



SERVICE MANUAL

HF/50MHz ALL MODE TRANSCEIVER

IC-756PROII

INTRODUCTION

This service manual describes the latest service information for the **IC-756PROII** HF/50MHz ALL MODE TRANSCEIVER.

VER. NO.	VERSION	SYMBOL
#22	U.S.A.	USA
#23	Europe	EUR
#24	France	FRA
#28	Italy	ITR
#29	Korea	KOR
#30	Spain	ESP

To upgrade quality, any electrical or mechanical parts and internal circuits are subject to change without notice or obligation.

DANGER

NEVER connect the transceiver to an AC outlet or to a DC power supply that uses more than 16 V. This will ruin the transceiver.

DO NOT expose the transceiver to rain, snow or any liquids.

DO NOT reverse the polarities of the power supply when connecting the transceiver.

DO NOT apply an RF signal of more than 20 dBm (100 mW) to the antenna connector. This could damage the transceiver's front end.



ORDERING PARTS

Be sure to include the following four points when ordering replacement parts:

1. 10-digit order numbers
2. Component part number and name
3. Equipment model name and unit name
4. Quantity required

<SAMPLE ORDER>

1110000960 S.IC NJM4558M IC-756PROII MAIN-A UNIT 5 pieces
8810005770 Screw BiH M3x8 ZK IC-756PROII Top cover 10 pieces
Addresses are provided on the inside back cover for your convenience.

REPAIR NOTES

1. Make sure a problem is internal before disassembling the transceiver.
2. **DO NOT** open the transceiver until the transceiver is disconnected from its power source.
3. **DO NOT** force any of the variable components. Turn them slowly and smoothly.
4. **DO NOT** short any circuits or electronic parts. An insulated tuning tool **MUST** be used for all adjustments.
5. **DO NOT** keep power ON for a long time when the transceiver is defective.
6. **DO NOT** transmit power into a signal generator or a sweep generator.
7. **ALWAYS** connect a 50 dB to 60 dB attenuator between the transceiver and a deviation meter or spectrum analyzer when using such test equipment.
8. **READ** the instructions of test equipment thoroughly before connecting equipment to the transceiver.

TABLE OF CONTENTS

SECTION 1	SPECIFICATIONS	
SECTION 2	INSIDE VIEWS	
SECTION 3	CIRCUIT DESCRIPTION	
3 - 1	RECEIVER CIRCUITS	3 - 1
3 - 2	TRANSMITTER CIRCUITS	3 - 4
3 - 3	PLL CIRCUITS	3 - 6
3 - 4	ANTENNA TUNER CIRCUITS	3 - 8
3 - 5	SCOPE CIRCUIT	3 - 9
3 - 6	POWER SUPPLY CIRCUITS	3 - 9
3 - 7	LOGIC CIRCUITS	3 - 10
SECTION 4	ADJUSTMENT PROCEDURES	
4 - 1	PREPARATION BEFORE SERVICING	4 - 1
4 - 2	PLL ADJUSTMENT	4 - 2
4 - 3	TRANSMITTER ADJUSTMENT	4 - 4
4 - 4	RECEIVER ADJUSTMENT	4 - 8
4 - 5	TUNER ADJUSTMENT	4 - 12
4 - 6	METER ADJUSTMENT	4 - 13
SECTION 5	PARTS LIST	
SECTION 6	MECHANICAL PARTS	
SECTION 7	SEMI-CONDUCTOR INFORMATION	
SECTION 8	BOARD LAYOUTS	
8 - 1	PBT, RIT AND MIC BOARDS	8 - 1
8 - 2	DISPLAY BOARD	8 - 2
8 - 3	MODE, PHONE, KEY AND TEN-KEY BOARDS	8 - 4
8 - 4	RF-A UNIT	8 - 6
8 - 5	PLL UNIT	8 - 8
8 - 6	MAIN-A UNIT	8 - 10
8 - 7	DSP-A, MEMORY AND BPF BOARDS	8 - 12
8 - 8	PA UNIT	8 - 14
8 - 9	FILTER UNIT	8 - 16
8 - 10	TUNER BOARD	8 - 18
8 - 11	CTRL UNIT	8 - 20
SECTION 9	BLOCK DIAGRAM	
SECTION 10	VOLTAGE DIAGRAMS	
10 - 1	FRONT UNIT	10 - 1
10 - 2	DSP-A BOARD	10 - 2
10 - 3	TUNER, MEMORY BOARDS AND CTRL UNIT	10 - 3
10 - 4	MAIN-A UNIT (1)	10 - 4
10 - 5	MAIN-A UNIT (2)	10 - 5
10 - 6	PLL UNIT	10 - 6
10 - 7	PA AND FILTER UNITS	10 - 7
10 - 8	RF-A UNIT AND BPF BOARD	10 - 8

SECTION 1 SPECIFICATIONS

■ GENERAL

- Frequency coverage:

Receive	0.030–60.000 MHz ^{*1, *2}	
Transmit	1.800–1.999 MHz ^{*2}	3.500–3.999 MHz ^{*2}
	7.000–7.300 MHz ^{*2}	10.100–10.150 MHz ^{*2}
	14.000–14.350 MHz ^{*2}	18.068–18.168 MHz ^{*2}
	21.000–21.450 MHz ^{*2}	24.890–24.990 MHz ^{*2}
	28.000–29.700 MHz ^{*2}	50.000–54.000 MHz ^{*2}

^{*1} Some frequency bands are not guaranteed.
^{*2} Depending on version.
- Mode : USB, LSB, CW, RTTY, AM, FM
- Number of memory channels : 101 (99 regular, 2 scan edges)
- Antenna connector : SO-239 x 2 and phono [(RCA); 50 Ω]
- Usable temp. range: –10°C to +50°C (14°F to 122°F)
- Frequency stability : Less than ±0.5 ppm from 1 min. after power ON.
- Freq. resolution : 1 Hz
- Power supply requirement : 13.8 V DC ±15 % (negative ground)
- Current consumption:

Transmit	max. power	23 A
Receive	stand-by	3.0 A (typical)
	max. audio	3.3 A (typical)
- Dimensions : 340 (W) x 111(H) x 285(D) mm
13³/₈(W) x 4³/₈(H) x 11⁷/₃₂(D) in
- Weight : 9.6 kg (21 lb 1 oz)
- ACC 1 connector : 8-pin DIN connector
- ACC 2 connector : 7-pin DIN connector
- CI-V connector : 2-conductor 3.5(d) mm (1/8")
- Display : 5-inch (diagonal) TFT color LCD

■ TRANSMITTER

- Output power :

SSB/CW/RTTY/FM	5–100 W
AM	5–40 W
- Modulation system :

SSB	PSN modulation
AM	Low power modulation
FM	Phase modulation
- Spurious emission : Less than –50 dB (HF bands)
Less than –60 dB (50 MHz band)
- Carrier suppression: More than 40 dB
- Unwanted sideband suppression: More than 55 dB
- ΔTX variable range : ±9.999 kHz
- Mic. connector : 8-pin connector (600 Ω)
- ELE-KEY connector: 3-conductor 6.35(d) mm (1/4")
- KEY connector : 3-conductor 6.35(d) mm (1/4")
- SEND connector : Phono (RCA)
- ALC connector : Phono (RCA)

■ RECEIVER

- Receive system : Triple-conversion superheterodyne
- Intermediate frequencies:

1st IF frequency	64.455 MHz
2nd IF frequency	455 kHz
3rd IF frequency	36 kHz
- Sensitivity :

SSB, CW, RTTY (at 2.4 kHz bandwidth)	
1.8–29.99 MHz ^{*1}	0.16 μV (10 dB S/N)
50.0–54.0 MHz ^{*2}	0.13 μV (10 dB S/N)
AM (at 6.0 kHz bandwidth)	
0.5–1.799 MHz	13 μV (10 dB S/N)
1.8–29.99 MHz ^{*1}	2.0 μV (10 dB S/N)
50.0–54.0 MHz ^{*2}	1.0 μV (10 dB S/N)
FM (at 15 kHz bandwidth)	
28.0–29.99 MHz ^{*1}	0.5 μV (12 dB SINAD)
50.0–54.0 MHz ^{*2}	0.32 μV (12 dB SINAD)

^{*1} Pre-amp 1 ON ^{*2} Pre-amp 2 ON
- Squelch sensitivity : (Pre-amp OFF)

SSB/CW/RTTY	Less than 5.6 μV
FM	Less than 1.0 μV
- Selectivity :

SSB/RTTY (at 2.4 kHz bandwidth)	
	More than 2.4 kHz/–6 dB
	Less than 3.6 kHz/–60 dB
CW (at 500 Hz bandwidth)	
	More than 500 Hz/–6 dB
	Less than 700 Hz/–60 dB
AM (at 6 kHz bandwidth)	
	More than 6.0 kHz/–6 dB
	Less than 15.0 kHz/–60 dB
FM (at 15 kHz bandwidth)	
	More than 12 kHz/–6 dB
	Less than 20 kHz/–60 dB
- Spurious and image: More than 70 dB rejection ratio (except IF through in 50 MHz band)
- RIT variable range : ±9.999 kHz
- Audio output power : More than 2.0 W at 10 % distortion (at 13.8 V DC) with an 8 Ω load
- PHONES connector: 3-conductor 6.35 (d) mm (1/4")
- EXT SP connector : 2-conductor 3.5 (d) mm (1/8") 8 Ω

■ ANTENNA TUNER

- Matching impedance range:

HF bands	16.7 to 150 Ω unbalanced ^{*1}
50 MHz band	20 to 125 Ω unbalanced ^{*2}

^{*1} Less than VSWR 3:1; ^{*2} Less than VSWR 2.5:1
- Minimum operating input power:

HF bands	: 8 W
50 MHz band	: 15 W
- Tuning accuracy : VSWR 1.5:1 or less
- Insertion loss : Less than 1.0 dB (after tuning)

All stated specifications are subject to change without notice or obligation.

SECTION 2 INSIDE VIEWS

• TOP VIEW

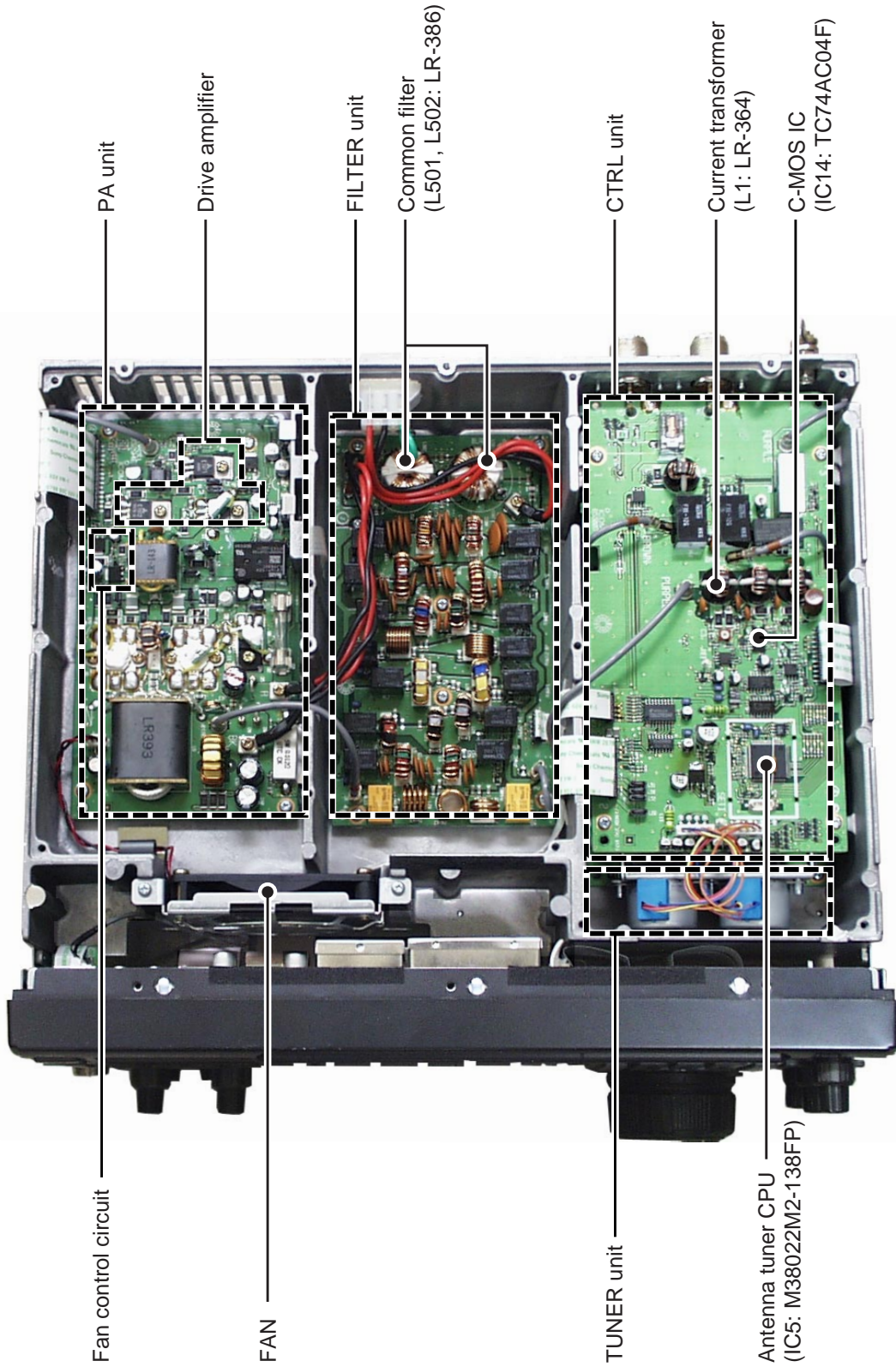

• BOTTOM VIEW

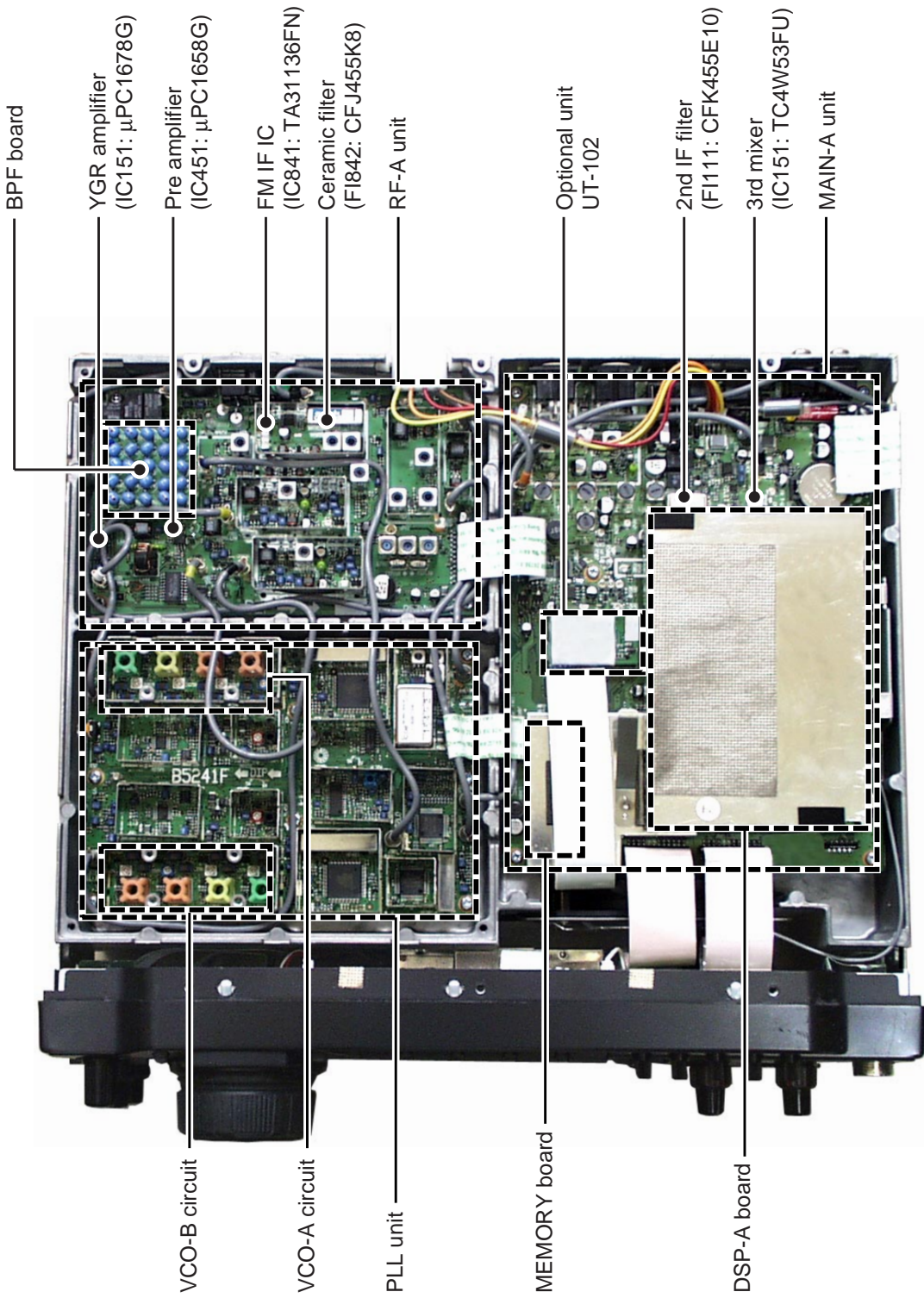

SECTION 3 CIRCUIT DESCRIPTION

3-1 RECEIVER CIRCUITS

3-1-1 RF SWITCHING CIRCUIT (CTRL AND RF-A UNITS)

The RF switching circuit leads receive signals to bandpass filters from an antenna connector while receiving. However, the circuit leads the signal from the RF power amplifier to the antenna connector while transmitting.

RF signals from [ANT 1] or [ANT 2] pass through the antenna selector (RL3), transmit/receive switching relays (RL1, RL2, RL4), and low-pass filter (L27, L28, C63–C66, C105), and are then applied to the RF-A unit via J2.

The signals from the CTRL unit either bypass or pass through the 6 dB (RF-A unit, RL121, R121) and/or 12 dB (RF-A unit, RL122, R123) attenuators via the antenna selector (RL101). By selecting the attenuators, 0 (bypass), 6, 12 and 18 dB attenuations are obtained. The signals are then applied to the RF filters.

When the [RX ANT] is selected, the RF signals are passed through the low-pass filter (RF-A unit, L112, L111, C111–C116), then applied to the antenna selector (RF-A unit, RL101).

3-1-2 RF BANDPASS FILTER CIRCUIT (RF-A UNIT AND BPF BOARD)

RF bandpass filters pass only the desired band signals and suppress any undesired band signals. The RF circuit has 11 bandpass filters and 1 low-pass filter.

(1) 0.03–1.6 MHz (BPF BOARD)

The signals pass through the low-pass filter (L181–L183, C181–C185), attenuator (R181–R183), and are then applied to the RF amplifiers (Q501, Q601).

(2) 1.6–60 MHz (RF-A UNIT AND BPF BOARD)

The signals pass through the high-pass filter (L171–L174, C171–C174) to suppress excessively strong signals below 1.6 MHz. The filtered signals are applied to one of 11 bandpass filters on the table at right above, and then applied to or bypassed the pre-amplifier circuit.

• Used RF filter

Band	Control signal	Input diode	Band	Control signal	Input diode
0.03–1.6 MHz	B0	N/A	11–15 MHz	B7	D281
1.6–2 MHz	B1	*D2001	15–22 MHz	B8	D301
2–3 MHz	B2	*D2021	22–30 MHz	B9	D321
3–4 MHz	B3	*D2041	30–50 MHz	B10W	D341
4–6 MHz	B4	*D2061	50–54 MHz	B10	D361
6–8 MHz	B5	*D2081	54–60 MHz	B10W	D341
8–11 MHz	B6	D261			

* : On the BPF board

3-1-3 PRE-AMPLIFIER CIRCUITS (RF-A UNIT)

The IC-756PROII has 2 gain levels of pre-amplifier circuits. One has 10 dB gain for the 1.8–21 MHz bands and the other one has 16 dB gain for the upper 24 MHz bands.

When the [P.AMP] switch is set to [P.AMP 1] or [P.AMP 2], the signals are applied to the pre-amplifier 1 (Q441, Q442) or pre-amplifier 2 (IC451) circuit, respectively. Pre-amplified or bypassed signals are applied to the RF amplifier circuits (Q501, Q502 and Q601, Q602).

3-1-4 RF AMPLIFIER AND 1ST MIXER CIRCUITS (RF-A UNIT)

The 1st mixer circuit mixes the receive signals with the 1st LO signal to convert the receive signal frequencies into a 64.455 MHz 1st IF signal. The IC-756PROII has two 1st mixer circuits for the dualwatch function.

The signals from the pre-amplifier circuit, or signals which bypass the pre-amplifiers, are divided at L491. Each signal is applied to a 60 MHz cut-off low-pass filter, RF amplifier (Q501, Q502 and Q601, Q602) and then to a 1st mixer (Q511–Q514 or Q611–Q614).

Each 1st LO signal (64.4850–124.4550 MHz) enters the RF-A unit from the PLL unit via J561 or J661. The LO signals are amplified at the LO amplifier (Q561 or Q661), filtered by a low-pass filter, and then applied to each 1st mixer.

• Receiver construction

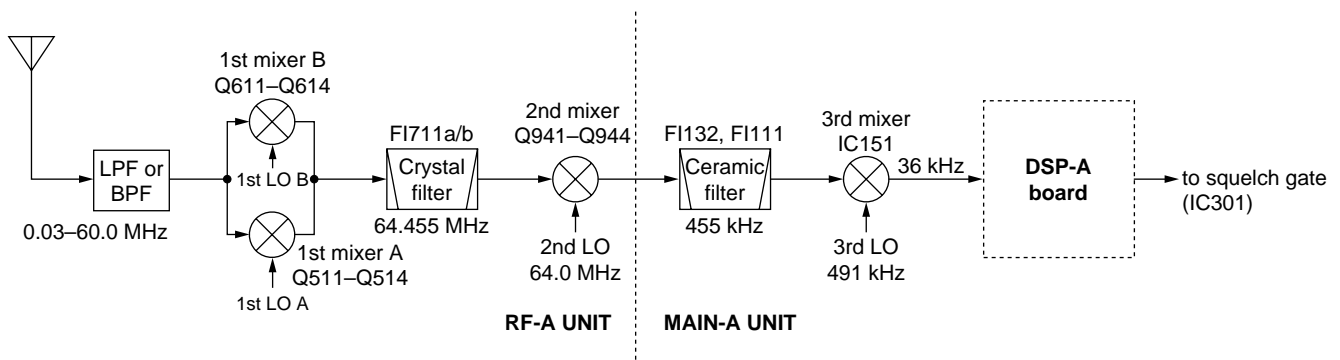

3-1-5 1ST IF CIRCUIT (RF-A UNIT)

The 1st IF circuit filters and amplifies the 1st IF signal. The 1st IF signal combined at L653 is applied to a pair of MCF (Monolithic Crystal Filter; FI711a/b) to suppress out-of-band signals.

The level of converted 1st IF signal is adjusted at the PIN attenuators (D531–D533, D535 or D631–D633, D635) controlled by the [BAL] controller for the dualwatch function. The signal is applied to the 1st IF amplifier (Q551 or Q651) and then combined at L653.

The combined signal passes through the 3 dB attenuator (R711–R713) and MCFs (FI711a/b). The signal is amplified at the 1st IF amplifier (Q721). The amplified signal is then applied to the 2nd mixer circuit.

3-1-6 2ND MIXER CIRCUIT (RF-A UNIT)

The 2nd mixer circuit mixes the amplified 1st IF signal and 2nd LO signal (64.00 MHz) for conversion into the 2nd IF signal.

The 1st IF signal from the 1st IF amplifier (Q721) is converted into a 455 kHz 2nd IF signal at the 2nd mixer circuit (D941).

The 2nd IF signal is applied to the noise blanker gate (MAIN-A unit) via the J741.

3-1-7 NOISE BLANKER CIRCUIT (MAIN-A UNIT)

The noise blanker circuit detects pulse-type noise, and turns OFF the signal line when the noise appears.

The 2nd IF signal from the RF-A unit is applied to the noise blanker gate (D112, D116). A portion of the 2nd IF signal from RF-A unit is amplified at the noise amplifiers (Q271–Q273, Q279), and is then detected at the noise detector (D271) to convert the noise components to DC voltages.

The signal is then applied to the noise blanker switch (Q276, Q278). At the moment the detected voltage exceeds Q276's threshold level, Q278 outputs a blanking signal to close the noise blanker gate (D113, D114). The PLL unlock signal are also applied to Q278, to control the noise blanker gate.

Some DC voltage from the noise detector circuit is fed back to the noise amplifiers (Q271–Q273) via the DC amplifiers (Q274, Q275). The DC amplifiers function as an AGC circuit to reduce average noise. Therefore, the noise blanker function shuts off pulse-type noise only.

3-1-8 2ND IF CIRCUIT (MAIN-A UNIT)

The 2nd IF circuit amplifies and filters the 2nd IF signal, and applies the 2nd IF signal to the 3rd mixer circuit.

The 2nd IF signal from the noise blanker gate (D113, D114) is amplified at the 2nd IF amplifier (Q141) and passed through the ceramic filter (FI111). The filtered signal is applied to the 3rd mixer circuit.

3-1-9 3RD MIXER AND 3RD IF CIRCUITS (MAIN-A UNIT)

The 3rd mixer circuit mixes the 2nd IF signal and the 3rd LO signal to obtain the 3rd IF (36 kHz) signal.

The 2nd IF signal from the ceramic filter (FI111) is applied to the 3rd mixer circuit (IC151, pin 1). The 3rd LO signal from the PLL unit is applied to the 3rd mixer (IC151, pin 5). The mixed signal is output from pin 6.

The 3rd IF signal is passed through the low-pass filter (IC201a) and amplified at the 3rd IF amplifier (IC201b). The filtered and amplified signal is then applied to the DSP-A board via DRIF line.

3-1-10 DSP RECEIVER CIRCUIT (DSP-A BOARD)

The DSP (Digital Signal Processor) circuit enables digital IF filter, digital noise reduction, digital PSN (Phase Shift Network)/Low Power/Phase demodulation, digital automatic notch, and etc.

The 36 kHz 3rd IF signal from the 3rd IF amplifier (MAIN-A unit, IC201b) is amplified at the differential amplifiers (IC2301a/b) after being passed through the T/R switch (IC2291), and is then applied to the A/D converter (IC2321). The converted signal is level shifted 5V to 3.3 V at the level converter (IC2051).

• DSP receiver circuit

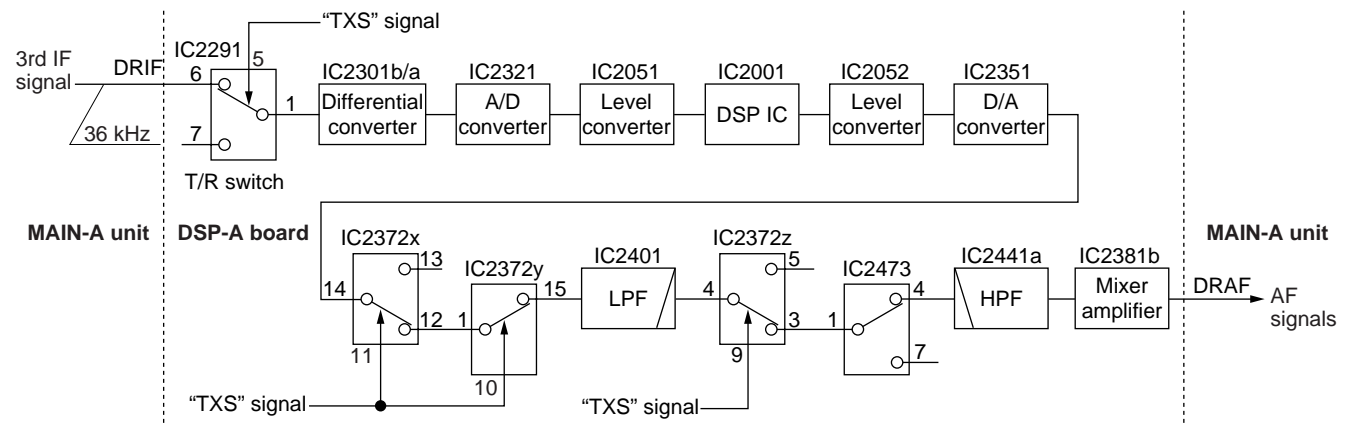

The level shifted signal is applied to the DSP IC (IC2001) for 36 kHz digital IF filter, demodulation, automatic notch and noise reduction, etc. The output signal is level shifted 3.3 V to 5V at the level converter (IC2052), and is applied to the D/A converter (IC2351) to convert into the analog audio signals.

The converted audio signals are passed through the active filter (IC2371a), AF amplifier (IC2371b), analog switches (IC2372, pins 14, 13 and pins 1, 15) then applied to the low-pass filter (IC2401). The filtered signals are passed through the analog switches (IC2372, pins 4, 3 and IC2473, pins 1, 7), high-pass filter (IC2441A) and mixer amplifier (IC2471A), and then applied to the MAIN-A unit via J2001 (pin 13) as the DRAF signal.

3-1-11 TWIN PBT CIRCUIT (DSP-A BOARD)

General PBT (Passband Tuning) circuit shifts the center frequency of IF signal to electronically narrow the passband width. The IC-756PROII uses the DSP circuit for the digital PBT function and actually shifts the both lower and higher passbands of 3rd IF filter within ± 1.8 kHz.

The twin PBT circuit in DSP IC (IC2001) controlled by the [TWIN PBT] controller adjusts the 3rd IF passband width and rejects interference.

3-1-12 AGC CIRCUIT (DSP-A BOARD)

The AGC (Automatic Gain Control) circuit reduces IF amplifier gain and attenuates IF signal to keep the audio output at a constant level.

The receiver gain is determined by the voltage on the AGC line (IC2461, pin 4). The D/A converter for AGC (IC2461) supplies control voltage to the AGC line and sets the receiver gain with the [RF/SQL] control.

The 3rd IF signal from the level converter (IC2051) is detected at the AGC detector section in DSP IC (IC2001), and is applied to the D/A converter for AGC via the level converter (IC2052). The AGC voltage is amplified at the buffer amplifier (IC2471b) and is applied to the MAIN-A unit to control the AGC line.

When receiving strong signals, the detected voltage increases and the AGC voltage decreases via the buffer amplifier (IC2471b). As the AGC voltage is used for the bias voltage of the IF amplifier (RF-A unit; Q721), IF amplifier gain is decreased.

3-1-13 S-METER CIRCUIT (MAIN-A UNIT)

The S-meter circuit indicates the relative received signal strength while receiving by utilizing the AGC voltage which changes depending on the received signal strength.

A portion of the AGC bias voltage from the DSP-A board is applied to the differential amplifier (IC101a, pin 2) where the difference between the AGC and reference voltage is detected.

The detected voltage is passed through the analog switch (IC3631, pins 12, 14) as the SML signal and applied to the main CPU (IC3501, pin 108) to activate the S/R/F meter via the sub CPU (IC401) on the DISPLAY board.

3-1-14 SQUELCH CIRCUIT (MAIN-A UNIT)

The squelch circuit mutes audio output when the S-meter signal is lower than the [RF/SQL] setting level.

The S-meter signal is applied to the main CPU (IC3501, pin 108) and is compared with the threshold level set by the [RF/SQL] control. The [RF/SQL] setting signal is applied to the main CPU via the sub CPU (DISPLAY board; IC401, pin 91). The main CPU analyzes the compared signal and outputs control signal to the squelch gate (IC301, pin 5) via the interface IC (IC3653, pin 19) to open or close the squelch as the SQLS signal.

3-1-15 AF AMPLIFIER CIRCUIT (MAIN-A UNIT)

The AF amplifier amplifies the audio signals to a suitable driving level for the speaker.

The AF signals (DRAF) from the DSP-A board are passed through the squelch gate (IC301) and amplified at the AF amplifier section of IC311 (pins 2, 4), and volume is controlled by the AFGV signal at the VCA section (pins 7-9). The volume controlled AF signals are passed through the AF mute gate (IC331, pins 1, 7), then applied to the AF power amplifier (IC332, pin 1) via the ripple filter (Q331).

The amplified audio signals are passed through the [PHONES] and [EXT SP] jacks then applied to the internal speaker when no plug is connected to the jacks.

The AF mute gate is controlled by the [AF] control via the sub and main CPUs.

• AF amplifier circuit

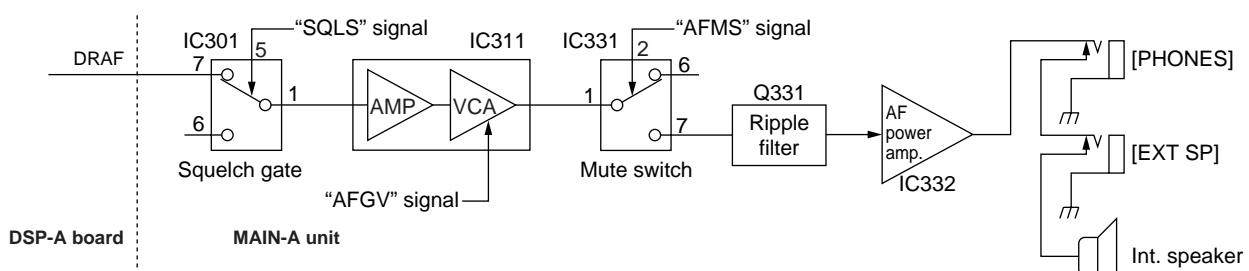

3-2 TRANSMITTER CIRCUITS

3-2-1 MICROPHONE AMPLIFIER CIRCUIT (MAIN-A UNIT)

The microphone amplifier circuit amplifies microphone audio signals to a level needed for the DSP circuit.

Audio signals from the [MIC] connector (MIC board; J1, pin 1) are amplified at the audio amplifier section in IC451 (pins 21, 22) via the analog switch (IC3002, pins 12, 14), then applied to the buffer amplifier section (IC451, pin 5) and VCA section. The gain controlled signals are output from (IC451, pin 9) and passed through the analog switch (IC3005, pins 14, 12) and then applied to the DSP circuit as the DTAF signal.

The VCA section in IC451 (pins 7–9) controls microphone input gain according to the [MIC GAIN] control level using the MIGV signal coming from the main CPU via the I/O expander (IC3751, pin 4).

3-2-2 VOX CIRCUIT (MAIN-A UNIT)

The VOX (Voice-Operated Transmission) circuit sets transmitting conditions according to voice input.

A portion of the amplified audio signals from the AF amplifier section in IC451 are again amplified at the VOX amplifier section IC451 (pin 9), also gain controlled signals at the VCA section (pin 9) are amplified at the AF amplifier (IC3004b, pins 6, 7), and then applied to the main CPU (IC3501, pin 106) after passing through the analog switch (IC362, pins 6, 1) as the VOXL signal.

The VOGV signal is applied to the VCA section in IC3003 (pin 7–9) from the main CPU via the I/O expander (IC3751, pin 9) to adjust VOX actionable sensitivity. This is controlled by the VOX gain set in the VOX SET mode.

3-2-3 DSP TRANSMITTER CIRCUIT (DSP-A BOARD)

The microphone audio signals from the MAIN-A unit via the DTAF line are applied to the analog switch (IC2201, pin 4) and output from pin 3 or 5 to the each modulation circuits.

(1) When SSB mode

The audio signals from the analog switch (IC2201, pin 5) are amplified at the limiter amplifier (IC2281b) and applied to the low-pass filter (IC2281d/c) to limit the transmit passband width.

The filtered signals are then applied to the differential amplifiers (IC2301a/b) via the analog switch (IC2201) and T/R switch (IC2291).

(2) When FM/AM modes

The audio signals from the analog switch (IC2201, pin 3) are applied to the modulation adjustment pots (R2227: FM mode, R2229: AM mode) via the limiter amplifier, pre-emphasis circuit (only FM mode) and splatter filter consist of IC2211. The level adjusted signals are applied to the differential amplifiers (IC2301a/b) after being passed through the analog switch (IC2201) and T/R switch (IC2291). The pre-emphasis circuit is cancelled by Q2201, Q2202, Q2211 on AM mode.

The amplified signals at the differential amplifiers (IC2301a/b) are applied to the A/D converter (IC2321). The converted signals are level shifted 5V to 3.3 V at the level converter (IC2051).

The level shifted signal is applied to the DSP IC (IC2001) and modulated at the DSP IC to produce the 36 kHz transmitter IF signal. The modulated IF signal from the DSP IC is level shifted 3.3 V to 5V at the level converter (IC2052), and is applied to the D/A converter (IC2351) to convert into the analog IF signal.

The converted IF signal is passed through the active filter (IC2371a), buffer amplifier (IC2371b), analog switch (IC2372, pins 14, 12) then applied to the low-pass filter (IC2381d/c). The filtered signal is applied to the MAIN unit via J2001 (pin 28) as the DTIF signal.

When SSB or RTTY mode, a portion of the filtered signal from the low-pass filter (IC2381d/c) is amplified at the IF and buffer amplifiers (IC2381b/c) and is applied to the transmit monitor circuit for the monitor function.

3-2-4 SPEECH COMPRESSOR CIRCUIT (DSP BOARD)

The speech compressor compresses the transmitter audio input signals to increase the average output level (average talk power).

When the speech compressor function is ON, the level shifted signal from the level converter (IC2051) is applied to the DSP IC (IC2001) and compressed at the DSP IC to obtain an average audio level.

At the same time, the compressed signals are modulated at the DSP IC and applied to the level converter (IC2052).

• Transmitter construction

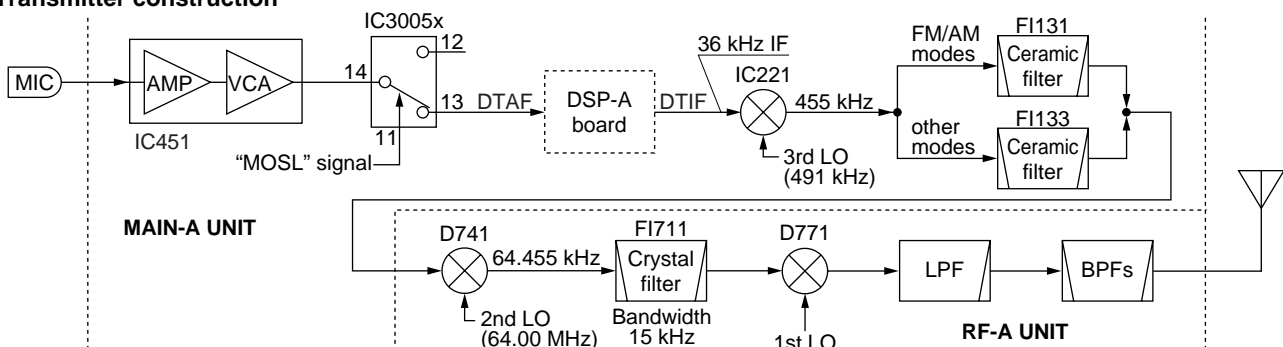

3-2-5 IF AMPLIFIER AND MIXER CIRCUITS (MAIN-A AND RF-A UNITS)

The modulated 3rd IF signal from the DSP-A board (DTIF: 36 kHz) is applied to the 3rd mixer circuit (MAIN-A unit; IC221, pin 1). The applied 3rd IF signal is mixed with the 3rd LO signal from the DDS circuit (PLL unit; IC701) to produce a 455 kHz 2nd IF signal.

The 2nd IF signal is output from pin 6 and amplified at the IF amplifier (MAIN-A unit; Q241). The amplified signal is passed through the ceramic bandpass filter (MAIN-A unit; F1131: FM/AM modes, F1133: other modes) for unwanted signals are suppressed. The filtered 2nd IF signal is amplified at IF amplifier (MAIN-A unit; Q261) and applied to the 2nd mixer circuit on the RF-A unit via J101.

The 2nd IF signal is mixed with the 64 MHz 2nd LO signal, coming from the PLL unit, at the 2nd mixer circuit (RF-A unit; D741) to obtain a 64.455 MHz 1st IF signal. The 1st IF signal is passed through the MCFs (RF-A unit; F1711a/b) to cut-off the undesired signals then amplified at the IF amplifier (RF-A unit; Q751) via the T/R switch (RF-A unit; D711). The amplified 1st IF signal is applied to the 1st IF mixer circuit (RF-A unit; D771).

The operating (transmitting) frequency is produced at the 1st IF mixer circuit (RF-A unit; D771) by mixing the 1st IF and 1st LO signals. The mixed signal is then applied to the RF circuit.

3-2-6 RF CIRCUIT (RF-A AND PA UNITS)

The RF circuit amplifies operating (transmitting) frequency to obtain 100 W of RF output.

The signal from the 1st IF mixer is passed through the low-pass filter (RF-A unit; L961, L962, C961-C965) and amplified at the RF amplifier (RF-A unit; IC961). The amplified signal is again amplified at the wide-band YGR amplifier (RF-A unit, IC151) after passing through one of 11 bandpass filters (Refer to page 3-1 for bandpass filters used) and high-pass filters, and is then applied to the PA unit via J151.

The signal applied from the RF-A unit is amplified at the pre-drive (Q1), drive (Q2, Q3) and power amplifiers (Q4, Q5) in

sequence to obtain a stable 100 W of RF output power. The amplified signal is applied to one of 8 low-pass filters in the FILTER unit.

3-2-7 LOW-PASS FILTER CIRCUIT (FILTER UNIT)

The low-pass filter circuit contains 8 Chebyshev low-pass filters to suppress the higher harmonic components.

The signal from the power amplifiers on the PA unit is applied to one of 8 low-pass filters, which is selected by the I/O expander (IC11) in the CTRL unit via the buffer amplifier (CTRL unit; IC12).

The filtered signal is then applied to one of 2 antenna connectors via the CTRL only/and TUNER unit/s.

3-2-8 ALC CIRCUIT (MAIN-A UNIT)

The ALC (Automatic Level Control) circuit controls the gain of IF amplifiers in order for the transceiver to output a constant RF power set by the [RF POWER] control even when the supplied voltage shifts, and etc.

The RF power level is detected at one of the APC detector circuits (CTRL unit; D2) to be converted into DC voltage and applied to the MAIN-A unit as the FORV signal.

The FORV signal from the CTRL unit is applied to the comparator (IC551b, pin 6). The POCV signal, controlled by the [RF POWER] control via the I/O expander (IC3751, pin 5), is also applied to the other input (pin 5) for reference. The compared signal is output from pin 7 and applied to the IF amplifiers in the MAIN-A (Q261) and RF-A (Q751) units to control amplifying gain.

When the FORV signal exceeds the POCV voltage, ALC bias voltage from the comparator controls the IF amplifiers. This adjusts the output power to a specified level from the [RF POWER] control until the FORV and POCV voltages are equalized.

In AM mode, the comparator operates as an averaging ALC amplifier. Q502 turns ON and the POCV voltage is shifted for 40 W AM output power (maximum) through R510.

• DSP Transmitter circuit

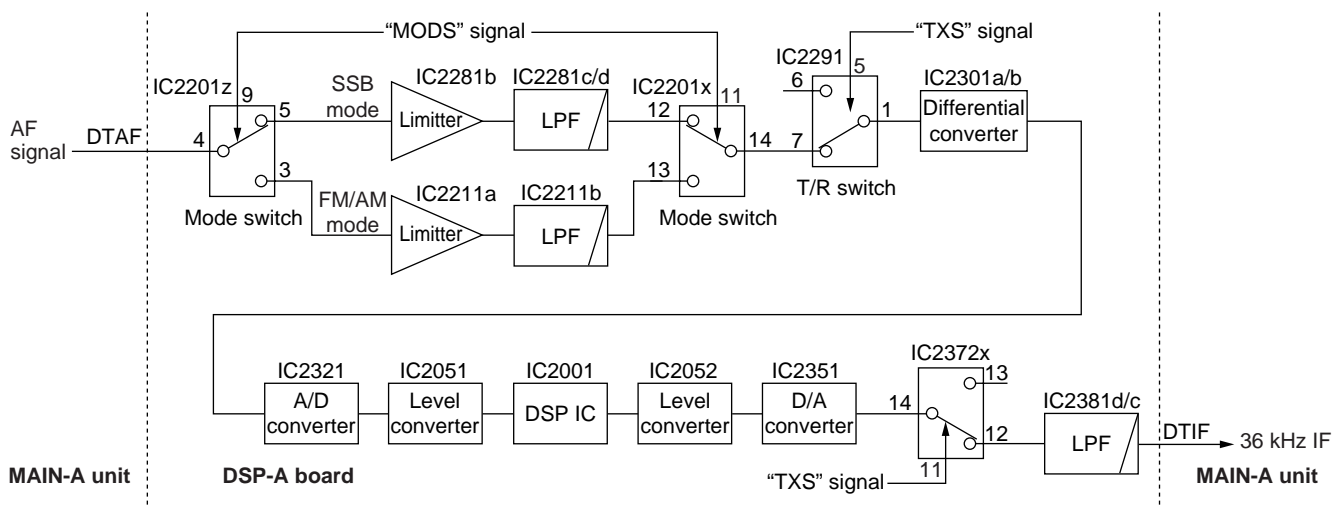

The ALC bias voltage is also applied to the ALC meter amplifier (IC551a, pin 2) to obtain an ALC meter signal (ALCL). The amplified signal is passed through the analog switch (IC3631, pins 13, 14) and applied to the main CPU (IC3501, pin 108) to drive the S/Rf meter via the sub CPU (IC401) on the DISPLAY board.

An external ALC input from the [ALC] jack or [ACC] sockets is applied to the buffer amplifier (Q521). External ALC operation is identical to that of the internal ALC.

The FORV signal is also applied to the power meter amplifier (IC571a, pin 3). The amplified signal is passed through the analog switch (IC3631, pins 1, 15) as an FORL signal and applied to the main CPU (IC3501, pin 109) to drive the S/Rf meter when the power meter is selected.

3-2-9 APC CIRCUIT (MAIN-A UNIT)

The APC (Automatic Power Control) circuit protects the power amplifiers on the PA unit from high SWR and excessive current.

The reflected wave signal appears and increases when the connected antenna is mismatched to 50 Ω . The APC detector circuit (CTRL unit; D1 and L1) detects the reflected signal, and applies it to the APC circuit (IC551c, pin 9) as a REFV signal.

When the REFV signal level increases, the APC circuit decreases the ALC voltage to activate the APC.

For the current APC, the power transistor current is obtained by detecting the voltages (ICH and ICL) which appear at both terminals of the current detector (PA unit; R28). The detected voltages are applied to the differential amplifier (IC551d, pins 12, 13). When the current of transistors is increased, the amplifier controls the ALC line to prevent excessive current flow.

A portion of the REFV signal is applied to the SWR meter amplifier (IC571b, pin 5). The amplified signal is passed through the analog switch (IC3631, pins 3, 4) as an REFL signal and applied to the main CPU (IC3501, pin 110) to drive the S/Rf meter when the SWR meter is selected.

3-2-10 TEMPERATURE PROTECTION CIRCUIT (PA UNIT)

The cooling fan (CHASSIS; MF1) is activated while transmitting or when the temperature of the power amplifier exceeds the preset value. The temperature protection circuit consists of Q10–Q13 and R50.

While transmitting, Q10 and Q12 are turned ON, and provide a voltage to the cooling fan to rotate at medium speed. The thermistor (R50) detects the temperature of the final amplifier (Q5), and activates Q11 and Q13 to accelerate the cooling fan when the detected temperature exceeds 70°C (158°F). The cooling fan rotates at high speed at 80°C (176°F) or more.

The thermistor keeps the cooling fan rotating even while receiving until the Q5 temperature drops to 60°C (140°F) or below.

3-2-11 MONITOR CIRCUIT (DSP-A BOARD AND MAIN-A UNIT)

The microphone audio signals can be monitored to check voice characteristics.

(1) When FM/AM modes (MAIN-A UNIT)

A portion of the microphone audio signals from the VCA section in IC451 are applied to the analog switch (IC361). The selected audio signals are applied to IC371 (pin 2), and the output signals from pin 9 are applied to the AF amplifier circuit (IC311, pin 7).

(2) When SSB/RTTY modes (DSP-A BOARD)

A portion of the transmit IF signal from the low-pass filter (IC2381d/c) is amplified at the IF (IC2381b) and buffer (IC2381a) amplifiers, and applied to the digital mixer circuit (IC2302). The applied signal is mixed with a 36 kHz LO signal from the D/A converter (IC2342) to demodulate into the AF signals. The demodulated signals are passed through the buffer amplifier (IC2381a), low-pass filter (IC2441b/c) and AF amplifier (IC2441d), and then applied to the MAIN-A unit as the DMAF signal.

The DMAF signal from the DSP-A board is amplified at the ALC amplifier (MAIN-A unit; IC372, pins 13, 1) and applied to the VCA section of IC371 (MAIN-A unit; pins 7, 9). The volume controlled AF signals is applied to the AF amplifier circuit (MAIN-A unit; IC311, pin 7).

3-3 PLL CIRCUITS

3-3-1 GENERAL

The PLL unit generates a pair of 1st LO frequencies (64.485–124.455 MHz) for dualwatch and spectrum scope functions; a 2nd LO frequency (64 MHz), 3rd LO frequency (491 kHz) and sweep LO frequency for the spectrum scope function.

The 1st LO PLLs adopt a mixer-less dual loop PLL system and has 4 VCO circuits. The LOs, except the 2nd, use DDSs while the 2nd LO uses the fixed frequency of the crystal oscillator.

3-3-2 1ST LO PLL CIRCUIT

The 1st LO PLLs contain a main and reference loop as a dual loop system. Both PLLs have equivalent circuits— this manual describes only the 1st LO PLL A circuit.

The reference loop generates a 10.747 to 10.865 MHz frequency using a DDS circuit, and the main loop generates a 64.485 to 124.455 MHz frequency using the reference loop frequency.

(1) REFERENCE LOOP PLL

The oscillated signal at the reference VCO (Q151, D151) is amplified at the buffer amplifiers (Q152, Q102) and is then applied to the DDS IC (IC101, pin 46). The signal is then divided and detected on phase with the DDS generated frequency.

The detected signal output from the DDS IC (pin 56) is converted into DC voltage (lock voltage) at the loop filter (R135–R137, C121, C151) and then fed back to the reference VCO circuit (Q151, D151).

(2) MAIN LOOP PLL

The oscillated signal at one of the main loop VCOs (Q201, D201, D202), (Q221, D221, D222), (Q251, D251–D254) and (Q271, D271–D274) is amplified at the buffer amplifiers (Q301, IC320) and is then applied to the PLL IC (IC381, pin 6) via the low-pass filter (L303, C304–C307). The signal is then divided and detected on phase with the reference loop output frequency.

The detected signal output from the PLL IC (pin 2) is converted into a DC voltage (lock voltage) at the loop filter and then fed back to one of the VCO circuits (Q201, D201, D202), (Q221, D221, D222), (Q251, D251–D254) and (Q271, D271–D274).

The oscillated signal is amplified at the buffer amplifiers (Q301, IC320) and then applied to the RF-A unit as a 1st LO A signal after being passed through the low-pass filters (L303, C304–C307 and L351–L353, C351–C356) and high-pass filter (L354, C358–C360) and mute circuit (D361).

3-3-3 2ND LO AND REFERENCE OSCILLATOR CIRCUITS

The reference oscillator (X52, Q51) generates a 32.00056 MHz frequency for the 4 DDS circuits as a system clock and for the LO output. The oscillated signal is doubled at the

doubler circuit (Q71, Q81) and the 64.0 MHz frequency is picked up at the double tuned filter (L81, L82). The 64.0 MHz signal is applied to the RF-A unit as a 2nd LO signal.

3-3-4 3RD LO CIRCUIT

The DDS IC (IC701) generates a 10-bit digital signal using the 32 MHz system clock. The digital signal is converted into an analog wave signal at the D/A converter (R701–R720). The converted analog wave is passed through the bandpass filter (L702, L703, C709–C713) and then applied to the MAIN-A unit as the 3rd LO signal.

3-3-5 MARKER CIRCUIT

The divided signal at the DDS circuit (IC101) is used for the marker signals with the IC-756PROII.

The reference signal for the DDS circuit (32.0 MHz) is divided to produce an acceptable frequency signal, 16 MHz, with the programmable divider then divided again by 160 to obtain 100 kHz cycle square-wave signals.

The generated marker signals are output from pin 66 of the DDS IC (IC101), and are then applied to the RF unit via the mute switch (IC192) and J851 as the MKR signal.

• PLL CIRCUIT

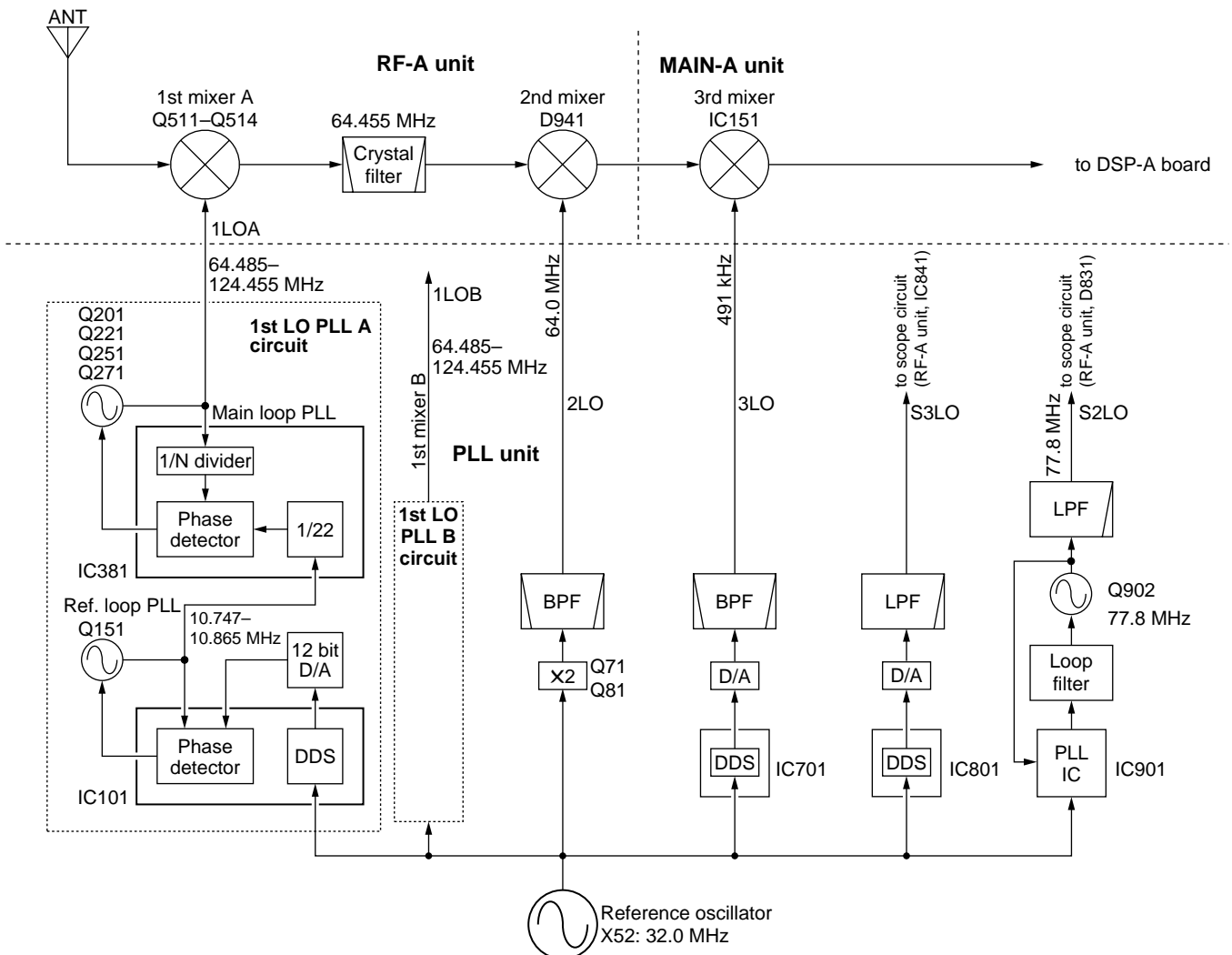

3-4 ANTENNA TUNER CIRCUITS

3-4-1 MATCHING CIRCUIT (TUNER UNIT)

The matching circuit is a T-network. Using 2 tuning motors, the matching circuit obtains rapid overall tuning speed.

Using relays (RL1–RL15), the relay control signals from the antenna tuner CPU (CTRL unit; IC5) via the buffer amplifier (IC1, IC2) ground one of the taps of L3–L12 and add capacitors (C27–C43). After selecting the coils and capacitors, 2 motors (CTRL unit; MF1, MF2) adjust C44 and C45 using the antenna tuner CPU (CTRL unit; IC5) and the motor controller (CTRL unit; Q211–Q218, D211, D213, D215, D217) to obtain a low SWR (Standing Wave Ratio).

3-4-2 DETECTOR CIRCUIT (CTRL UNIT)

(1) SWR detector

Forward and reflected power are picked up by a current transformer (L1), detected by D2 and D1, and then amplified at IC1a and IC1b, respectively. The amplified voltages are applied to the antenna tuner CPU (IC5, pins 2, 3). The tuner CPU detects the SWR.

(2) Reactance components detector

Reactance components are picked up by comparing the phases of the RF current and RF voltage. The RF current is detected by L4 and R16 and buffer-amplified at IC14e and IC2a and then applied to the phase comparator (IC3a). RF voltages are detected by C12–C14 and then applied to the phase comparator (IC3b) after being amplified at the buffer amplifiers (IC14c, IC2b). The output signal from the phase comparator (IC3a, pin 6 for RF current, IC3b pin 7 for RF voltage) is rectified at D7 and D6 for conversion into DC voltage. The rectified voltage signals are combined, then amplified at the inverter amplifier (IC4b), then applied to the antenna tuner CPU (IC5, pin 64).

A C-MOS IC is used for the buffer amplifier (IC14) to improve functionable sensitivity; the inverter amplifier (IC4) is very responsive even with a low signal level input. Together, these ensure quick and stable signal detection even at low RF signal level input.

(3) Resistance components detector

Resistance components are picked up by L8, and detected by D8, D9 and Q5. The detected resistance components are amplified at the inverter amplifier (IC4a), and then applied to the antenna tuner CPU (IC5, pin 1).

3-4-3 MOTOR CONTROL CIRCUIT (CTRL AND TUNER UNITS)

The control circuit of the internal antenna tuner consists of the CPU, EEPROM (Electrically-Erasable Programmable Read Only Memory), tuning motors and tuning relays.

(1) CPU and EEPROM (CTRL unit)

The antenna tuner CPU (IC5) controls the tuning motors via the motor controller (Q211–Q218, D211, D213, D215, D217) and tuning relays, and memorizes the best preset position in 100 kHz steps. The memory contents are stored in the EEPROM (IC6) without a backup battery.

(2) Tuning motors (CTRL and TUNER units)

A motor controller (Q211–Q218, D211, D213, D215, D217) rotates the tuning motors (TUNER unit; MF1, MF2) to obtain a low SWR.

(3) Tuning relays (TUNER unit)

According to the operating frequency band and antenna condition, tuning relays select the capacitors and coils.

3-4-4 ANTENNA TUNER CPU PORT ALLOCATION (CTRL unit; IC5)

Pin number	Port name	Description
1	R	Input port for the resistance components detection voltage.
2	REF	Input port for the reflected RF power voltage.
3	FOR	Input port for the forward RF power voltage.
4	PWRS	Input port for the transceiver power OFF.
6	STDU	Inputs low level signal when operating the antenna tuner in 50 MHz band.
7	SETI	Input port for reference voltage setting.
13	KEY	Outputs tuner data signal.
15	START	Input port for the serial signal.
17	THRU	Input port for the [TUNER] ON/OFF signal.
21	SEND	Input port for the TX/RX switching signal.
22, 23	CL1, CL2	Input port for the antenna tuner CPU system clock.
26	DUAL	Outputs the coil selection signal. High : While 46–60 MHz band is displayed.
27–32	L24M, L18M, L14M, L10M, L7M, L3.5M	Output the coil selection signal.
34–40	CO3, CO2, CO1, CI3, CI2, CI1	Output the capacitor selection signal.
41–48	PZ, PY, PX, PW, RZ, RY, RX, RW	Output pulse-type control signals for the tuning motors (MF1, MF2).
64	P	Input port for the reactance components detection voltage.

3-5 SCOPE CIRCUITS

3-5-1 SCOPE RECEIVER CIRCUIT (RF-A UNIT)

A portion of the 64.455 MHz 1st IF signal from the 1st mixer circuit (Q511–Q514: while receiving) or IF amplifier (Q751: while transmitting) is passed through the PIN attenuator (D801) and amplified at the IF amplifiers (Q811, Q812), and then mixed with the 77.8 MHz scope 2nd LO (S2LO) signal at the mixer circuit (D831) to produce the 13.345 MHz IF signal. The mixed IF signal is passed through the ceramic bandpass filters (F1843, F1841) to suppress unwanted signals. The filtered IF signal is applied to the FM IF IC (IC841, pin 16).

The applied 13.345 MHz IF signal is mixed with the sweep LO (S3LO) signals from the PLL unit at the FM IF IC (IC841), which includes the RSSI terminal. The mixed IF signals are filtered at the ceramic bandpass filter (F1842) then applied to the limiter amplifier section in the FM IF IC (IC841, pin 5). The applied IF signals are converted into DC voltages according to the applied IF signal strength at the RSSI section in the IC.

The converted voltages are output from pin12 (IC841) and amplified at IC871b, then applied to the MAIN-A unit as the SCPL signal.

Some of the DC voltages from the FM IF IC (IC841) are amplified at IC871a to produce AGC voltages for the IF amplifiers (Q811, Q812), producing wider dynamic range.

By sweeping LO signals (S3LO) are applied to the mixer section in the FM IF IC (IC841), the spectrum scope function is activated.

3-5-2 SWEEP LO CIRCUIT (PLL UNIT)

The sweep LO signals (S3LO) are generated by the DDS IC (IC801) using the 32 MHz system clock. A 10-bit digital signal is converted into analog wave signals at the D/A converter (R801–R820). The converted analog wave is passed through the bandpass filter (L802, L803, C809–C813) then applied to the RF-A unit after being amplified at the buffer amplifier (Q802).

3-6 POWER SUPPLY CIRCUITS

3-6-1 PA UNIT

LINE	DESCRIPTION
PHV	The voltage from an external power supply via the common filter circuit (FILTER unit; L501, L502).
HV	The same voltage as the PHV line passed through a fuse (F1).
14V	The same voltage as the HV line passed through the switching relay (RL1).
14VA	The same voltage as the 14 V line is applied to the AF power amplifier (MAIN-A unit; IC332).
8V	Common 8 V converted from the 14 V line and regulated by the +8 regulator circuit (IC3).
5V	Common 5 V converted from the 14 V line and regulated by the +5 regulator circuit (IC2).
H5V	Common 5 V converted from the HV line and regulated by the H5V regulator circuit (IC1).

3-6-2 FRONT UNIT

LINE	DESCRIPTION
5VF	Common 5 V converted from the 14 V line and regulated by the +5 regulator circuit (IC861).
-15V	Common -15 V converted from the 14 V line and converted by the -15 DC-DC converter circuit (IC841, Q841, D841). The voltage is applied to the -7 V, -8 V regulator circuits and etc.
-7V	Common -7 V converted from the -15 V line and regulated by the -7 regulator circuit (IC501).
-8V	Common -8 V converted from the -15 V line and regulated by the -8V regulator circuit (IC881).
+18V	Common 18 V converted from the 14 V line and converted by the 18 V DC-DC converter circuit (IC821, Q821, D822).

• SCOPE CIRCUIT DIAGRAM

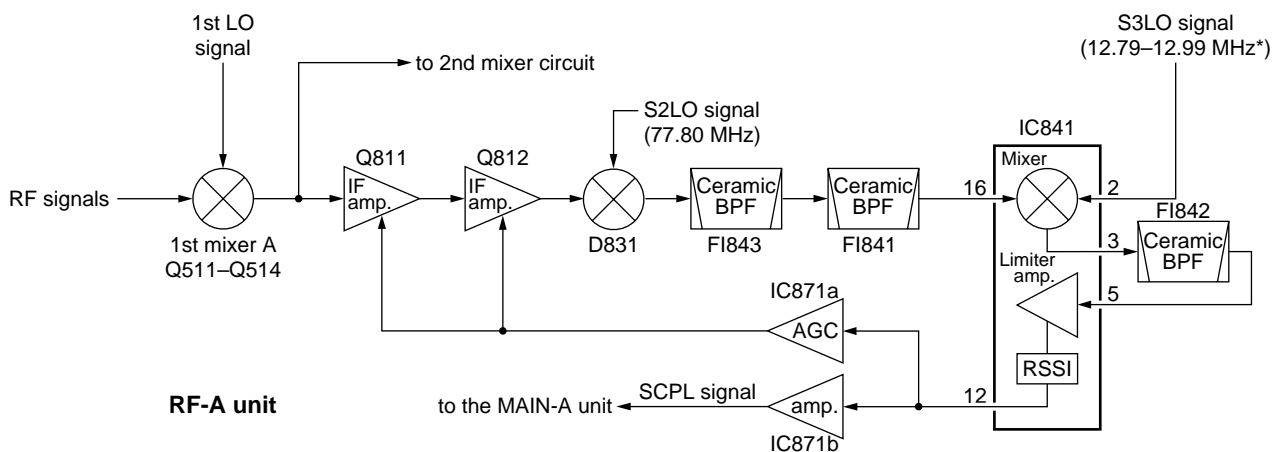

*depending on sweeping passband width

3-6-3 MAIN-A UNIT

LINE	DESCRIPTION
R8V	Receive 8 V converted from the 14 V line and regulated by the R8V regulator circuit (Q601, Q602, D601).
T8V	Transmit 8 V converted from the 14 V line and regulated by the T8V regulator circuit (Q611, Q612, D611).

3-6-4 CTRL AND PLL UNITS

LINE	DESCRIPTION
5V	Common 5 V for the antenna tuner CPU (CTRL unit; IC5) and the EEPROM (CTRL unit; IC6), converted from the 14 V line and regulated by the +5 regulator circuit (CTRL unit; IC13).
5V	Common 5 V for each PLL-A and PLL-B circuits regulated from the 8 V line and regulated by the +5 regulator circuit (PLL unit; IC382: PLL-A, IC682: PLL-B).

3-7 LOGIC CIRCUITS

3-7-1 BAND SELECTION DATA (RF-A, CTRL AND PLL UNITS)

To select the correct bandpass, low-pass filters and VCOs on the RF-A, FILTER and PLL units, the main CPU (MAIN-A unit, IC3501) outputs the following band selection data via the I/O expander (RF-A unit, IC901, IC902, CTRL unit, IC11) or DDS IC (PLL unit, IC101, IC401) depending on the displayed frequency.

Frequency [MHz]	IC901, IC902 (RF-A unit)	IC11 (CTRL)	IC101 (PLL)	IC401 (PLL)
	BPF	LPF	VCO-A	VCO-B
0.003–1.599999	B0	L1S	VA1S	VB1S
1.6–1.999999	B1			
2.0–2.999999	B2	L2S		
3.0–3.999999	B3			
4.0–5.999999	B4	L3S	VA2S	VB2S
6.0–7.999999	B5			
8.0–10.999999	B6	L4S	VA3S	VB3S
11.0–14.999999	B7			
15.0–19.999999	B8	L5S	VA4S	VB4S
20.0–21.999999				
22.0–29.999999	B9	L6S	VA3S	VB3S
30.0–44.999999	B10W	L7		
45.0–49.999999			B10	VA4S
50.0–54.000000	B10W			
54.000001–60.000000				

The D/A convertor (MAIN-A unit, IC3751) output signal from pin 7 is amplified at IC101b (pins 5–7) to obtain the band voltage for external equipment via the [ACC 2] connector pin 4.

3-7-2 SUB-CPU PORT ALLOCATIONS (DISPLAY BOARD; IC401)

Pin number	Port name	Description																																								
7, 8	OSC1, OSC2	Input and output ports for the system clock oscillator (X401; 9.8304 MHz).																																								
9	DRES	Input port for the reset signal.																																								
12, 83	MSB, MSA	Input port for the [DIAL]; pulse-type signals are applied.																																								
56, 57	DOTK, DSHK	Input ports for the [ELEC-KEY] jack.																																								
64–66	MDM0–MDM2	Output ports for the S/RF meter backlight and function switch activation indicator brightness control signal.																																								
		<table border="1"> <thead> <tr> <th>Port</th> <th colspan="7">Backlight level</th> </tr> <tr> <th></th> <th>1</th> <th>2</th> <th>3</th> <th>4</th> <th>5</th> <th>6</th> <th>7</th> </tr> </thead> <tbody> <tr> <td>MDM0</td> <td>High</td> <td>Low</td> <td>High</td> <td>Low</td> <td>High</td> <td>Low</td> <td>High</td> </tr> <tr> <td>MDM1</td> <td>Low</td> <td>High</td> <td>High</td> <td>Low</td> <td>Low</td> <td>High</td> <td>High</td> </tr> <tr> <td>MDM2</td> <td>Low</td> <td>Low</td> <td>Low</td> <td>High</td> <td>High</td> <td>High</td> <td>High</td> </tr> </tbody> </table>	Port	Backlight level								1	2	3	4	5	6	7	MDM0	High	Low	High	Low	High	Low	High	MDM1	Low	High	High	Low	Low	High	High	MDM2	Low	Low	Low	High	High	High	High
		Port	Backlight level																																							
			1	2	3	4	5	6	7																																	
MDM0	High	Low	High	Low	High	Low	High																																			
MDM1	Low	High	High	Low	Low	High	High																																			
MDM2	Low	Low	Low	High	High	High	High																																			
67–75	TNRD, MOND, NBD, NRD, LOCD, TXD, RXD, PBD, NOTD	Control signal output ports for the activation indicator of function switches. High: When the function is activated.																																								
77, 79	PB1B, PB1A	Input port for the [TWIN PBT (inner)] control (PBT board, S1/inner).																																								
81	METV	Outputs the S/RF meter (ME1) drive signal.																																								
82, 84	RSA, RSB	Input ports for the [RIT/ΔTX] control; pulse-type signals are applied.																																								
85, 88	PB2A, PB2B	Input port for the [TWIN PBT(outer)] control (PBT board, S1/outer).																																								
86	LMFD	Input port for data signal from the main-CPU (MAIN unit; IC3501).																																								
87	LFMD	Outputs data signal for the main-CPU (MAIN unit; IC3501).																																								
92	BALL	A/D input port for the [BAL] control (R702/ inner).																																								
93	NRL	A/D input port for the [NR] control (R702/ outer).																																								
94	MIGL	A/D input port for the [MIC GAIN] control (R712).																																								
95	PWRL	Input port for the [RF POWER] control (R714).																																								
96	CMPL	Input port for the [COMP] control (R716).																																								
97	KYSL	Input port for the [KEY SPEED] control (R718).																																								
98	DELL	Input port for the [BK-IN DELAY] control (R720).																																								
99	NOTL	Input port for the [NOTCH] control (PBT board, R1/inner).																																								
100	PITL	Input port for the [CW PITCH] control (PBT board, R1/outer).																																								

3-7-3 MAIN-CPU PORT ALLOCATIONS (MAIN UNIT; IC3501)

Pin number	Port name	Description
6-9, 11-18, 20-26	A0-A3, A4-A11, A12-A18	Address signal output ports for the LCD controller (IC3551).
29	SKYS	Input port for the [KEY] jack. Low : During key down
30	RTKI	Input port for the RTTY keying.
31	DPGI	Power supply detection input port for the DSP-A board.
32	DSDR	Input port for data signal from DSP-A board.
34	PWRK	Input port for the [POWER] switch. Low : When the [POWER] is pushed.
37	DSKY	Outputs CW/RTTY keying.
40-43, 45-52, 54-57	DB0-DB3, DB4-DB11, DB12-DB15	Data bus lines for the LCD controller (IC3551) and I/O expander (IC3652-IC3654).
59	CTXD	Output port for the CI-V signal.
61	CRXD	Input port for the CI-V signal.
63	MCK	Outputs clock signal.
64	MDAT	Outputs data signal.
66	TRVI	Input port for the [XVERT] detection signal.
69	IKEY	Input port for transmit control signal from the antenna tuner CPU (CTRL board; IC5).
70	RXS	Outputs R8V regulator (Q601, Q602, D601) control signal. Low : While receiving
71	TXS	Outputs T8V regulator (Q611, Q612, D611) control signal. Low : While transmitting
72	ISTA	Outputs antenna tuner start signal.
73	DRES	Outputs reset/inhibit signal to the sub-CPU (DISPLAY board; IC401), DDS ICs (PLL unit; IC101, IC401), antenna tuner CPU (CTRL board; IC5), and etc.
74	UNLC	Input port for unlock signal from the PLL unit.
75	PSTB	Outputs strobe signals for the I/O expander IC (PLL unit; IC1).
76	PSEL	Outputs strobe selection signals for the I/O expander (PLL unit; IC1).
77	CON2	Outputs control signal for the DDS circuits (PLL unit; IC101, IC401).

Pin number	Port name	Description
78	CON1 (PDAT)	Outputs data signal for the DDS circuits (PLL unit; IC101, IC401).
79	CON0 (PCK)	Outputs clock signal for the DDS circuits (PLL unit; IC101, IC401).
85, 86	XTAL, EXTAL	Input ports for the CPU system clock oscillator (X3501; 19.6608 MHz).
96	LRES	Outputs reset/inhibit signal for the LCD controller (IC3551), I/O expander (IC3652-IC3654), and etc.
97	LTXD	Outputs data signal for the sub-CPU (DISPLAY board; IC401).
98	LRXD	Input port for data signal from the sub-CPU (DISPLAY board; IC401).
101	TMD	Outputs [TIMER] indicator control signal. High: When the timer function is ON
105	SCPL	Input port for the scope signal.
106	VOXL	A/D input port for the VOX gain.
107	AVXL	A/D input port for the anti-VOX level.
108	ASO0	A/D input port via the analog switch (IC3631) for the SML signal from the S-meter amplifier circuit (IC101a), and ALCL signal from the ALC meter amplifier circuit (IC551a).
109	ASO1	A/D input port via the analog switch (IC3631) for the NSQO signal from the level conveter (DSP-A board; IC2063), for noise squelch operation, and FORL signal from the power meter amplifier circuit (IC571a).
110	ASO2	A/D input port from the analog switch (IC3631) for the FNTL signal from the low-pass filter (DSP-A board; IC2472a), for tone squelch operation, and REFL signal from the SWR meter amplifier circuit (IC571b).
111	STON	Outputs CW side-tone signals.
112	BEEP	Outputs beep audio signals.
115	SENI	Input port for connected microphone's PTT switch and SEND signal from the ACC jacks. High: While PTT switch is pushed or activated from an external unit.
116	PWRS	Outputs control signal for the power switching relay (PA unit; RL1) . High: During power ON

3-7-4 INPUT EXPANDER ALLOCATIONS

(1) DISPLAY board; IC411

Pin number	Port name	Description
1	KI4	Input port for the [RIT], [Δ TX] and [CLEAR] switches.
5	MUDK	Input port for [UP] and [DN] switches of the connected microphone.
12	KI3	Input port for the [D-WATCH], [CHANGE], [V/M] and [M/S] switches.
13	KI0	Input port for the [TUNER], [MONITOR], [NB] and [NR] switches.
14, 15	KI1, KI2	Input ports for the multi-function switches.

(2) MAIN-A unit; IC3652

Pin number	Port name	Description
11	CTFL	Input port transmission status for CW
12	RTDT	Input port for RTTY decode data.
13	EKEY	Input port for the KEY signal from the connected AH-3. Low : While tuning or tune NG
14	TCON	Input port for AH-3 connection detection. High: When AH-3 is connected.
16	VINT	Input port for interrupting signal from audio recoder.
17	VRAC	Input port for address clock signal from audio recoder.
18	SBSY	Input port for busy signal from the installed UT-102 SPEECH SYNTHESIZER.

3-7-4 OUTPUT EXPANDER ALLOCATIONS

(1) PLL unit; IC1

Pin number	Port name	Description
4	PST1	Outputs strobe signals to DDS IC (IC101) for the 1st LO PLL A circuit.
5	PST2	Outputs strobe signals to PLL IC (IC381) for the 1st LO PLL A circuit.
6	PST3	Outputs strobe signals to DDS IC (IC401) for the 1st LO PLL B circuit.
7	PST4	Outputs strobe signals to PLL IC (IC681) for the 1st LO PLL B circuit.
12	PST5	Outputs strobe signals to DDS IC (IC701) for the 3rd LO PLL circuit.
13	PST6	Outputs strobe signals to PLL IC (IC901) for the S2 LO PLL circuit.
14	PST7	Outputs strobe signals to DDS IC (IC801) for the S3 LO PLL circuit.

(2) PLL unit; IC101

Pin number	Port name	Description
66	MAKS	Outputs the marker mute switch (IC192) control signal. High : When the [MARKER] is ON and receiving.
68	PAMT	Outputs LO mute switch (Q361) control signal. Low : Muted
70	PAFS	Outputs bandpass filter select switch (Q351) control signal. High : When less than 8 MHz is displayed on the main band.
71	VA4S	Outputs the LO switch (Q121) control signal. High : While 45.0–60.0 MHz band is displayed on the main band.
73	VA3S	Outputs the LO switch (Q122) control signal. High : While 20.0–44.999999 MHz band is displayed on the main band.
74	VA2S	Outputs the LO switch (Q123) control signal. High : While 8.0–19.999999 MHz band is displayed on the main band.
75	VA1S	Outputs the LO switch (Q126) control signal. High : While 0.03–7.999999 MHz band is displayed on the main band.

(3) PLL unit; IC401

Pin number	Port name	Description
68	PBMT	Outputs LO mute switch (Q661) control signal. Low : Muted
70	PBFS	Outputs bandpass filter select switch (Q651) control signal. High : When less than 8 MHz is displayed on the main band.
71	VB4S	Outputs the LO switch (Q421) control signal. High : While 45.0–60.0 MHz band is displayed on the main band.
73	VB3S	Outputs the LO switch (Q422) control signal. High : While 20.0–44.999999 MHz band is displayed on the main band.
74	VB2S	Outputs the LO switch (Q423) control signal. High : While 8.0–19.999999 MHz band is displayed on the main band.
75	VB1S	Outputs the LO switch (Q426) control signal. High : While 0.03–7.999999 MHz band is displayed on the main band.

(4) CTRL board; IC11

Pin number	Port name	Description
4	L1S	Outputs a low-pass filter select signal. High: When 0.03–1.999999 MHz band is selected.
5	L2S	Outputs a low-pass filter select signal. High: When 2.0–5.999999 MHz band is selected.
6	L3S	Outputs a low-pass filter select signal. High: When 6.0–7.999999 MHz band is selected.
7	L4S	Outputs a low-pass filter select signal. High: When 8.0–11.999999 MHz band is selected.
11	L8S	Outputs a low-pass filter select signal. High: When 30.0–60.0 MHz band is selected.
12	L7S	Outputs a low-pass filter select signal. High: When 22.0–29.999999 MHz band is selected.
13	L6S	Outputs a low-pass filter select signal. High: When 15.0–21.999999 MHz band is selected.
14	L5S	Outputs a low-pass filter select signal. High: When 12.0–14.999999 MHz band is selected.

(6) RF-A unit; IC902

Pin number	Port name	Description
4	B7WS	Outputs a low-pass filter select signal. High: When 11–13.999999 MHz or 14.5–14.999999 MHz band is selected.
5	B7S	Outputs a low-pass filter select signal. High: When 14.0–14.499999 MHz band is selected.
6	B8WS	Outputs a low-pass filter select signal. High: When 15.0–20.999999 MHz or 21.5–21.999999 MHz band is selected.
7	B8W	Outputs a low-pass filter select signal. High: When 21.0–21.499999 MHz band is selected.
12	B10S	Outputs a low-pass filter select signal. High: When 50.0–54.0 MHz band is selected.
13	B10WS	Outputs a low-pass filter select signal. High: When 30.0–49.999999 MHz or 54.000001–60.0 MHz band is selected.
14	B9S	Outputs a low-pass filter select signal. High: When 22.0–29.999999 MHz band is selected.

(5) RF-A unit; IC901

Pin number	Port name	Description
4	B0S	Outputs a bandpass filter select signal. High: When 0.03–1.599999 MHz band is selected.
5	B1S	Outputs a bandpass filter select signal. High: When 1.6–1.999999 MHz band is selected.
6	B2S	Outputs a bandpass filter select signal. High: When 2.0–2.999999 MHz band is selected.
7	B3S	Outputs a bandpass filter select signal. High: When 3.0–3.999999 MHz band is selected.
11	B6S	Outputs a bandpass filter select signal. High: When 8.0–10.999999 MHz band is selected.
12	B5S	Outputs a bandpass filter select signal. High: When 7.0–7.299999 MHz band is selected.
13	B5WS	Outputs a bandpass filter select signal. High: When 6.0–6.999999 MHz or 7.3–7.999999 MHz band is selected.
14	B4S	Outputs a bandpass filter select signal. High: When 4.0–5.999999 MHz band is selected.

(7) RF-A unit; IC905

Pin number	Port name	Description
4	AT1S	Outputs control signal for the attenuator circuit (RL121, R121, R122). Low : When 6 dB attenuator is ON
5	AT2S	Outputs control signal for the attenuator circuit (RL122, R123, R124). Low : When 12 dB attenuator is ON
6	PR1S	Outputs control signal for the pre-amplifier 1 circuit (Q441, Q442). High: When P.AMP 1 is selected.
7	PR2S	Outputs control signal for the pre-amplifier 2 circuit (IC451). High: When P.AMP 2 is selected.
14	RANS	Outputs the RX antenna select signal. Low : When [RX ANT] is selected.

(8) MAIN-A unit; IC3653

Pin number	Port name	Description
13	BSTB	Outputs strobe signals for the output expander ICs (RF-A unit; IC901, IC902, IC905).
14	ANTS	Outputs the antenna connector ([ANT1] or [ANT2]) select signal. High: When the [ANT2] is selected.
15	FSTB	Outputs strobe signals for the output expander (CTRL board; IC11).
16	ASTB	Outputs strobe signals for the D/A converter (IC3751).
17	MSTB	Outputs strobe signals for the output expander ICs (IC3752, IC3753).
18	AFMS	Outputs control signal for the AF mute switch (IC331). High: When the [AF] control is set to maximum counter clockwidth.
19	SQLS	Outputs squelch mute control signal, applied to the squelch gate (IC301). High: Squelched

(9) MAIN-A unit; IC3654

Pin number	Port name	Description
12	SQSS	Outputs squelch control signal for the [MIC] and [ACC1] connectors. High: Squelch open. (RX LED ON)
13	SPS	Outputs control signal for the internal speaker ON/OFF select relay (RL351). High: Internal speaker is ON.
14	SSTB	Outputs strobe signals for the optional UT-102 SPEECH SYNTHESIZER.
15	VCS	Outputs chip select signal for the audio recoder (IC3001).
16	ESTA	Outputs external antenna tuner (AH-3) start signal. Low : When the [TUNE] switch is pushed.
17, 18	DSFR, DSFW	Outputs control signal for the DSP IC (DSP-A board; IC2001).

(10) MAIN-A unit; IC3752

Pin number	Port name	Description
4	NBS	Outputs control signal for the noise blanker switch (Q3751, Q3752). High: When the [NB] switch is ON, except in FM mode.
6	MSL1	Outputs audio select signal for the TX monitor function. High: During monitoring in SSB or RTTY mode.
7	MSL2	Outputs audio select signal for the TX monitor function. High: During monitoring in AM or FM mode.
12	VO SL	Outputs analog switch (IC3005) control signal for the audio recoder's (IC3001) output. High: When the audio recoder's output to the AF circuit.
14	MISL	Outputs analog switch (IC3002) control signal for input of the microphone amplifier (IC461). High: Except the microphone input is selected.

(11) MAIN-A unit; IC3753

Pin number	Port name	Description
4	AMS	Outputs AM mode select signal for the AGC and APC circuit. High: When AM is selected.
5	PHFS	Outputs HF band RF power control signal. High: When 0.03–29.999999 MHz band is selected.
6	P50S	Outputs 50 MHz band RF power control signal. High: When 30–60 MHz band is selected.
7	MODS	Outputs 2nd IF filter (F1131 or F1133) select signal. High: When transmitting in AM or FM mode. (F1131 is ON)
11	DSRS	Outputs reset signal for the DSP circuit and etc.
14	FMNS	Outputs FM deviation control signal. High: When FM-N is selected.

SECTION 4 ADJUSTMENT PROCEDURES

4-1 PREPARATION BEFORE SARVICING

■ REQUIRED TEST EQUIPMENT

EQUIPMENT	GRADE AND RANGE	EQUIPMENT	GRADE AND RENG
DC power supply	Output voltage : 13.8 V DC Current capacity : 30 A or more	Audio generator	Frequency range : 300–3000 Hz Measuring range : 1–500 mV
RF power meter (terminated type)	Measuring range : 10–200 W Frequency range : 1.8–100 MHz Impedance : 50 Ω SWR : Less than 1.2 : 1	Standard signal generator (SSG)	Frequency range : 0.1–100 MHz Output level : 0.1 μV–32 mV (–127 to –17 dBm)
Frequency counter	Frequency range : 0.1–100 MHz Frequency accuracy : ±0.5 ppm or better Sensitivity : 100 mV or better	Digital multimeter	Input impedance : 10 MΩ/DC or beter
RF voltmeter	Frequency range : 0.1–100 MHz Measuring range : 0.01–10 V	AC millivoltmeter	Measuring range : 10 mV–10 V
FM deviation meter	Frequency range : DC–500 MHz Measuring range : 0 to ±5 kHz	DC voltmeter	Input impedance : 50 kΩ/V DC or better
Modulation analyzer	Frequency range : At least 90 MHz Measuring range : 0–100 %	DC ammeter	Measurement capability: 1 A/30 A
Distortion meter	Frequency range : 1 kHz ±10 % Measuring range : 1–100 %	Spectrum analyzer	Frequency range : At least 90 MHz Spectrum bandwidth : 100 kHz or more
Oscilloscope	Frequency range : DC–20 MHz Measuring range : 0.01–20 V	Attenuator	Power attenuation : 50 or 60 dB Capacity : 150 W or more
		External speaker	Input impedance : 8 Ω Capacity : 5 W or more
		Terminator	Resistance : 50 and 150 Ω Capacity : 150 W or more

■ CONNECTIONS

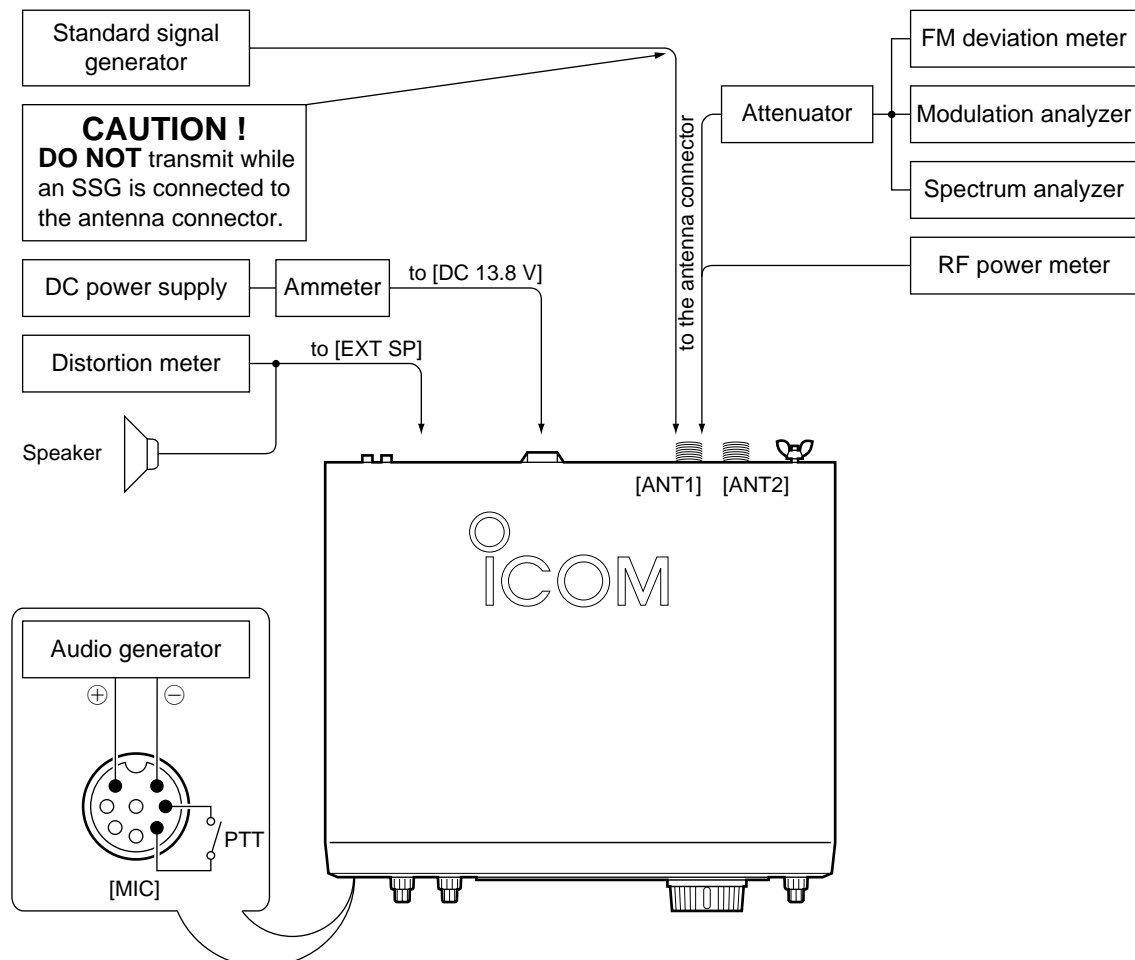

4-2 PLL ADJUSTMENTS

ADJUSTMENT		ADJUSTMENT CONDITION	MEASUREMENT		VALUE	ADJUSTMENT POINT	
			UNIT	LOCATION		UNIT	ADJUST
REFERENCE FREQUENCY	1	<ul style="list-style-type: none"> • Display frequency: Any • Turn L52 on the PLL unit to 4 rotation downside for presetting. • Receiving 	PLL	Connect a frequency counter to the check point P81.	64.000000 MHz	PLL	L52 (R33 for critical adjustment)
	2			Connect an RF voltmeter to the check point P81.			Maximum level (0 dB or more)
LPL-A LOCK VOLTAGE	1	<ul style="list-style-type: none"> • Display frequency: 0.030000 MHz • Mode : USB • Receiving 	PLL	Connect a digital multimeter or oscilloscope to the check point LPA.	2.0 V	PLL	C154
VCO-A LOCK VOLTAGE	1	<ul style="list-style-type: none"> • Display frequency: 7.999999 MHz • Mode : USB • Receiving 	PLL	Connect a digital multimeter or oscilloscope to the check point LVA.	4.3 V	PLL	C278
	2	<ul style="list-style-type: none"> • Display frequency: 19.999999 MHz • Mode : USB • Receiving 			4.3 V		C258
	3	<ul style="list-style-type: none"> • Display frequency: 44.999999 MHz • Mode : USB • Receiving 			4.3 V		C228
	4	<ul style="list-style-type: none"> • Display frequency: 60.000000 MHz • Mode : USB • Receiving 			4.3 V		C208
1LO-A OUTPUT LEVEL	1	<ul style="list-style-type: none"> • Display frequency: 0.030000 MHz, 7.999999 MHz, 8.000000 MHz, 19.999999 MHz, 20.000000 MHz, 44.999999 MHz, 45.000000 MHz, 60.000000 MHz • Receiving 	PLL	Connect an RF voltmeter to the check point P351.	-2 dBm or more		Verify
LPL-B LOCK VOLTAGE	1	<ul style="list-style-type: none"> • Sub display freq. : 0.030000 MHz • Mode : USB • Receiving 	PLL	Connect a digital multimeter or oscilloscope to the check point LPB.	2.0 V	PLL	C454
VCO-B LOCK VOLTAGE	1	<ul style="list-style-type: none"> • Sub display freq. : 7.999999 MHz • Mode : USB • Receiving 	PLL	Connect a digital multimeter or oscilloscope to the check point LVB.	4.3 V	PLL	C578
	2	<ul style="list-style-type: none"> • Sub display freq. : 19.999999 MHz • Mode : USB • Receiving 			4.3 V		C558
	3	<ul style="list-style-type: none"> • Display frequency: 44.999999 MHz • Mode : USB • Receiving 			4.3 V		C528
	4	<ul style="list-style-type: none"> • Display frequency: 60.000000 MHz • Mode : USB • Receiving 			4.3 V		C508
1LO-B OUTPUT LEVEL	1	<ul style="list-style-type: none"> • Sub display freq. : 0.030000 MHz, 7.999999 MHz, 8.000000 MHz, 19.999999 MHz, 20.000000 MHz, 44.999999 MHz, 45.000000 MHz, 60.000000 MHz • Receiving 	PLL	Connect an RF voltmeter to the check point P651.	-2 dBm or more		Verify
3LO OUTPUT LEVEL	1	<ul style="list-style-type: none"> • Display frequency: Any • Receiving 	PLL	Connect an RF voltmeter to the check point P701.	-10 dBm or more		Verify
S3LO OUTPUT LEVEL	1	<ul style="list-style-type: none"> • Display frequency: Any • Receiving 	PLL	Connect an RF voltmeter to the check point P801.	-7 dBm or more		Verify

PLL ADJUSTMENTS—continued

ADJUSTMENT	ADJUSTMENT CONDITION	MEASUREMENT		VALUE	ADJUSTMENT POINT	
		UNIT	LOCATION		UNIT	ADJUST
S2LO OUTPUT LEVEL	1 • Display frequency: Any • Receiving	PLL	Connect an RF voltmeter to the check point P901.	-3 dBm or more		Verify
MARKER OUTPUT LEVEL	1 • Display frequency: Any • Receiving	PLL	Connect an oscilloscope to the check point P851.	4 Vp-p or more		Verify

• PLL unit

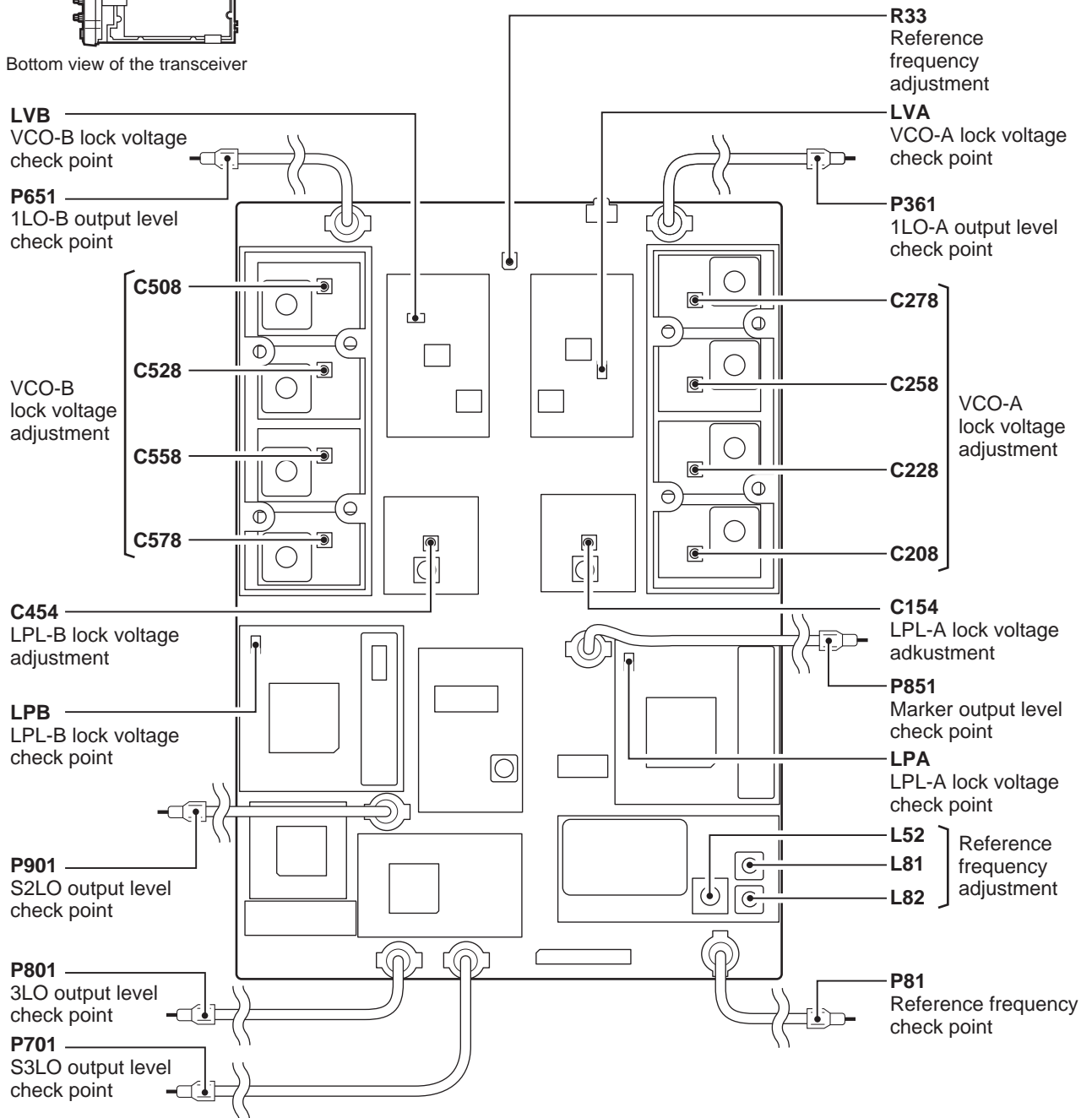
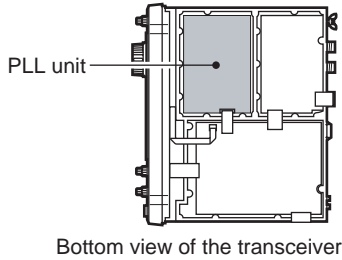

4-3 TRANSMITTER ADJUSTMENTS

ADJUSTMENT	ADJUSTMENT CONDITION	MEASUREMENT		VALUE	ADJUSTMENT POINT		
		UNIT	LOCATION		UNIT	ADJUST	
IDLING CURRENT (for driver)	1	<ul style="list-style-type: none"> • Display frequency: 14.100000 MHz • Mode : CW (key up) • Preset R11, R18 on the PA unit to max. CCW. • [RF POWER] : Max. CW • [TUNER] : OFF • Transmitting (without key) 	PA	Unsolder W29. Connect an ammeter to the unsoldering points of W29.	100 mA	PA	R11
	After adjustment, re-solder the lead wire (W29) on the PA board.						
(for final amplifier)	2	<ul style="list-style-type: none"> • Transmitting (without key) 	PA	Unsolder R28 (L8 side). Connect an ammeter to the unsoldering points of R28.	500 mA	PA	R18
	After adjustment, re-solder the resistor (R28) on the PA board.						
TX PEAK	1	<ul style="list-style-type: none"> • Display frequency: 14.100000 MHz • Mode : USB • Set following selections, controls and functions as : [VOX]: OFF , [ΔTX] : OFF PBT1 : Center , PBT2 : Center Filter : 2.4 kHz [RF POWER] : Max. CW [MIC GAIN] : Center [TUNER] : OFF [METER] : METER Po [MONITOR] : OFF • Apply no audio signals to [MIC] connector. • Transmitting 	MAIN-A	Connect a digital multimeter or oscilloscope to the check point CP243.	0.06 V	MAIN-A	R247
	2	<ul style="list-style-type: none"> • Connect an audio generator to [MIC] connector and set as: Frequency : 1.5 kHz Level : 1 mVrms • Transmitting 	Rear panel	Connect an RF power meter to [ANT1] connector.	50 W	Front panel	[MIC GAIN] control
	3	<ul style="list-style-type: none"> • Transmitting 			Maximum output power	MAIN-A	L261
	4	<ul style="list-style-type: none"> • [MIC GAIN] : Center • Preset L711, L712, L713 to bottom. • Connect an audio generator to [MIC] connector and set as: Frequency : 1.5 kHz Level : 10 mVrms • Transmitting 	RF-A	Connect an RF voltmeter to the check point J151.	Maximum level	RF-A	L701, L711, L712, L713, L752
	Adjustment in sequence L701, L752, L713, L711, L713, L712, L711, L713, L711, L712.						
TRANSMITTER TOTAL GAIN	1	<ul style="list-style-type: none"> • Display frequency: 14.100000 MHz • Mode : USB • [MIC GAIN] : Center • Connect an audio generator to [MIC] connector and set as: Frequency : 1.5 kHz Level : 1 mVrms • Transmitting 	Rear panel	Connect an RF power meter to [ANT1] connector.	50 W	MAIN-A	R263

• PA unit

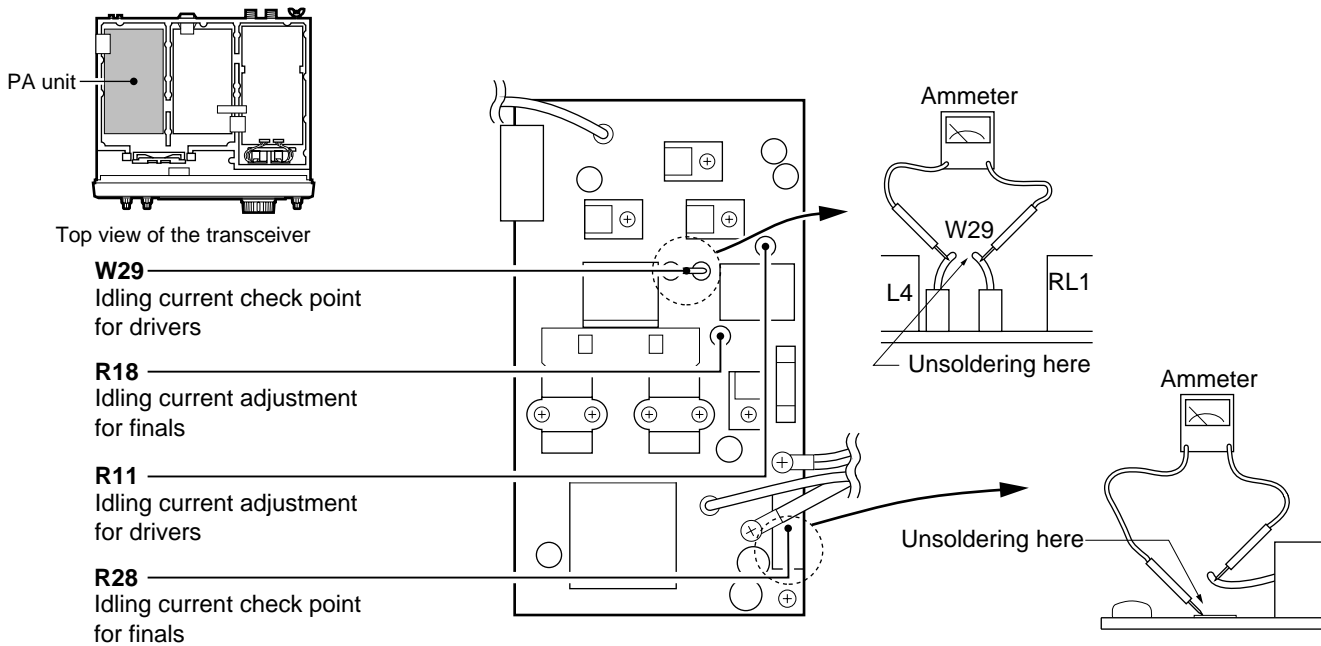

• MAIN-A unit

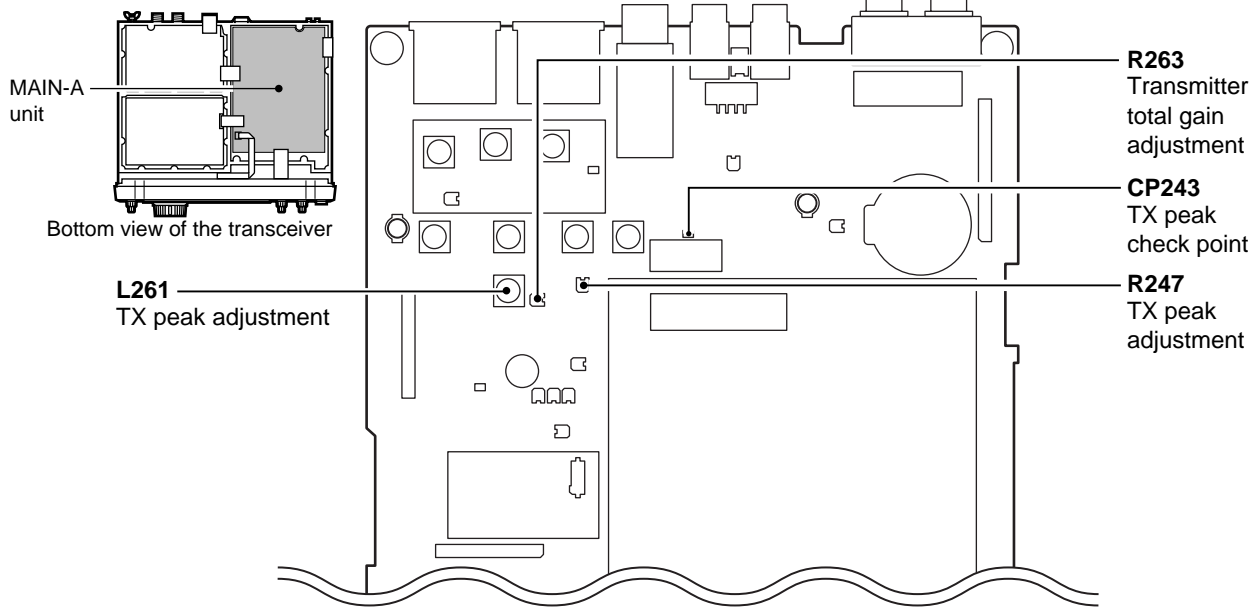

• RF-A unit

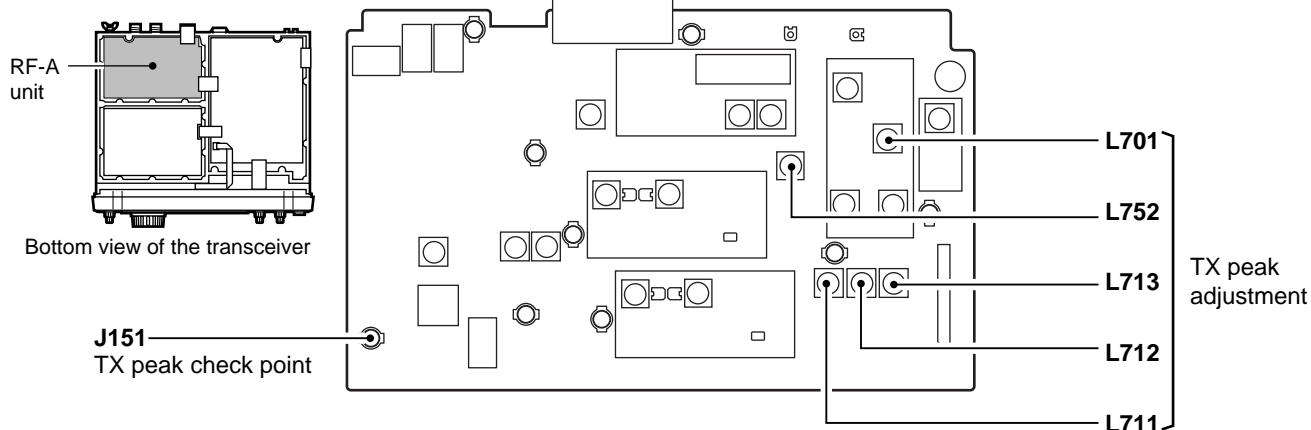

TRANSMITTER ADJUSTMENTS—continued

ADJUSTMENT		ADJUSTMENT CONDITION	MEASUREMENT		VALUE	ADJUSTMENT POINT	
			UNIT	LOCATION		UNIT	ADJUST
Ic APC	1	<ul style="list-style-type: none"> • Display frequency: 3.550000 MHz • Mode : RTTY • Connect CP501 to GND. • Transmitting 	Rear panel	Connect an ammeter between power supply and the IC-756PROII.	23 A	MAIN-A	R545
HF BANDS OUTPUT POWER	1	<ul style="list-style-type: none"> • Display frequency: 14.100000 MHz • Mode : RTTY • [RF POWER] : Max. CW • [TUNER] : OFF • Transmitting 	Rear panel	Connect an RF power meter to [ANT1] connector.	100 W	MAIN-A	R507
50 MHz BAND OUTPUT POWER	1	<ul style="list-style-type: none"> • Display frequency: 51.000000 MHz • Mode : RTTY • [RF POWER] : Max. CW • [TUNER] : OFF • Transmitting 	Rear panel	Connect an RF power meter to [ANT1] connector.	100 W	MAIN-A	R509
AM CARRIER	1	<ul style="list-style-type: none"> • Display frequency: 29.60000 MHz • Mode : AM • [RF POWER] : Max. CW • [MIC GAIN] : Center • Apply no audio signals to [MIC] connector. • Transmitting 	Rear panel	Connect an RF power meter to [ANT1] connector.	40 W	MAIN-A	R510
FM DEVIATION	1	<ul style="list-style-type: none"> • Displayed freq. : 29.60000 MHz • Mode : FM • Filter : 15 kHz • [RF POWER] : Max. CW • [MIC GAIN] : Center • Connect an audio generator to [MIC] connector and set as: <ul style="list-style-type: none"> Frequency : 1 kHz Level : 10 mVrms • Transmitting 	Rear panel	Connect an FM deviation meter to [ANT1] connector through an attenuator.	±4.5 kHz	DSP-A	R2227
AM MODULATION	1	<ul style="list-style-type: none"> • Display frequency: 14.10000 MHz • Mode : AM • [MIC GAIN] : Center • [RF POWER] : Max. CCW • Connect an audio generator to [MIC] connector and set as: <ul style="list-style-type: none"> Frequency : 1 kHz Level : 10 mVrms • Transmitting 	Rear panel	Connect a modulation analyzer to [ANT1] connector through an attenuator.	90%	DSP-A	R2229

• **MAIN-A unit**

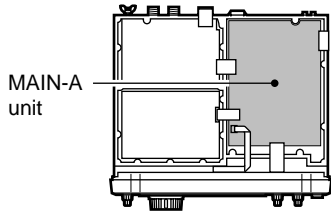

Bottom view of the transceiver

R509
50 MHz band output power adjustment

CP501
Ic APC check point

R507
HF bands output power adjustment

R545
Ic APC adjustment

R510
AM carrier adjustment

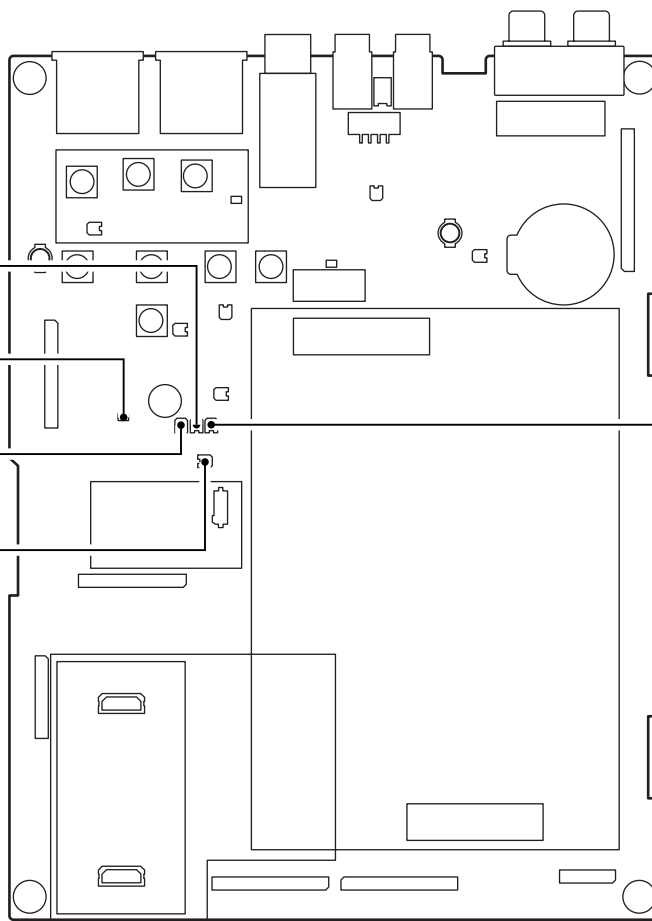

• **DSP-A board**

DSP-A board

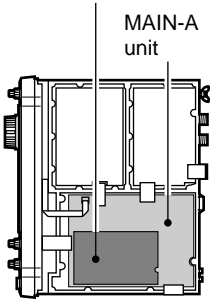

Bottom view of the transceiver

R2227
FM deviation adjustment

R2229
AM modulation adjustment

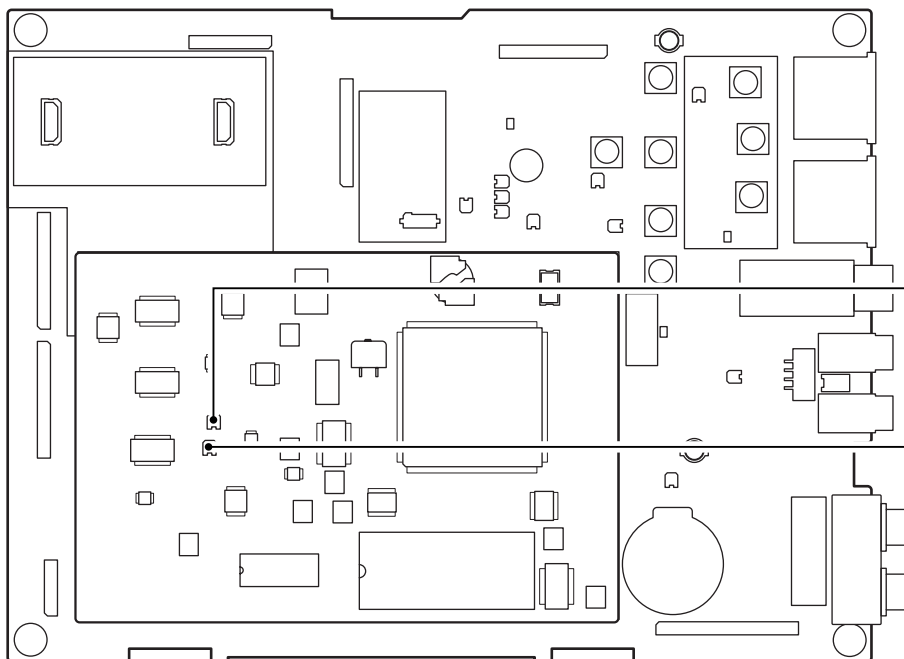

4-4 RECEIVER ADJUSTMENTS

ADJUSTMENT	ADJUSTMENT CONDITION	MEASUREMENT		VALUE	ADJUSTMENT POINT		
		UNIT	LOCATION		UNIT	ADJUST	
RX PEAK	1	<ul style="list-style-type: none"> • Display frequency: 14.100000 MHz • [DUAL WATCH] : OFF • Mode : USB • Set following selections, controls and functions as : <ul style="list-style-type: none"> [AGC]: MID , [ATT] : OFF [NB] : OFF , [RIT] : OFF PBT1 : Center , PBT2 : Center Filter : 2.4 kHz [P.AMP] : P.AMP1 [RF/SQL] : Center [NOTCH] : OFF [NR] switch : OFF • Preset center dots to 90° difference on the roter and stater of C555 and C655. • Connect an SSG to [ANT1] connector and set as : <ul style="list-style-type: none"> Frequency : 14.101500 MHz Level : 10 μV* (-87 dBm) Modulation: 1 kHz/\pm5.0 kHz dev. • Receiving 	Rear panel	Connect an AC millivolt meter to [EXT SP] connector with an 8 Ω load.	Maximum audio output level	RF-A	L513, C555
	Adjustment L513 to upper side of 2 peak points.						
	2	<ul style="list-style-type: none"> • Sub display freq. : 14.100000 MHz • [DUAL WATCH] : ON • Mode : USB • [BAL] : Max. CW • Set an SSG as : <ul style="list-style-type: none"> Level : 10 μV* (-87 dBm) • Receiving 		Connect an AC millivolt meter to [EXT SP] connector with an 8 Ω load.	Maximum audio output level	RF-A	L613, C655
Adjustment L613 to upper side of 2 peak points.							
3 On the MAIN-A unit, set L111, L112, L113, L141's top to same hight with coil's case.							
FM DISTORTION	1	<ul style="list-style-type: none"> • Display frequency: 14.100000 MHz • [DUAL WATCH] : OFF • Mode : FM • Filter : 15 kHz • [P.AMP] : P.AMP1 • Connect an SSG to [ANT1] connector and set as : <ul style="list-style-type: none"> Frequency : 14.100000 MHz Level : 500 μV* (-53 dBm) Modulation: 1 kHz/\pm5.0 kHz Dev. • Receiving 	Rear panel	Connect an distortion meter to [EXT SP] connector with an 8 Ω load.	Minimum distortion level	RF-A	L713, L721
	Adjustment in sequence L721, L713, L721.						
MIXER BALANCE	1	<ul style="list-style-type: none"> • Display frequency: 1.900000 MHz • Sub display freq. : 1.900000 MHz • [DUAL WATCH] : ON • Mode : USB • [BAL] : Max. CCW • Apply no no RF signal to [ANT1] connector. • Receiving 	Rear panel	Connect a spectrum analyzer to the check point J711.	Minimum noise output level	RF-A	R515, R516
	2	<ul style="list-style-type: none"> • [BAL] : Max. CW • Receiving 					R615, R616

*This output level of a standard signal generator (SSG) is indicated as SSG's open circuit.

• RF-A unit

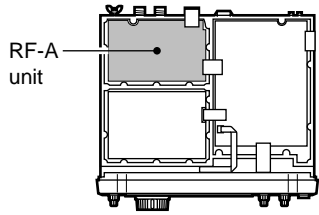

Bottom view of the transceiver

Mixer balance adjustment

- R515
- R516
- R615
- R616

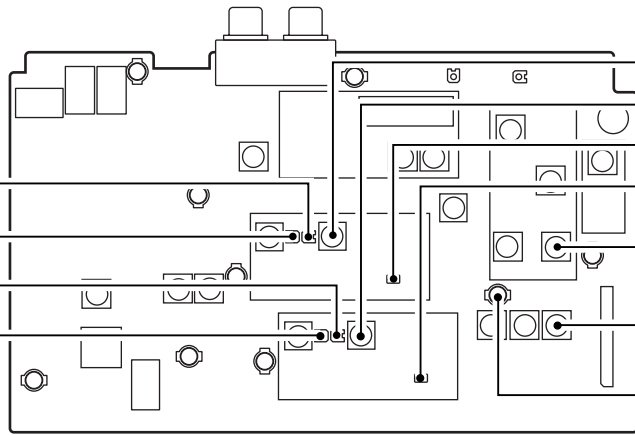

- L513
- L613 RX peak adjustment
- C555
- C655
- L721 FM distortion adjustment
- L713
- J711 Mixer balance check point

• MAIN-A unit

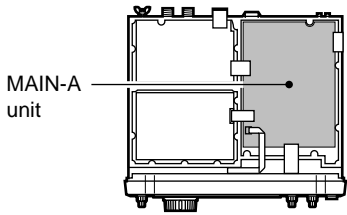

Bottom view of the transceiver

RX peak adjustment

- L111
- L112
- L113
- L141

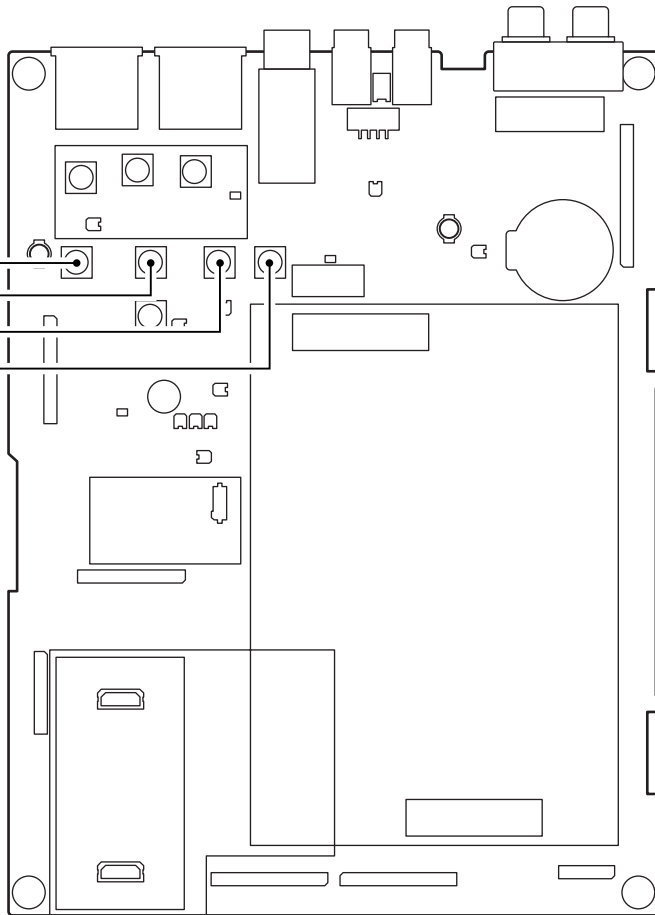

RECEIVER ADJUSTMENTS—continued

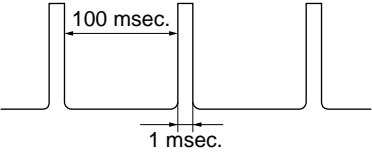
ADJUSTMENT	ADJUSTMENT CONDITION	MEASUREMENT		VALUE	ADJUSTMENT POINT		
		UNIT	LOCATION		UNIT	ADJUST	
RECEIVER TOTAL GAIN	1 <ul style="list-style-type: none"> • Display frequency: 14.100000 MHz • [DUAL WATCH] : OFF • Mode : USB • Filter : 2.4 kHz • [AGC] : OFF • [P.AMP] : OFF • Connect an SSG to [ANT1] connector and set as : <ul style="list-style-type: none"> Frequency : 14.101500 MHz Level : 160 mV* (-3 dBm) Modulation: OFF • Receiving 	MAIN-A	Connect an oscilloscope to the check point CP213.	3.7 Vp-p	MAIN-A	R210	
NOISE BLANKER	1 <ul style="list-style-type: none"> • Display frequency: 14.100000 MHz • [DUAL WATCH] : OFF • Mode : USB • [AGC] : MID • [P.AMP] : P.AMP1 • [NB] : OFF • [NB LEVEL] : 50% • Connect an SSG to [ANT1] connector and set as : <ul style="list-style-type: none"> Frequency : 14.101500 MHz Level : 5.6 μV* (-92 dBm) Modulation: OFF and apply following signal to [ANT1] connector.  <ul style="list-style-type: none"> • Preset R271 on the MAIN-A unit to the 12 o'clock position. • Receiving 	MAIN-A	Connect an oscilloscope to the check point CP271.	Maximum noise level	MAIN-A	L271, L272, L273	
	2 <ul style="list-style-type: none"> • [NB] : ON • Receiving 			At the point where the voltage just reduces.			R271
SPECTRUM SCOPE	1 <ul style="list-style-type: none"> • Display frequency: 14.100000 MHz • Mode : USB • [DUAL WATCH] : OFF • [P.AMP] : OFF • [SCOPE] : ON • [SCOPE ATT] : OFF • Verify the connection of J841 on the RF-A unit and P801 (S3LO: 12.89000 MHz/-7 dBm) from the PLL unit. • Connect an SSG to [ANT1] connector and set as : <ul style="list-style-type: none"> Frequency : 14.101500 MHz Level : 1 μV* (-107 dBm) Modulation: OFF • Receiving 	RF-A	Connect a digital multimeter or oscilloscope to the check point CP871.	Maximum voltage	RF-A	L812, L813, L833	
	2 <ul style="list-style-type: none"> • Set an SSG output level to OFF. • Receiving 			0.1 V			R872
	3 <ul style="list-style-type: none"> • Set an SSG output level as: <ul style="list-style-type: none"> Level : 50 mV* (-13 dBm) • Receiving 			4.4 V			R863

*This output level of a standard signal generator (SSG) is indicated as SSG's open circuit.

• **MAIN-A unit**

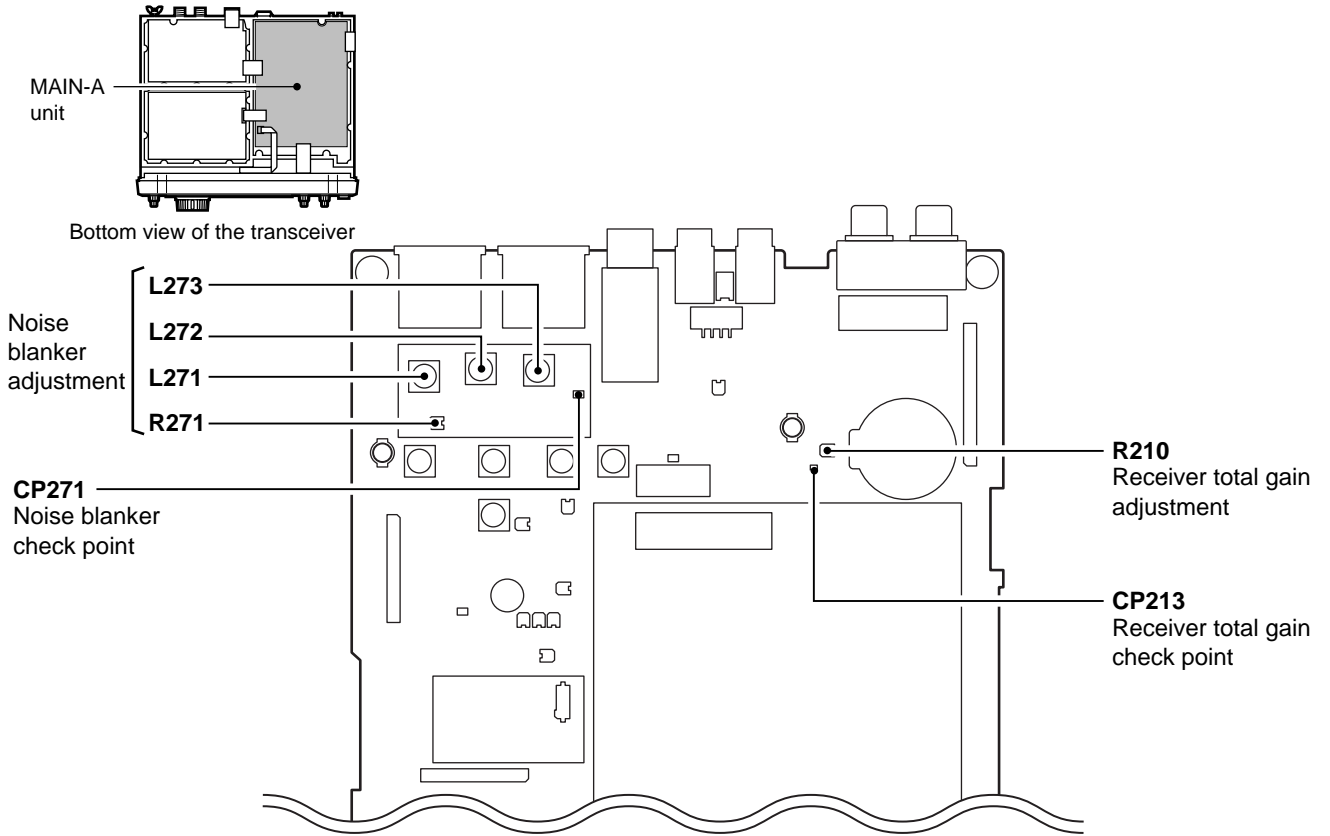

• **RF-A unit**

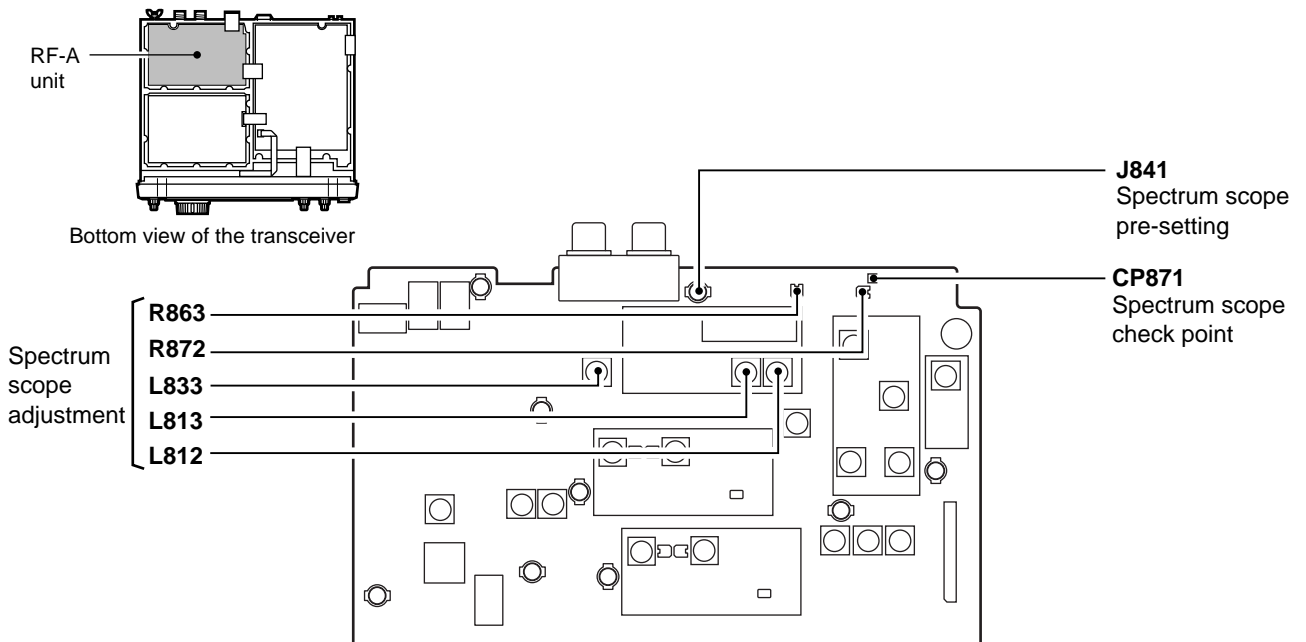

4-5 TUNER ADJUSTMENT

ADJUSTMENT	ADJUSTMENT CONDITION	MEASUREMENT		VALUE	ADJUSTMENT POINT		
		UNIT	LOCATION		UNIT	ADJUST	
SWR DETECTOR	1	<ul style="list-style-type: none"> • Display frequency: 29.70000 MHz • Mode : FM • [RF POWER] : Max. CW • [TUNER] : Through • Connect J12 (SETI) on the CTRL unit to GND. • Connect a 50 Ω terminator to [ANT1] connector. • Transmitting 	CTRL	Connect a digital multimeter or oscilloscope to the check point J14.	Minimum voltage	CTRL	C3
		ADJUSTMENT CONDITION	DISPLAY		OPERATION		
	2	<ul style="list-style-type: none"> • Enter the tuner adjustment mode: <ol style="list-style-type: none"> ① Turn power OFF. ② Terminate the [REMOTE] jack with a 3.5(d) mm mini-plug. ③ While pushing [FILTER] and [EXIT], turn power ON. 	TUNER-ADJUST MODE		Push [F-5 (START)] to start tuning.		
	3		<pre> --- TUNER --- Adjusting Now </pre>		Verify the display shows "Adjusting Now".		
	4		<pre> --- TUNER --- OK </pre>		Verify the display shows "OK".		
After adjustment, disconnect J12 (SETI) on the CTRL unit from GND.							

• CTRL unit

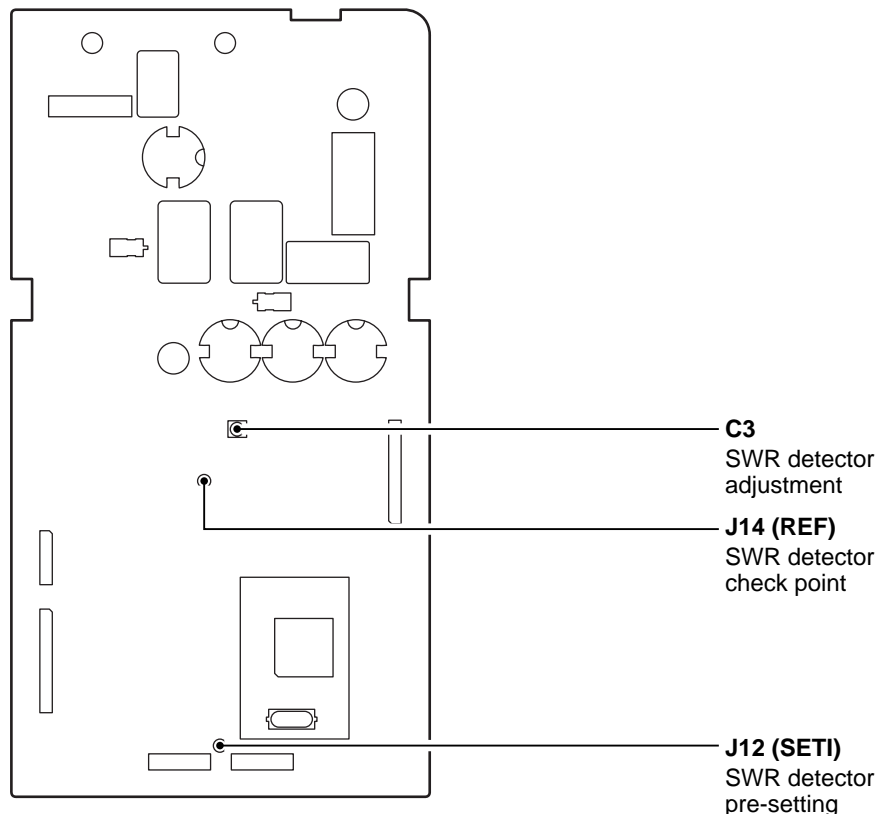
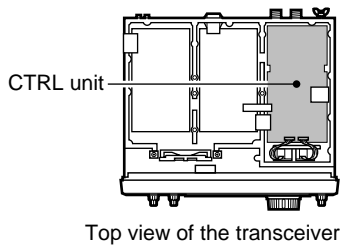

4-6 METER ADJUSTMENT

ADJUSTMENT	ADJUSTMENT CONDITION	DISPLAY	OPERATION
ENTERING ADJUSTMENT MODE	1 <ul style="list-style-type: none"> Enter the adjustment mode: <ol style="list-style-type: none"> Turn power OFF. Terminate the [REMOTE] jack with a 3.5(d) mm mini-plug. While pushing [SSB] and [CW/RTTY], turn power ON. 	ADJUST MODE	<p>Push [F-1 (METER)], [F-2 (TX)] or [F-3 (RX)] to select each adjustment mode.</p> <p>Once entering adjustment mode, use [F-1 (▼)] to skip items, or [F-2 (EXIT)] to return the opening display.</p>
	<p>CAUTION: NEVER select adjustment items [F-2 (TX)] while transceiver is connected to an SSG. Because transceiver automatically transmits when transmit item in the [F-2 (TX)] is selected.</p>		
METER SCALE	<ul style="list-style-type: none"> Push [F-1 (METER)] to enter the meter scale adjustment. 	1 --- METER --- SCALE S1	Set the analog meter to S1 position using [MAIN DIAL]. Then push [F-5 (SET)] to store the "S1" meter into memory, and to step next.
		2 --- METER --- SCALE S3	Set the analog meter to S3 position using [MAIN DIAL]. Then push [F-5 (SET)] to store the "S3" meter into memory, and to step next.
		3 --- METER --- SCALE S5	Set the analog meter to S5 position using [MAIN DIAL]. Then push [F-5 (SET)] to store the "S5" meter into memory, and to step next.
		4 --- METER --- SCALE S7	Set the analog meter to S7 position using [MAIN DIAL]. Then push [F-5 (SET)] to store the "S7" meter into memory, and to step next.
		5 --- METER --- SCALE S9	Set the analog meter to S9 position using [MAIN DIAL]. Then push [F-5 (SET)] to store the "S9" meter into memory, and to step next.
		6 --- METER --- SCALE S9+20	Set the analog meter to S9+20 position using [MAIN DIAL]. Then push [F-5 (SET)] to store the "S9+20" meter into memory, and to step next.
		7 --- METER --- SCALE S9+40	Set the analog meter to S9+40 position using [MAIN DIAL]. Then push [F-5 (SET)] to store the "S9+40" meter into memory, and to step next.
		8 --- METER --- SCALE S9+60	Set the analog meter to S9+60 position using [MAIN DIAL]. Then push [F-5 (SET)] to store the "S9+60" meter into memory, and to back to the opening display.
TX METER (HF POWER METER)	<ul style="list-style-type: none"> Push [F-2 (TX)] to enter the TX meter adjustment. Connect an RF power meter to [ANT1] connector. Connect a 100 Ω dummy load to [ANT2] connector. Connect an audio generator to [MIC] connector and set as: Frequency : 1.5 kHz Level : 10 mVrms 	1 --- TX --- POWER 0%	Push [F-5 (SET)] to store the "POWER 0%" meter into memory, and to step next.
		2 --- TX --- POWER HF Tuner	Set the output power to 10 W using [MAIN DIAL]. Then push [F-5 (SET)] to store the "POWER HF Tuner" meter into memory, and to step next.
		3 --- TX --- POWER HF 10%	Set the output power to 10 W using [MAIN DIAL]. Then push [F-5 (SET)] to store the "POWER HF 10%" meter into memory, and to step next.
		4 --- TX --- POWER HF 25%	Set the output power to 25 W using [MAIN DIAL]. Then push [F-5 (SET)] to store the "POWER HF 25%" meter into memory, and to step next.
		5 --- TX --- POWER HF 50%	Set the output power to 50 W using [MAIN DIAL]. Then push [F-5 (SET)] to store the "POWER HF 50%" meter into memory, and to step next.
		6 --- TX --- POWER HF 100%	Set the output power to 100 W using [MAIN DIAL]. Then push [F-5 (SET)] to store the "POWER HF 100%" meter into memory, and to step next.

METER ADJUSTMENT—continued

ADJUSTMENT	ADJUSTMENT CONDITION	DISPLAY	OPERATION
(50M POWER METER)	7	--- TX --- POWER 50M Tuner	Set the output power to 10 W using [MAIN DIAL]. Then push [F-5 (SET)] to store the “POWER 50M Tuner” meter into memory, and to step next.
	8	--- TX --- POWER 50M 10%	Set the output power to 10 W using [MAIN DIAL]. Then push [F-5 (SET)] to store the “POWER 50M 10%” meter into memory, and to step next.
	9	--- TX --- POWER 50M 25%	Set the output power to 25 W using [MAIN DIAL]. Then push [F-5 (SET)] to store the “POWER 50M 25%” meter into memory, and to step next.
	10	--- TX --- POWER 50M 50%	Set the output power to 50 W using [MAIN DIAL]. Then push [F-5 (SET)] to store the “POWER 50M 50%” meter into memory, and to step next.
	11	--- TX --- POWER 50M 100%	Set the output power to 100 W using [MAIN DIAL]. Then push [F-5 (SET)] to store the “POWER 50M 100%” meter into memory, and to step next.
(ALC METER)	12	--- TX --- ALC	Push [F-5 (SET)] to store the “ALC” meter into memory, and to step next.
(DRIVE LEVEL)	13	--- TX --- DRIVE	Push [F-5 (SET)] to store the “DRIVE” level into memory, and to step next.
(SWR METER)	14	--- TX --- SWR	Push [F-5 (SET)] to store the “SWR” meter into memory, and return to opening display.
RX METER ADJUSTMENT (SCOPE SCALE)	1	--- RX --- SCOPE L4	Push [F-5 (SET)] to store the “SCOPE” level into memory, and to step next. NOTE: While RX METER adjustment, NEVER change the connected SSG’s level until transceiver emits “Pi Pi” and changes indication.
(S-METER)	2	--- RX --- S0 LEVEL	Push [F-5 (SET)] to store the “S0” level into memory, and to step next.
	3	--- RX --- S9 LEVEL	Push [F-5 (SET)] to store the “S9” level into memory, and to step next.
	4	--- RX --- S9+60 LEVEL	Push [F-5 (SET)] to store the “S9+60” level into memory, and return to the opening display.

*This output level of a standard signal generator (SSG) is indicated as SSG’s open circuit.

SECTION 5 PARTS LIST

[FRONT UNIT]

REF NO.	ORDER NO.	DESCRIPTION	
DS1	5080000450	LAMP	SLU2LC1EX5B-TH
ME1	5510000490	METER	ME-41 (KL-293S-11) SX2495
W1	8900009230	CABLE	OPC-908 (P=1 N=10 L=60)
W2	8900009660	CABLE	OPC-964 (P=1 N=10 L=60)
W3	8900009230	CABLE	OPC-908 (P=1 N=10 L=60)
W4	8900009240	CABLE	OPC-909 (P=1 N=10 L=110)
W5	8900009240	CABLE	OPC-909 (P=1 N=10 L=110)
W6	8900009260	CABLE	OPC-911 (P=1 N=16 L=70)
W7	8900009260	CABLE	OPC-911 (P=1 N=16 L=70)
W8	8900009400	CABLE	OPC-926 (P=1 N=24 L=70)
EP1	6910011090	SENSOR UNIT	RMS20-250-201-P
EP2	6450001230	E.OTHER	HLJ0999-01-480
EP3	6450001230	E.OTHER	HLJ0999-01-480
EP4	6910012500	UNIT BOAD	TFD50W40-A

[DIAPLAY BOARD]

REF NO.	ORDER NO.	DESCRIPTION	
IC101	1130002660	S.IC	μPD4030BG-T1
IC102	1130008650	S.IC	MC14071BF-EL
IC401	1140008850	S.IC	HD6433832SD66H
IC411	1130009640	S.IC	BU4051BCFV-E2
IC490	1130009110	S.IC	S-80942ANMP-DD6-T2
IC492	1130003760	S.IC	TC4S81F (TE85R)
IC501	1180001920	S.IC	TA79L08F (TE12L)
IC511	1110002680	S.IC	NJM2902M-T1
IC542	1120002740	S.IC	TK16105MTL
IC821	1110002350	S.IC	BA6161F
IC841	1110004200	S.IC	NJM2360M-TE3
IC861	1180001070	S.IC	TA7805F (TE16L)
IC881	1180001920	S.IC	TA79L08F (TE12L)
IC1401	1120002580	S.IC	M52338FP
IC1521	1110003750	S.IC	M5218AFP 600C
Q321	1590002310	S.TRANSISTOR	DTC114EE TL
Q511	1590002310	S.TRANSISTOR	DTC114EE TL
Q512	1520000460	S.TRANSISTOR	2SB1132 T100 R
Q513	1590002310	S.TRANSISTOR	DTC114EE TL
Q514	1520000460	S.TRANSISTOR	2SB1132 T100 R
Q515	1590002310	S.TRANSISTOR	DTC114EE TL
Q622	1590002310	S.TRANSISTOR	DTC114EE TL
Q623	1590002310	S.TRANSISTOR	DTC114EE TL
Q624	1590002310	S.TRANSISTOR	DTC114EE TL
Q625	1590002310	S.TRANSISTOR	DTC114EE TL
Q801	1530002060	S.TRANSISTOR	2SC4081 T107 R
Q802	1520000650	S.TRANSISTOR	2SB1201-S-TL
Q803	1530003300	S.TRANSISTOR	2SC3647S-TD
Q804	1530003300	S.TRANSISTOR	2SC3647S-TD
Q805	1590002310	S.TRANSISTOR	DTC114EE TL
Q821	1530002060	S.TRANSISTOR	2SC4081 T107 R
Q841	1520000580	S.TRANSISTOR	2SB1124S-TD
Q901	1590002310	S.TRANSISTOR	DTC114EE TL
Q902	1590002310	S.TRANSISTOR	DTC114EE TL
Q903	1590002310	S.TRANSISTOR	DTC114EE TL
Q904	1530002060	S.TRANSISTOR	2SC4081 T107 R
Q905	1520000650	S.TRANSISTOR	2SB1201-S-TL
Q1201	1510000510	S.TRANSISTOR	2SA1576A T106R
Q1211	1510000510	S.TRANSISTOR	2SA1576A T106R
Q1221	1510000510	S.TRANSISTOR	2SA1576A T106R
Q1551	1530002060	S.TRANSISTOR	2SC4081 T107 R
Q1552	1510000510	S.TRANSISTOR	2SA1576A T106R
Q1553	1510000510	S.TRANSISTOR	2SA1576A T106R
Q1554	1530002060	S.TRANSISTOR	2SC4081 T107 R

[DISPALY BOARD]

REF NO.	ORDER NO.	DESCRIPTION	
D421	1750000520	S.DIODE	DAN222TL
D422	1750000520	S.DIODE	DAN222TL
D423	1750000520	S.DIODE	DAN222TL
D424	1750000520	S.DIODE	DAN222TL
D425	1750000520	S.DIODE	DAN222TL
D431	1750000520	S.DIODE	DAN222TL
D432	1750000520	S.DIODE	DAN222TL
D501	1750000190	S.DIODE	1SS322 (TE85R)
D509	1750000190	S.DIODE	1SS322 (TE85R)
D512	1730000410	S.ZENER	RD5.1M-T2B2
D531	1730002260	S.ZENER	MA8030-H (TX)
D701	1750000520	S.DIODE	DAN222TL
D801	1730002260	S.ZENER	MA8030-H (TX)
D821	1750000190	S.DIODE	1SS322 (TE85R)
D822	1730001050	S.ZENER	RD20M-T2B1
D841	1750000560	S.DIODE	RB050L-40 TE-25
D901	1730000410	S.ZENER	RD5.1M-T2B2
D1201	1730002260	S.ZENER	MA8030-H (TX)
D1211	1730002260	S.ZENER	MA8030-H (TX)
D1221	1730002260	S.ZENER	MA8030-H (TX)
X401	6050009870	S.XTAL	CR-567 (9.8304 MHz)
L321	6200003950	S.COIL	HF50ACC 322513-T
L322	6200003950	S.COIL	HF50ACC 322513-T
L323	6200003950	S.COIL	HF50ACC 322513-T
L401	6200003950	S.COIL	HF50ACC 322513-T
L801	6180000990	COIL	LAL 04NA 101K
L802	6190001190	S.COIL	D10F-A814AY-101K=P3
L803	6190001180	S.COIL	BLC13H-D818HN-1107
L821	6200003950	S.COIL	HF50ACC 322513-T
L822	6200009190	S.COIL	NLFC565050T-472K
L823	6200003520	S.COIL	ELJFB 102K-F
L841	6190001190	S.COIL	D10F-A814AY-101K=P3
L842	6180003250	S.COIL	SLF12565T-680M2R0
L843	6190001190	S.COIL	D10F-A814AY-101K=P3
R101	7030003320	S.RESISTOR	ERJ3GEYJ 101 V (100 Ω)
R102	7030003580	S.RESISTOR	ERJ3GEYJ 153 V (15 kΩ)
R103	7030003580	S.RESISTOR	ERJ3GEYJ 153 V (15 kΩ)
R104	7030003640	S.RESISTOR	ERJ3GEYJ 473 V (47 kΩ)
R105	7030003320	S.RESISTOR	ERJ3GEYJ 101 V (100 Ω)
R106	7030003720	S.RESISTOR	ERJ3GEYJ 224 V (220 kΩ)
R107	7030003720	S.RESISTOR	ERJ3GEYJ 224 V (220 kΩ)
R121	7030003680	S.RESISTOR	ERJ3GEYJ 104 V (100 kΩ)
R122	7030003720	S.RESISTOR	ERJ3GEYJ 224 V (220 kΩ)
R123	7030003680	S.RESISTOR	ERJ3GEYJ 104 V (100 kΩ)
R124	7030003800	S.RESISTOR	ERJ3GEYJ 105 V (1 MΩ)
R125	7030003680	S.RESISTOR	ERJ3GEYJ 104 V (100 kΩ)
R126	7030003720	S.RESISTOR	ERJ3GEYJ 224 V (220 kΩ)
R127	7030003680	S.RESISTOR	ERJ3GEYJ 104 V (100 kΩ)
R128	7030003800	S.RESISTOR	ERJ3GEYJ 105 V (1 MΩ)
R201	7030003440	S.RESISTOR	ERJ3GEYJ 102 V (1 kΩ)
R202	7030003440	S.RESISTOR	ERJ3GEYJ 102 V (1 kΩ)
R203	7030003440	S.RESISTOR	ERJ3GEYJ 102 V (1 kΩ)
R204	7030003440	S.RESISTOR	ERJ3GEYJ 102 V (1 kΩ)
R205	7030003440	S.RESISTOR	ERJ3GEYJ 102 V (1 kΩ)
R206	7030003440	S.RESISTOR	ERJ3GEYJ 102 V (1 kΩ)
R207	7030003440	S.RESISTOR	ERJ3GEYJ 102 V (1 kΩ)
R208	7030003440	S.RESISTOR	ERJ3GEYJ 102 V (1 kΩ)
R209	7030003440	S.RESISTOR	ERJ3GEYJ 102 V (1 kΩ)
R210	7030003440	S.RESISTOR	ERJ3GEYJ 102 V (1 kΩ)
R211	7030003440	S.RESISTOR	ERJ3GEYJ 102 V (1 kΩ)
R212	7030003640	S.RESISTOR	ERJ3GEYJ 473 V (47 kΩ)
R213	7030003640	S.RESISTOR	ERJ3GEYJ 473 V (47 kΩ)
R214	7030003640	S.RESISTOR	ERJ3GEYJ 473 V (47 kΩ)
R215	7030003640	S.RESISTOR	ERJ3GEYJ 473 V (47 kΩ)
R221	7030003440	S.RESISTOR	ERJ3GEYJ 102 V (1 kΩ)
R222	7030003440	S.RESISTOR	ERJ3GEYJ 102 V (1 kΩ)
R223	7030003440	S.RESISTOR	ERJ3GEYJ 102 V (1 kΩ)
R224	7030003440	S.RESISTOR	ERJ3GEYJ 102 V (1 kΩ)
R225	7030003440	S.RESISTOR	ERJ3GEYJ 102 V (1 kΩ)
R226	7030003440	S.RESISTOR	ERJ3GEYJ 102 V (1 kΩ)

S.=Surface mount

[DISPLAY BOARD]

REF NO.	ORDER NO.	DESCRIPTION	
R227	7030003440	S.RESISTOR	ERJ3GEYJ 102 V (1 kΩ)
R228	7030003440	S.RESISTOR	ERJ3GEYJ 102 V (1 kΩ)
R229	7030003440	S.RESISTOR	ERJ3GEYJ 102 V (1 kΩ)
R230	7030003440	S.RESISTOR	ERJ3GEYJ 102 V (1 kΩ)
R231	7030003440	S.RESISTOR	ERJ3GEYJ 102 V (1 kΩ)
R232	7030003440	S.RESISTOR	ERJ3GEYJ 102 V (1 kΩ)
R233	7030003440	S.RESISTOR	ERJ3GEYJ 102 V (1 kΩ)
R234	7030003440	S.RESISTOR	ERJ3GEYJ 102 V (1 kΩ)
R235	7030003440	S.RESISTOR	ERJ3GEYJ 102 V (1 kΩ)
R241	7030003440	S.RESISTOR	ERJ3GEYJ 102 V (1 kΩ)
R242	7030003440	S.RESISTOR	ERJ3GEYJ 102 V (1 kΩ)
R243	7030003440	S.RESISTOR	ERJ3GEYJ 102 V (1 kΩ)
R244	7030003440	S.RESISTOR	ERJ3GEYJ 102 V (1 kΩ)
R245	7030003440	S.RESISTOR	ERJ3GEYJ 102 V (1 kΩ)
R246	7030003440	S.RESISTOR	ERJ3GEYJ 102 V (1 kΩ)
R247	7030003440	S.RESISTOR	ERJ3GEYJ 102 V (1 kΩ)
R248	7030003440	S.RESISTOR	ERJ3GEYJ 102 V (1 kΩ)
R249	7030003440	S.RESISTOR	ERJ3GEYJ 102 V (1 kΩ)
R250	7030003440	S.RESISTOR	ERJ3GEYJ 102 V (1 kΩ)
R251	7030003440	S.RESISTOR	ERJ3GEYJ 102 V (1 kΩ)
R252	7030003440	S.RESISTOR	ERJ3GEYJ 102 V (1 kΩ)
R253	7030003440	S.RESISTOR	ERJ3GEYJ 102 V (1 kΩ)
R254	7030003440	S.RESISTOR	ERJ3GEYJ 102 V (1 kΩ)
R255	7030003440	S.RESISTOR	ERJ3GEYJ 102 V (1 kΩ)
R256	7030003440	S.RESISTOR	ERJ3GEYJ 102 V (1 kΩ)
R301	7030003440	S.RESISTOR	ERJ3GEYJ 102 V (1 kΩ)
R312	7030003440	S.RESISTOR	ERJ3GEYJ 102 V (1 kΩ)
R313	7030003440	S.RESISTOR	ERJ3GEYJ 102 V (1 kΩ)
R315	7030003280	S.RESISTOR	ERJ3GEYJ 470 V (47 Ω)
R316	7030003280	S.RESISTOR	ERJ3GEYJ 470 V (47 Ω)
R317	7030003280	S.RESISTOR	ERJ3GEYJ 470 V (47 Ω)
R318	7030003440	S.RESISTOR	ERJ3GEYJ 102 V (1 kΩ)
R319	7030003440	S.RESISTOR	ERJ3GEYJ 102 V (1 kΩ)
R321	7030003560	S.RESISTOR	ERJ3GEYJ 103 V (10 kΩ)
R401	7030003800	S.RESISTOR	ERJ3GEYJ 105 V (1 MΩ)
R402	7030003440	S.RESISTOR	ERJ3GEYJ 102 V (1 kΩ)
R403	7030003680	S.RESISTOR	ERJ3GEYJ 104 V (100 kΩ)
R404	7030003640	S.RESISTOR	ERJ3GEYJ 473 V (47 kΩ)
R405	7030003640	S.RESISTOR	ERJ3GEYJ 473 V (47 kΩ)
R406	7030003640	S.RESISTOR	ERJ3GEYJ 473 V (47 kΩ)
R407	7030003640	S.RESISTOR	ERJ3GEYJ 473 V (47 kΩ)
R408	7030003640	S.RESISTOR	ERJ3GEYJ 473 V (47 kΩ)
R409	7030003640	S.RESISTOR	ERJ3GEYJ 473 V (47 kΩ)
R410	7030003640	S.RESISTOR	ERJ3GEYJ 473 V (47 kΩ)
R411	7030003640	S.RESISTOR	ERJ3GEYJ 473 V (47 kΩ)
R412	7030003640	S.RESISTOR	ERJ3GEYJ 473 V (47 kΩ)
R413	7030003640	S.RESISTOR	ERJ3GEYJ 473 V (47 kΩ)
R414	7030003640	S.RESISTOR	ERJ3GEYJ 473 V (47 kΩ)
R415	7030003640	S.RESISTOR	ERJ3GEYJ 473 V (47 kΩ)
R416	7030003640	S.RESISTOR	ERJ3GEYJ 473 V (47 kΩ)
R421	7030003440	S.RESISTOR	ERJ3GEYJ 102 V (1 kΩ)
R424	7030003440	S.RESISTOR	ERJ3GEYJ 102 V (1 kΩ)
R431	7030003480	S.RESISTOR	ERJ3GEYJ 222 V (2.2 kΩ)
R432	7030003640	S.RESISTOR	ERJ3GEYJ 473 V (47 kΩ)
R441	7030003560	S.RESISTOR	ERJ3GEYJ 103 V (10 kΩ)
R442	7030003640	S.RESISTOR	ERJ3GEYJ 473 V (47 kΩ)
R443	7030003640	S.RESISTOR	ERJ3GEYJ 473 V (47 kΩ)
R444	7030003560	S.RESISTOR	ERJ3GEYJ 103 V (10 kΩ)
R445	7030003560	S.RESISTOR	ERJ3GEYJ 103 V (10 kΩ)
R446	7030003560	S.RESISTOR	ERJ3GEYJ 103 V (10 kΩ)
R447	7030003320	S.RESISTOR	ERJ3GEYJ 101 V (100 Ω)
R490	7030003630	S.RESISTOR	ERJ3GEYJ 393 V (39 kΩ)
R491	7030003640	S.RESISTOR	ERJ3GEYJ 473 V (47 kΩ)
R492	7030003560	S.RESISTOR	ERJ3GEYJ 103 V (10 kΩ)
R493	7030003440	S.RESISTOR	ERJ3GEYJ 102 V (1 kΩ)
R494	7030003680	S.RESISTOR	ERJ3GEYJ 104 V (100 kΩ)
R501	7030003440	S.RESISTOR	ERJ3GEYJ 102 V (1 kΩ)
R502	7030003580	S.RESISTOR	ERJ3GEYJ 153 V (15 kΩ)
R503	7030003440	S.RESISTOR	ERJ3GEYJ 102 V (1 kΩ)
R511	7030003560	S.RESISTOR	ERJ3GEYJ 103 V (10 kΩ)
R512	7030003560	S.RESISTOR	ERJ3GEYJ 103 V (10 kΩ)
R513	7030003450	S.RESISTOR	ERJ3GEYJ 122 V (1.2 kΩ)
R514	7030003430	S.RESISTOR	ERJ3GEYJ 821 V (820 Ω)
R515	7030003560	S.RESISTOR	ERJ3GEYJ 103 V (10 kΩ)
R516	7030003590	S.RESISTOR	ERJ3GEYJ 183 V (18 kΩ)
R518	7030003720	S.RESISTOR	ERJ3GEYJ 224 V (220 kΩ)
R519	7030003720	S.RESISTOR	ERJ3GEYJ 224 V (220 kΩ)
R520	7030003720	S.RESISTOR	ERJ3GEYJ 224 V (220 kΩ)
R521	7030003470	S.RESISTOR	ERJ3GEYJ 182 V (1.8 kΩ)
R531	7030003470	S.RESISTOR	ERJ3GEYJ 182 V (1.8 kΩ)
R532	7030003630	S.RESISTOR	ERJ3GEYJ 393 V (39 kΩ)
R533	7030003560	S.RESISTOR	ERJ3GEYJ 103 V (10 kΩ)

[DISPLAY BOARD]

REF NO.	ORDER NO.	DESCRIPTION	
R541	7030003560	S.RESISTOR	ERJ3GEYJ 103 V (10 kΩ)
R544	7030003200	S.RESISTOR	ERJ3GEYJ 100 V (10 Ω)
R601	7030003640	S.RESISTOR	ERJ3GEYJ 473 V (47 kΩ)
R602	7030003640	S.RESISTOR	ERJ3GEYJ 473 V (47 kΩ)
R621	7030003480	S.RESISTOR	ERJ3GEYJ 222 V (2.2 kΩ)
R622	7030003540	S.RESISTOR	ERJ3GEYJ 682 V (6.8 kΩ)
R623	7030003480	S.RESISTOR	ERJ3GEYJ 222 V (2.2 kΩ)
R624	7030003520	S.RESISTOR	ERJ3GEYJ 472 V (4.7 kΩ)
R625	7030003580	S.RESISTOR	ERJ3GEYJ 153 V (15 kΩ)
R626	7030009950	S.RESISTOR	ERJ8GEYJ 681V (680 Ω)
R627	7030009950	S.RESISTOR	ERJ8GEYJ 681V (680 Ω)
R628	7030009950	S.RESISTOR	ERJ8GEYJ 681V (680 Ω)
R629	7030009950	S.RESISTOR	ERJ8GEYJ 681V (680 Ω)
R701	7210002890	VARIABLE	RV-308 (RK1612210 10KB/10KB)
R702	7210002890	VARIABLE	RV-308 (RK1612210 10KB/10KB)
R703	7030003640	S.RESISTOR	ERJ3GEYJ 473 V (47 kΩ)
R704	7030003640	S.RESISTOR	ERJ3GEYJ 473 V (47 kΩ)
R705	7030003640	S.RESISTOR	ERJ3GEYJ 473 V (47 kΩ)
R706	7030003640	S.RESISTOR	ERJ3GEYJ 473 V (47 kΩ)
R709	7030003560	S.RESISTOR	ERJ3GEYJ 103 V (10 kΩ)
R711	7030003640	S.RESISTOR	ERJ3GEYJ 473 V (47 kΩ)
R712	7210002630	VARIABLE	EVU-FLAE02 B14 (10KB)
R713	7030003640	S.RESISTOR	ERJ3GEYJ 473 V (47 kΩ)
R714	7210002630	VARIABLE	EVU-FLAE02 B14 (10KB)
R715	7030003640	S.RESISTOR	ERJ3GEYJ 473 V (47 kΩ)
R716	7210002630	VARIABLE	EVU-FLAE02 B14 (10KB)
R717	7030003640	S.RESISTOR	ERJ3GEYJ 473 V (47 kΩ)
R718	7210002630	VARIABLE	EVU-FLAE02 B14 (10KB)
R719	7030003640	S.RESISTOR	ERJ3GEYJ 473 V (47 kΩ)
R720	7210002630	VARIABLE	EVU-FLAE02 B14 (10KB)
R801	7030003620	S.RESISTOR	ERJ3GEYJ 333 V (33 kΩ)
R802	7030003620	S.RESISTOR	ERJ3GEYJ 333 V (33 kΩ)
R803	7030000300	S.RESISTOR	MCR10EZJH 220 Ω (221)
R804	7030003500	S.RESISTOR	ERJ3GEYJ 332 V (3.3 kΩ)
R805	7030003500	S.RESISTOR	ERJ3GEYJ 332 V (3.3 kΩ)
R806	7030003640	S.RESISTOR	ERJ3GEYJ 473 V (47 kΩ)
R807	7030008380	S.RESISTOR	ERJ1WYJ270U (27 Ω)
R808	7030008380	S.RESISTOR	ERJ1WYJ270U (27 Ω)
R821	7030003450	S.RESISTOR	ERJ3GEYJ 122 V (1.2 kΩ)
R824	7030003560	S.RESISTOR	ERJ3GEYJ 103 V (10 kΩ)
R841	7030009740	S.RESISTOR	ERJ12RQJ0R33U (0.33 Ω)
R842	7030009740	S.RESISTOR	ERJ12RQJ0R33U (0.33 Ω)
R845	7030006580	S.RESISTOR	RR0816P-122-D (1.2 kΩ)
R846	7030008070	S.RESISTOR	RR0816P-273-D (27 kΩ)
R847	7030008070	S.RESISTOR	RR0816P-273-D (27 kΩ)
R848	7030006260	S.RESISTOR	ERJ12YJ471U (470 Ω)
R849	7030006260	S.RESISTOR	ERJ12YJ471U (470 Ω)
R850	7030003380	S.RESISTOR	ERJ3GEYJ 331 V (330 Ω)
R861	7030007120	S.RESISTOR	ERJ1WYJ120U (12 Ω)
R862	7030007120	S.RESISTOR	ERJ1WYJ120U (12 Ω)
R863	7030007120	S.RESISTOR	ERJ1WYJ120U (12 Ω)
R881	7030006140	S.RESISTOR	ERJ1WYJ560U (56 Ω)
R882	7030006140	S.RESISTOR	ERJ1WYJ560U (56 Ω)
R904	7030003520	S.RESISTOR	ERJ3GEYJ 472 V (4.7 kΩ)
R905	7030003540	S.RESISTOR	ERJ3GEYJ 682 V (6.8 kΩ)
R906	7030003580	S.RESISTOR	ERJ3GEYJ 153 V (15 kΩ)
R907	7030003580	S.RESISTOR	ERJ3GEYJ 153 V (15 kΩ)
R908	7030003520	S.RESISTOR	ERJ3GEYJ 472 V (4.7 kΩ)
R909	7030003400	S.RESISTOR	ERJ3GEYJ 471 V (470 Ω)
R910	7030000350	S.RESISTOR	MCR10EZJH 560 Ω (561)
R912	7030009950	S.RESISTOR	ERJ8GEYJ 681V (680 Ω)
R914	7030009950	S.RESISTOR	ERJ8GEYJ 681V (680 Ω)
R915	7030003560	S.RESISTOR	ERJ3GEYJ 103 V (10 kΩ)
R916	7030003480	S.RESISTOR	ERJ3GEYJ 222 V (2.2 kΩ)
R917	7030003520	S.RESISTOR	ERJ3GEYJ 472 V (4.7 kΩ)
R1101	7030003640	S.RESISTOR	ERJ3GEYJ 473 V (47 kΩ)
R1103	7030003560	S.RESISTOR	ERJ3GEYJ 103 V (10 kΩ)
R1104	7030003600	S.RESISTOR	ERJ3GEYJ 223 V (22 kΩ)
R1106	7030003590	S.RESISTOR	ERJ3GEYJ 183 V (18 kΩ)
R1107	7030003570	S.RESISTOR	ERJ3GEYJ 123 V (12 kΩ)
R1109	7030003670	S.RESISTOR	ERJ3GEYJ 823 V (82 kΩ)
R1110	7030003600	S.RESISTOR	ERJ3GEYJ 223 V (22 kΩ)
R1112	7030003620	S.RESISTOR	ERJ3GEYJ 333 V (33 kΩ)
R1113	7030003610	S.RESISTOR	ERJ3GEYJ 273 V (27 kΩ)
R1121	7030003610	S.RESISTOR	ERJ3GEYJ 273 V (27 kΩ)
R1122	7030003520	S.RESISTOR	ERJ3GEYJ 472 V (4.7 kΩ)
R1127	7030003670	S.RESISTOR	ERJ3GEYJ 823 V (82 kΩ)
R1128	7030003600	S.RESISTOR	ERJ3GEYJ 223 V (22 kΩ)
R1201	7030003340	S.RESISTOR	ERJ3GEYJ 151 V (150 Ω)
R1202	7030003450	S.RESISTOR	ERJ3GEYJ 122 V (1.2 kΩ)
R1203	7030003490	S.RESISTOR	ERJ3GEYJ 272 V (2.7 kΩ)
R1211	7030003340	S.RESISTOR	ERJ3GEYJ 151 V (150 Ω)

S.=Surface mount

[DISPLAY BOARD]

REF NO.	ORDER NO.	DESCRIPTION	
R1212	7030003450	S.RESISTOR	ERJ3GEYJ 122 V (1.2 kΩ)
R1213	7030003490	S.RESISTOR	ERJ3GEYJ 272 V (2.7 kΩ)
R1221	7030003340	S.RESISTOR	ERJ3GEYJ 151 V (150 Ω)
R1222	7030003450	S.RESISTOR	ERJ3GEYJ 122 V (1.2 kΩ)
R1223	7030003490	S.RESISTOR	ERJ3GEYJ 272 V (2.7 kΩ)
R1526	7030003320	S.RESISTOR	ERJ3GEYJ 101 V (100 Ω)
R1527	7030003320	S.RESISTOR	ERJ3GEYJ 101 V (100 Ω)
R1541	7030003560	S.RESISTOR	ERJ3GEYJ 103 V (10 kΩ)
R1542	7030003600	S.RESISTOR	ERJ3GEYJ 223 V (22 kΩ)
R1543	7030003600	S.RESISTOR	ERJ3GEYJ 223 V (22 kΩ)
R1544	7030003480	S.RESISTOR	ERJ3GEYJ 222 V (2.2 kΩ)
R1545	7030003480	S.RESISTOR	ERJ3GEYJ 222 V (2.2 kΩ)
R1551	7030003320	S.RESISTOR	ERJ3GEYJ 101 V (100 Ω)
R1552	7030003320	S.RESISTOR	ERJ3GEYJ 101 V (100 Ω)
R1553	7030003720	S.RESISTOR	ERJ3GEYJ 224 V (220 kΩ)
R1554	7030003720	S.RESISTOR	ERJ3GEYJ 224 V (220 kΩ)
R1555	7030003600	S.RESISTOR	ERJ3GEYJ 223 V (22 kΩ)
R1556	7030003600	S.RESISTOR	ERJ3GEYJ 223 V (22 kΩ)
R1560	7030003530	S.RESISTOR	ERJ3GEYJ 562 V (5.6 kΩ)
R1561	7030003610	S.RESISTOR	ERJ3GEYJ 273 V (27 kΩ)
C101	4030011600	S.CERAMIC	C1608 JB 1C 104KT-N
C102	4030006860	S.CERAMIC	C1608 JB 1H 102K-T-A
C103	4030006860	S.CERAMIC	C1608 JB 1H 102K-T-A
C104	4030006860	S.CERAMIC	C1608 JB 1H 102K-T-A
C105	4030011600	S.CERAMIC	C1608 JB 1C 104KT-N
C121	4030006860	S.CERAMIC	C1608 JB 1H 102K-T-A
C122	4030006860	S.CERAMIC	C1608 JB 1H 102K-T-A
C241	4030011600	S.CERAMIC	C1608 JB 1C 104KT-N
C242	4030011600	S.CERAMIC	C1608 JB 1C 104KT-N
C331	4030006850	S.CERAMIC	C1608 JB 1H 471K-T-A
C332	4030006880	S.CERAMIC	C1608 JB 1H 472K-T-A
C401	4030007020	S.CERAMIC	C1608 CH 1H 120J-T-A
C402	4030007020	S.CERAMIC	C1608 CH 1H 120J-T-A
C403	4030011600	S.CERAMIC	C1608 JB 1C 104KT-N
C404	4030011600	S.CERAMIC	C1608 JB 1C 104KT-N
C405	4030011600	S.CERAMIC	C1608 JB 1C 104KT-N
C406	4510006650	S.ELECTROLYTIC	ECEV1EA100SR
C411	4030011600	S.CERAMIC	C1608 JB 1C 104KT-N
C431	4030011600	S.CERAMIC	C1608 JB 1C 104KT-N
C490	4030011600	S.CERAMIC	C1608 JB 1C 104KT-N
C491	4030007020	S.CERAMIC	C1608 CH 1H 120J-T-A
C492	4030006880	S.CERAMIC	C1608 JB 1H 472K-T-A
C501	4510006650	S.ELECTROLYTIC	ECEV1EA100SR
C502	4030011600	S.CERAMIC	C1608 JB 1C 104KT-N
C503	4030011600	S.CERAMIC	C1608 JB 1C 104KT-N
C504	4510005310	S.ELECTROLYTIC	ECEV1CA220SR
C513	4030011600	S.CERAMIC	C1608 JB 1C 104KT-N
C531	4030006880	S.CERAMIC	C1608 JB 1H 472K-T-A
C542	4030011600	S.CERAMIC	C1608 JB 1C 104KT-N
C545	4510006650	S.ELECTROLYTIC	ECEV1EA100SR
C601	4030006880	S.CERAMIC	C1608 JB 1H 472K-T-A
C602	4030006880	S.CERAMIC	C1608 JB 1H 472K-T-A
C603	4030006860	S.CERAMIC	C1608 JB 1H 102K-T-A
C604	4030006860	S.CERAMIC	C1608 JB 1H 102K-T-A
C605	4030006860	S.CERAMIC	C1608 JB 1H 102K-T-A
C606	4030006860	S.CERAMIC	C1608 JB 1H 102K-T-A
C621	4030011600	S.CERAMIC	C1608 JB 1C 104KT-N
C701	4030011600	S.CERAMIC	C1608 JB 1C 104KT-N
C702	4030011600	S.CERAMIC	C1608 JB 1C 104KT-N
C703	4030006880	S.CERAMIC	C1608 JB 1H 472K-T-A
C704	4030006880	S.CERAMIC	C1608 JB 1H 472K-T-A
C711	4030006880	S.CERAMIC	C1608 JB 1H 472K-T-A
C712	4030006880	S.CERAMIC	C1608 JB 1H 472K-T-A
C713	4030006880	S.CERAMIC	C1608 JB 1H 472K-T-A
C714	4030006880	S.CERAMIC	C1608 JB 1H 472K-T-A
C715	4030006880	S.CERAMIC	C1608 JB 1H 472K-T-A
C801	4510006650	S.ELECTROLYTIC	ECEV1EA100SR
C802	4510006650	S.ELECTROLYTIC	ECEV1EA100SR
C803	4510006230	S.ELECTROLYTIC	ECEV1EA470UP
C804	4340000170	S.MYLAR	MMX-E 2A 473J
C805	4030016880	S.CERAMIC	C4520 CH 3F 150KT-A
C821	4030011600	S.CERAMIC	C1608 JB 1C 104KT-N
C822	4510006230	S.ELECTROLYTIC	ECEV1EA470UP
C823	4030006880	S.CERAMIC	C1608 JB 1H 472K-T-A
C824	4030006880	S.CERAMIC	C1608 JB 1H 472K-T-A
C825	4030006880	S.CERAMIC	C1608 JB 1H 472K-T-A
C826	4510005360	S.ELECTROLYTIC	ECEV1HA4R7SR
C827	4510005360	S.ELECTROLYTIC	ECEV1HA4R7SR
C828	4510006650	S.ELECTROLYTIC	ECEV1EA100SR
C829	4510005360	S.ELECTROLYTIC	ECEV1HA4R7SR

[DISPLAY BOARD]

REF NO.	ORDER NO.	DESCRIPTION	
C830	4510006650	S.ELECTROLYTIC	ECEV1EA100SR
C841	4510006240	S.ELECTROLYTIC	ECEV1CA221P
C842	4030011600	S.CERAMIC	C1608 JB 1C 104KT-N
C843	4030010760	S.CERAMIC	C1608 CH 1H 331J-T-A
C844	4510006240	S.ELECTROLYTIC	ECEV1CA221P
C845	4030011600	S.CERAMIC	C1608 JB 1C 104KT-N
C846	4510006240	S.ELECTROLYTIC	ECEV1CA221P
C847	4510006240	S.ELECTROLYTIC	ECEV1CA221P
C848	4030011600	S.CERAMIC	C1608 JB 1C 104KT-N
C849	4510006240	S.ELECTROLYTIC	ECEV1CA221P
C850	4510006240	S.ELECTROLYTIC	ECEV1CA221P
C861	4510006650	S.ELECTROLYTIC	ECEV1EA100SR
C862	4030011600	S.CERAMIC	C1608 JB 1C 104KT-N
C863	4030011600	S.CERAMIC	C1608 JB 1C 104KT-N
C864	4510005310	S.ELECTROLYTIC	ECEV1CA220SR
C881	4510006650	S.ELECTROLYTIC	ECEV1EA100SR
C882	4030011600	S.CERAMIC	C1608 JB 1C 104KT-N
C883	4030011600	S.CERAMIC	C1608 JB 1C 104KT-N
C884	4510005310	S.ELECTROLYTIC	ECEV1CA220SR
C901	4510005360	S.ELECTROLYTIC	ECEV1HA4R7SR
C921	4030006880	S.CERAMIC	C1608 JB 1H 472K-T-A
C922	4030006880	S.CERAMIC	C1608 JB 1H 472K-T-A
C1101	4030011600	S.CERAMIC	C1608 JB 1C 104KT-N
C1102	4030011600	S.CERAMIC	C1608 JB 1C 104KT-N
C1103	4030011600	S.CERAMIC	C1608 JB 1C 104KT-N
C1104	4030011600	S.CERAMIC	C1608 JB 1C 104KT-N
C1105	4030011600	S.CERAMIC	C1608 JB 1C 104KT-N
C1106	4030011600	S.CERAMIC	C1608 JB 1C 104KT-N
C1107	4030011600	S.CERAMIC	C1608 JB 1C 104KT-N
C1108	4030011600	S.CERAMIC	C1608 JB 1C 104KT-N
C1109	4030011600	S.CERAMIC	C1608 JB 1C 104KT-N
C1110	4030011600	S.CERAMIC	C1608 JB 1C 104KT-N
C1201	4030011600	S.CERAMIC	C1608 JB 1C 104KT-N
C1211	4030011600	S.CERAMIC	C1608 JB 1C 104KT-N
C1221	4030011600	S.CERAMIC	C1608 JB 1C 104KT-N
C1307	4030011600	S.CERAMIC	C1608 JB 1C 104KT-N
C1308	4030011600	S.CERAMIC	C1608 JB 1C 104KT-N
C1309	4030011600	S.CERAMIC	C1608 JB 1C 104KT-N
C1401	4030011600	S.CERAMIC	C1608 JB 1C 104KT-N
C1402	4030011600	S.CERAMIC	C1608 JB 1C 104KT-N
C1403	4030011600	S.CERAMIC	C1608 JB 1C 104KT-N
C1404	4030011600	S.CERAMIC	C1608 JB 1C 104KT-N
C1405	4030011600	S.CERAMIC	C1608 JB 1C 104KT-N
C1406	4030011600	S.CERAMIC	C1608 JB 1C 104KT-N
C1407	4030011600	S.CERAMIC	C1608 JB 1C 104KT-N
C1408	4030011600	S.CERAMIC	C1608 JB 1C 104KT-N
C1409	4030011600	S.CERAMIC	C1608 JB 1C 104KT-N
C1521	4030011600	S.CERAMIC	C1608 JB 1C 104KT-N
C1522	4030011600	S.CERAMIC	C1608 JB 1C 104KT-N
C1541	4510006650	S.ELECTROLYTIC	ECEV1EA100SR
C1551	4510006650	S.ELECTROLYTIC	ECEV1EA100SR
C1552	4510006650	S.ELECTROLYTIC	ECEV1EA100SR
C1553	4510006650	S.ELECTROLYTIC	ECEV1EA100SR
C1554	4510006650	S.ELECTROLYTIC	ECEV1EA100SR
C1555	4030011600	S.CERAMIC	C1608 JB 1C 104KT-N
C1556	4030011600	S.CERAMIC	C1608 JB 1C 104KT-N
J101	6510003400	CONNECTOR	B04B-EH-S
J120	6510022620	S.CONNECTOR	10FMN-BMTTR-A-TBT
J201	6510022610	S.CONNECTOR	16FMN-BMTTR-A-TBT
J221	6510022610	S.CONNECTOR	16FMN-BMTTR-A-TBT
J241	6510022580	S.CONNECTOR	24FMN-BMTTR-A-TBT
J301	6510022580	S.CONNECTOR	24FMN-BMTTR-A-TBT
J321	6510022580	S.CONNECTOR	24FMN-BMTTR-A-TBT
J322	6510022620	S.CONNECTOR	10FMN-BMTTR-A-TBT
J451	6510003400	CONNECTOR	B04B-EH-S
J452	6510003390	CONNECTOR	B03B-EH-S
J531	6510022580	S.CONNECTOR	24FMN-BMTTR-A-TBT
J601	6510022620	S.CONNECTOR	10FMN-BMTTR-A-TBT
J801	6510018960	S.CONNECTOR	B2B-PH-SM3-TB
J802	6510018960	S.CONNECTOR	B2B-PH-SM3-TB
J921	6510022620	S.CONNECTOR	10FMN-BMTTR-A-TBT
J941	6510022620	S.CONNECTOR	10FMN-BMTTR-A-TBT
DS621	5040002110	S.LED	CL-200HR-C-TU
DS622	5040002080	S.LED	CL-200YG-C-TU
DS623	5040002080	S.LED	CL-200YG-C-TU
DS624	5040002080	S.LED	CL-200YG-C-TU
DS625	5040002080	S.LED	CL-200YG-C-TU
DS901	5040002830	S.LED	NSCW100
DS904	5040002830	S.LED	NSCW100

S.=Surface mount

[DISPLAY BOARD]

REF NO.	ORDER NO.	DESCRIPTION	
S621	2260001890	S.SWITCH	SKQDPA
S622	2260001890	S.SWITCH	SKQDPA
S623	2260001890	S.SWITCH	SKQDPA
S624	2260001890	S.SWITCH	SKQDPA
S625	2260001890	S.SWITCH	SKQDPA
S626	2260001890	S.SWITCH	SKQDPA
W502	7030003860	S.JUMPER	ERJ3GE JPW V
W504	7030003860	S.JUMPER	ERJ3GE JPW V
W506	7030003860	S.JUMPER	ERJ3GE JPW V
W512	7030003860	S.JUMPER	ERJ3GE JPW V
W801	7030008240	S.JUMPER	ERJ12YJ0R00U
EP1	0910054521	PCB	B 5757A

[PHONE BOARD]

REF NO.	ORDER NO.	DESCRIPTION	
L1	6200003950	S.COIL	HF50ACC 322513-T
L2	6200003950	S.COIL	HF50ACC 322513-T
R1	7030006240	S.RESISTOR	ERJ12YJ181U (180 Ω)
R2	7030006240	S.RESISTOR	ERJ12YJ181U (180 Ω)
C1	4030006880	S.CERAMIC	C1608 JB 1H 472K-T-A
C2	4030006880	S.CERAMIC	C1608 JB 1H 472K-T-A
C3	4030006880	S.CERAMIC	C1608 JB 1H 472K-T-A
J1	6510022620	S.CONNECTOR	10FMN-BMTTR-A-TBT
J2	6450001980	CONNECTOR	HLJ5815-01-030
EP1	0910052282	PCB	B 5331B

[MODE BOARD]

REF NO.	ORDER NO.	DESCRIPTION	
R1	7030003540	S.RESISTOR	ERJ3GEYJ 682 V (6.8 kΩ)
R2	7030003480	S.RESISTOR	ERJ3GEYJ 222 V (2.2 kΩ)
R3	7030003520	S.RESISTOR	ERJ3GEYJ 472 V (4.7 kΩ)
R4	7030003580	S.RESISTOR	ERJ3GEYJ 153 V (15 kΩ)
R5	7030003540	S.RESISTOR	ERJ3GEYJ 682 V (6.8 kΩ)
R6	7030003480	S.RESISTOR	ERJ3GEYJ 222 V (2.2 kΩ)
R7	7030003520	S.RESISTOR	ERJ3GEYJ 472 V (4.7 kΩ)
C1	4030011600	S.CERAMIC	C1608 JB 1C 104KT-N
C2	4030011600	S.CERAMIC	C1608 JB 1C 104KT-N
J1	6510022610	S.CONNECTOR	16FMN-BMTTR-A-TBT
S1	2260001890	S.SWITCH	SKQDPA
S2	2260001890	S.SWITCH	SKQDPA
S3	2260001890	S.SWITCH	SKQDPA
S4	2260001890	S.SWITCH	SKQDPA
S5	2260001890	S.SWITCH	SKQDPA
S6	2260001890	S.SWITCH	SKQDPA
S7	2260001890	S.SWITCH	SKQDPA
S8	2260001890	S.SWITCH	SKQDPA
S9	2260001890	S.SWITCH	SKQDPA
S10	2260001890	S.SWITCH	SKQDPA
S11	2260001890	S.SWITCH	SKQDPA
S12	2260001890	S.SWITCH	SKQDPA
S13	2260001890	S.SWITCH	SKQDPA
S14	2260001890	S.SWITCH	SKQDPA
S15	2260001890	S.SWITCH	SKQDPA
S16	2260001890	S.SWITCH	SKQDPA
S17	2260001890	S.SWITCH	SKQDPA
S18	2260001890	S.SWITCH	SKQDPA
EP1	0910052293	PCB	B 5404C

[MIC BOARD]

REF NO.	ORDER NO.	DESCRIPTION	
L1	6200003260	S.COIL	NL 322522T-101J
L3	6200003260	S.COIL	NL 322522T-101J
L4	6200003260	S.COIL	NL 322522T-101J
L6	6200003950	S.COIL	HF50ACC 322513-T
C2	4030006880	S.CERAMIC	C1608 JB 1H 472K-T-A
C3	4030006880	S.CERAMIC	C1608 JB 1H 472K-T-A
C4	4030006880	S.CERAMIC	C1608 JB 1H 472K-T-A
C5	4030006880	S.CERAMIC	C1608 JB 1H 472K-T-A
C6	4030006880	S.CERAMIC	C1608 JB 1H 472K-T-A
C7	4030007130	S.CERAMIC	C1608 CH 1H 101J-T-A
J1	6510000190	CONNECTOR	FM214-8SS (P)
J2	6510022620	S.CONNECTOR	10FMN-BMTTR-A-TBT
EP1	0910052323	PCB	B 5407C

[PBT BOARD]

REF NO.	ORDER NO.	DESCRIPTION	
R1	7210002970	VARIABLE	RV-314 (RK0972210 10KB/10KB)
R3	7030003640	S.RESISTOR	ERJ3GEYJ 473 V (47 kΩ)
R4	7030003640	S.RESISTOR	ERJ3GEYJ 473 V (47 kΩ)
C1	4030006880	S.CERAMIC	C1608 JB 1H 472K-T-A
C2	4030006880	S.CERAMIC	C1608 JB 1H 472K-T-A
J1	6510022620	S.CONNECTOR	10FMN-BMTTR-A-TBT
S1	2250000410	ENCODER	TP90D96E20-30F-2178-1
EP1	0910051852	PCB	B 5330B

[RIT BOARD]

REF NO.	ORDER NO.	DESCRIPTION	
J1	6510022620	S.CONNECTOR	10FMN-BMTTR-A-TBT
S1	2250000340	ENCODER	EVQ-VCJF0324B
EP1	0910052301	PCB	B 5405A

S.=Surface mount

[TEN-KEY BOARD]

REF NO.	ORDER NO.	DESCRIPTION	
Q1	1590002310	S.TRANSISTOR	DTC114EE TL
Q2	1590002310	S.TRANSISTOR	DTC114EE TL
Q3	1590002310	S.TRANSISTOR	DTC114EE TL
Q4	1590002310	S.TRANSISTOR	DTC114EE TL
Q5	1590002310	S.TRANSISTOR	DTC114EE TL
R1	7030003540	S.RESISTOR	ERJ3GEYJ 682 V (6.8 kΩ)
R2	7030003480	S.RESISTOR	ERJ3GEYJ 222 V (2.2 kΩ)
R3	7030003520	S.RESISTOR	ERJ3GEYJ 472 V (4.7 kΩ)
R4	7030003580	S.RESISTOR	ERJ3GEYJ 153 V (15 kΩ)
R5	7030003540	S.RESISTOR	ERJ3GEYJ 682 V (6.8 kΩ)
R6	7030003480	S.RESISTOR	ERJ3GEYJ 222 V (2.2 kΩ)
R7	7030003520	S.RESISTOR	ERJ3GEYJ 472 V (4.7 kΩ)
R8	7030003530	S.RESISTOR	ERJ3GEYJ 562 V (5.6 kΩ)
R9	7030003530	S.RESISTOR	ERJ3GEYJ 562 V (5.6 kΩ)
R10	7030003420	S.RESISTOR	ERJ3GEYJ 681 V (680 Ω)
R11	7030003440	S.RESISTOR	ERJ3GEYJ 102 V (1 kΩ)
R12	7030003440	S.RESISTOR	ERJ3GEYJ 102 V (1 kΩ)
C1	4030011600	S.CERAMIC	C1608 JB 1C 104KT-N
C2	4030011600	S.CERAMIC	C1608 JB 1C 104KT-N
J1	6510022610	S.CONNECTOR	16FMN-BMTTR-A-TBT
J2	6510022580	S.CONNECTOR	24FMN-BMTTR-A-TBT
DS1	5040002110	S.LED	CL-200HR-C-TU
DS2	5040002110	S.LED	CL-200HR-C-TU
DS3	5040002220	S.LED	CL-220YG-C-TU
DS4	5040002220	S.LED	CL-220YG-C-TU
DS5	5040002220	S.LED	CL-220YG-C-TU
S1	2260001890	S.SWITCH	SKQDPA
S2	2260001890	S.SWITCH	SKQDPA
S3	2260001890	S.SWITCH	SKQDPA
S4	2260001890	S.SWITCH	SKQDPA
S5	2260001890	S.SWITCH	SKQDPA
S6	2260001890	S.SWITCH	SKQDPA
S7	2260001890	S.SWITCH	SKQDPA
S8	2260001890	S.SWITCH	SKQDPA
S9	2260001890	S.SWITCH	SKQDPA
S10	2260001890	S.SWITCH	SKQDPA
S11	2260001890	S.SWITCH	SKQDPA
S12	2260001890	S.SWITCH	SKQDPA
S13	2260001890	S.SWITCH	SKQDPA
S14	2260001890	S.SWITCH	SKQDPA
S15	2260001890	S.SWITCH	SKQDPA
S16	2260001890	S.SWITCH	SKQDPA
S17	2260001890	S.SWITCH	SKQDPA
S18	2260001890	S.SWITCH	SKQDPA
S19	2260001890	S.SWITCH	SKQDPA
S20	2260001890	S.SWITCH	SKQDPA
S21	2260001890	S.SWITCH	SKQDPA
S22	2260001890	S.SWITCH	SKQDPA
S23	2260001890	S.SWITCH	SKQDPA
S24	2260001890	S.SWITCH	SKQDPA
S25	2260001890	S.SWITCH	SKQDPA
S26	2260001890	S.SWITCH	SKQDPA
S27	2260001890	S.SWITCH	SKQDPA
S28	2260001890	S.SWITCH	SKQDPA
S29	2260001890	S.SWITCH	SKQDPA
S30	2260001890	S.SWITCH	SKQDPA
S31	2260001890	S.SWITCH	SKQDPA
EP1	0910052273	PCB	B 5403C

[KEY BOARD]

REF NO.	ORDER NO.	DESCRIPTION	
C1	4030006880	S.CERAMIC	C1608 JB 1H 472K-T-A
C2	4030006880	S.CERAMIC	C1608 JB 1H 472K-T-A
J1	6510022620	S.CONNECTOR	10FMN-BMTTR-A-TBT
J2	6450001790	CONNECTOR	HLJ7000-01-3010
EP1	0910052311	PCB	B 5406A

[PLL UNIT]

REF NO.	ORDER NO.	DESCRIPTION	
IC1	1130007700	S.IC	BU4094BCF-T1
IC101	1140007880	S.IC	TC190G08AF-0046-Z/SC-1246A
IC102	1130003830	S.IC	TC7S04F (TE85R)
IC191	1130006440	S.IC	TC7S08F (TE85R)
IC192	1130006440	S.IC	TC7S08F (TE85R)
IC320	1110001890	S.IC	μPC1678G-E2
IC381	1130009230	S.IC	LMX2306TMX
IC382	1180000420	S.IC	TA78L05F (TE12R)
IC401	1140007880	S.IC	TC190G08AF-0046-Z/SC-1246A
IC402	1130003830	S.IC	TC7S04F (TE85R)
IC620	1110001890	S.IC	μPC1678G-E2
IC681	1130009230	S.IC	LMX2306TMX
IC682	1180000420	S.IC	TA78L05F (TE12R)
IC701	1140004550	S.IC	M65343FP/SC1287
IC801	1140004550	S.IC	M65343FP/SC1287
IC901	1130007660	S.IC	LC7153M-TLM
IC902	1130006800	S.IC	TC7W08F (TE12L)
Q2	1590002420	S.TRANSISTOR	UMD3N TL
Q51	1530002560	S.TRANSISTOR	2SC4403-3-TL
Q52	1530002060	S.TRANSISTOR	2SC4081 T107 R
Q71	1530002060	S.TRANSISTOR	2SC4081 T107 R
Q81	1530002570	S.TRANSISTOR	2SC4405-3-TL
Q102	1530002060	S.TRANSISTOR	2SC4081 T107 R
Q103	1530002060	S.TRANSISTOR	2SC4081 T107 R
Q121	1590002420	S.TRANSISTOR	UMD3N TL
Q122	1590002420	S.TRANSISTOR	UMD3N TL
Q123	1590002420	S.TRANSISTOR	UMD3N TL
Q124	1590002420	S.TRANSISTOR	UMD3N TL
Q126	1590002420	S.TRANSISTOR	UMD3N TL
Q151	1560000330	S.FET	2SK210-GR (TE85R)
Q152	1530002060	S.TRANSISTOR	2SC4081 T107 R
Q181	1530002060	S.TRANSISTOR	2SC4081 T107 R
Q201	1560000490	S.FET	2SK508 K52 T2B
Q202	1530003090	S.TRANSISTOR	2SC4213-B (TE85R)
Q221	1560000490	S.FET	2SK508 K52 T2B
Q222	1530003090	S.TRANSISTOR	2SC4213-B (TE85R)
Q251	1560000490	S.FET	2SK508 K52 T2B
Q252	1530003090	S.TRANSISTOR	2SC4213-B (TE85R)
Q271	1560000490	S.FET	2SK508 K52 T2B
Q272	1530003090	S.TRANSISTOR	2SC4213-B (TE85R)
Q301	1530002560	S.TRANSISTOR	2SC4403-3-TL
Q351	1590001870	S.TRANSISTOR	DTA114EE TL
Q361	1590002310	S.TRANSISTOR	DTC114EE TL
Q402	1530002060	S.TRANSISTOR	2SC4081 T107 R
Q403	1530002060	S.TRANSISTOR	2SC4081 T107 R
Q421	1590002420	S.TRANSISTOR	UMD3N TL
Q422	1590002420	S.TRANSISTOR	UMD3N TL
Q423	1590002420	S.TRANSISTOR	UMD3N TL
Q424	1590002420	S.TRANSISTOR	UMD3N TL
Q426	1590002420	S.TRANSISTOR	UMD3N TL
Q451	1560000330	S.FET	2SK210-GR (TE85R)
Q452	1530002060	S.TRANSISTOR	2SC4081 T107 R
Q481	1530002060	S.TRANSISTOR	2SC4081 T107 R
Q501	1560000490	S.FET	2SK508 K52 T2B
Q502	1530003090	S.TRANSISTOR	2SC4213-B (TE85R)
Q521	1560000490	S.FET	2SK508 K52 T2B
Q522	1530003090	S.TRANSISTOR	2SC4213-B (TE85R)
Q551	1560000490	S.FET	2SK508 K52 T2B
Q552	1530003090	S.TRANSISTOR	2SC4213-B (TE85R)
Q571	1560000490	S.FET	2SK508 K52 T2B
Q572	1530003090	S.TRANSISTOR	2SC4213-B (TE85R)
Q601	1530002560	S.TRANSISTOR	2SC4403-3-TL

S.=Surface mount

[PLL UNIT]

REF NO.	ORDER NO.	DESCRIPTION	
Q651	1590001870	S.TRANSISTOR	DTA114EE TL
Q661	1590002310	S.TRANSISTOR	DTC114EE TL
Q681	1510000510	S.TRANSISTOR	2SA1576A T106R
Q701	1530002060	S.TRANSISTOR	2SC4081 T107 R
Q801	1530002060	S.TRANSISTOR	2SC4081 T107 R
Q802	1530003010	S.TRANSISTOR	2SC4117-GR (TE85R)
Q902	1560000490	S.FET	2SK508 K52 T2B
Q903	1530003010	S.TRANSISTOR	2SC4117-GR (TE85R)
Q904	1530002370	S.TRANSISTOR	2SC2714-O (TE85R)
Q905	1590002310	S.TRANSISTOR	DTC114EE TL
Q906	1590000980	S.TRANSISTOR	DTB123EK T147
Q907	1590002310	S.TRANSISTOR	DTC114EE TL
D2	1160000140	S.DIODE	DAP222 TL
D3	1750000520	S.DIODE	DAN222TL
D4	1750000520	S.DIODE	DAN222TL
D51	1720000390	S.VARICAP	KV1470TL
D151	1720000590	S.VARICAP	MA357 (TX)
D152	1790000490	S.DIODE	HSM88AS-TR
D153	1790000490	S.DIODE	HSM88AS-TR
D201	1720000390	S.VARICAP	KV1470TL
D202	1720000390	S.VARICAP	KV1470TL
D221	1720000390	S.VARICAP	KV1470TL
D222	1720000390	S.VARICAP	KV1470TL
D251	1790000540	S.VARICAP	MA338 (TX)
D252	1790000540	S.VARICAP	MA338 (TX)
D253	1790000540	S.VARICAP	MA338 (TX)
D254	1790000540	S.VARICAP	MA338 (TX)
D271	1790000540	S.VARICAP	MA338 (TX)
D272	1790000540	S.VARICAP	MA338 (TX)
D273	1790000540	S.VARICAP	MA338 (TX)
D274	1790000540	S.VARICAP	MA338 (TX)
D301	1790000620	S.DIODE	MA77 (TX)
D351	1790000620	S.DIODE	MA77 (TX)
D361	1750000580	S.DIODE	1SV307 (TPH3)
D362	1750000580	S.DIODE	1SV307 (TPH3)
D451	1720000590	S.VARICAP	MA357 (TX)
D452	1790000490	S.DIODE	HSM88AS-TR
D453	1790000490	S.DIODE	HSM88AS-TR
D501	1720000390	S.VARICAP	KV1470TL
D502	1720000390	S.VARICAP	KV1470TL
D521	1720000390	S.VARICAP	KV1470TL
D522	1720000390	S.VARICAP	KV1470TL
D551	1790000540	S.VARICAP	MA338 (TX)
D552	1790000540	S.VARICAP	MA338 (TX)
D553	1790000540	S.VARICAP	MA338 (TX)
D554	1790000540	S.VARICAP	MA338 (TX)
D571	1790000540	S.VARICAP	MA338 (TX)
D572	1790000540	S.VARICAP	MA338 (TX)
D573	1790000540	S.VARICAP	MA338 (TX)
D574	1790000540	S.VARICAP	MA338 (TX)
D601	1790000620	S.DIODE	MA77 (TX)
D651	1790000620	S.DIODE	MA77 (TX)
D661	1750000580	S.DIODE	1SV307 (TPH3)
D662	1750000580	S.DIODE	1SV307 (TPH3)
D901	1720000590	S.VARICAP	MA357 (TX)
D902	1750000070	S.DIODE	1SS226 (TE85R)
FI101	2020001690	S.CERAMIC	CFEC10.8MD11
FI401	2020001690	S.CERAMIC	CFEC10.8MD11
X52	6050008870	XTAL	CR-338 (32.00056 MHz)
L1	6200003950	S.COIL	HF50ACC 322513-T
L2	6200003950	S.COIL	HF50ACC 322513-T
L31	6200003590	S.COIL	EXCCL3225U1
L51	6200008910	S.COIL	1812CS-122XKBC
L52	6150004370	COIL	LS-472C (C-15045)
L55	6200001830	S.COIL	NL 322522T-100J
L81	6150004830	S.COIL	LS-509
L82	6150004830	S.COIL	LS-509
L101	6200001830	S.COIL	NL 322522T-100J
L121	6200001830	S.COIL	NL 322522T-100J
L122	6200001830	S.COIL	NL 322522T-100J
L123	6200001830	S.COIL	NL 322522T-100J
L124	6200001830	S.COIL	NL 322522T-100J
L125	6200001830	S.COIL	NL 322522T-100J
L126	6200001830	S.COIL	NL 322522T-100J

[PLL UNIT]

REF NO.	ORDER NO.	DESCRIPTION	
L128	6200001830	S.COIL	NL 322522T-100J
L152	6130002970	COIL	LB-343
L153	6200001830	S.COIL	NL 322522T-100J
L181	6200001830	S.COIL	NL 322522T-100J
L202	6190001410	COIL	E526GN-110501
L204	6200003260	S.COIL	NL 322522T-101J
L205	6200008910	S.COIL	1812CS-122XKBC
L206	6200008910	S.COIL	1812CS-122XKBC
L222	6190001410	COIL	E526GN-110501
L224	6200003260	S.COIL	NL 322522T-101J
L225	6200008910	S.COIL	1812CS-122XKBC
L226	6200008910	S.COIL	1812CS-122XKBC
L252	6190001420	COIL	E526GN-110502
L254	6200003260	S.COIL	NL 322522T-101J
L255	6200008910	S.COIL	1812CS-122XKBC
L256	6200008910	S.COIL	1812CS-122XKBC
L272	6190001440	COIL	E526GN-110504
L274	6200003260	S.COIL	NL 322522T-101J
L275	6200008910	S.COIL	1812CS-122XKBC
L276	6200008910	S.COIL	1812CS-122XKBC
L301	6200005550	S.COIL	ELJFC 100K-F
L303	6200004030	S.COIL	NL 322522T-047J
L304	6200002960	S.COIL	NL 322522T-4R7J-3
L320	6200004590	S.COIL	MLF1608D R18K-T
L321	6200003020	S.COIL	NL 322522T-R33J-3
L351	6200002410	S.COIL	NL 252018T-056J
L352	6200002430	S.COIL	NL 252018T-082J
L353	6200002430	S.COIL	NL 252018T-082J
L354	6200003420	S.COIL	NL 322522T-R15J-3
L355	6200000880	S.COIL	NL 322522T-4R7M
L357	6200003160	S.COIL	NL 322522T-270J
L382	6200003950	S.COIL	HF50ACC 322513-T
L401	6200001830	S.COIL	NL 322522T-100J
L421	6200001830	S.COIL	NL 322522T-100J
L422	6200001830	S.COIL	NL 322522T-100J
L423	6200001830	S.COIL	NL 322522T-100J
L424	6200001830	S.COIL	NL 322522T-100J
L425	6200001830	S.COIL	NL 322522T-100J
L426	6200001830	S.COIL	NL 322522T-100J
L428	6200001830	S.COIL	NL 322522T-100J
L452	6130002970	COIL	LB-343
L453	6200001830	S.COIL	NL 322522T-100J
L481	6200001830	S.COIL	NL 322522T-100J
L491	6200003040	S.COIL	NL 322522T-R68J-3
L492	6200003050	S.COIL	NL 322522T-R82J-3
L502	6190001410	COIL	E526GN-110501
L504	6200003260	S.COIL	NL 322522T-101J
L505	6200008910	S.COIL	1812CS-122XKBC
L506	6200008910	S.COIL	1812CS-122XKBC
L522	6190001410	COIL	E526GN-110501
L524	6200003260	S.COIL	NL 322522T-101J
L525	6200008910	S.COIL	1812CS-122XKBC
L526	6200008910	S.COIL	1812CS-122XKBC
L552	6190001420	COIL	E526GN-110502
L554	6200003260	S.COIL	NL 322522T-101J
L555	6200008910	S.COIL	1812CS-122XKBC
L556	6200008910	S.COIL	1812CS-122XKBC
L572	6190001440	COIL	E526GN-110504
L574	6200003260	S.COIL	NL 322522T-101J
L575	6200008910	S.COIL	1812CS-122XKBC
L576	6200008910	S.COIL	1812CS-122XKBC
L601	6200001830	S.COIL	NL 322522T-100J
L603	6200004030	S.COIL	NL 322522T-047J
L604	6200000880	S.COIL	NL 322522T-4R7M
L620	6200004590	S.COIL	MLF1608D R18K-T
L621	6200003020	S.COIL	NL 322522T-R33J-3
L651	6200002410	S.COIL	NL 252018T-056J
L652	6200002430	S.COIL	NL 252018T-082J
L653	6200002430	S.COIL	NL 252018T-082J
L654	6200003420	S.COIL	NL 322522T-R15J-3
L655	6200002960	S.COIL	NL 322522T-4R7J-3
L657	6200003160	S.COIL	NL 322522T-270J
L682	6200003950	S.COIL	HF50ACC 322513-T
L701	6200001830	S.COIL	NL 322522T-100J
L702	6200005490	S.COIL	NL 322522T-331J
L703	6200008640	S.COIL	NL 322522T-391J
L704	6200008640	S.COIL	NL 322522T-391J
L801	6200001830	S.COIL	NL 322522T-100J
L802	6200001830	S.COIL	NL 322522T-100J
L803	6200003130	S.COIL	NL 322522T-120J
L804	6200003170	S.COIL	NL 322522T-330J
L806	6200002980	S.COIL	NL 322522T-R56J-3

S.=Surface mount

[PLL UNIT]

REF NO.	ORDER NO.	DESCRIPTION
L901	6200008940	S.COIL LQH 3N 331K 34
L902	6200004950	S.COIL NL 252018T-1R8J
L903	6200003260	S.COIL NL 322522T-101J
L904	6190000950	COIL C-13975-6.5T
L905	6200003660	S.COIL NL 252018T-R68J
L906	6200003260	S.COIL NL 322522T-101J
L907	6200002630	S.COIL NL 252018T-R10J
L908	6200002180	S.COIL NL 252018T-R12J
L909	6200003260	S.COIL NL 322522T-101J
L910	6200004960	S.COIL NL 252018T-R33J
R1	7030003320	S.RESISTOR ERJ3GEYJ 101 V (100 Ω)
R2	7030003440	S.RESISTOR ERJ3GEYJ 102 V (1 kΩ)
R3	7030003280	S.RESISTOR ERJ3GEYJ 470 V (47 Ω)
R4	7030003280	S.RESISTOR ERJ3GEYJ 470 V (47 Ω)
R5	7030003440	S.RESISTOR ERJ3GEYJ 102 V (1 kΩ)
R8	7030003440	S.RESISTOR ERJ3GEYJ 102 V (1 kΩ)
R9	7030003440	S.RESISTOR ERJ3GEYJ 102 V (1 kΩ)
R10	7030003640	S.RESISTOR ERJ3GEYJ 473 V (47 kΩ)
R11	7030003640	S.RESISTOR ERJ3GEYJ 473 V (47 kΩ)
R12	7030003640	S.RESISTOR ERJ3GEYJ 473 V (47 kΩ)
R13	7030003640	S.RESISTOR ERJ3GEYJ 473 V (47 kΩ)
R14	7030003640	S.RESISTOR ERJ3GEYJ 473 V (47 kΩ)
R15	7030003560	S.RESISTOR ERJ3GEYJ 103 V (10 kΩ)
R32	7310003820	TRIMMER EVN-D2AA03 B14
R33	7310002720	S.TRIMMER RV-148 (RH03A3AS3X0DA) 472
R36	7030003640	S.RESISTOR ERJ3GEYJ 473 V (47 kΩ)
R40	7030003550	S.RESISTOR ERJ3GEYJ 822 V (8.2 kΩ)
R41	7030003550	S.RESISTOR ERJ3GEYJ 822 V (8.2 kΩ)
R42	7030003550	S.RESISTOR ERJ3GEYJ 822 V (8.2 kΩ)
R43	7030003550	S.RESISTOR ERJ3GEYJ 822 V (8.2 kΩ)
R44	7030003550	S.RESISTOR ERJ3GEYJ 822 V (8.2 kΩ)
R45	7030003550	S.RESISTOR ERJ3GEYJ 822 V (8.2 kΩ)
R46	7030003550	S.RESISTOR ERJ3GEYJ 822 V (8.2 kΩ)
R47	7030003440	S.RESISTOR ERJ3GEYJ 102 V (1 kΩ)
R48	7030003440	S.RESISTOR ERJ3GEYJ 102 V (1 kΩ)
R51	7030003640	S.RESISTOR ERJ3GEYJ 473 V (47 kΩ)
R52	7030003580	S.RESISTOR ERJ3GEYJ 153 V (15 kΩ)
R53	7030003520	S.RESISTOR ERJ3GEYJ 472 V (4.7 kΩ)
R54	7030003400	S.RESISTOR ERJ3GEYJ 471 V (470 Ω)
R55	7030003280	S.RESISTOR ERJ3GEYJ 470 V (47 Ω)
R57	7030003440	S.RESISTOR ERJ3GEYJ 102 V (1 kΩ)
R58	7030003610	S.RESISTOR ERJ3GEYJ 273 V (27 kΩ)
R60	7030003380	S.RESISTOR ERJ3GEYJ 331 V (330 Ω)
R61	7030003360	S.RESISTOR ERJ3GEYJ 221 V (220 Ω)
R62	7030003260	S.RESISTOR ERJ3GEYJ 330 V (33 Ω)
R63	7030003420	S.RESISTOR ERJ3GEYJ 681 V (680 Ω)
R71	7030003640	S.RESISTOR ERJ3GEYJ 473 V (47 kΩ)
R72	7030003380	S.RESISTOR ERJ3GEYJ 331 V (330 Ω)
R81	7030003600	S.RESISTOR ERJ3GEYJ 223 V (22 kΩ)
R82	7030003560	S.RESISTOR ERJ3GEYJ 103 V (10 kΩ)
R83	7030003370	S.RESISTOR ERJ3GEYJ 271 V (270 Ω)
R84	7030003320	S.RESISTOR ERJ3GEYJ 101 V (100 Ω)
R85	7030003350	S.RESISTOR ERJ3GEYJ 181 V (180 Ω)
R86	7030003350	S.RESISTOR ERJ3GEYJ 181 V (180 Ω)
R87	7030003220	S.RESISTOR ERJ3GEYJ 150 V (15 Ω)
R89	7030003260	S.RESISTOR ERJ3GEYJ 330 V (33 Ω)
R101	7030005400	S.RESISTOR RR0816P-202-D (2 kΩ)
R102	7030005400	S.RESISTOR RR0816P-202-D (2 kΩ)
R103	7030005390	S.RESISTOR RR0816P-102-D (1 kΩ)
R104	7030005400	S.RESISTOR RR0816P-202-D (2 kΩ)
R105	7030005390	S.RESISTOR RR0816P-102-D (1 kΩ)
R106	7030005400	S.RESISTOR RR0816P-202-D (2 kΩ)
R107	7030005390	S.RESISTOR RR0816P-102-D (1 kΩ)
R108	7030005400	S.RESISTOR RR0816P-202-D (2 kΩ)
R109	7030005390	S.RESISTOR RR0816P-102-D (1 kΩ)
R110	7030005400	S.RESISTOR RR0816P-202-D (2 kΩ)
R111	7030005390	S.RESISTOR RR0816P-102-D (1 kΩ)
R112	7030005400	S.RESISTOR RR0816P-202-D (2 kΩ)
R113	7030005390	S.RESISTOR RR0816P-102-D (1 kΩ)
R114	7030005400	S.RESISTOR RR0816P-202-D (2 kΩ)
R115	7030005380	S.RESISTOR RR0816P-102-B (1 kΩ)
R116	7030005370	S.RESISTOR RR0816P-202-B (2 kΩ)
R117	7030005380	S.RESISTOR RR0816P-102-B (1 kΩ)
R118	7030005370	S.RESISTOR RR0816P-202-B (2 kΩ)
R119	7030005380	S.RESISTOR RR0816P-102-B (1 kΩ)
R120	7030005370	S.RESISTOR RR0816P-202-B (2 kΩ)
R121	7030005380	S.RESISTOR RR0816P-102-B (1 kΩ)
R122	7030005370	S.RESISTOR RR0816P-202-B (2 kΩ)
R123	7030005380	S.RESISTOR RR0816P-102-B (1 kΩ)
R124	7030005370	S.RESISTOR RR0816P-202-B (2 kΩ)

[PLL UNIT]

REF NO.	ORDER NO.	DESCRIPTION
R125	7030003400	S.RESISTOR ERJ3GEYJ 471 V (470 Ω)
R127	7030003800	S.RESISTOR ERJ3GEYJ 105 V (1 MΩ)
R130	7030003200	S.RESISTOR ERJ3GEYJ 100 V (10 Ω)
R131	7030003320	S.RESISTOR ERJ3GEYJ 101 V (100 Ω)
R132	7030003640	S.RESISTOR ERJ3GEYJ 473 V (47 kΩ)
R133	7030003360	S.RESISTOR ERJ3GEYJ 221 V (220 Ω)
R134	7030003240	S.RESISTOR ERJ3GEYJ 220 V (22 Ω)
R135	7030003330	S.RESISTOR ERJ3GEYJ 121 V (120 Ω)
R136	7030003220	S.RESISTOR ERJ3GEYJ 150 V (15 Ω)
R137	7030003840	S.RESISTOR ERJ3GEYJ 225 V (2.2 MΩ)
R139	7030003640	S.RESISTOR ERJ3GEYJ 473 V (47 kΩ)
R140	7030003370	S.RESISTOR ERJ3GEYJ 271 V (270 Ω)
R141	7030003320	S.RESISTOR ERJ3GEYJ 101 V (100 Ω)
R142	7030003440	S.RESISTOR ERJ3GEYJ 102 V (1 kΩ)
R143	7030003440	S.RESISTOR ERJ3GEYJ 102 V (1 kΩ)
R144	7030003440	S.RESISTOR ERJ3GEYJ 102 V (1 kΩ)
R145	7030003440	S.RESISTOR ERJ3GEYJ 102 V (1 kΩ)
R146	7030003440	S.RESISTOR ERJ3GEYJ 102 V (1 kΩ)
R147	7030003440	S.RESISTOR ERJ3GEYJ 102 V (1 kΩ)
R150	7030003560	S.RESISTOR ERJ3GEYJ 103 V (10 kΩ)
R151	7030003680	S.RESISTOR ERJ3GEYJ 104 V (100 kΩ)
R152	7030003680	S.RESISTOR ERJ3GEYJ 104 V (100 kΩ)
R153	7030003340	S.RESISTOR ERJ3GEYJ 151 V (150 Ω)
R154	7030003320	S.RESISTOR ERJ3GEYJ 101 V (100 Ω)
R155	7030003350	S.RESISTOR ERJ3GEYJ 181 V (180 Ω)
R156	7030003640	S.RESISTOR ERJ3GEYJ 473 V (47 kΩ)
R157	7030003360	S.RESISTOR ERJ3GEYJ 221 V (220 Ω)
R158	7030003320	S.RESISTOR ERJ3GEYJ 101 V (100 Ω)
R159	7030003220	S.RESISTOR ERJ3GEYJ 150 V (15 Ω)
R160	7030003220	S.RESISTOR ERJ3GEYJ 150 V (15 Ω)
R161	7030003310	S.RESISTOR ERJ3GEYJ 820 V (82 Ω)
R181	7030003440	S.RESISTOR ERJ3GEYJ 102 V (1 kΩ)
R182	7030003530	S.RESISTOR ERJ3GEYJ 562 V (5.6 kΩ)
R191	7030003320	S.RESISTOR ERJ3GEYJ 101 V (100 Ω)
R192	7030003480	S.RESISTOR ERJ3GEYJ 222 V (2.2 kΩ)
R202	7030006520	S.RESISTOR RR0816P-561-D (560 Ω)
R203	7030006520	S.RESISTOR RR0816P-561-D (560 Ω)
R204	7030003560	S.RESISTOR ERJ3GEYJ 103 V (10 kΩ)
R222	7030009840	S.RESISTOR RR0816Q-330-D (33 Ω)
R223	7030009860	S.RESISTOR RR0816P-471-D (470 Ω)
R224	7030003560	S.RESISTOR ERJ3GEYJ 103 V (10 kΩ)
R252	7030009850	S.RESISTOR RR0816P-271-D (270 Ω)
R253	7030006520	S.RESISTOR RR0816P-561-D (560 Ω)
R254	7030003560	S.RESISTOR ERJ3GEYJ 103 V (10 kΩ)
R272	7030006520	S.RESISTOR RR0816P-561-D (560 Ω)
R273	7030006520	S.RESISTOR RR0816P-561-D (560 Ω)
R274	7030003560	S.RESISTOR ERJ3GEYJ 103 V (10 kΩ)
R275	7030003280	S.RESISTOR ERJ3GEYJ 470 V (47 Ω)
R301	7030003470	S.RESISTOR RR0816P-271-D (2.7 kΩ)
R302	7030003480	S.RESISTOR ERJ3GEYJ 222 V (2.2 kΩ)
R303	7030003440	S.RESISTOR ERJ3GEYJ 102 V (1 kΩ)
R304	7030003260	S.RESISTOR ERJ3GEYJ 330 V (33 Ω)
R309	7030003410	S.RESISTOR ERJ3GEYJ 561 V (560 Ω)
R320	7030003400	S.RESISTOR ERJ3GEYJ 471 V (470 Ω)
R321	7030003200	S.RESISTOR ERJ3GEYJ 100 V (10 Ω)
R322	7030003400	S.RESISTOR ERJ3GEYJ 471 V (470 Ω)
R323	7030003200	S.RESISTOR ERJ3GEYJ 100 V (10 Ω)
R350	7030003470	S.RESISTOR ERJ3GEYJ 182 V (1.8 kΩ)
R351	7030003490	S.RESISTOR ERJ3GEYJ 272 V (2.7 kΩ)
R352	7030003370	S.RESISTOR ERJ3GEYJ 271 V (270 Ω)
R353	7030003220	S.RESISTOR ERJ3GEYJ 150 V (15 Ω)
R354	7030003370	S.RESISTOR ERJ3GEYJ 271 V (270 Ω)
R355	7030003320	S.RESISTOR ERJ3GEYJ 101 V (100 Ω)
R356	7030003640	S.RESISTOR ERJ3GEYJ 473 V (47 kΩ)
R361	7030003520	S.RESISTOR ERJ3GEYJ 472 V (4.7 kΩ)
R362	7030003320	S.RESISTOR ERJ3GEYJ 101 V (100 Ω)
R363	7030003520	S.RESISTOR ERJ3GEYJ 472 V (4.7 kΩ)
R380	7030003560	S.RESISTOR ERJ3GEYJ 103 V (10 kΩ)
R381	7030003320	S.RESISTOR ERJ3GEYJ 101 V (100 Ω)
R385	7030003440	S.RESISTOR ERJ3GEYJ 102 V (1 kΩ)
R386	7030003440	S.RESISTOR ERJ3GEYJ 102 V (1 kΩ)
R387	7030003440	S.RESISTOR ERJ3GEYJ 102 V (1 kΩ)
R393	7030009650	S.RESISTOR RR0816Q-820-D (82 Ω)
R394	7030005350	S.RESISTOR RR0816P-182-D (1.8 kΩ)
R401	7030005400	S.RESISTOR RR0816P-202-D (2 kΩ)
R402	7030005400	S.RESISTOR RR0816P-202-D (2 kΩ)
R403	7030005390	S.RESISTOR RR0816P-102-D (1 kΩ)
R404	7030005400	S.RESISTOR RR0816P-202-D (2 kΩ)
R405	7030005390	S.RESISTOR RR0816P-102-D (1 kΩ)
R406	7030005400	S.RESISTOR RR0816P-202-D (2 kΩ)
R407	7030005390	S.RESISTOR RR0816P-102-D (1 kΩ)
R408	7030005400	S.RESISTOR RR0816P-202-D (2 kΩ)

S.=Surface mount

[PLL UNIT]

REF NO.	ORDER NO.	DESCRIPTION
R409	7030005390	S.RESISTOR RR0816P-102-D (1 kΩ)
R410	7030005400	S.RESISTOR RR0816P-202-D (2 kΩ)
R411	7030005390	S.RESISTOR RR0816P-102-D (1 kΩ)
R412	7030005400	S.RESISTOR RR0816P-202-D (2 kΩ)
R413	7030005390	S.RESISTOR RR0816P-102-D (1 kΩ)
R414	7030005370	S.RESISTOR RR0816P-202-B (2 kΩ)
R415	7030005380	S.RESISTOR RR0816P-102-B (1 kΩ)
R416	7030005370	S.RESISTOR RR0816P-202-B (2 kΩ)
R417	7030005380	S.RESISTOR RR0816P-102-B (1 kΩ)
R418	7030005370	S.RESISTOR RR0816P-202-B (2 kΩ)
R419	7030005380	S.RESISTOR RR0816P-102-B (1 kΩ)
R420	7030005370	S.RESISTOR RR0816P-202-B (2 kΩ)
R421	7030005380	S.RESISTOR RR0816P-102-B (1 kΩ)
R422	7030005370	S.RESISTOR RR0816P-202-B (2 kΩ)
R423	7030005380	S.RESISTOR RR0816P-102-B (1 kΩ)
R424	7030005370	S.RESISTOR RR0816P-202-B (2 kΩ)
R425	7030003400	S.RESISTOR ERJ3GEYJ 471 V (470 Ω)
R427	7030003800	S.RESISTOR ERJ3GEYJ 105 V (1 MΩ)
R430	7030003200	S.RESISTOR ERJ3GEYJ 100 V (10 Ω)
R431	7030003320	S.RESISTOR ERJ3GEYJ 101 V (100 Ω)
R432	7030003640	S.RESISTOR ERJ3GEYJ 473 V (47 kΩ)
R433	7030003360	S.RESISTOR ERJ3GEYJ 221 V (220 Ω)
R434	7030003240	S.RESISTOR ERJ3GEYJ 220 V (22 Ω)
R435	7030003330	S.RESISTOR ERJ3GEYJ 121 V (120 Ω)
R436	7030003220	S.RESISTOR ERJ3GEYJ 150 V (15 Ω)
R437	7030003840	S.RESISTOR ERJ3GEYJ 225 V (2.2 MΩ)
R439	7030003640	S.RESISTOR ERJ3GEYJ 473 V (47 kΩ)
R440	7030003370	S.RESISTOR ERJ3GEYJ 271 V (270 Ω)
R441	7030003320	S.RESISTOR ERJ3GEYJ 101 V (100 Ω)
R442	7030003440	S.RESISTOR ERJ3GEYJ 102 V (1 kΩ)
R443	7030003440	S.RESISTOR ERJ3GEYJ 102 V (1 kΩ)
R444	7030003440	S.RESISTOR ERJ3GEYJ 102 V (1 kΩ)
R445	7030003440	S.RESISTOR ERJ3GEYJ 102 V (1 kΩ)
R446	7030003440	S.RESISTOR ERJ3GEYJ 102 V (1 kΩ)
R447	7030003440	S.RESISTOR ERJ3GEYJ 102 V (1 kΩ)
R450	7030003560	S.RESISTOR ERJ3GEYJ 103 V (10 kΩ)
R451	7030003680	S.RESISTOR ERJ3GEYJ 104 V (100 kΩ)
R452	7030003680	S.RESISTOR ERJ3GEYJ 104 V (100 kΩ)
R453	7030003340	S.RESISTOR ERJ3GEYJ 151 V (150 Ω)
R454	7030003320	S.RESISTOR ERJ3GEYJ 101 V (100 Ω)
R455	7030003350	S.RESISTOR ERJ3GEYJ 181 V (180 Ω)
R456	7030003640	S.RESISTOR ERJ3GEYJ 473 V (47 kΩ)
R457	7030003360	S.RESISTOR ERJ3GEYJ 221 V (220 Ω)
R458	7030003320	S.RESISTOR ERJ3GEYJ 101 V (100 Ω)
R459	7030003220	S.RESISTOR ERJ3GEYJ 150 V (15 Ω)
R461	7030003310	S.RESISTOR ERJ3GEYJ 820 V (82 Ω)
R481	7030003440	S.RESISTOR ERJ3GEYJ 102 V (1 kΩ)
R482	7030003530	S.RESISTOR ERJ3GEYJ 562 V (5.6 kΩ)
R492	7030003350	S.RESISTOR ERJ3GEYJ 181 V (180 Ω)
R502	7030006520	S.RESISTOR RR0816P-561-D (560 Ω)
R503	7030006520	S.RESISTOR RR0816P-561-D (560 Ω)
R504	7030003560	S.RESISTOR RR0816Q-330-D (33 Ω)
R522	7030009840	S.RESISTOR RR0816P-471-D (470 Ω)
R523	7030009860	S.RESISTOR ERJ3GEYJ 103 V (10 kΩ)
R524	7030003560	S.RESISTOR RR0816P-271-D (270 Ω)
R552	7030009850	S.RESISTOR RR0816P-561-D (560 Ω)
R553	7030006520	S.RESISTOR RR0816P-561-D (560 Ω)
R554	7030003560	S.RESISTOR RR0816P-561-D (560 Ω)
R572	7030006520	S.RESISTOR RR0816P-561-D (560 Ω)
R573	7030006520	S.RESISTOR RR0816P-561-D (560 Ω)
R574	7030003560	S.RESISTOR ERJ3GEYJ 103 V (10 kΩ)
R575	7030003280	S.RESISTOR ERJ3GEYJ 470 V (47 Ω)
R601	7030003470	S.RESISTOR ERJ3GEYJ 182 V (1.8 kΩ)
R602	7030003480	S.RESISTOR ERJ3GEYJ 222 V (2.2 kΩ)
R603	7030003440	S.RESISTOR ERJ3GEYJ 102 V (1 kΩ)
R604	7030003260	S.RESISTOR ERJ3GEYJ 330 V (33 Ω)
R609	7030003410	S.RESISTOR ERJ3GEYJ 561 V (560 Ω)
R620	7030003400	S.RESISTOR ERJ3GEYJ 471 V (470 Ω)
R621	7030003200	S.RESISTOR ERJ3GEYJ 100 V (10 Ω)
R622	7030003400	S.RESISTOR ERJ3GEYJ 471 V (470 Ω)
R623	7030003200	S.RESISTOR ERJ3GEYJ 100 V (10 Ω)
R650	7030003470	S.RESISTOR ERJ3GEYJ 182 V (1.8 kΩ)
R651	7030003490	S.RESISTOR ERJ3GEYJ 272 V (2.7 kΩ)
R652	7030003370	S.RESISTOR ERJ3GEYJ 271 V (270 Ω)
R653	7030003220	S.RESISTOR ERJ3GEYJ 150 V (15 Ω)
R654	7030003370	S.RESISTOR ERJ3GEYJ 271 V (270 Ω)
R655	7030003320	S.RESISTOR ERJ3GEYJ 101 V (100 Ω)
R656	7030003640	S.RESISTOR ERJ3GEYJ 473 V (47 kΩ)
R660	7030003220	S.RESISTOR ERJ3GEYJ 150 V (15 Ω)
R661	7030003520	S.RESISTOR ERJ3GEYJ 472 V (4.7 kΩ)
R662	7030003320	S.RESISTOR ERJ3GEYJ 101 V (100 Ω)
R663	7030003520	S.RESISTOR ERJ3GEYJ 472 V (4.7 kΩ)

[PLL UNIT]

REF NO.	ORDER NO.	DESCRIPTION
R680	7030003560	S.RESISTOR ERJ3GEYJ 103 V (10 kΩ)
R681	7030003320	S.RESISTOR ERJ3GEYJ 101 V (100 Ω)
R685	7030003440	S.RESISTOR ERJ3GEYJ 102 V (1 kΩ)
R686	7030003440	S.RESISTOR ERJ3GEYJ 102 V (1 kΩ)
R687	7030003440	S.RESISTOR ERJ3GEYJ 102 V (1 kΩ)
R688	7030003670	S.RESISTOR ERJ3GEYJ 823 V (82 kΩ)
R689	7030003590	S.RESISTOR ERJ3GEYJ 183 V (18 kΩ)
R693	7030009650	S.RESISTOR RR0816Q-820-D (82 Ω)
R694	7030005350	S.RESISTOR RR0816P-182-D (1.8 kΩ)
R701	7030005400	S.RESISTOR RR0816P-202-D (2 kΩ)
R702	7030005390	S.RESISTOR RR0816P-102-D (1 kΩ)
R703	7030005400	S.RESISTOR RR0816P-202-D (2 kΩ)
R704	7030005390	S.RESISTOR RR0816P-102-D (1 kΩ)
R705	7030005400	S.RESISTOR RR0816P-202-D (2 kΩ)
R706	7030005390	S.RESISTOR RR0816P-102-D (1 kΩ)
R707	7030005400	S.RESISTOR RR0816P-202-D (2 kΩ)
R708	7030005390	S.RESISTOR RR0816P-102-D (1 kΩ)
R709	7030005370	S.RESISTOR RR0816P-202-B (2 kΩ)
R710	7030005380	S.RESISTOR RR0816P-102-B (1 kΩ)
R711	7030005370	S.RESISTOR RR0816P-202-B (2 kΩ)
R712	7030005380	S.RESISTOR RR0816P-102-B (1 kΩ)
R713	7030005370	S.RESISTOR RR0816P-202-B (2 kΩ)
R714	7030005380	S.RESISTOR RR0816P-102-B (1 kΩ)
R715	7030005370	S.RESISTOR RR0816P-202-B (2 kΩ)
R716	7030005380	S.RESISTOR RR0816P-102-B (1 kΩ)
R717	7030005370	S.RESISTOR RR0816P-202-B (2 kΩ)
R718	7030005380	S.RESISTOR RR0816P-102-B (1 kΩ)
R719	7030005370	S.RESISTOR RR0816P-202-B (2 kΩ)
R720	7030005370	S.RESISTOR RR0816P-202-B (2 kΩ)
R721	7030003640	S.RESISTOR ERJ3GEYJ 473 V (47 kΩ)
R722	7030003370	S.RESISTOR ERJ3GEYJ 271 V (270 Ω)
R724	7030003480	S.RESISTOR ERJ3GEYJ 222 V (2.2 kΩ)
R727	7030003440	S.RESISTOR ERJ3GEYJ 102 V (1 kΩ)
R728	7030003440	S.RESISTOR ERJ3GEYJ 102 V (1 kΩ)
R729	7030003440	S.RESISTOR ERJ3GEYJ 102 V (1 kΩ)
R730	7030003440	S.RESISTOR ERJ3GEYJ 102 V (1 kΩ)
R801	7030005400	S.RESISTOR RR0816P-202-D (2 kΩ)
R802	7030005390	S.RESISTOR RR0816P-102-D (1 kΩ)
R803	7030005400	S.RESISTOR RR0816P-202-D (2 kΩ)
R804	7030005390	S.RESISTOR RR0816P-102-D (1 kΩ)
R805	7030005400	S.RESISTOR RR0816P-202-D (2 kΩ)
R806	7030005390	S.RESISTOR RR0816P-102-D (1 kΩ)
R807	7030005400	S.RESISTOR RR0816P-202-D (2 kΩ)
R808	7030005390	S.RESISTOR RR0816P-102-D (1 kΩ)
R809	7030005370	S.RESISTOR RR0816P-202-B (2 kΩ)
R810	7030005380	S.RESISTOR RR0816P-102-B (1 kΩ)
R811	7030005370	S.RESISTOR RR0816P-202-B (2 kΩ)
R812	7030005380	S.RESISTOR RR0816P-102-B (1 kΩ)
R813	7030005370	S.RESISTOR RR0816P-202-B (2 kΩ)
R814	7030005380	S.RESISTOR RR0816P-102-B (1 kΩ)
R815	7030005370	S.RESISTOR RR0816P-202-B (2 kΩ)
R816	7030005380	S.RESISTOR RR0816P-102-B (1 kΩ)
R817	7030005370	S.RESISTOR RR0816P-202-B (2 kΩ)
R818	7030005380	S.RESISTOR RR0816P-102-B (1 kΩ)
R819	7030005370	S.RESISTOR RR0816P-202-B (2 kΩ)
R820	7030005370	S.RESISTOR RR0816P-202-B (2 kΩ)
R821	7030003630	S.RESISTOR ERJ3GEYJ 393 V (39 kΩ)
R822	7030003350	S.RESISTOR ERJ3GEYJ 181 V (180 Ω)
R823	7030003470	S.RESISTOR ERJ3GEYJ 182 V (1.8 kΩ)
R824	7030003480	S.RESISTOR ERJ3GEYJ 222 V (2.2 kΩ)
R825	7030003360	S.RESISTOR ERJ3GEYJ 221 V (220 Ω)
R826	7030003320	S.RESISTOR ERJ3GEYJ 101 V (100 Ω)
R827	7030003440	S.RESISTOR ERJ3GEYJ 102 V (1 kΩ)
R828	7030003440	S.RESISTOR ERJ3GEYJ 102 V (1 kΩ)
R829	7030003440	S.RESISTOR ERJ3GEYJ 102 V (1 kΩ)
R830	7030003440	S.RESISTOR ERJ3GEYJ 102 V (1 kΩ)
R901	7030003440	S.RESISTOR ERJ3GEYJ 102 V (1 kΩ)
R902	7030003440	S.RESISTOR ERJ3GEYJ 102 V (1 kΩ)
R903	7030003440	S.RESISTOR ERJ3GEYJ 102 V (1 kΩ)
R904	7030003560	S.RESISTOR ERJ3GEYJ 103 V (10 kΩ)
R906	7030003280	S.RESISTOR ERJ3GEYJ 470 V (47 Ω)
R907	7030003650	S.RESISTOR ERJ3GEYJ 563 V (56 kΩ)
R908	7030003840	S.RESISTOR ERJ3GEYJ 225 V (2.2 MΩ)
R909	7030003460	S.RESISTOR ERJ3GEYJ 152 V (1.5 kΩ)
R910	7030003520	S.RESISTOR ERJ3GEYJ 472 V (4.7 kΩ)
R911	7030003440	S.RESISTOR ERJ3GEYJ 102 V (1 kΩ)
R912	7030003440	S.RESISTOR ERJ3GEYJ 102 V (1 kΩ)
R913	7030003680	S.RESISTOR ERJ3GEYJ 104 V (100 kΩ)
R914	7030003680	S.RESISTOR ERJ3GEYJ 104 V (100 kΩ)
R915	7030003320	S.RESISTOR ERJ3GEYJ 101 V (100 Ω)
R916	7030003340	S.RESISTOR ERJ3GEYJ 151 V (150 Ω)
R917	7030003320	S.RESISTOR ERJ3GEYJ 101 V (100 Ω)

S.=Surface mount

[PLL UNIT]

REF NO.	ORDER NO.	DESCRIPTION	
R918	7030003680	S.RESISTOR	ERJ3GEYJ 104 V (100 kΩ)
R919	7030003440	S.RESISTOR	ERJ3GEYJ 102 V (1 kΩ)
R920	7030003280	S.RESISTOR	ERJ3GEYJ 470 V (47 Ω)
R921	7030003280	S.RESISTOR	ERJ3GEYJ 470 V (47 Ω)
R922	7030003320	S.RESISTOR	ERJ3GEYJ 101 V (100 Ω)
R923	7030003530	S.RESISTOR	ERJ3GEYJ 562 V (5.6 kΩ)
R924	7030003420	S.RESISTOR	ERJ3GEYJ 681 V (680 Ω)
R925	7030003200	S.RESISTOR	ERJ3GEYJ 100 V (10 Ω)
C1	4030006880	S.CERAMIC	C1608 JB 1H 472K-T-A
C2	4550006080	S.TANTALUM	TEMSVB2 1C 106M-8L
C3	4030006880	S.CERAMIC	C1608 JB 1H 472K-T-A
C4	4550006080	S.TANTALUM	TEMSVB2 1C 106M-8L
C5	4030011600	S.CERAMIC	C1608 JB 1C 104KT-N
C31	4030006880	S.CERAMIC	C1608 JB 1H 472K-T-A
C32	4030006880	S.CERAMIC	C1608 JB 1H 472K-T-A
C33	4550002810	S.TANTALUM	TESVD2 1E 106M-12L
C34	4030006880	S.CERAMIC	C1608 JB 1H 472K-T-A
C35	4030006880	S.CERAMIC	C1608 JB 1H 472K-T-A
C40	4030007050	S.CERAMIC	C1608 CH 1H 220J-T-A
C41	4030007050	S.CERAMIC	C1608 CH 1H 220J-T-A
C50	4030006880	S.CERAMIC	C1608 JB 1H 472K-T-A
C51	4030007020	S.CERAMIC	C1608 CH 1H 120J-T-A
C53	4030007120	S.CERAMIC	C1608 CH 1H 820J-T-A
C54	4030006880	S.CERAMIC	C1608 JB 1H 472K-T-A
C56	4030006880	S.CERAMIC	C1608 JB 1H 472K-T-A
C58	4030007400	S.CERAMIC	C1608 PH 1H 121J-T-A
C64	4030006880	S.CERAMIC	C1608 JB 1H 472K-T-A
C65	4030011600	S.CERAMIC	C1608 JB 1C 104KT-N
C71	4030006880	S.CERAMIC	C1608 JB 1H 472K-T-A
C81	4030006880	S.CERAMIC	C1608 JB 1H 472K-T-A
C82	4030007170	S.CERAMIC	C1608 CH 1H 221J-T-A
C83	4030007050	S.CERAMIC	C1608 CH 1H 220J-T-A
C84	4030006880	S.CERAMIC	C1608 JB 1H 472K-T-A
C85	4030009510	S.CERAMIC	C1608 CH 1H 010B-T-A
C86	4030007050	S.CERAMIC	C1608 CH 1H 220J-T-A
C87	4030006880	S.CERAMIC	C1608 JB 1H 472K-T-A
C88	4030006880	S.CERAMIC	C1608 JB 1H 472K-T-A
C101	4550006080	S.TANTALUM	TEMSVB2 1C 106M-8L
C102	4030011600	S.CERAMIC	C1608 JB 1C 104KT-N
C103	4030011600	S.CERAMIC	C1608 JB 1C 104KT-N
C104	4030011600	S.CERAMIC	C1608 JB 1C 104KT-N
C105	4030011600	S.CERAMIC	C1608 JB 1C 104KT-N
C106	4030011600	S.CERAMIC	C1608 JB 1C 104KT-N
C107	4030011600	S.CERAMIC	C1608 JB 1C 104KT-N
C108	4030011600	S.CERAMIC	C1608 JB 1C 104KT-N
C109	4030011600	S.CERAMIC	C1608 JB 1C 104KT-N
C110	4030011600	S.CERAMIC	C1608 JB 1C 104KT-N
C111	4030011600	S.CERAMIC	C1608 JB 1C 104KT-N
C112	4030011600	S.CERAMIC	C1608 JB 1C 104KT-N
C113	4030011600	S.CERAMIC	C1608 JB 1C 104KT-N
C114	4030011600	S.CERAMIC	C1608 JB 1C 104KT-N
C115	4030011600	S.CERAMIC	C1608 JB 1C 104KT-N
C116	4030011600	S.CERAMIC	C1608 JB 1C 104KT-N
C117	4030011600	S.CERAMIC	C1608 JB 1C 104KT-N
C118	4030011600	S.CERAMIC	C1608 JB 1C 104KT-N
C119	4030006880	S.CERAMIC	C1608 JB 1H 472K-T-A
C120	4030011600	S.CERAMIC	C1608 JB 1C 104KT-N
C121	4550006250	S.TANTALUM	TEMSVA 1A 106M-8L
C122	4030006880	S.CERAMIC	C1608 JB 1H 472K-T-A
C123	4030006880	S.CERAMIC	C1608 JB 1H 472K-T-A
C124	4030006880	S.CERAMIC	C1608 JB 1H 472K-T-A
C125	4030006880	S.CERAMIC	C1608 JB 1H 472K-T-A
C126	4030006880	S.CERAMIC	C1608 JB 1H 472K-T-A
C127	4030006880	S.CERAMIC	C1608 JB 1H 472K-T-A
C128	4030006880	S.CERAMIC	C1608 JB 1H 472K-T-A
C129	4030006880	S.CERAMIC	C1608 JB 1H 472K-T-A
C130	4030006880	S.CERAMIC	C1608 JB 1H 472K-T-A
C131	4030012600	S.CERAMIC	C2012 JB 1A 105M-T-A
C132	4030006880	S.CERAMIC	C1608 JB 1H 472K-T-A
C133	4030006880	S.CERAMIC	C1608 JB 1H 472K-T-A
C134	4030006880	S.CERAMIC	C1608 JB 1H 472K-T-A
C137	4030006880	S.CERAMIC	C1608 JB 1H 472K-T-A
C138	4030006880	S.CERAMIC	C1608 JB 1H 472K-T-A
C139	4030006880	S.CERAMIC	C1608 JB 1H 472K-T-A
C146	4030006880	S.CERAMIC	C1608 JB 1H 472K-T-A
C147	4030006880	S.CERAMIC	C1608 JB 1H 472K-T-A
C150	4030011600	S.CERAMIC	C1608 JB 1C 104KT-N
C151	4030006880	S.CERAMIC	C1608 JB 1H 472K-T-A
C152	4030007070	S.CERAMIC	C1608 CH 1H 330J-T-A
C153	4030009910	S.CERAMIC	C1608 CH 1H 040B-T-A

[PLL UNIT]

REF NO.	ORDER NO.	DESCRIPTION	
C154	4610001850	S.TRIMMER	TZBX4R200BA110T00 20P
C155	4030016550	S.CERAMIC	CM105 CH 151G 50AT
C156	4030016550	S.CERAMIC	CM105 CH 151G 50AT
C157	4030016550	S.CERAMIC	CM105 CH 151G 50AT
C158	4550006080	S.TANTALUM	TEMSVB2 1C 106M-8L
C159	4030006880	S.CERAMIC	C1608 JB 1H 472K-T-A
C160	4030006880	S.CERAMIC	C1608 JB 1H 472K-T-A
C161	4030009920	S.CERAMIC	C1608 CH 1H 050B-T-A
C162	4030011600	S.CERAMIC	C1608 JB 1C 104KT-N
C163	4030006880	S.CERAMIC	C1608 JB 1H 472K-T-A
C172	4030006990	S.CERAMIC	C1608 CH 1H 080D-T-A
C173	4030007030	S.CERAMIC	C1608 CH 1H 150J-T-A
C174	4030007060	S.CERAMIC	C1608 CH 1H 270J-T-A
C181	4030006880	S.CERAMIC	C1608 JB 1H 472K-T-A
C182	4550006080	S.TANTALUM	TEMSVB2 1C 106M-8L
C183	4030006880	S.CERAMIC	C1608 JB 1H 472K-T-A
C191	4030011600	S.CERAMIC	C1608 JB 1C 104KT-N
C192	4030011600	S.CERAMIC	C1608 JB 1C 104KT-N
C201	4030006880	S.CERAMIC	C1608 JB 1H 472K-T-A
C202	4030009990	S.CERAMIC	C1608 CH 1H 200J-T-A
C203	4030006880	S.CERAMIC	C1608 JB 1H 472K-T-A
C204	4030011340	S.CERAMIC	C1608 CH 1H 471J-T-A
C205	4030006880	S.CERAMIC	C1608 JB 1H 472K-T-A
C206	4030009510	S.CERAMIC	C1608 CH 1H 010B-T-A
C207	4030006880	S.CERAMIC	C1608 JB 1H 472K-T-A
C208	4610001860	S.TRIMMER	TZBX4Z060BA110T00 6P
C209	4030009350	S.CERAMIC	C1608 CH 1H 3R5B-T-A
C222	4030007100	S.CERAMIC	C1608 CH 1H 560J-T-A
C223	4030006880	S.CERAMIC	C1608 JB 1H 472K-T-A
C224	4030011340	S.CERAMIC	C1608 CH 1H 471J-T-A
C225	4030006880	S.CERAMIC	C1608 JB 1H 472K-T-A
C226	4030006920	S.CERAMIC	C1608 CH 1H 010C-T-A
C227	4030006880	S.CERAMIC	C1608 JB 1H 472K-T-A
C228	4610001830	S.TRIMMER	TZBX4N100BA110T00 10P
C229	4030009920	S.CERAMIC	C1608 CH 1H 050B-T-A
C252	4030007150	S.CERAMIC	C1608 CH 1H 151J-T-A
C253	4030006900	S.CERAMIC	C1608 JB 1H 103K-T-A
C254	4030011340	S.CERAMIC	C1608 CH 1H 471J-T-A
C255	4030006880	S.CERAMIC	C1608 JB 1H 472K-T-A
C256	4030009510	S.CERAMIC	C1608 CH 1H 010B-T-A
C257	4030006880	S.CERAMIC	C1608 JB 1H 472K-T-A
C258	4610001830	S.TRIMMER	TZBX4N100BA110T00 10P
C259	4030011770	S.CERAMIC	C1608 CH 1H 060B-T-A
C272	4030007130	S.CERAMIC	C1608 CH 1H 101J-T-A
C273	4030006880	S.CERAMIC	C1608 JB 1H 472K-T-A
C274	4030011340	S.CERAMIC	C1608 CH 1H 471J-T-A
C275	4030006880	S.CERAMIC	C1608 JB 1H 472K-T-A
C276	4030009510	S.CERAMIC	C1608 CH 1H 010B-T-A
C277	4030006880	S.CERAMIC	C1608 JB 1H 472K-T-A
C278	4610001830	S.TRIMMER	TZBX4N100BA110T00 10P
C279	4030007020	S.CERAMIC	C1608 CH 1H 120J-T-A
C301	4030006880	S.CERAMIC	C1608 JB 1H 472K-T-A
C302	4030007080	S.CERAMIC	C1608 CH 1H 390J-T-A
C304	4030007080	S.CERAMIC	C1608 CH 1H 390J-T-A
C305	4030006980	S.CERAMIC	C1608 CH 1H 070D-T-A
C306	4030007080	S.CERAMIC	C1608 CH 1H 390J-T-A
C307	4030007020	S.CERAMIC	C1608 CH 1H 120J-T-A
C309	4030006880	S.CERAMIC	C1608 JB 1H 472K-T-A
C310	4030006880	S.CERAMIC	C1608 JB 1H 472K-T-A
C311	4030006880	S.CERAMIC	C1608 JB 1H 472K-T-A
C320	4030007080	S.CERAMIC	C1608 CH 1H 390J-T-A
C321	4030007120	S.CERAMIC	C1608 CH 1H 820J-T-A
C322	4030006880	S.CERAMIC	C1608 JB 1H 472K-T-A
C323	4030006880	S.CERAMIC	C1608 JB 1H 472K-T-A
C324	4030006880	S.CERAMIC	C1608 JB 1H 472K-T-A
C325	4030011810	S.CERAMIC	C1608 JB 1A 224K-T-N
C326	4030011600	S.CERAMIC	C1608 JB 1C 104KT-N
C344	4030006880	S.CERAMIC	C1608 JB 1H 472K-T-A
C345	4030006880	S.CERAMIC	C1608 JB 1H 472K-T-A
C350	4030006880	S.CERAMIC	C1608 JB 1H 472K-T-A
C351	4030008560	S.CERAMIC	C1608 CH 1H 300J-T-A
C352	4030009530	S.CERAMIC	C1608 CH 1H 030B-T-A
C353	4030007070	S.CERAMIC	C1608 CH 1H 330J-T-A
C354	4030009520	S.CERAMIC	C1608 CH 1H 020B-T-A
C355	4030007010	S.CERAMIC	C1608 CH 1H 100D-T-A
C356	4030007050	S.CERAMIC	C1608 CH 1H 220J-T-A
C357	4030006880	S.CERAMIC	C1608 JB 1H 472K-T-A
C358	4030007100	S.CERAMIC	C1608 CH 1H 560J-T-A
C359	4030011280	S.CERAMIC	C1608 CH 1H 271J-T-A
C360	4030007100	S.CERAMIC	C1608 CH 1H 560J-T-A
C361	4030006880	S.CERAMIC	C1608 JB 1H 472K-T-A
C362	4030006880	S.CERAMIC	C1608 JB 1H 472K-T-A

S.=Surface mount

[PLL UNIT]

REF NO.	ORDER NO.	DESCRIPTION
C363	4030006880	S.CERAMIC C1608 JB 1H 472K-T-A
C364	4030006880	S.CERAMIC C1608 JB 1H 472K-T-A
C365	4030011600	S.CERAMIC C1608 JB 1C 104KT-N
C380	4550003220	S.TANTALUM TEMSVA 1E 105M-8L
C381	4030006880	S.CERAMIC C1608 JB 1H 472K-T-A
C382	4030007130	S.CERAMIC C1608 CH 1H 101J-T-A
C384	4030011600	S.CERAMIC C1608 JB 1C 104KT-N
C385	4550006080	S.TANTALUM TEMSVB2 1C 106M-8L
C386	4550005980	S.TANTALUM TEMSVA 1A 475M-8L
C387	4030006880	S.CERAMIC C1608 JB 1H 472K-T-A
C389	4030011340	S.CERAMIC C1608 CH 1H 471J-T-A
C390	4550006080	S.TANTALUM TEMSVB2 1C 106M-8L
C391	4030011600	S.CERAMIC C1608 JB 1C 104KT-N
C392	4030006880	S.CERAMIC C1608 JB 1H 472K-T-A
C393	4030006880	S.CERAMIC C1608 JB 1H 472K-T-A
C394	4030006850	S.CERAMIC C1608 JB 1H 471K-T-A
C395	4030006900	S.CERAMIC C1608 JB 1E 103K-T-A
C396	4550006480	S.TANTALUM TEMSVA 1C 475M-8L
C397	4030006880	S.CERAMIC C1608 JB 1H 472K-T-A
C401	4550006080	S.TANTALUM TEMSVB2 1C 106M-8L
C402	4030011600	S.CERAMIC C1608 JB 1C 104KT-N
C403	4030011600	S.CERAMIC C1608 JB 1C 104KT-N
C404	4030011600	S.CERAMIC C1608 JB 1C 104KT-N
C405	4030011600	S.CERAMIC C1608 JB 1C 104KT-N
C406	4030011600	S.CERAMIC C1608 JB 1C 104KT-N
C407	4030011600	S.CERAMIC C1608 JB 1C 104KT-N
C408	4030011600	S.CERAMIC C1608 JB 1C 104KT-N
C409	4030011600	S.CERAMIC C1608 JB 1C 104KT-N
C410	4030011600	S.CERAMIC C1608 JB 1C 104KT-N
C411	4030011600	S.CERAMIC C1608 JB 1C 104KT-N
C412	4030011600	S.CERAMIC C1608 JB 1C 104KT-N
C413	4030011600	S.CERAMIC C1608 JB 1C 104KT-N
C414	4030011600	S.CERAMIC C1608 JB 1C 104KT-N
C415	4030011600	S.CERAMIC C1608 JB 1C 104KT-N
C416	4030011600	S.CERAMIC C1608 JB 1C 104KT-N
C417	4030011600	S.CERAMIC C1608 JB 1C 104KT-N
C418	4030011600	S.CERAMIC C1608 JB 1C 104KT-N
C419	4030006880	S.CERAMIC C1608 JB 1H 472K-T-A
C420	4030011600	S.CERAMIC C1608 JB 1C 104KT-N
C421	4550006250	S.TANTALUM TEMSVA 1A 106M-8L
C422	4030006880	S.CERAMIC C1608 JB 1H 472K-T-A
C423	4030006880	S.CERAMIC C1608 JB 1H 472K-T-A
C424	4030006880	S.CERAMIC C1608 JB 1H 472K-T-A
C425	4030006880	S.CERAMIC C1608 JB 1H 472K-T-A
C426	4030006880	S.CERAMIC C1608 JB 1H 472K-T-A
C427	4030006880	S.CERAMIC C1608 JB 1H 472K-T-A
C428	4030006880	S.CERAMIC C1608 JB 1H 472K-T-A
C431	4030012600	S.CERAMIC C2012 JB 1A 105M-T-A
C437	4030006880	S.CERAMIC C1608 JB 1H 472K-T-A
C438	4030006880	S.CERAMIC C1608 JB 1H 472K-T-A
C439	4030006880	S.CERAMIC C1608 JB 1H 472K-T-A
C447	4030006880	S.CERAMIC C1608 JB 1H 472K-T-A
C450	4030011600	S.CERAMIC C1608 JB 1C 104KT-N
C451	4030006880	S.CERAMIC C1608 JB 1H 472K-T-A
C452	4030007070	S.CERAMIC C1608 CH 1H 330J-T-A
C453	4030009910	S.CERAMIC C1608 CH 1H 040B-T-A
C454	4610001850	S.TRIMMER TZBX4R200BA110T00 20P
C455	4030016550	S.CERAMIC CM105 CH 151G 50AT
C456	4030016550	S.CERAMIC CM105 CH 151G 50AT
C457	4030016550	S.CERAMIC CM105 CH 151G 50AT
C458	4550006080	S.TANTALUM TEMSVB2 1C 106M-8L
C459	4030006880	S.CERAMIC C1608 JB 1H 472K-T-A
C460	4030006880	S.CERAMIC C1608 JB 1H 472K-T-A
C461	4030009920	S.CERAMIC C1608 CH 1H 050B-T-A
C462	4030011600	S.CERAMIC C1608 JB 1C 104KT-N
C463	4030006880	S.CERAMIC C1608 JB 1H 472K-T-A
C472	4030006990	S.CERAMIC C1608 CH 1H 080D-T-A
C473	4030007030	S.CERAMIC C1608 CH 1H 150J-T-A
C474	4030007060	S.CERAMIC C1608 CH 1H 270J-T-A
C481	4030006880	S.CERAMIC C1608 JB 1H 472K-T-A
C482	4550006080	S.TANTALUM TEMSVB2 1C 106M-8L
C483	4030006880	S.CERAMIC C1608 JB 1H 472K-T-A
C491	4030006850	S.CERAMIC C1608 JB 1H 471K-T-A
C492	4030007130	S.CERAMIC C1608 CH 1H 101J-T-A
C493	4030009580	S.CERAMIC C1608 JB 1H 681K-T-A
C494	4030007080	S.CERAMIC C1608 CH 1H 390J-T-A
C495	4030006850	S.CERAMIC C1608 JB 1H 471K-T-A
C501	4030006880	S.CERAMIC C1608 JB 1H 472K-T-A
C502	4030009990	S.CERAMIC C1608 CH 1H 200J-T-A
C503	4030006880	S.CERAMIC C1608 JB 1H 472K-T-A
C504	4030011340	S.CERAMIC C1608 CH 1H 471J-T-A
C505	4030006880	S.CERAMIC C1608 JB 1H 472K-T-A

[PLL UNIT]

REF NO.	ORDER NO.	DESCRIPTION
C506	4030009510	S.CERAMIC C1608 CH 1H 010B-T-A
C507	4030006880	S.CERAMIC C1608 JB 1H 472K-T-A
C508	4610001860	S.TRIMMER TZBX4Z060BA110T00 6P
C509	4030009350	S.CERAMIC C1608 CH 1H 3R5B-T-A
C522	4030007100	S.CERAMIC C1608 CH 1H 560J-T-A
C523	4030006880	S.CERAMIC C1608 JB 1H 472K-T-A
C524	4030011340	S.CERAMIC C1608 CH 1H 471J-T-A
C525	4030006880	S.CERAMIC C1608 JB 1H 472K-T-A
C526	4030009510	S.CERAMIC C1608 CH 1H 010B-T-A
C527	4030006880	S.CERAMIC C1608 JB 1H 472K-T-A
C528	4610001830	S.TRIMMER TZBX4N100BA110T00 10P
C529	4030009920	S.CERAMIC C1608 CH 1H 050B-T-A
C552	4030007150	S.CERAMIC C1608 CH 1H 151J-T-A
C553	4030006900	S.CERAMIC C1608 JB 1H 103K-T-A
C554	4030011340	S.CERAMIC C1608 CH 1H 471J-T-A
C555	4030006880	S.CERAMIC C1608 JB 1H 472K-T-A
C556	4030009510	S.CERAMIC C1608 CH 1H 010B-T-A
C557	4030006880	S.CERAMIC C1608 JB 1H 472K-T-A
C558	4610001830	S.TRIMMER TZBX4N100BA110T00 10P
C559	4030011770	S.CERAMIC C1608 CH 1H 060B-T-A
C572	4030007130	S.CERAMIC C1608 CH 1H 101J-T-A
C573	4030006880	S.CERAMIC C1608 JB 1H 472K-T-A
C574	4030011340	S.CERAMIC C1608 CH 1H 471J-T-A
C575	4030006880	S.CERAMIC C1608 JB 1H 472K-T-A
C576	4030009510	S.CERAMIC C1608 CH 1H 010B-T-A
C577	4030006880	S.CERAMIC C1608 JB 1H 472K-T-A
C578	4610001830	S.TRIMMER TZBX4N100BA110T00 10P
C579	4030007020	S.CERAMIC C1608 CH 1H 120J-T-A
C601	4030006880	S.CERAMIC C1608 JB 1H 472K-T-A
C602	4030007080	S.CERAMIC C1608 CH 1H 390J-T-A
C604	4030007080	S.CERAMIC C1608 CH 1H 390J-T-A
C605	4030006980	S.CERAMIC C1608 CH 1H 070D-T-A
C606	4030007080	S.CERAMIC C1608 CH 1H 390J-T-A
C607	4030007020	S.CERAMIC C1608 CH 1H 120J-T-A
C609	4030006880	S.CERAMIC C1608 JB 1H 472K-T-A
C610	4030006880	S.CERAMIC C1608 JB 1H 472K-T-A
C611	4030006880	S.CERAMIC C1608 JB 1H 472K-T-A
C620	4030007080	S.CERAMIC C1608 CH 1H 390J-T-A
C621	4030007120	S.CERAMIC C1608 CH 1H 820J-T-A
C622	4030006880	S.CERAMIC C1608 JB 1H 472K-T-A
C623	4030006880	S.CERAMIC C1608 JB 1H 472K-T-A
C624	4030006880	S.CERAMIC C1608 JB 1H 472K-T-A
C625	4030011810	S.CERAMIC C1608 JB 1A 224K-T-N
C626	4030011600	S.CERAMIC C1608 JB 1C 104KT-N
C644	4030006880	S.CERAMIC C1608 JB 1H 472K-T-A
C645	4030006880	S.CERAMIC C1608 JB 1H 472K-T-A
C650	4030006880	S.CERAMIC C1608 JB 1H 472K-T-A
C651	4030008560	S.CERAMIC C1608 CH 1H 300J-T-A
C652	4030009530	S.CERAMIC C1608 CH 1H 030B-T-A
C653	4030007070	S.CERAMIC C1608 CH 1H 330J-T-A
C654	4030009520	S.CERAMIC C1608 CH 1H 020B-T-A
C655	4030007010	S.CERAMIC C1608 CH 1H 100D-T-A
C656	4030007050	S.CERAMIC C1608 CH 1H 220J-T-A
C657	4030006880	S.CERAMIC C1608 JB 1H 472K-T-A
C658	4030007100	S.CERAMIC C1608 CH 1H 560J-T-A
C659	4030011280	S.CERAMIC C1608 CH 1H 271J-T-A
C660	4030007100	S.CERAMIC C1608 CH 1H 560J-T-A
C661	4030006880	S.CERAMIC C1608 JB 1H 472K-T-A
C662	4030006880	S.CERAMIC C1608 JB 1H 472K-T-A
C663	4030006880	S.CERAMIC C1608 JB 1H 472K-T-A
C664	4030006880	S.CERAMIC C1608 JB 1H 472K-T-A
C665	4030011600	S.CERAMIC C1608 JB 1C 104KT-N
C680	4550003220	S.TANTALUM TEMSVA 1E 105M-8L
C681	4030006880	S.CERAMIC C1608 JB 1H 472K-T-A
C682	4030007130	S.CERAMIC C1608 CH 1H 101J-T-A
C684	4030011600	S.CERAMIC C1608 JB 1C 104KT-N
C685	4550006080	S.TANTALUM TEMSVB2 1C 106M-8L
C686	4550005980	S.TANTALUM TEMSVA 1A 475M-8L
C689	4030011340	S.CERAMIC C1608 CH 1H 471J-T-A
C690	4550006080	S.TANTALUM TEMSVB2 1C 106M-8L
C691	4030011600	S.CERAMIC C1608 JB 1C 104KT-N
C694	4030011340	S.CERAMIC C1608 CH 1H 471J-T-A
C695	4030006900	S.CERAMIC C1608 JB 1E 103K-T-A
C696	4550006480	S.TANTALUM TEMSVA 1C 475M-8L
C697	4030006880	S.CERAMIC C1608 JB 1H 472K-T-A
C701	4550006080	S.TANTALUM TEMSVB2 1C 106M-8L
C702	4030011600	S.CERAMIC C1608 JB 1C 104KT-N
C703	4030011600	S.CERAMIC C1608 JB 1C 104KT-N
C704	4030011600	S.CERAMIC C1608 JB 1C 104KT-N
C705	4030011600	S.CERAMIC C1608 JB 1C 104KT-N
C706	4030011600	S.CERAMIC C1608 JB 1C 104KT-N
C707	4030011600	S.CERAMIC C1608 JB 1C 104KT-N

S.=Surface mount

[PLL UNIT]

REF NO.	ORDER NO.	DESCRIPTION	
C708	4030006880	S.CERAMIC	C1608 JB 1H 472K-T-A
C709	4030011340	S.CERAMIC	C1608 CH 1H 471J-T-A
C710	4030007120	S.CERAMIC	C1608 CH 1H 820J-T-A
C711	4030009580	S.CERAMIC	C1608 JB 1H 681K-T-A
C712	4030007070	S.CERAMIC	C1608 CH 1H 330J-T-A
C713	4030010040	S.CERAMIC	C1608 JB 1H 561K-T-A
C714	4030011280	S.CERAMIC	C1608 CH 1H 271J-T-A
C715	4030006860	S.CERAMIC	C1608 JB 1H 102K-T-A
C716	4030011280	S.CERAMIC	C1608 CH 1H 271J-T-A
C801	4550006080	S.TANTALUM	TEMSVB2 1C 106M-8L
C802	4030011600	S.CERAMIC	C1608 JB 1C 104KT-N
C803	4030011600	S.CERAMIC	C1608 JB 1C 104KT-N
C804	4030011600	S.CERAMIC	C1608 JB 1C 104KT-N
C805	4030011600	S.CERAMIC	C1608 JB 1C 104KT-N
C806	4030011600	S.CERAMIC	C1608 JB 1C 104KT-N
C807	4030011600	S.CERAMIC	C1608 JB 1C 104KT-N
C808	4030006880	S.CERAMIC	C1608 JB 1H 472K-T-A
C809	4030007030	S.CERAMIC	C1608 CH 1H 150J-T-A
C810	4030006970	S.CERAMIC	C1608 CH 1H 060D-T-A
C811	4030007060	S.CERAMIC	C1608 CH 1H 270J-T-A
C812	4030009520	S.CERAMIC	C1608 CH 1H 020B-T-A
C813	4030007040	S.CERAMIC	C1608 CH 1H 180J-T-A
C814	4030007040	S.CERAMIC	C1608 CH 1H 180J-T-A
C815	4030007090	S.CERAMIC	C1608 CH 1H 470J-T-A
C816	4030007040	S.CERAMIC	C1608 CH 1H 180J-T-A
C817	4030006880	S.CERAMIC	C1608 JB 1H 472K-T-A
C818	4030006880	S.CERAMIC	C1608 JB 1H 472K-T-A
C826	4030011280	S.CERAMIC	C1608 CH 1H 271J-T-A
C827	4030011280	S.CERAMIC	C1608 CH 1H 271J-T-A
C901	4030006880	S.CERAMIC	C1608 JB 1H 472K-T-A
C902	4550006080	S.TANTALUM	TEMSVB2 1C 106M-8L
C903	4030007130	S.CERAMIC	C1608 CH 1H 101J-T-A
C905	4030009580	S.CERAMIC	C1608 JB 1H 681K-T-A
C906	4030011280	S.CERAMIC	C1608 CH 1H 271J-T-A
C907	4030011280	S.CERAMIC	C1608 CH 1H 271J-T-A
C908	4030011600	S.CERAMIC	C1608 JB 1C 104KT-N
C910	4030012600	S.CERAMIC	C2012 JB 1A 105M-T-A
C911	4030011600	S.CERAMIC	C1608 JB 1C 104KT-N
C912	4030010750	S.CERAMIC	C1608 CH 1H 201J-T-A
C913	4030007170	S.CERAMIC	C1608 CH 1H 221J-T-A
C914	4030007020	S.CERAMIC	C1608 CH 1H 120J-T-A
C915	4030008880	S.CERAMIC	C1608 JB 1C 223K-T-A
C916	4030007110	S.CERAMIC	C1608 CH 1H 680J-T-A
C917	4030007020	S.CERAMIC	C1608 CH 1H 120J-T-A
C918	4030007020	S.CERAMIC	C1608 CH 1H 120J-T-A
C919	4030009910	S.CERAMIC	C1608 CH 1H 040B-T-A
C920	4030006880	S.CERAMIC	C1608 JB 1H 472K-T-A
C921	4030006880	S.CERAMIC	C1608 JB 1H 472K-T-A
C922	4550006080	S.TANTALUM	TEMSVB2 1C 106M-8L
C923	4030006880	S.CERAMIC	C1608 JB 1H 472K-T-A
C924	4030006880	S.CERAMIC	C1608 JB 1H 472K-T-A
C925	4030006880	S.CERAMIC	C1608 JB 1H 472K-T-A
C926	4030007170	S.CERAMIC	C1608 CH 1H 221J-T-A
C927	4030006860	S.CERAMIC	C1608 JB 1H 102K-T-A
C928	4030007100	S.CERAMIC	C1608 CH 1H 560J-T-A
C929	4030009910	S.CERAMIC	C1608 CH 1H 040B-T-A
C930	4030007130	S.CERAMIC	C1608 CH 1H 101J-T-A
C931	4030007020	S.CERAMIC	C1608 CH 1H 120J-T-A
C932	4030007100	S.CERAMIC	C1608 CH 1H 560J-T-A
C934	4030011600	S.CERAMIC	C1608 JB 1C 104KT-N
C935	4030006880	S.CERAMIC	C1608 JB 1H 472K-T-A
C936	4550006080	S.TANTALUM	TEMSVB2 1C 106M-8L
J1	6510022610	S.CONNECTOR	16FMN-BMTTR-A-TBT
W1	7030003860	S.JUMPER	ERJ3GE JPW V
W2	7030003860	S.JUMPER	ERJ3GE JPW V
W6	7030003860	S.JUMPER	ERJ3GE JPW V
W10	7030003860	S.JUMPER	ERJ3GE JPW V
W25	7030003860	S.JUMPER	ERJ3GE JPW V
W28	7030003860	S.JUMPER	ERJ3GE JPW V
W29	7030003860	S.JUMPER	ERJ3GE JPW V
W32	7030003860	S.JUMPER	ERJ3GE JPW V
W33	7030003860	S.JUMPER	ERJ3GE JPW V
W51	7030003860	S.JUMPER	ERJ3GE JPW V
W92	7030003860	S.JUMPER	ERJ3GE JPW V
W121	7030003860	S.JUMPER	ERJ3GE JPW V
W122	7030003860	S.JUMPER	ERJ3GE JPW V
W151	7030008240	S.JUMPER	ERJ12YJ0R00U
W155	7030003860	S.JUMPER	ERJ3GE JPW V

[PLL UNIT]

REF NO.	ORDER NO.	DESCRIPTION	
W170	7030008240	S.JUMPER	ERJ12YJ0R00U
W181	7030003860	S.JUMPER	ERJ3GE JPW V
W201	7030003970	S.JUMPER	MCR18EZJH JPW
W202	7030008240	S.JUMPER	ERJ12YJ0R00U
W221	7030000010	S.JUMPER	MCR10EZJH JPW (000)
W222	7030008240	S.JUMPER	ERJ12YJ0R00U
W251	7030000010	S.JUMPER	MCR10EZJH JPW (000)
W252	7030008240	S.JUMPER	ERJ12YJ0R00U
W381	7030008240	S.JUMPER	ERJ12YJ0R00U
W382	7030008240	S.JUMPER	ERJ12YJ0R00U
W385	7030003860	S.JUMPER	ERJ3GE JPW V
W392	7030003860	S.JUMPER	ERJ3GE JPW V
W422	7030003860	S.JUMPER	ERJ3GE JPW V
W451	7030008240	S.JUMPER	ERJ12YJ0R00U
W452	7030008240	S.JUMPER	ERJ12YJ0R00U
W455	7030003860	S.JUMPER	ERJ3GE JPW V
W481	7030003860	S.JUMPER	ERJ3GE JPW V
W521	7030000010	S.JUMPER	MCR10EZJH JPW (000)
W522	7030008240	S.JUMPER	ERJ12YJ0R00U
W551	7030000010	S.JUMPER	MCR10EZJH JPW (000)
W552	7030008240	S.JUMPER	ERJ12YJ0R00U
W571	7030003970	S.JUMPER	MCR18EZJH JPW
W572	7030008240	S.JUMPER	ERJ12YJ0R00U
W692	7030003860	S.JUMPER	ERJ3GE JPW V
W821	7030003860	S.JUMPER	ERJ3GE JPW V
W951	7030000010	S.JUMPER	MCR10EZJH JPW (000)
W952	7030000010	S.JUMPER	MCR10EZJH JPW (000)
W963	7030003860	S.JUMPER	ERJ3GE JPW V
W964	7030003860	S.JUMPER	ERJ3GE JPW V
W965	7030003860	S.JUMPER	ERJ3GE JPW V
W966	7030003860	S.JUMPER	ERJ3GE JPW V
WS1	8970023450	CABLE	SX2178 1.5D COAXIAL TUBE (1)/PL
WS2	8970023461	CABLE	SX2178 1.5D COAXIAL TUBE (2)/PL
WS3	8970023471	CABLE	SX2178 1.5D COAXIAL TUBE (3)/PL
WS7	8970023480	CABLE	SX2178 1.5D COAXIAL TUBE (1)/PL
EP1	0910051798	PCB	B 5241H
EP151	6910012350	S.BEAD	MMZ1608Y 102BT
EP321	6910012350	S.BEAD	MMZ1608Y 102BT
EP451	6910012350	S.BEAD	MMZ1608Y 102BT
EP621	6910012350	S.BEAD	MMZ1608Y 102BT

[PA UNIT]

REF NO.	ORDER NO.	DESCRIPTION	
IC1	1180001070	S.IC	TA7805F (TE16L)
IC2	1110002020	IC	TA7805S
IC3	1180001980	IC	MC78T08CT
Q1	1530000790	TRANSISTOR	2SC1971
Q2	1530000800	TRANSISTOR	2SC1972
Q3	1530000800	TRANSISTOR	2SC1972
Q4	1530003740	TRANSISTOR	2SC5125
Q5	1530003740	TRANSISTOR	2SC5125
Q8	1540000500	TRANSISTOR	2SD1585K
Q9	1590001150	S.TRANSISTOR	UN9211 (TX)
Q10	1530002060	S.TRANSISTOR	2SC4081 T107 R
Q11	1530002060	S.TRANSISTOR	2SC4081 T107 R
Q12	1520000650	S.TRANSISTOR	2SB1201-S-TL
Q13	1520000650	S.TRANSISTOR	2SB1201-S-TL
D1	1790000710	VARISTOR	MA29B
D2	1790000710	VARISTOR	MA29B
D3	1790000710	VARISTOR	MA29B
D4	1790000700	DIODE	DSA3A1
D5	1790000700	DIODE	DSA3A1
D7	1160000140	S.DIODE	DAP222 TL
D8	1790000700	DIODE	DSA3A1
D10	1710000970	DIODE	MA185
D61	1750000520	S.DIODE	DAN222TL

S.=Surface mount

[PA UNIT]

REF NO.	ORDER NO.	DESCRIPTION	
L1	6140003240	S.COIL	LR-361
L2	2040000490	COIL	EXC-ELDR25C
L3	2040000490	COIL	EXC-ELDR25C
L4	6140001180	COIL	LR-143
L5	2040000490	COIL	EXC-ELDR25C
L6	6140003510	COIL	LR-393
L7	6140000610	COIL	LR-83
L8	6140002030	COIL	LR-230 (SK-10M-15Y 120)
L9	2040000490	COIL	EXC-ELDR25C
L10	2040000490	COIL	EXC-ELDR25C
L12	2040000490	COIL	EXC-ELDR25C
L14	6140003230	S.COIL	LR-360
L21	6110001730	COIL	LA-262
L22	2040000490	COIL	EXC-ELDR25C
R1	7030003380	S.RESISTOR	ERJ3GEYJ 331 V (330 Ω)
R2	7030003230	S.RESISTOR	ERJ3GEYJ 180 V (18 Ω)
R3	7030003380	S.RESISTOR	ERJ3GEYJ 331 V (330 Ω)
R4	7030003360	S.RESISTOR	ERJ3GEYJ 221 V (220 Ω)
R5	7030003390	S.RESISTOR	ERJ3GEYJ 391 V (390 Ω)
R6	7030003360	S.RESISTOR	ERJ3GEYJ 221 V (220 Ω)
R7	7030006210	S.RESISTOR	ERJ12YJ4R7U (4.7 Ω)
R8	7030008230	S.RESISTOR	ERJ1WYJ1R0U (1 Ω)
R9	7030008230	S.RESISTOR	ERJ1WYJ1R0U (1 Ω)
R10	7030003420	S.RESISTOR	ERJ3GEYJ 681 V (680 Ω)
R11	7310004740	TRIMMER	EVM-2AGA00 B52 (501)
R12	7030003300	S.RESISTOR	ERJ3GEYJ 680 V (68 Ω)
R13	7030000220	S.RESISTOR	MCR10EZJH 47 Ω (470)
R14	7030000220	S.RESISTOR	MCR10EZJH 47 Ω (470)
R15	70300006180	S.RESISTOR	ERJ1WYJ101U (100 Ω)
R16	70300006180	S.RESISTOR	ERJ1WYJ101U (100 Ω)
R17	70300006130	S.RESISTOR	ERJ1WYJ100U (10 Ω)
R18	7310004710	TRIMMER	EVM-2AGA00 B23 (202)
R19	7030003400	S.RESISTOR	ERJ3GEYJ 471 V (470 Ω)
R20	70300006130	S.RESISTOR	ERJ1WYJ100U (10 Ω)
R21	70300006130	S.RESISTOR	ERJ1WYJ100U (10 Ω)
R23	70300006130	S.RESISTOR	ERJ1WYJ100U (10 Ω)
R24	70300006130	S.RESISTOR	ERJ1WYJ100U (10 Ω)
R26	70300006060	S.RESISTOR	ERJ12YJ100U (10 Ω)
R27	70300006060	S.RESISTOR	ERJ12YJ100U (10 Ω)
R28	7100000640	RESISTOR	5 SI 0.012 Ω (J)
R29	7030003440	S.RESISTOR	ERJ3GEYJ 102 V (1 kΩ)
R31	7030003440	S.RESISTOR	ERJ3GEYJ 102 V (1 kΩ)
R32	7030007630	S.RESISTOR	MCR100JZHJ 0.68 Ω (R68)
R33	7030007630	S.RESISTOR	MCR100JZHJ 0.68 Ω (R68)
R34	7030007630	S.RESISTOR	MCR100JZHJ 0.68 Ω (R68)
R35	7030007630	S.RESISTOR	MCR100JZHJ 0.68 Ω (R68)
R38	70300006120	S.RESISTOR	ERJ1WYJ4R7U (4.7 Ω)
R39	70300006120	S.RESISTOR	ERJ1WYJ4R7U (4.7 Ω)
R40	70300006120	S.RESISTOR	ERJ1WYJ4R7U (4.7 Ω)
R41	70300009570	S.RESISTOR	ERJ1WYJ5R6U (5.6 Ω)
R42	70300009570	S.RESISTOR	ERJ1WYJ5R6U (5.6 Ω)
R44	7070000681	RESISTOR	ERX3SJ 3R9 (3.9 Ω)
R45	7030005340	S.RESISTOR	RR0816P-332-D (3.3 kΩ)
R46	7030008070	S.RESISTOR	RR0816P-273-D (27 kΩ)
R47	7030005980	S.RESISTOR	RR0816P-333-D (33 kΩ)
R48	7030008060	S.RESISTOR	RR0816P-222-D (2.2 kΩ)
R49	7030003440	S.RESISTOR	ERJ3GEYJ 102 V (1 kΩ)
R50	7510000070	THERMISTOR	ERT-D2FHL 503S
R51	70300006140	S.RESISTOR	ERJ1WYJ560U (56 Ω)
R52	70300006060	S.RESISTOR	ERJ12YJ100U (10 Ω)
R53	7030003440	S.RESISTOR	ERJ3GEYJ 102 V (1 kΩ)
R54	7030003440	S.RESISTOR	ERJ3GEYJ 102 V (1 kΩ)
R55	7030003560	S.RESISTOR	ERJ3GEYJ 103 V (10 kΩ)
R56	7030003560	S.RESISTOR	ERJ3GEYJ 103 V (10 kΩ)
R57	7030006270	S.RESISTOR	ERJ12YJ221U (220 Ω)
R58	7030003360	S.RESISTOR	ERJ3GEYJ 221 V (220 Ω)
C1	4030011600	S.CERAMIC	C1608 JB 1C 104KT-N
C2	4030006860	S.CERAMIC	C1608 JB 1H 102K-T-A
C3	4030011600	S.CERAMIC	C1608 JB 1C 104KT-N
C4	4030006860	S.CERAMIC	C1608 JB 1H 102K-T-A
C5	4030011600	S.CERAMIC	C1608 JB 1C 104KT-N
C6	4030006860	S.CERAMIC	C1608 JB 1H 102K-T-A
C7	4030006880	S.CERAMIC	C1608 JB 1H 472K-T-A
C8	4510004640	S.ELECTROLYTIC	ECEV1CA470SP
C9	4030011600	S.CERAMIC	C1608 JB 1C 104KT-N
C10	4030005010	S.CERAMIC	C2012 CH 1H 151J-T-A
C11	4030012490	S.CERAMIC	GRM42-6 SL 472J 100PT
C12	4030012490	S.CERAMIC	GRM42-6 SL 472J 100PT
C14	4030011600	S.CERAMIC	C1608 JB 1C 104KT-N
C15	4030011600	S.CERAMIC	C1608 JB 1C 104KT-N

[PA UNIT]

REF NO.	ORDER NO.	DESCRIPTION	
C16	4510004630	S.ELECTROLYTIC	ECEV1CA100SR
C17	4030008920	S.CERAMIC	C1608 JB 1C 473K-T-A
C18	4030008920	S.CERAMIC	C1608 JB 1C 473K-T-A
C20	4030011600	S.CERAMIC	C1608 JB 1C 104KT-N
C21	4030012620	S.CERAMIC	GRM44-1 CH 102J 500PT
C22	4030012620	S.CERAMIC	GRM44-1 CH 102J 500PT
C23	4030012620	S.CERAMIC	GRM44-1 CH 102J 500PT
C24	4030012620	S.CERAMIC	GRM44-1 CH 102J 500PT
C25	4030011740	S.CERAMIC	GRM42-2 CH 201J 500PT
C27	4030008920	S.CERAMIC	C1608 JB 1C 473K-T-A
C30	4030004760	S.CERAMIC	C2012 JF 1E 104Z-T-A
C33	4030006880	S.CERAMIC	C1608 JB 1H 472K-T-A
C34	4030006880	S.CERAMIC	C1608 JB 1H 472K-T-A
C35	4030005110	S.CERAMIC	C2012 JB 1E 473K-T-A
C36	4510004600	ELECTROLYTIC	16 MV 1000 HC
C37	4030011600	S.CERAMIC	C1608 JB 1C 104KT-N
C39	4510004600	ELECTROLYTIC	16 MV 1000 HC
C40	4510004600	ELECTROLYTIC	16 MV 1000 HC
C41	4030006860	S.CERAMIC	C1608 JB 1H 102K-T-A
C42	4030011600	S.CERAMIC	C1608 JB 1C 104KT-N
C57	4030011740	S.CERAMIC	GRM42-2 CH 201J 500PT
C58	4030016740	S.CERAMIC	GRH111 CH 102J 50PT
C59	4030011740	S.CERAMIC	GRM42-2 CH 201J 500PT
C60	4030011740	S.CERAMIC	GRM42-2 CH 201J 500PT
C61	4030012620	S.CERAMIC	GRM44-1 CH 102J 500PT
C62	4030012620	S.CERAMIC	GRM44-1 CH 102J 500PT
C71	4030011600	S.CERAMIC	C1608 JB 1C 104KT-N
C72	4030011600	S.CERAMIC	C1608 JB 1C 104KT-N
C73	4510004630	S.ELECTROLYTIC	ECEV1CA100SR
C74	4510004630	S.ELECTROLYTIC	ECEV1CA100SR
C75	4030011600	S.CERAMIC	C1608 JB 1C 104KT-N
C76	4030011600	S.CERAMIC	C1608 JB 1C 104KT-N
C77	4510006220	S.ELECTROLYTIC	ECEV1CA101UP
C78	4510006220	S.ELECTROLYTIC	ECEV1CA101UP
C79	4030011600	S.CERAMIC	C1608 JB 1C 104KT-N
C80	4030011600	S.CERAMIC	C1608 JB 1C 104KT-N
C81	4510004630	S.ELECTROLYTIC	ECEV1CA100SR
C82	4510004630	S.ELECTROLYTIC	ECEV1CA100SR
C89	4030011600	S.CERAMIC	C1608 JB 1C 104KT-N
C93	4030011600	S.CERAMIC	C1608 JB 1C 104KT-N
C94	4030006880	S.CERAMIC	C1608 JB 1H 472K-T-A
C95	4030006880	S.CERAMIC	C1608 JB 1H 472K-T-A
C96	4510005000	ELECTROLYTIC	16 MV 220 HC
C97	4030006880	S.CERAMIC	C1608 JB 1H 472K-T-A
C99	4510004590	ELECTROLYTIC	16 MV 470 HC
C100	4030006880	S.CERAMIC	C1608 JB 1H 472K-T-A
C101	4030006880	S.CERAMIC	C1608 JB 1H 472K-T-A
C102	4030006880	S.CERAMIC	C1608 JB 1H 472K-T-A
C103	4510004630	S.ELECTROLYTIC	ECEV1CA100SR
C105	4510006220	S.ELECTROLYTIC	ECEV1CA101UP
C107	4030006880	S.CERAMIC	C1608 JB 1H 472K-T-A
C108	4030006880	S.CERAMIC	C1608 JB 1H 472K-T-A
C109	4030006880	S.CERAMIC	C1608 JB 1H 472K-T-A
C110	4030006880	S.CERAMIC	C1608 JB 1H 472K-T-A
C111	4030006880	S.CERAMIC	C1608 JB 1H 472K-T-A
C112	4030006880	S.CERAMIC	C1608 JB 1H 472K-T-A
C113	4030006880	S.CERAMIC	C1608 JB 1H 472K-T-A
C114	4030006880	S.CERAMIC	C1608 JB 1H 472K-T-A
C115	4030006880	S.CERAMIC	C1608 JB 1H 472K-T-A
C116	4030011730	S.CERAMIC	GRM42-6 CH 101J 500PT
C117	4030007090	S.CERAMIC	C1608 CH 1H 470J-T-A
C118	4030012480	S.CERAMIC	GRM42-6 CH 121J 500PT
C119	4030012480	S.CERAMIC	GRM42-6 CH 121J 500PT
C120	4010005830	CERAMIC	HM74SJ SL 151J 500V
C121	4510004640	S.ELECTROLYTIC	ECEV1CA470SP
C122	4030004910	S.CERAMIC	C2012 CH 1H 220J-T-A
C123	4030011170	S.CERAMIC	GRM42-6 CH 180J 500PT
RL1	6330001160	RELAY	AJV5341 (JV1AP-DC12V)
J3	6510022600	S.CONNECTOR	30FMN-BMTTR-A-TBT
J10	6510003080	CONNECTOR	RT01T-1.0B
J11	6510018960	S.CONNECTOR	B2B-PH-SM3-TB
F1	5210000060	FUSE	FG5 5A
F2	5220000230	HOLDER	S-N5054 #01
F3	5220000230	HOLDER	S-N5054 #01

S.=Surface mount

[PA UNIT]

REF NO.	ORDER NO.	DESCRIPTION	
W29	9045201001	WIRE	74/98/040/X98/X98
W30	9021780060	WIRE	74/98/018/X98/X98
W31	9021780060	WIRE	74/98/018/X98/X98
WS1	8970023490	CABLE	SX2178 1.5D COAXIAL TUBE (1)/PA
WS2	8970023500	CABLE	SX2178 1.5D COAXIAL TUBE (1)/PA
WS3	8970023510	E.OTHER	SX2178 J BOARD SET (1)/PA
EP1	0910051815	PCB	B 5294E
EP2	6910000610	BEAD	FSOH050RN01
EP3	6910000610	BEAD	FSOH050RN01
EP4	6510018330	TERMINAL	F4053A
EP5	6510018330	TERMINAL	F4053A
EP8	9001602001	TUBE	IRRAX 0.7 (d) L=10 mm
EP9	9001602001	TUBE	IRRAX 0.7 (d) L=10 mm
EP10	9001602001	TUBE	IRRAX 0.7 (d) L=10 mm
EP11	9034701901	TUBE	IRRAX 0.7 (d) L=20 mm
EP12	0910052242	PCB	B 5447B
EP13	0910052341	PCB	B 5449A
EP14	0910052351	PCB	B 5450A

[TUNER UNIT]

REF NO.	ORDER NO.	DESCRIPTION	
C8	4030006880	S.CERAMIC	C1608 JB 1H 472K-T-A
C9	4030006880	S.CERAMIC	C1608 JB 1H 472K-T-A
C10	4030006880	S.CERAMIC	C1608 JB 1H 472K-T-A
C11	4030006880	S.CERAMIC	C1608 JB 1H 472K-T-A
C12	4030006880	S.CERAMIC	C1608 JB 1H 472K-T-A
C13	4030006880	S.CERAMIC	C1608 JB 1H 472K-T-A
C14	4030006880	S.CERAMIC	C1608 JB 1H 472K-T-A
C15	4030006880	S.CERAMIC	C1608 JB 1H 472K-T-A
C16	4030006880	S.CERAMIC	C1608 JB 1H 472K-T-A
C17	4030006880	S.CERAMIC	C1608 JB 1H 472K-T-A
C18	4030006880	S.CERAMIC	C1608 JB 1H 472K-T-A
C23	4030006880	S.CERAMIC	C1608 JB 1H 472K-T-A
C24	4030006880	S.CERAMIC	C1608 JB 1H 472K-T-A
C25	4030006880	S.CERAMIC	C1608 JB 1H 472K-T-A
C26	4030006880	S.CERAMIC	C1608 JB 1H 472K-T-A
C27	4030006880	S.CERAMIC	C1608 JB 1H 472K-T-A
C28	4030006880	S.CERAMIC	C1608 JB 1H 472K-T-A
C29	4030006880	S.CERAMIC	C1608 JB 1H 472K-T-A
C30	4030006880	S.CERAMIC	C1608 JB 1H 472K-T-A
C31	4030006880	S.CERAMIC	C1608 JB 1H 472K-T-A
C32	4030006880	S.CERAMIC	C1608 JB 1H 472K-T-A
C33	4030006880	S.CERAMIC	C1608 JB 1H 472K-T-A
C34	4010008550	CERAMIC	DE0607 SL 390J 3KV
C35	4010008550	CERAMIC	DE0607 SL 390J 3KV
C36	4010004800	CERAMIC	DE1210 SL 820J 6KV
C37	4010004250	CERAMIC	DE1007 SL 101J 3KV
C38	4010004830	CERAMIC	DE1510 SL 151J 6KV
C39	4010008560	CERAMIC	DE1107 SL 151J 3KV
C40	4010004250	CERAMIC	DE1007 SL 101J 3KV
C41	4010004250	CERAMIC	DE1007 SL 101J 3KV
C42	4010004250	CERAMIC	DE1007 SL 101J 3KV
C43	4010004250	CERAMIC	DE1007 SL 101J 3KV
C44	4620000140	VARIABLE	UV35A 150P
C45	4620000140	VARIABLE	UV35A 150P
C46	4030006880	S.CERAMIC	C1608 JB 1H 472K-T-A
C47	4030006880	S.CERAMIC	C1608 JB 1H 472K-T-A
C48	4030006880	S.CERAMIC	C1608 JB 1H 472K-T-A
C49	4030006880	S.CERAMIC	C1608 JB 1H 472K-T-A
C50	4030006880	S.CERAMIC	C1608 JB 1H 472K-T-A
C51	4030006880	S.CERAMIC	C1608 JB 1H 472K-T-A
C52	4030006880	S.CERAMIC	C1608 JB 1H 472K-T-A
C53	4030006880	S.CERAMIC	C1608 JB 1H 472K-T-A
C54	4030006880	S.CERAMIC	C1608 JB 1H 472K-T-A
C55	4030006880	S.CERAMIC	C1608 JB 1H 472K-T-A
C56	4030006880	S.CERAMIC	C1608 JB 1H 472K-T-A
C57	4030006880	S.CERAMIC	C1608 JB 1H 472K-T-A
C58	4030006880	S.CERAMIC	C1608 JB 1H 472K-T-A
C59	4030006880	S.CERAMIC	C1608 JB 1H 472K-T-A
C60	4030006880	S.CERAMIC	C1608 JB 1H 472K-T-A
C61	4030006880	S.CERAMIC	C1608 JB 1H 472K-T-A
RL1	6330001610	RELAY	NY-12W-K-IE
RL2	6330001610	RELAY	NY-12W-K-IE
RL3	6330001610	RELAY	NY-12W-K-IE
RL4	6330001610	RELAY	NY-12W-K-IE
RL5	6330001610	RELAY	NY-12W-K-IE
RL6	6330001610	RELAY	NY-12W-K-IE
RL7	6330001610	RELAY	NY-12W-K-IE
RL8	6330001610	RELAY	NY-12W-K-IE
RL9	6330001610	RELAY	NY-12W-K-IE
RL10	6330001610	RELAY	NY-12W-K-IE
RL11	6330001610	RELAY	NY-12W-K-IE
RL12	6330001610	RELAY	NY-12W-K-IE
RL13	6330001610	RELAY	NY-12W-K-IE
RL14	6330001610	RELAY	NY-12W-K-IE
RL15	6330001610	RELAY	NY-12W-K-IE
J5	6510022590	S.CONNECTOR	22FMN-BMTTR-A-TBT
MF1	2710000460	MOTOR	MP28GA STEPPING MOTOR
MF2	2710000460	MOTOR	MP28GA STEPPING MOTOR
WS1	8970023521	CABLE	SX2178 1.5D COAXIAL TUBE (2)/TU
EP1	0910052334	PCB	B 5408D

[TUNER UNIT]

REF NO.	ORDER NO.	DESCRIPTION	
IC1	1120000970	IC	M54562P
IC2	1120000970	IC	M54562P
L1	2040000490	COIL	EXC-ELDR25C
L2	2040000490	COIL	EXC-ELDR25C
L3	6110003600	COIL	LA-555
L4	6110003590	COIL	LA-554
L5	6110003020	COIL	LA-489
L6	6110003030	COIL	LA-490
L7	6110003020	COIL	LA-489
L8	6110003030	COIL	LA-490
L9	6140003260	COIL	LR-363 (T130-6)
L10	6140003260	COIL	LR-363 (T130-6)
L11	6140002700	COIL	LR-307 (T130-2)
L12	6140002700	COIL	LR-307 (T130-2)
L13	6180003290	COIL	BM27-400-6A
L14	6180003290	COIL	BM27-400-6A
L15	6180003290	COIL	BM27-400-6A
L16	6180003290	COIL	BM27-400-6A
L17	6180003290	COIL	BM27-400-6A
L18	6180003290	COIL	BM27-400-6A
L19	6180003290	COIL	BM27-400-6A
L20	6180003290	COIL	BM27-400-6A
R17	7030003440	S.RESISTOR	ERJ3GEYJ 102 V (1 kΩ)
R18	7030003440	S.RESISTOR	ERJ3GEYJ 102 V (1 kΩ)
R19	7030003440	S.RESISTOR	ERJ3GEYJ 102 V (1 kΩ)
R20	7030003440	S.RESISTOR	ERJ3GEYJ 102 V (1 kΩ)
R21	7030003440	S.RESISTOR	ERJ3GEYJ 102 V (1 kΩ)
R22	7030003440	S.RESISTOR	ERJ3GEYJ 102 V (1 kΩ)
R23	7030003440	S.RESISTOR	ERJ3GEYJ 102 V (1 kΩ)
R24	7030003440	S.RESISTOR	ERJ3GEYJ 102 V (1 kΩ)
R25	7030003440	S.RESISTOR	ERJ3GEYJ 102 V (1 kΩ)
R26	7030003440	S.RESISTOR	ERJ3GEYJ 102 V (1 kΩ)
R27	7030003440	S.RESISTOR	ERJ3GEYJ 102 V (1 kΩ)
R28	7030003440	S.RESISTOR	ERJ3GEYJ 102 V (1 kΩ)
R29	7030003440	S.RESISTOR	ERJ3GEYJ 102 V (1 kΩ)
R30	7030003440	S.RESISTOR	ERJ3GEYJ 102 V (1 kΩ)
R31	7030003440	S.RESISTOR	ERJ3GEYJ 102 V (1 kΩ)
R32	7030003440	S.RESISTOR	ERJ3GEYJ 102 V (1 kΩ)
C1	4030006880	S.CERAMIC	C1608 JB 1H 472K-T-A
C2	4030006880	S.CERAMIC	C1608 JB 1H 472K-T-A
C3	4030006880	S.CERAMIC	C1608 JB 1H 472K-T-A
C4	4030006880	S.CERAMIC	C1608 JB 1H 472K-T-A
C5	4030006880	S.CERAMIC	C1608 JB 1H 472K-T-A
C6	4030006880	S.CERAMIC	C1608 JB 1H 472K-T-A
C7	4030006880	S.CERAMIC	C1608 JB 1H 472K-T-A

S.=Surface mount

[FILTER UNIT]

REF NO.	ORDER NO.	DESCRIPTION	
L1	6140002570	COIL	LR-294 (T50-2)
L2	6140002580	COIL	LR-295 (T50-2)
L3	6140001240	COIL	LR-149 (T68-2)
L4	6140001130	COIL	LR-138 (T68-2)
L5	6140001800	COIL	LR-216 (T50-2)
L6	6140001800	COIL	LR-216 (T50-2)
L8	6140002270	COIL	LR-240 (T68-6)
L9	6110002920	COIL	LA-481
L10	6110002910	COIL	LA-480
L13	6200003260	S.COIL	NL 322522T-101J
L15	6200003260	S.COIL	NL 322522T-101J
L17	6200003260	S.COIL	NL 322522T-101J
L19	6200003260	S.COIL	NL 322522T-101J
L21	6200001830	S.COIL	NL 322522T-100J
L23	6200001830	S.COIL	NL 322522T-100J
L24	6140003450	COIL	LR-387
L25	6140003460	COIL	LR-388
L26	6140003460	COIL	LR-388
L28	6140002280	COIL	LR-241 (T68-6)
L29	6110003540	COIL	LA-548 (LA-215A)
L30	6110003570	COIL	LA-550
L31	6110003550	COIL	LA-547 (LA-214A)
L32	6200001830	S.COIL	NL 322522T-100J
L41	6200001830	S.COIL	NL 322522T-100J
L45	6140003560	COIL	LR-394
L46	6140001820	COIL	LR-218 (T50-10)
L501	6140003440	COIL	LR-386
L502	6140003440	COIL	LR-386
C2	4010008260	CERAMIC	HM74TJ SL 151J 500V
C3	4010008200	CERAMIC	HM11TJ SL 331J 500V
C5	4030012480	S.CERAMIC	GRM42-6 CH 121J 500PT
C7	4010005360	CERAMIC	HM11SJ SL 301J 500V
C8	4010005360	CERAMIC	HM11SJ SL 301J 500V
C10	4010005360	CERAMIC	HM11SJ SL 301J 500V
C12	4030011730	S.CERAMIC	GRM42-6 CH 101J 500PT
C14	4010005360	CERAMIC	HM11SJ SL 301J 500V
C15	4010008300	CERAMIC	HM11TJ SL 391J 500V
C16	4010005860	CERAMIC	HM95SJ SL 201J 500V
C17	4010008270	CERAMIC	HM95TJ SL 181J 500V
C18	4030011730	S.CERAMIC	GRM42-6 CH 101J 500PT
C20	4010005360	CERAMIC	HM11SJ SL 301J 500V
C21	4010005360	CERAMIC	HM11SJ SL 301J 500V
C22	4030011180	S.CERAMIC	GRM42-6 CH 220J 500PT
C23	4010008200	CERAMIC	HM11TJ SL 331J 500V
C24	4010008200	CERAMIC	HM11TJ SL 331J 500V
C25	4010008200	CERAMIC	HM11TJ SL 331J 500V
C28	4030011730	S.CERAMIC	GRM42-6 CH 101J 500PT
C30	4030011170	S.CERAMIC	GRM42-6 CH 180J 500PT
C31	4030011730	S.CERAMIC	GRM42-6 CH 101J 500PT
C32	4030012480	S.CERAMIC	GRM42-6 CH 121J 500PT
C33	4030011170	S.CERAMIC	GRM42-6 CH 180J 500PT
C34	4030012480	S.CERAMIC	GRM42-6 CH 121J 500PT
C35	4030011230	S.CERAMIC	GRM42-6 CH 390J 500PT
C36	4030011730	S.CERAMIC	GRM42-6 CH 101J 500PT
C37	4030011190	S.CERAMIC	GRM42-6 CH 270J 500PT
C38	4030012480	S.CERAMIC	GRM42-6 CH 121J 500PT
C39	4030011190	S.CERAMIC	GRM42-6 CH 270J 500PT
C40	4030011550	S.CERAMIC	GRM42-6 CH 680J 500PT
C41	4030011120	S.CERAMIC	GRM42-6 CH 100D 500PT
C42	4030006880	S.CERAMIC	C1608 JB 1H 472K-T-A
C43	4030006880	S.CERAMIC	C1608 JB 1H 472K-T-A
C44	4030006880	S.CERAMIC	C1608 JB 1H 472K-T-A
C45	4030006880	S.CERAMIC	C1608 JB 1H 472K-T-A
C46	4030006880	S.CERAMIC	C1608 JB 1H 472K-T-A
C47	4030006880	S.CERAMIC	C1608 JB 1H 472K-T-A
C48	4030006880	S.CERAMIC	C1608 JB 1H 472K-T-A
C49	4030006880	S.CERAMIC	C1608 JB 1H 472K-T-A
C50	4030006880	S.CERAMIC	C1608 JB 1H 472K-T-A
C51	4030006880	S.CERAMIC	C1608 JB 1H 472K-T-A
C52	4030006880	S.CERAMIC	C1608 JB 1H 472K-T-A
C53	4030006880	S.CERAMIC	C1608 JB 1H 472K-T-A
C62	4030011730	S.CERAMIC	GRM42-6 CH 101J 500PT
C63	4030011240	S.CERAMIC	GRM42-6 CH 470J 500PT
C65	4030011730	S.CERAMIC	GRM42-6 CH 101J 500PT
C66	4010005360	CERAMIC	HM11SJ SL 301J 500V
C67	4010005360	CERAMIC	HM11SJ SL 301J 500V
C68	4010005360	CERAMIC	HM11SJ SL 301J 500V
C69	4010005360	CERAMIC	HM11SJ SL 301J 500V
C72	4010008280	CERAMIC	HM95TJ SL 221J 500V
C73	4010005390	CERAMIC	HM15SJ SL 621J 500V

[FILTER UNIT]

REF NO.	ORDER NO.	DESCRIPTION	
C74	4010005390	CERAMIC	HM15SJ SL 621J 500V
C75	4010005390	CERAMIC	HM15SJ SL 621J 500V
C77	4030011210	S.CERAMIC	GRM42-6 CH 330J 500PT
C78	4030011240	S.CERAMIC	GRM42-6 CH 470J 500PT
C79	4030011240	S.CERAMIC	GRM42-6 CH 470J 500PT
C80	4030011240	S.CERAMIC	GRM42-6 CH 470J 500PT
C81	4030011240	S.CERAMIC	GRM42-6 CH 470J 500PT
C82	4030011230	S.CERAMIC	GRM42-6 CH 390J 500PT
C83	4030011080	S.CERAMIC	GRM42-6 CH 060D 500PT
C85	4030011160	S.CERAMIC	GRM42-6 CH 150J 500PT
C86	4030011180	S.CERAMIC	GRM42-6 CH 220J 500PT
C87	4030006880	S.CERAMIC	C1608 JB 1H 472K-T-A
C88	4030006880	S.CERAMIC	C1608 JB 1H 472K-T-A
C97	4010005390	CERAMIC	HM15SJ SL 621J 500V
C98	4010005390	CERAMIC	HM15SJ SL 621J 500V
C99	4010005390	CERAMIC	HM15SJ SL 621J 500V
C100	4010005390	CERAMIC	HM15SJ SL 621J 500V
C102	4030011730	S.CERAMIC	GRM42-6 CH 101J 500PT
C103	4030012480	S.CERAMIC	GRM42-6 CH 121J 500PT
C104	4030012480	S.CERAMIC	GRM42-6 CH 121J 500PT
C136	4030006880	S.CERAMIC	C1608 JB 1H 472K-T-A
C137	4030006880	S.CERAMIC	C1608 JB 1H 472K-T-A
C141	4010008290	CERAMIC	HM95TJ SL 271J 500V
C142	4030011230	S.CERAMIC	GRM42-6 CH 390J 500PT
C143	4010008280	CERAMIC	HM95TJ SL 221J 500V
C144	4010008280	CERAMIC	HM95TJ SL 221J 500V
C145	4030014460	S.CERAMIC	GRM42-6 CH 820J 500PT
C146	4030014460	S.CERAMIC	GRM42-6 CH 820J 500PT
C151	4010008200	CERAMIC	HM11TJ SL 331J 500V
C152	4010005390	CERAMIC	HM15SJ SL 621J 500V
C153	4010008200	CERAMIC	HM11TJ SL 331J 500V
C156	4030011550	S.CERAMIC	GRM42-6 CH 680J 500PT
C157	4030011210	S.CERAMIC	GRM42-6 CH 330J 500PT
C501	4030006480	S.CERAMIC	GRM42-6 B 104K 50PT
C502	4030006480	S.CERAMIC	GRM42-6 B 104K 50PT
C503	4030004740	S.CERAMIC	C2012 JB 1H 472K-T-A
C504	4030004740	S.CERAMIC	C2012 JB 1H 472K-T-A
C507	4030006480	S.CERAMIC	GRM42-6 B 104K 50PT
C508	4030004740	S.CERAMIC	C2012 JB 1H 472K-T-A
C513	4030006480	S.CERAMIC	GRM42-6 B 104K 50PT
C514	4030006480	S.CERAMIC	GRM42-6 B 104K 50PT
C515	4030004740	S.CERAMIC	C2012 JB 1H 472K-T-A
C516	4030004740	S.CERAMIC	C2012 JB 1H 472K-T-A
C517	4510004330	ELECTROLYTIC	35 MV 10 SWB
C521	4030004740	S.CERAMIC	C2012 JB 1H 472K-T-A
C522	4030004740	S.CERAMIC	C2012 JB 1H 472K-T-A
C523	4030006480	S.CERAMIC	GRM42-6 B 104K 50PT
C524	4030006480	S.CERAMIC	GRM42-6 B 104K 50PT
C527	4030006480	S.CERAMIC	GRM42-6 B 104K 50PT
C528	4510004330	ELECTROLYTIC	35 MV 10 SWB
RL1	6330001510	RELAY	TB1-160
RL2	6330001510	RELAY	TB1-160
RL3	6330001510	RELAY	TB1-160
RL4	6330001510	RELAY	TB1-160
RL5	6330001510	RELAY	TB1-160
RL6	6330001510	RELAY	TB1-160
RL7	6330001510	RELAY	TB1-160
RL8	6330001510	RELAY	TB1-160
RL9	6330001510	RELAY	TB1-160
RL10	6330001510	RELAY	TB1-160
RL11	6330001510	RELAY	TB1-160
RL12	6330001510	RELAY	TB1-160
RL13	6330001330	RELAY	AG 201344
RL14	6330001330	RELAY	AG 201344
RL15	6330001510	RELAY	TB1-160
RL16	6330001510	RELAY	TB1-160
J1	6510007020	CONNECTOR	TMP-J01X-V6
J2	6510007020	CONNECTOR	TMP-J01X-V6
J3	6510022620	S.CONNECTOR	10FMN-BMTTR-A-TBT
W1	7030003860	S.JUMPER	ERJ3GE JPW V
W2	7030003860	S.JUMPER	ERJ3GE JPW V
W3	7030003860	S.JUMPER	ERJ3GE JPW V
W4	7030003860	S.JUMPER	ERJ3GE JPW V
W5	7030003860	S.JUMPER	ERJ3GE JPW V
W6	7030003860	S.JUMPER	ERJ3GE JPW V
W7	7030003860	S.JUMPER	ERJ3GE JPW V

S.=Surface mount

[FILTER UNIT]

REF NO.	ORDER NO.	DESCRIPTION	
W8	7030003860	S.JUMPER	ERJ3GE JPW V
W9	8900009620	CABLE	OPC-961
W10	8900009630	CABLE	OPC-962
EP1	0910051805	PCB	B 5287E
EP501	6510018330	TERMINAL	F4053A
EP502	6510018330	TERMINAL	F4053A

[CTRL UNIT]

REF NO.	ORDER NO.	DESCRIPTION	
IC1	1110000960	S.IC	NJM4558M-T1
IC2	1120002250	S.IC	TC74ACT32F
IC3	1120002240	S.IC	TC74AC112F
IC4	1110000960	S.IC	NJM4558M-T1
IC5	1140004120	S.IC	M38022M2-138FP
IC6	1140003610	S.IC	X24C04S8-2.7T6
IC9	1110002690	S.IC	NJM2903M-T1
IC10	1130003920	S.IC	TC4S69F (TE85R)
IC11	1130007700	S.IC	BU4094BCF-T1
IC12	1160000130	S.IC	TD62783AF (TP1)
IC13	1180001070	S.IC	TA7805F (TE16L)
IC14	1120002300	S.IC	TC74AC04F
Q5	1560000870	S.FET	2SK515-T1B (X33)
Q12	1590000680	S.TRANSISTOR	DTC114EUA T106
Q13	1590001330	S.TRANSISTOR	DTA114EUA T106
Q14	1590000680	S.TRANSISTOR	DTC114EUA T106
Q15	1590001330	S.TRANSISTOR	DTA114EUA T106
Q16	1590000680	S.TRANSISTOR	DTC114EUA T106
Q17	1590001330	S.TRANSISTOR	DTA114EUA T106
Q21	1590000680	S.TRANSISTOR	DTC114EUA T106
Q22	1590001330	S.TRANSISTOR	DTA114EUA T106
Q23	1590000680	S.TRANSISTOR	DTC114EUA T106
Q24	1590001330	S.TRANSISTOR	DTA114EUA T106
Q25	1530003090	S.TRANSISTOR	2SC4213-B (TE85R)
Q26	1590000680	S.TRANSISTOR	DTC114EUA T106
Q27	1590001330	S.TRANSISTOR	DTA114EUA T106
Q211	1590000680	S.TRANSISTOR	DTC114EUA T106
Q212	1590000680	S.TRANSISTOR	DTC114EUA T106
Q213	1590000680	S.TRANSISTOR	DTC114EUA T106
Q214	1590000680	S.TRANSISTOR	DTC114EUA T106
Q215	1590000680	S.TRANSISTOR	DTC114EUA T106
Q216	1590000680	S.TRANSISTOR	DTC114EUA T106
Q217	1590000680	S.TRANSISTOR	DTC114EUA T106
Q218	1590000680	S.TRANSISTOR	DTC114EUA T106
D1	1790000490	S.DIODE	HSM88AS-TR
D2	1790000490	S.DIODE	HSM88AS-TR
D3	1750000200	S.DIODE	1SS319 (TE85R)
D4	1750000120	S.DIODE	DWA010-TE
D5	1790000690	S.DIODE	HSM88ASR-TR
D6	1790000490	S.DIODE	HSM88AS-TR
D7	1790000490	S.DIODE	HSM88AS-TR
D8	1790000490	S.DIODE	HSM88AS-TR
D9	1790000490	S.DIODE	HSM88AS-TR
D10	1750000120	S.DIODE	DWA010-TE
D11	1730000410	S.ZENER	RD5.1M-T2B2
D12	1730000030	S.ZENER	RD5.6M-T2B2
D13	1710000780	S.DIODE	MA114 (TX)
D15	1790000490	S.DIODE	HSM88AS-TR
D16	1750000270	S.DIODE	1SS301 (TE85R)
D17	1750000270	S.DIODE	1SS301 (TE85R)
D18	1750000270	S.DIODE	1SS301 (TE85R)
D20	1750000270	S.DIODE	1SS301 (TE85R)
D22	1750000850	S.DIODE	MMBV3700LT1
D23	1750000850	S.DIODE	MMBV3700LT1
D211	1750000200	S.DIODE	1SS319 (TE85R)
D213	1750000200	S.DIODE	1SS319 (TE85R)
D215	1750000200	S.DIODE	1SS319 (TE85R)
D217	1750000200	S.DIODE	1SS319 (TE85R)
X1	6050009890	S.XTAL	CR-569 (6.144 MHz)

[CTRL UNIT]

REF NO.	ORDER NO.	DESCRIPTION	
L1	6140003270	COIL	LR-364
L2	6200001830	S.COIL	NL 322522T-100J
L3	6200003260	S.COIL	NL 322522T-101J
L4	6140003270	COIL	LR-364
L5	6180001220	COIL	LAL 04NA 100K
L8	6140003270	COIL	LR-364
L9	6180000450	COIL	RFC L6 222K
L10	6200003260	S.COIL	NL 322522T-101J
L11	6200003260	S.COIL	NL 322522T-101J
L13	6180000990	COIL	LAL 04NA 101K
L22	6140003270	COIL	LR-364
L25	6200003260	S.COIL	NL 322522T-101J
L27	6110001630	COIL	LA-246
L28	6110001560	COIL	LA-236
L29	2040000490	COIL	EXC-ELDR25C
L30	2040000490	COIL	EXC-ELDR25C
L31	2040000490	COIL	EXC-ELDR25C
L32	2040000490	COIL	EXC-ELDR25C
L33	6200003260	S.COIL	NL 322522T-101J
L34	6200003260	S.COIL	NL 322522T-101J
L35	6200003950	S.COIL	HF50ACC 322513-T
L36	6200003950	S.COIL	HF50ACC 322513-T
L301	6140002580	COIL	LR-295 (T50-2)
L302	6140002580	COIL	LR-295 (T50-2)
R1	7030007130	S.RESISTOR	ERJ1WYJ150U (15 Ω)
R2	7030007130	S.RESISTOR	ERJ1WYJ150U (15 Ω)
R3	7030003560	S.RESISTOR	ERJ3GEYJ 103 V (10 kΩ)
R4	7030003560	S.RESISTOR	ERJ3GEYJ 103 V (10 kΩ)
R5	7030003720	S.RESISTOR	ERJ3GEYJ 224 V (220 kΩ)
R6	7030003720	S.RESISTOR	ERJ3GEYJ 224 V (220 kΩ)
R7	7030003720	S.RESISTOR	ERJ3GEYJ 224 V (220 kΩ)
R8	7030003720	S.RESISTOR	ERJ3GEYJ 224 V (220 kΩ)
R9	7030003800	S.RESISTOR	ERJ3GEYJ 105 V (1 MΩ)
R10	7030003790	S.RESISTOR	ERJ3GEYJ 824 V (820 kΩ)
R13	7030003440	S.RESISTOR	ERJ3GEYJ 102 V (1 kΩ)
R14	7030003440	S.RESISTOR	ERJ3GEYJ 102 V (1 kΩ)
R15	7030003320	S.RESISTOR	ERJ3GEYJ 101 V (100 Ω)
R16	7030006540	S.RESISTOR	ERJ1WYJ330U (33 Ω)
R17	7030003320	S.RESISTOR	ERJ3GEYJ 101 V (100 Ω)
R26	7030003280	S.RESISTOR	ERJ3GEYJ 470 V (47 Ω)
R27	7030003280	S.RESISTOR	ERJ3GEYJ 470 V (47 Ω)
R28	7030003500	S.RESISTOR	ERJ3GEYJ 332 V (3.3 kΩ)
R29	7030003480	S.RESISTOR	ERJ3GEYJ 222 V (2.2 kΩ)
R30	7030003360	S.RESISTOR	ERJ3GEYJ 221 V (220 Ω)
R31	7030003480	S.RESISTOR	ERJ3GEYJ 222 V (2.2 kΩ)
R32	7030003680	S.RESISTOR	ERJ3GEYJ 104 V (100 kΩ)
R33	7030003530	S.RESISTOR	ERJ3GEYJ 562 V (5.6 kΩ)
R34	7030003530	S.RESISTOR	ERJ3GEYJ 562 V (5.6 kΩ)
R35	7030003670	S.RESISTOR	ERJ3GEYJ 823 V (82 kΩ)
R36	7030003820	S.RESISTOR	ERJ3GEYJ 155 V (1.5 MΩ)
R37	7030003560	S.RESISTOR	ERJ3GEYJ 103 V (10 kΩ)
R38	7030003560	S.RESISTOR	ERJ3GEYJ 103 V (10 kΩ)
R39	7030003680	S.RESISTOR	ERJ3GEYJ 104 V (100 kΩ)
R40	7030003680	S.RESISTOR	ERJ3GEYJ 104 V (100 kΩ)
R41	7030008040	S.RESISTOR	ERJ1WYJ820U (82 Ω)
R42	7030003560	S.RESISTOR	ERJ3GEYJ 103 V (10 kΩ)
R43	7030003560	S.RESISTOR	ERJ3GEYJ 103 V (10 kΩ)
R44	7030003800	S.RESISTOR	ERJ3GEYJ 105 V (1 MΩ)
R45	7030003560	S.RESISTOR	ERJ3GEYJ 103 V (10 kΩ)
R46	7030003520	S.RESISTOR	ERJ3GEYJ 472 V (4.7 kΩ)
R47	7030003440	S.RESISTOR	ERJ3GEYJ 102 V (1 kΩ)
R48	7030003560	S.RESISTOR	ERJ3GEYJ 103 V (10 kΩ)
R49	7030003680	S.RESISTOR	ERJ3GEYJ 104 V (100 kΩ)
R50	7030003540	S.RESISTOR	ERJ3GEYJ 682 V (6.8 kΩ)
R51	7030003540	S.RESISTOR	ERJ3GEYJ 682 V (6.8 kΩ)
R52	7030003680	S.RESISTOR	ERJ3GEYJ 104 V (100 kΩ)
R53	7030003820	S.RESISTOR	ERJ3GEYJ 155 V (1.5 MΩ)
R54	7030003560	S.RESISTOR	ERJ3GEYJ 103 V (10 kΩ)
R55	7030003560	S.RESISTOR	ERJ3GEYJ 103 V (10 kΩ)
R56	7030003680	S.RESISTOR	ERJ3GEYJ 104 V (100 kΩ)
R57	7030003680	S.RESISTOR	ERJ3GEYJ 104 V (100 kΩ)
R58	7540000130	ABSORBER	2P-50A-301
R59	7030003560	S.RESISTOR	ERJ3GEYJ 103 V (10 kΩ)
R60	7030003560	S.RESISTOR	ERJ3GEYJ 103 V (10 kΩ)
R61	7030003680	S.RESISTOR	ERJ3GEYJ 104 V (100 kΩ)
R62	7030003680	S.RESISTOR	ERJ3GEYJ 104 V (100 kΩ)
R63	7030003680	S.RESISTOR	ERJ3GEYJ 104 V (100 kΩ)
R64	7030003680	S.RESISTOR	ERJ3GEYJ 104 V (100 kΩ)
R65	7030003440	S.RESISTOR	ERJ3GEYJ 102 V (1 kΩ)
R66	7030003650	S.RESISTOR	ERJ3GEYJ 563 V (56 kΩ)

S.=Surface mount

[CTRL UNIT]

REF NO.	ORDER NO.	DESCRIPTION	
R67	7030003440	S.RESISTOR	ERJ3GEYJ 102 V (1 kΩ)
R69	7030003320	S.RESISTOR	ERJ3GEYJ 101 V (100 Ω)
R71	7030003440	S.RESISTOR	ERJ3GEYJ 102 V (1 kΩ)
R76	7030003560	S.RESISTOR	ERJ3GEYJ 103 V (10 kΩ)
R83	7030007130	S.RESISTOR	ERJ1WYJ150U (15 Ω)
R84	7030003560	S.RESISTOR	ERJ3GEYJ 103 V (10 kΩ)
R86	7030003710	S.RESISTOR	ERJ3GEYJ 184 V (180 kΩ)
R87	7030003660	S.RESISTOR	ERJ3GEYJ 683 V (68 kΩ)
R88	7030003660	S.RESISTOR	ERJ3GEYJ 683 V (68 kΩ)
R89	7030003840	S.RESISTOR	ERJ3GEYJ 225 V (2.2 MΩ)
R90	7030003720	S.RESISTOR	ERJ3GEYJ 224 V (220 kΩ)
R92	7030003440	S.RESISTOR	ERJ3GEYJ 102 V (1 kΩ)
R93	7030003560	S.RESISTOR	ERJ3GEYJ 103 V (10 kΩ)
R98	7030003440	S.RESISTOR	ERJ3GEYJ 102 V (1 kΩ)
R99	7030003560	S.RESISTOR	ERJ3GEYJ 103 V (10 kΩ)
R100	7030003660	S.RESISTOR	ERJ3GEYJ 683 V (68 kΩ)
R101	7030003660	S.RESISTOR	ERJ3GEYJ 683 V (68 kΩ)
R102	7030003570	S.RESISTOR	ERJ3GEYJ 123 V (12 kΩ)
R103	7030003680	S.RESISTOR	ERJ3GEYJ 104 V (100 kΩ)
R105	7030003440	S.RESISTOR	ERJ3GEYJ 102 V (1 kΩ)
R106	7030003440	S.RESISTOR	ERJ3GEYJ 102 V (1 kΩ)
R107	7030003680	S.RESISTOR	ERJ3GEYJ 104 V (100 kΩ)
R108	7030003440	S.RESISTOR	ERJ3GEYJ 102 V (1 kΩ)
R109	7030003440	S.RESISTOR	ERJ3GEYJ 102 V (1 kΩ)
R110	7030003440	S.RESISTOR	ERJ3GEYJ 102 V (1 kΩ)
R111	7030003440	S.RESISTOR	ERJ3GEYJ 102 V (1 kΩ)
R112	7030003440	S.RESISTOR	ERJ3GEYJ 102 V (1 kΩ)
R113	7030003440	S.RESISTOR	ERJ3GEYJ 102 V (1 kΩ)
R114	7030003440	S.RESISTOR	ERJ3GEYJ 102 V (1 kΩ)
R115	7030003440	S.RESISTOR	ERJ3GEYJ 102 V (1 kΩ)
R116	7030003440	S.RESISTOR	ERJ3GEYJ 102 V (1 kΩ)
R117	7030003440	S.RESISTOR	ERJ3GEYJ 102 V (1 kΩ)
R118	7030003440	S.RESISTOR	ERJ3GEYJ 102 V (1 kΩ)
R119	7030003440	S.RESISTOR	ERJ3GEYJ 102 V (1 kΩ)
R120	7030003440	S.RESISTOR	ERJ3GEYJ 102 V (1 kΩ)
R121	7030003440	S.RESISTOR	ERJ3GEYJ 102 V (1 kΩ)
R122	7030003360	S.RESISTOR	ERJ3GEYJ 221 V (220 Ω)
R123	7030003360	S.RESISTOR	ERJ3GEYJ 221 V (220 Ω)
R124	7030003360	S.RESISTOR	ERJ3GEYJ 221 V (220 Ω)
R125	7030003360	S.RESISTOR	ERJ3GEYJ 221 V (220 Ω)
R126	7030003200	S.RESISTOR	ERJ3GEYJ 100 V (10 Ω)
R127	7030003200	S.RESISTOR	ERJ3GEYJ 100 V (10 Ω)
R128	7030003200	S.RESISTOR	ERJ3GEYJ 100 V (10 Ω)
R129	7030003200	S.RESISTOR	ERJ3GEYJ 100 V (10 Ω)
R130	7030003200	S.RESISTOR	ERJ3GEYJ 100 V (10 Ω)
R131	7030003200	S.RESISTOR	ERJ3GEYJ 100 V (10 Ω)
R132	7030003200	S.RESISTOR	ERJ3GEYJ 100 V (10 Ω)
R133	7030003200	S.RESISTOR	ERJ3GEYJ 100 V (10 Ω)
R136	7030003560	S.RESISTOR	ERJ3GEYJ 103 V (10 kΩ)
R137	7030003280	S.RESISTOR	ERJ3GEYJ 470 V (47 Ω)
R138	7030003440	S.RESISTOR	ERJ3GEYJ 102 V (1 kΩ)
R139	7030003560	S.RESISTOR	ERJ3GEYJ 103 V (10 kΩ)
R140	7030003280	S.RESISTOR	ERJ3GEYJ 470 V (47 Ω)
R141	7030003440	S.RESISTOR	ERJ3GEYJ 102 V (1 kΩ)
R142	7030003280	S.RESISTOR	ERJ3GEYJ 470 V (47 Ω)
R143	7030003440	S.RESISTOR	ERJ3GEYJ 102 V (1 kΩ)
R144	7030003280	S.RESISTOR	ERJ3GEYJ 470 V (47 Ω)
R145	7030003440	S.RESISTOR	ERJ3GEYJ 102 V (1 kΩ)
R146	7030003280	S.RESISTOR	ERJ3GEYJ 470 V (47 Ω)
R147	7030003440	S.RESISTOR	ERJ3GEYJ 102 V (1 kΩ)
R148	7030003640	S.RESISTOR	ERJ3GEYJ 473 V (47 kΩ)
R149	7030003680	S.RESISTOR	ERJ3GEYJ 104 V (100 kΩ)
R150	7030003390	S.RESISTOR	ERJ3GEYJ 391 V (390 Ω)
R151	7030003430	S.RESISTOR	ERJ3GEYJ 821 V (820 Ω)
R152	7030003520	S.RESISTOR	ERJ3GEYJ 472 V (4.7 kΩ)
R153	7030003520	S.RESISTOR	ERJ3GEYJ 472 V (4.7 kΩ)
R154	7030003480	S.RESISTOR	ERJ3GEYJ 222 V (2.2 kΩ)
R155	7030003390	S.RESISTOR	ERJ3GEYJ 391 V (390 Ω)
R156	7010006940	RESISTOR	PSD1/4 1 kΩ
R211	7030003380	S.RESISTOR	ERJ3GEYJ 331 V (330 Ω)
R212	7030003380	S.RESISTOR	ERJ3GEYJ 331 V (330 Ω)
R213	7030003380	S.RESISTOR	ERJ3GEYJ 331 V (330 Ω)
R214	7030003380	S.RESISTOR	ERJ3GEYJ 331 V (330 Ω)
R215	7030003380	S.RESISTOR	ERJ3GEYJ 331 V (330 Ω)
R216	7030003380	S.RESISTOR	ERJ3GEYJ 331 V (330 Ω)
R217	7030003380	S.RESISTOR	ERJ3GEYJ 331 V (330 Ω)
R218	7030003380	S.RESISTOR	ERJ3GEYJ 331 V (330 Ω)
C1	4010005530	CERAMIC	HM60SJ SL 020C 500V
C2	4030007110	S.CERAMIC	C1608 CH 1H 680J-T-A
C3	4610001260	S.TRIMMER	ECR-JA020 E12W

[CTRL UNIT]

REF NO.	ORDER NO.	DESCRIPTION	
C4	4010005530	CERAMIC	HM60SJ SL 020C 500V
C5	4030011540	S.CERAMIC	C1608 CH 1H 750J-T-A
C6	4030006860	S.CERAMIC	C1608 JB 1H 102K-T-A
C7	4030006860	S.CERAMIC	C1608 JB 1H 102K-T-A
C8	4030006880	S.CERAMIC	C1608 JB 1H 472K-T-A
C9	4030006880	S.CERAMIC	C1608 JB 1H 472K-T-A
C10	4030006880	S.CERAMIC	C1608 JB 1H 472K-T-A
C11	4030006880	S.CERAMIC	C1608 JB 1H 472K-T-A
C12	4010005540	CERAMIC	HM60SJ SL 030C 500V
C13	4030007070	S.CERAMIC	C1608 CH 1H 330J-T-A
C14	4030007070	S.CERAMIC	C1608 CH 1H 330J-T-A
C15	4030007070	S.CERAMIC	C1608 CH 1H 330J-T-A
C16	4030006880	S.CERAMIC	C1608 JB 1H 472K-T-A
C17	4030007120	S.CERAMIC	C1608 CH 1H 820J-T-A
C20	4030006880	S.CERAMIC	C1608 JB 1H 472K-T-A
C21	4030006880	S.CERAMIC	C1608 JB 1H 472K-T-A
C22	4550003120	S.TANTALUM	TEMSVD2 1A 476M-12L
C23	4030006880	S.CERAMIC	C1608 JB 1H 472K-T-A
C24	4030007170	S.CERAMIC	C1608 CH 1H 221J-T-A
C25	4030007170	S.CERAMIC	C1608 CH 1H 221J-T-A
C26	4030006880	S.CERAMIC	C1608 JB 1H 472K-T-A
C27	4030006880	S.CERAMIC	C1608 JB 1H 472K-T-A
C30	4030007170	S.CERAMIC	C1608 CH 1H 221J-T-A
C31	4030011340	S.CERAMIC	C1608 CH 1H 471J-T-A
C32	4010005520	CERAMIC	HM60SJ SL 010C 500V
C33	4030016550	S.CERAMIC	CM105 CH 151G 50AT
C35	4030006880	S.CERAMIC	C1608 JB 1H 472K-T-A
C36	4030006860	S.CERAMIC	C1608 JB 1H 102K-T-A
C37	4030006880	S.CERAMIC	C1608 JB 1H 472K-T-A
C38	4030006880	S.CERAMIC	C1608 JB 1H 472K-T-A
C39	4030006880	S.CERAMIC	C1608 JB 1H 472K-T-A
C40	4030006880	S.CERAMIC	C1608 JB 1H 472K-T-A
C43	4030007170	S.CERAMIC	C1608 CH 1H 221J-T-A
C44	4030011340	S.CERAMIC	C1608 CH 1H 471J-T-A
C45	4030011600	S.CERAMIC	C1608 JB 1C 104KT-N
C46	4030011600	S.CERAMIC	C1608 JB 1C 104KT-N
C47	4030009990	S.CERAMIC	C1608 CH 1H 200J-T-A
C48	4030009990	S.CERAMIC	C1608 CH 1H 200J-T-A
C49	4030006880	S.CERAMIC	C1608 JB 1H 472K-T-A
C51	4030006860	S.CERAMIC	C1608 JB 1H 102K-T-A
C52	4030006880	S.CERAMIC	C1608 JB 1H 472K-T-A
C53	4030006880	S.CERAMIC	C1608 JB 1H 472K-T-A
C54	4030006880	S.CERAMIC	C1608 JB 1H 472K-T-A
C55	4030006860	S.CERAMIC	C1608 JB 1H 102K-T-A
C56	4030006880	S.CERAMIC	C1608 JB 1H 472K-T-A
C57	4030006880	S.CERAMIC	C1608 JB 1H 472K-T-A
C58	4030006880	S.CERAMIC	C1608 JB 1H 472K-T-A
C59	4030006880	S.CERAMIC	C1608 JB 1H 472K-T-A
C60	4030006880	S.CERAMIC	C1608 JB 1H 472K-T-A
C62	4030006880	S.CERAMIC	C1608 JB 1H 472K-T-A
C63	4030007090	S.CERAMIC	C1608 CH 1H 470J-T-A
C64	4030007030	S.CERAMIC	C1608 CH 1H 150J-T-A
C65	4030007120	S.CERAMIC	C1608 CH 1H 820J-T-A
C66	4030007070	S.CERAMIC	C1608 CH 1H 330J-T-A
C69	4510004630	S.ELECTROLYTIC	ECEV1CA100SR
C70	4510004630	S.ELECTROLYTIC	ECEV1CA100SR
C71	4030006880	S.CERAMIC	C1608 JB 1H 472K-T-A
C72	4510006260	S.ELECTROLYTIC	ECEV1AA471UP
C73	4030006880	S.CERAMIC	C1608 JB 1H 472K-T-A
C74	4030006880	S.CERAMIC	C1608 JB 1H 472K-T-A
C75	4030006880	S.CERAMIC	C1608 JB 1H 472K-T-A
C76	4030006880	S.CERAMIC	C1608 JB 1H 472K-T-A
C77	4030006880	S.CERAMIC	C1608 JB 1H 472K-T-A
C78	4030006880	S.CERAMIC	C1608 JB 1H 472K-T-A
C79	4030006880	S.CERAMIC	C1608 JB 1H 472K-T-A
C80	4030006880	S.CERAMIC	C1608 JB 1H 472K-T-A
C81	4030006880	S.CERAMIC	C1608 JB 1H 472K-T-A
C82	4030006880	S.CERAMIC	C1608 JB 1H 472K-T-A
C83	4030006880	S.CERAMIC	C1608 JB 1H 472K-T-A
C84	4030006880	S.CERAMIC	C1608 JB 1H 472K-T-A
C85	4030006880	S.CERAMIC	C1608 JB 1H 472K-T-A
C86	4030006880	S.CERAMIC	C1608 JB 1H 472K-T-A
C87	4030006880	S.CERAMIC	C1608 JB 1H 472K-T-A
C88	4510004630	S.ELECTROLYTIC	ECEV1CA100SR
C89	4030006880	S.CERAMIC	C1608 JB 1H 472K-T-A
C90	4510004630	S.ELECTROLYTIC	ECEV1CA100SR
C91	4030006880	S.CERAMIC	C1608 JB 1H 472K-T-A
C92	4030006880	S.CERAMIC	C1608 JB 1H 472K-T-A
C93	4030006880	S.CERAMIC	C1608 JB 1H 472K-T-A
C94	4030006880	S.CERAMIC	C1608 JB 1H 472K-T-A
C95	4030006880	S.CERAMIC	C1608 JB 1H 472K-T-A
C96	4030006880	S.CERAMIC	C1608 JB 1H 472K-T-A

S.=Surface mount

[CTRL UNIT]

REF NO.	ORDER NO.	DESCRIPTION	
C97	4030006880	S.CERAMIC	C1608 JB 1H 472K-T-A
C98	4510006220	S.ELECTROLYTIC	ECEV1CA101UP
C100	4030011570	S.CERAMIC	CM105 CH 101G 50AT
C101	4030006880	S.CERAMIC	C1608 JB 1H 472K-T-A
C102	4510004630	S.ELECTROLYTIC	ECEV1CA100SR
C105	4030011540	S.CERAMIC	C1608 CH 1H 750J-T-A
C107	4010005580	CERAMIC	HM60SJ SL 070D 500V
C108	4010005560	CERAMIC	HM60SJ SL 050C 500V
C109	4030011600	S.CERAMIC	C1608 JB 1C 104KT-N
C209	4030006900	S.CERAMIC	C1608 JB 1E 103K-T-A
C210	4030006900	S.CERAMIC	C1608 JB 1E 103K-T-A
C211	4510004440	S.ELECTROLYTIC	ECEV1HA010SR
C212	4510004440	S.ELECTROLYTIC	ECEV1HA010SR
C213	4510004440	S.ELECTROLYTIC	ECEV1HA010SR
C214	4510004440	S.ELECTROLYTIC	ECEV1HA010SR
C215	4510004440	S.ELECTROLYTIC	ECEV1HA010SR
C216	4510004440	S.ELECTROLYTIC	ECEV1HA010SR
C217	4510004440	S.ELECTROLYTIC	ECEV1HA010SR
C218	4510004440	S.ELECTROLYTIC	ECEV1HA010SR
C220	4030006880	S.CERAMIC	C1608 JB 1H 472K-T-A
C228	4030005040	S.CERAMIC	C2012 CH 1H 271J-T-A
C301	4030007060	S.CERAMIC	C1608 CH 1H 270J-T-A
C302	4610002210	TRIMMER	TZ03Z500FR169 50P
C303	4610002210	TRIMMER	TZ03Z500FR169 50P
RL1	6330001450	RELAY	FXE-12G
RL2	6330001450	RELAY	FXE-12G
RL3	6330000800	RELAY	G5A-237P DC12V
RL4	6330000470	RELAY	NR-HD (12V) AE5343
J3	6510017150	CONNECTOR	TMP-S01X-C1
J4	6510017150	CONNECTOR	TMP-S01X-C1
J7	6510022590	S.CONNECTOR	22FMN-BMTTR-A-TBT
J8	6510022590	S.CONNECTOR	22FMN-BMTTR-A-TBT
J10	6510003410	CONNECTOR	B05B-EH-S
J11	6510003410	CONNECTOR	B05B-EH-S
J12	6910001040	CONNECTOR	IPS-1136
J13	6510022620	S.CONNECTOR	10FMN-BMTTR-A-TBT
J14	6910001040	CONNECTOR	IPS-1136
W1	7120000490	JUMPER	ERD25T0
W2	7120000490	JUMPER	ERD25T0
W3	7120000490	JUMPER	ERD25T0
W4	7030003860	S.JUMPER	ERJ3GE JPW V
WS1	8970023531	CABLE	SX2178 1.5D COAXIAL TUBE (2)/CT
EP1	0910051826	PCB	B 5300F

[MEMORY BOARD]

REF NO.	ORDER NO.	DESCRIPTION	
IC1	1140009990	S.IC	MBM29F400BC-90PFTN SC-1388
IC2	1140008470	S.IC	IDT71256SA20PZ
R1	7030003680	S.RESISTOR	ERJ3GEYJ 104 V (100 kΩ)
R2	7030003680	S.RESISTOR	ERJ3GEYJ 104 V (100 kΩ)
C1	4030011600	S.CERAMIC	C1608 JB 1C 104KT-N
C2	4030006860	S.CERAMIC	C1608 JB 1H 102K-T-A
C3	4550006250	S.TANTALUM	TEMSVA 1A 106M-8L
C4	4030011600	S.CERAMIC	C1608 JB 1C 104KT-N
J1	6510022070	S.CONNECTOR	AXK6S30635P
J2	6510022070	S.CONNECTOR	AXK6S30635P
EP1	6910012350	S.BEAD	MMZ1608Y 102BT
EP2	0910052263	PCB	B 5418C

[RF-A UNIT]

REF NO.	ORDER NO.	DESCRIPTION	
IC151	1110001890	S.IC	μPC1678G-E2
IC451	1110003970	S.IC	μPC1658G-E1
IC841	1110003490	S.IC	TA31136FN (D, EL)
IC871	1110000960	S.IC	NJM4558M-T1
IC901	1130007700	S.IC	BU4094BCF-T1
IC902	1130007570	S.IC	BU4094BCFV-E2
IC903	1160000130	S.IC	TD62783AF (TP1)
IC904	1160000130	S.IC	TD62783AF (TP1)
IC905	1130007570	S.IC	BU4094BCFV-E2
IC961	1110004130	S.IC	μPC2708T-E3
Q101	1590001150	S.TRANSISTOR	UN9211 (TX)
Q131	1590001150	S.TRANSISTOR	UN9211 (TX)
Q132	1590001150	S.TRANSISTOR	UN9211 (TX)
Q141	1590002710	S.TRANSISTOR	UMH11NTN
Q143	1590001150	S.TRANSISTOR	UN9211 (TX)
Q151	1590002710	S.TRANSISTOR	UMH11NTN
Q152	1510000510	S.TRANSISTOR	2SA1576A T106R
Q153	1590001150	S.TRANSISTOR	UN9211 (TX)
Q441	1560000720	S.FET	2SK2171-4-TD
Q442	1560000720	S.FET	2SK2171-4-TD
Q445	1590001960	S.TRANSISTOR	XP4311 (TX)
Q452	1590001960	S.TRANSISTOR	XP4311 (TX)
Q501	1560000720	S.FET	2SK2171-4-TD
Q502	1560000720	S.FET	2SK2171-4-TD
Q511	1560000640	S.FET	2SK1740-TA
Q512	1560000640	S.FET	2SK1740-TA
Q513	1560000640	S.FET	2SK1740-TA
Q514	1560000640	S.FET	2SK1740-TA
Q531	1530002060	S.TRANSISTOR	2SC4081 T107 R
Q551	1560000720	S.FET	2SK2171-4-TD
Q561	1530003150	S.TRANSISTOR	2SC4673D-TD
Q601	1560000720	S.FET	2SK2171-4-TD
Q602	1560000720	S.FET	2SK2171-4-TD
Q611	1560000640	S.FET	2SK1740-TA
Q612	1560000640	S.FET	2SK1740-TA
Q613	1560000640	S.FET	2SK1740-TA
Q614	1560000640	S.FET	2SK1740-TA
Q631	1530002060	S.TRANSISTOR	2SC4081 T107 R
Q651	1560000720	S.FET	2SK2171-4-TD
Q661	1530003150	S.TRANSISTOR	2SC4673D-TD
Q701	1560000560	S.FET	2SK882-GR (TE85L)
Q721	1580000620	S.FET	3SK131-T2 MAS
Q722	1590001960	S.TRANSISTOR	XP4311 (TX)
Q751	1560000560	S.FET	2SK882-GR (TE85L)
Q801	1530002060	S.TRANSISTOR	2SC4081 T107 R
Q811	1560000560	S.FET	2SK882-GR (TE85L)
Q812	1560000560	S.FET	2SK882-GR (TE85L)
Q831	1560000560	S.FET	2SK882-GR (TE85L)
Q901	1590002710	S.TRANSISTOR	UMH11NTN
Q902	1590002710	S.TRANSISTOR	UMH11NTN
Q903	1590001960	S.TRANSISTOR	XP4311 (TX)
Q904	1590001960	S.TRANSISTOR	XP4311 (TX)
Q905	1590001960	S.TRANSISTOR	XP4311 (TX)
D103	1750000520	S.DIODE	DAN222TL
D131	1750000850	S.DIODE	MMBV3700LT1
D141	1750000850	S.DIODE	MMBV3700LT1
D142	1790000620	S.DIODE	MA77 (TX)
D153	1750000850	S.DIODE	MMBV3700LT1
D171	1750000850	S.DIODE	MMBV3700LT1
D181	1750000850	S.DIODE	MMBV3700LT1
D261	1750000850	S.DIODE	MMBV3700LT1
D262	1790000620	S.DIODE	MA77 (TX)
D281	1750000850	S.DIODE	MMBV3700LT1
D282	1790000620	S.DIODE	MA77 (TX)
D301	1750000850	S.DIODE	MMBV3700LT1
D302	1790000620	S.DIODE	MA77 (TX)
D321	1750000850	S.DIODE	MMBV3700LT1
D322	1790000620	S.DIODE	MA77 (TX)
D341	1750000850	S.DIODE	MMBV3700LT1
D342	1790000620	S.DIODE	MA77 (TX)
D361	1750000850	S.DIODE	MMBV3700LT1
D362	1790000620	S.DIODE	MA77 (TX)
D411	1790000620	S.DIODE	MA77 (TX)
D421	1790000620	S.DIODE	MA77 (TX)
D431	1790000620	S.DIODE	MA77 (TX)
D432	1790000620	S.DIODE	MA77 (TX)
D441	1790000620	S.DIODE	MA77 (TX)
D442	1790000620	S.DIODE	MA77 (TX)

S.=Surface mount

[RF-A UNIT]

REF NO.	ORDER NO.	DESCRIPTION	
D443	1790000620	S.DIODE	MA77 (TX)
D444	1790000620	S.DIODE	MA77 (TX)
D481	1790000620	S.DIODE	MA77 (TX)
D531	1750000450	S.DIODE	1SV265-TL
D532	1750000450	S.DIODE	1SV265-TL
D533	1750000440	S.DIODE	1SV263-TL
D534	1790000620	S.DIODE	MA77 (TX)
D535	1790000620	S.DIODE	MA77 (TX)
D536	1790001250	S.DIODE	MA2S111-(TX)
D561	1790000620	S.DIODE	MA77 (TX)
D562	1790000620	S.DIODE	MA77 (TX)
D631	1750000450	S.DIODE	1SV265-TL
D632	1750000450	S.DIODE	1SV265-TL
D633	1750000440	S.DIODE	1SV263-TL
D635	1790000620	S.DIODE	MA77 (TX)
D636	1790001250	S.DIODE	MA2S111-(TX)
D701	1790000620	S.DIODE	MA77 (TX)
D702	1790000620	S.DIODE	MA77 (TX)
D711	1790000620	S.DIODE	MA77 (TX)
D712	1790000620	S.DIODE	MA77 (TX)
D721	1790000620	S.DIODE	MA77 (TX)
D722	1790000620	S.DIODE	MA77 (TX)
D741	1750000430	S.DIODE	HSB88WSTR
D742	1790001620	S.DIODE	1SV308 (TPL3)
D743	1790001620	S.DIODE	1SV308 (TPL3)
D751	1790000620	S.DIODE	MA77 (TX)
D771	1750000430	S.DIODE	HSB88WSTR
D772	1790000620	S.DIODE	MA77 (TX)
D801	1750000440	S.DIODE	1SV263-TL
D831	1750000430	S.DIODE	HSB88WSTR
D861	1790001250	S.DIODE	MA2S111-(TX)
D871	1790001670	S.DIODE	RB706F-40T106
D901	1750000520	S.DIODE	DAN222TL
D902	1750000520	S.DIODE	DAN222TL
D903	1750000520	S.DIODE	DAN222TL
D904	1750000520	S.DIODE	DAN222TL
D905	1750000520	S.DIODE	DAN222TL
D941	1750000430	S.DIODE	HSB88WSTR
FI711	2010002540	XTAL	FL-315A (64.45500 MHz)
FI841	2020001800	S.CERAMIC	SFECV13.35MAS
FI842	2020001320	CERAMIC	CFJ455K8
FI843	2020001800	S.CERAMIC	SFECV13.35MAS
L111	6200003450	S.COIL	NL 322522T-082J
L112	6200001470	S.COIL	NL 322522T-R12J-3
L121	6180002970	S.COIL	NL 322522T-068J
L132	6200005490	S.COIL	NL 322522T-331J
L141	6200005490	S.COIL	NL 322522T-331J
L151	6200001710	S.COIL	NL 322522T-220J
L152	6200001470	S.COIL	NL 322522T-R12J-3
L153	6200009810	S.COIL	LQN 1H R61J04
L171	6200005490	S.COIL	NL 322522T-331J
L172	6180000850	COIL	LAL 03NA 4R7K
L173	6180000860	COIL	LAL 03NA 5R6K
L174	6200005490	S.COIL	NL 322522T-331J
L181	6180001900	COIL	LAL 02NA 6R8K
L182	6180001900	COIL	LAL 02NA 6R8K
L261	6180002400	COIL	LAL 02NA 1R0K
L262	6180001730	COIL	LAL 02NA 1R8K
L263	6180001730	COIL	LAL 02NA 1R8K
L264	6180001730	COIL	LAL 02NA 1R8K
L265	6180002400	COIL	LAL 02NA 1R0K
L281	6180002530	COIL	LAL 02NA R68K
L282	6180002370	COIL	LAL 02NA 1R5K
L283	6180002370	COIL	LAL 02NA 1R5K
L284	6180002370	COIL	LAL 02NA 1R5K
L285	6180002530	COIL	LAL 02NA R68K
L301	6180002350	COIL	LAL 02NA R56K
L302	6180001740	COIL	LAL 02NA R82K
L303	6180001740	COIL	LAL 02NA R82K
L304	6180001740	COIL	LAL 02NA R82K
L305	6180002350	COIL	LAL 02NA R56K
L321	6200003020	S.COIL	NL 322522T-R33J-3
L322	6200003040	S.COIL	NL 322522T-R68J-3
L323	6200003040	S.COIL	NL 322522T-R68J-3
L324	6200003040	S.COIL	NL 322522T-R68J-3
L325	6200003020	S.COIL	NL 322522T-R33J-3
L341	6200003010	S.COIL	NL 322522T-R27J-3
L342	6200003000	S.COIL	NL 322522T-R22J-3

[RF-A UNIT]

REF NO.	ORDER NO.	DESCRIPTION	
L343	6200003010	S.COIL	NL 322522T-R27J-3
L361	6200008100	S.COIL	LQN 1H R14J04
L363	6200007810	S.COIL	LQN 1H 95NK04
L365	6200008100	S.COIL	LQN 1H R14J04
L412	6200005490	S.COIL	NL 322522T-331J
L413	6200005490	S.COIL	NL 322522T-331J
L431	6200003220	S.COIL	NL 322522T-151J
L441	6140003530	COIL	LR-395
L442	6180000850	COIL	LAL 03NA 4R7K
L443	6180000850	COIL	LAL 03NA 4R7K
L444	6140003640	COIL	LR-408
L445	6200003220	S.COIL	NL 322522T-151J
L452	6200003260	S.COIL	NL 322522T-101J
L453	6200005490	S.COIL	NL 322522T-331J
L471	6200005490	S.COIL	NL 322522T-331J
L491	6140003530	COIL	LR-395
L492	6140003530	COIL	LR-395
L501	6200008280	S.COIL	0.30-1.7-7TL 50N
L502	6200008180	S.COIL	0.25-1.9-10TL 107N
L503	6200008360	S.COIL	0.25-1.9-13TL
L504	6200005490	S.COIL	NL 322522T-331J
L505	6200003030	S.COIL	NL 322522T-R47J-3
L511	6140003250	COIL	LR-362
L512	6200003260	S.COIL	NL 322522T-101J
L513	6150005130	COIL	LS-541
L514	6200001830	S.COIL	NL 322522T-100J
L530	6200003640	S.COIL	MLF1608E 100K-T
L531	6200001830	S.COIL	NL 322522T-100J
L532	6200001830	S.COIL	NL 322522T-100J
L533	6200001830	S.COIL	NL 322522T-100J
L534	6180001000	COIL	LAL 04NA 102K
L535	6200003640	S.COIL	MLF1608E 100K-T
L551	6200001830	S.COIL	NL 322522T-100J
L552	6200003420	S.COIL	NL 322522T-R15J-3
L561	6200003000	S.COIL	NL 322522T-R22J-3
L562	6200003020	S.COIL	NL 322522T-R33J-3
L563	6200001830	S.COIL	NL 322522T-100J
L564	6180002970	S.COIL	NL 322522T-068J
L565	6180002970	S.COIL	NL 322522T-068J
L566	6140003210	S.COIL	LR-358
L567	6180002970	S.COIL	NL 322522T-068J
L568	6200003640	S.COIL	MLF1608E 100K-T
L601	6200008280	S.COIL	0.30-1.7-7TL 50N
L602	6200008180	S.COIL	0.25-1.9-10TL 107N
L603	6200008360	S.COIL	0.25-1.9-13TL
L604	6200005490	S.COIL	NL 322522T-331J
L605	6200003030	S.COIL	NL 322522T-R47J-3
L611	6140003250	COIL	LR-362
L612	6200003260	S.COIL	NL 322522T-101J
L613	6150005130	COIL	LS-541
L614	6200001830	S.COIL	NL 322522T-100J
L631	6200001830	S.COIL	NL 322522T-100J
L632	6200001830	S.COIL	NL 322522T-100J
L633	6200001830	S.COIL	NL 322522T-100J
L634	6180001000	COIL	LAL 04NA 102K
L651	6200001830	S.COIL	NL 322522T-100J
L652	6200003420	S.COIL	NL 322522T-R15J-3
L653	6140003210	S.COIL	LR-358
L661	6200003000	S.COIL	NL 322522T-R22J-3
L662	6200003020	S.COIL	NL 322522T-R33J-3
L663	6200001830	S.COIL	NL 322522T-100J
L664	6180002970	S.COIL	NL 322522T-068J
L665	6180002970	S.COIL	NL 322522T-068J
L666	6140003210	S.COIL	LR-358
L667	6180002970	S.COIL	NL 322522T-068J
L701	6150004280	COIL	LS-484B (C-14927)
L711	6150005110	COIL	LS-540
L712	6150005110	COIL	LS-540
L713	6150005110	COIL	LS-540
L721	6150004280	COIL	LS-484B (C-14927)
L722	6150004280	COIL	LS-484B (C-14927)
L741	6140003210	S.COIL	LR-358
L742	6140003530	COIL	LR-395
L745	6200005490	S.COIL	NL 322522T-331J
L746	6200005490	S.COIL	NL 322522T-331J
L752	6150004280	COIL	LS-484B (C-14927)
L753	6200004600	S.COIL	MLF1608D R15K-T
L754	6200004600	S.COIL	MLF1608D R15K-T
L755	6200003630	S.COIL	MLF1608D R68K-T
L771	6130002960	S.COIL	617DB-1327=P3
L772	6130002960	S.COIL	617DB-1327=P3
L802	6200003090	S.COIL	NL 322522T-2R7J-3

S.=Surface mount

[RF-A UNIT]

REF NO.	ORDER NO.	DESCRIPTION	
L812	6150004280	COIL	LS-484B (C-14927)
L813	6150004280	COIL	LS-484B (C-14927)
L831	6140003210	S.COIL	LR-358
L832	6140003210	S.COIL	LR-358
L833	6150004280	COIL	LS-484B (C-14927)
L841	6200003080	S.COIL	NL 322522T-1R8J-3
L842	6200003640	S.COIL	MLF1608E 100K-T
L871	6200003260	S.COIL	NL 322522T-101J
L872	6200003260	S.COIL	NL 322522T-101J
L873	6200003260	S.COIL	NL 322522T-101J
L941	6140003530	COIL	LR-395
L942	6140003210	S.COIL	LR-358
L951	6200003950	S.COIL	HF50ACC 322513-T
L961	6200003450	S.COIL	NL 322522T-082J
L962	6200003420	S.COIL	NL 322522T-R15J-3
L963	6200001710	S.COIL	NL 322522T-220J
R111	7030003560	S.RESISTOR	ERJ3GEYJ 103 V (10 kΩ)
R112	7540000130	ABSORBER	2P-50A-301
R121	7030003280	S.RESISTOR	ERJ3GEYJ 470 V (47 Ω)
R122	7030003320	S.RESISTOR	ERJ3GEYJ 101 V (100 Ω)
R123	7030003340	S.RESISTOR	ERJ3GEYJ 151 V (150 Ω)
R124	7030003300	S.RESISTOR	ERJ3GEYJ 680 V (68 Ω)
R131	7030008180	S.RESISTOR	ERJ12YJ331U (330 Ω)
R132	7030003680	S.RESISTOR	ERJ3GEYJ 104 V (100 kΩ)
R133	7030003560	S.RESISTOR	ERJ3GEYJ 103 V (10 kΩ)
R141	7030008180	S.RESISTOR	ERJ12YJ331U (330 Ω)
R142	7030003680	S.RESISTOR	ERJ3GEYJ 104 V (100 kΩ)
R143	7030003480	S.RESISTOR	ERJ3GEYJ 222 V (2.2 kΩ)
R144	7030003560	S.RESISTOR	ERJ3GEYJ 103 V (10 kΩ)
R145	7540000130	ABSORBER	2P-50A-301
R146	7030003560	S.RESISTOR	ERJ3GEYJ 103 V (10 kΩ)
R147	7030003680	S.RESISTOR	ERJ3GEYJ 104 V (100 kΩ)
R151	7030000320	S.RESISTOR	MCR10EZJH 330 Ω (331)
R152	7030003220	S.RESISTOR	ERJ3GEYJ 150 V (15 Ω)
R153	7030000320	S.RESISTOR	MCR10EZJH 330 Ω (331)
R154	7030007530	S.RESISTOR	ERJ8ENF 1800V (180 Ω)
R155	7030003680	S.RESISTOR	ERJ3GEYJ 104 V (100 kΩ)
R156	7030003560	S.RESISTOR	ERJ3GEYJ 103 V (10 kΩ)
R158	7030004040	S.RESISTOR	ERJ3GEYJ 4R7 V (4.7 Ω)
R159	7030003640	S.RESISTOR	ERJ3GEYJ 473 V (47 kΩ)
R160	7030003440	S.RESISTOR	ERJ3GEYJ 102 V (1 kΩ)
R161	7030003400	S.RESISTOR	ERJ3GEYJ 471 V (470 Ω)
R162	7030003200	S.RESISTOR	ERJ3GEYJ 100 V (10 Ω)
R163	7030003400	S.RESISTOR	ERJ3GEYJ 471 V (470 Ω)
R171	7030003680	S.RESISTOR	ERJ3GEYJ 104 V (100 kΩ)
R181	7030000260	S.RESISTOR	MCR10EZJH 100 Ω (101)
R182	7030003300	S.RESISTOR	ERJ3GEYJ 680 V (68 Ω)
R183	7030000260	S.RESISTOR	MCR10EZJH 100 Ω (101)
R271	7030000260	S.RESISTOR	MCR10EZJH 100 Ω (101)
R281	7030000260	S.RESISTOR	MCR10EZJH 100 Ω (101)
R301	7030000260	S.RESISTOR	MCR10EZJH 100 Ω (101)
R321	7030000260	S.RESISTOR	MCR10EZJH 100 Ω (101)
R341	7030000260	S.RESISTOR	MCR10EZJH 100 Ω (101)
R361	7030000260	S.RESISTOR	MCR10EZJH 100 Ω (101)
R411	7030008180	S.RESISTOR	ERJ12YJ331U (330 Ω)
R412	7030009220	S.RESISTOR	ERJ12YJ561U
R431	7030003280	S.RESISTOR	ERJ3GEYJ 470 V (47 Ω)
R432	7030003280	S.RESISTOR	ERJ3GEYJ 470 V (47 Ω)
R441	7030003280	S.RESISTOR	ERJ3GEYJ 470 V (47 Ω)
R442	7030000180	S.RESISTOR	MCR10EZJH 22 Ω (220)
R444	7030003280	S.RESISTOR	ERJ3GEYJ 470 V (47 Ω)
R451	7030003280	S.RESISTOR	ERJ3GEYJ 470 V (47 Ω)
R452	7030003420	S.RESISTOR	ERJ3GEYJ 681 V (680 Ω)
R453	7030003320	S.RESISTOR	ERJ3GEYJ 101 V (100 Ω)
R454	7030003340	S.RESISTOR	ERJ3GEYJ 151 V (150 Ω)
R455	7030003270	S.RESISTOR	ERJ3GEYJ 390 V (39 Ω)
R456	7030003340	S.RESISTOR	ERJ3GEYJ 151 V (150 Ω)
R471	7030009220	S.RESISTOR	ERJ12YJ561U
R481	7030003640	S.RESISTOR	ERJ3GEYJ 473 V (47 kΩ)
R482	7030003480	S.RESISTOR	ERJ3GEYJ 222 V (2.2 kΩ)
R491	7030003320	S.RESISTOR	ERJ3GEYJ 101 V (100 Ω)
R501	7030000220	S.RESISTOR	MCR10EZJH 47 Ω (470)
R511	7030003410	S.RESISTOR	ERJ3GEYJ 561 V (560 Ω)
R512	7030003410	S.RESISTOR	ERJ3GEYJ 561 V (560 Ω)
R513	7030003410	S.RESISTOR	ERJ3GEYJ 561 V (560 Ω)
R514	7030003410	S.RESISTOR	ERJ3GEYJ 561 V (560 Ω)
R515	7310004650	S.TRIMMER	EVM-2WSX80 B53 (502)
R516	7310004650	S.TRIMMER	EVM-2WSX80 B53 (502)
R517	7030003320	S.RESISTOR	ERJ3GEYJ 101 V (100 Ω)
R518	7030003320	S.RESISTOR	ERJ3GEYJ 101 V (100 Ω)

[RF-A UNIT]

REF NO.	ORDER NO.	DESCRIPTION	
R531	7030003360	S.RESISTOR	ERJ3GEYJ 221 V (220 Ω)
R532	7030003460	S.RESISTOR	ERJ3GEYJ 152 V (1.5 kΩ)
R533	7030003440	S.RESISTOR	ERJ3GEYJ 102 V (1 kΩ)
R534	7030003480	S.RESISTOR	ERJ3GEYJ 222 V (2.2 kΩ)
R535	7030003560	S.RESISTOR	ERJ3GEYJ 103 V (10 kΩ)
R537	7030003480	S.RESISTOR	ERJ3GEYJ 222 V (2.2 kΩ)
R539	7030003480	S.RESISTOR	ERJ3GEYJ 222 V (2.2 kΩ)
R551	7030003280	S.RESISTOR	ERJ3GEYJ 470 V (47 Ω)
R552	7030003320	S.RESISTOR	ERJ3GEYJ 101 V (100 Ω)
R561	7030003300	S.RESISTOR	ERJ3GEYJ 680 V (68 Ω)
R563	7030003620	S.RESISTOR	ERJ3GEYJ 333 V (33 kΩ)
R565	7030009800	S.RESISTOR	ERJ12YJ121U (120 Ω)
R567	7030003440	S.RESISTOR	ERJ3GEYJ 102 V (1 kΩ)
R578	7030003440	S.RESISTOR	ERJ3GEYJ 102 V (1 kΩ)
R601	7030000220	S.RESISTOR	MCR10EZJH 47 Ω (470)
R611	7030003410	S.RESISTOR	ERJ3GEYJ 561 V (560 Ω)
R612	7030003410	S.RESISTOR	ERJ3GEYJ 561 V (560 Ω)
R613	7030003410	S.RESISTOR	ERJ3GEYJ 561 V (560 Ω)
R614	7030003410	S.RESISTOR	ERJ3GEYJ 561 V (560 Ω)
R615	7310004650	S.TRIMMER	EVM-2WSX80 B53 (502)
R616	7310004650	S.TRIMMER	EVM-2WSX80 B53 (502)
R617	7030003320	S.RESISTOR	ERJ3GEYJ 101 V (100 Ω)
R618	7030003320	S.RESISTOR	ERJ3GEYJ 101 V (100 Ω)
R631	7030003360	S.RESISTOR	ERJ3GEYJ 221 V (2.2 kΩ)
R632	7030003460	S.RESISTOR	ERJ3GEYJ 152 V (1.5 kΩ)
R633	7030003440	S.RESISTOR	ERJ3GEYJ 102 V (1 kΩ)
R634	7030003480	S.RESISTOR	ERJ3GEYJ 222 V (2.2 kΩ)
R635	7030003560	S.RESISTOR	ERJ3GEYJ 103 V (10 kΩ)
R638	7030003360	S.RESISTOR	ERJ3GEYJ 221 V (2.2 kΩ)
R651	7030003280	S.RESISTOR	ERJ3GEYJ 470 V (47 Ω)
R652	7030003320	S.RESISTOR	ERJ3GEYJ 101 V (100 Ω)
R661	7030003300	S.RESISTOR	ERJ3GEYJ 680 V (68 Ω)
R663	7030003620	S.RESISTOR	ERJ3GEYJ 333 V (33 kΩ)
R665	7030009800	S.RESISTOR	ERJ12YJ121U (120 Ω)
R701	7030003440	S.RESISTOR	ERJ3GEYJ 102 V (1 kΩ)
R702	7030003320	S.RESISTOR	ERJ3GEYJ 101 V (100 Ω)
R704	7030003680	S.RESISTOR	ERJ3GEYJ 104 V (100 kΩ)
R705	7030003380	S.RESISTOR	ERJ3GEYJ 331 V (330 Ω)
R706	7030003220	S.RESISTOR	ERJ3GEYJ 150 V (15 Ω)
R707	7030003380	S.RESISTOR	ERJ3GEYJ 331 V (330 Ω)
R708	7030003440	S.RESISTOR	ERJ3GEYJ 102 V (1 kΩ)
R711	7030003370	S.RESISTOR	ERJ3GEYJ 271 V (270 Ω)
R712	7030003230	S.RESISTOR	ERJ3GEYJ 180 V (18 Ω)
R713	7030003370	S.RESISTOR	ERJ3GEYJ 271 V (270 Ω)
R720	7030003440	S.RESISTOR	ERJ3GEYJ 102 V (1 kΩ)
R721	7030003440	S.RESISTOR	ERJ3GEYJ 102 V (1 kΩ)
R722	7030003470	S.RESISTOR	ERJ3GEYJ 182 V (1.8 kΩ)
R723	7030003600	S.RESISTOR	ERJ3GEYJ 223 V (22 kΩ)
R724	7030003200	S.RESISTOR	ERJ3GEYJ 100 V (10 Ω)
R725	7030003470	S.RESISTOR	ERJ3GEYJ 182 V (1.8 kΩ)
R726	7030003280	S.RESISTOR	ERJ3GEYJ 470 V (47 Ω)
R727	7030003560	S.RESISTOR	ERJ3GEYJ 103 V (10 kΩ)
R728	7030003300	S.RESISTOR	ERJ3GEYJ 680 V (68 Ω)
R729	7030003480	S.RESISTOR	ERJ3GEYJ 222 V (2.2 kΩ)
R730	7030003280	S.RESISTOR	ERJ3GEYJ 470 V (47 Ω)
R733	7030005280	S.RESISTOR	ERJ3GEYJ 6R8V (6.8 Ω)
R734	7030003420	S.RESISTOR	ERJ3GEYJ 681 V (680 Ω)
R735	7030003420	S.RESISTOR	ERJ3GEYJ 681 V (680 Ω)
R736	7030003440	S.RESISTOR	ERJ3GEYJ 102 V (1 kΩ)
R741	7030003380	S.RESISTOR	ERJ3GEYJ 331 V (330 Ω)
R742	7030003220	S.RESISTOR	ERJ3GEYJ 150 V (15 Ω)
R743	7030003380	S.RESISTOR	ERJ3GEYJ 331 V (330 Ω)
R744	7030003440	S.RESISTOR	ERJ3GEYJ 102 V (1 kΩ)
R746	7030000340	S.RESISTOR	MCR10EZJH 470 Ω (471)
R751	7030003440	S.RESISTOR	ERJ3GEYJ 102 V (1 kΩ)
R752	7030003440	S.RESISTOR	ERJ3GEYJ 102 V (1 kΩ)
R753	7030003340	S.RESISTOR	ERJ3GEYJ 151 V (150 Ω)
R755	7030003320	S.RESISTOR	ERJ3GEYJ 101 V (100 Ω)
R756	7030003480	S.RESISTOR	ERJ3GEYJ 222 V (2.2 kΩ)
R758	7030004040	S.RESISTOR	ERJ3GEYJ 4R7 V (4.7 Ω)
R759	7030003480	S.RESISTOR	ERJ3GEYJ 222 V (2.2 kΩ)
R760	7030003290	S.RESISTOR	ERJ3GEYJ 560 V (56 Ω)
R761	7030003480	S.RESISTOR	ERJ3GEYJ 222 V (2.2 kΩ)
R762	7510001270	S.THERMISTOR	NTCCM1608 3NH 681KC
R771	7030003350	S.RESISTOR	ERJ3GEYJ 181 V (180 Ω)
R772	7030003260	S.RESISTOR	ERJ3GEYJ 330 V (33 Ω)
R773	7030003350	S.RESISTOR	ERJ3GEYJ 181 V (180 Ω)
R774	7030003430	S.RESISTOR	ERJ3GEYJ 821 V (820 Ω)
R781	7030003440	S.RESISTOR	ERJ3GEYJ 102 V (1 kΩ)
R803	7030003560	S.RESISTOR	ERJ3GEYJ 103 V (10 kΩ)
R804	7030003440	S.RESISTOR	ERJ3GEYJ 102 V (1 kΩ)
R806	7030003560	S.RESISTOR	ERJ3GEYJ 103 V (10 kΩ)

S.=Surface mount

[RF-A UNIT]

REF NO.	ORDER NO.	DESCRIPTION	
R807	7030003440	S.RESISTOR	ERJ3GEYJ 102 V (1 kΩ)
R808	7030003440	S.RESISTOR	ERJ3GEYJ 102 V (1 kΩ)
R811	7030003520	S.RESISTOR	ERJ3GEYJ 472 V (4.7 kΩ)
R812	7030003340	S.RESISTOR	ERJ3GEYJ 151 V (150 Ω)
R813	7030003280	S.RESISTOR	ERJ3GEYJ 470 V (47 Ω)
R814	7030003420	S.RESISTOR	ERJ3GEYJ 681 V (680 Ω)
R815	7030003340	S.RESISTOR	ERJ3GEYJ 151 V (150 Ω)
R818	7030003280	S.RESISTOR	ERJ3GEYJ 470 V (47 Ω)
R819	7030003380	S.RESISTOR	ERJ3GEYJ 331 V (330 Ω)
R820	7030003220	S.RESISTOR	ERJ3GEYJ 150 V (15 Ω)
R821	7030003380	S.RESISTOR	ERJ3GEYJ 331 V (330 Ω)
R831	7030003380	S.RESISTOR	ERJ3GEYJ 331 V (330 Ω)
R832	7030003220	S.RESISTOR	ERJ3GEYJ 150 V (15 Ω)
R833	7030003380	S.RESISTOR	ERJ3GEYJ 331 V (330 Ω)
R834	7030003320	S.RESISTOR	ERJ3GEYJ 101 V (100 Ω)
R835	7030003280	S.RESISTOR	ERJ3GEYJ 470 V (47 Ω)
R841	7030003280	S.RESISTOR	ERJ3GEYJ 470 V (47 Ω)
R845	7030003680	S.RESISTOR	ERJ3GEYJ 104 V (100 kΩ)
R846	7030003360	S.RESISTOR	ERJ3GEYJ 221 V (220 Ω)
R847	7030003360	S.RESISTOR	ERJ3GEYJ 221 V (220 Ω)
R848	7030003440	S.RESISTOR	ERJ3GEYJ 102 V (1 kΩ)
R861	7030003760	S.RESISTOR	ERJ3GEYJ 474 V (470 kΩ)
R862	7030003840	S.RESISTOR	ERJ3GEYJ 225 V (2.2 MΩ)
R863	7310002580	S.TRIMMER	RV-108 (RH03A3A15X05A) 104
R864	7030003700	S.RESISTOR	ERJ3GEYJ 154 V (150 kΩ)
R865	7030003480	S.RESISTOR	ERJ3GEYJ 222 V (2.2 kΩ)
R866	7030003800	S.RESISTOR	ERJ3GEYJ 105 V (1 MΩ)
R871	7030003580	S.RESISTOR	ERJ3GEYJ 153 V (15 kΩ)
R872	7310002590	S.TRIMMER	RV-109 (RH03AJ3X0BA) 222
R873	7030003680	S.RESISTOR	ERJ3GEYJ 104 V (100 kΩ)
R874	7030003750	S.RESISTOR	ERJ3GEYJ 394 V (390 kΩ)
R875	7030003670	S.RESISTOR	ERJ3GEYJ 823 V (82 kΩ)
R876	7030003440	S.RESISTOR	ERJ3GEYJ 102 V (1 kΩ)
R901	7030003520	S.RESISTOR	ERJ3GEYJ 472 V (4.7 kΩ)
R902	7030003520	S.RESISTOR	ERJ3GEYJ 472 V (4.7 kΩ)
R905	7030003560	S.RESISTOR	ERJ3GEYJ 103 V (10 kΩ)
R906	7030003560	S.RESISTOR	ERJ3GEYJ 103 V (10 kΩ)
R907	7030003560	S.RESISTOR	ERJ3GEYJ 103 V (10 kΩ)
R908	7030003560	S.RESISTOR	ERJ3GEYJ 103 V (10 kΩ)
R909	7030003560	S.RESISTOR	ERJ3GEYJ 103 V (10 kΩ)
R910	7030003560	S.RESISTOR	ERJ3GEYJ 103 V (10 kΩ)
R911	7030003560	S.RESISTOR	ERJ3GEYJ 103 V (10 kΩ)
R913	7030003200	S.RESISTOR	ERJ3GEYJ 100 V (10 Ω)
R914	7030003200	S.RESISTOR	ERJ3GEYJ 100 V (10 Ω)
R915	7030003200	S.RESISTOR	ERJ3GEYJ 100 V (10 Ω)
R916	7030003200	S.RESISTOR	ERJ3GEYJ 100 V (10 Ω)
R917	7030003200	S.RESISTOR	ERJ3GEYJ 100 V (10 Ω)
R918	7030003200	S.RESISTOR	ERJ3GEYJ 100 V (10 Ω)
R919	7030003200	S.RESISTOR	ERJ3GEYJ 100 V (10 Ω)
R921	7030003560	S.RESISTOR	ERJ3GEYJ 103 V (10 kΩ)
R922	7030003560	S.RESISTOR	ERJ3GEYJ 103 V (10 kΩ)
R923	7030003560	S.RESISTOR	ERJ3GEYJ 103 V (10 kΩ)
R924	7030003560	S.RESISTOR	ERJ3GEYJ 103 V (10 kΩ)
R925	7030003560	S.RESISTOR	ERJ3GEYJ 103 V (10 kΩ)
R927	7030003200	S.RESISTOR	ERJ3GEYJ 100 V (10 Ω)
R928	7030003200	S.RESISTOR	ERJ3GEYJ 100 V (10 Ω)
R929	7030003200	S.RESISTOR	ERJ3GEYJ 100 V (10 Ω)
R930	7030003200	S.RESISTOR	ERJ3GEYJ 100 V (10 Ω)
R931	7030003200	S.RESISTOR	ERJ3GEYJ 100 V (10 Ω)
R933	7030003560	S.RESISTOR	ERJ3GEYJ 103 V (10 kΩ)
R934	7030003560	S.RESISTOR	ERJ3GEYJ 103 V (10 kΩ)
R941	7030003370	S.RESISTOR	ERJ3GEYJ 271 V (270 Ω)
R942	7030003230	S.RESISTOR	ERJ3GEYJ 180 V (18 Ω)
R943	7030003370	S.RESISTOR	ERJ3GEYJ 271 V (270 Ω)
R944	7030003430	S.RESISTOR	ERJ3GEYJ 821 V (820 Ω)
R961	7030003200	S.RESISTOR	ERJ3GEYJ 100 V (10 Ω)
R962	7030003340	S.RESISTOR	ERJ3GEYJ 151 V (150 Ω)
R963	7030003340	S.RESISTOR	ERJ3GEYJ 151 V (150 Ω)
R964	7030003270	S.RESISTOR	ERJ3GEYJ 390 V (39 Ω)
R965	7030003320	S.RESISTOR	ERJ3GEYJ 101 V (100 Ω)
R966	7030003320	S.RESISTOR	ERJ3GEYJ 101 V (100 Ω)
C101	4030006880	S.CERAMIC	C1608 JB 1H 472K-T-A
C111	4030011600	S.CERAMIC	C1608 JB 1C 104KT-N
C112	4030007070	S.CERAMIC	C1608 CH 1H 330J-T-A
C113	4030011540	S.CERAMIC	C1608 CH 1H 750J-T-A
C114	4030007120	S.CERAMIC	C1608 CH 1H 820J-T-A
C115	4030007030	S.CERAMIC	C1608 CH 1H 150J-T-A
C116	4030007090	S.CERAMIC	C1608 CH 1H 470J-T-A
C121	4030006880	S.CERAMIC	C1608 JB 1H 472K-T-A
C122	4030006880	S.CERAMIC	C1608 JB 1H 472K-T-A

[RF-A UNIT]

REF NO.	ORDER NO.	DESCRIPTION	
C131	4030011600	S.CERAMIC	C1608 JB 1C 104KT-N
C132	4030011600	S.CERAMIC	C1608 JB 1C 104KT-N
C133	4030011600	S.CERAMIC	C1608 JB 1C 104KT-N
C141	4030011600	S.CERAMIC	C1608 JB 1C 104KT-N
C142	4030011600	S.CERAMIC	C1608 JB 1C 104KT-N
C143	4030011600	S.CERAMIC	C1608 JB 1C 104KT-N
C144	4030011600	S.CERAMIC	C1608 JB 1C 104KT-N
C145	4030011600	S.CERAMIC	C1608 JB 1C 104KT-N
C151	4030011600	S.CERAMIC	C1608 JB 1C 104KT-N
C152	4030011600	S.CERAMIC	C1608 JB 1C 104KT-N
C153	4030011600	S.CERAMIC	C1608 JB 1C 104KT-N
C154	4030011600	S.CERAMIC	C1608 JB 1C 104KT-N
C155	4030007120	S.CERAMIC	C1608 CH 1H 820J-T-A
C156	4030007020	S.CERAMIC	C1608 CH 1H 120J-T-A
C157	4030007120	S.CERAMIC	C1608 CH 1H 820J-T-A
C158	4030011600	S.CERAMIC	C1608 JB 1C 104KT-N
C159	4030007010	S.CERAMIC	C1608 CH 1H 100D-T-A
C171	4030017850	S.CERAMIC	C2012 CH 1H 272J-T-N
C172	4030017860	S.CERAMIC	C2012 CH 1H 332J-T-N
C173	4030017830	S.CERAMIC	C2012 CH 1H 152J-T-N
C174	4030011600	S.CERAMIC	C1608 JB 1C 104KT-N
C175	4030011600	S.CERAMIC	C1608 JB 1C 104KT-N
C176	4030017860	S.CERAMIC	C2012 CH 1H 332J-T-N
C181	4030011600	S.CERAMIC	C1608 JB 1C 104KT-N
C182	4030011600	S.CERAMIC	C1608 JB 1C 104KT-N
C183	4030017840	S.CERAMIC	C2012 CH 1H 222J-T-N
C184	4030017850	S.CERAMIC	C2012 CH 1H 272J-T-N
C185	4030017820	S.CERAMIC	C2012 CH 1H 122J-T-N
C186	4030017840	S.CERAMIC	C2012 CH 1H 222J-T-N
C261	4030007170	S.CERAMIC	C1608 CH 1H 221J-T-A
C262	4030007110	S.CERAMIC	C1608 CH 1H 680J-T-A
C263	4030011600	S.CERAMIC	C1608 JB 1C 104KT-N
C264	4030007090	S.CERAMIC	C1608 CH 1H 470J-T-A
C265	4030007090	S.CERAMIC	C1608 CH 1H 470J-T-A
C266	4030007070	S.CERAMIC	C1608 CH 1H 330J-T-A
C267	4030007070	S.CERAMIC	C1608 CH 1H 330J-T-A
C268	4030007120	S.CERAMIC	C1608 CH 1H 820J-T-A
C270	4030007070	S.CERAMIC	C1608 CH 1H 330J-T-A
C271	4030007070	S.CERAMIC	C1608 CH 1H 330J-T-A
C272	4030007090	S.CERAMIC	C1608 CH 1H 470J-T-A
C273	4030007090	S.CERAMIC	C1608 CH 1H 470J-T-A
C274	4030007170	S.CERAMIC	C1608 CH 1H 221J-T-A
C275	4030007110	S.CERAMIC	C1608 CH 1H 680J-T-A
C276	4030011600	S.CERAMIC	C1608 JB 1C 104KT-N
C281	4030007160	S.CERAMIC	C1608 CH 1H 181J-T-A
C282	4030007090	S.CERAMIC	C1608 CH 1H 470J-T-A
C283	4030011600	S.CERAMIC	C1608 JB 1C 104KT-N
C284	4030007090	S.CERAMIC	C1608 CH 1H 470J-T-A
C285	4030007040	S.CERAMIC	C1608 CH 1H 180J-T-A
C286	4030007050	S.CERAMIC	C1608 CH 1H 220J-T-A
C287	4030007030	S.CERAMIC	C1608 CH 1H 150J-T-A
C288	4030007090	S.CERAMIC	C1608 CH 1H 470J-T-A
C289	4030006990	S.CERAMIC	C1608 CH 1H 080D-T-A
C290	4030007050	S.CERAMIC	C1608 CH 1H 220J-T-A
C291	4030007030	S.CERAMIC	C1608 CH 1H 150J-T-A
C292	4030007090	S.CERAMIC	C1608 CH 1H 470J-T-A
C293	4030007040	S.CERAMIC	C1608 CH 1H 180J-T-A
C294	4030007160	S.CERAMIC	C1608 CH 1H 181J-T-A
C295	4030007090	S.CERAMIC	C1608 CH 1H 470J-T-A
C296	4030011600	S.CERAMIC	C1608 JB 1C 104KT-N
C301	4030007140	S.CERAMIC	C1608 CH 1H 121J-T-A
C302	4030007040	S.CERAMIC	C1608 CH 1H 180J-T-A
C303	4030011600	S.CERAMIC	C1608 JB 1C 104KT-N
C304	4030007070	S.CERAMIC	C1608 CH 1H 330J-T-A
C305	4030007040	S.CERAMIC	C1608 CH 1H 180J-T-A
C306	4030007070	S.CERAMIC	C1608 CH 1H 330J-T-A
C307	4030007010	S.CERAMIC	C1608 CH 1H 100D-T-A
C308	4030007090	S.CERAMIC	C1608 CH 1H 470J-T-A
C310	4030007070	S.CERAMIC	C1608 CH 1H 330J-T-A
C311	4030007010	S.CERAMIC	C1608 CH 1H 100D-T-A
C312	4030007070	S.CERAMIC	C1608 CH 1H 330J-T-A
C313	4030007040	S.CERAMIC	C1608 CH 1H 180J-T-A
C314	4030007140	S.CERAMIC	C1608 CH 1H 121J-T-A
C315	4030007040	S.CERAMIC	C1608 CH 1H 180J-T-A
C316	4030011600	S.CERAMIC	C1608 JB 1C 104KT-N
C321	4030007130	S.CERAMIC	C1608 CH 1H 101J-T-A
C322	4030007030	S.CERAMIC	C1608 CH 1H 150J-T-A
C323	4030011600	S.CERAMIC	C1608 JB 1C 104KT-N
C324	4030007050	S.CERAMIC	C1608 CH 1H 220J-T-A
C325	4030007020	S.CERAMIC	C1608 CH 1H 120J-T-A
C326	4030007050	S.CERAMIC	C1608 CH 1H 220J-T-A
C328	4030007050	S.CERAMIC	C1608 CH 1H 220J-T-A

S.=Surface mount

[RF-A UNIT]

REF NO.	ORDER NO.	DESCRIPTION
C329	4030006980	S.CERAMIC C1608 CH 1H 070D-T-A
C330	4030007050	S.CERAMIC C1608 CH 1H 220J-T-A
C332	4030007050	S.CERAMIC C1608 CH 1H 220J-T-A
C333	4030007020	S.CERAMIC C1608 CH 1H 120J-T-A
C334	4030007130	S.CERAMIC C1608 CH 1H 101J-T-A
C335	4030007030	S.CERAMIC C1608 CH 1H 150J-T-A
C336	4030011600	S.CERAMIC C1608 JB 1C 104KT-N
C341	4030007100	S.CERAMIC C1608 CH 1H 560J-T-A
C343	4030007110	S.CERAMIC C1608 CH 1H 680J-T-A
C345	4030007100	S.CERAMIC C1608 CH 1H 560J-T-A
C347	4030011600	S.CERAMIC C1608 JB 1C 104KT-N
C348	4030011600	S.CERAMIC C1608 JB 1C 104KT-N
C363	4030011600	S.CERAMIC C1608 JB 1C 104KT-N
C366	4030007090	S.CERAMIC C1608 CH 1H 470J-T-A
C370	4030007090	S.CERAMIC C1608 CH 1H 470J-T-A
C376	4030011600	S.CERAMIC C1608 JB 1C 104KT-N
C411	4030011600	S.CERAMIC C1608 JB 1C 104KT-N
C431	4030011600	S.CERAMIC C1608 JB 1C 104KT-N
C432	4030011600	S.CERAMIC C1608 JB 1C 104KT-N
C441	4030011600	S.CERAMIC C1608 JB 1C 104KT-N
C442	4030011600	S.CERAMIC C1608 JB 1C 104KT-N
C443	4030011600	S.CERAMIC C1608 JB 1C 104KT-N
C445	4030011600	S.CERAMIC C1608 JB 1C 104KT-N
C446	4510006670	S.ELECTROLYTIC ECEV1CA471P
C447	4030012610	S.CERAMIC C2012 JB 1C 474K-T-A
C451	4030011600	S.CERAMIC C1608 JB 1C 104KT-N
C452	4030011600	S.CERAMIC C1608 JB 1C 104KT-N
C453	4030011600	S.CERAMIC C1608 JB 1C 104KT-N
C454	4030011600	S.CERAMIC C1608 JB 1C 104KT-N
C455	4030011600	S.CERAMIC C1608 JB 1C 104KT-N
C456	4030011600	S.CERAMIC C1608 JB 1C 104KT-N
C457	4030011600	S.CERAMIC C1608 JB 1C 104KT-N
C481	4030007170	S.CERAMIC C1608 CH 1H 221J-T-A
C491	4030011600	S.CERAMIC C1608 JB 1C 104KT-N
C501	4030007070	S.CERAMIC C1608 CH 1H 330J-T-A
C502	4030007090	S.CERAMIC C1608 CH 1H 470J-T-A
C503	4030007080	S.CERAMIC C1608 CH 1H 390J-T-A
C504	4030007030	S.CERAMIC C1608 CH 1H 150J-T-A
C505	4030007100	S.CERAMIC C1608 CH 1H 560J-T-A
C506	4030011600	S.CERAMIC C1608 JB 1C 104KT-N
C507	4030007000	S.CERAMIC C1608 CH 1H 090D-T-A
C508	4030007050	S.CERAMIC C1608 CH 1H 220J-T-A
C509	4030007140	S.CERAMIC C1608 CH 1H 121J-T-A
C511	4030011600	S.CERAMIC C1608 JB 1C 104KT-N
C512	4030011600	S.CERAMIC C1608 JB 1C 104KT-N
C513	4030011600	S.CERAMIC C1608 JB 1C 104KT-N
C514	4030011600	S.CERAMIC C1608 JB 1C 104KT-N
C515	4030011600	S.CERAMIC C1608 JB 1C 104KT-N
C516	4030006990	S.CERAMIC C1608 CH 1H 080D-T-A
C517	4030006990	S.CERAMIC C1608 CH 1H 080D-T-A
C519	4030007080	S.CERAMIC C1608 CH 1H 390J-T-A
C520	4030007100	S.CERAMIC C1608 CH 1H 560J-T-A
C531	4030011600	S.CERAMIC C1608 JB 1C 104KT-N
C532	4030011340	S.CERAMIC C1608 CH 1H 471J-T-A
C533	4030006880	S.CERAMIC C1608 JB 1H 472K-T-A
C534	4030011340	S.CERAMIC C1608 CH 1H 471J-T-A
C535	4030006880	S.CERAMIC C1608 JB 1H 472K-T-A
C536	4030006880	S.CERAMIC C1608 JB 1H 472K-T-A
C537	4030006880	S.CERAMIC C1608 JB 1H 472K-T-A
C538	4030011600	S.CERAMIC C1608 JB 1C 104KT-N
C539	4030011600	S.CERAMIC C1608 JB 1C 104KT-N
C540	4510004630	S.ELECTROLYTIC ECEV1CA100SR
C541	4030006880	S.CERAMIC C1608 JB 1H 472K-T-A
C542	4030006880	S.CERAMIC C1608 JB 1H 472K-T-A
C551	4030011600	S.CERAMIC C1608 JB 1C 104KT-N
C552	4030007060	S.CERAMIC C1608 CH 1H 270J-T-A
C553	4510004630	S.ELECTROLYTIC ECEV1CA100SR
C554	4030007010	S.CERAMIC C1608 CH 1H 100D-T-A
C555	4540000020	S.TRIMMER TZVY22060A110
C556	4030011600	S.CERAMIC C1608 JB 1C 104KT-N
C557	4030011600	S.CERAMIC C1608 JB 1C 104KT-N
C561	4030007080	S.CERAMIC C1608 CH 1H 390J-T-A
C563	4030011600	S.CERAMIC C1608 JB 1C 104KT-N
C564	4030006860	S.CERAMIC C1608 JB 1H 102K-T-A
C565	4030009650	S.CERAMIC C1608 CH 1H 240J-T-A
C566	4030007010	S.CERAMIC C1608 CH 1H 100D-T-A
C567	4030007070	S.CERAMIC C1608 CH 1H 330J-T-A
C568	4030006980	S.CERAMIC C1608 CH 1H 070D-T-A
C569	4030007060	S.CERAMIC C1608 CH 1H 270J-T-A
C570	4030011600	S.CERAMIC C1608 JB 1C 104KT-N
C601	4030007070	S.CERAMIC C1608 CH 1H 330J-T-A
C602	4030007090	S.CERAMIC C1608 CH 1H 470J-T-A

[RF-A UNIT]

REF NO.	ORDER NO.	DESCRIPTION
C603	4030007080	S.CERAMIC C1608 CH 1H 390J-T-A
C604	4030007030	S.CERAMIC C1608 CH 1H 150J-T-A
C605	4030007100	S.CERAMIC C1608 CH 1H 560J-T-A
C606	4030011600	S.CERAMIC C1608 JB 1C 104KT-N
C607	4030007000	S.CERAMIC C1608 CH 1H 090D-T-A
C608	4030007050	S.CERAMIC C1608 CH 1H 220J-T-A
C609	4030007140	S.CERAMIC C1608 CH 1H 121J-T-A
C611	4030011600	S.CERAMIC C1608 JB 1C 104KT-N
C612	4030011600	S.CERAMIC C1608 JB 1C 104KT-N
C613	4030011600	S.CERAMIC C1608 JB 1C 104KT-N
C614	4030011600	S.CERAMIC C1608 JB 1C 104KT-N
C615	4030011600	S.CERAMIC C1608 JB 1C 104KT-N
C616	4030006990	S.CERAMIC C1608 CH 1H 080D-T-A
C617	4030006990	S.CERAMIC C1608 CH 1H 080D-T-A
C619	4030007080	S.CERAMIC C1608 CH 1H 390J-T-A
C620	4030007100	S.CERAMIC C1608 CH 1H 560J-T-A
C631	4030011600	S.CERAMIC C1608 JB 1C 104KT-N
C632	4030011340	S.CERAMIC C1608 CH 1H 471J-T-A
C633	4030006880	S.CERAMIC C1608 JB 1H 472K-T-A
C634	4030011340	S.CERAMIC C1608 CH 1H 471J-T-A
C635	4030006880	S.CERAMIC C1608 JB 1H 472K-T-A
C636	4030006880	S.CERAMIC C1608 JB 1H 472K-T-A
C637	4030006880	S.CERAMIC C1608 JB 1H 472K-T-A
C638	4030011600	S.CERAMIC C1608 JB 1C 104KT-N
C639	4030011600	S.CERAMIC C1608 JB 1C 104KT-N
C640	4510004630	S.ELECTROLYTIC ECEV1CA100SR
C651	4030011600	S.CERAMIC C1608 JB 1C 104KT-N
C652	4030007060	S.CERAMIC C1608 CH 1H 270J-T-A
C653	4510004630	S.ELECTROLYTIC ECEV1CA100SR
C654	4030007010	S.CERAMIC C1608 CH 1H 100D-T-A
C655	4540000020	S.TRIMMER TZVY22060A110
C656	4030011600	S.CERAMIC C1608 JB 1C 104KT-N
C657	4030011600	S.CERAMIC C1608 JB 1C 104KT-N
C661	4030007080	S.CERAMIC C1608 CH 1H 390J-T-A
C663	4030011600	S.CERAMIC C1608 JB 1C 104KT-N
C664	4030006860	S.CERAMIC C1608 JB 1H 102K-T-A
C665	4030009650	S.CERAMIC C1608 CH 1H 240J-T-A
C666	4030007010	S.CERAMIC C1608 CH 1H 100D-T-A
C667	4030007070	S.CERAMIC C1608 CH 1H 330J-T-A
C668	4030006980	S.CERAMIC C1608 CH 1H 070D-T-A
C669	4030007060	S.CERAMIC C1608 CH 1H 270J-T-A
C701	4030006880	S.CERAMIC C1608 JB 1H 472K-T-A
C702	4030006880	S.CERAMIC C1608 JB 1H 472K-T-A
C703	4030007030	S.CERAMIC C1608 CH 1H 150J-T-A
C704	4030006880	S.CERAMIC C1608 JB 1H 472K-T-A
C705	4030011600	S.CERAMIC C1608 JB 1C 104KT-N
C706	4030011600	S.CERAMIC C1608 JB 1C 104KT-N
C710	4030009920	S.CERAMIC C1608 CH 1H 050B-T-A
C711	4030006880	S.CERAMIC C1608 JB 1H 472K-T-A
C712	4030006880	S.CERAMIC C1608 JB 1H 472K-T-A
C713	4030006880	S.CERAMIC C1608 JB 1H 472K-T-A
C714	4030006950	S.CERAMIC C1608 CH 1H 040C-T-A
C715	4030006940	S.CERAMIC C1608 CH 1H 030C-T-A
C716	4030006950	S.CERAMIC C1608 CH 1H 040C-T-A
C721	4030006880	S.CERAMIC C1608 JB 1H 472K-T-A
C722	4030006860	S.CERAMIC C1608 JB 1H 102K-T-A
C723	4030007010	S.CERAMIC C1608 CH 1H 100D-T-A
C724	4030006880	S.CERAMIC C1608 JB 1H 472K-T-A
C725	4030007130	S.CERAMIC C1608 CH 1H 101J-T-A
C726	4030006880	S.CERAMIC C1608 JB 1H 472K-T-A
C727	4030007020	S.CERAMIC C1608 CH 1H 120J-T-A
C728	4030006880	S.CERAMIC C1608 JB 1H 472K-T-A
C731	4030011600	S.CERAMIC C1608 JB 1C 104KT-N
C732	4030006880	S.CERAMIC C1608 JB 1H 472K-T-A
C742	4030011340	S.CERAMIC C1608 CH 1H 471J-T-A
C743	4030011600	S.CERAMIC C1608 JB 1C 104KT-N
C744	4030011600	S.CERAMIC C1608 JB 1C 104KT-N
C745	4030011600	S.CERAMIC C1608 JB 1C 104KT-N
C746	4030011600	S.CERAMIC C1608 JB 1C 104KT-N
C751	4030006860	S.CERAMIC C1608 JB 1H 102K-T-A
C752	4030006880	S.CERAMIC C1608 JB 1H 472K-T-A
C753	4030006860	S.CERAMIC C1608 JB 1H 102K-T-A
C754	4030006980	S.CERAMIC C1608 CH 1H 070D-T-A
C755	4030007010	S.CERAMIC C1608 CH 1H 100D-T-A
C756	4030006880	S.CERAMIC C1608 JB 1H 472K-T-A
C757	4030006880	S.CERAMIC C1608 JB 1H 472K-T-A
C758	4030006880	S.CERAMIC C1608 JB 1H 472K-T-A
C759	4030006980	S.CERAMIC C1608 CH 1H 070D-T-A
C760	4030007100	S.CERAMIC C1608 CH 1H 560J-T-A
C761	4030007100	S.CERAMIC C1608 CH 1H 560J-T-A
C763	4030011600	S.CERAMIC C1608 JB 1C 104KT-N
C771	4030006880	S.CERAMIC C1608 JB 1H 472K-T-A

S.=Surface mount

[RF-A UNIT]

REF NO.	ORDER NO.	DESCRIPTION	
C772	4030006880	S.CERAMIC	C1608 JB 1H 472K-T-A
C774	4030009920	S.CERAMIC	C1608 CH 1H 050B-T-A
C775	4030007040	S.CERAMIC	C1608 CH 1H 180J-T-A
C781	4030011600	S.CERAMIC	C1608 JB 1C 104KT-N
C802	4030006880	S.CERAMIC	C1608 JB 1H 472K-T-A
C803	4030006880	S.CERAMIC	C1608 JB 1H 472K-T-A
C805	4030006880	S.CERAMIC	C1608 JB 1H 472K-T-A
C806	4030008920	S.CERAMIC	C1608 JB 1C 473K-T-A
C813	4030007010	S.CERAMIC	C1608 CH 1H 100D-T-A
C814	4030006860	S.CERAMIC	C1608 JB 1H 102K-T-A
C815	4030007030	S.CERAMIC	C1608 CH 1H 150J-T-A
C816	4030006880	S.CERAMIC	C1608 JB 1H 472K-T-A
C818	4030007030	S.CERAMIC	C1608 CH 1H 150J-T-A
C819	4030009520	S.CERAMIC	C1608 CH 1H 020B-T-A
C820	4030006860	S.CERAMIC	C1608 JB 1H 102K-T-A
C823	4030006880	S.CERAMIC	C1608 JB 1H 472K-T-A
C833	4030006980	S.CERAMIC	C1608 CH 1H 070D-T-A
C834	4030006880	S.CERAMIC	C1608 JB 1H 472K-T-A
C835	4030006880	S.CERAMIC	C1608 JB 1H 472K-T-A
C840	4030006980	S.CERAMIC	C1608 CH 1H 070D-T-A
C841	4030007130	S.CERAMIC	C1608 CH 1H 101J-T-A
C844	4030006880	S.CERAMIC	C1608 JB 1H 472K-T-A
C845	4030006860	S.CERAMIC	C1608 JB 1H 102K-T-A
C846	4030006880	S.CERAMIC	C1608 JB 1H 472K-T-A
C847	4030011600	S.CERAMIC	C1608 JB 1C 104KT-N
C848	4030011600	S.CERAMIC	C1608 JB 1C 104KT-N
C862	4510004630	S.ELECTROLYTIC	ECEV1CA100SR
C863	4030006860	S.CERAMIC	C1608 JB 1H 102K-T-A
C872	4030011600	S.CERAMIC	C1608 JB 1C 104KT-N
C873	4030011600	S.CERAMIC	C1608 JB 1C 104KT-N
C874	4030006880	S.CERAMIC	C1608 JB 1H 472K-T-A
C875	4030008920	S.CERAMIC	C1608 JB 1C 473K-T-A
C901	4030011600	S.CERAMIC	C1608 JB 1C 104KT-N
C902	4030011600	S.CERAMIC	C1608 JB 1C 104KT-N
C903	4030011600	S.CERAMIC	C1608 JB 1C 104KT-N
C904	4030011600	S.CERAMIC	C1608 JB 1C 104KT-N
C905	4030011600	S.CERAMIC	C1608 JB 1C 104KT-N
C941	4030006880	S.CERAMIC	C1608 JB 1H 472K-T-A
C943	4030011600	S.CERAMIC	C1608 JB 1C 104KT-N
C951	4510004630	S.ELECTROLYTIC	ECEV1CA100SR
C952	4030011600	S.CERAMIC	C1608 JB 1C 104KT-N
C953	4510004630	S.ELECTROLYTIC	ECEV1CA100SR
C954	4030011600	S.CERAMIC	C1608 JB 1C 104KT-N
C955	4510004630	S.ELECTROLYTIC	ECEV1CA100SR
C956	4030011600	S.CERAMIC	C1608 JB 1C 104KT-N
C961	4030007100	S.CERAMIC	C1608 CH 1H 560J-T-A
C962	4030007110	S.CERAMIC	C1608 CH 1H 680J-T-A
C963	4030007130	S.CERAMIC	C1608 CH 1H 101J-T-A
C964	4030007040	S.CERAMIC	C1608 CH 1H 180J-T-A
C965	4030007120	S.CERAMIC	C1608 CH 1H 820J-T-A
C966	4030011600	S.CERAMIC	C1608 JB 1C 104KT-N
C967	4030011600	S.CERAMIC	C1608 JB 1C 104KT-N
C968	4030011600	S.CERAMIC	C1608 JB 1C 104KT-N
C969	4030011600	S.CERAMIC	C1608 JB 1C 104KT-N
C970	4030006880	S.CERAMIC	C1608 JB 1H 472K-T-A
C2001	4030006880	S.CERAMIC	C1608 JB 1H 472K-T-A
C2002	4030006880	S.CERAMIC	C1608 JB 1H 472K-T-A
C2003	4030006880	S.CERAMIC	C1608 JB 1H 472K-T-A
C2004	4030006880	S.CERAMIC	C1608 JB 1H 472K-T-A
C2005	4030006880	S.CERAMIC	C1608 JB 1H 472K-T-A
C2006	4030006880	S.CERAMIC	C1608 JB 1H 472K-T-A
C2007	4030006880	S.CERAMIC	C1608 JB 1H 472K-T-A
C2008	4030006880	S.CERAMIC	C1608 JB 1H 472K-T-A
C2009	4030006880	S.CERAMIC	C1608 JB 1H 472K-T-A
C2010	4030006880	S.CERAMIC	C1608 JB 1H 472K-T-A
RL101	6330001320	RELAY	AHY103
RL121	6330001320	RELAY	AHY103
RL122	6330001320	RELAY	AHY103
CP871	6910009670	S.CHECK P	HK3-S-T
J101	6510007020	CONNECTOR	TMP-J01X-V6
J111	6450001130	CONNECTOR	JPJ2042-01-110
J151	6510007020	CONNECTOR	TMP-J01X-V6
J201	6910013780	CONNECTOR	IMSA-9201B-05Z330-T
J202	6910013780	CONNECTOR	IMSA-9201B-05Z330-T
J203	6910013780	CONNECTOR	IMSA-9201B-05Z330-T
J481	6510007020	CONNECTOR	TMP-J01X-V6

[RF-A UNIT]

REF NO.	ORDER NO.	DESCRIPTION	
J561	6510007020	CONNECTOR	TMP-J01X-V6
J661	6510007020	CONNECTOR	TMP-J01X-V6
J711	6510007020	CONNECTOR	TMP-J01X-V6
J831	6510007020	CONNECTOR	TMP-J01X-V6
J841	6510007020	CONNECTOR	TMP-J01X-V6
J901	6510007020	CONNECTOR	TMP-J01X-V6
J951	6510022590	S.CONNECTOR	22FMN-BMTTR-A-TBT
DS111	5080000370	LAMP	HRS-4160A
W361	7030003860	S.JUMPER	ERJ3GE JPW V
W362	7030003860	S.JUMPER	ERJ3GE JPW V
W443	7030000010	S.JUMPER	MCR10EZHU JPW (000)
W562	7030003860	S.JUMPER	ERJ3GE JPW V
W662	7030003860	S.JUMPER	ERJ3GE JPW V
W941	7030003860	S.JUMPER	ERJ3GE JPW V
WS1	8970023930	CABLE	SX2178 1.5D COAXIAL TUBE (1)/RF-A
EP1	0910054313	PCB	B 5706C

[BPF BOARD]

REF NO.	ORDER NO.	DESCRIPTION	
D2001	1750000850	S.DIODE	MMBV3700LT1
D2002	1790000620	S.DIODE	MA77 (TX)
D2021	1750000850	S.DIODE	MMBV3700LT1
D2022	1790000620	S.DIODE	MA77 (TX)
D2041	1750000850	S.DIODE	MMBV3700LT1
D2042	1790000620	S.DIODE	MA77 (TX)
D2061	1750000850	S.DIODE	MMBV3700LT1
D2062	1790000620	S.DIODE	MA77 (TX)
D2081	1750000850	S.DIODE	MMBV3700LT1
D2082	1790000620	S.DIODE	MA77 (TX)
L2001	6180002850	COIL	EL0606SKI-3R9J
L2002	6180003280	COIL	EL0606SKI-120J
L2003	6180003280	COIL	EL0606SKI-120J
L2004	6180003280	COIL	EL0606SKI-120J
L2005	6180002850	COIL	EL0606SKI-3R9J
L2021	6180002860	COIL	EL0606SKI-4R7J
L2022	6180002870	COIL	EL0606SKI-5R6J
L2023	6180002870	COIL	EL0606SKI-5R6J
L2024	6180002870	COIL	EL0606SKI-5R6J
L2025	6180002860	COIL	EL0606SKI-4R7J
L2041	6180002820	COIL	EL0606SKI-2R2J
L2042	6180002880	COIL	EL0606SKI-6R8J
L2043	6180002880	COIL	EL0606SKI-6R8J
L2044	6180002880	COIL	EL0606SKI-6R8J
L2045	6180002820	COIL	EL0606SKI-2R2J
L2061	6180002820	COIL	EL0606SKI-2R2J
L2062	6180002840	COIL	EL0606SKI-3R3J
L2063	6180002840	COIL	EL0606SKI-3R3J
L2064	6180002840	COIL	EL0606SKI-3R3J
L2065	6180002820	COIL	EL0606SKI-2R2J
L2081	6180002790	COIL	EL0606SKI-1R2J
L2082	6180002830	COIL	EL0606SKI-2R7J
L2083	6180002830	COIL	EL0606SKI-2R7J
L2084	6180002830	COIL	EL0606SKI-2R7J
L2085	6180002790	COIL	EL0606SKI-1R2J
R2001	7030000260	S.RESISTOR	MCR10EZHU 100 Ω (101)
R2021	7030000260	S.RESISTOR	MCR10EZHU 100 Ω (101)
R2041	7030000260	S.RESISTOR	MCR10EZHU 100 Ω (101)
R2061	7030000260	S.RESISTOR	MCR10EZHU 100 Ω (101)
R2081	7030000260	S.RESISTOR	MCR10EZHU 100 Ω (101)
C2001	4030017810	S.CERAMIC	C1608 CH 1H 102J-T-N
C2002	4030017810	S.CERAMIC	C1608 CH 1H 102J-T-N
C2003	4030011600	S.CERAMIC	C1608 JB 1C 104KT-N

S.=Surface mount

[BPF BOARD]

REF NO.	ORDER NO.	DESCRIPTION
C2004	4030010760	S.CERAMIC C1608 CH 1H 331J-T-A
C2005	4030007140	S.CERAMIC C1608 CH 1H 121J-T-A
C2006	4030007160	S.CERAMIC C1608 CH 1H 181J-T-A
C2007	4030007060	S.CERAMIC C1608 CH 1H 270J-T-A
C2008	4030010760	S.CERAMIC C1608 CH 1H 331J-T-A
C2009	4030007090	S.CERAMIC C1608 CH 1H 470J-T-A
C2010	4030007160	S.CERAMIC C1608 CH 1H 181J-T-A
C2011	4030007060	S.CERAMIC C1608 CH 1H 270J-T-A
C2012	4030010760	S.CERAMIC C1608 CH 1H 331J-T-A
C2013	4030007140	S.CERAMIC C1608 CH 1H 121J-T-A
C2014	4030017810	S.CERAMIC C1608 CH 1H 102J-T-N
C2015	4030017810	S.CERAMIC C1608 CH 1H 102J-T-N
C2016	4030011600	S.CERAMIC C1608 JB 1C 104KT-N
C2021	4030017800	S.CERAMIC C1608 CH 1H 561J-T-N
C2022	4030010760	S.CERAMIC C1608 CH 1H 331J-T-A
C2023	4030011600	S.CERAMIC C1608 JB 1C 104KT-N
C2024	4030010760	S.CERAMIC C1608 CH 1H 331J-T-A
C2025	4030007080	S.CERAMIC C1608 CH 1H 390J-T-A
C2026	4030010760	S.CERAMIC C1608 CH 1H 331J-T-A
C2027	4030007100	S.CERAMIC C1608 CH 1H 560J-T-A
C2028	4030010760	S.CERAMIC C1608 CH 1H 331J-T-A
C2029	4030007090	S.CERAMIC C1608 CH 1H 470J-T-A
C2030	4030010760	S.CERAMIC C1608 CH 1H 331J-T-A
C2031	4030007100	S.CERAMIC C1608 CH 1H 560J-T-A
C2032	4030010760	S.CERAMIC C1608 CH 1H 331J-T-A
C2033	4030007080	S.CERAMIC C1608 CH 1H 390J-T-A
C2034	4030017800	S.CERAMIC C1608 CH 1H 561J-T-N
C2035	4030010760	S.CERAMIC C1608 CH 1H 331J-T-A
C2036	4030011600	S.CERAMIC C1608 JB 1C 104KT-N
C2041	4030017800	S.CERAMIC C1608 CH 1H 561J-T-N
C2042	4030011330	S.CERAMIC C1608 CH 1H 391J-T-A
C2043	4030011600	S.CERAMIC C1608 JB 1C 104KT-N
C2044	4030007160	S.CERAMIC C1608 CH 1H 181J-T-A
C2045	4030007070	S.CERAMIC C1608 CH 1H 330J-T-A
C2046	4030007120	S.CERAMIC C1608 CH 1H 820J-T-A
C2047	4030007030	S.CERAMIC C1608 CH 1H 150J-T-A
C2048	4030007140	S.CERAMIC C1608 CH 1H 121J-T-A
C2049	4030007100	S.CERAMIC C1608 CH 1H 560J-T-A
C2050	4030007120	S.CERAMIC C1608 CH 1H 820J-T-A
C2051	4030007030	S.CERAMIC C1608 CH 1H 150J-T-A
C2052	4030007160	S.CERAMIC C1608 CH 1H 181J-T-A
C2053	4030007070	S.CERAMIC C1608 CH 1H 330J-T-A
C2054	4030017800	S.CERAMIC C1608 CH 1H 561J-T-N
C2055	4030011330	S.CERAMIC C1608 CH 1H 391J-T-A
C2056	4030011600	S.CERAMIC C1608 JB 1C 104KT-N
C2061	4030010760	S.CERAMIC C1608 CH 1H 331J-T-A
C2062	4030007150	S.CERAMIC C1608 CH 1H 151J-T-A
C2063	4030011600	S.CERAMIC C1608 JB 1C 104KT-N
C2064	4030007150	S.CERAMIC C1608 CH 1H 151J-T-A
C2065	4030007060	S.CERAMIC C1608 CH 1H 270J-T-A
C2066	4030007140	S.CERAMIC C1608 CH 1H 121J-T-A
C2067	4030007060	S.CERAMIC C1608 CH 1H 270J-T-A
C2068	4030007150	S.CERAMIC C1608 CH 1H 151J-T-A
C2069	4030007010	S.CERAMIC C1608 CH 1H 100D-T-A
C2070	4030007140	S.CERAMIC C1608 CH 1H 121J-T-A
C2071	4030007060	S.CERAMIC C1608 CH 1H 270J-T-A
C2072	4030007150	S.CERAMIC C1608 CH 1H 151J-T-A
C2073	4030007060	S.CERAMIC C1608 CH 1H 270J-T-A
C2074	4030010760	S.CERAMIC C1608 CH 1H 331J-T-A
C2075	4030007150	S.CERAMIC C1608 CH 1H 151J-T-A
C2076	4030011600	S.CERAMIC C1608 JB 1C 104KT-N
C2081	4030007170	S.CERAMIC C1608 CH 1H 221J-T-A
C2082	4030007170	S.CERAMIC C1608 CH 1H 221J-T-A
C2083	4030011600	S.CERAMIC C1608 JB 1C 104KT-N
C2084	4030007130	S.CERAMIC C1608 CH 1H 101J-T-A
C2085	4030007050	S.CERAMIC C1608 CH 1H 220J-T-A
C2086	4030007080	S.CERAMIC C1608 CH 1H 390J-T-A
C2087	4030007070	S.CERAMIC C1608 CH 1H 330J-T-A
C2088	4030007120	S.CERAMIC C1608 CH 1H 820J-T-A
C2089	4030007050	S.CERAMIC C1608 CH 1H 220J-T-A
C2090	4030007080	S.CERAMIC C1608 CH 1H 390J-T-A
C2091	4030007070	S.CERAMIC C1608 CH 1H 330J-T-A
C2092	4030007130	S.CERAMIC C1608 CH 1H 101J-T-A
C2093	4030007050	S.CERAMIC C1608 CH 1H 220J-T-A
C2094	4030007170	S.CERAMIC C1608 CH 1H 221J-T-A
C2095	4030007170	S.CERAMIC C1608 CH 1H 221J-T-A
C2096	4030011600	S.CERAMIC C1608 JB 1C 104KT-N
EP2001	0910054321	PCB B 5732A

[MAIN-A UNIT]

REF NO.	ORDER NO.	DESCRIPTION
IC101	1110000960	S.IC NJM4558M-T1
IC151	1130006220	S.IC TC4W53FU (TE12L)
IC152	1130003610	S.IC TC4SU69F (TE85R)
IC153	1130003610	S.IC TC4SU69F (TE85R)
IC201	1110005420	S.IC BA15532F-E2
IC221	1110004840	S.IC NJM1496V-TE1
IC301	1130006220	S.IC TC4W53FU (TE12L)
IC311	1110003300	S.IC M5282FP 70CD
IC321	1110000960	S.IC NJM4558M-T1
IC331	1130006220	S.IC TC4W53FU (TE12L)
IC332	1110003090	IC LA4425A
IC361	1130006220	S.IC TC4W53FU (TE12L)
IC362	1130006220	S.IC TC4W53FU (TE12L)
IC371	1110003300	S.IC M5282FP 70CD
IC372	1110003670	S.IC BA3308F-T1
IC451	1140005280	S.IC μPC5023GS-077-E1
IC551	1110003870	S.IC NJM2058M-T1
IC571	1110000960	S.IC NJM4558M-T1
IC801	1180002000	REG BA033T
IC802	1180001070	S.IC TA7805F (TE16L)
IC803	1180001070	S.IC TA7805F (TE16L)
IC805	1180000720	S.IC AN79L05M-(E1)
IC3001	1190001640	S.IC ISD4003-04MS
IC3002	1130008230	S.IC BU4053BCFV-E2
IC3003	1110003300	S.IC M5282FP 70CD
IC3004	1110000960	S.IC NJM4558M-T1
IC3005	1130008230	S.IC BU4053BCFV-E2
IC3501	1140008590	S.IC HD64F2357F20
IC3502	1130009110	S.IC S-80942ANMP-DD6-T2
IC3503	1140005880	S.IC X25320S8I-2.7T6
IC3504	1130007450	S.IC RTC-4553A
IC3551	1190000950	S.IC S1D13504F00A000 (SED1354F0A)
IC3552	1130007180	S.IC TC7WU04FU (TE12L)
IC3553	1130009360	S.IC LH61665AS-60A
IC3631	1130008230	S.IC BU4053BCFV-E2
IC3651	1120002770	S.IC TC74AC244FT (EL)
IC3652	1120002780	S.IC TC74AC245FT (EL)
IC3653	1120002790	S.IC TC74AC574FT (EL)
IC3654	1120002790	S.IC TC74AC574FT (EL)
IC3655	1120002880	S.IC TC74AC08FT (EL)
IC3656	1120002760	S.IC TC74AC32FT (EL)
IC3751	1110004310	S.IC M62352GP 75EC
IC3752	1130007570	S.IC BU4094BCFV-E2
IC3753	1130007570	S.IC BU4094BCFV-E2
IC3771	1130007110	S.IC TC7W04FU (TE12L)
Q131	1590002710	S.TRANSISTOR UMH11NTN
Q132	1590001150	S.TRANSISTOR UN9211 (TX)
Q141	1580000620	S.FET 3SK131-T2 MAS
Q241	1560000560	S.FET 2SK882-GR (TE85L)
Q261	1560000560	S.FET 2SK882-GR (TE85L)
Q271	1560000560	S.FET 2SK882-GR (TE85L)
Q272	1560000560	S.FET 2SK882-GR (TE85L)
Q273	1560000560	S.FET 2SK882-GR (TE85L)
Q274	1530002060	S.TRANSISTOR 2SC4081 T107 R
Q275	1510000510	S.TRANSISTOR 2SA1576A T106R
Q276	1530002060	S.TRANSISTOR 2SC4081 T107 R
Q278	1590002530	S.TRANSISTOR UN911H (TX)
Q279	1530002060	S.TRANSISTOR 2SC4081 T107 R
Q331	1540000470	S.TRANSISTOR 2SD1801S-TL
Q333	1590002770	S.FET CPH3404-TL
Q334	1590001150	S.TRANSISTOR UN9211 (TX)
Q351	1590001150	S.TRANSISTOR UN9211 (TX)
Q471	1530002060	S.TRANSISTOR 2SC4081 T107 R
Q501	1590002710	S.TRANSISTOR UMH11NTN
Q502	1590002390	S.TRANSISTOR UMH4N TN
Q503	1530002060	S.TRANSISTOR 2SC4081 T107 R
Q504	1530002060	S.TRANSISTOR 2SC4081 T107 R
Q505	1510000510	S.TRANSISTOR 2SA1576A T106R
Q506	1590002150	S.TRANSISTOR DTC144TE TL
Q507	1590001870	S.TRANSISTOR DTA114EE TL
Q521	1510000510	S.TRANSISTOR 2SA1576A T106R
Q601	1540000440	S.TRANSISTOR 2SD1619-T-TD
Q602	1530002060	S.TRANSISTOR 2SC4081 T107 R
Q611	1540000440	S.TRANSISTOR 2SD1619-T-TD
Q612	1530002060	S.TRANSISTOR 2SC4081 T107 R
Q621	1510000920	S.TRANSISTOR 2SA1577 T107 Q
Q622	1590002710	S.TRANSISTOR UMH11NTN
Q631	1530002060	S.TRANSISTOR 2SC4081 T107 R
Q632	1530002060	S.TRANSISTOR 2SC4081 T107 R
Q651	1590001870	S.TRANSISTOR DTA114EE TL

S.=Surface mount

[MAIN-A UNIT]

REF NO.	ORDER NO.	DESCRIPTION	
Q652	1540000440	S.TRANSISTOR	2SD1619-T-TD
Q653	1590001150	S.TRANSISTOR	UN9211 (TX)
Q691	1590001150	S.TRANSISTOR	UN9211 (TX)
Q801	1530002060	S.TRANSISTOR	2SC4081 T107 R
Q803	1590002430	S.TRANSISTOR	DTA144EE TL
Q804	1540000470	S.TRANSISTOR	2SD1801S-TL
Q3002	1590001870	S.TRANSISTOR	DTA114EE TL
Q3504	1510000510	S.TRANSISTOR	2SA1576A T106R
Q3505	1590001940	S.TRANSISTOR	DTC144EE TL
Q3551	1590001870	S.TRANSISTOR	DTA114EE TL
Q3701	1590001150	S.TRANSISTOR	UN9211 (TX)
Q3751	1590001960	S.TRANSISTOR	XP4311 (TX)
Q3771	1510000510	S.TRANSISTOR	2SA1576A T106R
Q3772	1530002060	S.TRANSISTOR	2SC4081 T107 R
Q3773	1590001150	S.TRANSISTOR	UN9211 (TX)
D111	1790001620	S.DIODE	1SV308 (TPL3)
D112	1790001620	S.DIODE	1SV308 (TPL3)
D113	1790001620	S.DIODE	1SV308 (TPL3)
D114	1790001620	S.DIODE	1SV308 (TPL3)
D115	1790000620	S.DIODE	MA77 (TX)
D116	1790000620	S.DIODE	MA77 (TX)
D117	1790000620	S.DIODE	MA77 (TX)
D118	1790000620	S.DIODE	MA77 (TX)
D251	1750000520	S.DIODE	DAN222TL
D252	1750000520	S.DIODE	DAN222TL
D271	1790001210	S.DIODE	1SS375-TL
D273	1790001250	S.DIODE	MA2S111-(TX)
D351	1750000520	S.DIODE	DAN222TL
D501	1790001040	S.ZENER	MA8033-L (TX)
D502	1790001250	S.DIODE	MA2S111-(TX)
D504	1790001240	S.DIODE	MA2S728-(TX)
D505	1790001040	S.ZENER	MA8033-L (TX)
D531	1790001250	S.DIODE	MA2S111-(TX)
D532	1790001250	S.DIODE	MA2S111-(TX)
D533	1790001250	S.DIODE	MA2S111-(TX)
D541	1790001250	S.DIODE	MA2S111-(TX)
D542	1790001250	S.DIODE	MA2S111-(TX)
D561	1790001250	S.DIODE	MA2S111-(TX)
D571	1790001250	S.DIODE	MA2S111-(TX)
D601	1750000370	S.DIODE	DA221 TL
D611	1750000370	S.DIODE	DA221 TL
D631	1790001250	S.DIODE	MA2S111-(TX)
D632	1790001250	S.DIODE	MA2S111-(TX)
D691	1750000520	S.DIODE	DAN222TL
D801	1730002320	S.ZENER	MA8051-M (TX)
D3001	1750000370	S.DIODE	DA221 TL
D3504	1790001250	S.DIODE	MA2S111-(TX)
D3505	1790001250	S.DIODE	MA2S111-(TX)
D3506	1790001250	S.DIODE	MA2S111-(TX)
D3507	1750000370	S.DIODE	DA221 TL
D3508	1790001670	S.DIODE	RB706F-40T106
D3509	1790001670	S.DIODE	RB706F-40T106
D3601	1790001250	S.DIODE	MA2S111-(TX)
D3602	1790001670	S.DIODE	RB706F-40T106
D3701	1750000520	S.DIODE	DAN222TL
D3702	1160000140	S.DIODE	DAP222 TL
D3750	1790001250	S.DIODE	MA2S111-(TX)
D3751	1790001250	S.DIODE	MA2S111-(TX)
[USA], [KOR], [ESP]			
D3752	1790001250	S.DIODE	MA2S111-(TX)
D3753	1790001250	S.DIODE	MA2S111-(TX)
[USA], [EUR], [FRA]			
D3754	1790001250	S.DIODE	MA2S111-(TX)
[EUR], [FRA], [ITA], [KOR]			
D3755	1790001250	S.DIODE	MA2S111-(TX)
[FRA], [ITA], [KOR], [ESP]			
D3756	1790001250	S.DIODE	MA2S111-(TX)
[FRA], [ITA], [KOR], [ESP]			
D3757	1790001250	S.DIODE	MA2S111-(TX)
D3758	1790001250	S.DIODE	MA2S111-(TX)
D3761	1790001250	S.DIODE	MA2S111-(TX)
D3762	1790001250	S.DIODE	MA2S111-(TX)
[USA], [EUR], [ITA], [KOR], [ESP]			
D3763	1790001250	S.DIODE	MA2S111-(TX) [EUR], [FRA], [ITA]
D3771	1750000520	S.DIODE	DAN222TL

[MAIN-A UNIT]

REF NO.	ORDER NO.	DESCRIPTION	
FI111	2020000260	CERAMIC	CFK455E10
FI131	2020001740	CERAMIC	CFWM455D
FI133	2020001510	CERAMIC	CFWS455IT
X3501	60500009520	S.XTAL	CR-520 (19.6608 MHz+)
X3551	6060000740	S.CERAMIC	CSTCV26.00MXJ040
L111	6150004080	COIL	LS-468 (C-13958)
L112	6150004080	COIL	LS-468 (C-13958)
L113	6150004080	COIL	LS-468 (C-13958)
L114	6200005490	S.COIL	NL 322522T-331J
L115	6200005490	S.COIL	NL 322522T-331J
L141	6150004080	COIL	LS-468 (C-13958)
L151	6200003260	S.COIL	NL 322522T-101J
L152	6200003260	S.COIL	NL 322522T-101J
L201	6200003950	S.COIL	HF50ACC 322513-T
L202	6200003950	S.COIL	HF50ACC 322513-T
L203	6200003950	S.COIL	HF50ACC 322513-T
L204	6200003950	S.COIL	HF50ACC 322513-T
L205	6200003950	S.COIL	HF50ACC 322513-T
L206	6200003950	S.COIL	HF50ACC 322513-T
L221	6200003260	S.COIL	NL 322522T-101J
L227	6200003260	S.COIL	NL 322522T-101J
L241	6200003520	S.COIL	ELJFB 102K-F
L261	6150004090	COIL	LS-469 (C-13969)
L271	6150002291	COIL	LS-450
L272	6150002291	COIL	LS-450
L273	6150002291	COIL	LS-450
L274	6180001000	COIL	LAL 04NA 102K
L351	6910003570	COIL	2943-666663
L352	6910003570	COIL	2943-666663
L451	6200001830	S.COIL	NL 322522T-100J
L452	6180002650	COIL	RCR-875D-472K
L641	6200003240	S.COIL	NL 322522T-221J
L642	6200003240	S.COIL	NL 322522T-221J
L643	6200008820	S.COIL	HF70ACC 635050-T
L644	6200008820	S.COIL	HF70ACC 635050-T
L661	6200003260	S.COIL	NL 322522T-101J
L662	6200003260	S.COIL	NL 322522T-101J
L663	6200003950	S.COIL	HF50ACC 322513-T
L664	6200003260	S.COIL	NL 322522T-101J
L665	6200003260	S.COIL	NL 322522T-101J
L666	6200003950	S.COIL	HF50ACC 322513-T
L667	6200003260	S.COIL	NL 322522T-101J
L668	6200003260	S.COIL	NL 322522T-101J
L669	6200003950	S.COIL	HF50ACC 322513-T
L670	6200003260	S.COIL	NL 322522T-101J
L681	6200003260	S.COIL	NL 322522T-101J
L701	2040000490	COIL	EXC-ELDR25C
L702	6200003950	S.COIL	HF50ACC 322513-T
L703	6200003950	S.COIL	HF50ACC 322513-T
L704	6200003260	S.COIL	NL 322522T-101J
L705	6200003260	S.COIL	NL 322522T-101J
L706	6200003260	S.COIL	NL 322522T-101J
L707	6200003260	S.COIL	NL 322522T-101J
L708	6200003260	S.COIL	NL 322522T-101J
L709	6200003950	S.COIL	HF50ACC 322513-T
L710	2040000490	COIL	EXC-ELDR25C
L711	6200003950	S.COIL	HF50ACC 322513-T
L712	6200003950	S.COIL	HF50ACC 322513-T
L713	6200003260	S.COIL	NL 322522T-101J
L714	6200003260	S.COIL	NL 322522T-101J
L715	6200003260	S.COIL	NL 322522T-101J
L716	6200003950	S.COIL	HF50ACC 322513-T
L717	6200003950	S.COIL	HF50ACC 322513-T
L719	2040000490	COIL	EXC-ELDR25C
L720	6180003040	COIL	LHL 08NB 101K
L721	6200003220	S.COIL	NL 322522T-151J
L722	2040000490	COIL	EXC-ELDR25C
L723	2040000490	COIL	EXC-ELDR25C
L3001	6200001830	S.COIL	NL 322522T-100J
L3002	6200003260	S.COIL	NL 322522T-101J
L3501	6200003950	S.COIL	HF50ACC 322513-T
L3601	6200003950	S.COIL	HF50ACC 322513-T
L3602	6200003950	S.COIL	HF50ACC 322513-T
L3603	6180002650	COIL	RCR-875D-472K
L3604	6180002650	COIL	RCR-875D-472K

S.=Surface mount

[MAIN-A UNIT]

REF NO.	ORDER NO.	DESCRIPTION
R102	7030003730	S.RESISTOR ERJ3GGEYJ 274 V (270 kΩ)
R103	7030003680	S.RESISTOR ERJ3GGEYJ 104 V (100 kΩ)
R104	7030003620	S.RESISTOR ERJ3GGEYJ 333 V (33 kΩ)
R105	7030003680	S.RESISTOR ERJ3GGEYJ 104 V (100 kΩ)
R106	7030003680	S.RESISTOR ERJ3GGEYJ 104 V (100 kΩ)
R107	7030003680	S.RESISTOR ERJ3GGEYJ 104 V (100 kΩ)
R108	7030003400	S.RESISTOR ERJ3GGEYJ 471 V (470 Ω)
R111	7030003680	S.RESISTOR ERJ3GGEYJ 104 V (100 kΩ)
R112	7030003400	S.RESISTOR ERJ3GGEYJ 471 V (470 Ω)
R113	7030003440	S.RESISTOR ERJ3GGEYJ 102 V (1 kΩ)
R115	7030000310	S.RESISTOR MCR10EZHJ 270 Ω (271)
R116	7030003440	S.RESISTOR ERJ3GGEYJ 102 V (1 kΩ)
R118	7030000340	S.RESISTOR MCR10EZHJ 470 Ω (471)
R119	7030003560	S.RESISTOR ERJ3GGEYJ 103 V (10 kΩ)
R120	7030003560	S.RESISTOR ERJ3GGEYJ 103 V (10 kΩ)
R125	7030003560	S.RESISTOR ERJ3GGEYJ 103 V (10 kΩ)
R126	7030003560	S.RESISTOR ERJ3GGEYJ 103 V (10 kΩ)
R127	7030003560	S.RESISTOR ERJ3GGEYJ 103 V (10 kΩ)
R130	7030003560	S.RESISTOR ERJ3GGEYJ 103 V (10 kΩ)
R134	7030003560	S.RESISTOR ERJ3GGEYJ 103 V (10 kΩ)
R135	7030003440	S.RESISTOR ERJ3GGEYJ 102 V (1 kΩ)
R136	7030003440	S.RESISTOR ERJ3GGEYJ 102 V (1 kΩ)
R141	7030003560	S.RESISTOR ERJ3GGEYJ 103 V (10 kΩ)
R142	7030003280	S.RESISTOR ERJ3GGEYJ 470 V (47 Ω)
R143	7030003460	S.RESISTOR ERJ3GGEYJ 152 V (1.5 kΩ)
R144	7030003300	S.RESISTOR ERJ3GGEYJ 680 V (68 Ω)
R145	7030003460	S.RESISTOR ERJ3GGEYJ 152 V (1.5 kΩ)
R146	7030003200	S.RESISTOR ERJ3GGEYJ 100 V (10 Ω)
R147	7030003460	S.RESISTOR ERJ3GGEYJ 152 V (1.5 kΩ)
R148	7030003560	S.RESISTOR ERJ3GGEYJ 103 V (10 kΩ)
R151	7030003460	S.RESISTOR ERJ3GGEYJ 152 V (1.5 kΩ)
R152	7030003560	S.RESISTOR ERJ3GGEYJ 103 V (10 kΩ)
R153	7030003800	S.RESISTOR ERJ3GGEYJ 105 V (1 MΩ)
R154	7030003640	S.RESISTOR ERJ3GGEYJ 473 V (47 kΩ)
R201	7030003200	S.RESISTOR ERJ3GGEYJ 100 V (10 Ω)
R202	7030008061	S.RESISTOR ERA3YED 222V
R203	7030003200	S.RESISTOR ERJ3GGEYJ 100 V (10 Ω)
R205	7030008061	S.RESISTOR ERA3YED 222V
R206	7030003640	S.RESISTOR ERJ3GGEYJ 473 V (47 kΩ)
R207	7030006461	S.RESISTOR ERA3YED 152V
R208	7030006461	S.RESISTOR ERA3YED 152V
R209	7030006461	S.RESISTOR ERA3YED 152V
R210	7310002690	S.TRIMMER RV-145 (RH03A3A13X0CA) 102
R213	7030003320	S.RESISTOR ERJ3GGEYJ 101 V (100 Ω)
R214	7510001110	S.THERMISTOR NTCCM1608 4BH 153KC
R221	7030003440	S.RESISTOR ERJ3GGEYJ 102 V (1 kΩ)
R222	7030003420	S.RESISTOR ERJ3GGEYJ 681 V (680 Ω)
R223	7030003510	S.RESISTOR ERJ3GGEYJ 392 V (3.9 kΩ)
R224	7030003360	S.RESISTOR ERJ3GGEYJ 221 V (220 Ω)
R225	7030003530	S.RESISTOR ERJ3GGEYJ 562 V (5.6 kΩ)
R226	7030003440	S.RESISTOR ERJ3GGEYJ 102 V (1 kΩ)
R227	7030003440	S.RESISTOR ERJ3GGEYJ 102 V (1 kΩ)
R229	7030003530	S.RESISTOR ERJ3GGEYJ 562 V (5.6 kΩ)
R230	7030003520	S.RESISTOR ERJ3GGEYJ 472 V (4.7 kΩ)
R231	7030003500	S.RESISTOR ERJ3GGEYJ 332 V (3.3 kΩ)
R232	7030003500	S.RESISTOR ERJ3GGEYJ 332 V (3.3 kΩ)
R241	7030009691	S.RESISTOR ERA3YED 101V (100 Ω)
R242	7030003550	S.RESISTOR ERJ3GGEYJ 822 V (8.2 kΩ)
R243	7510001150	S.THERMISTOR NTCCM1608 4BH 103KC
R244	7030005681	S.RESISTOR ERA3YKD 473V
R246	7030005981	S.RESISTOR ERA3YED 333V
R247	7310002600	S.TRIMMER RV-110 (RH03A3AS4X0AA) 473
R248	7030003320	S.RESISTOR ERJ3GGEYJ 101 V (100 Ω)
R249	7030003680	S.RESISTOR ERJ3GGEYJ 104 V (100 kΩ)
R250	7030003440	S.RESISTOR ERJ3GGEYJ 102 V (1 kΩ)
R251	7030003460	S.RESISTOR ERJ3GGEYJ 152 V (1.5 kΩ)
R253	7030003470	S.RESISTOR ERJ3GGEYJ 182 V (1.8 kΩ)
R261	7030003490	S.RESISTOR ERJ3GGEYJ 272 V (2.7 kΩ)
R262	7030003440	S.RESISTOR ERJ3GGEYJ 102 V (1 kΩ)
R263	7310002760	S.TRIMMER RV-152 (RH03A3AJ4X0HA) 223
R264	7030003320	S.RESISTOR ERJ3GGEYJ 101 V (100 Ω)
R265	7030003400	S.RESISTOR ERJ3GGEYJ 471 V (470 Ω)
R271	7310002760	S.TRIMMER RV-152 (RH03A3AJ4X0HA) 223
R272	7030003400	S.RESISTOR ERJ3GGEYJ 471 V (470 Ω)
R273	7030003320	S.RESISTOR ERJ3GGEYJ 101 V (100 Ω)
R274	7030003600	S.RESISTOR ERJ3GGEYJ 223 V (22 kΩ)
R275	7030003400	S.RESISTOR ERJ3GGEYJ 471 V (470 Ω)
R276	7030003320	S.RESISTOR ERJ3GGEYJ 101 V (100 Ω)
R277	7030003600	S.RESISTOR ERJ3GGEYJ 223 V (22 kΩ)
R279	7030003520	S.RESISTOR ERJ3GGEYJ 472 V (4.7 kΩ)
R280	7030003320	S.RESISTOR ERJ3GGEYJ 101 V (100 Ω)
R281	7030003680	S.RESISTOR ERJ3GGEYJ 104 V (100 kΩ)

[MAIN-A UNIT]

REF NO.	ORDER NO.	DESCRIPTION
R283	7030003640	S.RESISTOR ERJ3GGEYJ 473 V (47 kΩ)
R284	7030003640	S.RESISTOR ERJ3GGEYJ 473 V (47 kΩ)
R285	7030003840	S.RESISTOR ERJ3GGEYJ 225 V (2.2 MΩ)
R286	7030003380	S.RESISTOR ERJ3GGEYJ 331 V (330 Ω)
R287	7030003540	S.RESISTOR ERJ3GGEYJ 682 V (6.8 kΩ)
R290	7030003540	S.RESISTOR ERJ3GGEYJ 682 V (6.8 kΩ)
R292	7030003600	S.RESISTOR ERJ3GGEYJ 223 V (22 kΩ)
R293	7030003600	S.RESISTOR ERJ3GGEYJ 223 V (22 kΩ)
R294	7030003440	S.RESISTOR ERJ3GGEYJ 102 V (1 kΩ)
R301	7030003440	S.RESISTOR ERJ3GGEYJ 102 V (1 kΩ)
R302	7030003440	S.RESISTOR ERJ3GGEYJ 102 V (1 kΩ)
R303	7030003440	S.RESISTOR ERJ3GGEYJ 102 V (1 kΩ)
R304	7030003560	S.RESISTOR ERJ3GGEYJ 103 V (10 kΩ)
R305	7030003400	S.RESISTOR ERJ3GGEYJ 471 V (470 Ω)
R306	7030003400	S.RESISTOR ERJ3GGEYJ 471 V (470 Ω)
R307	7030003560	S.RESISTOR ERJ3GGEYJ 103 V (10 kΩ)
R311	7030003640	S.RESISTOR ERJ3GGEYJ 473 V (47 kΩ)
R312	7030003560	S.RESISTOR ERJ3GGEYJ 103 V (10 kΩ)
R313	7030003440	S.RESISTOR ERJ3GGEYJ 102 V (1 kΩ)
R314	7030003520	S.RESISTOR ERJ3GGEYJ 472 V (4.7 kΩ)
R315	7030003640	S.RESISTOR ERJ3GGEYJ 473 V (47 kΩ)
R316	7030003200	S.RESISTOR ERJ3GGEYJ 100 V (10 Ω)
R317	7030003670	S.RESISTOR ERJ3GGEYJ 823 V (82 kΩ)
R318	7030003730	S.RESISTOR ERJ3GGEYJ 274 V (270 kΩ)
R320	7030003680	S.RESISTOR ERJ3GGEYJ 104 V (100 kΩ)
R321	7030003520	S.RESISTOR ERJ3GGEYJ 472 V (4.7 kΩ)
R322	7030003690	S.RESISTOR ERJ3GGEYJ 124 V (120 kΩ)
R323	7030003690	S.RESISTOR ERJ3GGEYJ 124 V (120 kΩ)
R324	7030003690	S.RESISTOR ERJ3GGEYJ 124 V (120 kΩ)
R325	7030003440	S.RESISTOR ERJ3GGEYJ 102 V (1 kΩ)
R331	7030003400	S.RESISTOR ERJ3GGEYJ 471 V (470 Ω)
R332	7030003400	S.RESISTOR ERJ3GGEYJ 471 V (470 Ω)
R333	7030003520	S.RESISTOR ERJ3GGEYJ 472 V (4.7 kΩ)
R334	7030003440	S.RESISTOR ERJ3GGEYJ 102 V (1 kΩ)
R335	7030003400	S.RESISTOR ERJ3GGEYJ 471 V (470 Ω)
R336	7030003280	S.RESISTOR ERJ3GGEYJ 470 V (47 Ω)
R337	7030003560	S.RESISTOR ERJ3GGEYJ 103 V (10 kΩ)
R338	7030003680	S.RESISTOR ERJ3GGEYJ 104 V (100 kΩ)
R339	7030003680	S.RESISTOR ERJ3GGEYJ 104 V (100 kΩ)
R340	7030003440	S.RESISTOR ERJ3GGEYJ 102 V (1 kΩ)
R341	7030003680	S.RESISTOR ERJ3GGEYJ 104 V (100 kΩ)
R342	7030003720	S.RESISTOR ERJ3GGEYJ 224 V (220 kΩ)
R343	7030003560	S.RESISTOR ERJ3GGEYJ 103 V (10 kΩ)
R351	7030003200	S.RESISTOR ERJ3GGEYJ 100 V (10 Ω)
R361	7030003400	S.RESISTOR ERJ3GGEYJ 471 V (470 Ω)
R362	7030003400	S.RESISTOR ERJ3GGEYJ 471 V (470 Ω)
R363	7030003560	S.RESISTOR ERJ3GGEYJ 103 V (10 kΩ)
R364	7030003630	S.RESISTOR ERJ3GGEYJ 393 V (39 kΩ)
R365	7030003640	S.RESISTOR ERJ3GGEYJ 473 V (47 kΩ)
R366	7030003520	S.RESISTOR ERJ3GGEYJ 472 V (4.7 kΩ)
R367	7030003460	S.RESISTOR ERJ3GGEYJ 152 V (1.5 kΩ)
R369	7030003440	S.RESISTOR ERJ3GGEYJ 102 V (1 kΩ)
R370	7030003320	S.RESISTOR ERJ3GGEYJ 101 V (100 Ω)
R371	7030003760	S.RESISTOR ERJ3GGEYJ 474 V (470 kΩ)
R372	7030003640	S.RESISTOR ERJ3GGEYJ 473 V (47 kΩ)
R373	7030003480	S.RESISTOR ERJ3GGEYJ 222 V (2.2 kΩ)
R374	7030003680	S.RESISTOR ERJ3GGEYJ 104 V (100 kΩ)
R375	7030003520	S.RESISTOR ERJ3GGEYJ 472 V (4.7 kΩ)
R376	7030009930	S.RESISTOR ERJ3GGEYJ 825 V (8.2 MΩ)
R377	7030003520	S.RESISTOR ERJ3GGEYJ 472 V (4.7 kΩ)
R378	7030003320	S.RESISTOR ERJ3GGEYJ 101 V (100 Ω)
R379	7030003670	S.RESISTOR ERJ3GGEYJ 823 V (82 kΩ)
R380	7030003730	S.RESISTOR ERJ3GGEYJ 274 V (270 kΩ)
R381	7030003560	S.RESISTOR ERJ3GGEYJ 103 V (10 kΩ)
R390	7030003400	S.RESISTOR ERJ3GGEYJ 471 V (470 Ω)
R391	7030003400	S.RESISTOR ERJ3GGEYJ 471 V (470 Ω)
R392	7310002580	S.TRIMMER RV-108 (RH03A3A15X05A) 104
R393	7030003640	S.RESISTOR ERJ3GGEYJ 473 V (47 kΩ)
R394	7030003680	S.RESISTOR ERJ3GGEYJ 104 V (100 kΩ)
R395	7030003680	S.RESISTOR ERJ3GGEYJ 104 V (100 kΩ)
R451	7030003560	S.RESISTOR ERJ3GGEYJ 103 V (10 kΩ)
R453	7030003520	S.RESISTOR ERJ3GGEYJ 472 V (4.7 kΩ)
R454	7030003710	S.RESISTOR ERJ3GGEYJ 184 V (180 kΩ)
R455	7030003730	S.RESISTOR ERJ3GGEYJ 274 V (270 kΩ)
R456	7030003550	S.RESISTOR ERJ3GGEYJ 822 V (82 kΩ)
R457	7030003510	S.RESISTOR ERJ3GGEYJ 392 V (3.9 kΩ)
R458	7030003540	S.RESISTOR ERJ3GGEYJ 682 V (6.8 kΩ)
R459	7030003720	S.RESISTOR ERJ3GGEYJ 224 V (220 kΩ)
R460	7030003680	S.RESISTOR ERJ3GGEYJ 104 V (100 kΩ)
R461	7030003600	S.RESISTOR ERJ3GGEYJ 223 V (22 kΩ)
R462	7030003560	S.RESISTOR ERJ3GGEYJ 103 V (10 kΩ)
R463	7030003560	S.RESISTOR ERJ3GGEYJ 103 V (10 kΩ)

S.=Surface mount

[MAIN-A UNIT]

REF NO.	ORDER NO.	DESCRIPTION
R464	7030003640	S.RESISTOR ERJ3GEYJ 473 V (47 kΩ)
R465	7030003640	S.RESISTOR ERJ3GEYJ 473 V (47 kΩ)
R466	7030003680	S.RESISTOR ERJ3GEYJ 104 V (100 kΩ)
R471	7030003440	S.RESISTOR ERJ3GEYJ 102 V (1 kΩ)
R472	7030003520	S.RESISTOR ERJ3GEYJ 472 V (4.7 kΩ)
R473	7030003580	S.RESISTOR ERJ3GEYJ 153 V (15 kΩ)
R474	7030003390	S.RESISTOR ERJ3GEYJ 391 V (390 Ω)
R475	7030003680	S.RESISTOR ERJ3GEYJ 104 V (100 kΩ)
R476	7030003320	S.RESISTOR ERJ3GEYJ 101 V (100 Ω)
R477	7030003550	S.RESISTOR ERJ3GEYJ 822 V (8.2 kΩ)
R478	7030003680	S.RESISTOR ERJ3GEYJ 104 V (100 kΩ)
R479	7030003420	S.RESISTOR ERJ3GEYJ 681 V (680 Ω)
R480	7030003580	S.RESISTOR ERJ3GEYJ 153 V (15 kΩ)
R501	70300008180	S.RESISTOR ERJ12YJ331U (330 Ω)
R502	7030003380	S.RESISTOR ERJ3GEYJ 331 V (330 Ω)
R503	7030003600	S.RESISTOR ERJ3GEYJ 223 V (22 kΩ)
R504	7030003620	S.RESISTOR ERJ3GEYJ 333 V (33 kΩ)
R505	7030003720	S.RESISTOR ERJ3GEYJ 224 V (220 kΩ)
R507	7310002800	S.TRIMMER RV-156 (RH03A3AJ5) 224
R509	7310002800	S.TRIMMER RV-156 (RH03A3AJ5) 224
R510	7310002580	S.TRIMMER RV-108 (RH03A3A15X05A) 104
R511	7030003720	S.RESISTOR ERJ3GEYJ 224 V (220 kΩ)
R512	7030009920	S.RESISTOR ERJ3GEYJ 335 V (3.3 MΩ)
R513	7030003380	S.RESISTOR ERJ3GEYJ 331 V (330 Ω)
R514	7030003640	S.RESISTOR ERJ3GEYJ 473 V (47 kΩ)
R515	7030003760	S.RESISTOR ERJ3GEYJ 474 V (470 kΩ)
R516	7030003600	S.RESISTOR ERJ3GEYJ 223 V (22 kΩ)
R517	7030003760	S.RESISTOR ERJ3GEYJ 474 V (470 kΩ)
R518	7030003680	S.RESISTOR ERJ3GEYJ 104 V (100 kΩ)
R521	7030003560	S.RESISTOR ERJ3GEYJ 103 V (10 kΩ)
R522	7030003680	S.RESISTOR ERJ3GEYJ 104 V (100 kΩ)
R531	7030003680	S.RESISTOR ERJ3GEYJ 104 V (100 kΩ)
R532	7030003560	S.RESISTOR ERJ3GEYJ 103 V (10 kΩ)
R533	7030003720	S.RESISTOR ERJ3GEYJ 224 V (220 kΩ)
R534	7030003660	S.RESISTOR ERJ3GEYJ 683 V (68 kΩ)
R535	7030003500	S.RESISTOR ERJ3GEYJ 332 V (3.3 kΩ)
R536	7030003400	S.RESISTOR ERJ3GEYJ 471 V (470 Ω)
R537	7510000771	S.THERMISTOR NTCCM2012 3SH 223KC-T
R541	7030003640	S.RESISTOR ERJ3GEYJ 473 V (47 kΩ)
R542	7030003640	S.RESISTOR ERJ3GEYJ 473 V (47 kΩ)
R543	7030003620	S.RESISTOR ERJ3GEYJ 333 V (33 kΩ)
R544	7030003620	S.RESISTOR ERJ3GEYJ 333 V (33 kΩ)
R545	7310002740	S.TRIMMER RV-150 (RH03A3A14X0FC) 103
R546	7030003800	S.RESISTOR ERJ3GEYJ 105 V (1 MΩ)
R551	7030009920	S.RESISTOR ERJ3GEYJ 335 V (3.3 MΩ)
R552	7030009930	S.RESISTOR ERJ3GEYJ 825 V (8.2 MΩ)
R553	7030003840	S.RESISTOR ERJ3GEYJ 225 V (2.2 MΩ)
R561	7030003360	S.RESISTOR ERJ3GEYJ 221 V (220 Ω)
R562	7030003760	S.RESISTOR ERJ3GEYJ 474 V (470 kΩ)
R563	7030003680	S.RESISTOR ERJ3GEYJ 104 V (100 kΩ)
R564	7030003560	S.RESISTOR ERJ3GEYJ 103 V (10 kΩ)
R571	7030003360	S.RESISTOR ERJ3GEYJ 221 V (220 Ω)
R574	7030003600	S.RESISTOR ERJ3GEYJ 223 V (22 kΩ)
R601	7030006210	S.RESISTOR ERJ12YJ4R7U (4.7 Ω)
R602	7030003440	S.RESISTOR ERJ3GEYJ 102 V (1 kΩ)
R603	7030003560	S.RESISTOR ERJ3GEYJ 103 V (10 kΩ)
R611	7030006210	S.RESISTOR ERJ12YJ4R7U (4.7 Ω)
R612	7030003440	S.RESISTOR ERJ3GEYJ 102 V (1 kΩ)
R613	7030003560	S.RESISTOR ERJ3GEYJ 103 V (10 kΩ)
R621	7030003640	S.RESISTOR ERJ3GEYJ 473 V (47 kΩ)
R622	7030003460	S.RESISTOR ERJ3GEYJ 152 V (1.5 kΩ)
R623	7030003560	S.RESISTOR ERJ3GEYJ 103 V (10 kΩ)
R631	7030003520	S.RESISTOR ERJ3GEYJ 472 V (4.7 kΩ)
R632	7030003620	S.RESISTOR ERJ3GEYJ 333 V (33 kΩ)
R633	7030003580	S.RESISTOR ERJ3GEYJ 153 V (15 kΩ)
R634	7030003520	S.RESISTOR ERJ3GEYJ 472 V (4.7 kΩ)
R635	7030003520	S.RESISTOR ERJ3GEYJ 472 V (4.7 kΩ)
R636	7030003620	S.RESISTOR ERJ3GEYJ 333 V (33 kΩ)
R637	7030003580	S.RESISTOR ERJ3GEYJ 153 V (15 kΩ)
R638	7030003520	S.RESISTOR ERJ3GEYJ 472 V (4.7 kΩ)
R651	7030003380	S.RESISTOR ERJ3GEYJ 331 V (330 Ω)
R652	7030003560	S.RESISTOR ERJ3GEYJ 103 V (10 kΩ)
R653	7030003550	S.RESISTOR ERJ3GEYJ 822 V (8.2 kΩ)
R691	7030003200	S.RESISTOR ERJ3GEYJ 100 V (10 Ω)
R761	7030003360	S.RESISTOR ERJ3GEYJ 221 V (220 Ω)
R762	7030003360	S.RESISTOR ERJ3GEYJ 221 V (220 Ω)
R763	7030003360	S.RESISTOR ERJ3GEYJ 221 V (220 Ω)
R801	7030003560	S.RESISTOR ERJ3GEYJ 103 V (10 kΩ)
R802	7030003280	S.RESISTOR ERJ3GEYJ 470 V (47 Ω)
R803	7030003480	S.RESISTOR ERJ3GEYJ 222 V (2.2 kΩ)
R804	7030000340	S.RESISTOR MCR10EZHJ 470 Ω (471)
R806	7030003440	S.RESISTOR ERJ3GEYJ 102 V (1 kΩ)

[MAIN-A UNIT]

REF NO.	ORDER NO.	DESCRIPTION
R807	7030003360	S.RESISTOR ERJ3GEYJ 221 V (220 Ω)
R3003	7030003640	S.RESISTOR ERJ3GEYJ 473 V (47 kΩ)
R3004	7030003640	S.RESISTOR ERJ3GEYJ 473 V (47 kΩ)
R3005	7030003440	S.RESISTOR ERJ3GEYJ 102 V (1 kΩ)
R3006	7030003400	S.RESISTOR ERJ3GEYJ 471 V (470 Ω)
R3007	7030003400	S.RESISTOR ERJ3GEYJ 471 V (470 Ω)
R3010	7030003600	S.RESISTOR ERJ3GEYJ 223 V (22 kΩ)
R3011	7030003670	S.RESISTOR ERJ3GEYJ 823 V (82 kΩ)
R3012	7030003730	S.RESISTOR ERJ3GEYJ 274 V (270 kΩ)
R3013	7030003560	S.RESISTOR ERJ3GEYJ 103 V (10 kΩ)
R3015	7030003690	S.RESISTOR ERJ3GEYJ 124 V (120 kΩ)
R3016	7030003680	S.RESISTOR ERJ3GEYJ 104 V (100 kΩ)
R3017	7030003480	S.RESISTOR ERJ3GEYJ 222 V (2.2 kΩ)
R3018	7030003640	S.RESISTOR ERJ3GEYJ 473 V (47 kΩ)
R3019	7030003360	S.RESISTOR ERJ3GEYJ 221 V (220 Ω)
R3020	7030003640	S.RESISTOR ERJ3GEYJ 473 V (47 kΩ)
R3021	7030003360	S.RESISTOR ERJ3GEYJ 221 V (220 Ω)
R3022	7030003400	S.RESISTOR ERJ3GEYJ 471 V (470 Ω)
R3023	7030003400	S.RESISTOR ERJ3GEYJ 471 V (470 Ω)
R3024	7030003680	S.RESISTOR ERJ3GEYJ 104 V (100 kΩ)
R3025	7030003560	S.RESISTOR ERJ3GEYJ 103 V (10 kΩ)
R3026	7030003820	S.RESISTOR ERJ3GEYJ 155 V (1.5 MΩ)
R3027	7030003670	S.RESISTOR ERJ3GEYJ 823 V (82 kΩ)
R3028	7030003670	S.RESISTOR ERJ3GEYJ 823 V (82 kΩ)
R3030	7030003680	S.RESISTOR ERJ3GEYJ 104 V (100 kΩ)
R3032	7030003680	S.RESISTOR ERJ3GEYJ 104 V (100 kΩ)
R3033	7030003680	S.RESISTOR ERJ3GEYJ 104 V (100 kΩ)
R3034	7030003450	S.RESISTOR ERJ3GEYJ 122 V (1.2 kΩ)
R3035	7030003440	S.RESISTOR ERJ3GEYJ 102 V (1 kΩ)
R3036	7030003320	S.RESISTOR ERJ3GEYJ 101 V (100 Ω)
R3037	7030003560	S.RESISTOR ERJ3GEYJ 103 V (10 kΩ)
R3040	7030003640	S.RESISTOR ERJ3GEYJ 473 V (47 kΩ)
R3041	7030003640	S.RESISTOR ERJ3GEYJ 473 V (47 kΩ)
R3042	7030003480	S.RESISTOR ERJ3GEYJ 222 V (2.2 kΩ)
R3501	7030003640	S.RESISTOR ERJ3GEYJ 473 V (47 kΩ)
R3502	7030003640	S.RESISTOR ERJ3GEYJ 473 V (47 kΩ)
R3503	7030003640	S.RESISTOR ERJ3GEYJ 473 V (47 kΩ)
R3505	7030003620	S.RESISTOR ERJ3GEYJ 333 V (33 kΩ)
R3506	7030003520	S.RESISTOR ERJ3GEYJ 472 V (4.7 kΩ)
R3507	7030003640	S.RESISTOR ERJ3GEYJ 473 V (47 kΩ)
R3508	7030003640	S.RESISTOR ERJ3GEYJ 473 V (47 kΩ)
R3509	7030003520	S.RESISTOR ERJ3GEYJ 472 V (4.7 kΩ)
R3510	7030003560	S.RESISTOR ERJ3GEYJ 103 V (10 kΩ)
R3511	7030003720	S.RESISTOR ERJ3GEYJ 224 V (220 kΩ)
R3512	7030003720	S.RESISTOR ERJ3GEYJ 224 V (220 kΩ)
R3513	7030003720	S.RESISTOR ERJ3GEYJ 224 V (220 kΩ)
R3514	7030003720	S.RESISTOR ERJ3GEYJ 224 V (220 kΩ)
R3515	7030003720	S.RESISTOR ERJ3GEYJ 224 V (220 kΩ)
R3516	7030003720	S.RESISTOR ERJ3GEYJ 224 V (220 kΩ)
R3517	7030003720	S.RESISTOR ERJ3GEYJ 224 V (220 kΩ)
R3518	7030003720	S.RESISTOR ERJ3GEYJ 224 V (220 kΩ)
R3519	7030003720	S.RESISTOR ERJ3GEYJ 224 V (220 kΩ)
R3520	7030003720	S.RESISTOR ERJ3GEYJ 224 V (220 kΩ)
R3521	7030003720	S.RESISTOR ERJ3GEYJ 224 V (220 kΩ)
R3522	7030003720	S.RESISTOR ERJ3GEYJ 224 V (220 kΩ)
R3523	7030003720	S.RESISTOR ERJ3GEYJ 224 V (220 kΩ)
R3524	7030003720	S.RESISTOR ERJ3GEYJ 224 V (220 kΩ)
R3525	7030003720	S.RESISTOR ERJ3GEYJ 224 V (220 kΩ)
R3526	7030003720	S.RESISTOR ERJ3GEYJ 224 V (220 kΩ)
R3531	7030003720	S.RESISTOR ERJ3GEYJ 224 V (220 kΩ)
R3532	7030003720	S.RESISTOR ERJ3GEYJ 224 V (220 kΩ)
R3533	7030003720	S.RESISTOR ERJ3GEYJ 224 V (220 kΩ)
R3534	7030003720	S.RESISTOR ERJ3GEYJ 224 V (220 kΩ)
R3535	7030003720	S.RESISTOR ERJ3GEYJ 224 V (220 kΩ)
R3536	7030003720	S.RESISTOR ERJ3GEYJ 224 V (220 kΩ)
R3537	7030003720	S.RESISTOR ERJ3GEYJ 224 V (220 kΩ)
R3538	7030003720	S.RESISTOR ERJ3GEYJ 224 V (220 kΩ)
R3539	7030003720	S.RESISTOR ERJ3GEYJ 224 V (220 kΩ)
R3540	7030003720	S.RESISTOR ERJ3GEYJ 224 V (220 kΩ)
R3541	7030003720	S.RESISTOR ERJ3GEYJ 224 V (220 kΩ)
R3542	7030003720	S.RESISTOR ERJ3GEYJ 224 V (220 kΩ)
R3543	7030003720	S.RESISTOR ERJ3GEYJ 224 V (220 kΩ)
R3544	7030003720	S.RESISTOR ERJ3GEYJ 224 V (220 kΩ)
R3545	7030003720	S.RESISTOR ERJ3GEYJ 224 V (220 kΩ)
R3546	7030003720	S.RESISTOR ERJ3GEYJ 224 V (220 kΩ)
R3547	7030003720	S.RESISTOR ERJ3GEYJ 224 V (220 kΩ)
R3548	7030003720	S.RESISTOR ERJ3GEYJ 224 V (220 kΩ)
R3549	7030003720	S.RESISTOR ERJ3GEYJ 224 V (220 kΩ)
R3551	7030003800	S.RESISTOR ERJ3GEYJ 105 V (1 MΩ)
R3552	7030003680	S.RESISTOR ERJ3GEYJ 104 V (100 kΩ)
R3553	7030003680	S.RESISTOR ERJ3GEYJ 104 V (100 kΩ)
R3554	7030003580	S.RESISTOR ERJ3GEYJ 153 V (15 kΩ)

S.=Surface mount

[MAIN-A UNIT]

REF NO.	ORDER NO.	DESCRIPTION
C141	4030006860	S.CERAMIC C1608 JB 1H 102K-T-A
C142	4030011600	S.CERAMIC C1608 JB 1C 104KT-N
C144	4030011600	S.CERAMIC C1608 JB 1C 104KT-N
C145	4030006880	S.CERAMIC C1608 JB 1H 472K-T-A
C146	4030011600	S.CERAMIC C1608 JB 1C 104KT-N
C151	4510006220	S.ELECTROLYTIC ECEV1CA101UP
C152	4030011600	S.CERAMIC C1608 JB 1C 104KT-N
C153	4030011600	S.CERAMIC C1608 JB 1C 104KT-N
C154	4510006220	S.ELECTROLYTIC ECEV1CA101UP
C155	4030011600	S.CERAMIC C1608 JB 1C 104KT-N
C156	4030011600	S.CERAMIC C1608 JB 1C 104KT-N
C157	4030006860	S.CERAMIC C1608 JB 1H 102K-T-A
C158	4340000250	S.MYLAR ECHU 1C 104JX5
C201	4510004630	S.ELECTROLYTIC ECEV1CA100SR
C202	4510004630	S.ELECTROLYTIC ECEV1CA100SR
C203	4340000200	S.MYLAR ECHU 1H 271JX5
C204	4340000230	S.MYLAR ECHU 1H 272JB5
C205	4340000240	S.MYLAR ECHU 1C 682JX5
C206	4340000220	S.MYLAR ECHU 1H 681JB5
C207	4340000210	S.MYLAR ECHU 1H 331JX5
C208	4340000190	S.MYLAR ECHU 1H 101JX5
C209	4510006670	S.ELECTROLYTIC ECEV1CA471P
C211	4030006880	S.CERAMIC C1608 JB 1H 472K-T-A
C221	4030006860	S.CERAMIC C1608 JB 1H 102K-T-A
C222	4510004630	S.ELECTROLYTIC ECEV1CA100SR
C223	4030011600	S.CERAMIC C1608 JB 1C 104KT-N
C224	4550006080	S.TANTALUM TEMSVB2 1C 106M-8L
C225	4030011600	S.CERAMIC C1608 JB 1C 104KT-N
C226	4030011600	S.CERAMIC C1608 JB 1C 104KT-N
C227	4510004630	S.ELECTROLYTIC ECEV1CA100SR
C228	4030011600	S.CERAMIC C1608 JB 1C 104KT-N
C229	4030006850	S.CERAMIC C1608 JB 1H 471K-T-A
C231	4030011600	S.CERAMIC C1608 JB 1C 104KT-N
C241	4030011600	S.CERAMIC C1608 JB 1C 104KT-N
C242	4030006880	S.CERAMIC C1608 JB 1H 472K-T-A
C243	4030006880	S.CERAMIC C1608 JB 1H 472K-T-A
C244	4030006880	S.CERAMIC C1608 JB 1H 472K-T-A
C245	4030011600	S.CERAMIC C1608 JB 1C 104KT-N
C246	4030011600	S.CERAMIC C1608 JB 1C 104KT-N
C247	4030011600	S.CERAMIC C1608 JB 1C 104KT-N
C261	4030006880	S.CERAMIC C1608 JB 1H 472K-T-A
C262	4030008920	S.CERAMIC C1608 JB 1C 473K-T-A
C264	4030011600	S.CERAMIC C1608 JB 1C 104KT-N
C266	4030006860	S.CERAMIC C1608 JB 1H 102K-T-A
C267	4510004630	S.ELECTROLYTIC ECEV1CA100SR
C268	4030011600	S.CERAMIC C1608 JB 1C 104KT-N
C271	4030011600	S.CERAMIC C1608 JB 1C 104KT-N
C272	4030011600	S.CERAMIC C1608 JB 1C 104KT-N
C274	4030011600	S.CERAMIC C1608 JB 1C 104KT-N
C275	4030011600	S.CERAMIC C1608 JB 1C 104KT-N
C279	4030011600	S.CERAMIC C1608 JB 1C 104KT-N
C280	4030006880	S.CERAMIC C1608 JB 1H 472K-T-A
C281	4030006850	S.CERAMIC C1608 JB 1H 471K-T-A
C283	4030011600	S.CERAMIC C1608 JB 1C 104KT-N
C284	4510004640	S.ELECTROLYTIC ECEV1CA470SP
C285	4030011810	S.CERAMIC C1608 JB 1A 224K-T-N
C286	4510006240	S.ELECTROLYTIC ECEV1CA221P
C287	4510004640	S.ELECTROLYTIC ECEV1CA470SP
C288	4030011600	S.CERAMIC C1608 JB 1C 104KT-N
C289	4030006870	S.CERAMIC C1608 JB 1H 222K-T-A
C301	4510005890	S.ELECTROLYTIC ECEV1AAN100R
C302	4510005890	S.ELECTROLYTIC ECEV1AAN100R
C303	4510005890	S.ELECTROLYTIC ECEV1AAN100R
C304	4030011600	S.CERAMIC C1608 JB 1C 104KT-N
C305	4030011600	S.CERAMIC C1608 JB 1C 104KT-N
C306	4030011600	S.CERAMIC C1608 JB 1C 104KT-N
C307	4030011600	S.CERAMIC C1608 JB 1C 104KT-N
C308	4510005890	S.ELECTROLYTIC ECEV1AAN100R
C311	4510005860	S.ELECTROLYTIC ECEV1HA2R2SR
C312	4030006870	S.CERAMIC C1608 JB 1H 222K-T-A
C313	4510004630	S.ELECTROLYTIC ECEV1CA100SR
C314	4510004630	S.ELECTROLYTIC ECEV1CA100SR
C315	4510004630	S.ELECTROLYTIC ECEV1CA100SR
C316	4510006670	S.ELECTROLYTIC ECEV1CA471P
C317	4030012600	S.CERAMIC C2012 JB 1A 105M-T-A
C318	4510004440	S.ELECTROLYTIC ECEV1HA010SR
C319	4030012600	S.CERAMIC C2012 JB 1A 105M-T-A
C320	4030012600	S.CERAMIC C2012 JB 1A 105M-T-A
C321	4030006880	S.CERAMIC C1608 JB 1H 472K-T-A
C322	4030006880	S.CERAMIC C1608 JB 1H 472K-T-A
C323	4030006860	S.CERAMIC C1608 JB 1H 102K-T-A
C324	4030006860	S.CERAMIC C1608 JB 1H 102K-T-A

[MAIN-A UNIT]

REF NO.	ORDER NO.	DESCRIPTION
C325	4030011600	S.CERAMIC C1608 JB 1C 104KT-N
C326	4030011600	S.CERAMIC C1608 JB 1C 104KT-N
C327	4030012600	S.CERAMIC C2012 JB 1A 105M-T-A
C331	4510004630	S.ELECTROLYTIC ECEV1CA100SR
C332	4510004630	S.ELECTROLYTIC ECEV1CA100SR
C333	4030008950	S.CERAMIC C2012 JB 1C 823K-T-A
C334	4510004630	S.ELECTROLYTIC ECEV1CA100SR
C335	4030008880	S.CERAMIC C1608 JB 1C 223K-T-A
C336	4030011600	S.CERAMIC C1608 JB 1C 104KT-N
C337	4510006670	S.ELECTROLYTIC ECEV1CA471P
C338	4510006670	S.ELECTROLYTIC ECEV1CA471P
C340	4510006220	S.ELECTROLYTIC ECEV1CA101UP
C341	4030011600	S.CERAMIC C1608 JB 1C 104KT-N
C351	4030006880	S.CERAMIC C1608 JB 1H 472K-T-A
C352	4030006880	S.CERAMIC C1608 JB 1H 472K-T-A
C353	4030006880	S.CERAMIC C1608 JB 1H 472K-T-A
C354	4030006880	S.CERAMIC C1608 JB 1H 472K-T-A
C361	4030011600	S.CERAMIC C1608 JB 1C 104KT-N
C362	4030011600	S.CERAMIC C1608 JB 1C 104KT-N
C363	4510004630	S.ELECTROLYTIC ECEV1CA100SR
C364	4510004630	S.ELECTROLYTIC ECEV1CA100SR
C365	4550000270	S.TANTALUM TESVA 1E 474M1-8L
C371	4030012600	S.CERAMIC C2012 JB 1A 105M-T-A
C372	4550000460	S.TANTALUM TESVA 1C 105M1-8L
C374	4510004630	S.ELECTROLYTIC ECEV1CA100SR
C375	4510004630	S.ELECTROLYTIC ECEV1CA100SR
C376	4030006900	S.CERAMIC C1608 JB 1E 103K-T-A
C377	4510006670	S.ELECTROLYTIC ECEV1CA471P
C378	4030012600	S.CERAMIC C2012 JB 1A 105M-T-A
C379	4510004440	S.ELECTROLYTIC ECEV1HA010SR
C390	4030011600	S.CERAMIC C1608 JB 1C 104KT-N
C391	4030011600	S.CERAMIC C1608 JB 1C 104KT-N
C392	4030011600	S.CERAMIC C1608 JB 1C 104KT-N
C453	4510004440	S.ELECTROLYTIC ECEV1HA010SR
C456	4030007130	S.CERAMIC C1608 CH 1H 101J-T-A
C457	4510005860	S.ELECTROLYTIC ECEV1HA2R2SR
C458	4030008880	S.CERAMIC C1608 JB 1C 223K-T-A
C459	4030010040	S.CERAMIC C1608 JB 1H 561K-T-A
C460	4030008880	S.CERAMIC C1608 JB 1C 223K-T-A
C461	4030012600	S.CERAMIC C2012 JB 1A 105M-T-A
C462	4030007130	S.CERAMIC C1608 CH 1H 101J-T-A
C463	4030011600	S.CERAMIC C1608 JB 1C 104KT-N
C464	4510004630	S.ELECTROLYTIC ECEV1CA100SR
C465	4030011600	S.CERAMIC C1608 JB 1C 104KT-N
C466	4510004440	S.ELECTROLYTIC ECEV1HA010SR
C467	4030006860	S.CERAMIC C1608 JB 1H 102K-T-A
C471	4030012600	S.CERAMIC C2012 JB 1A 105M-T-A
C472	4510005860	S.ELECTROLYTIC ECEV1HA2R2SR
C473	4510004630	S.ELECTROLYTIC ECEV1CA100SR
C474	4510006220	S.ELECTROLYTIC ECEV1CA101UP
C475	4030012600	S.CERAMIC C2012 JB 1A 105M-T-A
C476	4030011600	S.CERAMIC C1608 JB 1C 104KT-N
C477	4510006670	S.ELECTROLYTIC ECEV1CA471P
C502	4030012600	S.CERAMIC C2012 JB 1A 105M-T-A
C504	4030012600	S.CERAMIC C2012 JB 1A 105M-T-A
C506	4030012610	S.CERAMIC C2012 JB 1C 474K-T-A
C507	4030011600	S.CERAMIC C1608 JB 1C 104KT-N
C508	4550006080	S.TANTALUM TEMSVB2 1C 106M-8L
C510	4030012600	S.CERAMIC C2012 JB 1A 105M-T-A
C552	4030011600	S.CERAMIC C1608 JB 1C 104KT-N
C553	4030011600	S.CERAMIC C1608 JB 1C 104KT-N
C561	4510004630	S.ELECTROLYTIC ECEV1CA100SR
C571	4510004630	S.ELECTROLYTIC ECEV1CA100SR
C572	4030011600	S.CERAMIC C1608 JB 1C 104KT-N
C573	4030011600	S.CERAMIC C1608 JB 1C 104KT-N
C601	4510005810	S.ELECTROLYTIC ECEV1HAR47R
C611	4510005810	S.ELECTROLYTIC ECEV1HAR47R
C631	4030006880	S.CERAMIC C1608 JB 1H 472K-T-A
C632	4030006880	S.CERAMIC C1608 JB 1H 472K-T-A
C641	4030006880	S.CERAMIC C1608 JB 1H 472K-T-A
C642	4030006880	S.CERAMIC C1608 JB 1H 472K-T-A
C643	4030006880	S.CERAMIC C1608 JB 1H 472K-T-A
C651	4030006880	S.CERAMIC C1608 JB 1H 472K-T-A
C661	4030006880	S.CERAMIC C1608 JB 1H 472K-T-A
C662	4030006880	S.CERAMIC C1608 JB 1H 472K-T-A
C663	4030006880	S.CERAMIC C1608 JB 1H 472K-T-A
C664	4030006880	S.CERAMIC C1608 JB 1H 472K-T-A
C665	4030006880	S.CERAMIC C1608 JB 1H 472K-T-A
C666	4030006880	S.CERAMIC C1608 JB 1H 472K-T-A
C667	4030006880	S.CERAMIC C1608 JB 1H 472K-T-A
C668	4030006880	S.CERAMIC C1608 JB 1H 472K-T-A
C669	4030006880	S.CERAMIC C1608 JB 1H 472K-T-A

S.=Surface mount

[MAIN-A UNIT]

REF NO.	ORDER NO.	DESCRIPTION	
C3764	4030006880	S.CERAMIC	C1608 JB 1H 472K-T-A
C3765	4030006880	S.CERAMIC	C1608 JB 1H 472K-T-A
C3766	4030006880	S.CERAMIC	C1608 JB 1H 472K-T-A
C3767	4030006880	S.CERAMIC	C1608 JB 1H 472K-T-A
C3768	4030006880	S.CERAMIC	C1608 JB 1H 472K-T-A
C3769	4030006880	S.CERAMIC	C1608 JB 1H 472K-T-A
C3770	4030006880	S.CERAMIC	C1608 JB 1H 472K-T-A
C3771	4030011600	S.CERAMIC	C1608 JB 1C 104KT-N
C3772	4030011600	S.CERAMIC	C1608 JB 1C 104KT-N
C3773	4030011600	S.CERAMIC	C1608 JB 1C 104KT-N
C3774	4030011600	S.CERAMIC	C1608 JB 1C 104KT-N
C3775	4510006670	S.ELECTROLYTIC	ECEV1CA471P
C3801	4030007090	S.CERAMIC	C1608 CH 1H 470J-T-A
C3802	4030007090	S.CERAMIC	C1608 CH 1H 470J-T-A
C3803	4030007090	S.CERAMIC	C1608 CH 1H 470J-T-A
RL351	6330001320	RELAY	AHY103
RL691	6330000540	RELAY	OMR-109F
CP213	6910009670	S.CHECK P	HK3-S-T
CP243	6910009670	S.CHECK P	HK3-S-T
CP271	6910009670	S.CHECK P	HK3-S-T
CP501	6910009670	S.CHECK P	HK3-S-T
J101	6510007020	CONNECTOR	TMP-J01X-V6
J201	6910012460	CONNECTOR	IMSA-9180S-30A
J202	6910012460	CONNECTOR	IMSA-9180S-30A
J211	6510007020	CONNECTOR	TMP-J01X-V6
J351	6450000140	CONNECTOR	HSJ0807-01-010
J641	6510018970	S.CONNECTOR	B4B-PH-SM3-TB
J661	6450000170	CONNECTOR	TCS4480-01-1111
J662	6450000160	CONNECTOR	TCS4470-01-1111
J681	6450001490	CONNECTOR	HLJ7001-01-3010
J691	6450001130	CONNECTOR	JPJ2042-01-110
J701	6450000140	CONNECTOR	HSJ0807-01-010
J741	6510022590	S.CONNECTOR	22FMN-BMTTR-A-TBT
J771	6510022600	S.CONNECTOR	30FMN-BMTTR-A-TBT
J811	6510022590	S.CONNECTOR	22FMN-BMTTR-A-TBT
J841	6510022610	S.CONNECTOR	16FMN-BMTTR-A-TBT
J861	6510022580	S.CONNECTOR	24FMN-BMTTR-A-TBT
J891	6510022580	S.CONNECTOR	24FMN-BMTTR-A-TBT
J1702	6510022620	S.CONNECTOR	10FMN-BMTTR-A-TBT
J3501	6510021860	CONNECTOR	BH-800.8 <Al>
J3502	6510019190	S.CONNECTOR	52365-0891
J3503	6510022060	S.CONNECTOR	AXK5S30235P
J3504	6510022060	S.CONNECTOR	AXK5S30235P
BT3501	3020000110	LITHIUM	CR2032
W122	7030003860	S.JUMPER	ERJ3GE JPW V
W252	7030003860	S.JUMPER	ERJ3GE JPW V
W278	7030003860	S.JUMPER	ERJ3GE JPW V
W291	7030003860	S.JUMPER	ERJ3GE JPW V
W308	7030003860	S.JUMPER	ERJ3GE JPW V
W309	7030003860	S.JUMPER	ERJ3GE JPW V
W311	7030003860	S.JUMPER	ERJ3GE JPW V
W319	7030003860	S.JUMPER	ERJ3GE JPW V
W354	7030003860	S.JUMPER	ERJ3GE JPW V
W355	7030003860	S.JUMPER	ERJ3GE JPW V
W451	7030003860	S.JUMPER	ERJ3GE JPW V
W452	7030008240	S.JUMPER	ERJ12YJ0R00U
W501	7030003860	S.JUMPER	ERJ3GE JPW V
W503	7030003860	S.JUMPER	ERJ3GE JPW V
W561	7030003860	S.JUMPER	ERJ3GE JPW V
W571	7030003860	S.JUMPER	ERJ3GE JPW V
W572	7030003860	S.JUMPER	ERJ3GE JPW V
W701	7030003860	S.JUMPER	ERJ3GE JPW V
W702	7030003860	S.JUMPER	ERJ3GE JPW V
W703	7030003860	S.JUMPER	ERJ3GE JPW V
W1001	7030009300	S.JUMPER	ERJ1WY0R00U
W3001	7030003860	S.JUMPER	ERJ3GE JPW V
W3010	7030003860	S.JUMPER	ERJ3GE JPW V
W3014	7030003860	S.JUMPER	ERJ3GE JPW V
W3504	7030003860	S.JUMPER	ERJ3GE JPW V
W3551	7030003860	S.JUMPER	ERJ3GE JPW V
W3601	7030003860	S.JUMPER	ERJ3GE JPW V
W3730	7030003860	S.JUMPER	ERJ3GE JPW V

[USA] only

[MAIN-A UNIT]

REF NO.	ORDER NO.	DESCRIPTION	
WS1	8970023940		SX2178 P352*J352 (1) /MA-A
EP1	0910054303	PCB	B 5705C

[DSP-A UNIT]

REF NO.	ORDER NO.	DESCRIPTION	
IC2001	1190000970	S.IC	ADSP-21061LKS-160
IC2041	1130008360	S.IC	TC7SHU04FU (TE85L)
IC2042	1130008040	S.IC	TC7SH04FU
IC2051	1130009310	S.IC	TC74VHC125FT (EL)
IC2052	1130009300	S.IC	TC7SET08FU (TE85L)
IC2053	1130006080	S.IC	TC74HC02AF (TP1)
IC2054	1130009620	S.IC	TC74VHC74FT (EL)
IC2061	1130009300	S.IC	TC7SET08FU (TE85L)
IC2062	1130009290	S.IC	TC74VHC541FT (EL)
IC2063	1130009300	S.IC	TC7SET08FU (TE85L)
IC2065	1130009300	S.IC	TC7SET08FU (TE85L)
IC2066	1130009300	S.IC	TC7SET08FU (TE85L)
IC2071	1130010511	IC	SC-1387-1
IC2072	1130009290	S.IC	TC74VHC541FT (EL)
IC2091	1110004920	S.IC	S-80934ANMP-DDY
IC2092	1130006540	S.IC	TC7S02FU (TE85R)
IC2101	1130008810	S.IC	TC7SH32FU (TE85L)
IC2201	1130008230	S.IC	BU4053BCFV-E2
IC2211	1110005240	S.IC	NJM4565M-T1
IC2281	1110003870	S.IC	NJM2058M-T1
IC2291	1130006220	S.IC	TC4W53FU (TE12L)
IC2301	1110005420	S.IC	BA1553ZF-E2
IC2302	1130006220	S.IC	TC4W53FU (TE12L)
IC2321	1190000960	S.IC	CS5396-KS
IC2341	1130009610	S.IC	TC74VHC00FT (EL)
IC2342	1130009630	S.IC	TC74VHC4040FT (EL)
IC2343	1130009280	S.IC	TC7WH74FU (TE12L)
IC2344	1130009620	S.IC	TC74VHC74FT (EL)
IC2345	1130008810	S.IC	TC7SH32FU (TE85L)
IC2346	1130009300	S.IC	TC7SET08FU (TE85L)
IC2347	1130007131	S.IC	TC74HC390AF (EL)
IC2348	1130009300	S.IC	TC7SET08FU (TE85L)
IC2351	1190001170	S.IC	AD1855JRSRL
IC2352	1130008360	S.IC	TC7SHU04FU (TE85L)
IC2353	1130008040	S.IC	TC7SH04FU
IC2371	1110001900	S.IC	µPC4570G2-T1
IC2372	1130008230	S.IC	BU4053BCFV-E2
IC2381	1110005060	S.IC	µPC4574G2-E1
IC2401	1190001100	S.IC	MAX293CWE-W
IC2441	1110003870	S.IC	NJM2058M-T1
IC2461	1110004770	S.IC	BU9480F-E2
IC2471	1110005240	S.IC	NJM4565M-T1
IC2472	1110005240	S.IC	NJM4565M-T1
IC2473	1130006220	S.IC	TC4W53FU (TE12L)
IC2474	1130008040	S.IC	TC7SH04FU
IC2475	1130009300	S.IC	TC7SET08FU (TE85L)
Q2201	1590001150	S.TRANSISTOR	UN9211 (TX)
Q2202	1590001150	S.TRANSISTOR	UN9211 (TX)
Q2211	1590001150	S.TRANSISTOR	UN9211 (TX)
Q2213	1590001150	S.TRANSISTOR	UN9211 (TX)
Q2321	1590002470	S.FET	2SJ381-TD
Q2322	1590002470	S.FET	2SJ381-TD
D2371	1730002320	S.ZENER	MA8051-M (TX)
D2372	1730002320	S.ZENER	MA8051-M (TX)
D2373	1790001250	S.DIODE	MA2S111-(TX)
X2041	6050009880	S.XTAL	CR-568 (40.000 MHz)
X2351	6050010650	S.XTAL	CR-643 (24.576 MHz)
L2001	6190001190	S.COIL	D10F-A814AY-101K=P3
L2401	6200003260	S.COIL	NL 322522T-101J
L2402	6200003260	S.COIL	NL 322522T-101J
L2461	6200003260	S.COIL	NL 322522T-101J

S.=Surface mount

[DSP-A UNIT]

REF NO.	ORDER NO.	DESCRIPTION	
L2502	6200003950	S.COIL	HF50ACC 322513-T
L2503	6200003950	S.COIL	HF50ACC 322513-T
L2504	6200003950	S.COIL	HF50ACC 322513-T
L2506	6200003950	S.COIL	HF50ACC 322513-T
R2001	7030003560	S.RESISTOR	ERJ3GEYJ 103 V (10 kΩ)
R2002	7030003560	S.RESISTOR	ERJ3GEYJ 103 V (10 kΩ)
R2003	7030003560	S.RESISTOR	ERJ3GEYJ 103 V (10 kΩ)
R2004	7030003560	S.RESISTOR	ERJ3GEYJ 103 V (10 kΩ)
R2005	7030003560	S.RESISTOR	ERJ3GEYJ 103 V (10 kΩ)
R2006	7030003560	S.RESISTOR	ERJ3GEYJ 103 V (10 kΩ)
R2007	7030003560	S.RESISTOR	ERJ3GEYJ 103 V (10 kΩ)
R2008	7030003560	S.RESISTOR	ERJ3GEYJ 103 V (10 kΩ)
R2009	7030003560	S.RESISTOR	ERJ3GEYJ 103 V (10 kΩ)
R2010	7030003560	S.RESISTOR	ERJ3GEYJ 103 V (10 kΩ)
R2011	7030003560	S.RESISTOR	ERJ3GEYJ 103 V (10 kΩ)
R2012	7030003560	S.RESISTOR	ERJ3GEYJ 103 V (10 kΩ)
R2013	7030003560	S.RESISTOR	ERJ3GEYJ 103 V (10 kΩ)
R2014	7030003560	S.RESISTOR	ERJ3GEYJ 103 V (10 kΩ)
R2015	7030003560	S.RESISTOR	ERJ3GEYJ 103 V (10 kΩ)
R2016	7030003560	S.RESISTOR	ERJ3GEYJ 103 V (10 kΩ)
R2017	7030003560	S.RESISTOR	ERJ3GEYJ 103 V (10 kΩ)
R2018	7030003560	S.RESISTOR	ERJ3GEYJ 103 V (10 kΩ)
R2019	7030003560	S.RESISTOR	ERJ3GEYJ 103 V (10 kΩ)
R2020	7030003560	S.RESISTOR	ERJ3GEYJ 103 V (10 kΩ)
R2041	7030003800	S.RESISTOR	ERJ3GEYJ 105 V (1 MΩ)
R2042	7030003320	S.RESISTOR	ERJ3GEYJ 101 V (100 Ω)
R2043	7030003320	S.RESISTOR	ERJ3GEYJ 101 V (100 Ω)
R2051	7030003320	S.RESISTOR	ERJ3GEYJ 101 V (100 Ω)
R2052	7030003320	S.RESISTOR	ERJ3GEYJ 101 V (100 Ω)
R2053	7030003320	S.RESISTOR	ERJ3GEYJ 101 V (100 Ω)
R2054	7030003320	S.RESISTOR	ERJ3GEYJ 101 V (100 Ω)
R2062	7030003640	S.RESISTOR	ERJ3GEYJ 473 V (47 kΩ)
R2063	7030003320	S.RESISTOR	ERJ3GEYJ 101 V (100 Ω)
R2064	7030003320	S.RESISTOR	ERJ3GEYJ 101 V (100 Ω)
R2065	7030003320	S.RESISTOR	ERJ3GEYJ 101 V (100 Ω)
R2066	7030003320	S.RESISTOR	ERJ3GEYJ 101 V (100 Ω)
R2067	7030003640	S.RESISTOR	ERJ3GEYJ 473 V (47 kΩ)
R2068	7030003640	S.RESISTOR	ERJ3GEYJ 473 V (47 kΩ)
R2071	7030003320	S.RESISTOR	ERJ3GEYJ 101 V (100 Ω)
R2072	7030003560	S.RESISTOR	ERJ3GEYJ 103 V (10 kΩ)
R2073	7030003560	S.RESISTOR	ERJ3GEYJ 103 V (10 kΩ)
R2074	7030003320	S.RESISTOR	ERJ3GEYJ 101 V (100 Ω)
R2083	7030003320	S.RESISTOR	ERJ3GEYJ 101 V (100 Ω)
R2091	7030003560	S.RESISTOR	ERJ3GEYJ 103 V (10 kΩ)
R2092	7030003320	S.RESISTOR	ERJ3GEYJ 101 V (100 Ω)
R2101	7030003680	S.RESISTOR	ERJ3GEYJ 104 V (100 kΩ)
R2102	7030003320	S.RESISTOR	ERJ3GEYJ 101 V (100 Ω)
R2201	7030003680	S.RESISTOR	ERJ3GEYJ 104 V (100 kΩ)
R2202	7030003320	S.RESISTOR	ERJ3GEYJ 101 V (100 Ω)
R2203	7030003320	S.RESISTOR	ERJ3GEYJ 101 V (100 Ω)
R2211	7030003680	S.RESISTOR	ERJ3GEYJ 104 V (100 kΩ)
R2212	7030003640	S.RESISTOR	ERJ3GEYJ 473 V (47 kΩ)
R2213	7030005451	S.RESISTOR	ERA3YED 153V
R2214	7030006101	S.RESISTOR	ERA3YED 183V
R2215	7030003370	S.RESISTOR	ERJ3GEYJ 271 V (270 Ω)
R2216	7030003460	S.RESISTOR	ERJ3GEYJ 152 V (1.5 kΩ)
R2217	7030003760	S.RESISTOR	ERJ3GEYJ 474 V (470 kΩ)
R2218	7030003320	S.RESISTOR	ERJ3GEYJ 101 V (100 Ω)
R2219	7030003750	S.RESISTOR	ERJ3GEYJ 394 V (390 kΩ)
R2220	7030003760	S.RESISTOR	ERJ3GEYJ 474 V (470 kΩ)
R2221	7030003700	S.RESISTOR	ERJ3GEYJ 154 V (150 kΩ)
R2222	7030003670	S.RESISTOR	ERJ3GEYJ 823 V (82 kΩ)
R2223	7030003670	S.RESISTOR	ERJ3GEYJ 823 V (82 kΩ)
R2224	7030003760	S.RESISTOR	ERJ3GEYJ 474 V (470 kΩ)
R2227	7310002720	S.TRIMMER	RV-148 (RH03A3AS3X0DA) 472
R2229	7310002720	S.TRIMMER	RV-148 (RH03A3AS3X0DA) 472
R2230	7030003430	S.RESISTOR	ERJ3GEYJ 821 V (820 Ω)
R2241	7030005321	S.RESISTOR	ERA3YED 103V
R2242	7030003720	S.RESISTOR	ERJ3GEYJ 224 V (220 kΩ)
R2243	7030005321	S.RESISTOR	ERA3YED 103V
R2244	7030008061	S.RESISTOR	ERA3YED 222V
R2245	7030007230	S.RESISTOR	ERA3YED 102V
R2252	7030006561	S.RESISTOR	ERA3YED 223V
R2253	7030006561	S.RESISTOR	ERA3YED 223V
R2254	7030006561	S.RESISTOR	ERA3YED 223V
R2255	7030006561	S.RESISTOR	ERA3YED 223V
R2256	7030006561	S.RESISTOR	ERA3YED 223V
R2257	7030003440	S.RESISTOR	ERJ3GEYJ 102 V (1 kΩ)
R2281	7030003320	S.RESISTOR	ERJ3GEYJ 101 V (100 Ω)
R2282	7030003320	S.RESISTOR	ERJ3GEYJ 101 V (100 Ω)

[DSP-A UNIT]

REF NO.	ORDER NO.	DESCRIPTION	
R2283	7030003560	S.RESISTOR	ERJ3GEYJ 103 V (10 kΩ)
R2291	7030003320	S.RESISTOR	ERJ3GEYJ 101 V (100 Ω)
R2292	7030003320	S.RESISTOR	ERJ3GEYJ 101 V (100 Ω)
R2293	7030003680	S.RESISTOR	ERJ3GEYJ 104 V (100 kΩ)
R2294	7030003560	S.RESISTOR	ERJ3GEYJ 103 V (10 kΩ)
R2302	7030003560	S.RESISTOR	ERJ3GEYJ 103 V (10 kΩ)
R2304	7030003560	S.RESISTOR	ERJ3GEYJ 103 V (10 kΩ)
R2306	7030005321	S.RESISTOR	ERA3YED 103V
R2307	7030003320	S.RESISTOR	ERJ3GEYJ 101 V (100 Ω)
R2308	7030005321	S.RESISTOR	ERA3YED 103V
R2309	7030003320	S.RESISTOR	ERJ3GEYJ 101 V (100 Ω)
R2321	7030009691	S.RESISTOR	ERA3YED 101V (100 Ω)
R2322	7030009691	S.RESISTOR	ERA3YED 101V (100 Ω)
R2323	7030009781	S.RESISTOR	ERA3YHD 680V
R2324	7030009781	S.RESISTOR	ERA3YHD 680V
R2325	7030004040	S.RESISTOR	ERJ3GEYJ 4R7 V (4.7 Ω)
R2326	7030003560	S.RESISTOR	ERJ3GEYJ 103 V (10 kΩ)
R2327	7030003480	S.RESISTOR	ERJ3GEYJ 222 V (2.2 kΩ)
R2328	7030003560	S.RESISTOR	ERJ3GEYJ 103 V (10 kΩ)
R2329	7030009891	S.RESISTOR	ERA3YED 151V
R2340	7030003290	S.RESISTOR	ERJ3GEYJ 560 V (56 Ω)
R2341	7030003320	S.RESISTOR	ERJ3GEYJ 101 V (100 Ω)
R2342	7030003320	S.RESISTOR	ERJ3GEYJ 101 V (100 Ω)
R2343	7030003320	S.RESISTOR	ERJ3GEYJ 101 V (100 Ω)
R2344	7030003320	S.RESISTOR	ERJ3GEYJ 101 V (100 Ω)
R2345	7030003320	S.RESISTOR	ERJ3GEYJ 101 V (100 Ω)
R2346	7030003320	S.RESISTOR	ERJ3GEYJ 101 V (100 Ω)
R2347	7030003320	S.RESISTOR	ERJ3GEYJ 101 V (100 Ω)
R2348	7030003320	S.RESISTOR	ERJ3GEYJ 101 V (100 Ω)
R2349	7030003290	S.RESISTOR	ERJ3GEYJ 560 V (56 Ω)
R2350	7030008071	S.RESISTOR	ERA3YED 273V
R2351	7030005321	S.RESISTOR	ERA3YED 103V
R2353	7030003800	S.RESISTOR	ERJ3GEYJ 105 V (1 MΩ)
R2354	7030003320	S.RESISTOR	ERJ3GEYJ 101 V (100 Ω)
R2355	7030008061	S.RESISTOR	ERA3YED 222V
R2356	7030008061	S.RESISTOR	ERA3YED 222V
R2357	7030008061	S.RESISTOR	ERA3YED 222V
R2358	7030008061	S.RESISTOR	ERA3YED 222V
R2359	7030008061	S.RESISTOR	ERA3YED 222V
R2360	7030008061	S.RESISTOR	ERA3YED 222V
R2361	7030003360	S.RESISTOR	ERJ3GEYJ 221 V (220 Ω)
R2362	7030003360	S.RESISTOR	ERJ3GEYJ 221 V (220 Ω)
R2363	7030003360	S.RESISTOR	ERJ3GEYJ 221 V (220 Ω)
R2364	7030003360	S.RESISTOR	ERJ3GEYJ 221 V (220 Ω)
R2365	7030003290	S.RESISTOR	ERJ3GEYJ 560 V (56 Ω)
R2369	7030003680	S.RESISTOR	ERJ3GEYJ 104 V (100 kΩ)
R2370	7030003680	S.RESISTOR	ERJ3GEYJ 104 V (100 kΩ)
R2371	7030006091	S.RESISTOR	ERA3YED 822V
R2372	7030003360	S.RESISTOR	ERJ3GEYJ 221 V (220 Ω)
R2373	7030003360	S.RESISTOR	ERJ3GEYJ 221 V (220 Ω)
R2374	7030003320	S.RESISTOR	ERJ3GEYJ 101 V (100 Ω)
R2375	7030003680	S.RESISTOR	ERJ3GEYJ 104 V (100 kΩ)
R2376	7030003510	S.RESISTOR	ERJ3GEYJ 392 V (3.9 kΩ)
R2377	7030003460	S.RESISTOR	ERJ3GEYJ 152 V (1.5 kΩ)
R2378	7030003680	S.RESISTOR	ERJ3GEYJ 104 V (100 kΩ)
R2379	7030008071	S.RESISTOR	ERA3YED 273V
R2380	7030003320	S.RESISTOR	ERJ3GEYJ 101 V (100 Ω)
R2381	7030003680	S.RESISTOR	ERJ3GEYJ 104 V (100 kΩ)
R2382	7030003440	S.RESISTOR	ERJ3GEYJ 102 V (1 kΩ)
R2383	7030003440	S.RESISTOR	ERJ3GEYJ 102 V (1 kΩ)
R2384	7030003440	S.RESISTOR	ERJ3GEYJ 102 V (1 kΩ)
R2385	7030003440	S.RESISTOR	ERJ3GEYJ 102 V (1 kΩ)
R2386	7030003440	S.RESISTOR	ERJ3GEYJ 102 V (1 kΩ)
R2387	7030005321	S.RESISTOR	ERA3YED 103V
R2388	7030005321	S.RESISTOR	ERA3YED 103V
R2389	7030009591	S.RESISTOR	ERA3YED 472V
R2390	7030003320	S.RESISTOR	ERJ3GEYJ 101 V (100 Ω)
R2391	7030003320	S.RESISTOR	ERJ3GEYJ 101 V (100 Ω)
R2392	7030003680	S.RESISTOR	ERJ3GEYJ 104 V (100 kΩ)
R2394	7030003680	S.RESISTOR	ERJ3GEYJ 104 V (100 kΩ)
R2402	7030005451	S.RESISTOR	ERA3YED 153V
R2403	7030005451	S.RESISTOR	ERA3YED 153V
R2404	7030006561	S.RESISTOR	ERA3YED 223V
R2421	7030003320	S.RESISTOR	ERJ3GEYJ 101 V (100 Ω)
R2422	7030003400	S.RESISTOR	ERJ3GEYJ 471 V (470 Ω)
R2423	7030003320	S.RESISTOR	ERJ3GEYJ 101 V (100 Ω)
R2424	7030003680	S.RESISTOR	ERJ3GEYJ 104 V (100 kΩ)
R2441	7030003520	S.RESISTOR	ERJ3GEYJ 472 V (4.7 kΩ)
R2442	7030003560	S.RESISTOR	ERJ3GEYJ 103 V (10 kΩ)
R2443	7030003560	S.RESISTOR	ERJ3GEYJ 103 V (10 kΩ)
R2444	7030003560	S.RESISTOR	ERJ3GEYJ 103 V (10 kΩ)
R2445	7030003560	S.RESISTOR	ERJ3GEYJ 103 V (10 kΩ)

S.=Surface mount

[DSP-A UNIT]

REF NO.	ORDER NO.	DESCRIPTION	
R2446	7030003560	S.RESISTOR	ERJ3GEYJ 103 V (10 kΩ)
R2447	7030003560	S.RESISTOR	ERJ3GEYJ 103 V (10 kΩ)
R2448	7030003560	S.RESISTOR	ERJ3GEYJ 103 V (10 kΩ)
R2449	7030003560	S.RESISTOR	ERJ3GEYJ 103 V (10 kΩ)
R2450	7030003440	S.RESISTOR	ERJ3GEYJ 102 V (1 kΩ)
R2451	7030003320	S.RESISTOR	ERJ3GEYJ 101 V (100 Ω)
R2452	7030003320	S.RESISTOR	ERJ3GEYJ 101 V (100 Ω)
R2453	7030003540	S.RESISTOR	ERJ3GEYJ 682 V (6.8 kΩ)
R2472	7030003680	S.RESISTOR	ERJ3GEYJ 104 V (100 kΩ)
R2474	7030003680	S.RESISTOR	ERJ3GEYJ 104 V (100 kΩ)
R2475	7030003600	S.RESISTOR	ERJ3GEYJ 223 V (22 kΩ)
R2476	7030003500	S.RESISTOR	ERJ3GEYJ 332 V (3.3 kΩ)
R2477	7030003320	S.RESISTOR	ERJ3GEYJ 101 V (100 Ω)
R2478	7030003320	S.RESISTOR	ERJ3GEYJ 101 V (100 Ω)
R2479	7030003560	S.RESISTOR	ERJ3GEYJ 103 V (10 kΩ)
R2480	7030003600	S.RESISTOR	ERJ3GEYJ 223 V (22 kΩ)
R2481	7030003500	S.RESISTOR	ERJ3GEYJ 332 V (3.3 kΩ)
R2482	7030003440	S.RESISTOR	ERJ3GEYJ 102 V (1 kΩ)
R2483	7030003470	S.RESISTOR	ERJ3GEYJ 182 V (1.8 kΩ)
R2484	7030003320	S.RESISTOR	ERJ3GEYJ 101 V (100 Ω)
R2485	7030003320	S.RESISTOR	ERJ3GEYJ 101 V (100 Ω)
R2486	7030003320	S.RESISTOR	ERJ3GEYJ 101 V (100 Ω)
R2503	7030003320	S.RESISTOR	ERJ3GEYJ 101 V (100 Ω)
R2505	7030003320	S.RESISTOR	ERJ3GEYJ 101 V (100 Ω)
R2507	7030003320	S.RESISTOR	ERJ3GEYJ 101 V (100 Ω)
R2509	7030003320	S.RESISTOR	ERJ3GEYJ 101 V (100 Ω)
R2510	7030003320	S.RESISTOR	ERJ3GEYJ 101 V (100 Ω)
R2511	7030003320	S.RESISTOR	ERJ3GEYJ 101 V (100 Ω)
R2512	7030003320	S.RESISTOR	ERJ3GEYJ 101 V (100 Ω)
R2513	7030003320	S.RESISTOR	ERJ3GEYJ 101 V (100 Ω)
R2514	7030003320	S.RESISTOR	ERJ3GEYJ 101 V (100 Ω)
R2515	7030003320	S.RESISTOR	ERJ3GEYJ 101 V (100 Ω)
R2516	7030003320	S.RESISTOR	ERJ3GEYJ 101 V (100 Ω)
R2517	7030003320	S.RESISTOR	ERJ3GEYJ 101 V (100 Ω)
R2518	7030003320	S.RESISTOR	ERJ3GEYJ 101 V (100 Ω)
R2519	7030003320	S.RESISTOR	ERJ3GEYJ 101 V (100 Ω)
R2520	7030003320	S.RESISTOR	ERJ3GEYJ 101 V (100 Ω)
R2521	7030003320	S.RESISTOR	ERJ3GEYJ 101 V (100 Ω)
R2523	7030003520	S.RESISTOR	ERJ3GEYJ 472 V (4.7 kΩ)
R2526	7030003320	S.RESISTOR	ERJ3GEYJ 101 V (100 Ω)
R2571	7030003670	S.RESISTOR	ERJ3GEYJ 823 V (82 kΩ)
R2572	7030003670	S.RESISTOR	ERJ3GEYJ 823 V (82 kΩ)
R2573	7030003670	S.RESISTOR	ERJ3GEYJ 823 V (82 kΩ)
R2575	7030003690	S.RESISTOR	ERJ3GEYJ 124 V (120 kΩ)
R2577	7030003320	S.RESISTOR	ERJ3GEYJ 101 V (100 Ω)
R2578	7030003760	S.RESISTOR	ERJ3GEYJ 474 V (470 kΩ)
R2579	7030003760	S.RESISTOR	ERJ3GEYJ 474 V (470 kΩ)
R2580	7030003760	S.RESISTOR	ERJ3GEYJ 474 V (470 kΩ)
R2581	7030003680	S.RESISTOR	ERJ3GEYJ 104 V (100 kΩ)
R2582	7030003680	S.RESISTOR	ERJ3GEYJ 104 V (100 kΩ)
R2583	7030003680	S.RESISTOR	ERJ3GEYJ 104 V (100 kΩ)
C2001	4030011600	S.CERAMIC	C1608 JB 1C 104KT-N
C2002	4030011600	S.CERAMIC	C1608 JB 1C 104KT-N
C2003	4030011600	S.CERAMIC	C1608 JB 1C 104KT-N
C2004	4030011600	S.CERAMIC	C1608 JB 1C 104KT-N
C2005	4030011600	S.CERAMIC	C1608 JB 1C 104KT-N
C2006	4030011600	S.CERAMIC	C1608 JB 1C 104KT-N
C2007	4030011600	S.CERAMIC	C1608 JB 1C 104KT-N
C2008	4030011600	S.CERAMIC	C1608 JB 1C 104KT-N
C2009	4030011600	S.CERAMIC	C1608 JB 1C 104KT-N
C2010	4030011600	S.CERAMIC	C1608 JB 1C 104KT-N
C2011	4030011600	S.CERAMIC	C1608 JB 1C 104KT-N
C2012	4030011600	S.CERAMIC	C1608 JB 1C 104KT-N
C2013	4030011600	S.CERAMIC	C1608 JB 1C 104KT-N
C2014	4030011600	S.CERAMIC	C1608 JB 1C 104KT-N
C2015	4030011600	S.CERAMIC	C1608 JB 1C 104KT-N
C2016	4030011600	S.CERAMIC	C1608 JB 1C 104KT-N
C2017	4030011600	S.CERAMIC	C1608 JB 1C 104KT-N
C2018	4030011600	S.CERAMIC	C1608 JB 1C 104KT-N
C2019	4030011600	S.CERAMIC	C1608 JB 1C 104KT-N
C2020	4030011600	S.CERAMIC	C1608 JB 1C 104KT-N
C2021	4030011600	S.CERAMIC	C1608 JB 1C 104KT-N
C2022	4030011600	S.CERAMIC	C1608 JB 1C 104KT-N
C2023	4030011600	S.CERAMIC	C1608 JB 1C 104KT-N
C2024	4030011600	S.CERAMIC	C1608 JB 1C 104KT-N
C2025	4030011600	S.CERAMIC	C1608 JB 1C 104KT-N
C2026	4510006220	S.ELECTROLYTIC	ECEV1CA101UP
C2027	4030011600	S.CERAMIC	C1608 JB 1C 104KT-N
C2028	4030011600	S.CERAMIC	C1608 JB 1C 104KT-N
C2029	4030011600	S.CERAMIC	C1608 JB 1C 104KT-N

[DSP-A UNIT]

REF NO.	ORDER NO.	DESCRIPTION	
C2030	4030011600	S.CERAMIC	C1608 JB 1C 104KT-N
C2031	4030011600	S.CERAMIC	C1608 JB 1C 104KT-N
C2033	4030012600	S.CERAMIC	C2012 JB 1A 105M-T-A
C2034	4030012600	S.CERAMIC	C2012 JB 1A 105M-T-A
C2035	4030012600	S.CERAMIC	C2012 JB 1A 105M-T-A
C2041	4030011600	S.CERAMIC	C1608 JB 1C 104KT-N
C2042	4030011600	S.CERAMIC	C1608 JB 1C 104KT-N
C2043	4030007030	S.CERAMIC	C1608 CH 1H 150J-T-A
C2044	4030007030	S.CERAMIC	C1608 CH 1H 150J-T-A
C2051	4030011600	S.CERAMIC	C1608 JB 1C 104KT-N
C2052	4030011600	S.CERAMIC	C1608 JB 1C 104KT-N
C2053	4030011600	S.CERAMIC	C1608 JB 1C 104KT-N
C2054	4030011600	S.CERAMIC	C1608 JB 1C 104KT-N
C2061	4030011600	S.CERAMIC	C1608 JB 1C 104KT-N
C2062	4030011600	S.CERAMIC	C1608 JB 1C 104KT-N
C2063	4030011600	S.CERAMIC	C1608 JB 1C 104KT-N
C2065	4030011600	S.CERAMIC	C1608 JB 1C 104KT-N
C2066	4030011600	S.CERAMIC	C1608 JB 1C 104KT-N
C2071	4030011600	S.CERAMIC	C1608 JB 1C 104KT-N
C2072	4030011600	S.CERAMIC	C1608 JB 1C 104KT-N
C2091	4030011600	S.CERAMIC	C1608 JB 1C 104KT-N
C2092	4030008890	S.CERAMIC	C1608 JB 1C 273K-T-A
C2093	4030011600	S.CERAMIC	C1608 JB 1C 104KT-N
C2101	4030011600	S.CERAMIC	C1608 JB 1C 104KT-N
C2201	4030011600	S.CERAMIC	C1608 JB 1C 104KT-N
C2202	4030011600	S.CERAMIC	C1608 JB 1C 104KT-N
C2210	4550006250	S.TANTALUM	TEMSVA 1A 106M-8L
C2211	4030006880	S.CERAMIC	C1608 JB 1H 472K-T-A
C2212	4030011600	S.CERAMIC	C1608 JB 1C 104KT-N
C2213	4030011600	S.CERAMIC	C1608 JB 1C 104KT-N
C2214	4510004630	S.ELECTROLYTIC	ECEV1CA100SR
C2215	4030011600	S.CERAMIC	C1608 JB 1C 104KT-N
C2216	4510004630	S.ELECTROLYTIC	ECEV1CA100SR
C2217	4030006860	S.CERAMIC	C1608 JB 1H 102K-T-A
C2218	4030006870	S.CERAMIC	C1608 JB 1H 222K-T-A
C2219	4030007170	S.CERAMIC	C1608 CH 1H 221J-T-A
C2220	4510004630	S.ELECTROLYTIC	ECEV1CA100SR
C2255	4030006870	S.CERAMIC	C1608 JB 1H 222K-T-A
C2256	4030011280	S.CERAMIC	C1608 CH 1H 271J-T-A
C2257	4030008470	S.CERAMIC	C1608 JB 1H 272K-T-A
C2258	4030011340	S.CERAMIC	C1608 CH 1H 471J-T-A
C2259	4030009580	S.CERAMIC	C1608 JB 1H 681K-T-A
C2260	4030007120	S.CERAMIC	C1608 CH 1H 820J-T-A
C2261	4030006880	S.CERAMIC	C1608 JB 1H 472K-T-A
C2262	4030010020	S.CERAMIC	C1608 JB 1H 122K-T-A
C2263	4030010040	S.CERAMIC	C1608 JB 1H 561K-T-A
C2281	4550000270	S.TANTALUM	TESVA 1E 474M1-8L
C2283	4030011600	S.CERAMIC	C1608 JB 1C 104KT-N
C2284	4510004630	S.ELECTROLYTIC	ECEV1CA100SR
C2285	4030011600	S.CERAMIC	C1608 JB 1C 104KT-N
C2286	4510004630	S.ELECTROLYTIC	ECEV1CA100SR
C2291	4030011600	S.CERAMIC	C1608 JB 1C 104KT-N
C2292	4030011600	S.CERAMIC	C1608 JB 1C 104KT-N
C2293	4340000250	S.MYLAR	ECHU 1C 104JX5
C2301	4510004630	S.ELECTROLYTIC	ECEV1CA100SR
C2302	4030011600	S.CERAMIC	C1608 JB 1C 104KT-N
C2303	4510006220	S.ELECTROLYTIC	ECEV1CA101UP
C2306	4030011600	S.CERAMIC	C1608 JB 1C 104KT-N
C2307	4510004630	S.ELECTROLYTIC	ECEV1CA100SR
C2308	4510005890	S.ELECTROLYTIC	ECEV1AAN100R
C2309	4030011600	S.CERAMIC	C1608 JB 1C 104KT-N
C2310	4510004630	S.ELECTROLYTIC	ECEV1CA100SR
C2311	4030011810	S.CERAMIC	C1608 JB 1A 224K-T-N
C2321	4030009880	S.CERAMIC	C1608 JB 1H 682K-T-A
C2322	4030009880	S.CERAMIC	C1608 JB 1H 682K-T-A
C2323	4030011600	S.CERAMIC	C1608 JB 1C 104KT-N
C2324	4510004630	S.ELECTROLYTIC	ECEV1CA100SR
C2325	4030011600	S.CERAMIC	C1608 JB 1C 104KT-N
C2327	4030011600	S.CERAMIC	C1608 JB 1C 104KT-N
C2328	4510006220	S.ELECTROLYTIC	ECEV1CA101UP
C2329	4030011600	S.CERAMIC	C1608 JB 1C 104KT-N
C2330	4030011600	S.CERAMIC	C1608 JB 1C 104KT-N
C2331	4510006220	S.ELECTROLYTIC	ECEV1CA101UP
C2341	4030011600	S.CERAMIC	C1608 JB 1C 104KT-N
C2342	4030011600	S.CERAMIC	C1608 JB 1C 104KT-N
C2343	4030011600	S.CERAMIC	C1608 JB 1C 104KT-N
C2344	4030007090	S.CERAMIC	C1608 CH 1H 470J-T-A
C2345	4030011600	S.CERAMIC	C1608 JB 1C 104KT-N
C2346	4030011600	S.CERAMIC	C1608 JB 1C 104KT-N
C2347	4030011600	S.CERAMIC	C1608 JB 1C 104KT-N
C2348	4030011600	S.CERAMIC	C1608 JB 1C 104KT-N
C2349	4030011600	S.CERAMIC	C1608 JB 1C 104KT-N

S.=Surface mount

[DSP-A UNIT]

REF NO.	ORDER NO.	DESCRIPTION
C2351	4030007010	S.CERAMIC C1608 CH 1H 100D-T-A
C2352	4030007010	S.CERAMIC C1608 CH 1H 100D-T-A
C2353	4510004630	S.ELECTROLYTIC ECEV1CA100SR
C2354	4030011600	S.CERAMIC C1608 JB 1C 104KT-N
C2355	4510004630	S.ELECTROLYTIC ECEV1CA100SR
C2356	4030011600	S.CERAMIC C1608 JB 1C 104KT-N
C2357	4510004630	S.ELECTROLYTIC ECEV1CA100SR
C2358	4030011600	S.CERAMIC C1608 JB 1C 104KT-N
C2359	4510004630	S.ELECTROLYTIC ECEV1CA100SR
C2360	4030011600	S.CERAMIC C1608 JB 1C 104KT-N
C2361	4030011600	S.CERAMIC C1608 JB 1C 104KT-N
C2362	4030006880	S.CERAMIC C1608 JB 1H 472K-T-A
C2363	4030006860	S.CERAMIC C1608 JB 1H 102K-T-A
C2364	4030007170	S.CERAMIC C1608 CH 1H 221J-T-A
C2365	4030006860	S.CERAMIC C1608 JB 1H 102K-T-A
C2366	4030007170	S.CERAMIC C1608 CH 1H 221J-T-A
C2367	4510004440	S.ELECTROLYTIC ECEV1HA010SR
C2372	4510004630	S.ELECTROLYTIC ECEV1CA100SR
C2373	4030011600	S.CERAMIC C1608 JB 1C 104KT-N
C2374	4510004630	S.ELECTROLYTIC ECEV1CA100SR
C2375	4030011600	S.CERAMIC C1608 JB 1C 104KT-N
C2376	4030011600	S.CERAMIC C1608 JB 1C 104KT-N
C2377	4030011600	S.CERAMIC C1608 JB 1C 104KT-N
C2378	4030011600	S.CERAMIC C1608 JB 1C 104KT-N
C2379	4030011600	S.CERAMIC C1608 JB 1C 104KT-N
C2380	4030011600	S.CERAMIC C1608 JB 1C 104KT-N
C2381	4030010020	S.CERAMIC C1608 JB 1H 122K-T-A
C2383	4030009980	S.CERAMIC C1608 JB 1H 152K-T-A
C2384	4030009000	S.CERAMIC C2012 JB 1C 224K-T-A
C2385	4030011330	S.CERAMIC C1608 CH 1H 391J-T-A
C2387	4030008470	S.CERAMIC C1608 JB 1H 272K-T-A
C2389	4030011280	S.CERAMIC C1608 CH 1H 271J-T-A
C2391	4510004630	S.ELECTROLYTIC ECEV1CA100SR
C2392	4030011600	S.CERAMIC C1608 JB 1C 104KT-N
C2393	4510004630	S.ELECTROLYTIC ECEV1CA100SR
C2394	4030011600	S.CERAMIC C1608 JB 1C 104KT-N
C2395	4030011810	S.CERAMIC C1608 JB 1A 224K-T-N
C2401	4030009490	S.CERAMIC C1608 JB 1H 821K-T-A
C2402	4030007150	S.CERAMIC C1608 CH 1H 151J-T-A
C2403	4510004630	S.ELECTROLYTIC ECEV1CA100SR
C2404	4030011600	S.CERAMIC C1608 JB 1C 104KT-N
C2405	4510004630	S.ELECTROLYTIC ECEV1CA100SR
C2406	4030011600	S.CERAMIC C1608 JB 1C 104KT-N
C2407	4030007130	S.CERAMIC C1608 CH 1H 101J-T-A
C2422	4030011600	S.CERAMIC C1608 JB 1C 104KT-N
C2424	4030011600	S.CERAMIC C1608 JB 1C 104KT-N
C2425	4030011810	S.CERAMIC C1608 JB 1A 224K-T-N
C2442	4030011600	S.CERAMIC C1608 JB 1C 104KT-N
C2443	4510007570	S.ELECTROLYTIC EEVHB1C220UR
C2444	4030011600	S.CERAMIC C1608 JB 1C 104KT-N
C2445	4510007570	S.ELECTROLYTIC EEVHB1C220UR
C2446	4030006880	S.CERAMIC C1608 JB 1H 472K-T-A
C2447	4030009580	S.CERAMIC C1608 JB 1H 681K-T-A
C2448	4030009880	S.CERAMIC C1608 JB 1H 682K-T-A
C2449	4030007160	S.CERAMIC C1608 CH 1H 181J-T-A
C2450	4030006860	S.CERAMIC C1608 JB 1H 102K-T-A
C2451	4030009580	S.CERAMIC C1608 JB 1H 681K-T-A
C2452	4030009630	S.CERAMIC C1608 JB 1H 822K-T-A
C2453	4030006880	S.CERAMIC C1608 JB 1H 472K-T-A
C2454	4030010020	S.CERAMIC C1608 JB 1H 122K-T-A
C2461	4510006220	S.ELECTROLYTIC ECEV1CA101UP
C2462	4030011600	S.CERAMIC C1608 JB 1C 104KT-N
C2463	4510004630	S.ELECTROLYTIC ECEV1CA100SR
C2471	4030011600	S.CERAMIC C1608 JB 1C 104KT-N
C2472	4030011600	S.CERAMIC C1608 JB 1C 104KT-N
C2473	4030011600	S.CERAMIC C1608 JB 1C 104KT-N
C2474	4030011600	S.CERAMIC C1608 JB 1C 104KT-N
C2475	4030011600	S.CERAMIC C1608 JB 1C 104KT-N
C2476	4030011600	S.CERAMIC C1608 JB 1C 104KT-N
C2478	4030012600	S.CERAMIC C2012 JB 1A 105M-T-A
C2479	4030006860	S.CERAMIC C1608 JB 1H 102K-T-A
C2480	4510004630	S.ELECTROLYTIC ECEV1CA100SR
C2501	4030011600	S.CERAMIC C1608 JB 1C 104KT-N
C2502	4510004630	S.ELECTROLYTIC ECEV1CA100SR
C2505	4510006220	S.ELECTROLYTIC ECEV1CA101UP
C2507	4510006220	S.ELECTROLYTIC ECEV1CA101UP
C2508	4030011600	S.CERAMIC C1608 JB 1C 104KT-N
C2509	4510006220	S.ELECTROLYTIC ECEV1CA101UP
C2510	4030011600	S.CERAMIC C1608 JB 1C 104KT-N
C2511	4510006220	S.ELECTROLYTIC ECEV1CA101UP
C2512	4030011600	S.CERAMIC C1608 JB 1C 104KT-N
C2514	4030006860	S.CERAMIC C1608 JB 1H 102K-T-A

[DSP-A UNIT]

REF NO.	ORDER NO.	DESCRIPTION
C2515	4030006860	S.CERAMIC C1608 JB 1H 102K-T-A
C2519	4030006860	S.CERAMIC C1608 JB 1H 102K-T-A
C2520	4030006860	S.CERAMIC C1608 JB 1H 102K-T-A
C2524	4030006860	S.CERAMIC C1608 JB 1H 102K-T-A
C2571	4030009000	S.CERAMIC C2012 JB 1C 224K-T-A
C2572	4030008910	S.CERAMIC C1608 JB 1C 393K-T-A
C2573	4030011600	S.CERAMIC C1608 JB 1C 104KT-N
C2574	4030009980	S.CERAMIC C1608 JB 1H 152K-T-A
C2578	4030011600	S.CERAMIC C1608 JB 1C 104KT-N
C2579	4510004630	S.ELECTROLYTIC ECEV1CA100SR
C2580	4030011600	S.CERAMIC C1608 JB 1C 104KT-N
C2581	4030011600	S.CERAMIC C1608 JB 1C 104KT-N
C2582	4030007130	S.CERAMIC C1608 CH 1H 101J-T-A
J2001	6510021650	CONNECTOR IMSA-9180B-30B
J2002	6510021650	CONNECTOR IMSA-9180B-30B
J2003	2610000400	CONNECTOR IC140-3206-BS4
W2201	7030003860	S.JUMPER ERJ3GE JPW V
W2226	7030003860	S.JUMPER ERJ3GE JPW V
W2228	7030003860	S.JUMPER ERJ3GE JPW V
W2301	7030003860	S.JUMPER ERJ3GE JPW V
W2302	7030003860	S.JUMPER ERJ3GE JPW V
W2401	7030003860	S.JUMPER ERJ3GE JPW V
W2471	7030003860	S.JUMPER ERJ3GE JPW V
W2505	7030003860	S.JUMPER ERJ3GE JPW V
EP1	0910054271	PCB B 5704A

S.=Surface mount

SECTION 6 MECHANICAL PARTS

[FRONT UNIT]

REF. NO.	ORDER NO.	DESCRIPTION	QTY.
DS1	5080000450	SLU2LC1EX5B-TH	1
ME1	5510000490	Meter ME-41	1
EP1	6910011090	Sensor unit RMS20-250-201-P	1
EP2	6450001230	Plate HLJ0999-01-480	1
EP3	6450001230	Plate HLJ0999-01-480	1
EP4	6910012500	Unit board TFD50W40-A	1
MP1	8210018221	1876 front panel (C)-1	1
MP2	8010016722	1876 sub chassis-2	1
MP3	8930041380	1876 window plate	1
MP4	8930056110	1876 power button (A)	1
MP5	8930050370	1876 4-key (A)	1
MP6	8930056090	1876 key board (B)	1
MP7	8930056100	1876 7-key (B)	1
MP8	8930050380	1876 5-key (A)	1
MP9	8930056080	1876 10-key (B)	1
MP10	8930041280	1876 2-key	1
MP11	8610010720	Knob N273	3
MP12	8610010260	Knob N252	3
MP13	8610010270	Knob N253	1
MP14	8610010650	Knob N268 assembly	1
MP19	8310052240	2495 A-name plate	1
MP20	8930041060	1876 brake plate	1
MP21	8930027470	1296 brake pad	1
MP23	8810008660	Screw PH BT M3 × 8 NI-ZU	6
MP24	8810008760	Screw PH BT M2 × 8 NI-ZU	1
MP25	8810008760	Screw PH BT M2 × 8 NI-ZU	2
MP26	8810009560	Screw PH BT M2 × 6 ZK	6
MP27	8810009560	Screw PH BT M2 × 6 ZK	6
MP29	8820000770	1296 screw	1
MP30	8810009390	Screw PH BT M3 × 18 NI-ZU	1
MP40	8810008760	Screw PH BT M2 × 8 NI-ZU	2
MP41	8810008760	Screw PH BT M2 × 8 NI-ZU	2
MP49	8810008200	Screw PH BT M2.6 × 6 NI-ZU	2
MP50	8810007300	Screw PH B0 M2.6 × 14 ZK	1
MP51	8610010740	Knob N273 (A)	1
MP52	8610010730	Knob N252 (A)	1
MP53	8850001250	Flat washer M2.6 (2.6 × 5 × 0.5)	1
MP54	8930051520	Polyester Tape No.631S #25 W8 L=230	1

[DISPLAY BOARD]

REF. NO.	ORDER NO.	DESCRIPTION	QTY.
R701	7210002890	Variable register RV-308	1
R702	7210002890	Variable register RV-308	1
MP1	8510012630	2178 shield case	1
MP3	8510010760	1876 DDS case	1
MP4	8510010770	1876 DDS cover	1
MP5	8510001081	Shield case (A)-1	1
MP6	8510001101	Shield cover (A)-1	1
MP7	8210013980	1876 reflector	1

[PBT BOARD]

REF. NO.	ORDER NO.	DESCRIPTION	QTY.
R1	7210002970	Variable register RV-314	1
S1	2250000410	Encoder TP90D96E20-30F-2178-1	1

[RIT BOARD]

REF. NO.	ORDER NO.	DESCRIPTION	QTY.
S1	2250000340	Encoder EVQ-VCJF0324B	1

[PHONE BOARD]

REF. NO.	ORDER NO.	DESCRIPTION	QTY.
J2	6450001980	Connector HLJ5815-01-030	1

[KEY BOARD]

REF. NO.	ORDER NO.	DESCRIPTION	QTY.
J2	6450001790	Connector HLJ7000-01-3010	1

[MIC BOARD]

REF. NO.	ORDER NO.	DESCRIPTION	QTY.
J1	6510000190	Connector FM214-8SS(P)	1

[CHASSIS PARTS]

REF. NO.	ORDER NO.	DESCRIPTION	QTY.
J5	6510000370	Connector MR-DS	1
J6	6510000370	Connector MR-DS	1
SP1	2510000760	SM-77KY0208	1
MF1	2710000630	Fan FBA08T12HC	1
W15	8900007150	Cable OPC-699	1
EP1	6910000340	Insulation sheet P101 (KD)	1
EP2	6910000310	Insulation washer B312D	1
MP1	8410002322	1876 heatsink (A)-2	1
MP2	8110005931	1876 T-cover-1	1
MP3	8110007100	2178 L-cover	1
MP4	8510012530	2178 A-plate	1
MP5	8510010730	1876 B-plate	1
MP6	8510010740	1876 C-plate	1
MP7	8510010751	1876 D-plate-1	1
MP8	8930041350	1876 main stand	2
MP9	8930041340	1876 sub stand	2
MP11	8930002910	Rubber foot (B)	2
MP12	8930002910	Rubber foot (B)	2
MP13	8930029730	1413 fan holder	1
MP15	8930037001	1691 earth plate-1	2
MP16	8930018520	TR crip (A)	1
MP17	8930035240	1546 TR-B crip	1
MP20	8810005770	Screw BiH M3 × 8 ZK	11
MP21	8810005770	Screw BiH M3 × 8 ZK	6
MP22	8810008660	Screw PH BT M3 × 8 NI-ZU	4
MP23	8810008660	Screw PH BT M3 × 8 NI-ZU	11
MP24	8810008660	Screw PH BT M3 × 8 NI-ZU	3
MP25	8810008660	Screw PH BT M3 × 8 NI-ZU	6
MP26	8810008660	Screw PH BT M3 × 8 NI-ZU	2
MP27	8810008660	Screw PH BT M3 × 8 NI-ZU	2
MP28	8810008660	Screw PH BT M3 × 8 NI-ZU	2

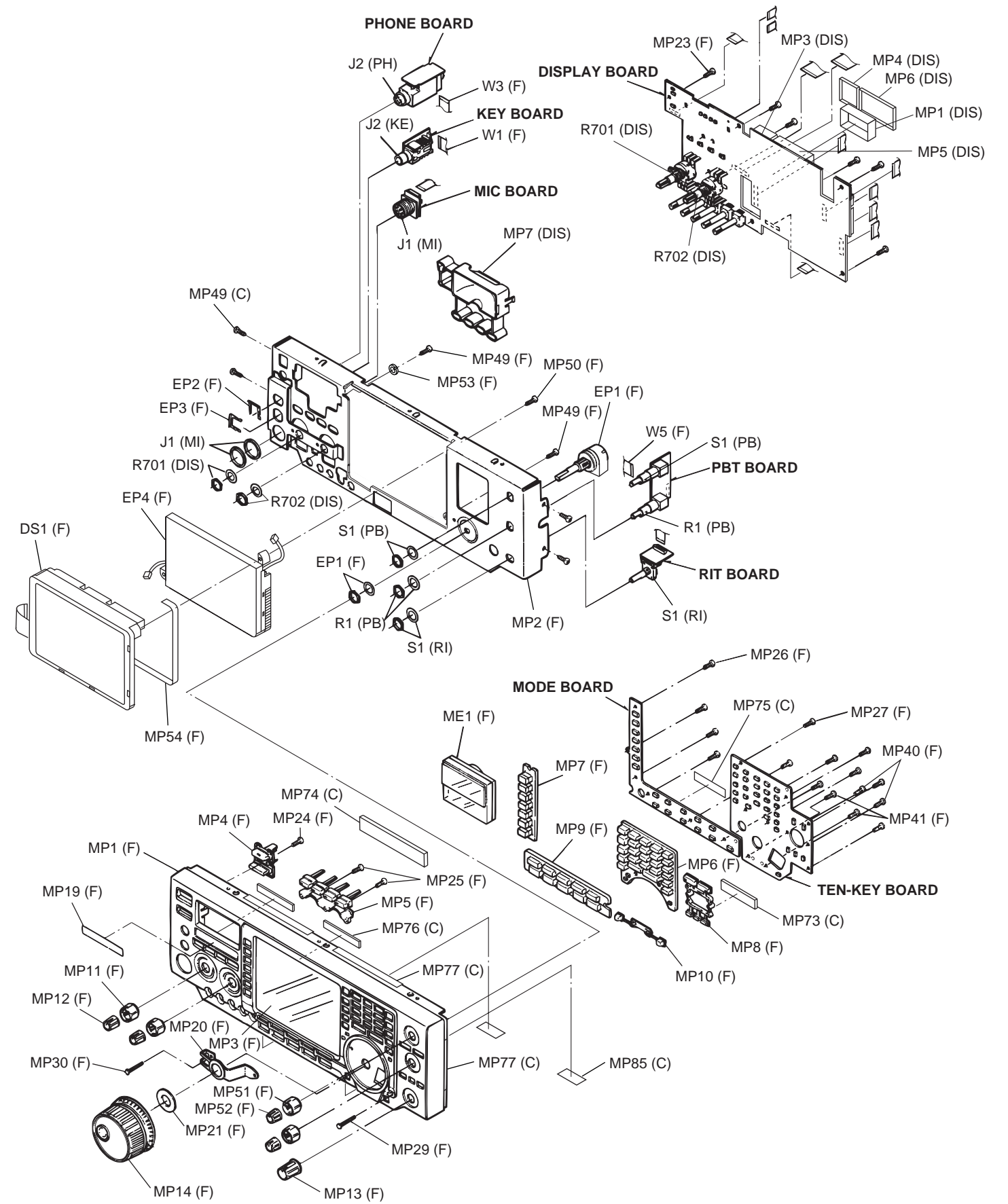
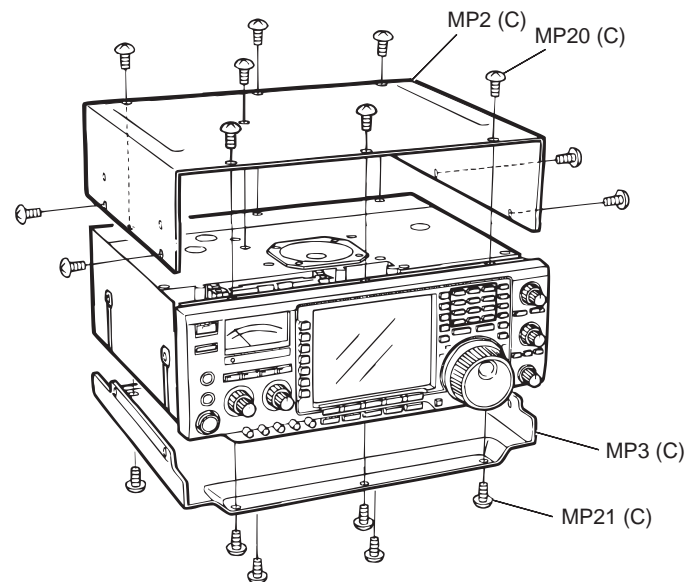
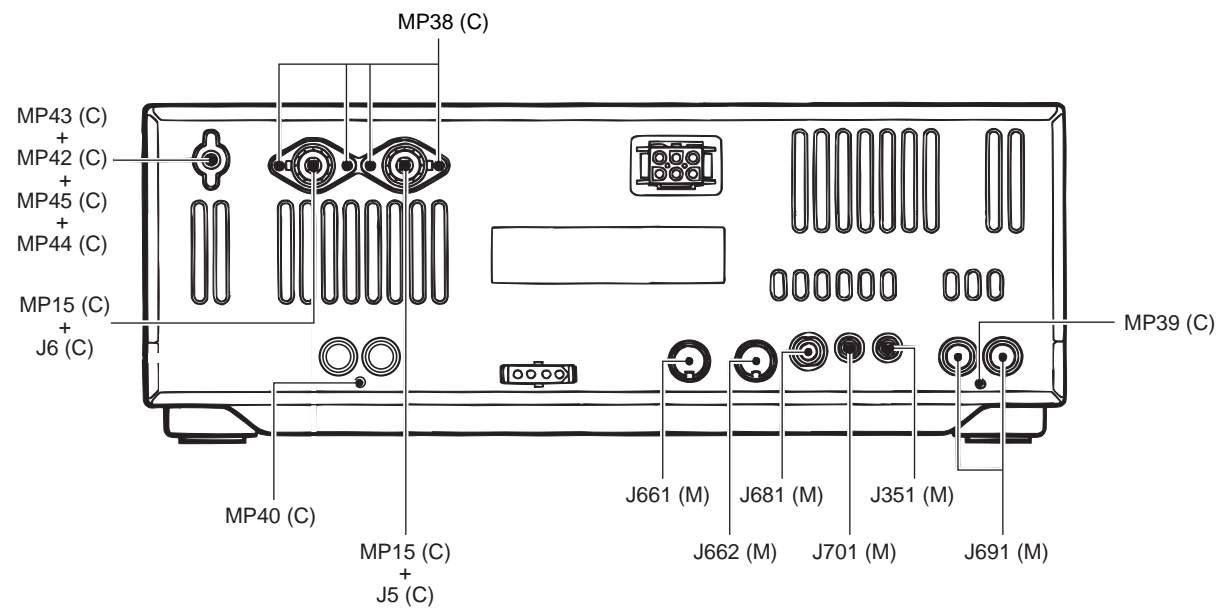
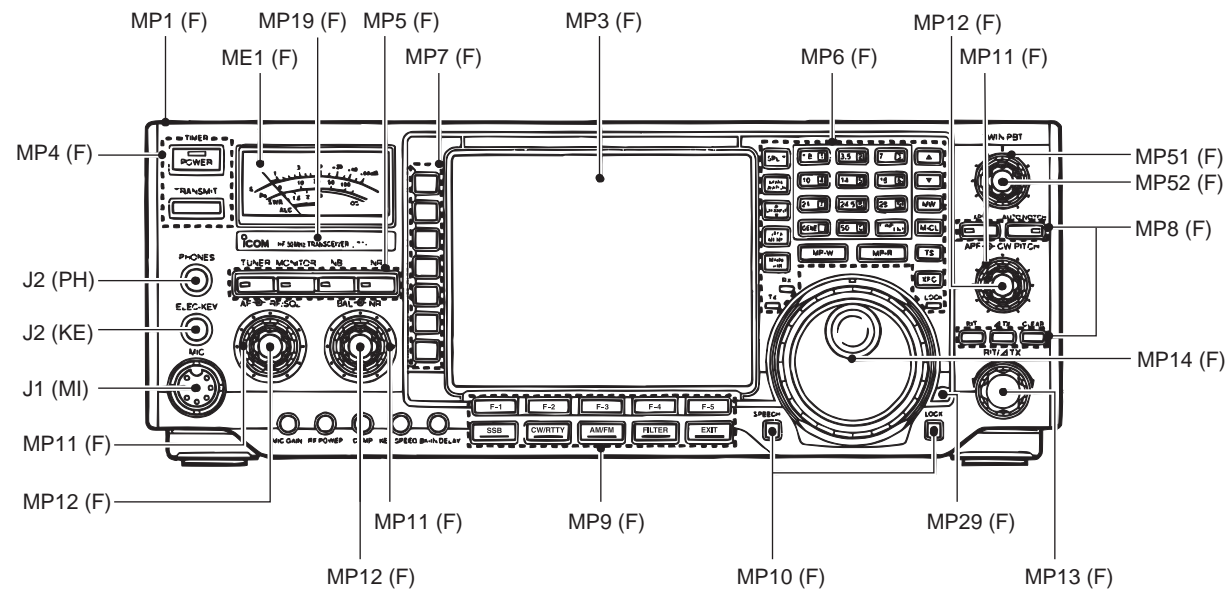

Unit abbreviations (F) : FRONT UNIT (C) : CHASSIS PARTS (PB) : PBT BOARD
 (RI) : RIT BOARD (DIS) : DISPLAY BOARD (MI) : MIC BOARD
 (KE) : KEY BOARD (PH) : PHONE BOARD

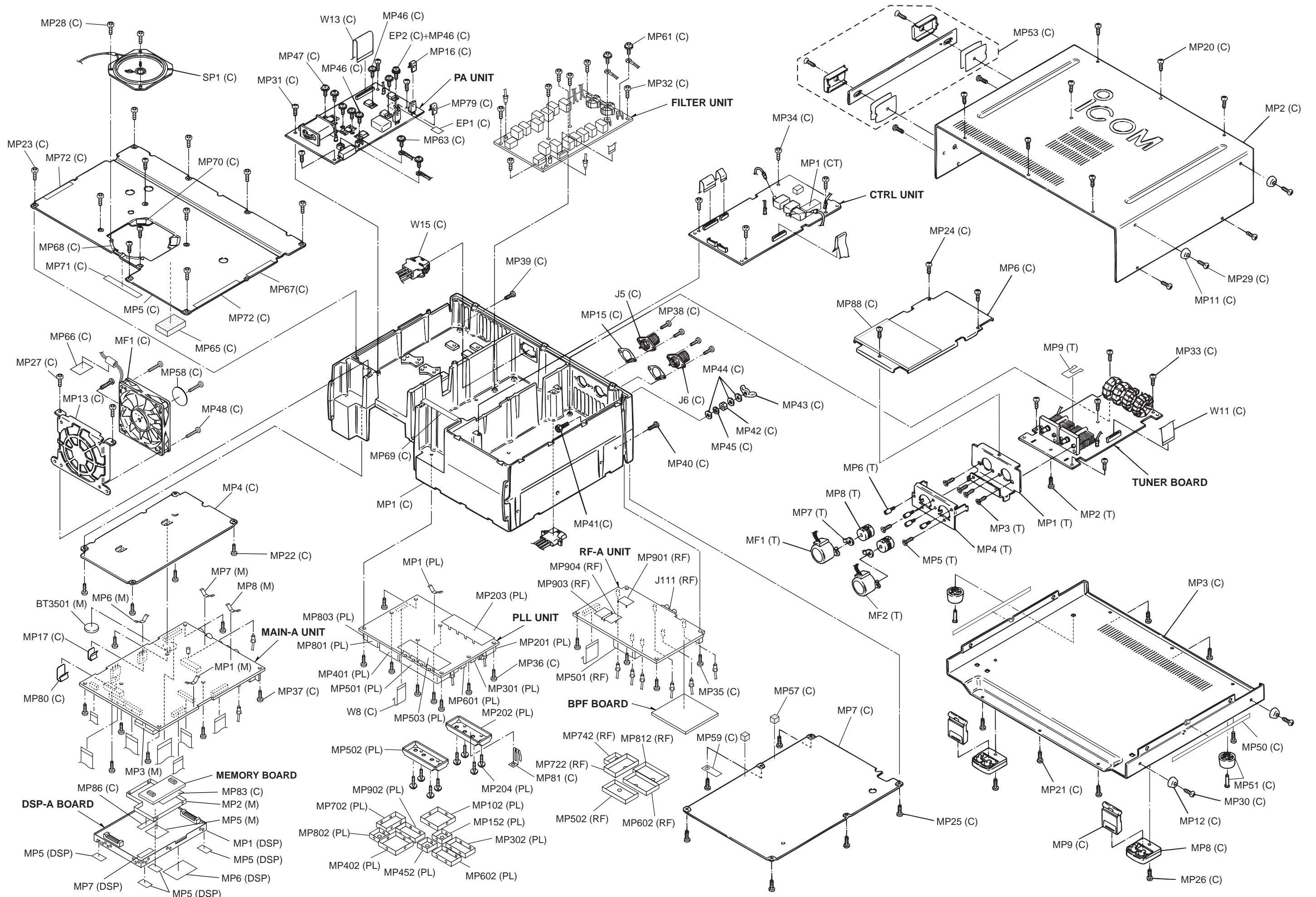

Unit abbreviations (C) : CHASSIS PARTS (M) : MAIN-A UNIT (RF) : RF-A UNIT (T) : TUNER BOARD
 (PL) : PLL UNIT (DSP) : DSP-A BOARD (CT) : CTRL UNIT

[CHASSIS PARTS]

REF. NO.	ORDER NO.	DESCRIPTION	QTY.
MP29	8810001650	Screw PH FT M3 × 6	2
MP30	8810001650	Screw PH FT M3 × 6	2
MP31	8810008660	Screw PH BT M3 × 8 NI-ZU	4
MP32	8810008660	Screw PH BT M3 × 8 NI-ZU	7
MP33	8810008660	Screw PH BT M3 × 8 NI-ZU	5
MP34	8810008660	Screw PH BT M3 × 8 NI-ZU	4
MP35	8810008660	Screw PH BT M3 × 8 NI-ZU	4
MP36	8810008660	Screw PH BT M3 × 8 NI-ZU	8
MP37	8810008660	Screw PH BT M3 × 8 NI-ZU	7
MP38	8810008660	Screw PH BT M3 × 8 NI-ZU	4
MP39	8810008660	Screw PH BT M3 × 8 NI-ZU	1
MP40	8810008660	Screw PH BT M3 × 8 NI-ZU	1
MP41	8810008160	Hex volt M5 × 18 NI (+)	1
MP42	8830000210	Nut M5 NI BS	1
MP43	8830000360	Wing nut M5 NI	1
MP44	8850000150	Flat washer M5 NI BS	3
MP45	8850000440	Spring washer M5 NI	1
MP46	8810003170	Setscrew A M3 × 8	4
MP47	8810003170	Setscrew A M3 × 8	4
MP48	8810000420	Screw PH M4 × 18	4
MP49	8810009310	Screw FH BT M3 × 6 NI-ZU	4
MP50	8930048120	Shield tape (A) 120 × 9	2
MP51	8930042690	Rubber foot (L)	2
MP53	8010018060	Carrying handle (A)	1
MP57	8930027900	Sponge (DD)	2
MP58	8930038820	Aluminum sheet (V)	1
MP59	8930001170	Earth spring (A)	1
MP61	8810003160	Setscrew A M3 × 6	2
MP63	8810003160	Setscrew A M3 × 6	2
MP65	8930043281	Sponge (EW)-1	1
MP66	8930043800	Double coated tape (S)	1
MP67	8930029050	Non-woven sheet (AL)	1
MP68	8930032130	Non-woven sheet (AQ)	2
MP69	8930029050	Non-woven sheet (AL)	1
MP70	8930008670	Sponge (AQ)	2
MP71	8930043490	Sponge (FB)	1
MP72	8930007840	Non-woven sheet (K)	2
MP73	8930043600	Sponge (FE)	1
MP74	8930043480	Sponge (FA)	1
MP75	8930041160	Non-woven sheet (BO)	1
MP76	8930037830	Sponge (ED)	2
MP77	8930007840	Non-woven sheet (K)	4
MP79	8930035240	1546 TR-B crip	1
MP80	8930027940	1126 TR-B crip	1
MP81	8930017260	758 module earth spring	1
MP83	8930043090	Sponge (EV)	1
MP85	8930049130	Shield tape (D) 20 × 9	2
MP86	8930052100	Shield sponge (C)	1
MP88	8930054550	Insulation sheet (GL)	1

[MAIN-A UNIT]

REF. NO.	ORDER NO.	DESCRIPTION	QTY.
BT3501	3020000110	Lithium battery CR2032	1
J351	6450000140	Connector HSJ0807-01-010	1
J661	6450000170	Connector TCS4480-01-1111	1
J662	6450000160	Connector TCS4470-01-1111	1
J681	6450001490	Connector HLJ7001-01-3010	1
J691	6450001130	Connector JPL2042-01-110	1
J701	6450000140	Connector HSJ0807-01-010	1
MP1	8930014140	Earth spring (D)	1
MP2	8510012880	2178 A-shield cover assembly	1
MP3	8510012780	2178 A-shield case	1
MP5	8930032290	Sponge (DQ)	1
MP6	8930014140	Earth spring (D)	1
MP7	8930014140	Earth spring (D)	1
MP8	8930014140	Earth spring (D)	1

[DSP-A UNIT]

REF. NO.	ORDER NO.	DESCRIPTION	QTY.
MP1	8510012573	2178 DSP case-3	1
MP5	8930043440	Sponge (EY)	4
MP6	8930052890	Shield tape (G)	1
MP7	8930027700	Insulation sheet (E)	1

[RF-A UNIT]

REF. NO.	ORDER NO.	DESCRIPTION	QTY.
J111	6450001130	Connector JPJ2042-01-110	1
MP501	8510000230	220 shield case	1
MP502	8510000241	220 shield cover-1	1
MP601	8510000230	220 shield case	1
MP602	8510000241	220 shield cover-1	1
MP721	8510000230	220 shield case	1
MP722	8510000241	220 shield cover-1	1
MP741	8510005150	602 shield case	1
MP742	8510005160	602 shield cover	1
MP811	8510000230	220 shield case	1
MP812	8510000241	220 shield cover-1	1
MP901	8510002280	VCO shield plate (A)	1
MP903	8510002280	VCO shield plate (A)	1
MP904	8510002280	VCO shield plate (A)	1

[CTRL UNIT]

REF. NO.	ORDER NO.	DESCRIPTION	QTY.
MP1	8510002020	MIX shield case	1

[PLL UNIT]

REF. NO.	ORDER NO.	DESCRIPTION	QTY.
MP1	8930014140	Earth spring (D)	1
MP51	8510000230	220 shield case	1
MP101	8510010760	1876 DDS case	1
MP102	8510010770	1876 DDS cover	1
MP103	8510005330	Coil case	1
MP151	8510012550	2178 DDS case	1
MP152	8510012580	2178 DDS cover	1
MP201	8510012540	2178 VCO case	1
MP202	8510011520	2072 VCO cover	1
MP203	8510011710	2072 VCO shield plate	1
MP204	8810003960	Setscrew A M2.6 × 5	8
MP301	8510005980	724 shield case	1
MP302	8510005990	724 shield cover	1
MP401	8510010760	1876 DDS case	1
MP402	8510010770	1876 DDS cover	1
MP403	8510005330	Coil case	1
MP451	8510012550	2178 DDS case	1
MP452	8510012580	2178 DDS cover	1
MP501	8510012540	2178 VCO case	1
MP502	8510011520	2072 VCO cover	1
MP503	8510011710	2072 VCO shield plate	1
MP601	8510005980	724 shield case	1
MP602	8510005990	724 shield cover	1
MP701	8510005980	724 shield case	1
MP702	8510005990	724 shield cover	1
MP801	8510012550	2178 DDS case	1
MP802	8510012580	2178 DDS cover	1
MP803	8510012400	2177 D/A case	1
MP901	8510005980	724 shield case	1
MP902	8510005990	724 shield cover	1

[TUNER BOARD]

REF. NO.	ORDER NO.	DESCRIPTION	QTY.
MF1	2710000460	Motor MP28GA	1
MF2	2710000460	Motor MP28GA	1
MP1	8930041090	1876 A-angle	1
MP2	8810008660	Screw PH BT M3 × 8 NI-ZU	1
MP3	8810009060	Screw FH M3 × 6 ZK	4
MP4	8930041110	1876 B-angle	1
MP5	8810009060	Screw FH M3 × 6 ZK	2
MP6	8820000880	1528 screw	4
MP7	8930030111	1414 plate-1	2
MP8	8950003200	UJ6-5 (universal couplings)	2
MP9	8930051580	2178 tuner plate	1

[UNPACKING]

REF. NO.	ORDER NO.	DESCRIPTION	QTY.
F1	5210000090	Fuse FGB 30A	2
F2	5210000060	Fuse FGB 5A	1
MC1	Optional product	Hand microphone HM-36	1
W1	Optional product	DC power cable OPC-025D	1

Screw abbreviations BT: Self-tapping B0: Self-tapping
 FT: Self-tapping PH: Pan head
 FH: Flat head BiH: Bind head
 NI-ZU: Nickel-zinc NI: Nickel
 BS: Brass ZK:Black





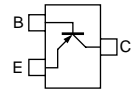
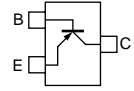
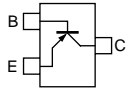
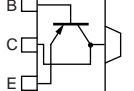
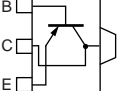
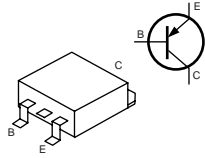
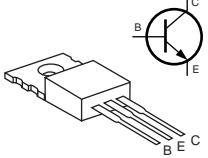
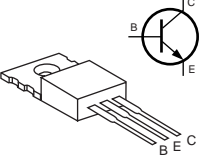
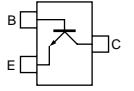
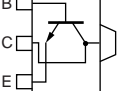
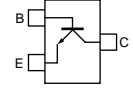
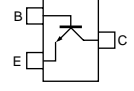
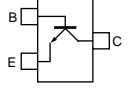
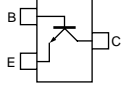
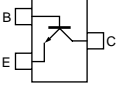
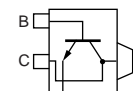
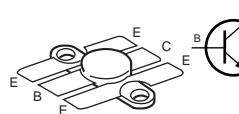
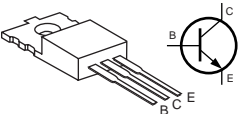
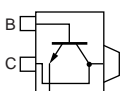
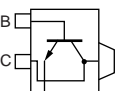
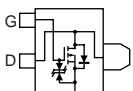
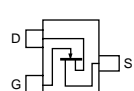
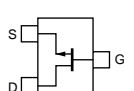
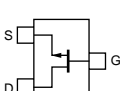
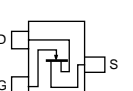
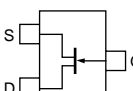
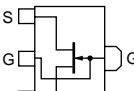
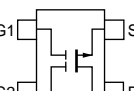
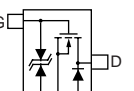
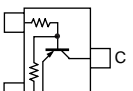
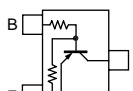
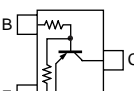
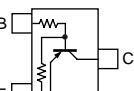
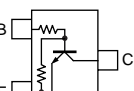
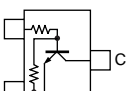

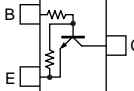
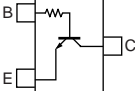
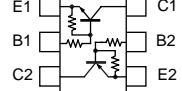
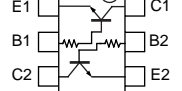
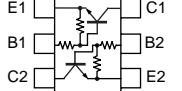
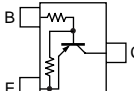
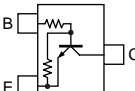
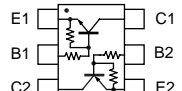



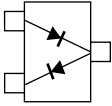
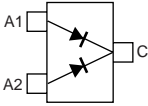
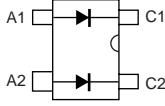
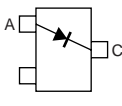
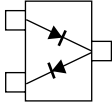
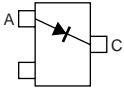
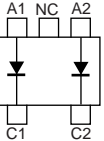

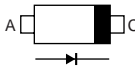
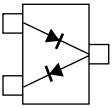
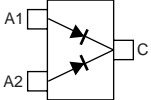
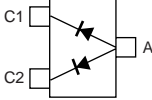
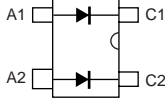
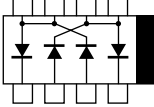
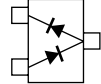
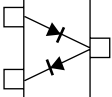
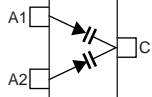
SECTION 7 SEMI-CONDUCTOR INFORMATION

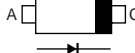
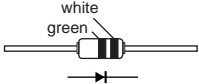
• TRANSISTORS AND FET'S

2SA1162 GR (Symbol: SG) 	2SA1576A T106 R (Symbol: FR) 	2SA1577 (Symbol: HP) 	2SB1124 S TD (Symbol: BG) 	2SB1132 T100 R (Symbol: BAR) 
2SB1201 S (Symbol: B1201) 	2SC1971 (Symbol: None) 	2SC1972 (Symbol: None) 	2SC2714 O (Symbol: QO) 	2SC3647 S TD (Symbol: CC) 
2SC4081 T107 R (Symbol: BR) 	2SC4117 GR (Symbol: DG) 	2SC4213 B (Symbol: AB) 	2SC4403 3 TL (Symbol: LY3) 	2SC4405 3 TL (Symbol: OY3) 
2SC4673 D TD (Symbol: CO) 	2SC5125 	2SD1585 K (Symbol: None) 	2SD1619 T TD (Symbol: DB) 	2SD1801 S TL (Symbol: CE) 
2SJ381 TD (Symbol: JI) 	2SK210 GR (Symbol: YG) 	2SK508 K52 T2B (Symbol: K52) 	2SK515 T1B (Symbol: X33) 	2SK882 GR (Symbol: TGR) 
2SK1740 (Symbol: IJ) 	2SK2171 4 TD (Symbol: KM) 	3SK131 T2 MAS (Symbol: V11) 	CPH3404-TL (Symbol: KD) 	DTA114 EE TL (Symbol: 14) 
DTA114EUA T106 (Symbol: 14) 	DTA144 EE TL (Symbol: 16) 	DTB123 EK T147 (Symbol: F12) 	DTC114 EE TL (Symbol: 24) 	DTC114EUA T106 (Symbol: 24) 

DTC144 EE TL (Symbol: 26) 	DTC144 TE (Symbol: 06) 	UMD3 N TL (Symbol: D3) 	UMH4N TN (Symbol: H4) 	UMH11N TN (Symbol: H11) 
UN911H (Symbol: 6P) 	UN9211 (Symbol: 8A) 	XP4311 (Symbol: 3X) 		

• DIODES

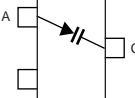
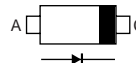
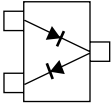
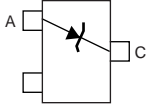
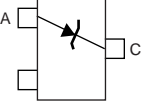
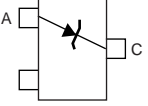
<p>1SS226 (Symbol: C3)</p> 	<p>1SS301 (Symbol: B3)</p> 	<p>1SS319 (Symbol: A4)</p> 	<p>1SS322 (Symbol: A9)</p> 	<p>1SS375-TL (Symbol: FH)</p> 
<p>1SV263 TL (Symbol: JV)</p> 	<p>1SV265 TL (Symbol: LV)</p> 	<p>1SV307 (Symbol: TX)</p> 	<p>1SV308 (Symbol: TX)</p> 	<p>DA221 TL (Symbol: K)</p> 
<p>DAN222TL (Symbol: N)</p> 	<p>DAP222 TL (Symbol: P)</p> 	<p>DWA010 TE (Symbol: W8)</p> 	<p>HSB88WSTR (Symbol: Silver line)</p> 	<p>HSM88ASR TR (Symbol: C3)</p> 
<p>HSM88AS TR (Symbol: C1)</p> 	<p>KV1470 TL (Symbol: F7)</p> 	<p>MA77 (Symbol: 4B)</p> 	<p>MA114 (Symbol: 1E)</p> 	<p>MA185 (White, Green lines)</p> 
<p>MA29B (Symbol: Y)</p> 	<p>MA2S111 (Symbol: A)</p> 	<p>MA2S728 (Symbol: B)</p> 	<p>MA338 (Symbol: 6H)</p> 	<p>MA357 (Symbol: 7K)</p> 
<p>MA8030 H (Symbol: 3^0)</p> 	<p>MA8033 L (Symbol: 3_3)</p> 	<p>MA8051 M (Symbol: 5-1)</p> 	<p>MMBV3700LT1 (Symbol: 4R)</p> 	<p>RB050L 40 (Symbol: 35)</p> 
<p>RB706F-40 T106 (Symbol: 3J)</p> 	<p>RD5.1M T2B2 (Symbol: 512)</p> 	<p>RD5.6M T2B2 (Symbol: 562)</p> 	<p>RD20M T2B1 (Symbol: 201)</p> 	

SECTION 8 BOARD LAYOUTS

8-1 PBT, RIT AND MIC BOARDS

• PBT BOARD

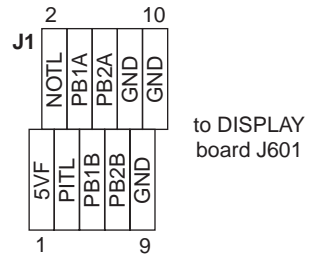
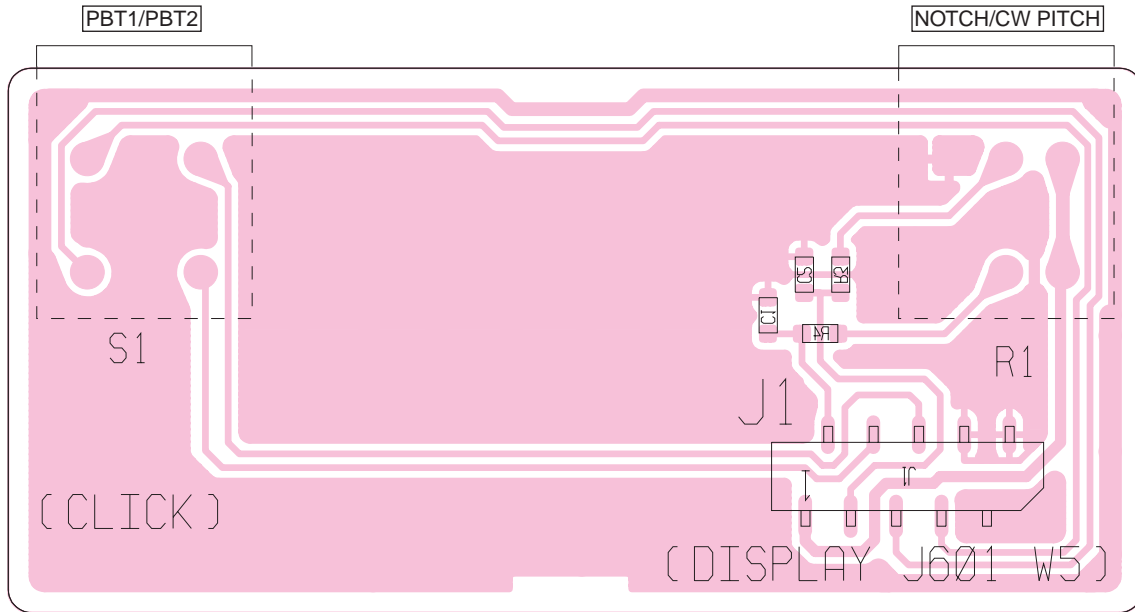

• RIT BOARD

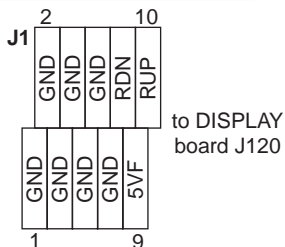
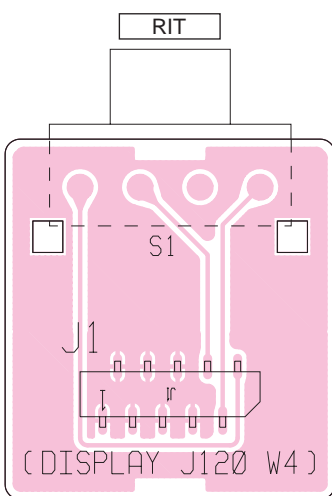

• MIC BOARD

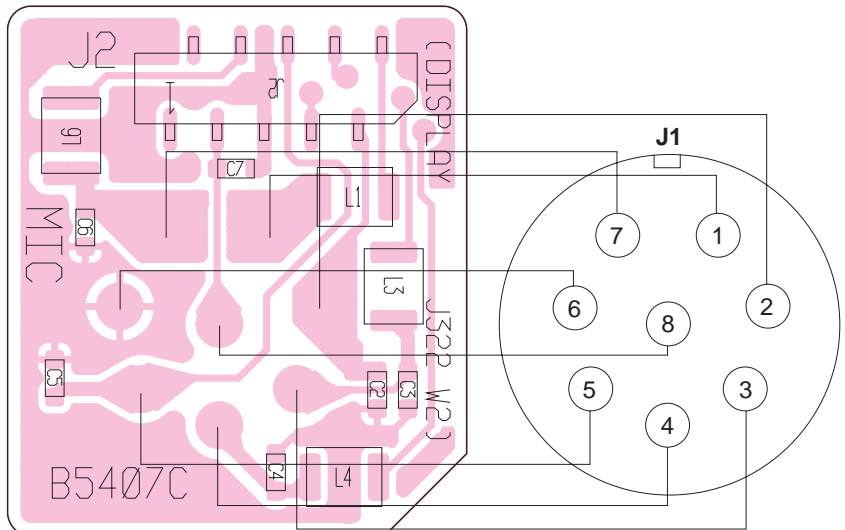
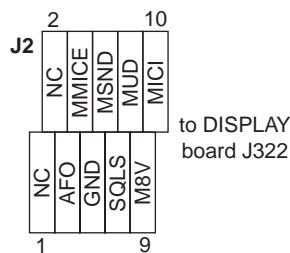

8-2 DISPLAY BOARD (TOP VIEW)

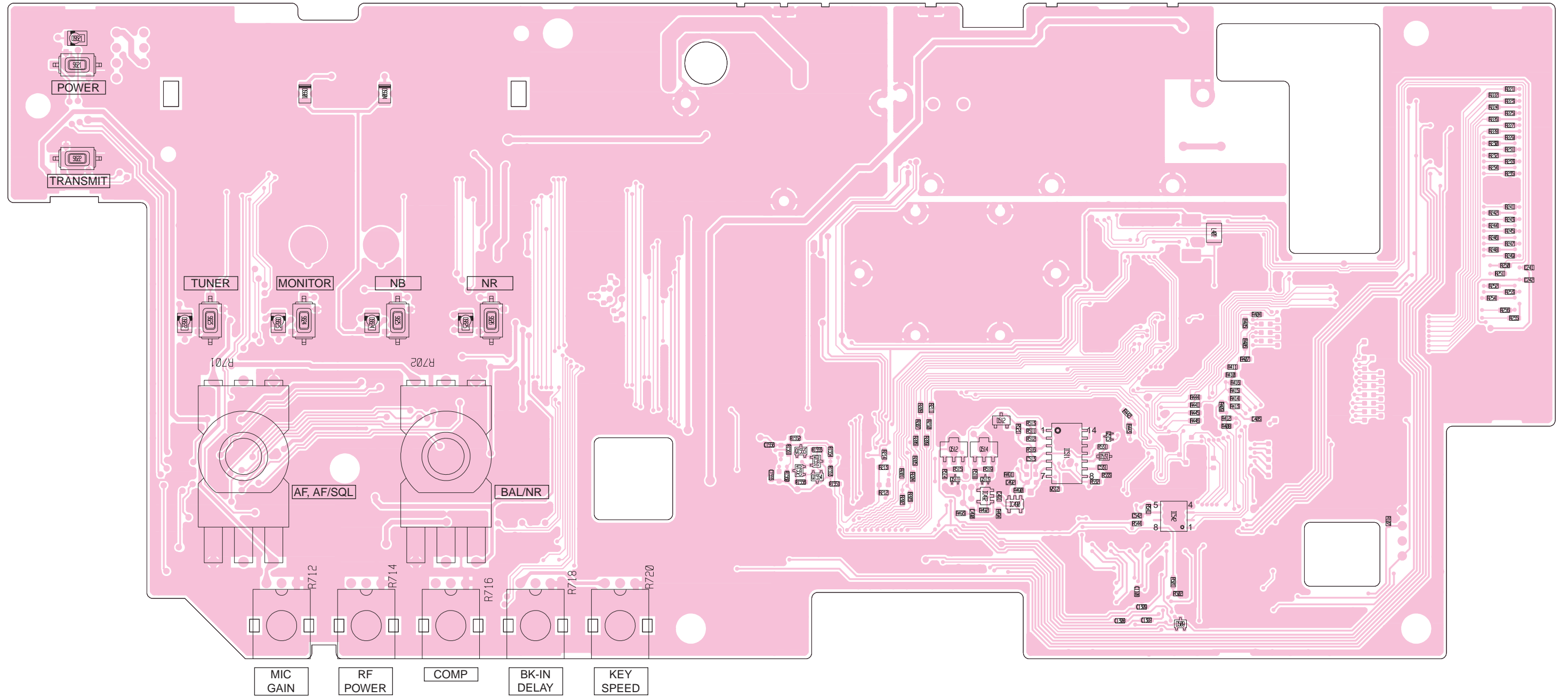

• DISPLAY BOARD (BOTTOM VIEW)

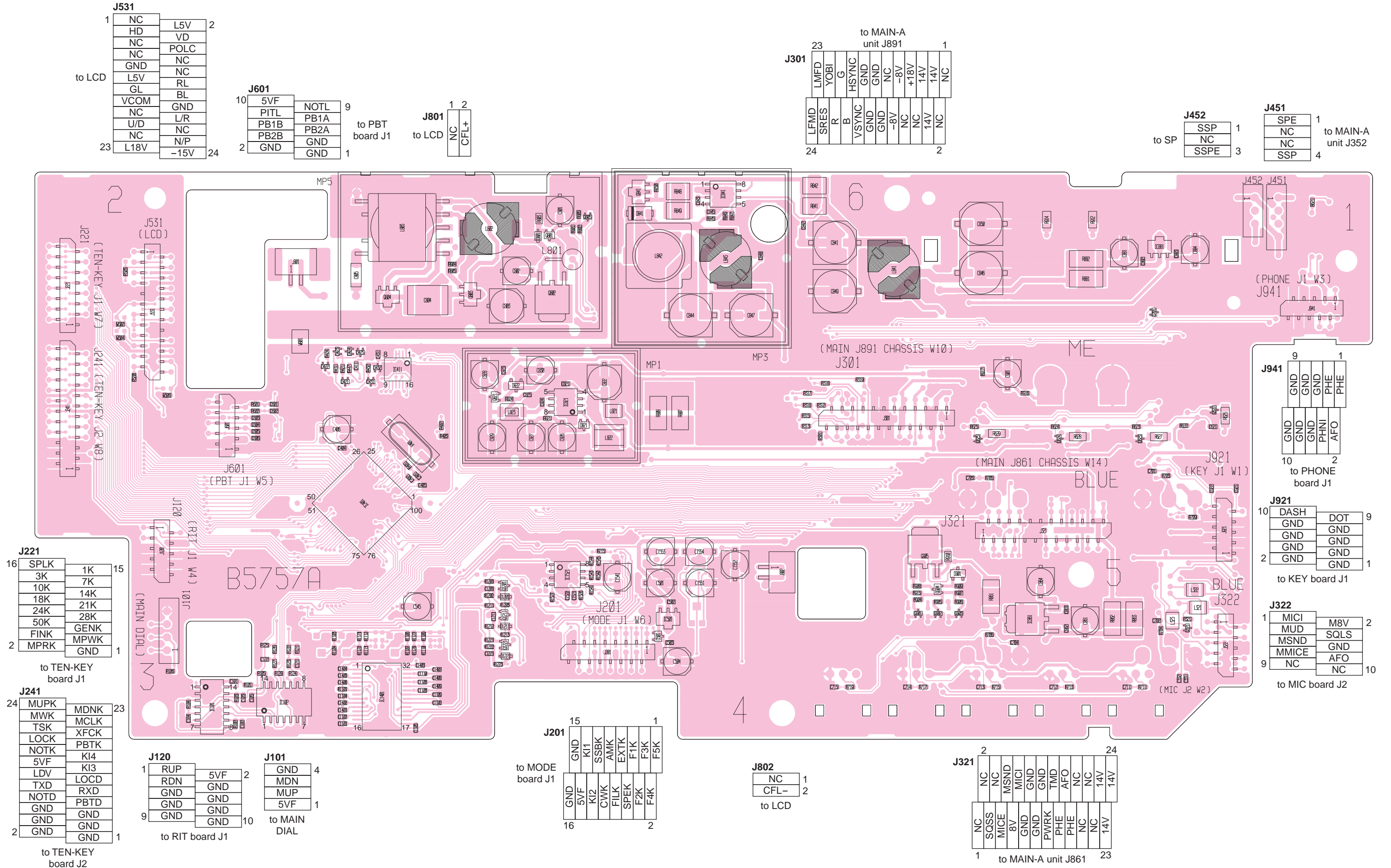

8-3 MODE, PHONE, KEY AND TEN-KEY BOARDS

• MODE BOARD (TOP VIEW)

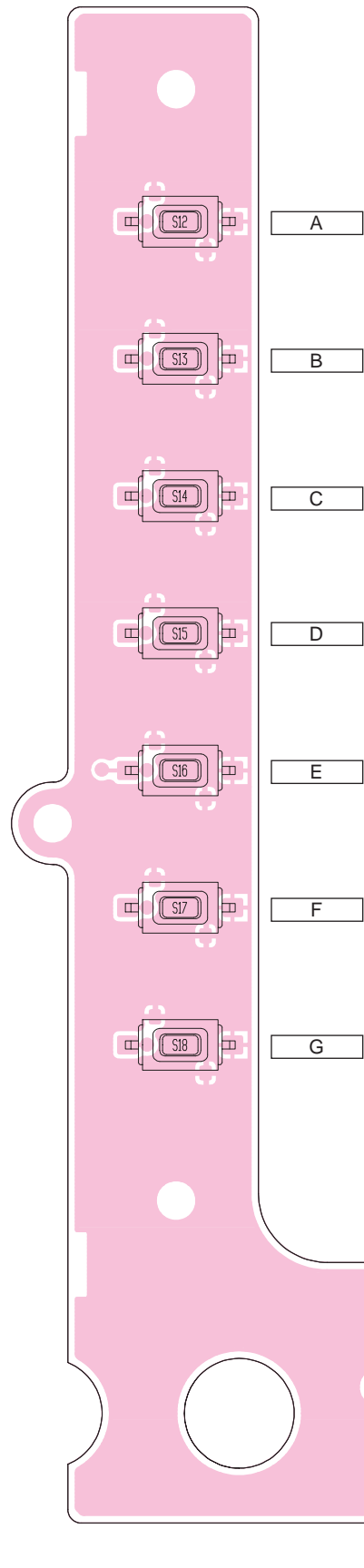

• PHONE BOARD

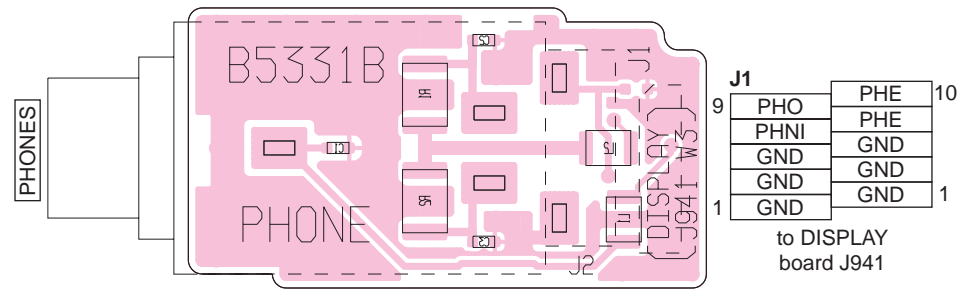

• KEY BOARD

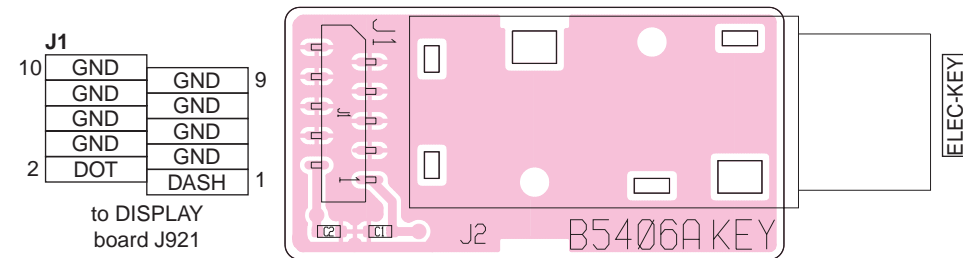

• TEN-KEY BOARD (TOP VIEW)

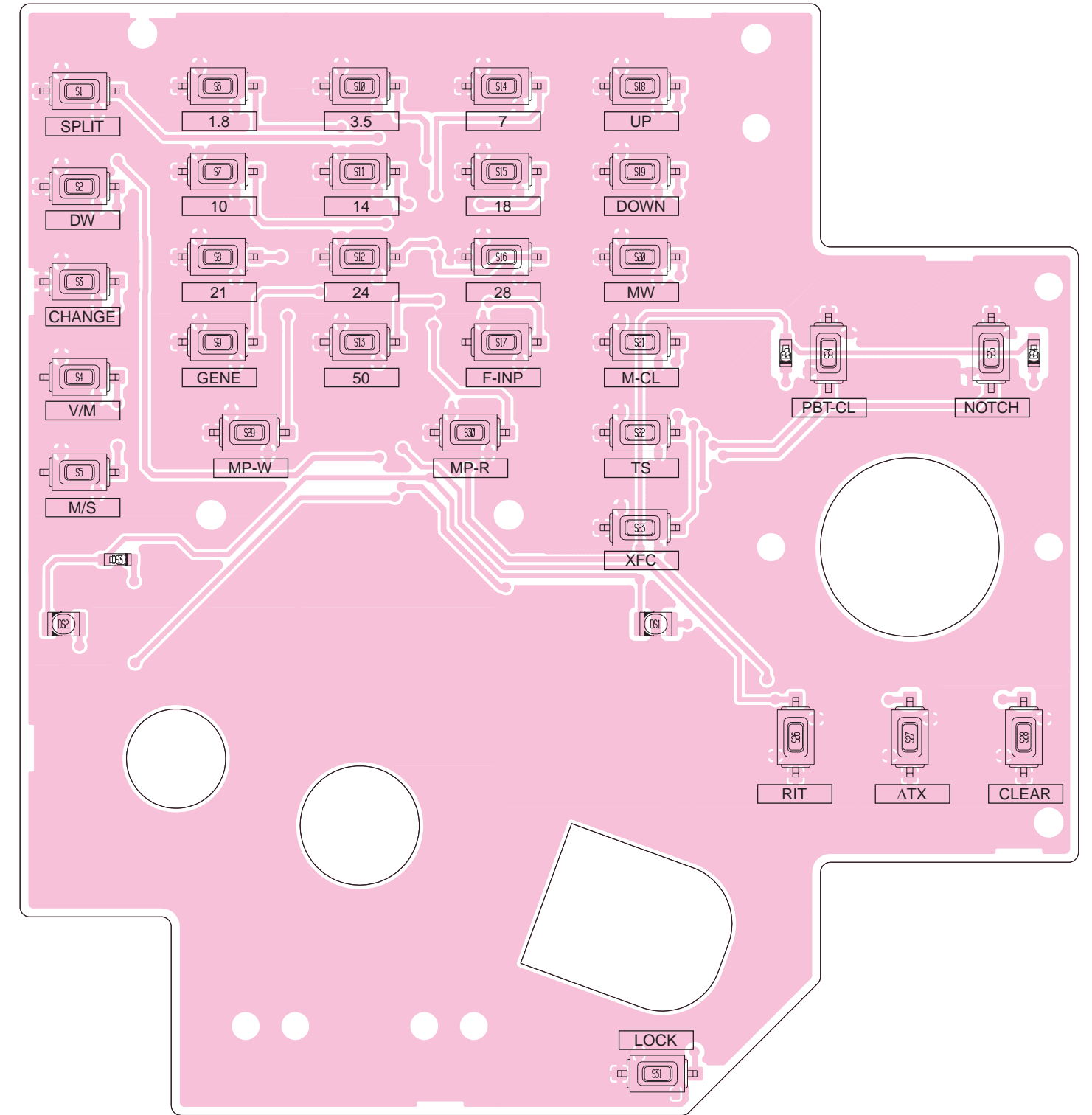

• TEN-KEY BOARD (BOTTOM VIEW)

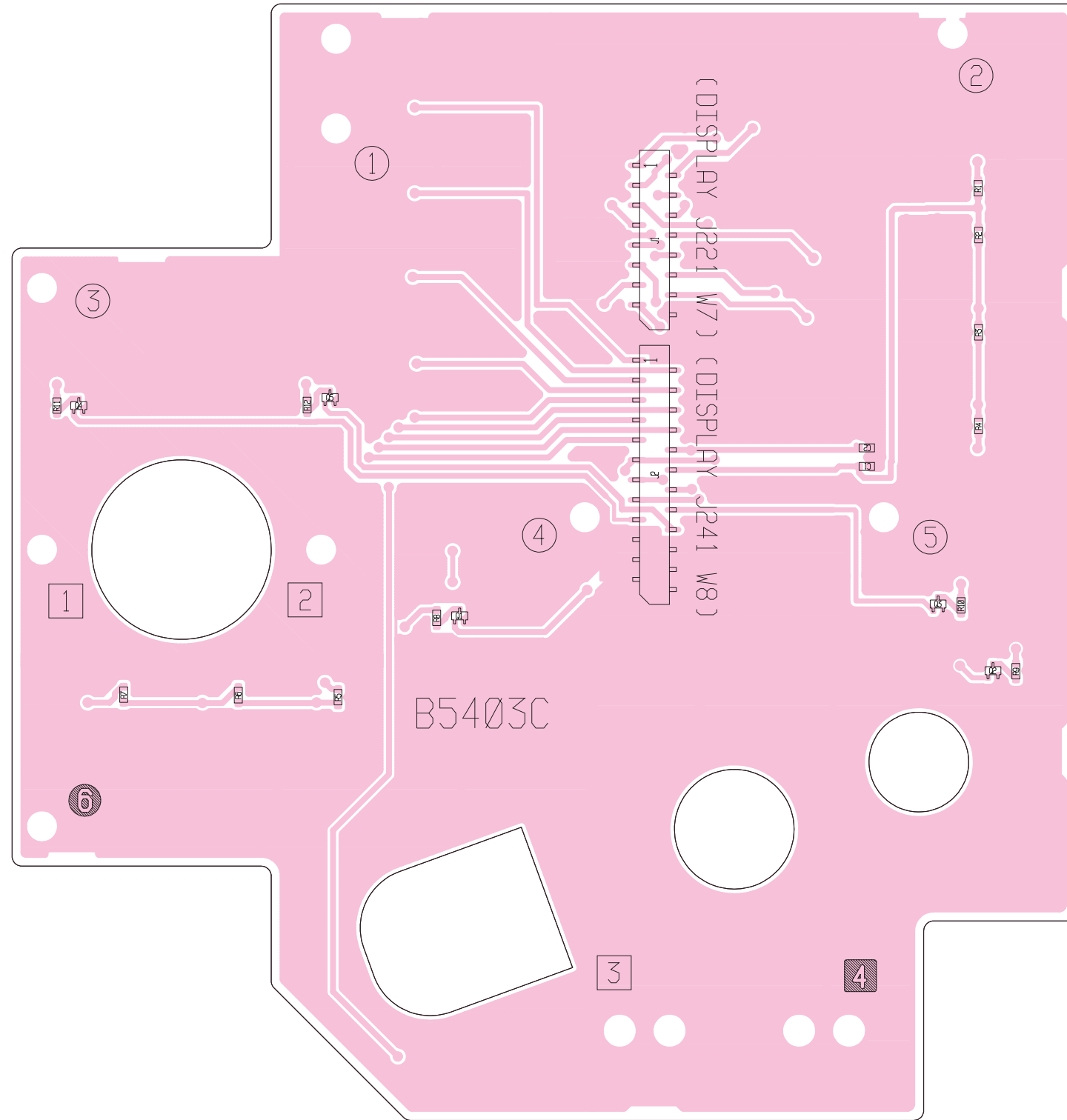

J1

1	SPLK	1K	2
	3K	7K	
	10K	14K	
	18K	21K	
	24K	28K	
	50K	GENK	
	FINK	MPWK	
15	MPRK	GND	16

to DISPLAY board J221

J2

1	MUPK	MDNK	2
	MWK	MCLK	
	TSK	XFCK	
	LOCK	PBTK	
	NOTK	KI4	
	5VF	KI3	
	LDV	LOCD	
	TXD	RXD	
	NOTD	PBTD	
	GND	GND	
	GND	GND	
23	GND	GND	24

to DISPLAY board J241

to DISPLAY board J201

2	GND	16
	KI1	
	SSBK	
	AMK	
	EXTK	
	F1K	
	F3K	
	F5K	
1	GND	15
	5VF	
	KI2	
	CWK	
	FILK	
	SPEK	
	F2K	
	F4K	

• MODE BOARD (BOTTOM VIEW)

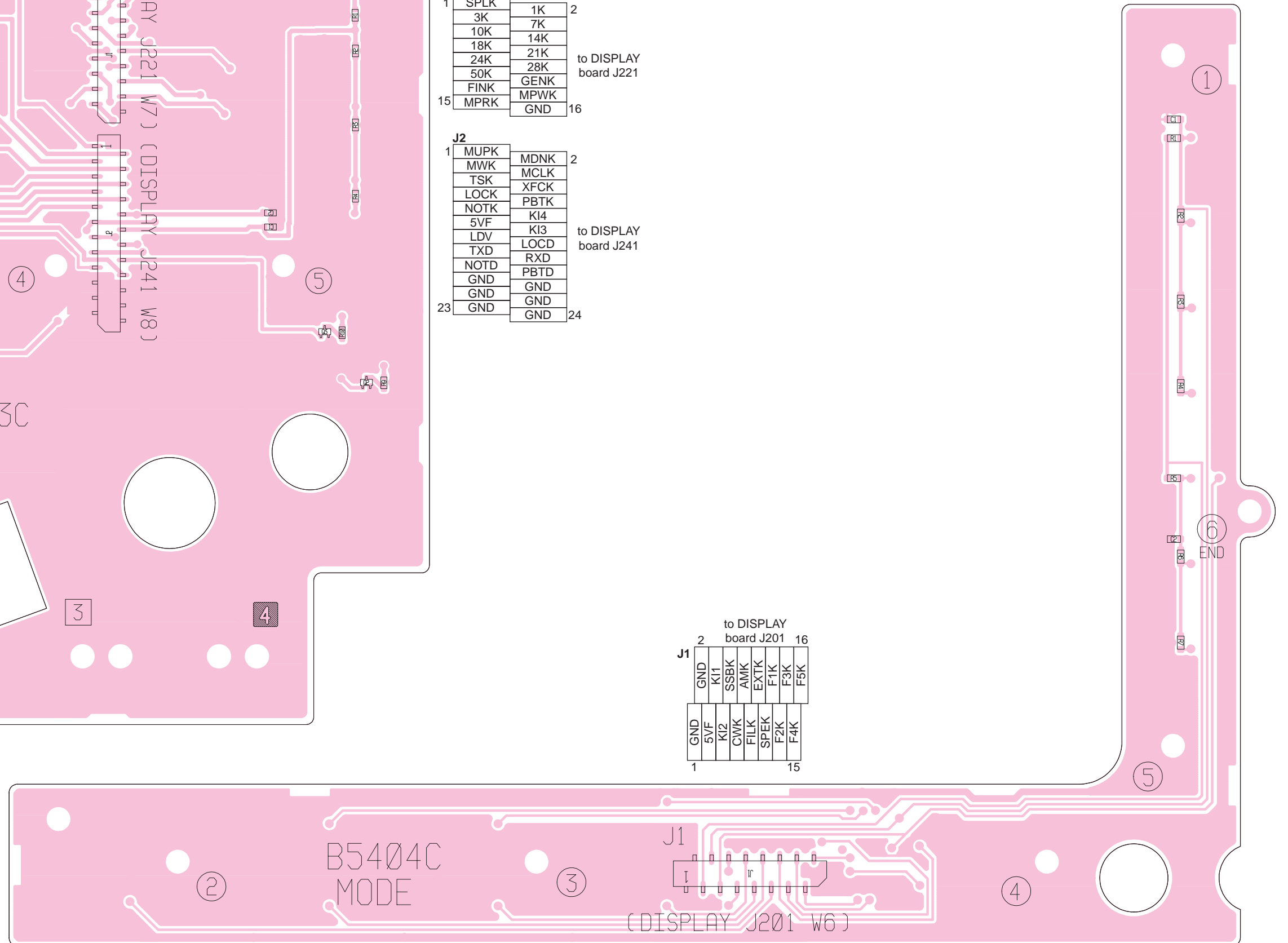

8-4 RF-A UNIT (TOP VIEW)

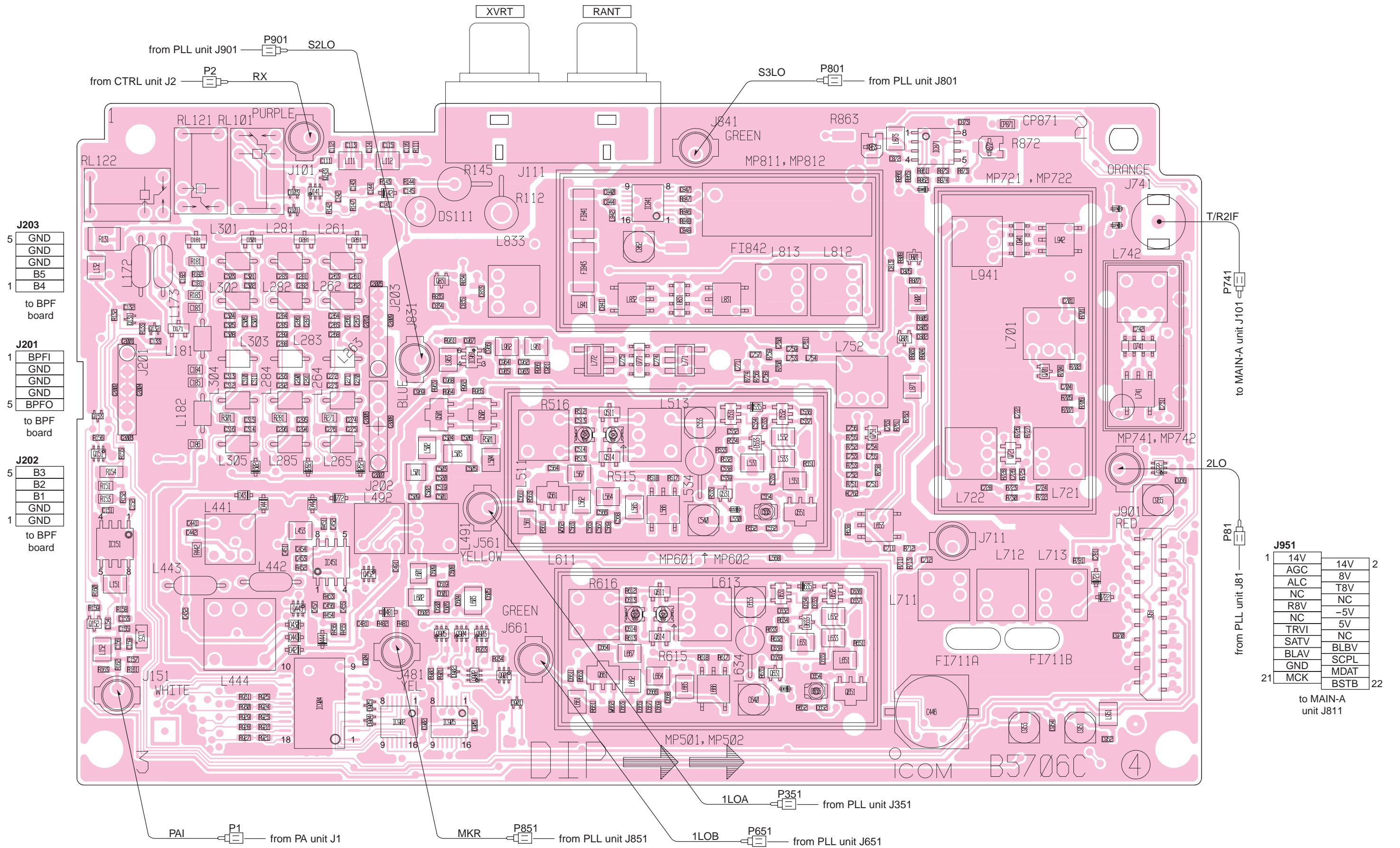

• RF-A UNIT (BOTTOM VIEW)

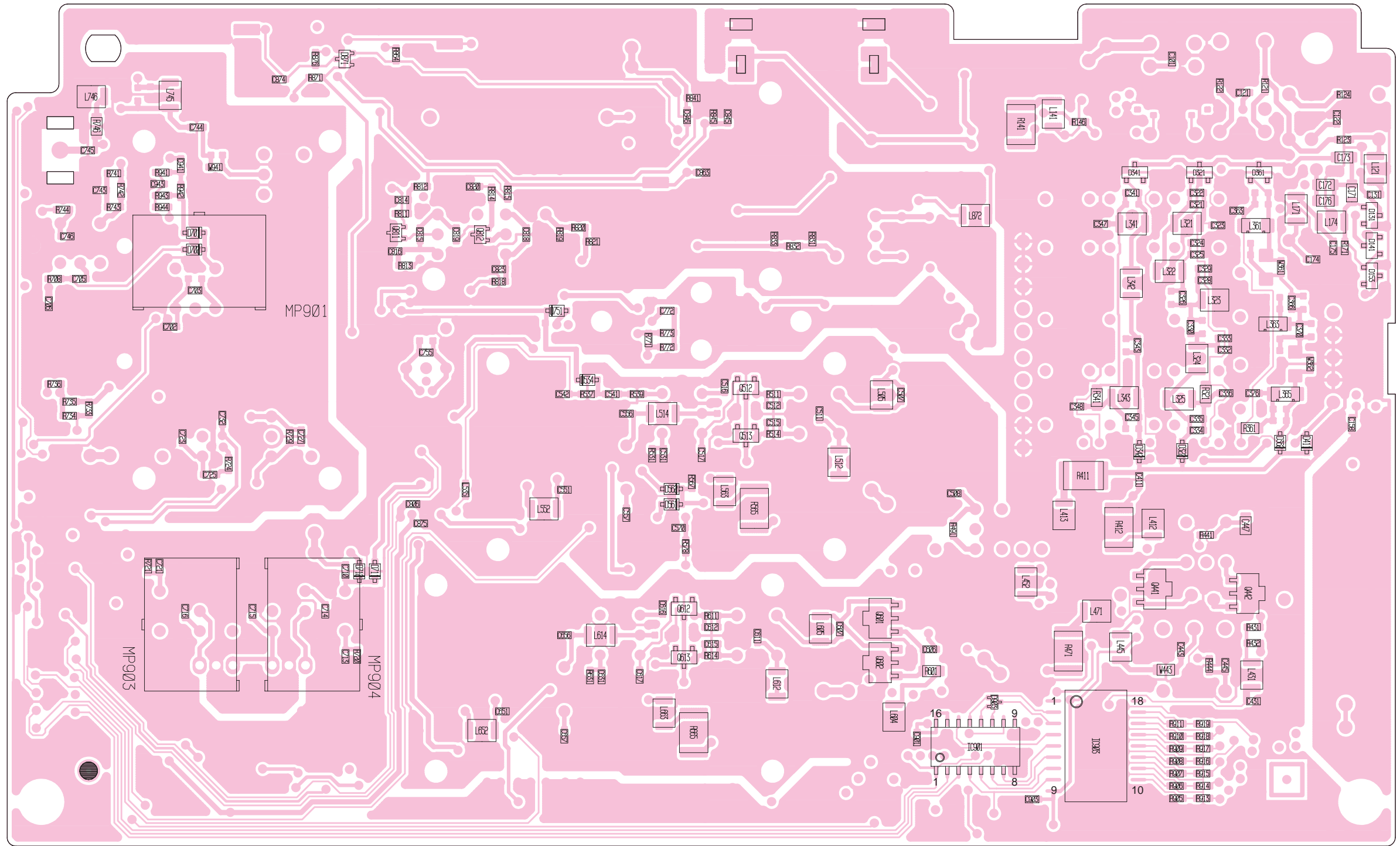

8-5 PLL UNIT (TOP VIEW)

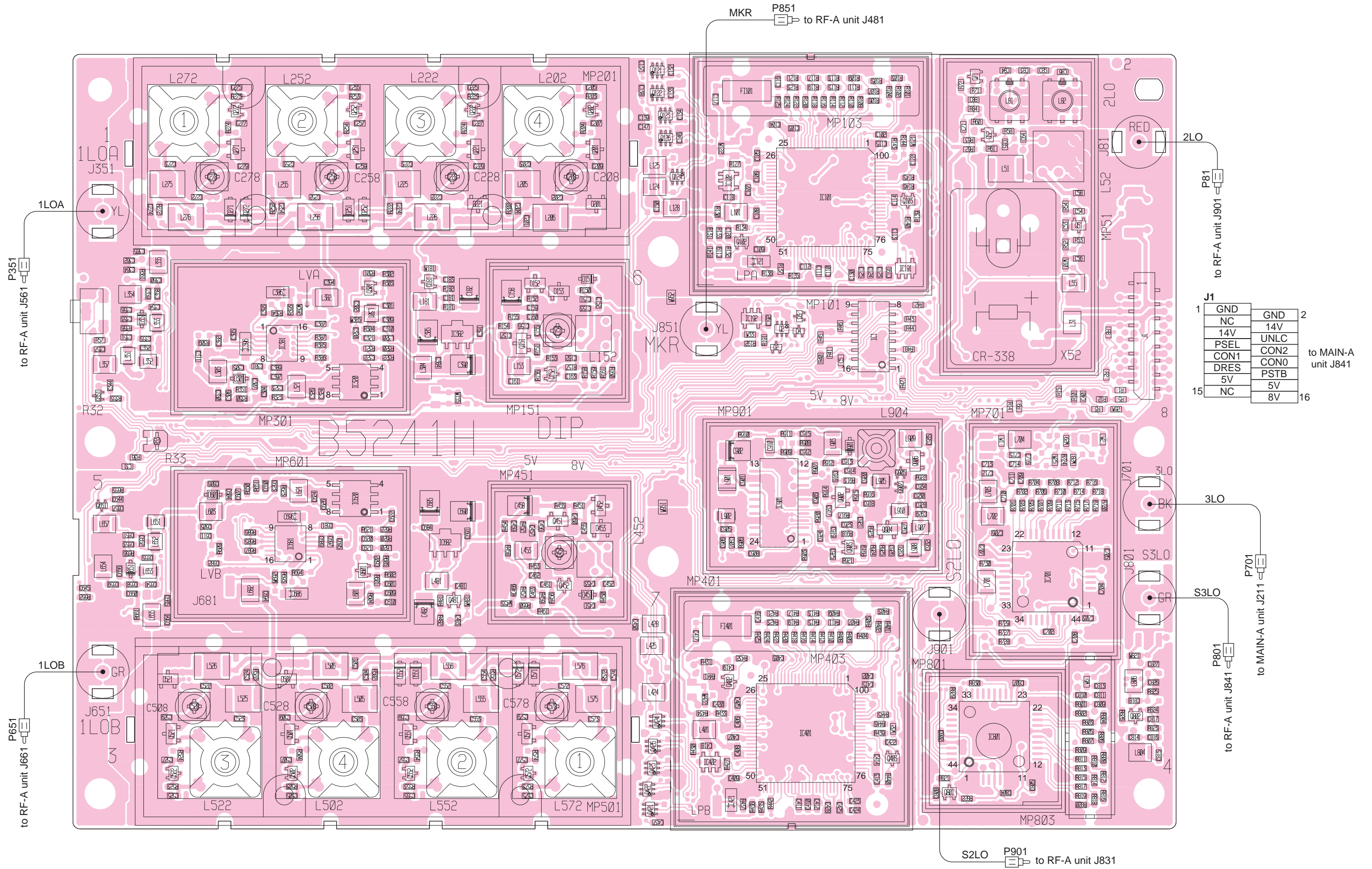

• PLL UNIT (BOTTOM VIEW)

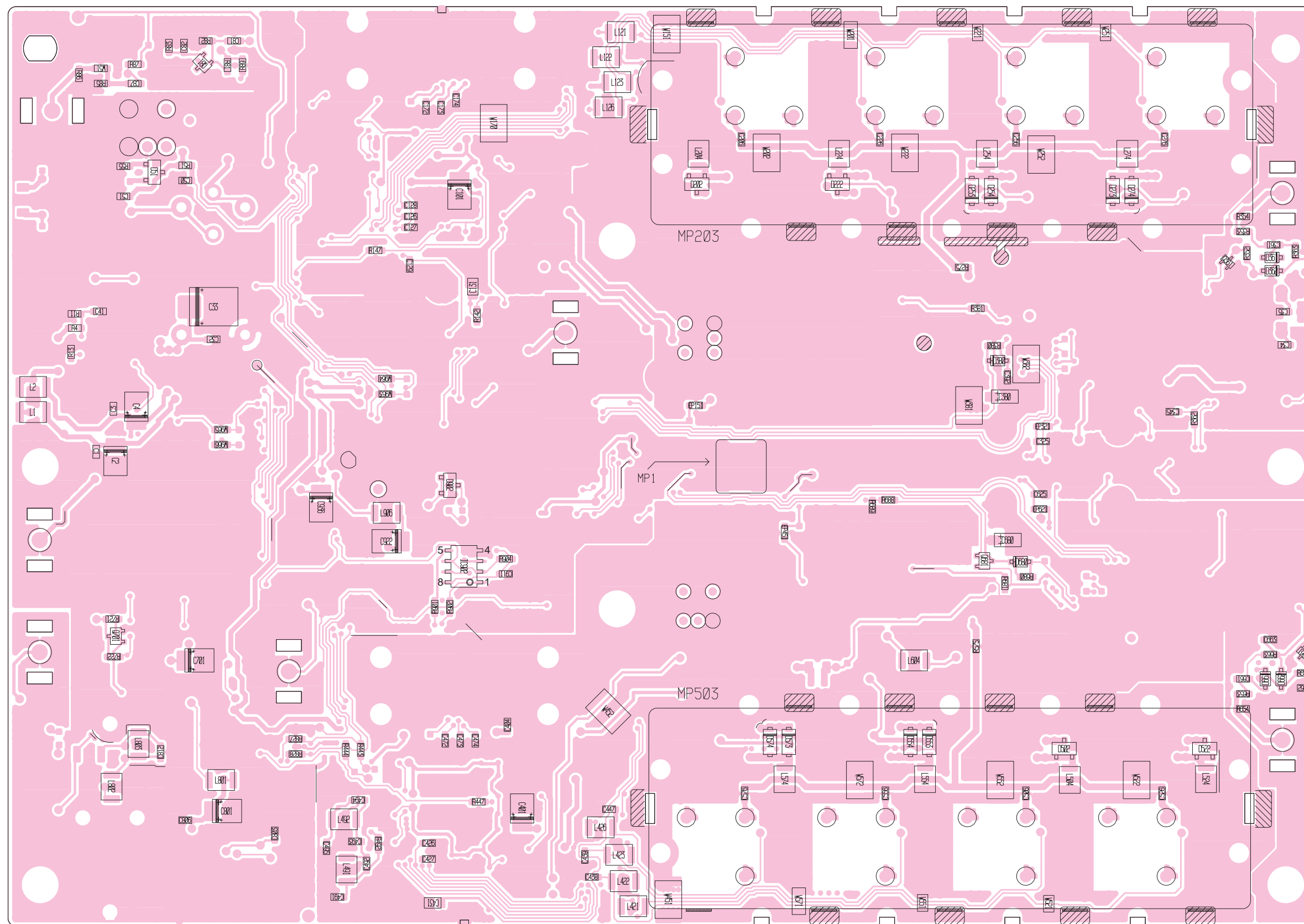

⊗ Soldering point

• MAIN-A UNIT (BOTTOM VIEW)

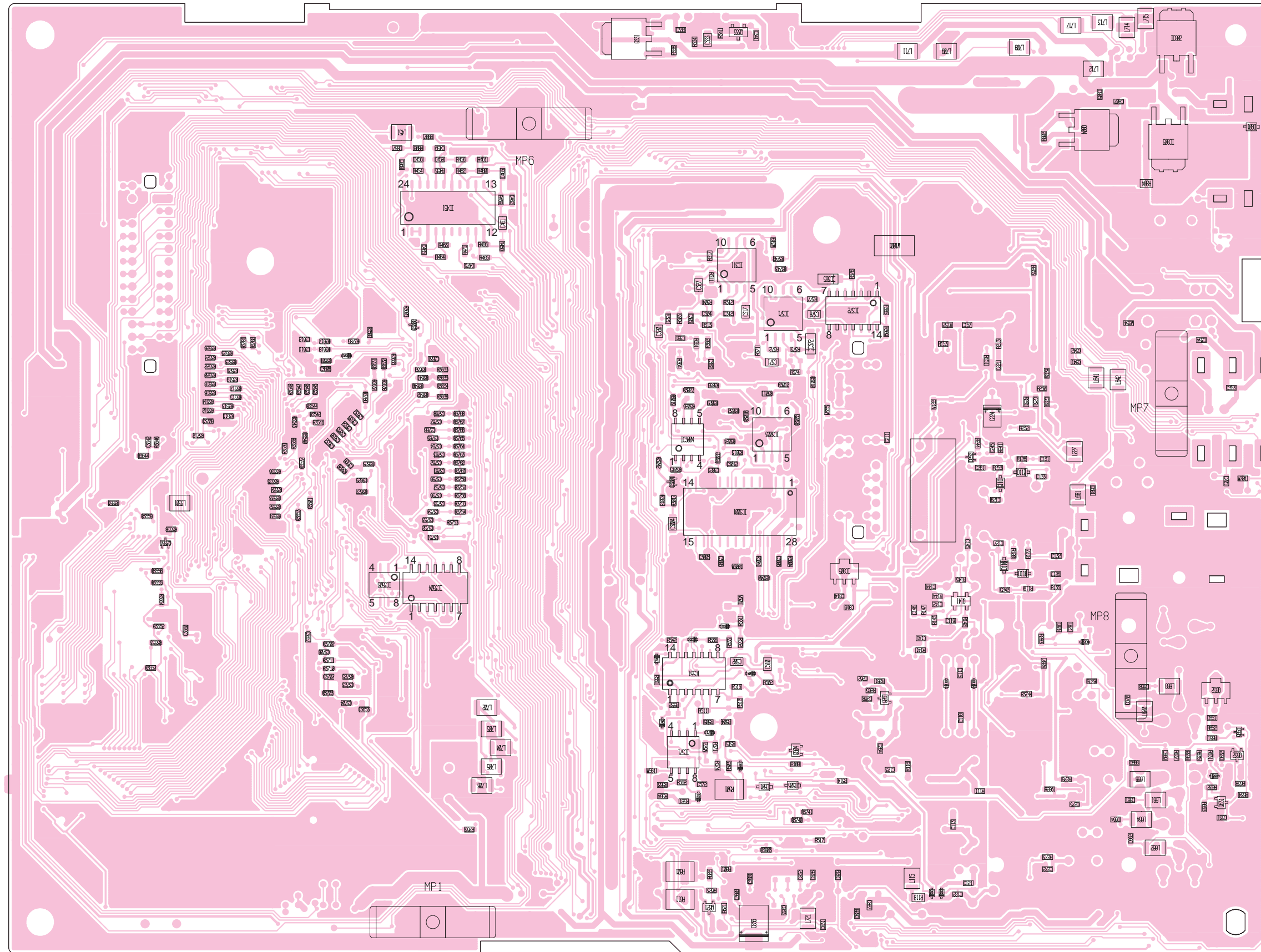

• MEMORY BOARD (BOTTOM VIEW)

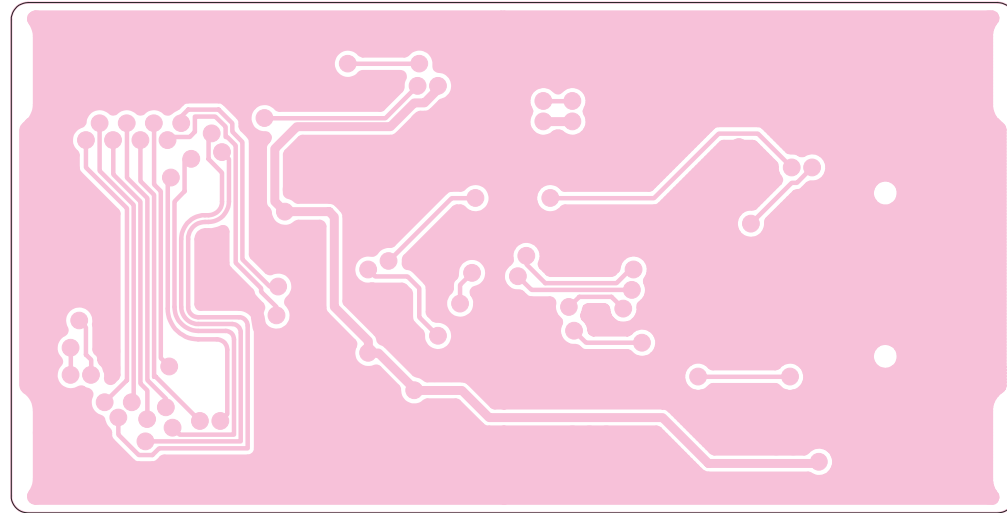

• DSP-A BOARD (BOTTOM VIEW)

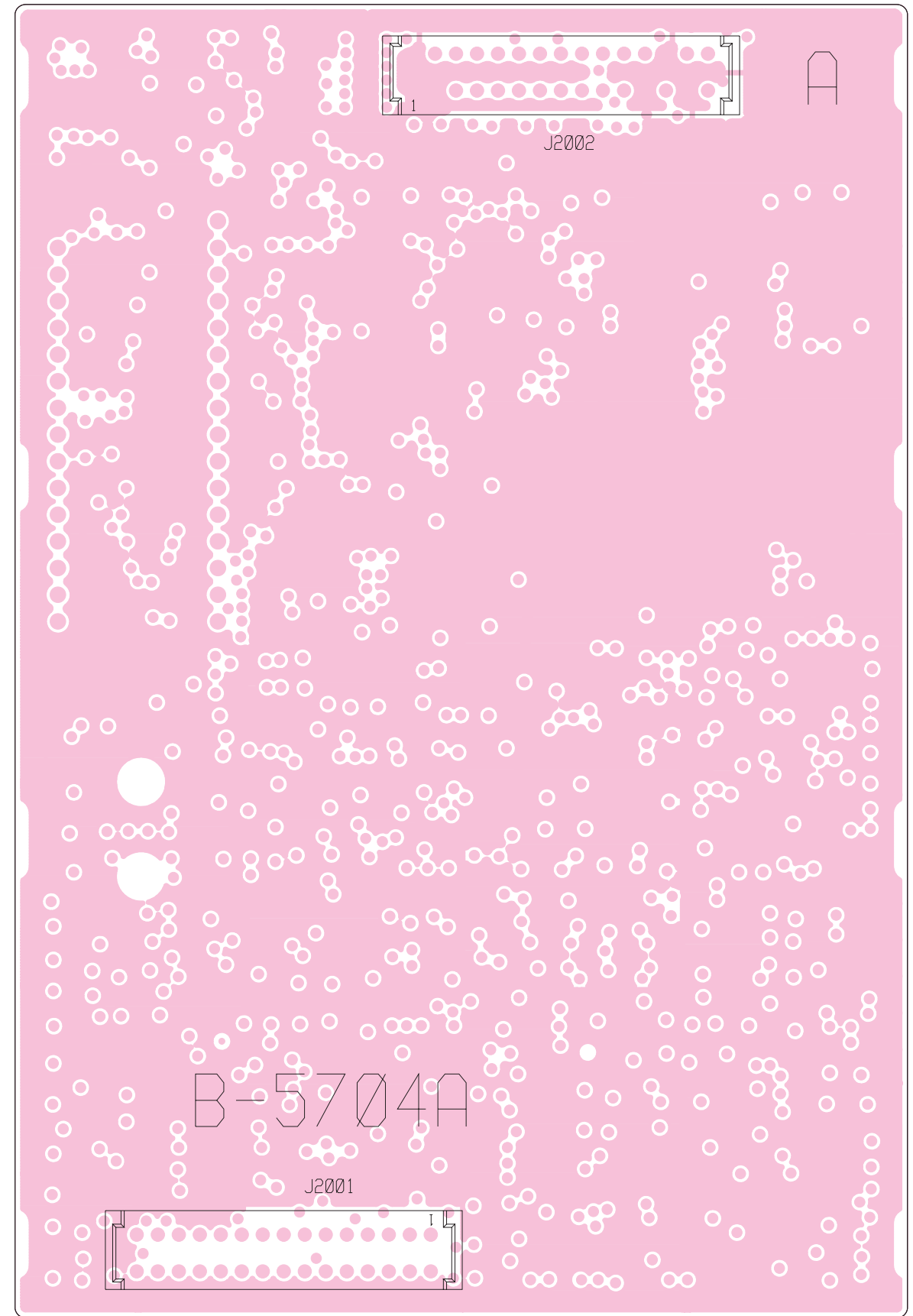

• BPF BOARD (BOTTOM VIEW)

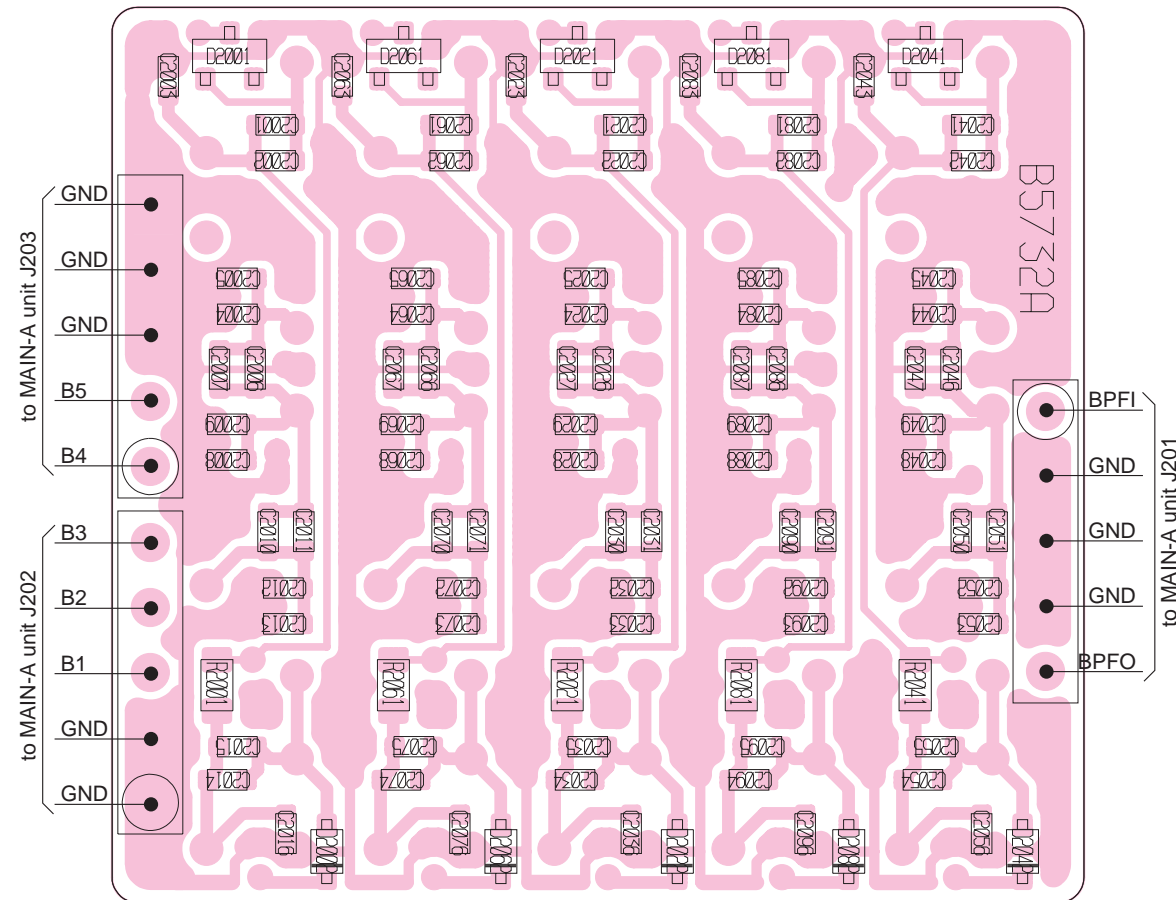

29	GND	1
8V	FMTL	GND
8V	GND	-5V
-5V	GND	-8V
-8V	GND	-8V
GND	DRAF	AGC DTAF
GND	DRAF	GND
GND	DMAF	GND
GND	D5VA	GND
GND	D5VA	GND
GND	D5VA	DTIF DRIF
DTIF	DRIF	GND
GND	GND	2
30		

to MAIN-A unit J201

2	GND	29
GND	DSKY	MSL1
RTDT	MSL1	TXS
CTFL	AMS	DSFR
MDAT	DSRS	DSFW
ACKS	ACKS	MCK
CALS	CALS	NC
FMNS	FMNS	NC
MODS	MODS	DSDR
DPGI	DPGI	NSQO
GND	NSQO	M5V_d
GND	M5V_d	GND
GND	3R3V_d	AGRS
AGRS	3R3V_d	30
1		

to MAIN-A unit J202

• PA UNIT (BOTTOM VIEW)

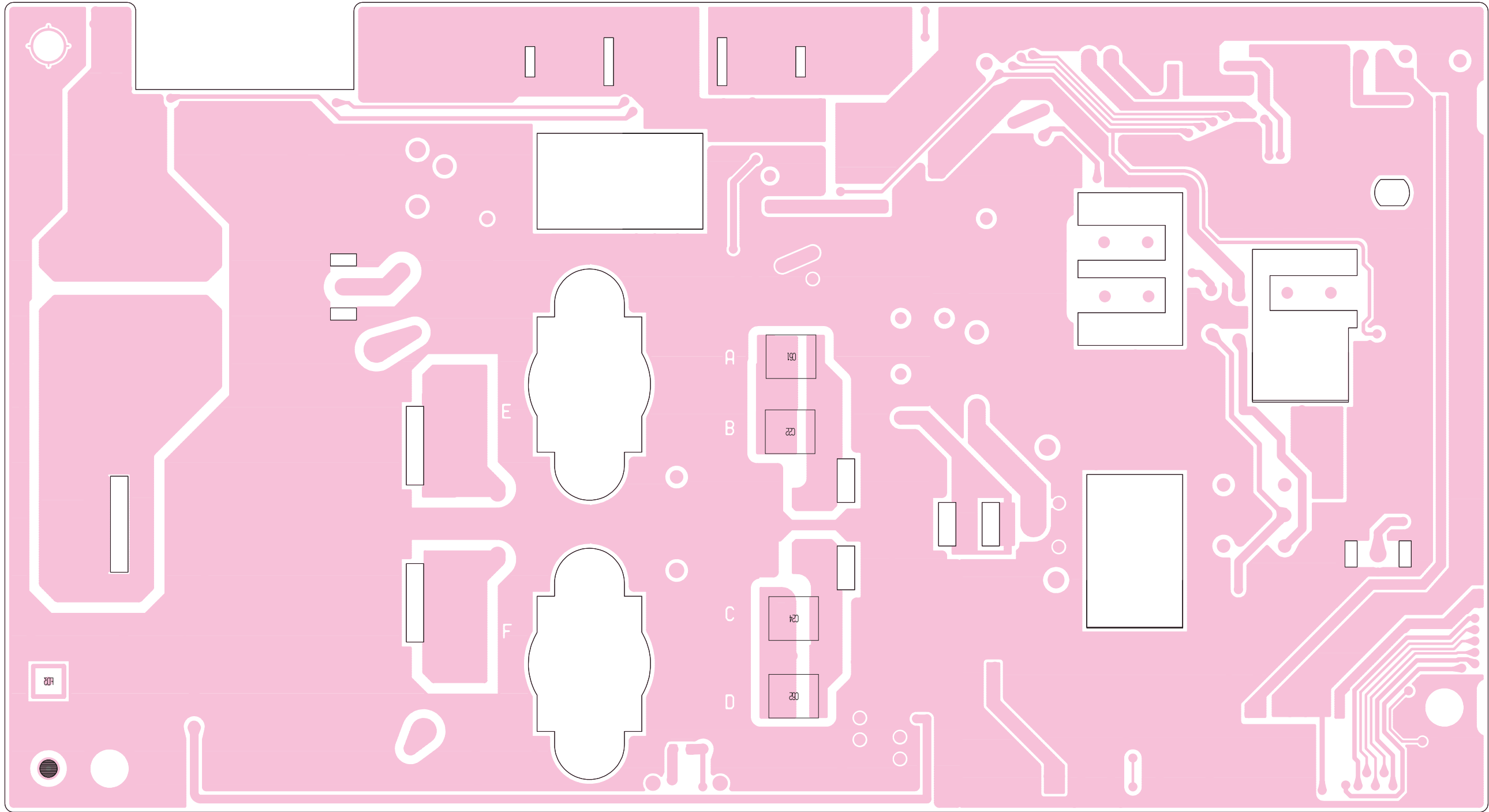

8-9 FILTER UNIT (TOP VIEW)

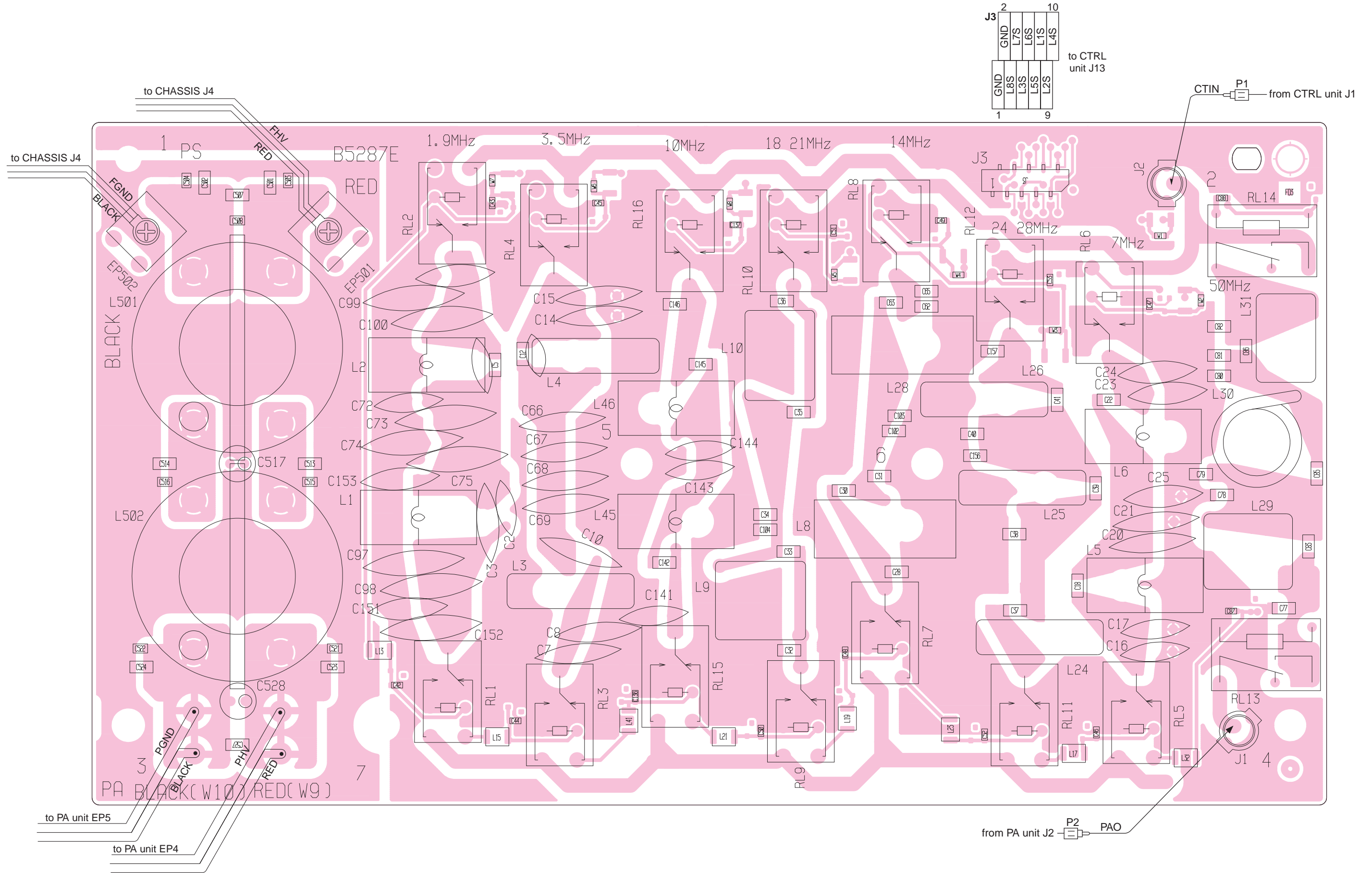

• FILTER UNIT (BOTTOM VIEW)

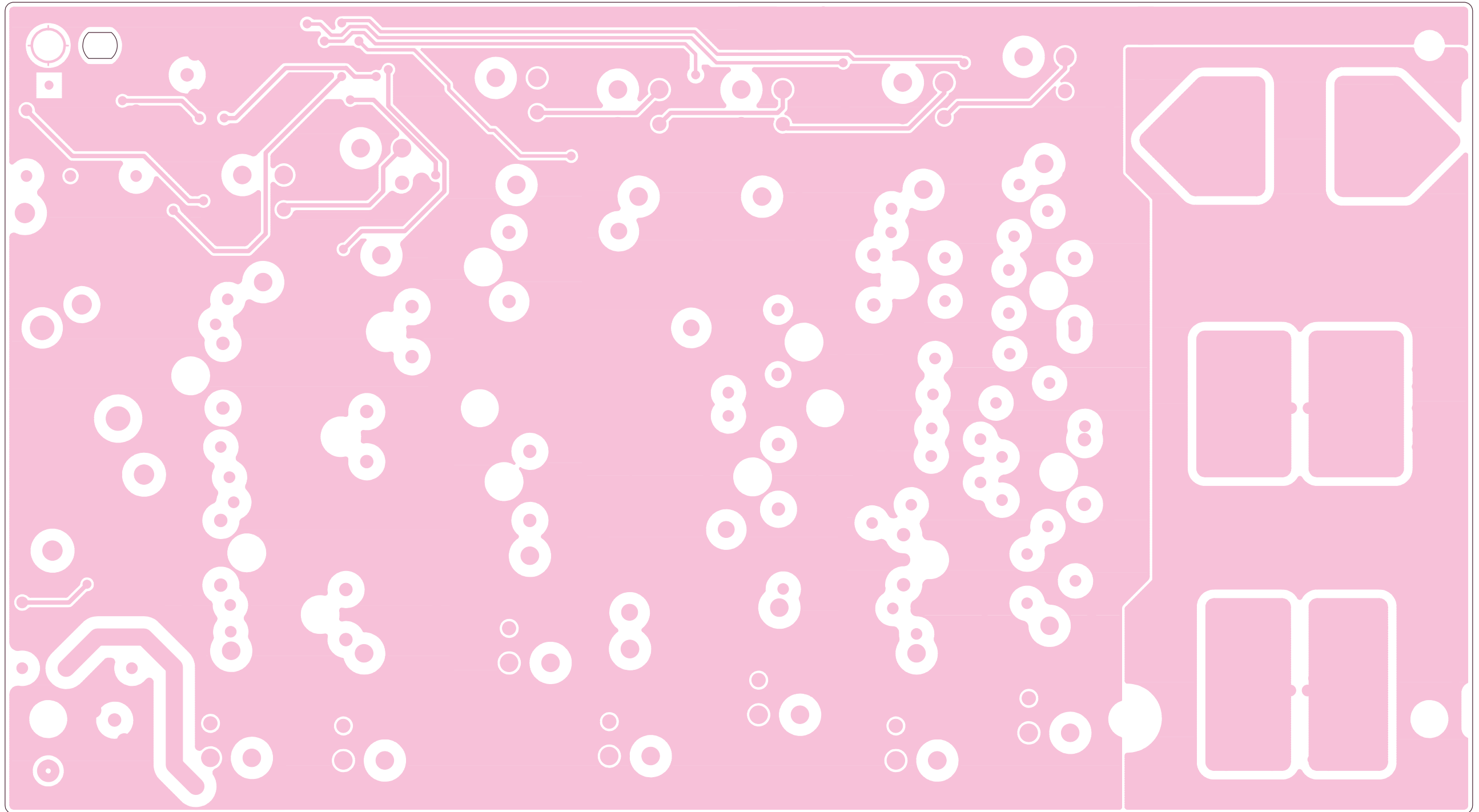

8-10 TUNER BOARD (TOP VIEW)

21	to CTRL unit J8										1
J5	GND	7M	14M	24M	GND	14V	CO3	CO1	CI3	CI1	GND
22	GND	3.5M	10M	18M	VHF	NC	14V	CO2	NVHF	CI2	GND
											2

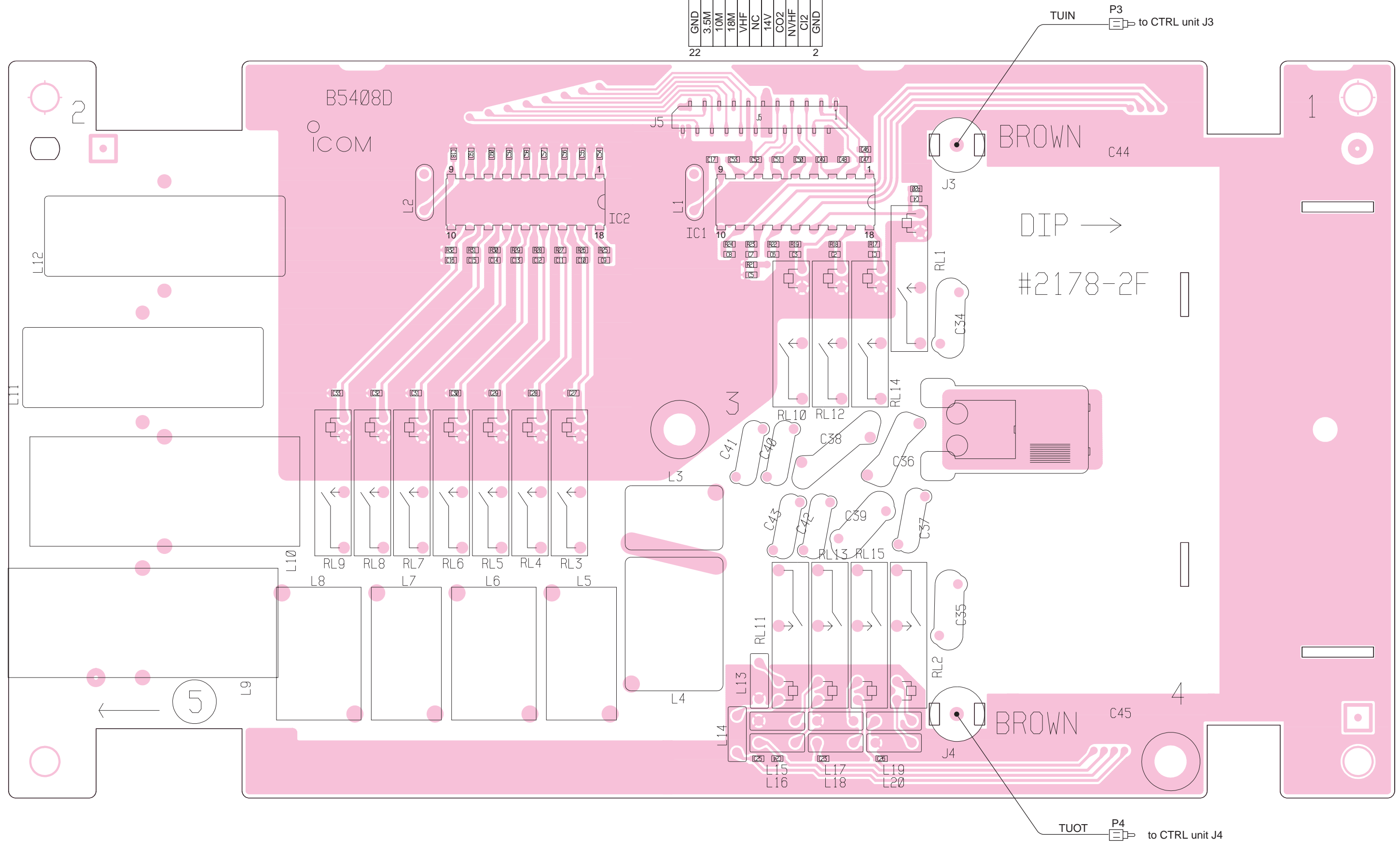

• TUNER BOARD (BOTTOM VIEW)

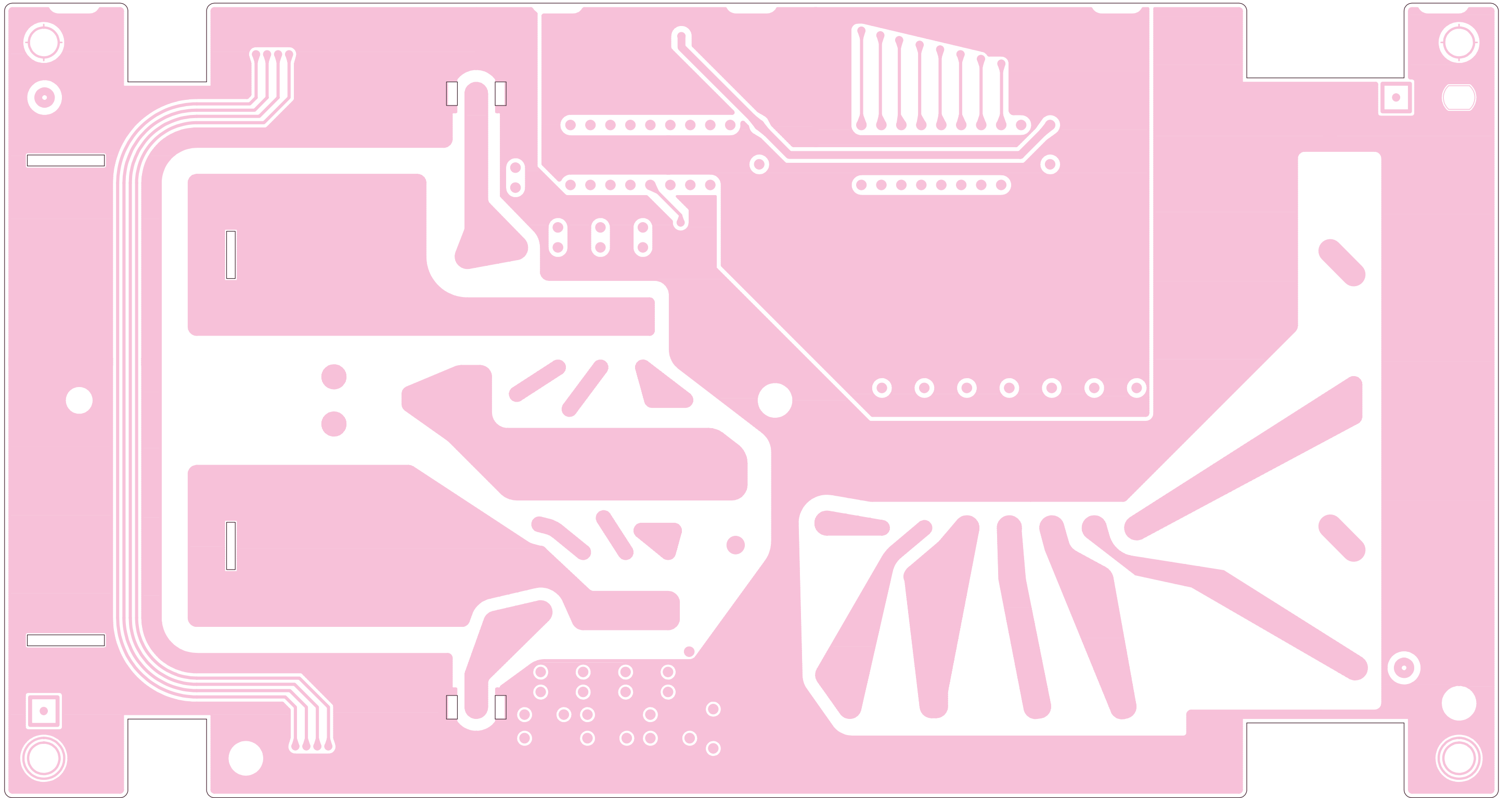

8-11 CTRL UNIT (TOP VIEW)

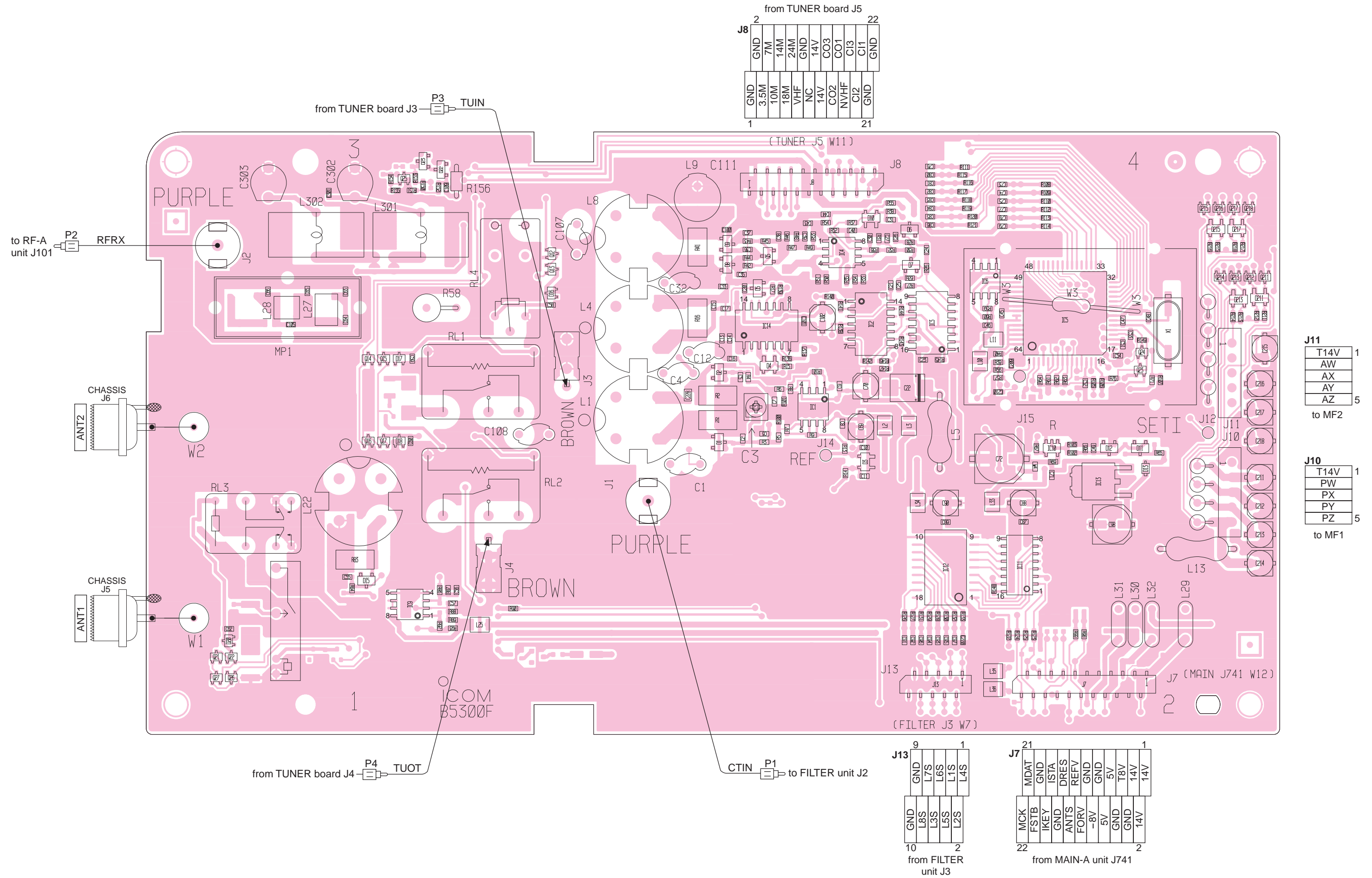

from TUNER board J5

2	GND	7M	14M	18M	VHF	NC	14V	CO3	CO1	CO13	C11	GND
1	GND	3.5M	10M	24M	VHF	NC	14V	CO2	NVHF	C12	GND	21

J11

1	T14V
	AW
	AX
	AY
5	AZ

to MF2

J10

1	T14V
	PW
	PX
	PY
5	PZ

to MF1

J13

9	GND	1
	L7S	
	L6S	
	L1S	
	L4S	
10	GND	2

from FILTER unit J3

J7

21	MDAT	1
	GND	
	ISTA	
	DRES	
	REFV	
	GND	
	5V	
	T8V	
	14V	
	14V	
22	MCK	2
	FSTB	
	IKEY	
	GND	
	ANTS	
	FORV	
	-8V	
	5V	
	GND	
	14V	

from MAIN-A unit J741

• CTRL UNIT (BOTTOM VIEW)

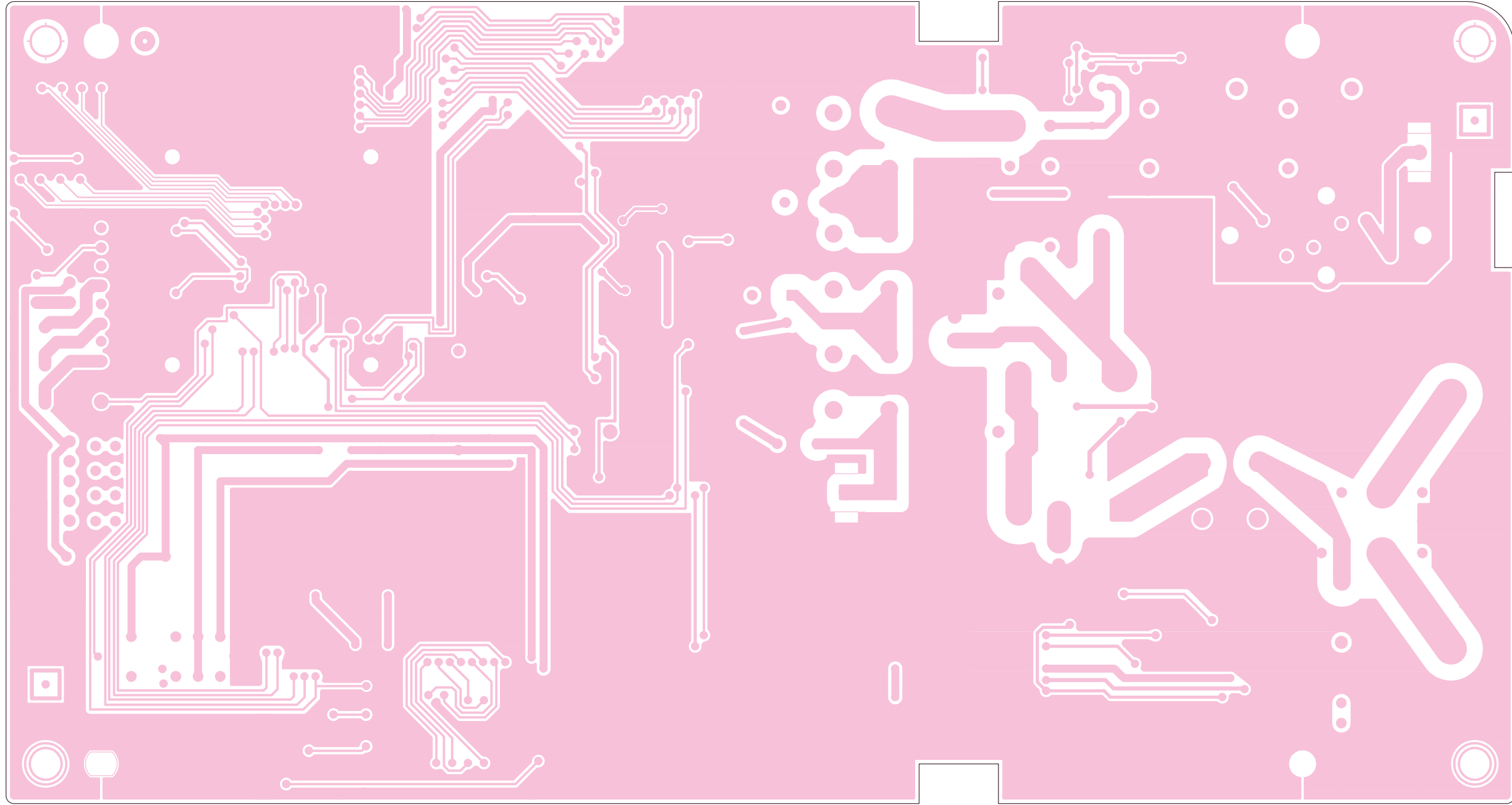

SECTION 9 BLOCK DIAGRAM

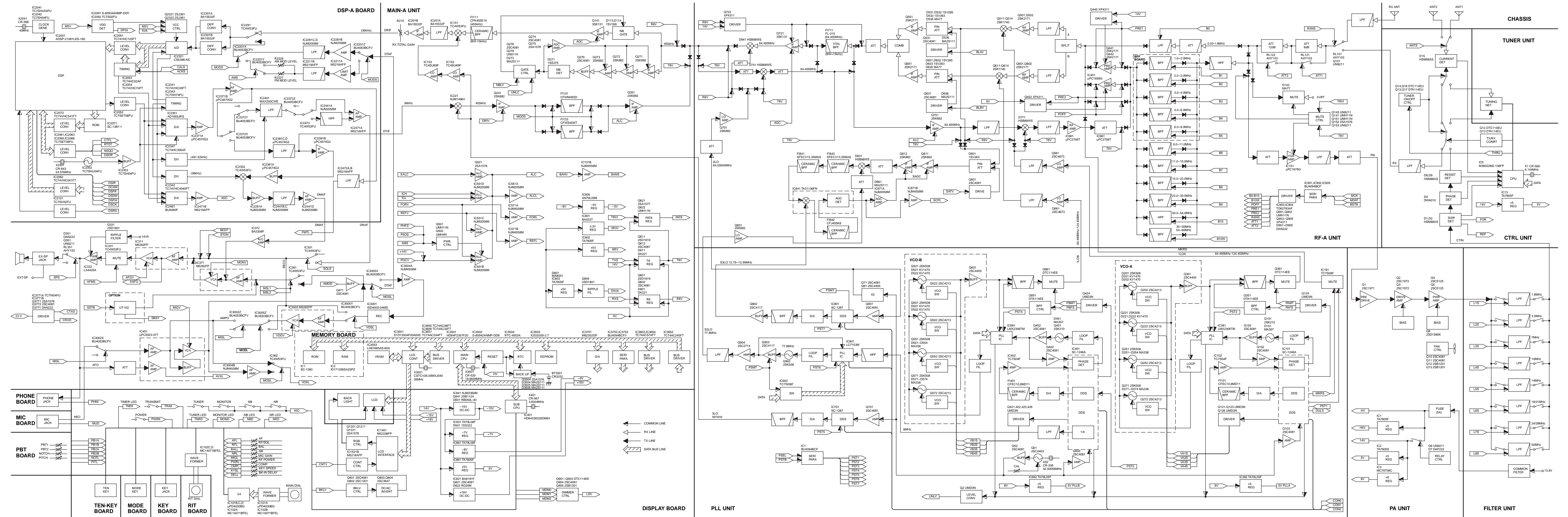

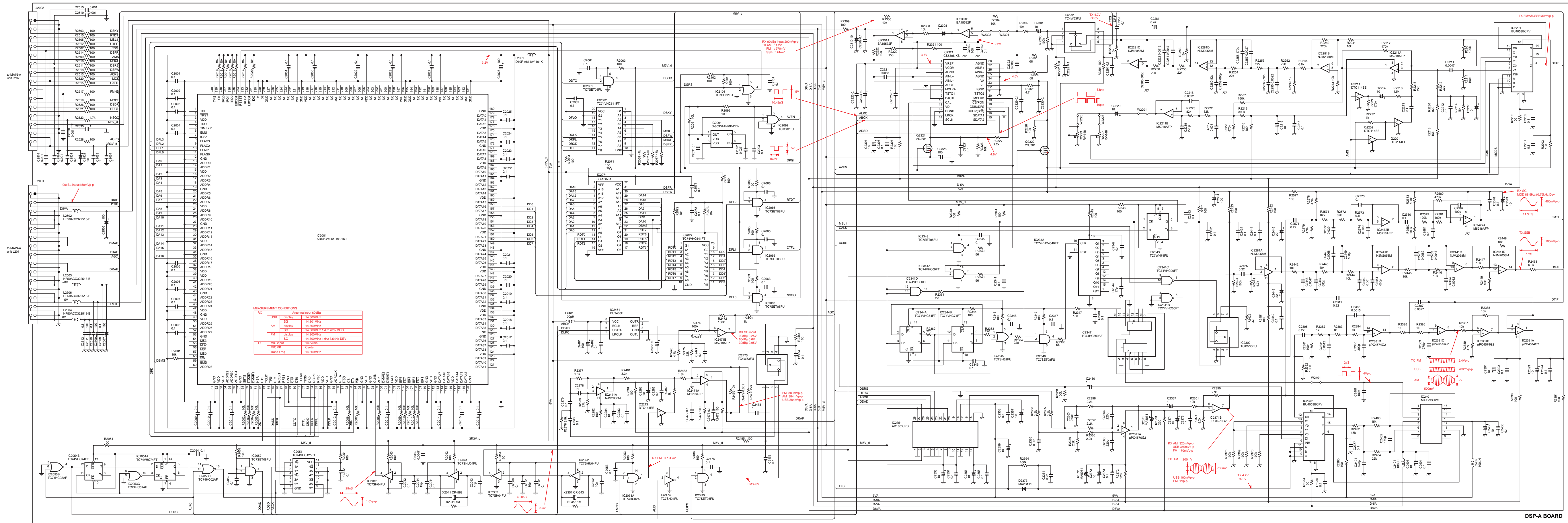

10-3 TUNER, MEMORY BOARDS AND CTRL UNIT

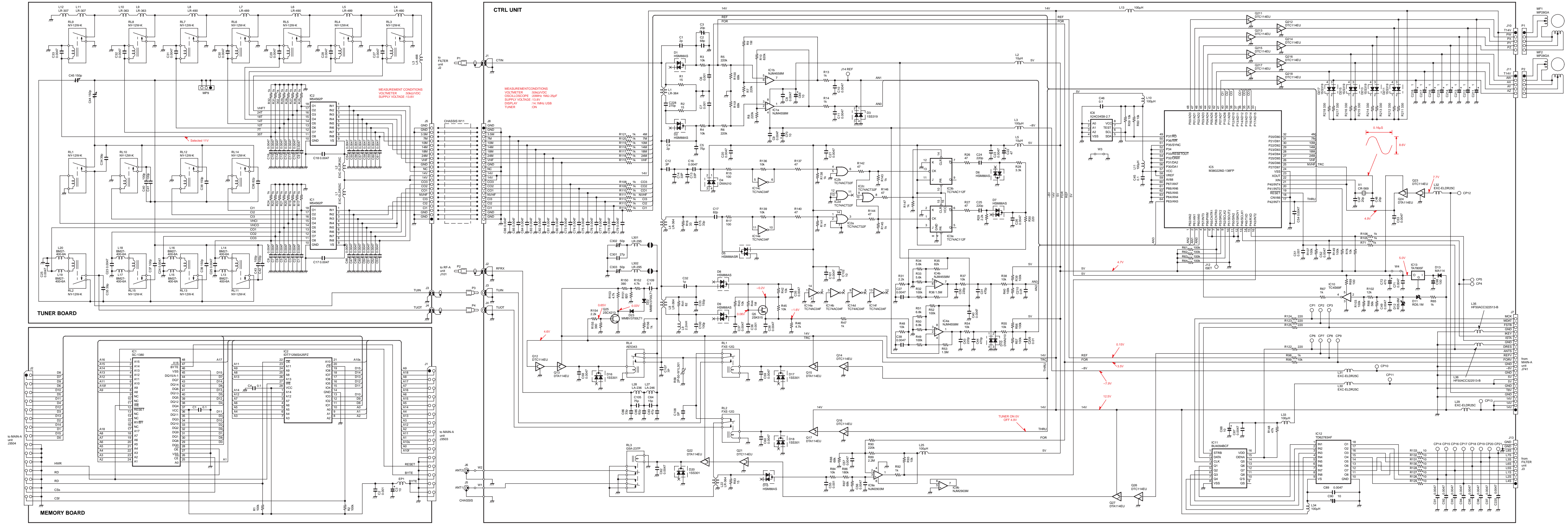

10-4 MAIN-A UNIT (1)

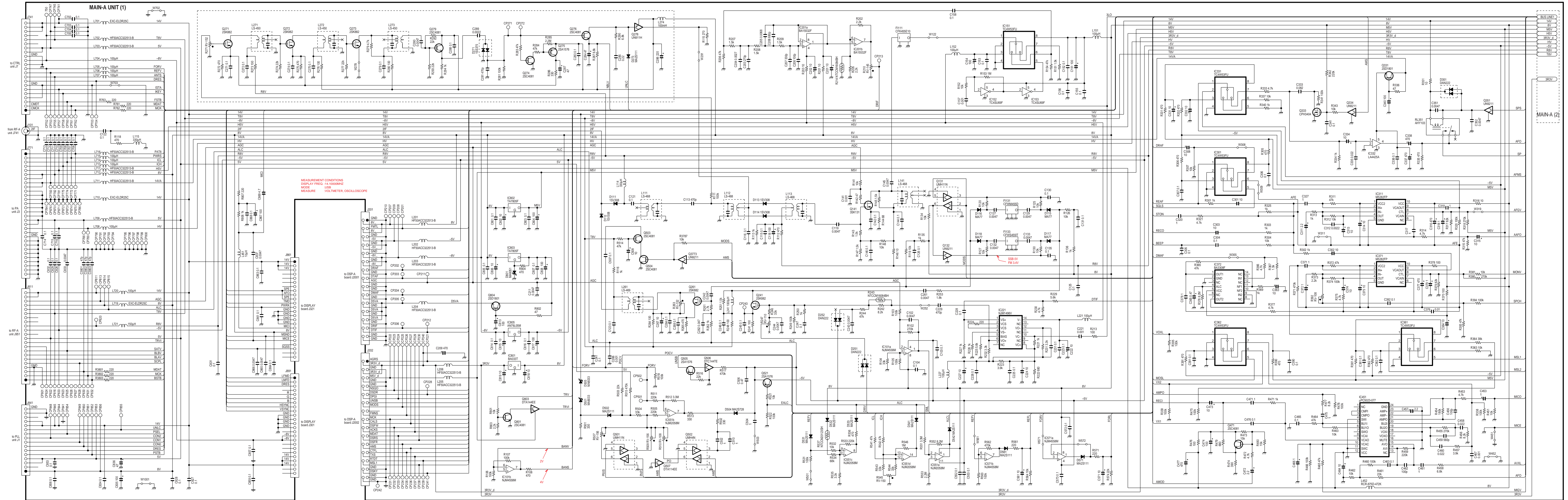

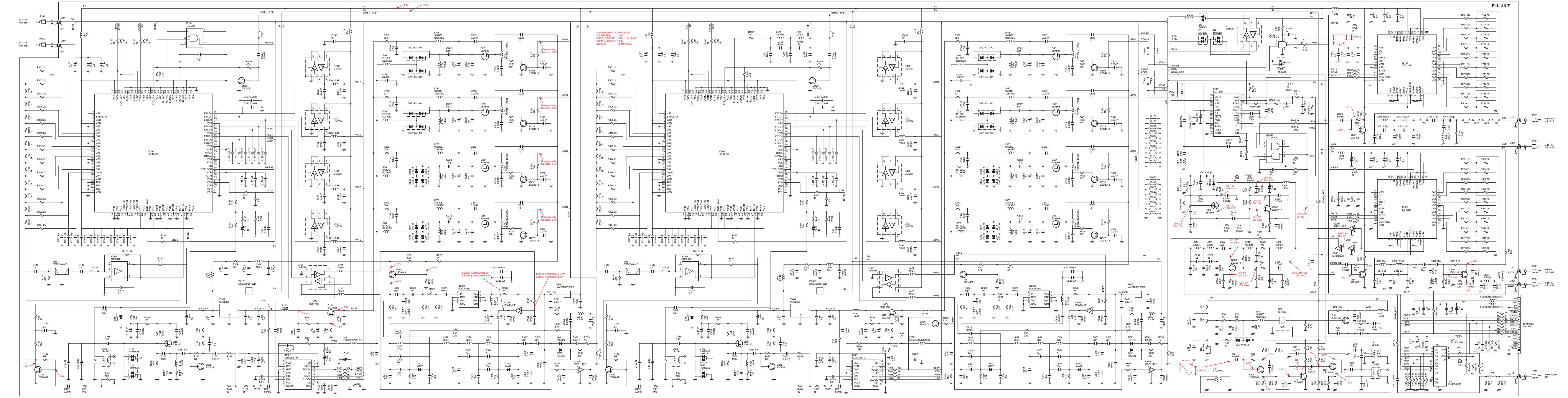

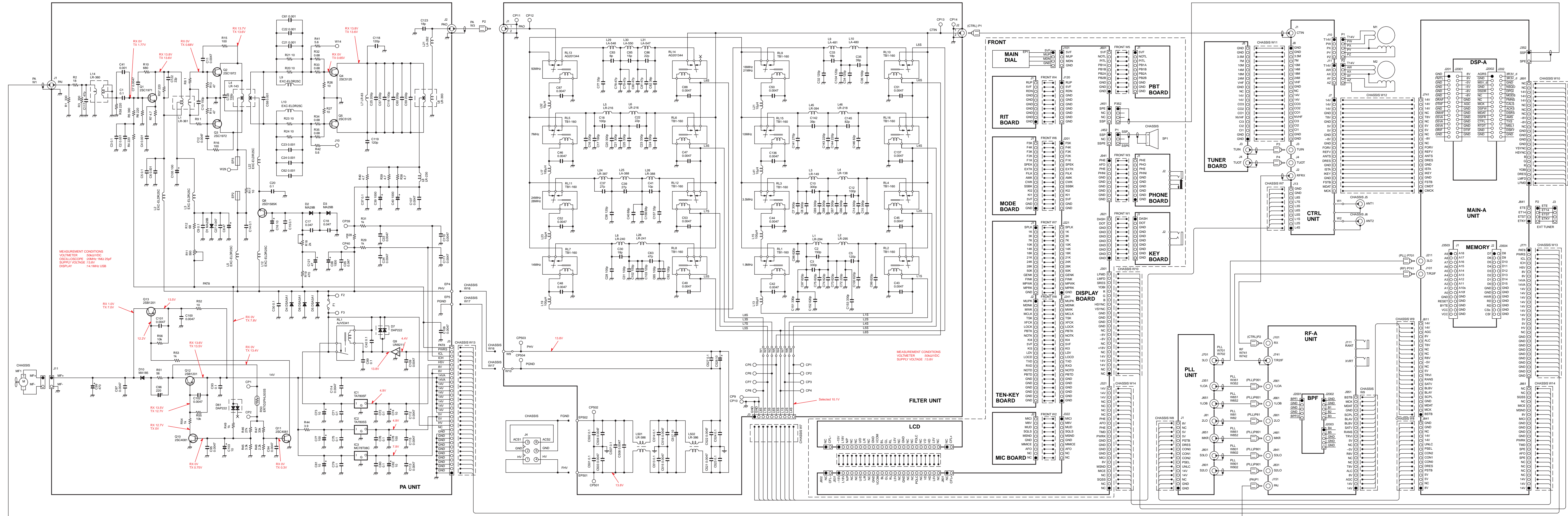

10-8 RF-A UNIT AND BPF BOARD

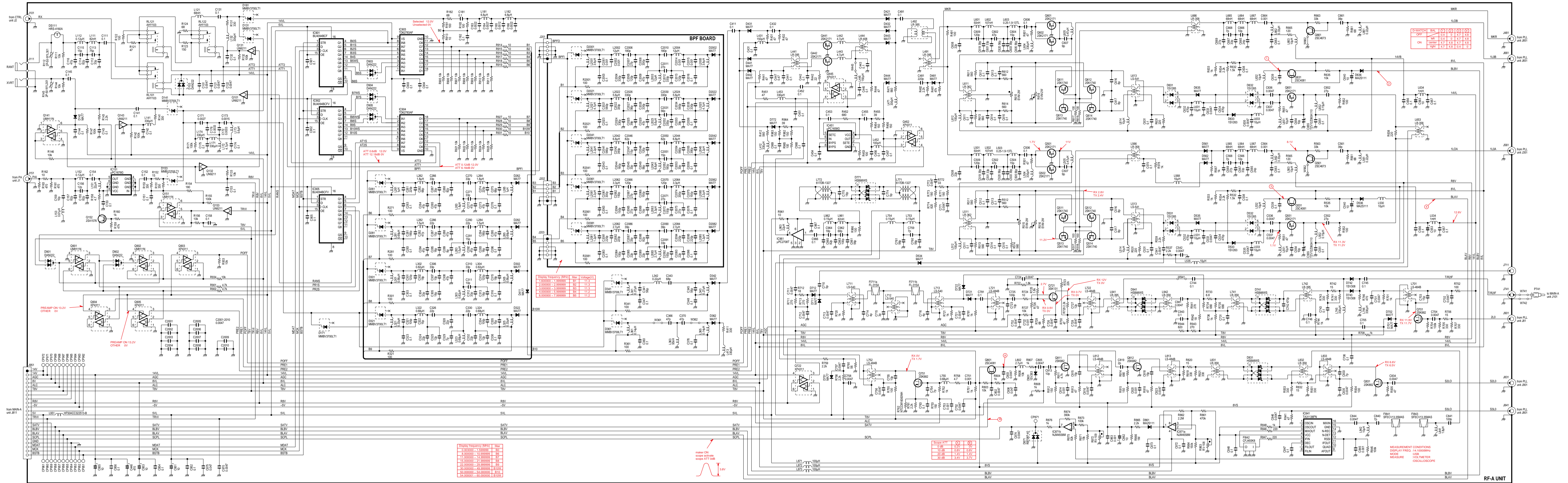

Icom Inc.

1-1-32, Kamiminami, Hirano-ku, Osaka 547-0003, Japan
Phone : 06 6793 5302
Fax : 06 6793 0013
URL : <http://www.icom.co.jp/world/index.html>

Icom America Inc.

<Corporate Headquarters>
2380 116th Avenue N.E., Bellevue, WA 98004, U.S.A.
Phone : (425) 454-8155 Fax : (425) 454-1509
URL : <http://www.icomamerica.com>
<Customer Service>
Phone : (425) 454-7619

Icom Canada

Glenwood Centre #150-6165
Highway 17 Delta, B.C., V4K 5B8, Canada
Phone : (604) 952-4266 Fax : (604) 952-0090
URL : <http://www.icomcanada.com>

Icom (Australia) Pty. Ltd.

A.B.N. 88 006 092 575
290-294 Albert Street, Brunswick, Victoria, 3056, Australia
Phone : 03 9387 0666 Fax : 03 9387 0022
URL : <http://www.icom.net.au>

Icom New Zealand

146A Harris Road, East Tamaki,
Auckland, New Zealand
Phone : 09 274 4062 Fax : 09 274 4708
URL : <http://www.icom.co.nz>

Icom (Europe) GmbH

Communication Equipment
Himmelgeister Str. 100, D-40225 Düsseldorf, Germany
Phone : 0211 346047 Fax : 0211 333639
URL : <http://www.icomeurope.com>

Icom Spain S.L.

Crta. de Gracia a Manresa Km. 14,750
08190 Sant Cugat del Valles Barcelona, SPAIN
Phone : (93) 590 26 70 Fax : (93) 589 04 46
URL : <http://www.icomspain.com>

Icom (UK) Ltd.

Unit 9, Sea St., Herne Bay, Kent, CT6 8LD, U.K.
Phone : 01227 741741 Fax : 01227 741742
URL : <http://www.icomuk.co.uk>

Icom France S.a

Zac de la Plaine, Rue Brindejonc des Moulinais
BP 5804, 31505 Toulouse Cedex, France
Phone : 561 36 03 03 Fax : 561 36 03 00
URL : <http://www.icom-france.com>

Asia Icom Inc.

6F No. 68, Sec. 1 Cheng-Teh Road, Taipei, Taiwan, R.O.C.
Phone : (02) 2559 1899 Fax : (02) 2559 1874

Count on us!

Icom Inc.

1-1-32, Kamiminami, Hirano-ku Osaka 547-0003, Japan

S-13807HZ-C1
© 2001 Icom Inc.