

HF/50MHz TRANSCEIVER TS-990S

KENWOOD



# TS-990S

HF/50MHz TRANSCEIVER

For Real DXers

KENWOOD

200W P.A.M.P. ANT1  
JAN/01/13 09:00 00:00 0.000  
D.VOX OFF OFF RXEQ OFF TXEQ OFF  
LSB RX TX VFO 7.100.000 BAND 1 USB RX TX VFO 14.200.000 BAND 1  
MAIN CENTER MODE Bandscope SPAN 200kHz ATT: OFF  
7.000.000 7.200.000  
Grid/div 20kHz, 10dB  
Averaging 1  
MORE M/S CTR/FIX SPAN REF.LEV PAUSE MARKER  
ESC F1 F2 F3 F4 F5 F6 F7 SCP  
SEL SEL SEL SEL SEL  
VOX PROC FBK MONI  
MIC-VOX GAIN PROC IN-PROC OUT PWR-CAR KEY SPEED-DELAY CW PITCH-MONITOR  
4. 6. 2- 8. 2- 8. 2- 8. 2- 8. 2- 8. 2- 8.

Legend and Innovation



Actual size  
 W460 x H165 x D400 mm  
 Projections not included.

The ultimate DX and Contest experience is here. Kenwood's long-awaited flagship model is equipped with the latest technology that embodies an entirely new HF standard.

# TS-990S

## 1973 TS-900

The all-band SSB transceiver is making history for its state-of-the-art technology.



## 1982 TS-930

The HF transceiver is the world's first Ham Radio transceiver equipped with built-in automatic antenna tuner.



## 1985 TS-940

The HF transceiver offers the high dynamic range that won the struggle through Cycle 22.



## 1989 TS-950

The HF transceiver is the world's first digitalized unit that comes with built-in DSP.



Repeated innovation turns  
the tradition into a legend.



External Speaker  
**SP-990** **NEW**  
Input: 5 W

## 2013 TS-990

The TS-990S comes equipped with dual receivers for simultaneous dual reception on different bands. It also features narrow-band roofing filters in the main receiver in a full down-conversion configuration. The new TS-990S achieves the highest base-level reception performance of any radio in the TS series, through the careful selection of circuits and components for their high-performance and through an innovative triple DSP configuration. The Trio tone has evolved into the Kenwood tone. Also, thanks to the dual TFT display and superior panel layout, it achieves both comfortable visibility and operability. Our top-of-the-line transceiver is for all radio operators who love HF.



HF/50 MHz Transceiver

# TS-990S

NEW

Output: 200 W

## The TS-990S has the overwhelmingly highest quality receiver among the TS series.

The dual receivers facilitate reception on different bands.

The main receiver is the highest quality receiver among the TS series, thanks to its down-conversion configuration, newly developed mixer, and five types of roofing filters. The highest quality transceiver shows its true mettle in contests, fierce pile-ups and strong signal operations.

The TS-990S will surely satisfy any real DXer.



## Main Receiver

### We have achieved a down-conversion format for all amateur bands

A key point in realising maximum performance from the 1st mixer is to prevent the leakage of unnecessary signals, other than the target signal, from the mixer to the subsequent stage. This is achieved by taking advantage of the digital filter using the DSP in the final IF stage. The TS-990S main receiver employs a 1st IF frequency of 8.248 MHz for down-conversion, achieving superior close-in dynamic range unattainable through conventional up-conversion formats. Even if the interference is a close-in frequency, the receiver maintains a relatively flat dynamic range, which you can tune without losing your target signal.

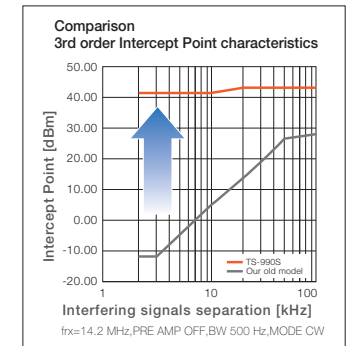

The horizontal axis shows separation of the target signal and interfering signal frequencies.

### The newly developed mixer contributes to achieving +40 dBm IP3

In place of the Double Balanced Mixer, which uses the J-FET, we have installed the newly developed Double Balanced Grounded Switch Type in the 1st mixer circuit, which is the heart of the main receiver.

The transceiver is also equipped with an Amateur Bands pre selector function that varies its tuning frequency in tandem with the receiver frequency. It effectively attenuates strong out-of-band signals that cannot be minimized through bandpass filters. Furthermore, we have achieved a +40dBm class third-order intercept point for the signal path of the 1st mixer, based on select circuits and components, employing large core toroidal coils to protect against distortion from large input signals, as well as using relays for the signal switching.

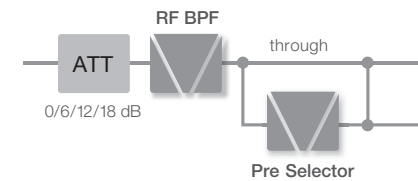

Amateur band RF BPF

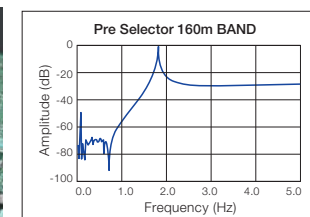

Pre Selector feature



Transformer feedback RF Amp

**The newly developed narrow-band High-IP roofing filter shows its true value by cutting adjacent unwanted signals**

The transceiver uses a down-conversion method for all amateur band reception, and features five types of High-IP roofing filter, plus space for an optional sixth filter. Narrow bandpass widths selectable are 500 Hz and 270 Hz for CW operation, 2.7 kHz for SSB and 6 kHz and 15 kHz, which are suitable for AM/FM. These filters are automatically selected in tandem with DSP-based final bandpass settings. Of course, manual switching is possible as well.

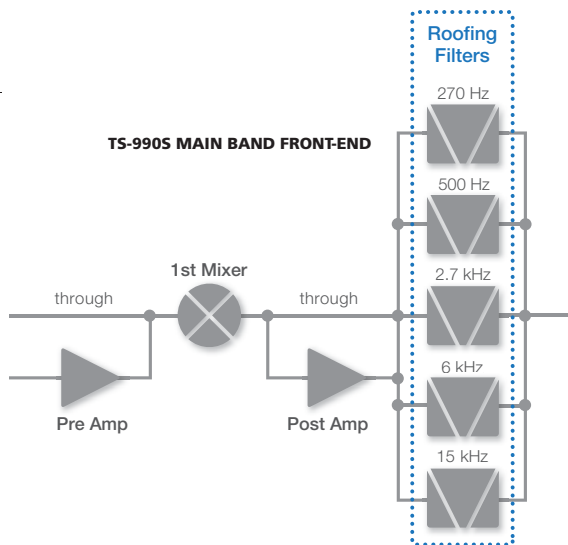

1st Mixer

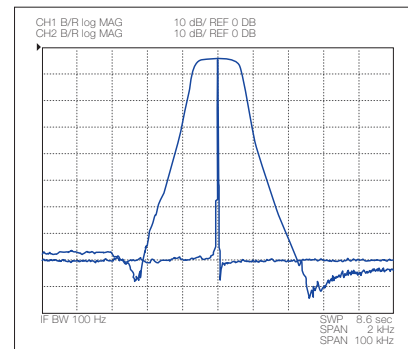

Roofing filter-characteristic example BW=270 Hz

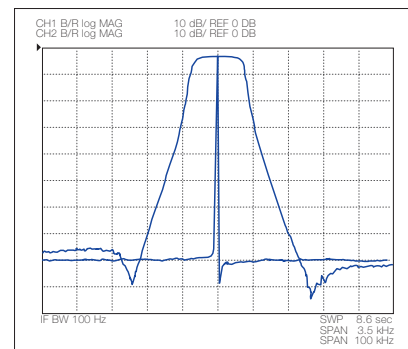

Roofing filter-characteristic example BW=500 Hz

**You can realize high C/N levels by dividing high frequencies using the newly developed VCO frequency division 1st local oscillator**

The TS-990S Local Oscillator Circuit is an independent configuration that combines the main receiver and VCO Frequency Division/DDS Direct, the sub-receiver and DDS Direct, and the transmitter and conventional PLL, with the targeted signal system. The newly developed VCO frequency division format is used for the 1st local oscillator of the main receiver. The device achieves favourable C/N characteristics that rival the DDS direct format, and relatively spurious-free local oscillation signals that are characteristic of the PLL format, by oscillating and dividing the VCO at higher frequencies than the intended frequency. It is possible to convert it to 1st IF in a pure state without leaking the target signal as noise by reducing static noise from the local oscillator and increasing the C/N ratio.

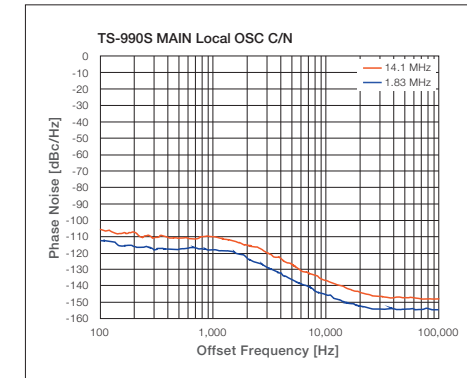

Main receiver 1st Local Oscillator C/N main receiver characteristic example (20m/160m)



DDS IC AD 9951

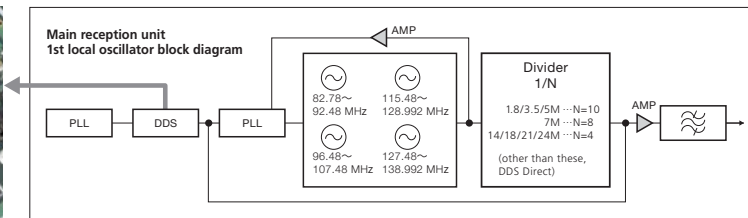

**Comes equipped with ±0.1 ppm TCXO, which combines high stability and energy saving**

The standard equipment includes a TCXO (Temperature-Compensated crystal Oscillator), which stabilizes frequencies at ±0.1 ppm as the standard signal source. Unlike OCXO (Oven Controlled crystal Oscillator), which requires warm-up time, this device can start up quickly even from the power-off position, while maintaining a high level of stability. It is in compliance with European energy-saving standard Lot6. Power consumption in stand-by energy-saving mode is less than 0.5 W. A BNC connector on the rear panel provides 10 MHz reference I/O.

Mode	Phantom load	Start-up time
Stand-by power saving	Or Less 0.5 W	Approx. 40 seconds
Normal	Approx. 20 W	Approx. 5 seconds



Super sub, which supports simultaneous dual reception.

Two attractive features of simultaneous dual reception for different bands are that you can easily change the condx on other bands and also easily handle split-operation. From this single device a whole new array of strategies becomes possible.

## Sub-receiver

### The sub-receiver, which incorporates the TS-590S receiver

#### Down-conversion occurs on the 160m/80m/40m/20m/15m amateur bands\*

The sub-receiver features performance that has exceeded its class since going on sale, thus further refining this popular receiver on the TS-590S. Because this is particularly the case in the front end, where it employs circuit configuration that makes down-conversion possible on the leading five amateur bands, it can be used in actual operation despite being "just" a sub-receiver.

\* The IF bandwidth for 160m/80m/40m/20m/15m bands is (SSB/CW/FSK/PSK) for frequency levels 2.7 kHz or below.

#### Roofing filter, 500 Hz, 2.7 kHz

Frequencies of 500 Hz and 2.7 kHz are standard for sub-receiver roofing filters. You can maintain a

more or less flat dynamic range even if interference impinges on your reception frequency, thanks to superior close-in dynamic range properties. You can clearly catch signals under conditions made problematic by strong close-in interference signals.

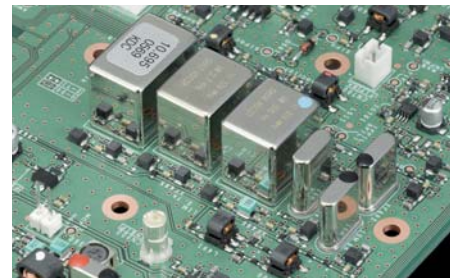

Innovation spurred on by digital technology has revolutionized the Kenwood tone.

Even after using narrow bandwidth filters for long periods of time, it is still easy to hear and less tiring to listen to.

In addition to introducing AGC control using dedicated DSP, we have further refined the Kenwood tone and reception sound quality transmitted by radio operators worldwide by innovating the analogue AGC unit and installing numerous interference and noise elimination functions. Such innovations have given new life to Kenwood's legendary tone.



## Triple DSP



### Equipped with dedicated DSP for the main receiver, sub-receiver, and band scope.

Kenwood continues to provide quality sound reception that is unattainable through analogue circuits, by incorporating the world-premiere DSP on the TS-950 and achieving IF AGC control on the TS-870 by using DSP for the first time for amateur transceivers. As a culmination of the foregoing

developments, three DSP units are used, one on each major block of the TS-990S. By distributing the signal processing of the main IF, band scope, and sub-IF, we have realized ample digital signal processing. (FM mode is AF DSP processing.)



For main receiver IF DSP  
ADSP-21363 clock @333 MHz

For sub-receiver IF DSP, every kind of signal processing  
ADSP-21369 clock @260 MHz

For band scope  
ADSP-21363 clock @333 MHz

### Advanced AGC control, fusing together digital and analogue

The reception sound quality of SSB and CW is not solely determined by audio frequency and filter delay properties. AGC characteristics play a very

significant role as well. The opinion of many of our fans that “even for long periods of time they never get tired of listening” is due to the characteristics of Kenwood’s AGC. The TS-990S goes a long way in helping further refine the Kenwood tone by innovating not only the AGC control algorithm on the DSP but also the analog AGC unit as well.

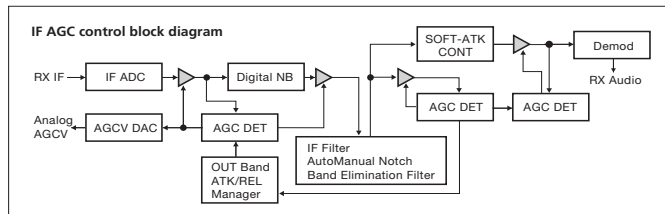

### Exacting chassis design for realizing quality sound

The sound quality of the built-in speaker is largely determined by the chassis structure. With the TS-990S, we have been able to minimize unnecessary chassis vibration through multiple simulations from the concept phase. The Kenwood tone is supported not only by circuits and DSP but also by exact chassis design.

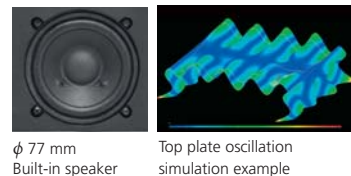

φ 77 mm  
Built-in speaker

Top plate oscillation  
simulation example

### Extensive interference elimination and noise reduction functions

#### IF filter bandwidth variability

You can vary DSP filter bandwidth and eliminate extensive interference depending on use and condition. You can operate it as a HI CUT/LOW CUT function in SSB/AM/FM mode, and WIDTH/SHIFT function in CW/FSK/SSB-DATA transmission mode.

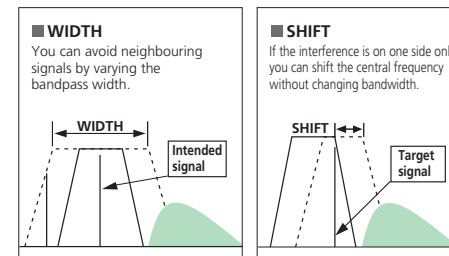

#### IF filter A/B/C one-touch switch instantly

It is possible to preset a maximum of three IF filter bandwidths and switch instantly at any time. Set for narrow or wide, such a function is convenient for competitions requiring quick operations.



#### IF notch

You can eliminate overpowering interference signals with a notch filter and catch intended weak signals. You can switch between the IF auto notch and the manual notch function that can be changed manually, depending on the nature of the interference.

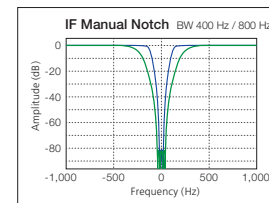

#### Band elimination filter function

The filter is capable of varying the stopband bandwidth and the amount of loss. When signals that interfere with the target signal multiply, this is a convenient function for operations such as dampening interference signals, even if it cuts down some of the target signal.

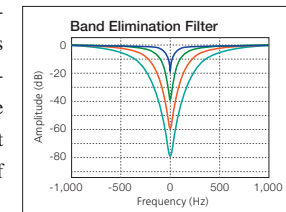

#### The noise blanker function (NB1/NB2) is equipped with digital/analogue 2 format

Equipped with an analogue noise blanker (NB1) which is considered being effective against weak noise, and a digital noise blanker (NB2). Choose the NB1 or NB2 based on noise type and reception condition. With NB1, stable noise reduction is possible without depending on reception bandwidth. NB2 is effective against noise that cannot be tracked by an analogue noise blanker. Plus, both the NB1 and NB2 can be used simultaneously with the TS-990S.

#### DSP-based noise reduction function (NR1/NR2)

The TS-990S is also equipped with two types of noise reduction format—NR1 and NR2. An optimal noise reduction format is applied to each reception mode for NR1. And for NR2, SPAC method is applied which is more effective in CW operation.

#### Other extensive interference elimination and noise reduction functions

##### ●Beat cancel function (BC1/BC2)

The beat cancel function is effective against relatively weak, multiple beats, whereas the IF auto notch is effective against strong beats.

##### ●Audio peak filter

You can vary the bandpass width of the pitch tone in carrier modes such as CW and FSK. FSK is compatible with mark and space frequencies.

Transmitter performance, featuring high-scale specifications, can withstand long periods of operation at full power.

Operating stably even when continually working over long periods of time, such as in competitions.

Transmit



### High reliability design promises stable operation at 200 W

The device uses VRF150MP power MOSFETs in push-pull, running at 50 V. You can obtain a high, stable output of 200 W on all bands. You can achieve superior IMD properties by pursuing bias and matching conditions in order to fully exploit the

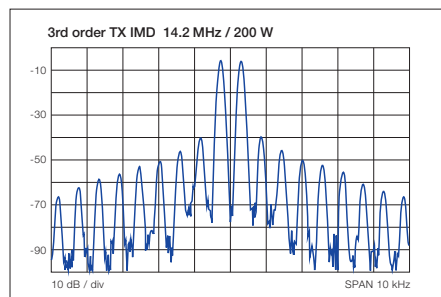

FET attributes. Further, you can realize Kenwood's distinctive tone by amplifying the clean modulated signal produced by DSP with an amplifier that exhibits excellent linearity.



### Built-in automatic antenna tuner capable of high-speed operation

The built-in automatic antenna tuner is a preset type that covers amateur band frequencies ranging from 160m~6m, and can be switched in on receive too. The tuner is capable of rapid QSY based on instantaneous band change, using a relay system that is known for high-speed operations. The relay, inductors, and coil use large-sized components that are able to handle the 200 W output.

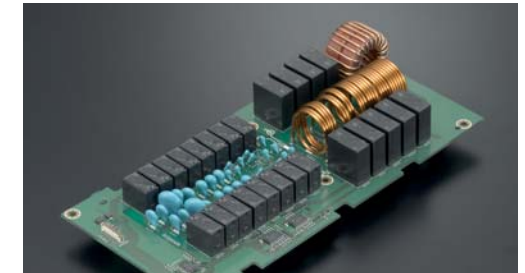

It is fitted with four antenna terminals, which can be set independently on amateur bands, whether main band or sub-band. The reception input and output terminals can be used for reception dedicated antennas, antenna output for external reception devices, and external BPF connections. It is usable with either the main band or the sub-band.

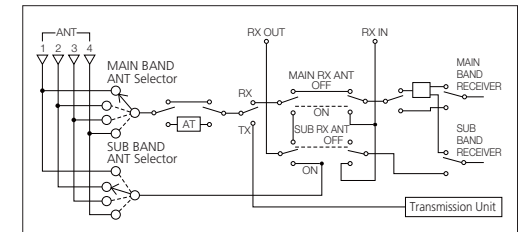

### Cooling system to send a sufficient volume of air to each unit

Cooling is very important to obtain a stable output of 200 W. Heat dissipation efficiency is increased in the TS-990S through a large fin-type aluminium heat sink. An independent variable-speed fan is provided for the switching power supply, final unit, and antenna tuner, cooling each unit with a sufficient air supply. The switching power supply and the final unit have twin cooling fans. Noise is reduced by controlling the fan speed according to the temperature.

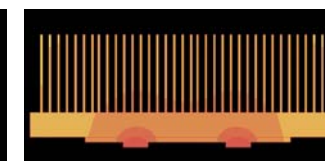
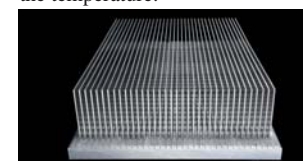
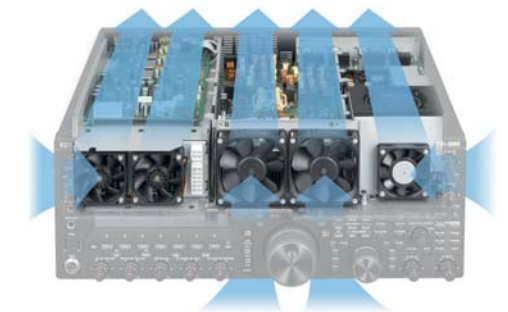

#### Thermal simulation example

To dissipate the heat of the 200 W final, we used swage fins instead of the conventional extruded aluminium fins. Using CAE analysis we designed the optimal fin shape and size for heat dissipation.

Fitted with dual TFT displays for an intuitive understanding of what's happening around you.

The combination of two displays, main and sub-band, allows you to simultaneously monitor the target signal and the surrounding area with minimal eye movement.



### Monitor the area surrounding the target signal with the main display

#### Main display

The main display shows basic information about the frequency, mode, meter, and others functions, as well as the on/off status of the other accessory functions. You can also view internal parameter settings and memory lists. In addition, it features a

band scope function that allows you to monitor band status. Execute fast sweeps with FFT processing using DSP. Switch to different view modes such as waterfall and reception/transmission equalizer views.

#### Main display example views



Waterfall view



Equalizer view



RTTY reception view

### Sub-band display monitors the target signal itself

The 3.5" TFT sub-band display is located above the main dial, which not only reduces eye movement in reading the frequency, but also allows you to monitor the target signal itself by displaying the demodulated audio spectrum. In addition, filter

effects can be displayed on the easy-to-see sub-band display, allowing for intuitive operation. You can switch the sub-band display between the four different view modes below according to your intention.

**Normal display**  
Dual frequency display  
Basic Screen

**Magnified frequency display**  
Dual frequency display

**Simultaneous display**  
FSK mode

**Simultaneous display**  
PSK mode

**Single frequency display with virtual dial**

**Single frequency display**

### When you are in the mood for a change, how about these display modes?

#### Main display

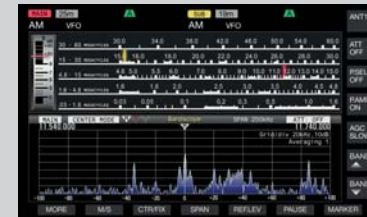

Wide dial display (Reception specific)



TS-930 type display

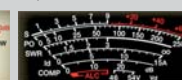

TS-940 type display

#### Sub-band display



Analogue dial display

### Touch-sensitive main screen



Simply touch the main screen for quick QS.Y.

## Comfortable operational performance that you can control at will.

The panel layout, familiar to Kenwood users, allows for intuitive operation. It is sure to win you over, increasing the accuracy of your operations and allowing you to develop greater familiarity with the equipment.

# Control

### The new frequency function can be operated intuitively

You can use the frequency function that switches legacy VFO A/VFO B by switching the main and sub-band. Turn the sub-band reception on and off using the RX key located above the main tuning dial, and switch between simplex and split using the TX key. A single glance at the LEDs lets you know the current status.

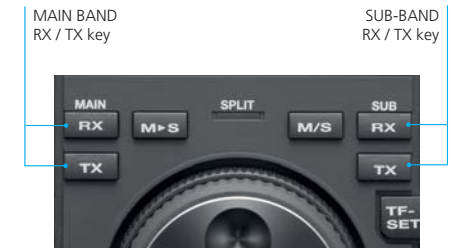

### The new split function allows you to use quick settings

Similar to the legacy series, you can add functions via M>S and M/S giving a dual-action quick-split setup.



1. Hold down the Sub-band TX key, and the split LED will flash.



2. When the transmission frequency is set.

To set 2UP, simply press 2 on the numeric keypad, and the sub-band VFO will change +2 kHz from the main reception frequency; split set up is now complete. To set 1DOWN, press 0 and then 1 on the numeric keypad, and you can set increments of 1 kHz from ±1~9 kHz.



2. Searching for a transmission frequency

Operate the sub-band dial to determine the transmission frequency, press the TX key, and setup is complete. Coarse adjustment is also possible by tapping a likely vacant frequency on the main scope.

### You can also input split and sub-band reception states into memory

Memory for a maximum of 120 channels is available. In addition to the repeater frequency, you can also preset beacons and transmission stations.

You can easily call up the states of simultaneous dual reception using the dual channel memory.

Memory Channel List						
CH	Type	Frequency 1	Frequency 2	TX/RX Func.	Name	L. OUT
00	S	14.200.000	USB		JA1YKX	
01	D	14.200.000	USB	14.205.000	USB SPLIT	
02	D	14.200.000	USB	14.205.000	USB DUAL	
03	D	14.200.000	USB	14.205.000	USB SPLIT DUAL	
04						
05						
06						
07						

Number of Memory Channels  
 Standard Memory: 100 Channels  
 Interval Specified Memory: 10 Channels  
 Extended Memory: 10 Channels

### Conveniently located extensive sub-Receiver controls

The dedicated sub-receiver with extensive interference elimination is centrally located at the right edge of the main panel. Access the dials and keys you need without hesitation. An LED is lit when operating the sub-band to prevent accidental operation (this can also be dedicated to the main encoder variable bandwidth). Other functions have been significantly upgraded in the TS-990S from the TS-590S, including band elimination filters, APF, mute, the addition of slope switching in the DSP IF FILTER, independent AGC OFF key, and simultaneous use of NB1/NB2.

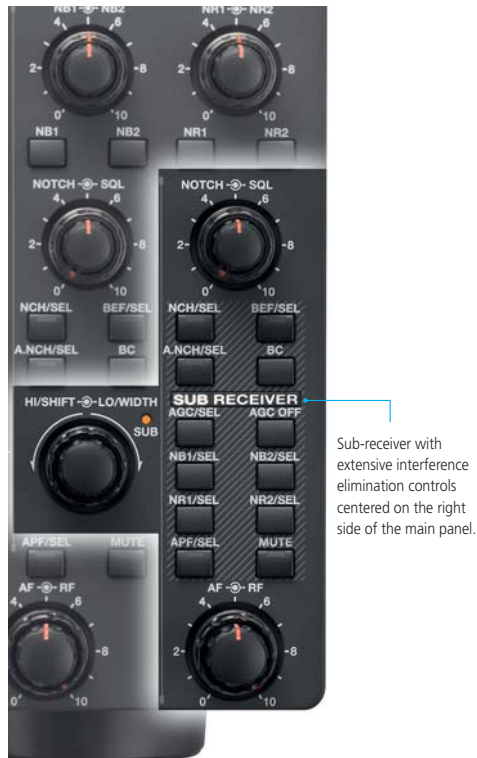

Sub-receiver with extensive interference elimination controls centered on the right side of the main panel.

### Useful functions positioned around the main and sub-band dial

Frequently used functions are centrally placed in the immediate vicinity of the main and sub-band dial. Supports quick operations.

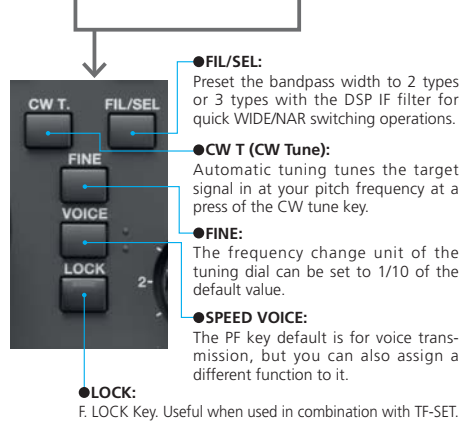

### Increased user-friendliness featuring two USB-A ports on the front panel

The front panel is equipped with headphone jack, microphone jack, and two USB-A ports for keyboard or USB flash drive.



### Firmware updates by USB flash drive or USB cable

Switch to update mode and insert a USB memory stick into the USB-A port on the front panel, and the update will automatically begin. In addition, access your USB memory from your PC by connecting your PC via USB cable to the USB-B port on the rear panel, switch to update mode, and a folder named TS-990 will appear on your computer.

### DATA mode supported by external I/O switching

There are a variety of I/O interfaces, including the microphone jack, analogue audio input and output, USB audio interface, and optical digital interface. By combining DATA mode (1-3) with SSB/FM/AM modes, it is possible to easily switch between external devices for modulation and demodulation. Switch between DATA VOX function and mute for each modulated line.

### Transmit and receive DSP equalizers

In addition to the legacy presets, up to a maximum of three user settings can be configured. You can store the equalizer settings used for each mode and enjoy a very comfortable rag-chew session with others.

RX equalizer



### Voice guidance / recording function

Equipped with voice guidance for frequencies, key control, and setting. You can also record and replay your message.

### Remote control the TS-990S from your PC

Using the ARCP-990 radio control software, you can control most functions from your PC. Control the memory channel, settings, and functions using your PC. Download the free software from the Kenwood website.



ARCP-990 example views

### Kenwood SKY COMMAND SYSTEM II

Enables full-duplex operation with improved functionality such as visual confirmation of HF frequency on the LCD panel. Control via TNC (AX.25) enables more accesses to HF functions: XIT, mode switching, split-frequency operations on/off, memory shift, and frequency step selection. The transporter sends out its pre-programmed call sign via CW every 10 minutes.

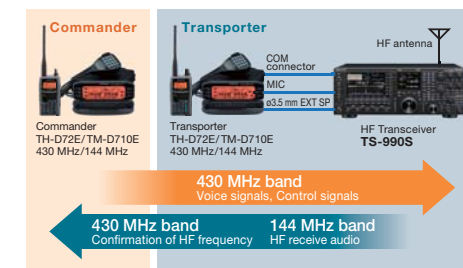

\*Kenwood SKY COMMAND SYSTEM II uses a pair of TH-D72E/TM-D710E transceivers.  
**TS-990S is limited to the following functions in the operation of the control KSS.**  
 ● Operation Commander [A / B] in the TS-990S is equivalent to [M / S].  
 ● Memory channel is simplex operation only.  
 ● Remote power On/Off is not available on Standby State Low Power Consumption mode.  
 ● Control to the main band operation only.  
**Note: Refer to applicable Amateur Radio regulations to check whether you are permitted to use this function.**

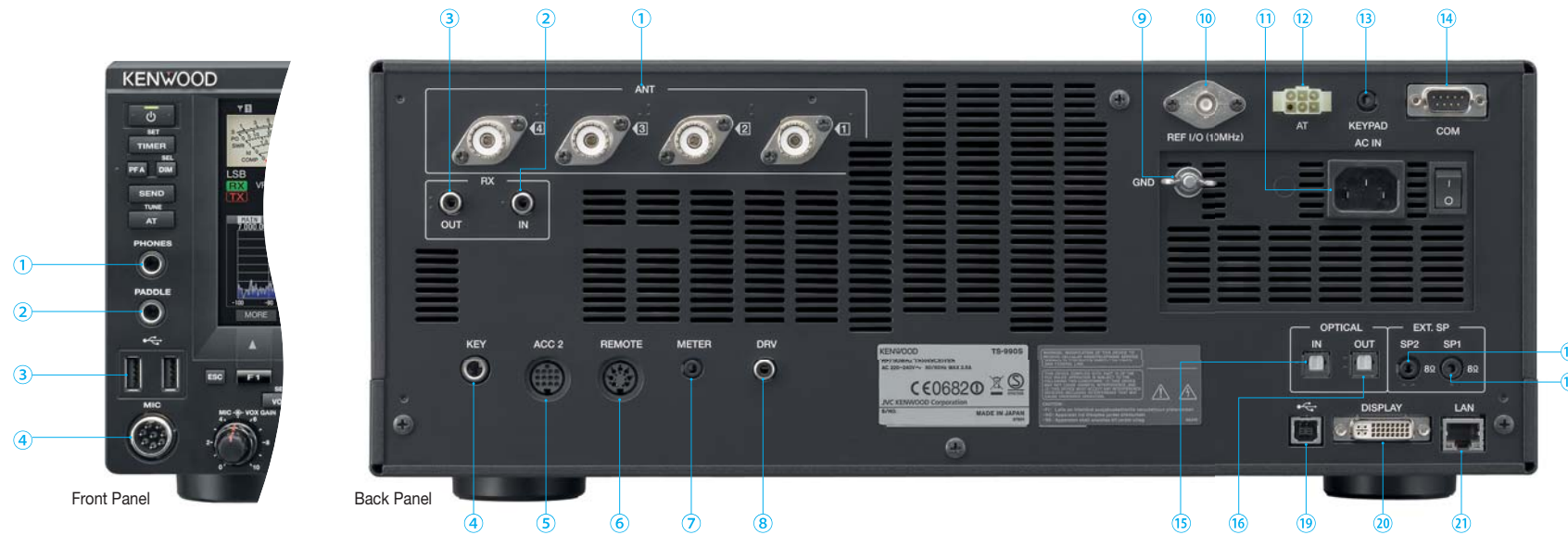

**Front Panel**

- ① Headphone Jack (φ6.3 mm)
- ② Paddle Keyer (φ6.3 mm)
- ③ USB Connector (USB-A):  
USB Memory, USB Keyboard
- ④ Microphone Jack (8 Pin Metal Type)

**Back Panel**

- ① Antenna Connector x4
- ② RX IN Connector (RCA): Receive Only Antenna Terminal
- ③ RX OUT Connector (RCA): External Receiver Connection Terminal
- ④ Key Jack (φ6.3 mm): For Paddle, Straight Key, and PC Keying
- ⑤ ACC2 Connector (13 Pin DIN): Audio I/O and Other Accessories Connection
- ⑥ Remote Connector (7 Pin DIN): Linear Amplifier Connection
- ⑦ Meter Jack (φ3.5 mm): Analogue Meter Connection
- ⑧ Drive Connector (RCA): Drive Output
- ⑨ Ground Terminal
- ⑩ Standard External I/O Terminal (BNC): 10 MHz





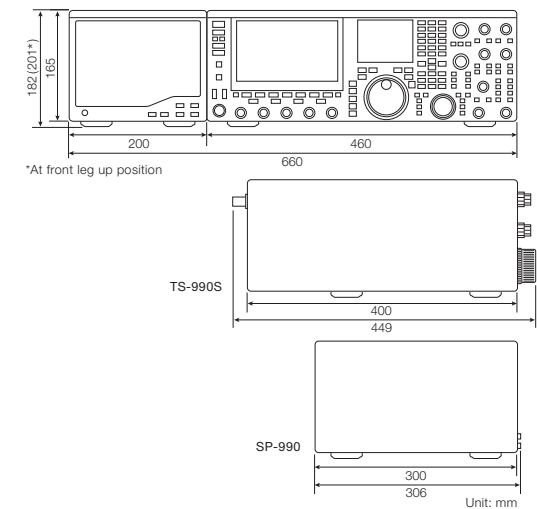



- ⑪ AC Power Supply Connector (3 Pin)
- ⑫ AT Connector (6 Pin): External Antenna Tuner Connection
- ⑬ Keypad Jack (φ3.5 mm): Function Key Pad Connection
- ⑭ COM Connector (D-SUB 9 Pin): RS-232C
- ⑮ Optical Connector Input Terminal (EIAJ Optical)
- ⑯ Optical Connector Output Terminal (EIAJ Optical)
- ⑰ External Speaker Jack 1 (φ3.5 mm)
- ⑱ External Speaker Jack 2 (φ3.5 mm)
- ⑲ USB Connector (USB-B): PC Control, USB Audio
- ⑳ Display Connector (DVI-I): External Display Connection Terminal
- ㉑ LAN Connector (RJ-45): PC Control, Time Correction (NTP)

**■Dimensions**



# Front/Rear Panel

## ■ Main Options

<b>MC-90</b> Deluxe Desktop Microphone 	<b>MC-60A</b> Desktop Microphone 
<b>MC-43S</b> Hand Microphone 	<b>HS-5*1</b> Open-Air Deluxe Headphones 
<b>HS-6*1</b> Light Weight Headphones 	<b>SP-990</b> External Speaker <b>NEW</b> 
<b>ARCP-990</b> Radio Control Program <b>NEW</b>  <p>*Freeware Freeware available for download from Kenwood website starting late March, 2013</p>	<b>ARHP-990</b> Radio Host Program <b>NEW</b>  <p>*Freeware Freeware available for download from Kenwood website starting late March, 2013</p>

\*1:HS-5 and HS-6 are monaural. We recommend using stereo headphones to fully utilize the simultaneous dual reception function of the main unit.



## ■ TS-990S Specifications

General		
Frequency range (Transmitter)	160m band	1.81 ~ 2.0 MHz
	80m band	3.5 ~ 3.8 MHz
	60m band *1	5.25 ~ 5.45 MHz
	40m band	7.0 ~ 7.2 MHz
	30m band	10.1 ~ 10.15 MHz
	20m band	14.0 ~ 14.35 MHz
	17m band	18.068 ~ 18.168 MHz
	15m band	21.0 ~ 21.45 MHz
	12m band	24.89 ~ 24.99 MHz
	10m band	28.0 ~ 29.7 MHz
6m band	50.0 ~ 52.0 MHz	
Frequency range (Receiver)*2	0.13 ~ 30 MHz, 50 ~ 54 MHz VFO: Continuous 30 kHz ~ 60 MHz	
Mode	A1A(CW), A3E(AM), J3E(SSB), F3E(FM), F1B(FSK), G1B(PSK)	
Frequency stability	Within ±0.1 ppm (0 °C ~ +50 °C)	
Antenna impedance	50 Ω	
Antenna tuner load range	16.7 Ω ~ 150 Ω	
Standard voltage	AC 220 ~ 240 V (50/60 Hz)	
Supply voltage range	±10 % (AC 198 V ~ 264 V)	
Power consumption	At transmit (maximum)	840 VA or less
	At receive (no signal)	200 VA or less
Usable temperature range	0 °C ~ +50 °C	
Dimensions	Without projection	W460 x H165 x D400 mm
	Include projection	W460 x H182 x D449 mm
	At front leg up position	H201 mm (front panel), H173 mm (rear panel)
Weight	Approx. 24.5 kg	
Transmitter		
Output power	CW/SSB/FSK/PSK/FM (AM)	200 W (50 W)
Modulation	SSB:Balanced, AM:Low Power, FM:Reactance	
Maximum frequency deviation (FM)	wide: ±5 kHz or less, narrow: ±2.5 kHz or less	
Spurious emissions	HF (Harmonics) : -60 dB or less	
	HF (others) : -50 dB or less	
Carrier suppression	50 MHz: -66 dB or less	
Unwanted sideband suppression	-60 dB or less	
Transmit frequency response	Within -6 dB (300 ~ 2700 Hz)	
Microphone impedance	600 Ω	
XIT variable range	±9.999 kHz	

Receiver			
Circuit type		Main	Sub1 *3
		Double superheterodyne	Double superheterodyne
Intermediate frequency	1st IF	8.248 MHz	11.374 MHz
	2nd IF (FM)	24 kHz / (455 kHz)	24 kHz
	3rd IF (FM)	-	-
Sensitivity (TYP)	SSB, CW, FSK, PSK (S/N 10 dB)	0.5 μV (0.13 ~ 0.522 MHz)	
		4 μV (0.522 ~ 1.705 MHz)	
		0.2 μV (1.705 ~ 24.5 MHz)	
		0.13 μV (24.5 ~ 30 MHz)	
		0.13 μV (50 ~ 54 MHz)	
	AM (S/N 10 dB)	6.3 μV (0.13 ~ 0.522 MHz)	
		32 μV (0.522 ~ 1.705 MHz)	
		2 μV (1.705 ~ 24.5 MHz)	
	FM (12 dB SINAD)	1.3 μV (24.5 ~ 30 MHz)	
		1.3 μV (50 ~ 54 MHz)	
Image Rejection Ratio (50 MHz)	70 dB (60 dB) or less		
IF Rejection Ratio	70 dB or less		
Selectivity	SSB (LO:200 / HI:2800 Hz)	2.4 kHz or more (-6 dB)	
		4.4 kHz or less (-60 dB)	
	CW, FSK, PSK (WIDTH:500 Hz)	500 Hz or more (-6 dB)	
		1.2 kHz or less (-60 dB)	
	AM (LO:100 / HI:3000 Hz)	6.0 kHz or more (-6 dB)	
		12 kHz or less (-50 dB)	
FM	12 kHz or more (-6 dB)		
	25 kHz or less (-50 dB)		
XIT variable range	±9.999 kHz		
Notch filter attenuation	60 dB or more (Auto), 70 dB or more (Manual)		
Beat cancel attenuation	40 dB or more		
Audio output	1.5 W or more (8 Ω)		
Audio output impedance	8 Ω		

\*1 60m band: Refer to applicable Amateur Radio regulations to your country.

\*2 MAIN BAND: Spec. guaranteed in amateur band 160m through 6m

\*3 In 160m/80m/40m/20m/15m Amateur bands, IF band width 2.7 kHz or less (SSB, CW, FSK, PSK)

\*4 Except in above \*3

Internal beats may occur during amateur radio band reception, depending on combinations of main band and sub-band frequencies.

Spurious signals other than the intended signal may appear on the band scope and/or waterfall view.



---

## Kenwood Electronics UK Limited

Kenwood House Dwight Road Watford  
Hertfordshire WD18 9EB, United Kingdom

\*Alterations may be made without notice to improve the ratings or the design of the transceiver.

\*The photographic and printing processes may cause the coloration of the transceiver to appear different from that of the actual transceiver.

[www.kenwood-electronics.co.uk](http://www.kenwood-electronics.co.uk)

CA321E-E-16