

INSTRUCTION MANUAL FT-290R



YAESU ELECTRONICS CORP.
P.O. BOX 49
PARAMOUNT, CA 90723
U.S.A.

YAESU MUSEN CO., LTD.
C.P.O. BOX 1500
TOKYO, JAPAN

Scanned by IW1AXR

Downloaded by
Amateur Radio Directory



TABLE OF CONTENTS

	(Page)
INTRODUCTION	1
SPECIFICATIONS	2
SEMICONDUCTORS	3
ACCESSORIES	3
FRONT PANEL CONTROLS AND SWITCHES	4
REAR APRON SWITCHES AND JACKS	8
SIDE PANEL JACKS	10
INTERNAL SWITCHES	11
OPERATION	14
CIRCUIT DESCRIPTION	25
MAINTENANCE AND ALIGNMENT	32
PARTS LIST	46

FT-290R 2 METER PORTABLE TRANSCEIVER



INTRODUCTION

The FT-290R is a highly sophisticated, compact multi-mode transceiver for the two meter amateur band. Featuring PLL synthesis in 100 Hz, 1 kHz, 5 kHz, or 10 kHz steps, the FT-290R utilizes a Liquid Crystal Display for digital readout of the operating frequency. Ten memories, scanning of the band or memory channels, two VFOs, and receiver offset tuning make the FT-290R a significant breakthrough in technology.

Powered by eight "C" size dry cells or Ni-Cd batteries (not supplied), the FT-290R is completely self-contained and portable. A telescoping whip antenna is built into the FT-290R, for convenient portable operation. And a high-performance noise blanker is also included, for minimizing interference caused by impulse noise.

Power output is 2.5 watts, switchable to 0.5 watt for battery conservation. For memory backup purposes, a lithium cell is included, providing an estimated lifetime of five years because of the extremely low current consumption of the memory circuitry. The light weight, portability, and efficiency of the FT-290R make it suitable for field satellite operation, emergency FM work, or vacation enjoyment.

We recommend that you read this manual in its entirety, so as to understand more completely the many features of the exciting new FT-290R. With proper care in operation, this equipment will provide many years of reliable performance.

FT-290R MODEL CHART

MODEL	FREQUENCY COVERAGE	PRESET FREQUENCY	FREQUENCY STEPS (FM)	FREQUENCY STEPS (SSB/CW)	REPEATER SHIFT (FM)	TONE BURST FREQUENCY (OPTIONAL)	TONE ENCODER (OPTIONAL)	TONE SQUELCH (OPTIONAL)
(A)	144 - 147.999 MHz	147.000 MHz	10 kHz (5 kHz)	100 Hz (1 kHz)	±600 kHz	1800 Hz	FTS-32AE	FTS-32
(B)	144 - 145.999 MHz	145.000 MHz	25 kHz (12.5 kHz)	100 Hz (1 kHz)	±600 kHz	1750 Hz	FTS-32AE	FTS-32
(C)	144 - 147.999 MHz	145.000 MHz	25 kHz (12.5 kHz)	100 Hz (1 kHz)	±600 kHz	1750 Hz	FTS-32AE	FTS-32
(D)	144 - 147.999 MHz	145.000 MHz	10 kHz (5 kHz)	100 Hz (1 kHz)	±600 kHz	1750 Hz	FTS-32AE	FTS-32
(E)	144 - 147.999 MHz	147.000 MHz	10 kHz (5 kHz)	100 Hz (1 kHz)	±600 kHz	1750 Hz	FTS-32AE	FTS-32

SPECIFICATIONS

GENERAL

Frequency coverage:
144 – 148 MHz; 144 – 146 MHz
(as per your local regulations)

Modes of operation:
SSB (USB, LSB), CW and FM

Synthesizer steps:
SSB/CW: 100 Hz, 1 kHz
FM: 5 kHz, 10 kHz (12.5 kHz, 25 kHz,
depending on local requirements)

Power requirements:
8 C - size dry battery cells or
8 C - size Ni-Cd battery cells
External: 8.5 – 15.2 V DC
Memory backup: built-in lithium bat-
tery cell

Current consumption:
60mA on receive;
800mA on transmit (2.5W RF, FM)

Antenna impedance:
50 ohms

Case size:
58(H) x 150(W) x 195(D) mm

Weight:
1.3kg. without batteries

TRANSMITTER

Power output:
2.5 watts at 12 volts

Carrier suppression:
Better than 40 dB

Spurious radiation:
Better than 60 dB

Unwanted sideband suppression:
Better than 40 dB

Tone burst frequency:
1800 Hz (U.S.A. model)
1750 Hz (other models)

Frequency response:
300 – 2700 Hz (–6 dB)

FM deviation:
±5 kHz

Microphone impedance:
600 ohms

RECEIVER

Circuit type:
SSB/CW: Single conversion
superheterodyne
FM: Double conversion
superheterodyne

Intermediate frequencies:
1st IF 10.81 MHz
2nd IF 455 kHz (FM)

Sensitivity:
SSB/CW: 0.5μV for 20 dB S/N
FM: 0.25μV for 12 dB SINAD

Selectivity:
SSB/CW: 2.4 kHz at 6 dB down;
4.1 kHz at 60 dB down
FM: 14 kHz at 6 dB down;
25 kHz at 60 dB down

Image reduction:
Better than –60 dB

Audio output impedance:
8 ohms

Audio output:
1 watt @10% THD

Specifications subject to change without notice or obligation.

Scanned by IW1AXR
Downloaded by
Amateur Radio Directory

SEMICONDUCTORS

ICs:

HD44820A18 1
ICL7660CPA 1
MC1496P 1
MC3357P 1
MC14001B 1
MC14069UB 2
TC5082P 1
TP0401 1
μPC575-C2 1
μPC577H 1
μPD2819-C 1

FETs:

2SK30A-Y 1
2SK168D 2
2SK192GR 4
2SK193F 1
3SK51-03 1
3SK59GR 1
3SK59Y 1
3SK73Y 4

Transistors:

2SA733P 2
2SA733Q 1
2SC496Y 1
2SC535A 5
2SC945P 4
2SC1583 1
2SC1947 1
2SC2026 1
2SC2053 1
2SC2603E 16
2SC2786L 2
MPS-A13 1

Diodes:

1S188FM (Ge) 12
1SS53(Si) 49
10D1(Si) 2
MI301(Si) 2
V05B 1
1SS97 1
(Schottky Barrier)
1SV50 (Varactor) 1
1SV68 (") 1
1SV69 (") 8
1T25 (") 1
HZ6C-1L (Zener) 1
RD5.6EB-3(") 2
RD6.8EB-3(") 1
TLG205(LED) 1
TLR205(LED) 1

LCD Display:
H1313A 1

ACCESSORIES

MICROPHONE YM-47 1
(M3090033)

MICROPHONE HANGER 1
(R0071360)

SHOULDER STRAP 1
(R070600)

EXTERNAL POWER SUPPLY PLUG P-200 1
(P1090139)

EXTERNAL SPEAKER PLUG C-107 1
(P0090034)

FRONT PANEL CONTROLS AND SWITCHES

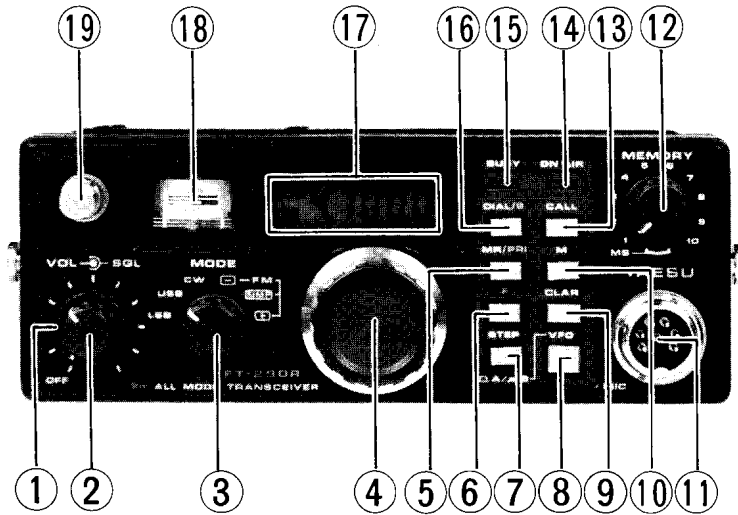

(1) SQL

The squelch control silences the receiver in the FM mode when no stations are being received on the channel in use. The SQL control should only be advanced to the threshold point of background noise silencing; further advancement of this control will lead to reduced sensitivity to weak signals.

(2) VOL

This is the audio gain control for the receiver, as well as the main ON/OFF switch for the transceiver.

(3) MODE

This switch selects the desired mode: LSB, USB, CW, or FM.

(4) MAIN DIAL

The main tuning dial is used for selection of operating frequencies using the two main VFOs or the clarifier. In the LSB, USB, and CW modes, synthesizer steps of 100 Hz or 1 kHz are programmed, while on FM the channel steps are 5 kHz or 10 kHz each. In the clarifier mode, the synthesizer moves in 100 Hz steps.

(5) MR/PRI

This switch selects either the memory recall mode or priority channel operation. If only the MR/PRI switch is pressed, the memory channel selected by the MEMORY rotary switch will be activated. If the yellow F button is first pressed, then the MR/PRI button, priority channel operation will be selected.

(6) F

The yellow "F" (Function) button activates either the priority channel mode or the memory split mode. The F button itself does not select a mode, but it programs the microprocessor to select the mode labeled in yellow letters in either of the two switches immediately above the F button: DIAL/S or MR/PRI.

(7) STEP

This switch selects the desired synthesizer steps. In the LSB, USB, or CW mode, the preset mode is 1 kHz per step. Press the STEP button to switch to 100 Hz steps. A second press of this switch returns you to 1 kHz steps. In the FM mode, the preset is for 10 kHz steps. Pressing the STEP switch selects 5 kHz steps, while a second press returns you to 10 kHz steps.

(8) VFO Switch

The VFO button selects one of the two internal VFOs on the FT-290R. Upon switch-on, VFO-A is automatically selected. Press the VFO switch to select VFO-B, and dial up the new frequency. A second press of the button releases the switch, returning you to VFO-A.

(9) CLAR

This switch activates the receiver offset tuning feature (Clarifier). The clarifier allows ± 10 kHz of offset from the transmit frequency, tuned in 100 Hz steps (all modes).

(10) M

The M (Memory) button is used to store a frequency in memory.

(11) MIC

This seven pin jack accepts microphone audio input, the scanning control lines, and the PTT (Push to Talk) control line. Microphone impedance is 500 ohms.

(12) MEMORY

The memory channel selector is used to choose any of the 10 memory channels. In the MS (Memory Scan) position, scanning of the memories may be performed.

(13) CALL

When this button is pressed (FM mode only), a 1800 Hz tone will be superimposed on the microphone line, and the PTT switch line will be grounded, activating the transmitter. This allows manual-length access of repeaters requiring a burst tone.

(14) ON AIR

This indicator lights up while transmitting.

(15) BUSY

This indicator lights up when the main squelch is opened up by an incoming signal.

(16) DIAL/S

When the DIAL/S button alone is pushed, tuning is accomplished by the main dial on either VFO-A or VFO-B. If the F button is pushed, then the DIAL/S button, the memory split mode will be selected, for receiving on the memory while transmitting on the VFO.

(17) DIGITAL DISPLAY

The digital display uses a liquid crystal display for indication of the operating frequency and mode. The frequency readout displays the last five digits of the operating frequency, with resolution to 0.1 kHz. Indicators are also provided for indication of clarifier operation ("CLAR"), memory channel operation ("M"), or memory split operation ("-") on transmit).

(18) S/PO

The meter allows determination of incoming signal strength and relative power output. The meter is also used for checking battery operation.

(19) WHIP ANTENNA

The built-in whip antenna is satisfactory for most portable operation. When using an external antenna, the whip should be telescoped fully into the transceiver. Conversely, when an external antenna is not used, the whip should always be fully extended.

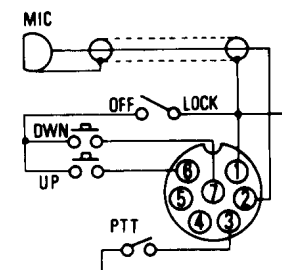
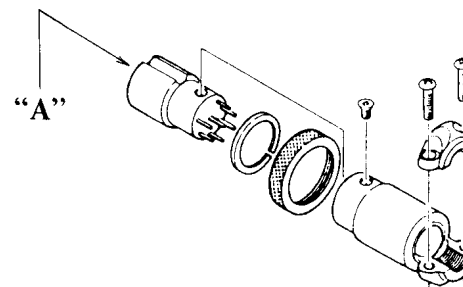

Viewed from "A" Side
Pin 4 +5VOLT
Pin 5 Audio Rx

YM-47

MICROPHONE PLUG
CONNECTIONS

Scanned by IW1AXR
Downloaded by
Amateur Radio Directory

REAR APRON SWITCHES AND JACKS

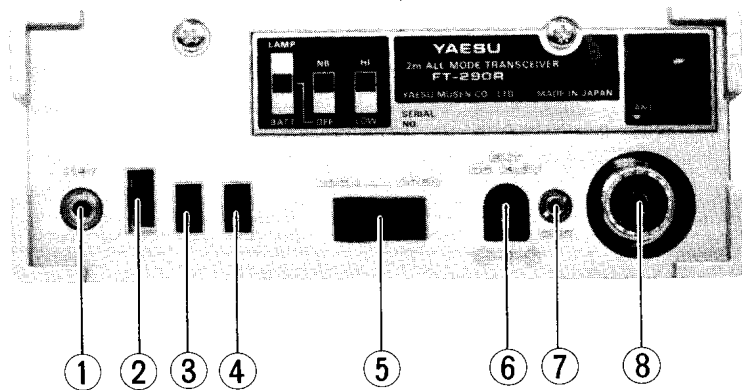

(1) KEY

This jack is used for the keying input line. Use a miniature phone plug for connection to your telegraph key or keyer. The key-up voltage is 7V, and the key-down current is 0.3 mA.

(2) LAMP/BATT CHECK

With this switch in the LAMP mode, the front panel meter and LCD display will become illuminated for nighttime operation. If the power switch (on the VOL control) is off, this lamp will not come on, thus preventing inadvertent battery discharge.

In the BATT mode, the battery voltage is checked. The meter needle should deflect at least to the dividing line between the green and white zones of the meter scale. If not, the batteries will require replacement or recharging.

(3) NB

This switch activates the built-in noise blanker. While no blanker can be expected to eliminate all types of noise, such as white noise, etc., this blanker should prove highly effective in minimizing pulse-type noise such as that caused by automotive ignition systems.

(4) HI/LOW

This switch selects power outputs of 2.5 watts (HI) or 0.5 watt (LOW).

(5) CASE LATCH

This mechanism provides easy opening and closing of the cabinet for battery removal.

(6) EXT DC 13.8V

Use this jack for connection to an external DC supply. Never exceed 15 volts at this jack, and never apply AC power of any kind at this point. Also, be absolutely certain that DC power of the proper polarity is applied; when replacing DC plugs, check to be sure that the plug is wired correctly, as there is little standardization in the world for the power plug used for the FT-290R. Failure to observe these simple precautions will void any and all warranties on this equipment.

(7) CHG

The external charge jack accepts charging voltage from the NC-11B/C battery charger (Option). When using alkaline or other dry cell batteries, do not attempt to recharge them. Use only C size Ni-Cd cells (available from your Yaesu dealer) if you desire rechargeable cells.

(8) ANT

This is a UHF type connector for use with an external antenna of 50 ohms impedance (nominal). When using an external antenna, the internal whip should be telescoped fully inside the radio.

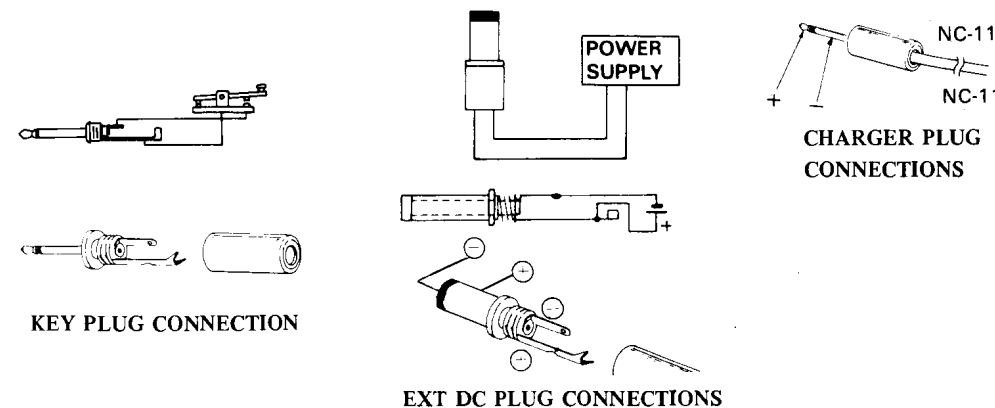

SIDE PANEL JACKS

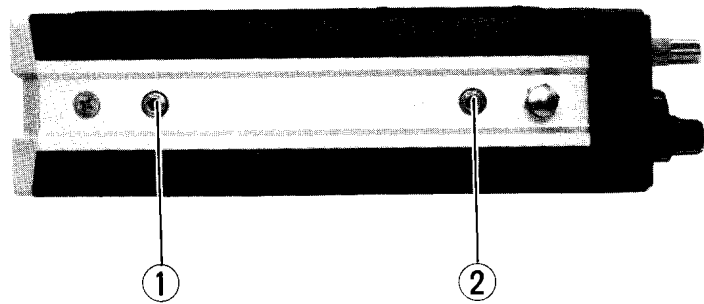

(1) STAND BY

This jack is wired in parallel with the PTT line of the microphone, allowing the use of a footswitch to activate the transmitter.

(2) EXT SP

Use this jack to connect an external speaker. The output impedance is 8 ohms.

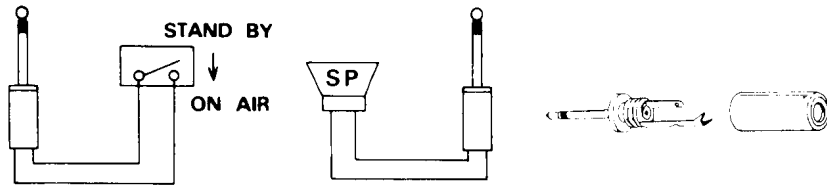

SHOULDER STRAP ATTACHMENT AND REMOVAL

ATTACHMENT

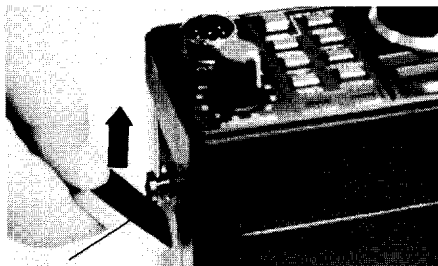

Press pin into hole, then pull up tab.

REMOVAL

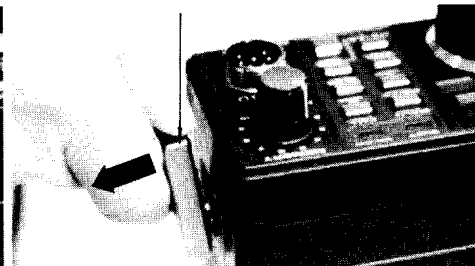

Press with thumb while lifting tab, swiveling back and forth slightly until pin disengages.

INTERNAL SWITCHES

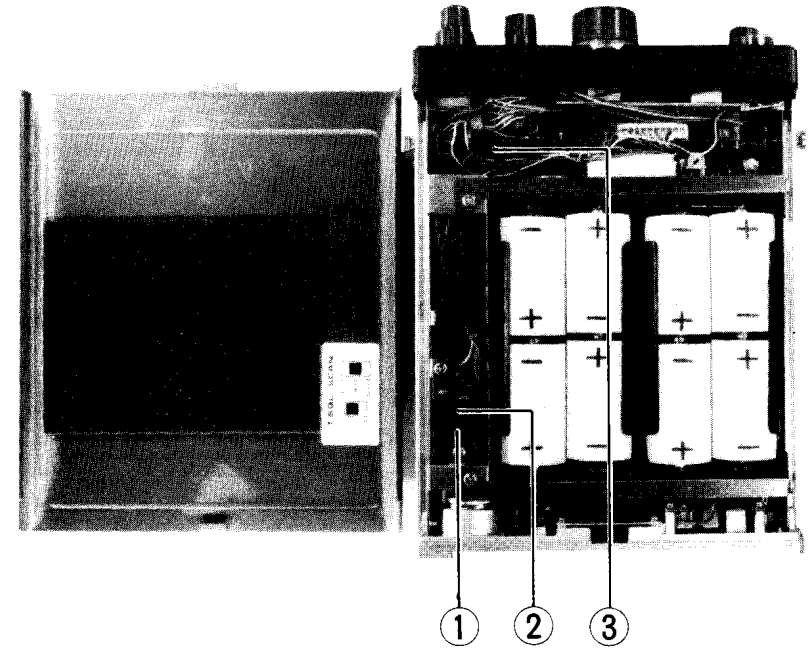

(1) T SQL

When the optional tone squelch unit is installed, this switch will place the unit in operation.

(2) SCAN

This switch selects scanning stop on a busy or clear channel, per your requirements. Manual scanning can also be selected, if desired.

(3) BACKUP

This switch activates the memory backup feature. Once the batteries are correctly installed, this switch may be turned on and left on indefinitely. See the operation section for details.

LOCK ← OPEN

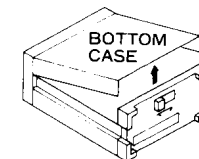
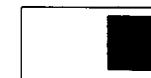

ANTENNA CONSIDERATIONS

The FT-290R is designed for use into a 50 ohm resistive load. While departures from this value are of no significant consequence, it is possible to damage the transmitter circuitry if no antenna is connected and the transmitter is activated.

For most portable use, the built-in telescoping whip antenna will provide satisfactory operation. For base station use, any of the popular beam or phased arrays will provide excellent performance, so long as they present the proper impedance to the transmitter and have been optimized for best forward gain

When an external antenna is being used, the whip antenna should be telescoped fully into the FT-290R. Conversely, when no external antenna is connected, the whip should be fully extended. Failure to observe these simple precautions will void all warranties on this unit.

BATTERY INFORMATION

The FT-290R is designed for use with eight size C Ni-Cd rechargeable cells or eight dry cells of the same size. When using alkaline cells or other dry cell types, no "dummy" battery is required, as the FT-290R will tolerate the slightly elevated voltage of these batteries as compared to Ni-Cd cells.

The install batteries, set the rear panel lever to OPEN to unlock the case. The bottom cover may then be carefully removed, exposing the battery holder. Install the eight new cells, being absolutely certain to observe the proper polarity.

WARNING

Serious damage can occur if incorrect battery polarity is used. Our warranty does not cover damage caused by incorrect polarity in the battery compartment.

If Ni-Cd cells are used, the optional NC-11B/C battery charger may be used to return the cells to a full charge. Allow the cells to discharge minimum operating voltage before recharging them. If the cells are only partially exhausted, and repeatedly recharged in this condition, they may develop a memory for this level, and not provide full discharge capability.

Ni-Cd cells suitable for use in the FT-290R are available from your Yaesu dealer. Ask also for the MMB-11 Mobile Mounting Bracket, FL-2010 Linear Amplifier, YM-49 and YM-50 microphones, and CSC-1A vinyl carrying case for the FT-290R.

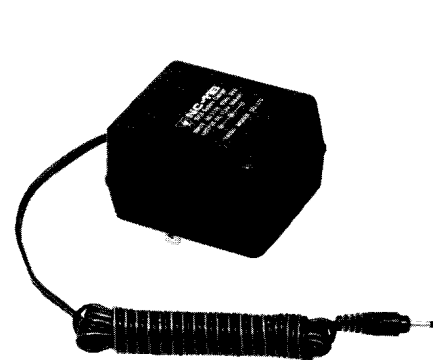

NC-11B (117V AC)



NC-11C (220-234V)



FT-290R/FL-2010/MMB-11/YM-47

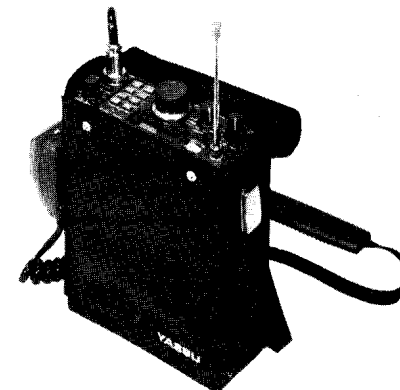

FT-290R/CSC-1A/YM-47

OPERATION

The tuning procedure for this transceiver is not complicated. However, because microcomputer circuitry is used extensively throughout the transceiver, this section should be read thoroughly, so as to understand all of the features that are made available. Note that off-frequency operation could occur without proper setting of the controls, because of the many options the operator has for frequency selection.

INITIAL CHECK

Before operating the transceiver, be certain that the necessary batteries are installed in the case, as described previously. Extend fully the built-in telescoping whip antenna, if used. If an external antenna is used, be certain that the internal whip antenna is fully nested into the FT-290R. If an external voltage source is used instead of batteries, confirm that the proper DC voltage is being applied to the rear panel jack, and that the proper polarity is used.

FREQUENCY READOUT

Frequency display is provided by a five-digit Liquid Crystal Display (LCD) system. Resolution of the last five digits of the operating frequency is provided to 0.1 kHz.

When operating on a memory channel, the letter "M" will appear on the left side of the display. The memory channel number will not be shown, as it is already shown on the selector switch labeling. The actual memorized frequency will be displayed, however.

SSB OPERATION

Preset the controls and switches as follows:

VOL	OFF (Fully counterclockwise)
SQL	Fully counterclockwise
MODE	Desired mode, USB or LSB
MEMORY	Channel 1
LAMP (Rear apron)	OFF
NB (" ")	OFF
HI/LOW (" ")	HI

Rotate the VOL switch out of the click-stop, and adjust the volume level for a comfortable audio output from the speaker. The LCD display will indicate the operating frequency. Initially (first switch-on after the memory backup battery has been installed), the display will indicate 147.000 MHz as a preset frequency; thereafter, when the transceiver is switched on, the backup feature will keep you locked onto the frequency and mode (dial or memory) last used when you switched the unit off.

The STEP switch is used to select the desired synthesizer step, 1 kHz or 100 Hz per step (SSB/CW modes). If you rotate the main tuning dial, initially the synthesizer will provide 1 kHz steps. Press the STEP button once, and you will note that the steps are now 100 Hz (0.1 kHz) each. Another pressing of the STEP button will return the selection to 1 kHz/step.

While most operation on 2 meters is on USB, there are many times (especially during satellite operation) when LSB operation is needed. Simply rotate the mode switch to LSB to select that mode. There is no passband tuning adjustment needed on this transceiver.

Rotate the main tuning dial until an SSB signal is heard. Using the 100 Hz/step mode, tune in the signal until a natural reproduction of the voice signal is obtained.

To transmit, close the microphone PTT switch, and speak at a normal level into the microphone. Release the PTT switch for receiver recovery. The microphone amplifier gain is preset in this transceiver and requires no further adjustment for normal operation.

If the station you are in contact with begins to drift, you may follow the station by activating the receiver offset tuning control (CLARIFIER). Push the CLAR button, and then rotate the main tuning dial (or push the scanning controls) until the desired frequency is reached. In the CLAR mode, the synthesizer automatically is set to the 100 Hz/step mode, and the STEP button is disabled. The clarifier leaves the transmit frequency unchanged.

Push the CLAR button again to return to normal operation with the clarifier off. If you switch the clarifier on again, the receiver will **not** return to the last offset frequency, but rather will initiate on the current operating frequency.

For satellite operation, it **is** possible for the transmit frequency to be varied while transmitting.

If pulse-type noise is encountered, the rear apron NB (Noise Blanker) switch may be activated. While no noise blanker can be expected to eliminate all types of atmospheric and man-made noise encountered in day-to-day operation, the FT-290R noise blanker should be quite helpful in reducing interference caused by pulse noise such as that produced by automobile ignition systems.

To reduce power for local communication, place the HI/LOW power switch in the LOW position. In this position, the PEP output power is approximately 500 mW. Battery consumption will be greatly reduced by using the low power position whenever possible.

FM OPERATION

Preset the controls and switches as described for SSB operation, but set the MODE switch to FM/SIMP.

In the FM mode, the synthesizer steps provided are 5 kHz and 10 kHz per step (the clarifier steps are still 100 Hz/step). When you are changing modes from SSB to FM, and were last operating on other than a 5 kHz or 10 kHz step, the microprocessor will automatically move you to the next higher or lower 5 kHz or 10 kHz step upon the first click of the main tuning dial (or first stepping of the scanner).

Rotate the main tuning dial (or operate the scanning controls) until the desired frequency is reached. To transmit, close the PTT switch, and speak into the microphone in a normal voice. Release the PTT switch for receiver recovery.

For repeater operation, selection of the standard ± 600 kHz splits is provided on the front panel. For -600 kHz shift, set the MODE switch to FM/-, and for $+600$ kHz shift, select FM/+. This selection can be made either during main dial or memory operation.

For operation on odd splits, use a combination of the memory system and the main tuning dial. First, store the desired receive frequency in any memory channel. Now use the main dial to select the desired transmit frequency. Next push the yellow F and S buttons. You will now be receiving on the memory channel just programmed. When you close the PTT switch, you will be transmitting on the main dial frequency. If you desire to listen on several memory channels, the memory channel selector may be rotated as desired.

The front panel CALL switch activates a manual-length 1800 Hz tone for repeater access. When this button is pushed, the transmitter is activated and the access tone is superimposed on the transmit signal.

Rotate the SQL (Squelch) control fully counterclockwise. Now turn the VOL control out of the click-stop to turn the transceiver on. Advance the volume control for a comfortable listening level.

When the channel is clear, adjust the SQL control so the background noise just disappears. This threshold point is the point of maximum sensitivity, and the squelch control should not be advanced beyond this point too far, or the squelch will not respond to weak signals.

CW OPERATION

- (1) The synthesizer steps selected in the CW mode are identical to those used for SSB operation.
- (2) Connect a key to the rear panel KEY jack, using a miniature phone plug. The key-up voltage is 7V, while the key-down current is 0.3mA, so most electronic keyers that close completely to ground will work well with the FT-290R.
- (3) Set the MODE switch to CW.
- (4) Close the PTT switch on the microphone to switch to the transmit mode. If desired, a footswitch may be used with the FT-290R. The STAND BY jack, located on the side of the transceiver, is wired in parallel with the PTT line on the microphone. This may be used in situations where the microphone is not the most efficient means of activating the transmitter.
- (5) The clarifier may be used for following unstable signals. The clarifier allows offset tuning in 100 Hz steps away from the transmit frequency. See the section on clarifier operation for details.

CLARIFIER OPERATION

Offset tuning is provided on receive, for tracking of unstable or Doppler-shifted signals. The clarifier may be used either on VFO frequencies or memory frequencies.

To activate the clarifier, push the CLAR button once. The letters "CLAR" will appear on the digital display. Now, tune the receiver as needed to follow the unstable signal. The synthesizer automatically programs 100 Hz steps for clarifier operation. A frequency shift of up to 10 kHz can be accomplished by using the clarifier.

When you close the PTT switch, the digital display will revert to the frequency programmed **before** the clarifier was switched on. In other words, your transmit frequency has remained unchanged, while your receive frequency has been varied.

A second press of the CLAR button will cancel clarifier operation. If the CLAR button is then pressed again, switching the clarifier back on, the clarifier is zeroed to the original operating frequency (before any offset), **not** to the offset frequency tuned previously.

THE UP/DWN CONTROLS ON THE MICROPHONE MAY BE USED FOR SCANNING DURING CLARIFIER OPERATION.

VFO SELECTION

Two VFOs are available on the FT-290R for split frequency operation. The VFO selector button is the largest of the eight mode selector buttons on the front panel of the FT-290R. This switch is a push-push type, not the momentary type used for the other mode selector buttons.

For VFO B operation, push the VFO button once; the switch will hold inward, and the desired frequency may then be dialed up. Be certain, of course, that you are in the DIAL mode. To return to VFO A, simply push the VFO button again to release the switch.

It is not possible to receive on one VFO while transmitting on another. For frequency splits of 10 kHz or less, use the clarifier to achieve this function. Otherwise, use the MEMORY SPLIT mode described elsewhere in this manual.

NOTE REGARDING BACKUP OPERATION

When a backup battery or main batteries are first installed in the FT-290R (after service or replacement), it is necessary to reset the microcomputer properly. Failure to follow a simple sequence of steps may cause erratic operation.

- (1) Set both the VOL and memory backup switches (memory backup switch is located inside the cabinet, as shown on page 11) to OFF.
- (2) Replace the memory backup battery and main batteries (if removed).
- (3) Turn the VOL control out of the click-stop, turning the transceiver ON.
- (4) Now turn the backup switch to ON. The CPU is now reset, and the backup switch may be left on indefinitely, owing to the very low current drain in the backup mode.

MEMORY OPERATION

Ten memory channels are available for storage and recall of favorite operating frequencies. The procedure for entry and recall of memory channels is extremely simple.

Push the DIAL switch for normal tuning, using the main tuning dial. When you have found a frequency you wish to store in memory (for example 146.520 MHz), rotate the MEMORY switch to 1 (channel 1) and push the M (memory store) button. If you wish to store 146.490 MHz in channel 2, rotate the main dial to that frequency, rotate the MEMORY switch to channel 2, and push M, and so forth. This procedure may be repeated for all 10 memory channels.

To recall these frequencies, push the MR button (memory recall) and rotate the MEMORY switch to select the desired channel. One push of the M button will keep you on memory recall operation until the DIAL button is pushed again to return you to main dial tuning. Note that there is no formal erasure procedure for memory channels. When you push the M button, the previous frequency stored in that position will be erased. Until a frequency is programmed into a memory channel (from initial switch on of the transceiver), 147.000 MHz will be preset in all memory channels.

SCANNER OPERATION

The UP/DOWN scanning controls on the microphone may be used to control the operating frequency.

When in the DIAL mode, one push of the UP button will cause the frequency to advance upward by one step of the synthesizer (the step size being programmed by the mode switch and the STEP button). If you hold the UP button down for more than 1/2 second, the scanner will become engaged, and you will begin scanning up the band. Push the UP or DN button or the PTT switch to halt the scan.

Scanning toward a lower frequency is achieved by using the same procedure, only using the DN button on the microphone.

To scan only the memory channels, rotate the MEMORY selector to either of the MS (Memory Scan) positions, and press the MR button. Now, when you push and hold the UP or DN button, the scanner will search the memory channels only. Manual halting of the scan is accomplished by pushing the UP, DN, or PTT switches as before.

Inside the case of the radio, the BUSY-MAN-CLEAR switch allows selection of one of three scan halt modes. In the MAN (Manual) position, scanning is halted as discussed above. If the BUSY position is selected (see Page 11), the scanner will search until a busy channel (one occupied by a station strong enough to break the main squelch) is received. The scan will then pause on that frequency for five seconds. If you choose to stay on that frequency, press one of the scan control buttons or the PTT switch. While in the PAUSE mode, the decimal point farthest to the right will blink; when you push a button to halt the resumption of the scan, the blinking will stop.

To scan for a clear channel (one where the squelch does not open), set the BUSY-MAN-CLEAR switch to CLEAR. The scan will halt, and the decimal point will blink, as in the previous section. Press the UP, DN, or PTT switch to cancel the pause/resume feature and hold on the frequency you stopped at.

Memory scan halting follows the same format as main dial scanning.

PRIORITY CHANNEL OPERATION

Priority channel operation uses a combination of the main dial VFO and the memory. It can be used in conjunction to the automatic scan stop feature of the microprocessor, if desired. The steps for priority channel operation are detailed below.

- (1) Program into memory the desired priority channel. Do not **recall** the channel at this time.
- (2) Dial up a basic operating frequency on the main VFO. This will be your main operation channel during priority channel operation.
- (3) Set the BUSY-MAN-CLEAR switch to BUSY or CLEAR, as desired.
- (4) Now push the yellow F button, followed immediately by a press of the MR/PRI button. The letter "P" will appear on the digital display, signifying priority channel operation. The display will then show the VFO frequency, with a flash every five seconds to the memory channel being checked for activity. When the memory channel is busy or clear (depending on your instructions), the scanner will halt on the memory channel. The pause/restart feature does not function in this mode; to restart, simply press the F and MR/PRI buttons again.
- (5) If the scan stop switch is set to the MAN position, the CPU will have no instructions for halting the scan. Simply press the DIAL or MR button to select the desired channel under this mode of operation. If you hit the PTT switch during manual priority channel operation, the checking of the priority channel will be delayed by five seconds.

MEMORY SPLIT OPERATION

The memory split operation mode is useful for covering unusual repeater splits or other occasions where the receive frequency may be fixed, but the transmit frequency is variable. In this mode, you receive on a memory channel, while transmitting on the VFO.

- (1) Store the desired receive frequency into a memory channel.
- (2) Dial up the desired transmit frequency on the main dial.
- (3) Now press the yellow F and DIAL/S buttons. You will be receiving on the memory, while transmitting on the VFO.
- (4) For transmitting purposes, either VFO A or VFO B may be used. Set the VFO selector as needed.

Scan by Don
hamdirectory.info
www.hamdirectory.info

CIRCUIT DESCRIPTION

The block diagram and circuit description to follow will provide you with a better understanding of this transceiver. Please refer to the block and schematic diagrams for specific circuit details.

RECEIVER

The RF signal from the antenna jack is applied to a lowpass filter and diode antenna switch, consisting of D_{2024} and D_{2025} (MI301) and is then fed to an RF amplifier, Q_{1001} (3SK59Y), where the signal is amplified with excellent rejection of cross modulation and intermodulation. The amplified signal is then fed through three sections of Auto-tuning filter to reject unwanted signals which may cause intermodulation at the 1st Mixer, Q_{1002} (3SK51-03). Here, the signal is mixed with a local signal delivered from the local oscillator buffer, resulting in a 10.81 MHz first IF signal.

The first IF signal passes through a pair of monolithic crystal filters, XF_{1001} (108M30B), which have bandwidths of ± 15 kHz. It is then amplified by Q_{1003} (3SK73Y), which acts as a switch, driven by the NB (noise blanker) circuit. The amplified signal from Q_{1003} is fed to IF amplifiers for FM or SSB/CW.

A portion of the RF signal from monolithic crystal filter XF_{1001} is fed to a noise blanker amplifier circuit, consisting of Q_{1004} (2SC535A), Q_{1005} (2SC1583) and Q_{1006} (2SC2786L), where the signal is amplified to a level sufficient to drive the noise blanker rectifier and noise blanker AGC circuits.

When the carrier of a noise-free modulated signal is received, the signal at the noise amplifier is rectified by D_{1005} and D_{1006} (1S188FM), producing a DC voltage. The DC voltage is amplified by Q_{1007} (2SC2603E), which charges C_{1042} for AGC purposes. The AGC voltage is used to control the gain of Q_{1005} and Q_{1006} .

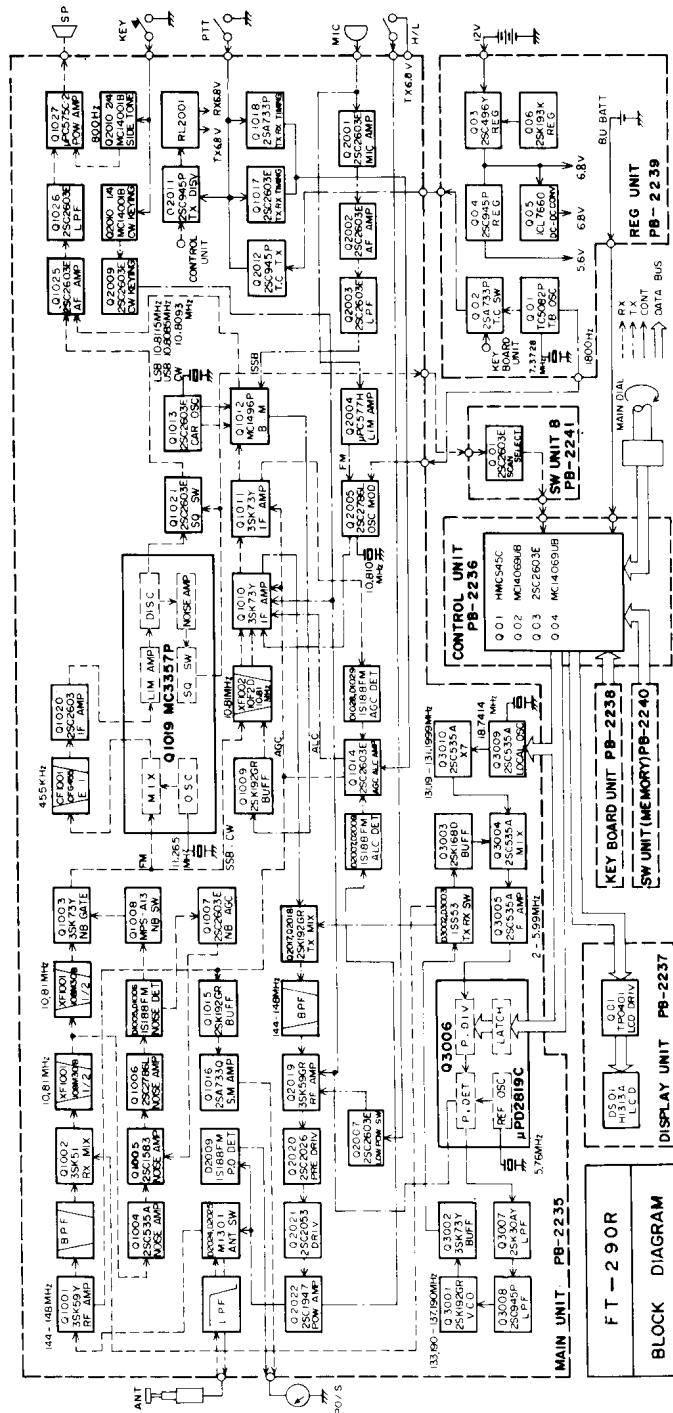

Scanned by IW1AXR
 Downloaded by
 Amateur Radio Directory

When a pulse-type noise is received, D_{1005} and D_{1006} rectify the noise, and it is then fed through D_{1042} (1S188FM) to a DC amplifier, Q_{1008} (MPSA13), which drives gate 2 of Q_{1003} .

The FM mode signal is fed to the mixer section of Q_{1019} (MC3357P), where the signal is mixed with a 11.265 MHz local signal, oscillated by its local oscillator section, and fed through a ceramic filter, CF_{1001} , which has a ± 7.5 kHz bandwidth. It is then amplified by IF amplifier Q_{1020} (2SC2603E), and fed back to the IF amplifier/limiter section of Q_{1019} , where the IF signal is amplified and any amplitude modulation in the signal is rejected. Next, the signal is delivered to the discriminator section, which produces an audio output in response to a corresponding shift in the 455 kHz IF signal.

When no carrier is present in the 455 kHz IF, the high frequency noise at the discriminator output, which passes through a bandpass filter, is amplified by the noise amplifier in Q_{1019} and detected by D_{1032} (1S188FM), producing a DC voltage. This voltage activates a switch in Q_{1019} which grounds the base of Q_{1021} (2SC2603E), to turn off the AF output from the discriminator to the AF amplifier.

When a carrier is present in the 455 kHz IF, the noise is removed from the discriminator and the audio amplifier then returns to normal operation. The squelch threshold sensitivity is set by VR_{1b} .

SSB and CW mode IF signals from Q_{1003} are passed through a crystal filter, XF_{1002} , which has a very high shape factor, to reduce signals on adjacent frequencies. The filtered SSB signal is amplified by Q_{1010} and Q_{1011} (3SK73Y), and then fed to the balanced demodulator, Q_{1012} (MC1496P), where a carrier signal is applied from carrier oscillator Q_{1013} (2SC2603E), resulting in an AF signal, which is then fed to the AF amplifier.

The AF amplifier consists of Q_{1025} , Q_{1026} (2SC2603E) and Q_{1027} (μ PC575C-2). The AF signal from the FM discriminator and the balanced demodulator are amplified by Q_{1025} , and fed to active lowpass filter Q_{1026} , where the AF signal above 3 kHz is cut off. The AF signal is then delivered to AF power amplifier Q_{1027} , providing approximately 1 watt of audio output to the speaker.

S-METER AND AGC CIRCUITS

A portion of the IF signal from Q_{1011} is rectified by D_{1028} and D_{1029} (1S188FM) and amplified by Q_{1014} (2SC2603E). This amplified DC voltage controls gate 2 of MOS FET's in the IF amplifier. A portion of the AGC signal is buffered by Q_{1015} (2SK192GR), and fed to the S-meter amplifier, Q_{1016} (2SA733Q), providing a DC voltage for the S-meter deflection.

TRANSMITTER

The discussion of the signal flow on transmit will be made on a mode-by-mode basis.

SSB

The audio input signal from the microphone is amplified by Q_{2001} and Q_{2002} (2SC2603E), and then delivered to an active lowpass filter, Q_{2003} (2SC2603E), where the unwanted frequency spectrum above 3 kHz is cut off. This amplified speech signal is fed to balanced modulator Q_{1012} (MC1496P), where the audio signal modulates the 10.81 MHz carrier signal delivered from the carrier oscillator, Q_{1013} (2SC2603E), resulting in a 10.81 MHz double-sideband signal. The DSB signal is amplified by a buffer, Q_{1009} (2SK192GR), and delivered to crystal filter XF_{1002} (10F2D), where the unwanted sideband is sliced out, resulting in a single sideband signal. This SSB signal is then amplified by Q_{1010} (3SK73Y), and delivered to a mixer, Q_{2017} and Q_{2018} (2SK192GR), where the SSB signal is mixed with a local signal from the PLL local oscillator buffer, Q_{3002} (3SK73Y), resulting in a 144 – 148 MHz SSB signal.

The SSB signal passes through an auto-tuning filter consisting of T_{1002} – T_{1005} and varactor diode D_{1018} – D_{1021} , where the resonant frequency is tuned exactly to the transmitting frequency, thus minimizing spurious radiation. The signal is then amplified by four stages of straight amplifier consisting of Q_{2019} (3SK59GR), Q_{2020} (2SC2026), Q_{2021} (2SC2053) and Q_{2022} (2SC1947), providing a power output of 2.5 watts over the range of 144 – 148 MHz.

Finally, this signal passes through an RF diode switch and lowpass filter to the ANT connector and built-in telescoping antenna.

FM

The speech signal from the microphone is amplified and limited in amplitude by Q_{2004} (μ PC577H). It is then fed through a lowpass filter to eliminate harmonics above the speech range, caused by clipping. Next it goes to a frequency modulator consisting of Q_{2005} (2SC2786L) and D_{1005} (1SV68), where the 10.81 MHz oscillating frequency is modulated, corresponding to the AF signal from Q_{2004} . Thus, an FM signal of 10.81 MHz is produced. This signal is then delivered to the IF amplifier, Q_{1010} , and the signal path then becomes identical to that of the SSB signal.

CW

For CW, the 10.8093 MHz carrier is generated by Q_{1013} (2SC2603E), and delivered to the balanced modulator Q_{1012} . The key line is connected to keying control IC (quad NOR gate) Q_{2010} (MC14001B), which drives keying switch Q_{2009} (2SC2603E) to control the DC bias voltage sent to the source of Q_{1010} and Q_{2019} . As a result, the RF signal is turned on and off.

From this point, the signal path is identical to that of the SSB signal.

The control signal from Q_{2010} is also fed to the sidetone oscillator consisting of two sections of gate circuits in Q_{2010} , which oscillate sidetones of about 800 Hz and the sidetone signal is then delivered to the AF amplifier.

Tone Burst Circuit

When the T. CALL switch is pressed, the base of Q_{4002} (2SA733P) is grounded and a DC voltage is applied to tone burst oscillator Q_{4001} (TC5082P) to generate a 1800 (1750) Hz tone signal. The tone is superimposed on the transmit signal as long as the switch is held.

PLL Circuit

The PLL circuit is composed of a reference crystal oscillator, programmable divider, VCO (voltage controlled oscillator), PLL local mixer, PLL local oscillator, lowpass filter and phase comparator. The PLL produces the local signal for the receiver and transmitter stages, using a synthesis scheme which utilizes 100 Hz steps throughout the range.

The VCO oscillator, Q_{3001} (2SK192GR), generates a signal at 133.190 – 137.190 MHz. The oscillator frequency is controlled by varactor diode D_{3001} (1T25), which varies the capacitance of the oscillator tuned circuit in accordance with the control voltage supplied from an active lowpass filter consisting of Q_{3007} (2SK30AY), and Q_{3008} (2SC945P).

The output signal from Q_{3001} is amplified by buffer Q_{3002} (3SK73Y) and delivered to TX mixer Q_{2017}/Q_{2018} and RX mixer Q_{1002} . A portion of the local signal from Q_{3002} is fed through the buffer amplifier Q_{3003} (2SC535A) to the PLL local mixer, Q_{3004} (2SC535A), where the signal is mixed with a PLL local signal generated by Q_{3009} (2SC535A) and multiplied 7 times by Q_{3010} (2SC535A). This local signal varies from 131.9 – 131.999 MHz as a result of the control voltage from the CONTROL Unit. Thus, a PLL IF frequency of 2.00 – 5.99 MHz is obtained. The frequency varies at the PLL local signal, providing movement in 10 kHz steps.

This PLL IF signal is then amplified by Q₃₀₀₅ (2SC535A), and fed to Q₃₀₀₆ (μ PD2819C), where the programmable divider section divides the IF signal by 200 – 599, depending on the data from the 4-bit microprocessor in the CONTROL Unit.

Next, this signal is delivered to the phase comparator section, where the phase of divided IF signal is compared with its reference signal of 10 kHz. This reference signal is generated and divided by the reference oscillator/reference signal divider section in Q₃₀₀₆. Any difference in phase of the divided PLL IF signal with that of the PLL reference signal is converted into an error-signal with a different bandwidth of pulse. This signal is then fed to active lowpass filters Q₃₀₀₇ and Q₃₀₀₈, resulting in a VCO correction voltage.

When the PLL is unlocked, an unlock signal at pin 7 of Q₃₀₀₆ drops to a low level, cutting off the bias voltage at Q₂₀₀₉ (2SC2603E), and thus turning off Q₂₀₁₉ (3SK59GR) and Q₁₀₁₀ (3SK73Y).

ALC Circuit

A portion of the RF signal is coupled through C₂₀₃₇ to a rectifier circuit consisting of D₂₀₀₇ and D₂₀₀₈ (1S188FM), producing a DC voltage. The DC voltage is amplified by DC amplifier Q₁₀₁₄ (2SC3603E) and fed to gate 2 of Q₁₀₁₀ to control its gain, thus preventing overdrive. The ALC level is adjusted by VR₂₀₀₃ for proper gain at Q₁₀₁₀.

Power Control Circuit

When the HI/LOW switch is set to the low position and the base of Q₂₀₀₇ (2SC2603E) to a high level, the voltage at the corrector becomes low, thus reducing the voltage at gate 2 of Q₂₀₁₉ (3SK59GR) and the amplitude of the RF signal.

PLL Control Circuit

The PLL Control Unit features a low current drain 4-bit microprocessor chip, Q₅₀₀₁ (HD44820A-18), which processes data for controlling the operating frequency, UP/DOWN scanning, priority channel, memory selection, etc. The CPU processes input data by means of the main dial or other control switches in accordance with the program stored in a ROM for control of the PLL frequency, indication of the operating frequency, or memory channels on digital display.

MAINTENANCE AND ALIGNMENT

This equipment has been carefully aligned and tested at the factory prior to shipment. If the instrument is not abused, it should not require other than the usual attention given to electronic equipment.

Service or replacement of a major component may require considerable realignment. Under no circumstances, though, should realignment be attempted unless the operation of the transceiver is fully understood, the malfunction has been carefully analyzed, and the fault has definitely been traced to misalignment rather than part failure. Service work must only be performed by experienced personnel using the proper test equipment.

Never align this transceiver without having a 50 ohm dummy load connected to the antenna jack. Troubleshooting using an antenna can result in misleading indications on the test equipment.

EQUIPMENT REQUIRED

1. RF Signal Generator: Hewlett-Packard Model 8640B or equivalent with one volt output at 50 ohms and frequency coverage to 150 MHz.
2. Vacuum Tube Voltmeter (VTVM): Hewlett-Packard Model 410B or equivalent.
3. Dummy Load/Wattmeter: Yaesu YP-150Z or equivalent.
4. AF Signal Generator: Hewlett-Packard Model 200AB or equivalent.
5. IF Sweep Generator: capable of output at 10.81 MHz.
6. RF Sweep Generator: capable of output at 143 – 149 MHz.
7. Oscilloscope: Hewlett-Packard Model 1740A or equivalent.
8. FM Deviation Meter: coverage to 144 – 148 MHz.
9. Precision Frequency Counter: Yaesu Model YC-500E or equivalent with resolution to 0.01 kHz and frequency coverage to 150 MHz.

Scan by Don
hamdirectory.info
www.hamdirectory.info

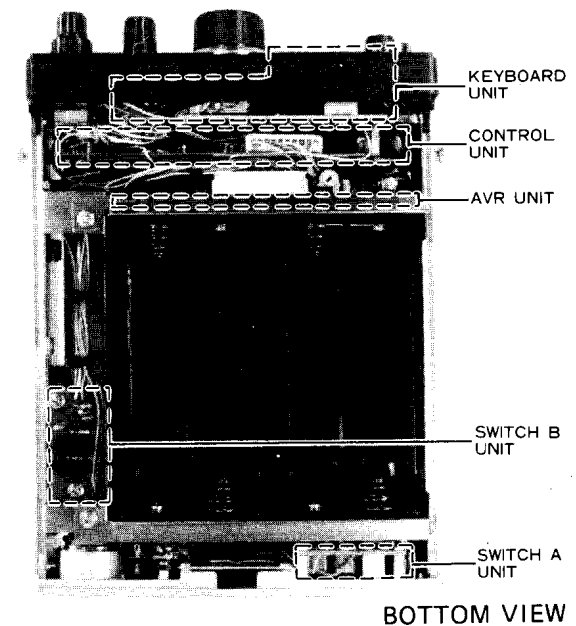
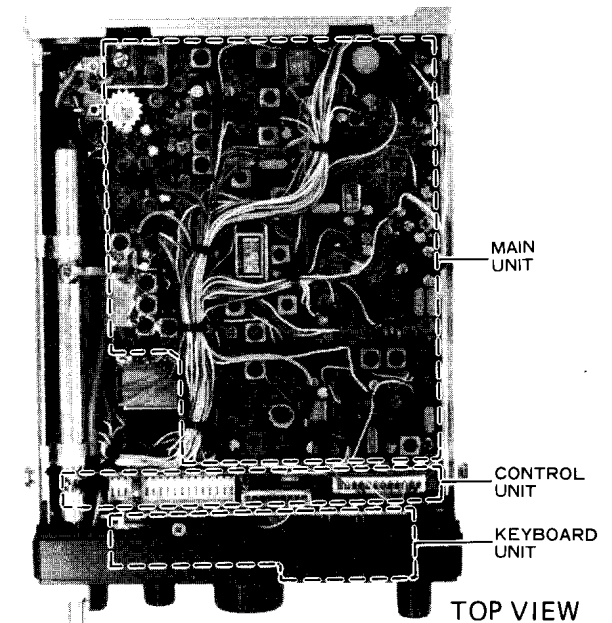

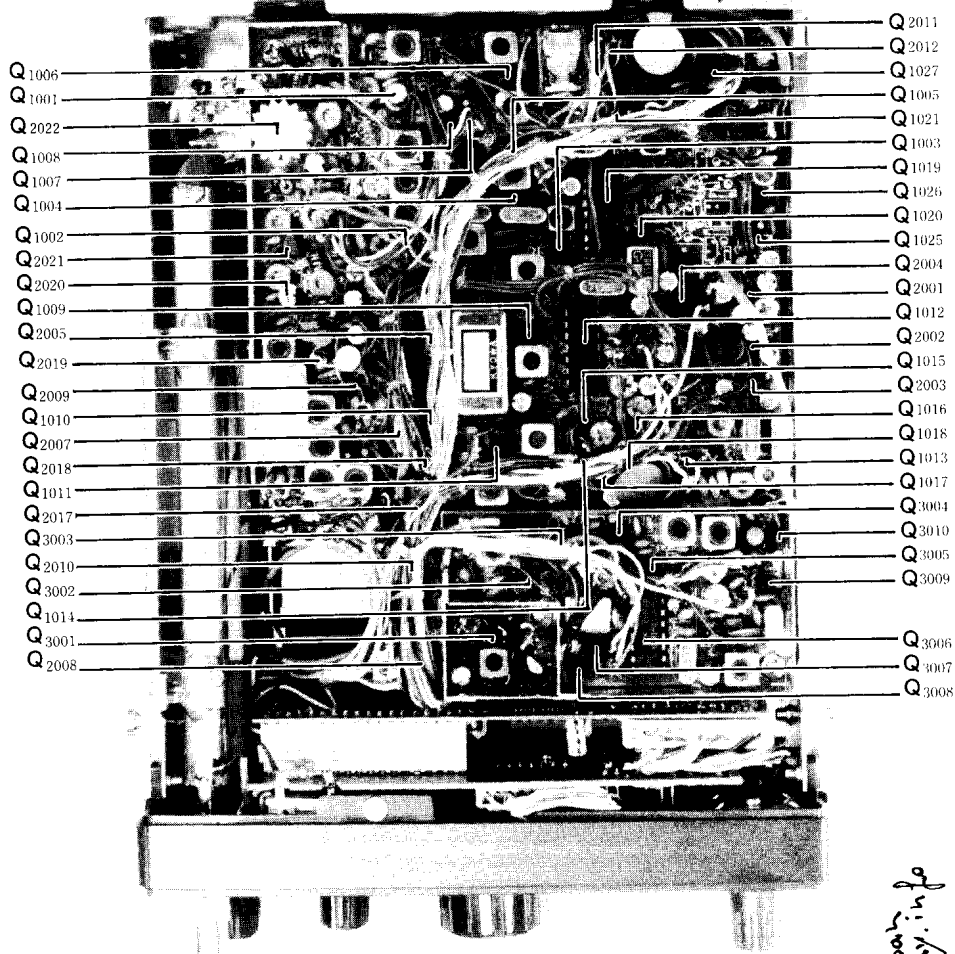

Q1006
Q1001
Q2022
Q1008
Q1007
Q1004
Q1002
Q2021
Q2020
Q1009
Q2005
Q2019
Q2009
Q1010
Q2007
Q2018
Q1011
Q2017
Q3003
Q2010
Q3002
Q1014
Q3001
Q2008

Q2011
Q2012
Q1027
Q1005
Q1021
Q1003
Q1019
Q1026
Q1020
Q1025
Q2004
Q2001
Q1012
Q2002
Q1015
Q2003
Q1016
Q1018
Q1013
Q1017
Q3004
Q3010
Q3005
Q3009
Q3006
Q3007
Q3008

Scanned by Dan
hamdirectory.info
www.hamdirectory.info

Scanned by IW1AXR
Downloaded by
Amateur Radio Directory

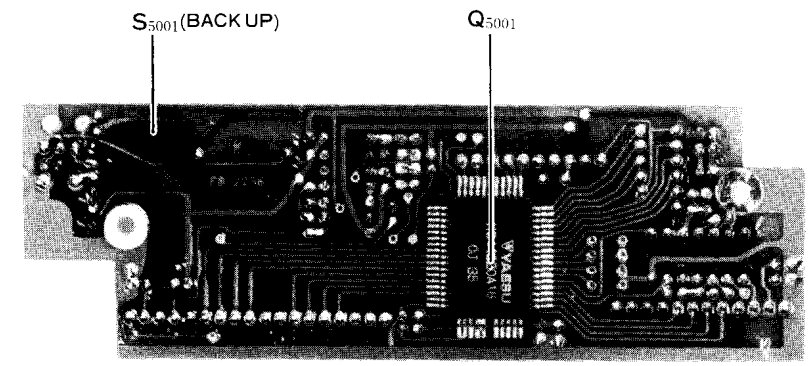
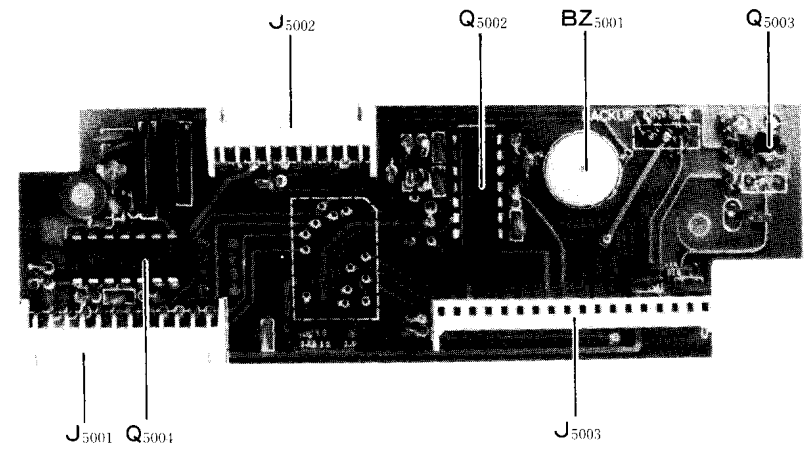
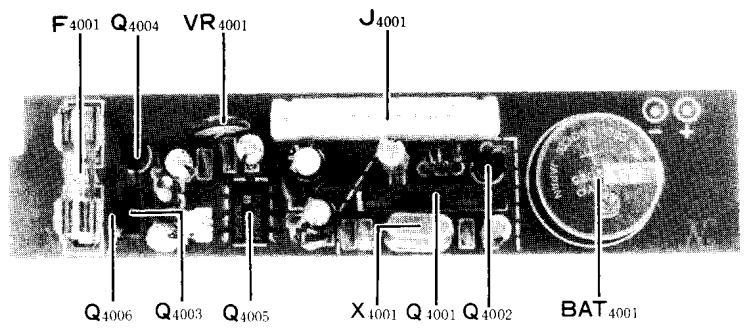

PLL CIRCUIT ALIGNMENT

The PLL circuit alignment procedure is very critical because of the ambient temperature change. This alignment must be performed under temperature conditions between the range of 15 to 30°C. If your transceiver is exposed to temperatures beyond this range for an extended period of time, the transceiver should sit in the proper alignment temperature for at least two hours before you start the following alignment procedure.

1. PLL Local, IF Alignment

- (a) Set the MODE switch to the FM position, and adjust the frequency to 146.000.0 MHz (model B; 145.000.0 MHz).
- (b) Set TC₃₀₀₁ to the center position, and connect an oscilloscope to pin 14 of Q₃₀₀₆.
- (c) Adjust the cores of T₃₀₀₁ – T₃₀₀₃ for maximum amplitude on the oscilloscope.

2. VCV Line Adjustment

- (a) Tune the transceiver to 146.000.0 MHz (model B: 145.000.0 MHz), and connect a DC voltmeter to R₃₀₁₄.
- (b) Adjust TC₃₀₀₁ for a reading of 3.5 volts on the meter.

3. PLL Local Frequency Adjustment

- (a) Set the MODE switch to FM and tune the transceiver to 146.000.0 MHz (model B: 145.000.0 MHz). Preset VR₃₀₀₁ and VR₃₀₀₂ to the center position.
- (b) Connect a frequency counter to the cathode of D₃₀₀₂ or D₃₀₀₃.
- (c) Adjust the core of L₃₀₀₇ for the frequency of 135.190.0 MHz (model B: 134.190.0 MHz).
- (d) Now turn the CLAR switch on, and rotate the main knob one click counterclockwise (1 step).
- (e) Adjust VR₃₀₀₁ and VR₃₀₀₂ for a frequency of 135.189.9 MHz (model B: 134.189.9 MHz).
- (f) Repeat the alignment from step (c) to (e) a few times to be sure the proper frequency is obtained.

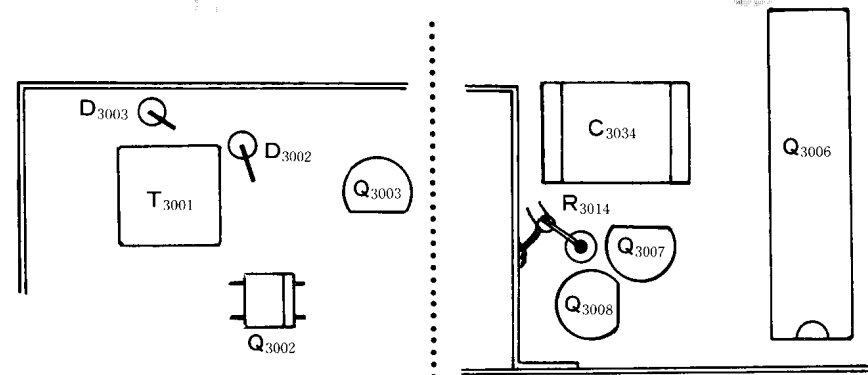
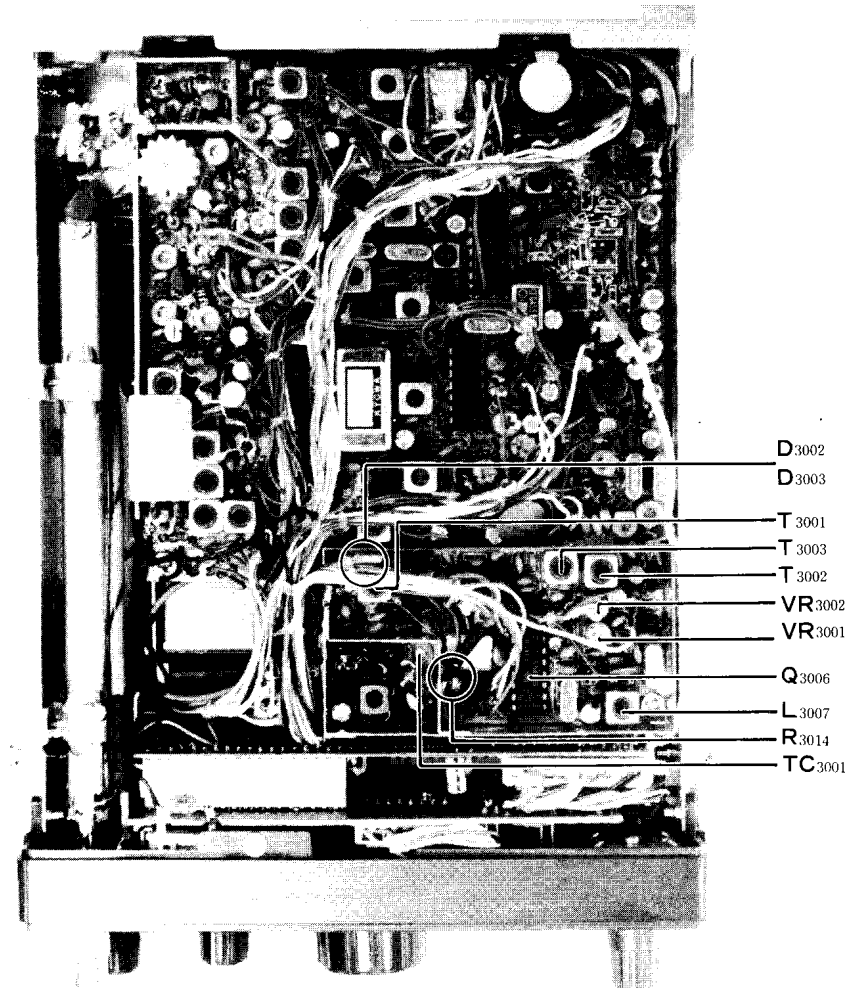

PLL SECTION ALIGNMENT POINTS

RECEIVER ALIGNMENT

1. First IF Alignment

- Set the MODE switch to FM.
- Connect a sweep generator output to gate 1 of Q_{1002} and set the frequency of the sweep generator to 10.81 MHz.
Connect an oscilloscope, through a detector, to pin 16 of Q_{1019} .
- Adjust the cores of T_{1005} , T_{1006} and T_{1014} until the scope pattern illustrated in Figure 1 is obtained.

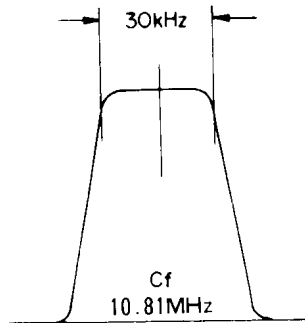

Figure 1

2. FM Discriminator Alignment

- Set the MODE switch to FM and rotate the SQL control fully counter-clockwise.
- Connect an audio voltmeter to the speaker terminal.
- Set the VOL control to the center position, and adjust the core of T_{1013} for a maximum reading on the meter.

3. SSB/CW IF Alignment

- Set the MODE switch to CW and the frequency to 146 MHz (model B: 145 MHz).
- Connect an RF signal generator to the ANT jack and set the output level and frequency to 15 dB μ at 146 MHz (model B: 145 MHz).
- Adjust the cores of T_{1006} , T_{1010} and T_{1011} for maximum reading on the S-meter.

4. RF Coil Alignment

- Set the output level and frequency of the generator to 10 dB μ at 146 MHz (model B: 145 MHz).
- Set the receiver frequency to 146 MHz (model B: 145 MHz), and adjust the cores of $T_{1001} - T_{1004}$ for maximum deflection on the S-meter.

5. S-meter Alignment

- Set the MODE switch to USB or LSB and preset VR_{1001} to the center position.
- Apply a 15 dB μ signal from the signal generator, and adjust VR_{1003} for a reading of S9 on the S-meter.
- Now remove the signal from the signal generator, and adjust VR_{1002} so the S-meter indicates exactly 0.
- Repeat steps (b) and (c) a few times to obtain the proper S-meter deflection.

6. N.B. Alignment

- Set the MODE switch to CW and apply a 5 dB μ signal from the signal generator.
- Connect the \oplus lead of a DC voltmeter to the cathode of D_{1006} and the \ominus lead to the -6.8 volts line.
- Adjust the cores of $T_{1007} - T_{1009}$ for maximum deflection on the voltmeter.
- Next, reduce the amplitude of the signal generator to 0 dB μ , and check the voltmeter, which should show approximately 0.03 volts.

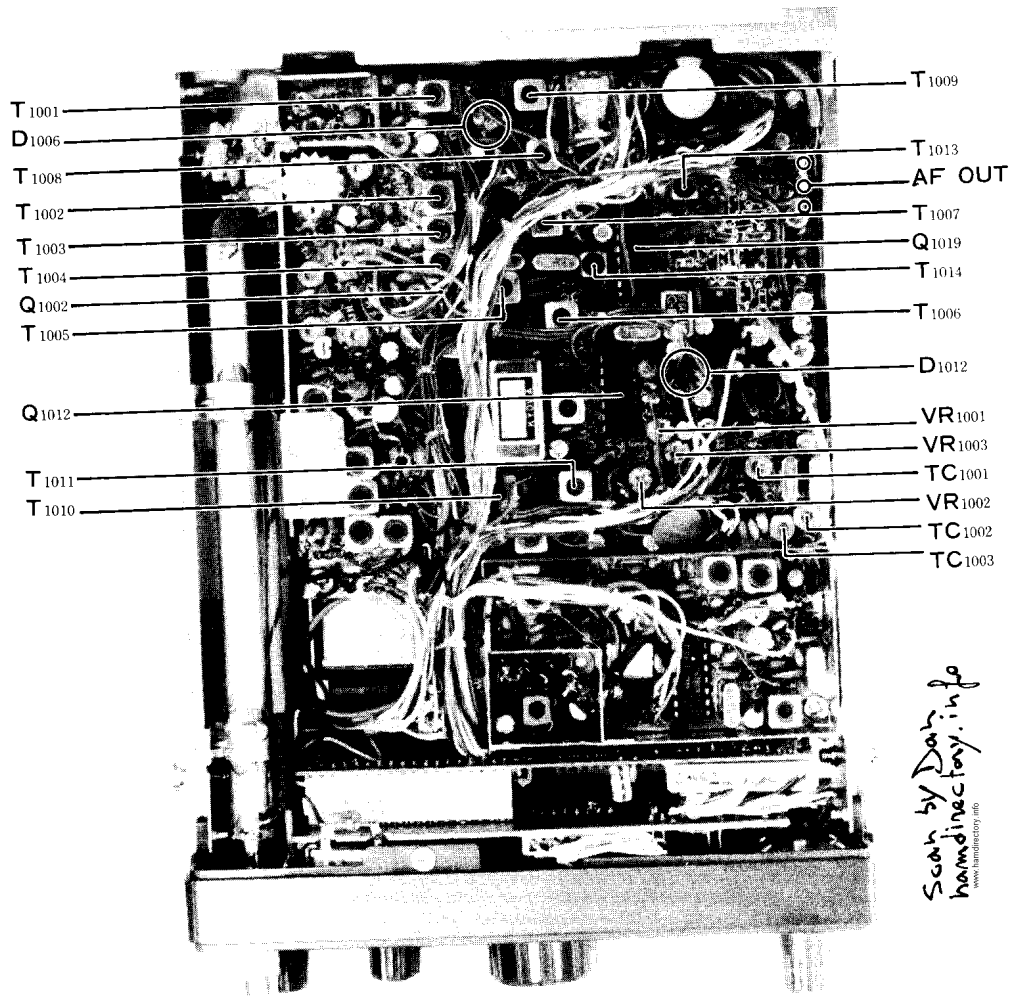

Scan by Dan hamdirectory.info

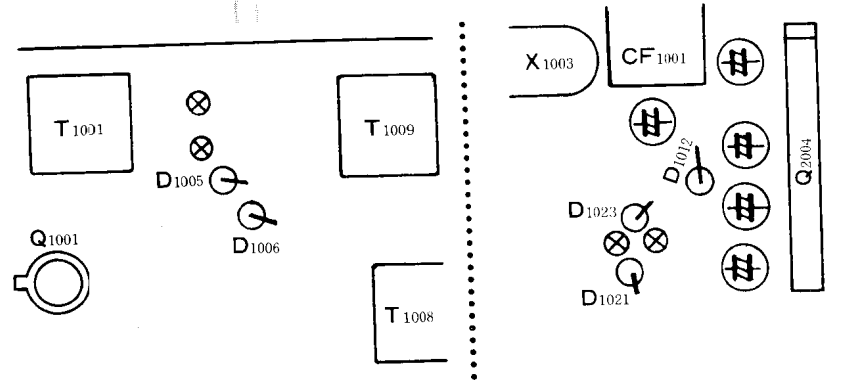
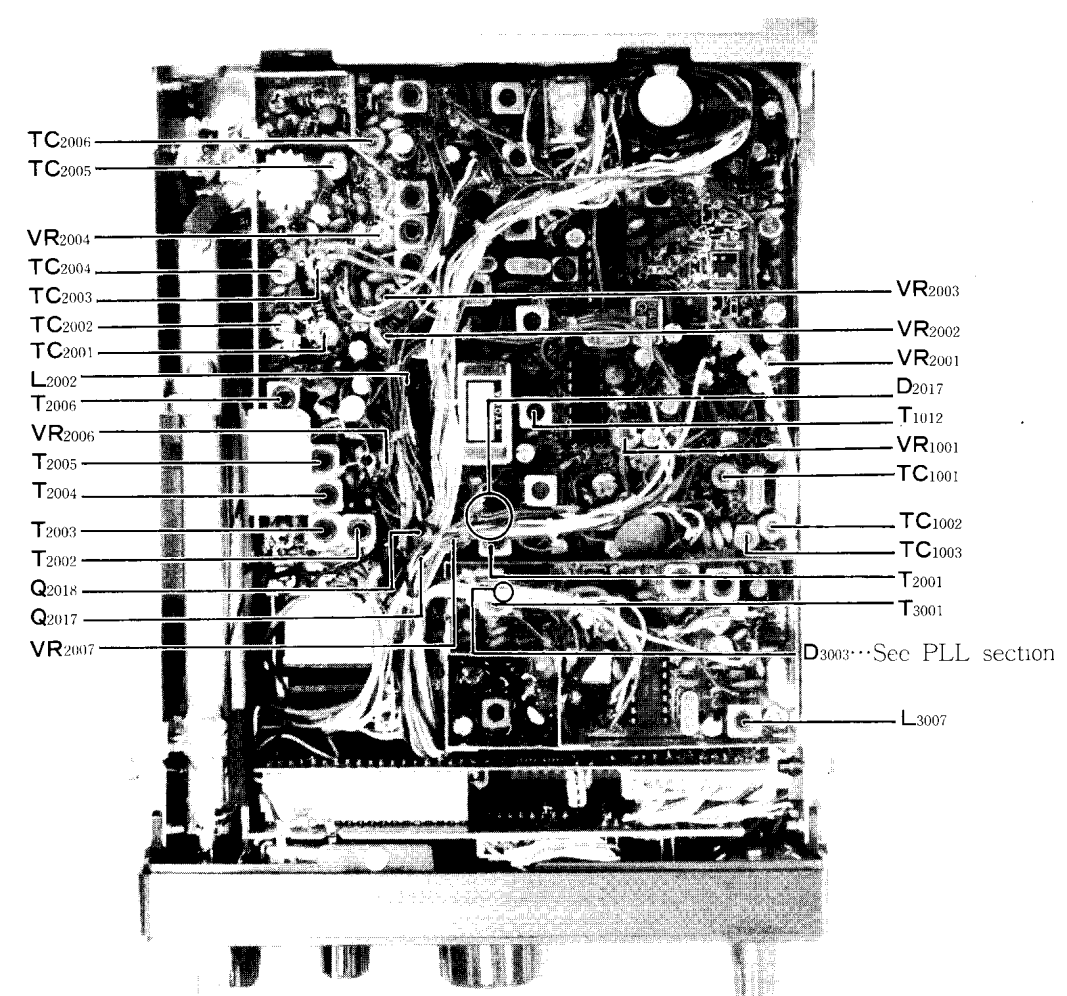

RECEIVER SECTION ALIGNMENT POINTS

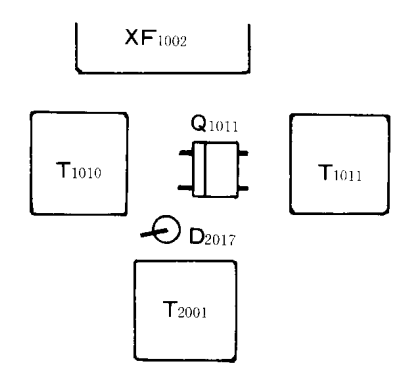

TRANSMITTER SECTION ALIGNMENT POINTS

TRANSMITTER

The transmitter alignment should be performed with a dummy load connected to the antenna jack.

1. RF Power Stage Alignment

- Tune the transceiver to 146.000 MHz (model B: 145.000 MHz), and set the MODE switch to FM. Connect a dummy load/wattmeter to the ANT jack.
- Rotate VR_{2003} and VR_{2004} fully counterclockwise, and close the PTT switch.
- Connect the probe of a VTVM to the cathode of D_{3003} and check to see that the VTVM shows approximately 500 mV rms.
- Connect the probe of the VTVM to the cathode of D_{2017} and a frequency counter to the same point.
- Adjust the core of L_{2002} for a reading of 10.81 MHz \pm 100 Hz, and be sure its level is approximately 500 mV rms.
- Now adjust $T_{2001} - T_{2006}$, T_{3001} , $TC_{2001} - TC_{2006}$ for maximum reading on the wattmeter.

2. ALC Alignment

- Set the MODE switch to FM, and close the PTT switch.
- Adjust VR_{2003} for a reading of 2.5 watts on the wattmeter.

3. PO Meter Alignment

- Set the MODE switch to FM and close the PTT switch.
- Adjust VR_{2004} so that the PO meter indicator reaches the middle of the green zone, with a 2.5 watt reading on the wattmeter.

4. FM Deviation Alignment

- Assemble the test equipment and the transceiver as shown in Figure 2.
- Connect an audio generator to the MIC jack, and apply a 1 kHz 15 mV signal.

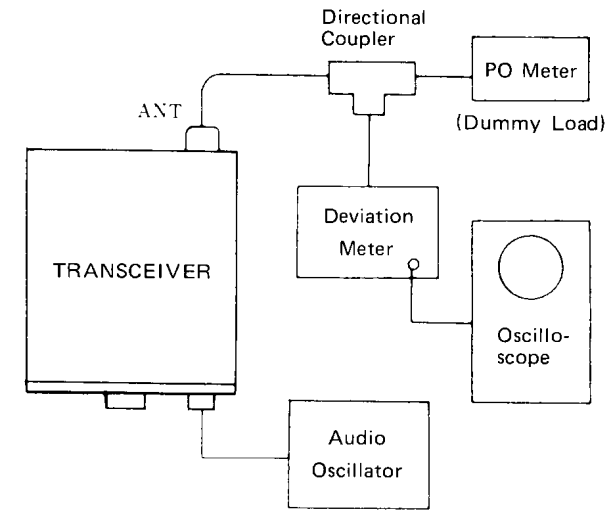

Figure 2

- Now close the PTT switch, and adjust VR_{2002} for a deviation of \pm 4.5 kHz while observing the signal waveform on the scope.
- Reduce the amplitude of the audio generator to 1.5 mV, and check to see that the linear detector shows \pm 3.5 kHz and that the signal waveform on the scope is not distorted.

5. Low Power Adjustment

- With the dummy load/wattmeter connected to the ANT jack, set the MODE switch to FM and the HI/LOW switch to the LOW position.
- Close the PTT switch and adjust VR_{2006} for an output of 0.5 watts.

6. SSB Modulator Output Transformer Adjustment

- With a dummy load/wattmeter connected to the ANT jack, set the MODE switch to either USB or LSB.
- Set VR_{2001} to the center of its range and apply a 1 kHz 1 mV signal from the audio generator to the MIC jack.
- Adjust T_{1012} for maximum power output.

7. SSB Carrier Point Adjustment

- (a) Apply a 1 kHz 1.2 mV signal from the audio generator to the MIC jack and adjust VR₂₀₀₁ for an output of 2.5 watts.
- (b) Set the MODE switch to USB and the frequency of the audio generator to 300 Hz. Adjust TC₁₀₀₂ for an output of 0.6 watts.
- (c) Change the MODE switch to LSB, and adjust TC₁₀₀₁ for an output of 0.6 watts.

8. Carrier Balance Adjustment

- (a) Temporarily short the PTT line at the MIC jack, using a jumper wire, not the microphone.
- (b) Monitor the carrier on a monitor receiver, and adjust VR₁₀₀₁ for minimum S-meter reading (or minimum signal level if no S-meter reading occurs).
- (c) Switch the MODE switch between USB and LSB, and compare the carrier levels of both modes and again adjust VR₁₀₀₁ so as to achieve good carrier nulling on both modes.

9. CW Carrier Frequency Adjustment

- (a) Set the MODE switch to CW.
- (b) Connect a frequency counter to the cathode of D₂₀₁₇.
- (c) Connect a CW key to the KEY jack, and then close the PTT switch and KEY simultaneously. Adjust TC₁₀₀₃ for a frequency of exactly 10.8093 MHz.
- (d) Now set the frequency to 145.100.0 MHz and place the input lead from the counter to the dummy load to read the transmit frequency. Then adjust L₃₀₀₇ for a reading of 145.100.0 MHz \pm 100 Hz on the frequency counter.

10. TX Balanced Mixer Alignment

If you do not have a spectrum analyzer, do not perform this alignment, as serious spurious radiation will result.

- (a) Connect a directional coupler between the transceiver and dummy load/wattmeter, and feed the coupled output from the directional coupler to the spectrum analyzer.

- (b) Set the MODE switch to FM and close the PTT switch. Adjust VR₂₀₀₇ so that a minimum spurious level appears \pm 10.81 MHz from the carrier on the spectrum analyzer.

11. Battery Check

- (a) Apply a DC 9V to the EXT DC 13.8V terminal from an external power supply.
- (b) Set the LAMP/BATT CHECK switch (on the REAR PANEL) to the BATT CHECK position.
- (c) Adjust VR₄₀₀₁ so that the PO meter deflects to the left side of the green zone.

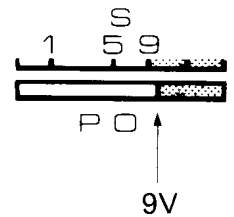
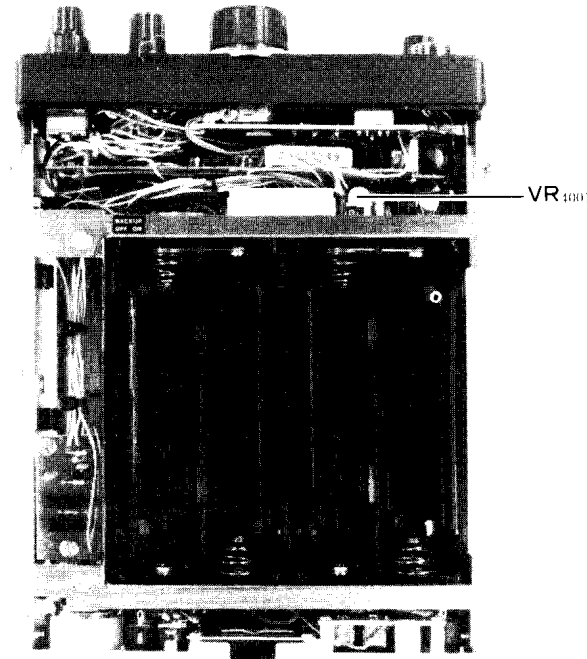

Scanned by
Dair
hamdirectory.info
www.hamdirectory.info

PARTS LIST

MAIN CHASSIS		
Symbol No.	Part No.	Description
DIODE		
D01, 02	G2090001	Si 10D1
D03	G2090027	Si 1SS53
D04	G2090034	Si U05B
RESISTOR		
R02	J01215101	Carbon Film 1/8W TJ 100Ω
R01	J01215103	" " " " 10kΩ
POTENTIOMETER		
VR01 (with S01)	J62800057	K12B61004-5N1211-5KB, 10KA
CAPACITOR		
C03	K00175150	Ceramic Disc 50WV SL 15pF (DD104SL150J50V02)
C04	K00175390	Ceramic Disc 50WV SL 39pF (DD104SL390J50V02)
C01, 02, 05, 06	K12171102	Ceramic Disc 50WV 0.001μF (DD105E102P50V02)
C07-10	K10179016	Ceramic Disc 50WV 0.001μF (DB201YB102K5L5)
INDUCTOR		
L01	L0020951	
L02	L0020334	
SWITCH		
S01 (with VR01)	-	
S02	Q9000115	EWT-XDBS2050B
S03	N0190082	SRN3066
S04	N0190084	SRS101C Switch Unit (C)
PB-2240	F0002240 C0022400	Printed Circuit Board PCB with S04
S05	N6090028	SSH-P-23-05 Switch Unit (A)
S06, 07	N6090029	SSFYP-22-07 Switch Unit (A)
PB-2242	F0002242 C0022420	Printed Circuit Board PCB with S05, S06, S07
RECEPTACLE		
J01	P0090243	FM214-7SS(A)
J02	P1090193	FM-MR-M

J03, 07	P1090005	SG8050
J04	P1090051	SG8512
J05	P0090190	HEC0630
J06	P1090197	SG8021
SPEAKER		
SP01	M4090029A	SM-50A
CONNECTOR		
P01 (with wire)	T9204140	XHP-9
P02 (with wire)	T9204150	XHP-10
P03 (with wire)	T9204160	XHP-12
P04 (with wire)	T9204247A	XHP-13
P05 (with wire)	T9204248A	3021-05
ANTENNA		
ANT01	Q3000020	
METER		
M01	M0290023	T-22
BATTERY HOLDER		
	Q9000116B	C-12A (with wire)
	Q9000117B	C-12A (with wire)
MAIN UNIT		
Symbol No.	Part No.	Description
PB-2235C	F0002235C	Printed Circuit Board
	C0022350	P.C.B. with Components
IC		
Q1012	G1090340	MC1496P
Q1019	G1090145	MC3357P
Q1027	G1090073	μPC575C2
Q2004	G1090072	μPC577H
Q2010	G1090027	MC14001B
Q3006	G1090237	μPD2819C

		FET	
Q1001	G4800590Y	3SK59Y	
Q1002	G4800510C	3SK51-03	
Q1003, 1010, 1111, 3002	G4800730Y	3SK73Y	
Q1009, 3003	G3801680D	2SK168D	
Q1015, 2017, 2018, 3001	G3801920G	2SK192GR	
Q3007	G3800301Y	2SK30A-Y	
Q2019	G4800590G	3SK59GR	
		TRANSISTOR	
Q1004, 3004, 3005, 3009, 3010	G3305350A	2SC535A	
Q1007, 1013, 1014, 1017, 1020, 1021, 1025, 1026, 2001-2003, 2007-2009	G3326030E	2SC2603E	
Q1008	G3090005	MPS-A13	
Q1016	G3107331Q	2SA733Q	
Q1018	G3107331P	2SA733P	
Q2011, 2012, 3008	G3309451P	2SC945P	
Q2020	G3320260	2SC2026	
Q2021	G3320530	2SC2053	
Q2022	G3319470	2SC1947	
Q1005	G3315830	2SC1583	
Q1006, 2005	G3327860	2SC2786L	
		DIODE	
D3006	G2090023	Varactor	1SV50
D2005	G2090108	"	1SV68
D1002-1004, 2018-2022	G2090109	"	1SV69
D3001	G2090107	"	1T25
D1005, 1006, 1028, 1029, 1031, 1042, 2007-2009, 2010, 2027, 3005	G2001880F	Ge	1S188FM
D2023	G2015550	Si	1S1555

D1007-1024, 1027, 1030, 1032, 1039, 1041, 2011-2013, 2016, 2017, 2026, 2028, 2030, 3002-3004	G2090027	Si	1SS53
D2024, 2025	G2090033	Si	MI301
D2029	G2090193	Zener	RD5.6EB-3
D3007	G2090196	"	HZ6C-1L
		CRYSTAL	
X1001	H0100992	HC-18/U	10.8115 MHz
X1002	H0102288	HC-18/U	10.8093 MHz
X1003	H0101100	HC-18/U	11.265 MHz
X2001	H0101020	HC-18/U	10.810 MHz
X3001	H0101986	HC-18/T	5.76 MHz
X3002	H0102385B	RW-18/T3P	18.7414 MHz
		CRYSTAL FILTER	
XF1001	H1102021	108M30B	
XF1002	H1102022	10F2D	10.81 MHz
		CERAMIC FILTER	
CF1001	H3900171	CFG455E-1/SLFD15SA	
		RESISTOR	
R1122	J10246229	Carbon Composition	1/4W GK 2.2Ω
R2069	J00215569	" Film	1/8W VJ 5.6Ω
R2066	J00215100	" "	" " 10Ω
R2071	J00215470	" "	" " 47Ω
R2059	J10246560	" Composition	1/4W GK 56Ω
R1018, 1037, 1038, 1121, 2020, 2063	J00215560	" Film	1/8W VJ 56Ω
R1012, 1021, 1023, 1026, 1030, 1043, 1048, 1052, 1057, 2054, 2067, 3003, 3008, 3012, 3019, 3040	J00215101	" "	" " 100Ω

R1113, 3044	J10246101	Carbon Composition	1/4W	GK	100Ω
R1005, 1015, 1041	J00215151	" Film	1/8W	VJ	150Ω
R1116, 2028, 3002, 3007	J00215221	" "	"	"	220Ω
R2075	J10246221	" Composition	1/4W	GK	220Ω
R2072	J02245331	" Film	1/4W	SJ	330Ω
R2070	J02245391	" "	"	"	390Ω
R2013, 2014, 2027, 2061, 3036, 3039	J00215471	" "	1/8W	VJ	470Ω
R1032, 1054, 1055	J00215561	" "	"	"	560Ω
R1065	J10246561	" Composition	"	GK	560Ω
R2068	J00215681	" Film	"	VJ	680Ω
R3013	J00215821	" "	"	"	820Ω
R1033, 1034, 1036, 1044, 1049, 1077, 1101, 1107, 1118, 2007, 2019, 2065, 3018, 3027, 3031, 3035	J00215102	" "	"	"	1kΩ
R1040	J10246102	" Composition	1/4W	GK	1kΩ
R3045	J00215122	" Film	1/8W	VJ	1.2kΩ
R1076, 1081, 1087, 3017, 3030	J00215152	" "	"	"	1.5kΩ
R3041	J10246222	" Composition	1/4W	GK	2.2kΩ
R1019, 1031, 1058, 1083, 2012, 3028, 3029	J00215222	" Film	1/8W	VJ	2.2kΩ
R1042, 2018, 3009-3011	J00215272	" "	"	"	2.7kΩ
R3020	J10246272	" Composition	1/4W	GK	2.7kΩ
R1046, 1056, 1062, 1102, 2001, 2003, 2039	J00215332	" Film	1/8W	VJ	3.3kΩ
R1053, 2008	J00215392	" "	"	"	3.9kΩ
R1051, 1061, 1070, 1072, 1086, 1106, 2004, 2009, 2049, 2064	J00215472	" "	"	"	4.7kΩ

Scan by Dar
Hamid Factory info
www.hamidfactory.info

R1078	J10246472	" Composition	1/4W	GK	4.7kΩ
R1103	J00215562	Carbon Film	1/8W	VJ	5.6kΩ
R1013	J00215682	" "	"	"	6.8kΩ
R1059, 2005	J00215822	" "	"	"	8.2kΩ
R1001, 2037, 2045, 3014	J10246103	" Composition	1/4W	GK	10kΩ
R1002, 1011, 1025, 1029, 1050, 1068, 1071, 1089, 1100, 1104, 1105, 1109, 2034, 2042, 2044, 2060, 2073, 2074, 3016	J00215103	" Film	1/8W	VJ	10kΩ
R2010	J00215123	" "	"	"	12kΩ
R1060, 1080, 1082	J00215153	" "	"	"	15kΩ
R2076	J10246153	" Composition	1/4W	GK	15kΩ
R1010, 1063, 1069, 1098, 2011, 2021, 2026, 2033, 2035, 3004, 3005, 3015, 3033, 3037	J00215223	" Film	1/8W	VJ	22kΩ
R2036, 2077	J01215223	" "	"	TJ	22kΩ
R1114, 1115, 2031, 2038	J10246223	" Composition	1/4W	GK	22kΩ
R3026	J10246333	" "	"	"	33kΩ
R1125, 2022, 2043	J00215333	" Film	1/8W	VJ	33kΩ
R1016, 1035, 1039, 1064, 1075, 1084, 1085, 1090, 1110, 2025, 2032, 2050, 2051, 3001, 3034, 3038	J00215473	" "	"	"	47kΩ
R1073, 1074	J00215823	" "	"	"	82kΩ
R1006, 1008, 1009, 2023, 2052, 2053, 2055-2058, 2062, 3006, 3032	J00215104	" "	"	"	100kΩ
R3022-3024	J10246104	" Composition	1/4W	GK	100kΩ
R1112	J00215124	" Film	1/8W	VJ	120kΩ

R1024, 1111, 3021	J00215154	Carbon Film	1/8W	VJ	150kΩ
R1119	J00215224	" "	" "	" "	220kΩ
R1079, 3043	J00215274	" "	" "	" "	270kΩ
R2006, 3042	J00215334	" "	" "	" "	330kΩ
R1020, 1027 1108, 1120	J00215474	" "	" "	" "	470kΩ
R2040	J00215684	" "	" "	" "	680kΩ
R1004, 1123, 3025	J00215105	" "	" "	" "	1MΩ
R1123	J01215105	" "	" "	TJ	1MΩ
R1066, 1097	J00215155	" "	" "	VJ	1.5MΩ
R2002	J00215225	" "	" "	" "	2.2MΩ
R1067	J00215335	" "	" "	" "	3.3MΩ
R1124	J00215331	" "	" "	" "	330Ω
R1126	J01215102	" "	" "	TJ	1kΩ
POTENTIOMETER					
VR2002, 2006, 2007	J51745102	H0651A-1KB	1kΩB		
VR2003, 2004	J51745103	H0651A-10KB	10kΩB		
VR1002, 2001	J51745223	H0651A-22KB	22kΩB		
VR1001, 3002	J51745473	H0651A-47KB	47kΩB		
VR3001	J51745154	H0651A-150KB	150kΩB		
VR1003	J51745225	H0651A-2.2MB	2.2MΩB		
THERMISTOR					
TH2001	G9090020	21D27			
TH3001	G9090008	31D26			
CAPACITOR					
C1015, 2037, 2038, 2072, 3046	K00179001	Ceramic Disc (DD104SL0R5C50V02)	50WV	SL	0.5pF
C1010, 2066, 2076, 2083	K02179003	" " (DD104CK020C50V02)	" "	CH	2pF
	K00172020	" " (DD104SL020C50V02)	" "	SL	2pF
C3004	K06172020	" " (ECC-D1H020CU)	" "	UJ	2pF
C1013, 2070, 2074, 3006	K02179004	" " (DD104CH030C50V02)	" "	CH	3pF
C2030	K06172030	" " (ECC-D1H030CU)	" "	UJ	3pF
C3017	K00172030	" " (DD104SL030C50V02)	" "	SL	3pF
C3056	K06172040	" " (ECC-D1H040CU)	" "	UJ	4pF

C1058, 3008, 3014, 3040	K00172050	Ceramic Disc (DD104SL050C50V02)	50WV	SL	5pF
C2077, 2082	K06172050	" " (DD104RH050D50V02)	" "	UJ	5pF
C1003, 1023, 3021	K00173060	" " (DD104SL060D50V02)	" "	SL	6pF
C2071, 2073, 3002	K06173060	" " (DD104UJ060D50V02)	" "	UJ	6pF
C1009, 1014, 1016	K06173070	" " (ECC-D1H070DU)	" "	" "	7pF
C1046, 3047	K00173070	" " (DD104SL070D50V02)	" "	SL	7pF
C3001	K05173080	" " (DD104RH080D50V02)	" "	RH	8pF
	K02173090	" " (DD104CH090D50V02)	" "	CH	9pF
C3043	K00173090	" " (DD104SL090D50V02)	" "	SL	9pF
C1012, 1101, 2067, 2075, 2101	K00173100	" " (DD104SL100D50V02)	" "	" "	10pF
C1079	K02173100	" " (DD104CH100D50V02)	" "	CH	10pF
C3007	K02175120	" " (DD104CH120J50V02)	" "	" "	12pF
C2064, 2065	K06175150	" " (ECC-D1H150JU)	" "	UJ	15pF
C3005, 3007	K02175180	" " (DD104CH180J50V02)	" "	CH	18pF
C2056, 2057	K00175180	" " (DD104SL180J50V02)	" "	SL	18pF
C2095, 3022	K00175220	" " (DD104SL220J50V02)	" "	SL	22pF
C1078	K02179011	" " (DD104CH270J50V02)	" "	CH	27pF
C1040, 2078, 2087, 2098, 2099, 2106, 3031, 3032	K00175330	" " (DD104SL330J50V02)	" "	SL	33pF
C2104	K00175390	" " (DD104SL390J50V02)	" "	" "	39pF
C1072, 1095, 2112	K00175470	" " (DD104SL470J50V02)	" "	" "	47pF
C2027	K05185470	" " (RD871-1N220470J63V)	" "	RH	47pF
C3024, 3025	K00175560	" " (DD104SL560J50V02)	" "	SL	56pF
C1053, 1083	K00175101	" " (DD105SL101J50V02)	" "	" "	100pF

C1076	K02175101	" " " CH 100pF (DD107CH101J50V02)
C1127	K00179056	Ceramic Disc 50WV SL 100pF (DD105-257SL101J50V02)
C2031, 2032, 3035, 3038, 3039	K06175101	" " " UJ 100pF (DD106UJ101J50V02)
C1096	K00175121	" " " SL 120pF (DD105SL121J50V02)
	K06175181	" " " UJ 180pF (ECC-D1H181JU2)
C1075	K02179025	" " " CH 220pF (DD111CH221J50V02)
C1041	K00175331	" " " SL 330pF (DD107SL331J50V02)
C1001, 1002, 1004, 1006, 1008, 1031, 1048, 1066, 1130, 2002, 2003, 2014, 2018, 2036, 2039, 2040, 2046, 2058, 2059, 2062, 2063, 2068, 2069, 2079- 2081, 2084, 2085, 2088, 2090-2092, 2094, 2097, 2100, 2102, 2105, 2107, 2108, 2111, 3009, 3011- 3013, 3015, 3016, 3018, 3020, 3023, 3028, 3041, 3044, 3049, 3050, 3051- 3053, 3057	K12171102	" " " 0.001μF (DD105E102P50V02)
C1011, 2033-2035	K11179001	" " " 0.001μF (ECK-D1H102MD)
C1005, 1007, 1018, 1061, 1073, 1074, 1080-1082, 1084, 1088- 1090, 1093, 2054, 2060	K13170103	" " " 0.01μF (DB201YF103Z5L5)

C2061, 3029	K13170103	Ceramic Disc 50WV 0.01μF (DB201YF103Z5L5)
C3026, 3030, 3037, 3042	K14179002	" " " 0.01μF (RD204YM103Z50V)
C1024, 1098, 1099, 1133, 2008, 2041	K19149001	Semiconductor Ceramic 25WV 0.001μF (UAT04X102K-L05AE)
C1124	K19149005	" " " 0.0022μF (UAT04X222K-L05AE)
C2009	K19149007	" " " 0.0033μF (UAT05X332K-L05AE)
C1044, 1049, 1054, 1060, 1063, 1065, 1068, 1069, 1071, 1108, 1125, 2010, 2012, 2017, 2043	K19149013	" " " 0.01μF (UAT05X103K-L05AE)
C1100, 1102	K19149017	" " " 0.022μF (UAT06X223K-L45AE)
C1021, 1025, 1027, 1028, 1030, 1034, 1035, 1037, 1039, 1043, 1045, 1047, 1050, 1052, 1055, 1057, 1085, 1105, 1106, 1109, 1110, 1138, 2024, 2025, 2044, 2045, 3003	K19149021	" " " 0.047μF (UAT08X473K-L45AE)
C1091, 1135	K19149025	" " " 0.1μF (UAT13X104K-L46AE)
C1097	K40179002	Electrolytic 50WV 0.1μF (50RC2-R1)
C1042, 1067, 1086, 1097, 1111, 1112, 1126, 1129, 2001, 2005, 2006, 2013, 2026, 3027	K40179001	" " 1μF (50RC2-R47)

Scan by Data
 Handinectory.info
 www.handinectory.info

C1092, 1094, 1131, 3048	K40149011	Electrolytic (25RC2-4R7)	25WV	4.7 μ F
C1062, 1064, 1087, 1104, 1123, 2004, 2007, 2011, 2019, 2021- 2023, 2086, 2089, 2093, 2096, 2109, 2110, 3010, 3045, 3054, 3055	K40129012	" (16RC2-10)	16WV	10 μ F
C1128, 1132, 1137	K40109002	" (10RE47)	10WV	47 μ F
C1134	K40129007	" (16RE100)	16WV	100 μ F
C1136	K40129021	" (16R102S)	"	1000 μ F
C3033	K70167474	Tantalum (CS15E1VR47)	35WV	0.47 μ F
C2020	K70127106	" (CS15E1O100M)	16WV	10 μ F
C3034	K54200001	Polyester Film (B32561-A-1105J)	100WV	1 μ F
TRIMMER CAPACITOR				
TC3001	K91000056	TZ03Z070A		7pF
TC1001-1003, 2001-2006	K91000075	TZ03R200E		20pF
INDUCTOR				
L3003	L1190004	FL 4H-R68M		0.68 μ H
L2011, 3004,	L1190005	FL 4H-1R0M		1 μ H
L1003	L1190111	FL 4H-5R6K		5.6 μ H
L3001, 3006	L1190014	FL 4H-100K		10 μ H
L1001	L1190016	FL 5H-101K		100 μ H
L1004 1005	L1190120	FL 5H-471K		470 μ H
L2001	L1190102	S 104K		100mH
L2004	L1020682			
L2003, 2005	L1020683			
L2007, 2009	L1020681			
L3005	L1020680			
L2002	L0020775			
L2006	L0020725			

L2008	L0020766	
L2010	L0020744	
L2012	L0020341	
L2013, 2014	L0020743	
L3002	L0020359A	S-6B
L3007, 3008	L0020950	
TRANSFORMER		
T1001-1004, 2002-2006, 3001-3003	L0020345	
T1005-1012	L0020187	
T1013	L0020887	
T2001	L0020910A	
T1014	L0020888	
RELAY		
RL2001	M1190001	FBR211AD009M
TERMINAL BOARD		
	Q6000005	1L2P
FB2001, 2002	L9190001	Ferrite Beads
REG. UNIT		
Symbol No.	Part No.	Description
PB-2239A	F0002239A	Printed Circuit Board
	C0022390	P.C.B. with Components
IC		
Q4001	G1090239	TC5082P
Q4005	G1090350	ICL7660CPA
FET		
Q4006	G3801930K	2SK193K
TRANSISTOR		
Q4002	G3307331P	2SA733P
Q4003	G3304960Y	2SC496Y

R5004, 5009, 5010	J00215105	Carbon Film	1/8W	VJ	1M Ω
R5007	J00215223	" "	" "	" "	22k Ω
BLOCK RESISTOR					
RB5001	J40900023				
RB5002	J40900022				
THERMISTOR					
TH5001	G9090016	33D-28			
CAPACITOR					
C5001	K10176391	Ceramic Disc (DD104B391K50V02)	50WV		390pF
C5002, 5005, 5010-5012	K12171102	" " (DD105E102P50V02)	"		0.001 μ F
C5006, 5008, 5009	K19149009	Semiconductor Ceramic (UAT05X472K-L05AE)	"		0.0047 μ F
C5007	K19149013	" " (UAT05X103K-L05AE)	"		0.01 μ F
C5003, 5004	K40129012	Electrolytic (16RC2-10)	16WV		10 μ F
CONNECTOR					
J5001	P0090213	S-12B-XH	12P		
J5002	P0090211	S-10B-XH	10P		
J5003	P1090232	3024-18CH	18P		
SWITCH					
S5001	N6090008	SSS-012			
BUZZER					
BZ5001	M4290001	EFBRE-25D02			
DISPLAY UNIT					
Symbol No.	Part No.	Description			
PB-2237A	F0002237A	Printed Circuit Board			
	C0022370	P.C.B. with Components			

IC					
Q6001	G1090346	TP0401			
LCD					
DS6001	G6090025	H1313A			
LAMP					
PL6001	Q1000046	BQ031-30103A	12V		40mA
KEYBOARD UNIT					
Symbol No.	Part No.	Description			
PB-2238	F0002238	Printed Circuit Board			
	C0022380	P.C.B. with Components			
DIODE					
D7003-7007	G2090027	Si			1SS53
D7001	G2090136	LED			TLG205
D7002	G2090137	LED			TLR205
RESISTOR					
R7001	J01215821	Carbon Film	1/8W	TJ	820 Ω
SWITCH					
S7001-7007	N5090003	KEF-10901			
S7008	N4090042	SUT 111			
CONNECTOR					
J7001	P0090210	S9B-XH			
P7001	P0090242	3022-18A			
SWITCH UNIT (B)					
Symbol No.	Part No.	Description			
PB-2241A	F0002241A	Printed Circuit Board			
	C0022410	P.C.B. with Components			

		TRANSISTOR	
Q8001	G3326030E	2SC2603E	
		RESISTOR	
R8001	J00215223	Carbon Film	1/8W VJ 22k Ω
R8004	J01215333	" "	" TJ 33k Ω
R8002	J00215473	" "	" VJ 47k Ω
R8003	J01215474	" "	" TJ 470k Ω
		CAPACITOR	
C8001, 8002	K12171102	Ceramic Disc (DD105E102P50V02)	50WV 0.001 μ F
		SWITCH	
S8001	N6090007	SSS013	
S8002	N6090008	SSS012	
ACCESSORIES			
Symbol No.	Part No.	Description	
	M3090033	Microphone	YM-47
	P1090253	(Microphone Plug FM147P)	
	R7070600B	Shoulder Belt	
	R0071360	Microphone Hanger	
	P1090139	Power Plug	P-200
	P0090034	SP Plug	C-107

Scanned by IW1AXR
 Downloaded by
 Amateur Radio Directory