

73 for Radio Amateurs

® A CWC/P Publication

International Edition

Sub-Zero Circuits

State Machines

- What They Are
- How to Use Them

Simple C-64 Printer Interface

Shifty RTTY Filter

1986 Awards Program

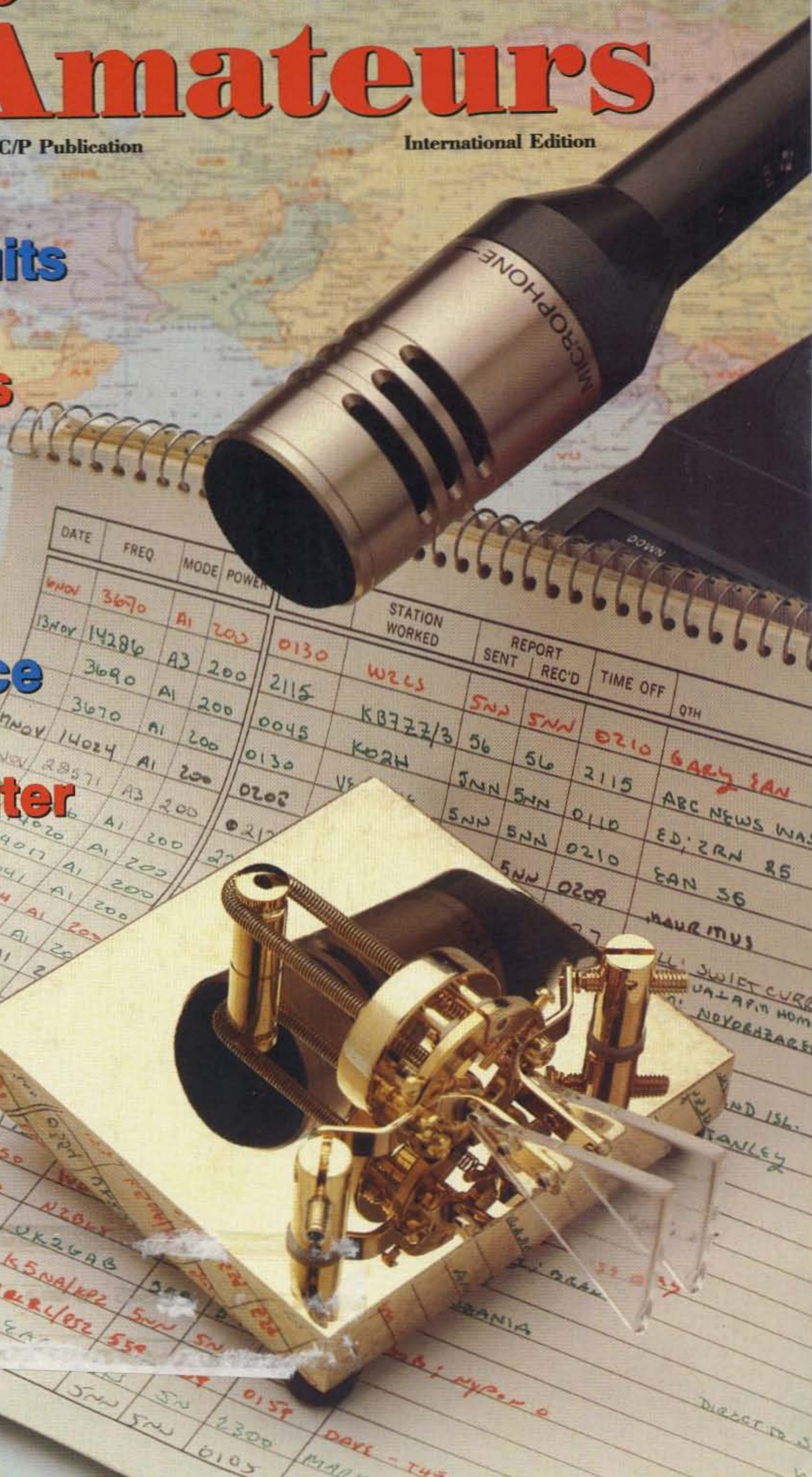

ICOM HF Transceiver

IC-751



The Standard of Excellence in HF Base Stations

The IC-751 is the most advanced transceiver available today. It's a competition grade ham receiver, a 100KHz to 30MHz continuous tuning general coverage receiver AND a full-featured all mode solid-state ham band transmitter. The IC-751 also covers the new WARC bands, MARS frequencies, and is AMTOR compatible.

Important Standard Features. Compare these important standard features in this "top of the line" base station:

- 100KHz - 30MHz Receiver
- 105dB dynamic range
- QSK — full break-in CW (nominal speed 20WPM)

- FM Mode Standard
- High-grade FL-44A 455KHz SSB filter
- 32 tunable Memories with lithium battery backup
- 100% Duty Cycle Transmitter
- Passband Tuning
- 12V DC operation
- Adjustable AGC
- Adjustable Noise Blanker
- RIT/XIT with separate readout
- IC-HM12 Microphone with Up/Down Scan
- Continuously adjustable transmit power

Options. IC-EX310 speech synthesizer, internal IC-PS35 power supply, external IC-PS15 or IC-PS30 system supply, IC-SM8 two-cable desk mic,

IC-SM6 desk mic, RC-10 external controller, and a variety of filters.

FILTER SPECIFICATIONS

Filter	Model	Center Freq. (KHz)	-6dB Width
STANDARD FILTERS			
AM Ceramic	CFW-455 IT	455	6.0
SSB (PBT) XTAL	FL-30	9011.5	2.3
FM Filter	9M15A	9011.5	15 (-3dB)
SSB Narrow (Hygrade Crystal)	FL-44A	455	2.4
OPTIONAL FILTERS			
CW Narrow	FL-52A	455	0.500
CW Narrow	FL-53A	455	0.250
SSB Wide	FL-70	9011.5	2.8
CW Narrow	FL-32	9010.6	0.500
CW Narrow	FL-63	9010.6	0.250
AM	FL-33	9010.0	6.0

Operating From 12V, the IC-751 is also available with an optional internal AC power supply, the IC-PS35...for the winning edge in field day competition.



Shown with IC-PS35

The IC-751 provides superior performance for all amateur radio operators...from novice to extra class. See the IC-751 at your local ICOM dealer.

Now with a ONE YEAR Warranty!



First in Communications

ICOM America, Inc., 2380-116th Ave NE, Bellevue, WA 98004 / 3331 Towerwood Drive, Suite 307, Dallas, TX 75234

All stated specifications are approximate and subject to change without notice or obligation. All ICOM radios significantly exceed FCC regulations limiting spurious emissions. 751385



HAM RADIO OUTLET

ALL MAJOR BRANDS IN STOCK

ICOM IC-R71A

SUPERIOR GRADE
GENERAL COVERAGE
RECEIVER



Regular \$799

SALE! ~~\$629.95~~
\$599.95

TOLL-FREE PHONE

INCLUDING ALASKA AND HAWAII

ICOM HAND-HELDS



IC-02AT IC-2AT IC-3AT
IC-04AT IC-4AT

**AT GREAT LOW
LOW PRICES**

FREE SHIPMENT
MOST ITEMS. U.P.S. SURFACE.

ICOM IC-735

THE LATEST IN ICOM'S LONG LINE
OF HF TRANCEIVERS

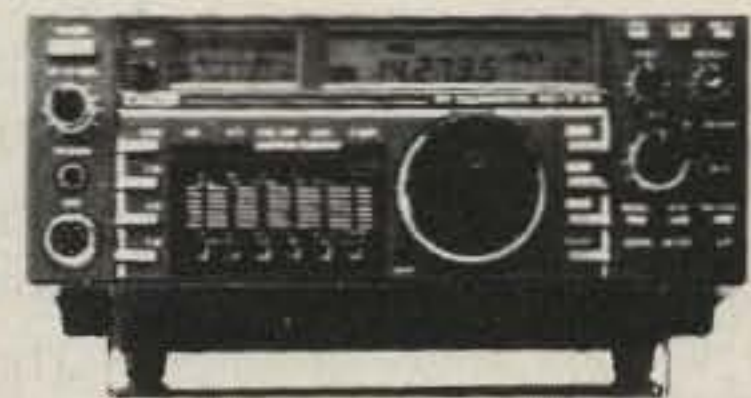

CALL FOR LOW, LOW PRICE

ICOM IC-37A



220 MHz's **BEST BUY!**

REGULAR \$449

SALE!

LIMITED QUANTITIES
THIS PRICE.

ICOM LATEST EDITION

IC-3200A DUAL BANDER

COVERS BOTH 2 METERS
and 70CM



CALL FOR
LOW,
LOW
PRICE

6 STORE BUYING POWER!

PERSONALIZED SERVICE



BOB FERRERO W6RU
President
JIM RAFFERTY N6RJ
VP So. Calif. Div. Anaheim
Managers
GEORGE, W5605V Burlingame
DON, N5IPE Oakland
BOB, K7RDH Phoenix
GLENN, K8NA San Diego
AL, K8YRA Van Nuys
and other active amateurs to serve you

800-854-6046

TOLL FREE PHONE INCLUDING ALASKA AND HAWAII

CALIF. AND ARIZONA CUSTOMERS CALL OR VISIT NEAREST STORE

PHONE HOURS: 9:30 AM TO 5:30 PM PACIFIC TIME.

STORE HOURS: 10 AM to 5:30 PM Mon. through Sat.

FREE SHIPMENT
MOST ITEMS U.P.S. SURFACE

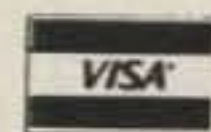

ANAHEIM, CA 92801
2620 W. La Palma,
(714) 761-3033, (213) 860-2040,
Between Disneyland & Knotts Berry Farm.

BURLINGAME, CA 94010
990 Howard Ave.,
(415) 342-5757,
5 miles south on 101 from San Fran. Airport.

OAKLAND, CA 94609
2811 Telegraph Ave.,
(415) 451-5757,
Highway 24 Downtown. Left 27th off-ramp.

PHOENIX, AZ 85015
1702 W. Camelback Road,
(602) 242-3515,
East of Highway 17.

SAN DIEGO, CA 92123
5375 Kearny Villa Road,
(619) 560-4900,
Highway 163 and Clairemont Mesa Blvd.

VAN NUYS, CA 91401
6265 Sepulveda Blvd.,
(818) 988-2212
San Diego Freeway at Victory Boulevard

AEA • ALLIANCE • ALPHA • AMECO • B & W • CALLBOOK • CENTURIAN • COLLINS • JSC • J W MILLER • KANTRONICS • SIGNAL ONE • STONER • TEMPO • TEN-TEC
AMPHENOL • ANXTER MARK • ANTENNA • COLUMBIA • CURTIS • CUSHCRAFT • KENWOOD • KLM • LARSEN • LUNAR • METZ • TRISTAD • TRI-EX • VAN GORDON • VOICOM
SPECIALISTS • ARRL • ASTRON • BASH • DAIWA • DRAKE • DX EDGE • EIMAC • MFJ • MICRO-LOG • MINI-PRODUCTS • VIBROPLEX • WEST • YAESU and more
BELDEN • BENCHER • BIRD • BUTTERNUT • GILFER • HAL • HUSTLER • HY GAIN • ICOM • MIRAGE • NYE • PALOMAR • ROHN • SHURE

Prices, specifications, descriptions subject to change without notice. Calif. and Arizona residents please add sales tax.

THINGS TO LOOK FOR (AND LOOK OUT FOR) IN A PHONE PATCH

- One year warranty.
- A patch should work with any radio. AM, FM, ACSB, relay switched or synthesized.
- Patch performance should not be dependent on the T/R speed of your radio.
- Your patch should sound just like your home phone.
- There should not be any sampling noises to distract you and rob important syllables. The best phone patches do not use the cheap sampling method. (Did you know that the competition uses VOX rather than sampling in their \$1000 commercial model?)
- A patch should disconnect automatically if the number dialed is busy.
- A patch should be flexible. You should be able to use it simplex, repeater aided simplex, or semi-duplex.
- A patch should allow you to manually connect any mobile or HT on your local repeater to the phone system for a fully automatic conversation. Someone may need to report an emergency!
- A patch should not become erratic when the mobile is noisy.
- You should be able to use a power amplifier on your base to extend range.
- You should be able to connect a patch to the MIC and EXT. speaker jack of your radio for a quick and effortless interface.
- You should be able to connect a patch to three points inside your radio (VOL high side, PTT, MIC) so that the patch does not interfere with the use of the radio and the VOL. and SQ. settings do not affect the patch.
- A patch should have MOV lightning protectors.
- Your patch should be made in the USA where consultation and factory service are immediately available. (Beware of an inferior offshore copy of our former PRIVATE PATCH II.)

**ONLY
PRIVATE PATCH III
GIVES YOU ALL
OF THE ABOVE**

**N
E
W**

PRIVATE PATCH III

SIMPLEX SEMI-DUPLEX INTERCONNECT

**N
E
W**



With an amazingly low price, the all new PRIVATE PATCH III is the most powerful personal phone patch system available. You can use it simplex, repeater aided simplex (from your base) or semi-duplex (at the repeater). That's right, you will never have to buy another patch. PRIVATE PATCH III does it all! There are many new and important features which were formerly only available in our top commercial models.

With a flick of the new connect switch you can patch your friends on the repeater into the phone system. One of them may need to report an emergency!

No hassles with busy signals! If you call a number that is busy, just put your MIC down and relax. PRIVATE PATCH III will disconnect automatically.

The new CW ID keeps you completely informed as to patch status. ID occurs when you access and again when you disconnect. ID is also sent after toll call attempts, all automatic disconnects, manual disconnect and when timeout is imminent. And of course your CW ID chip is free.

PRIVATE PATCH III does not interfere with the normal use of your base radio. A new audio pre-amp permits audio take off before the VOL. control. As a result, the VOL. and squelch settings do not affect patch operation. Of course you can also connect PRIVATE PATCH III to the MIC and EXT speaker jacks as before.

A new digit counting system makes the toll restrict positive even in areas where you do not have to dial "1" first. A secret five digit code disables the toll restrict for one toll call. Re-arm is automatic.

Additional new features: MOV lightning protection — Three digit access code (eg. *93) — Spare relay position on board — Plus former features: 3/6 minute timeout timer — Digital fast VOX (pat. pend.) — 115 VAC supply — Modular Jack and cord plus much more!

Why settle for a starter set? PRIVATE PATCH III provides you with commercial quality uninterrupted (cellular like) mobile telephone communications 24 hours a day. Send for our four page brochure today for complete details.

Options:
FCC approved coupler
12 VDC or 230 VAC power



DEALERS

- | | |
|--|---|
| AMATEUR ELECTRONIC SUPPLY
Milwaukee WI, Wickliffe Oh,
Orlando FL, Clearwater FL,
Las Vegas NV | MADISON ELECTRONICS SUPPLY
Houston, TX |
| BARRY ELECTRONICS CORP.
New York, NY | MIAMI RADIO CENTER CORP.
Miami FL |
| COLES COMMUNICATIONS
San Antonio TX | MIKES ELECTRONICS
Ft. Lauderdale, Miami FL |
| EGE, INC.
Woodbridge, VA | N&G DISTRIBUTING CORP.
Miami FL |
| ERICKSON COMMUNICATIONS
Chicago IL | PACE ENGINEERING
Tucson AZ |
| HAM RADIO OUTLET
Anaheim CA, Burlingame CA,
Oakland CA, Phoenix AZ,
San Diego CA, Van Nuys CA | THE HAM STATION
Evansville IN |
| HENRY RADIO
Los Angeles CA | TEXAS TOWERS
Piano, TX |
| INTERNATIONAL RADIO
SYSTEMS
Miami, FL | TNT RADIO SALES
Robbinsdale, MN |
| JUNS ELECTRONICS
Culver City CA | WESTCOM
San Marcos, CA |
| | CANADA:
DOLLARD ELECTRONICS
Vancouver, BC |

**CONNECT
SYSTEMS
INCORPORATED**

(213) 373-6803

23731 Madison St., Torrance, CA 90505



73[®] for Radio Amateurs

ISSUE #304

JANUARY 1986

On the Cover:

Design by Art Director
Dianne Ritson and
Designer Sue Hays.
Paddles courtesy of
Bencher, Inc.
Photography by
Frank Cordelle,
Bennington NH.

- 4 What?
- 7 QRX
- 61 Barter 'N' Buy
- 62 Special Events
- 63 Letters
- 63 Fun!
- 64 73 Awards
- 66 Review
- 72, 80, 84 Ham Help
- 76 New Products
- 77 RTTY Loop
- 78 Above and Beyond
- 82 73 International
- 84 Satellites
- 88 Contests
- 92 QSL of the Month
- 94 Dealer Directory
- 94 Propagation
- 95 List of Advertisers

12 More Cheap Talk

Here's the beginning of the end of your sanity—a text-to-speech algorithm that lets your computer speak its mind!

..... WB6NQG

22 Try an Inverted-Psi Wire

Get the DX edge on 80m with a radiation angle that's almost too low!

..... W1GV/4

28 Selcal and State Machines

WA7NBF takes the mystery out of this powerful technique with a hands-on selective-calling project.

..... WA7NBF

36 Little or No Resistance

Explore the strange world of superconduction, where current flows forever and a picosecond is an eternity.

..... AJ0N

40 Run Silent, Run Beep

Is your FT-227RB scanning? You won't have to guess with this easy add-on.

..... PY2AUC

42 A Better Money-Maker

WA6TTY stiffens up his original power supply to deliver a solid 13.8 volts at 20 Amps. The cost? Under three bucks!

..... WA6TTY

44 The Commodore Cable Caper

Need a printer cable? Strapped for cash? Don't just sit there—*build* the darn thing!

..... KE4PC

46 The Perfect RTTY Filter

Its tunable shift covers 80 to 1160 Hz with a flat gain and Q. And you can build it for less than ten dollars!

..... WA0MRG

50 Double Your Computing Power!

Try "parallel processing" with a second CoCo keyboard.

..... NO8M

54 Working 2ICTU

Can RTTY get any simpler?

..... WB8OMK

Editorial Offices: Pine Street, Peterborough NH 03458, phone: 603-924-9471. **Advertising Offices:** Elm Street, Peterborough NH 03458, phone: 603-924-7138. **Circulation Offices:** Elm Street, Peterborough NH 03458, phone: 603-924-9471. **Manuscripts:** Contributions in the form of manuscripts with drawings and/or photographs are welcome and will be considered for possible publication. We can assume no responsibility for loss or damage to any material. Please enclose a stamped, self-addressed envelope with each submission. Payment for the use of any unsolicited material will be made upon acceptance. All contributions should be directed to the 73 editorial offices. "How to Write for 73" guidelines are available upon request. US citizens must include their social security number with submitted manuscripts. **Subscription Information:** Rates: in the United States and Possessions: One Year (12 issues) \$24.97; Two Years (24 issues) \$38.00; Three Years (36 issues) \$53.00. Elsewhere: Canada and Mexico—\$27.97/1 year only, U.S. funds. Foreign surface mail—\$44.97/1 year only, U.S. funds drawn on U.S. bank. Foreign air mail—please inquire. To subscribe, renew or change an address: Write to Subscription Department, PO Box 931, Farmingdale NY 11737. Send Canadian changes of address to: 73, PO Box 1051, Fort Erie, Ontario CANADA L2A 5N8. Return postage guaranteed. For renewals and changes of address, include the address label from your most recent issue of 73. For gift subscriptions, include your name and address as well as those of gift recipients. For questions concerning your subscription and to place subscription orders, please call us toll free at 1-800-645-9559 between 9 am and 5 pm or write to: 73, Subscription Department, PO Box 931, Farmingdale NY 11737. 73 for Radio Amateurs (ISSN 0745-080X) is published monthly by CW Communications/Peterborough, Inc., 80 Pine Street, Peterborough NH 03458. Second class postage paid at Peterborough NH 03458 and at additional mailing offices. Canadian second class mail registration number 9566. Entire contents copyright © 1985, CW Communications/Peterborough, Inc. All rights reserved. No part of this publication may be reprinted or otherwise reproduced without written permission from the publisher. Microfilm Edition—University Microfilm, Ann Arbor MI 48106. Postmaster: Send address changes to 73 for Radio Amateurs, Subscription Services, PO Box 931, Farmingdale NY 11737. Nationally distributed by International Circulation Distributors.



WHAT?

News from KW10

Four things happened recently that set alarms clanging in my mind. Taken separately they seem innocuous enough, but it really wasn't until the fourth incident that I remembered the other three things and they all came together in a pattern. Here's what happened, in no particular order:

- On the local packet bulletin board I see a product release for TAPR's new TNC-2. It gives a technical description of the unit, a price, and an address and a telephone number to write or call if you want to buy a TNC-2.
- Lee Shoblom asks the FCC to let him use the 432-MHz ham band to gather news for his low-power television station.
- Chet Lambert of *Computer Trader Magazine* announces his Packet Sweepstakes—a Worked-All-States contest that promises valuable prizes to the winner.
- During the Mexico City earthquake, television networks use amateur radio to coordinate production schedules and to order parts and equipment.

Dingdingding!

There are two types of trouble here. In the first, a person or organization outside of amateur radio is trying to use the hobby for personal gain. In the second, the threat is from within our ranks, but the goal is the same. Commercialism, external and internal.

Outies...

External commercialism is something we can deal with easily. They FCC gives us plenty of time to comment on petitions that might affect ham radio adversely, and the ARRL does a pretty good job of keeping us all informed.

The Mexican earthquake made it obvious that the Commission had rather vaguely defined the rules of conduct during a communications emergency. In fact, they had rather vaguely defined a communications emergency. The major news organizations pounced on the loophole *before* the earthquake, and the League pounced on the FCC, asking for a reconsideration of the rules. What went on *after* the quake is a travesty. Fortunately the Commission agrees and I don't think it will happen again.

Now, take Lee Shoblom. Here is a fellow who owns a television station out in the boonies and wants to use ham radio to transmit video back to his studio. Can you blame him? Why should Lee shell out \$30,000 for a remote link when he can buy a Creeper Peepie and some ham gear for five hundred bucks? The best part is this: The local amateurs think it's a *wonderful* idea. Well, I think it *stinks*. We might as well hand over the keys to our UHF spectrum. And while we're at it, we could give cabbies the two-meter band (I hear they're already using it in New York). Since this is external commercialism, we have plenty of time to examine what's going on and to act appropriately.

...and Innies

Internal commercialism is more insidious. It's a lot harder to define. And because it is perpetrated by people we know, we're less likely to call it out. But that doesn't make it OK.

The spread of internal commercialism is directly linked to the growth of packet radio. The reason is simple: The act of communicating has shifted from the radio to the keyboard. What appears on the screen of your terminal is the same whether you use a VHF channel or a telephone line for the connection, so it seems very natural to transfer information from one computer to another.

The "ad" I saw for TAPR's TNC-2 was probably lifted from CompuServe® and deposited on our local packet bulletin board. In fairness, I must point out that its "wrongness" was felt by several individuals who read it, and it was eventually removed from the airways. But how do we know if something is commercial? In the TAPR case the matter was clear-cut, but consider this: A message is placed on a packet board which announces the availability of a new piece of hardware. No price is given, but an address is supplied so that you can get more information. Commercial? I say that it is, because the message will eventually create a sale for the company producing the hardware. Or try this: Excerpts from an amateur-radio newsletter are made available on a packet bulletin board. Commercial? Again, I have to say that it is, since the excerpts could be considered an advertisement which would make a sale for the publisher. This kind of internal commercialism is going to get worse as our hobby matures unless strong measures are taken *now*.

Finally, Chet Lambert's Packet Sweepstakes. I group this under internal commercialism because Chet is a ham who dearly loves amateur radio, not some sinister corporation trying to hoodwink us. Nevertheless, the idea still smacks of commercialism. Look—if someone is willing to give you a VHF transceiver for working 50 states on packet radio, how long will it be before you can get a Buick for winning the CQ WW PX contest?

Reaction to the Sweepstakes, at least here in New England, has been negative among experienced packeteers. And I

Continued on page 84

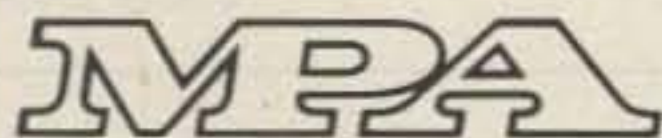

73 for Radio Amateurs is a member of the CW Communications/Inc. group, the world's largest publisher of computer-related information. The group publishes 57 computer publications in more than 20 major countries. Nine million people read one or more of the group's publications each month. Members of the group

include: Argentina's *Computerworld/Argentina*; Asia's *The Asian Computerworld*; Australia's *Computerworld Australia*, *Australian PC World*, *Macworld* and *Directories*; Brazil's *DataNews* and *MicroMundo*; China's *China Computerworld*; Denmark's *Computerworld/Danmark*, *PC World* and *RUN* (Commodore); Finland's *Mikro*; France's *Le Monde Informatique*, *Golden* (Apple), *OPC* (IBM) and *Distributique*; Germany's *Computerwoche*, *Microcomputerwelt*, *PC Welt*, *SoftwareMarkt*, *CW Edition/Seminar*, *Computer Business*, *RUN* and *Apple's*; Italy's *Computerworld Italia* and *PC Magazine*; Japan's *Computerworld Japan*; Mexico's *Computerworld/Mexico* and *CompuMundo*; The Netherlands' *Computerworld Benelux* and *PC World Benelux*; Norway's *Computerworld Norge*, *PC World* and *RUN* (Commodore); Saudi Arabia's *Saudi Computerworld*; Spain's *Computerworld Espana*, *Microsistemas/PC World*, *Commodore World*; Sweden's *ComputerSweden*, *Mikrodatorn* and *Svenska PC*; the UK's *Computer Management*, *Computer News*, *PC Business World* and *Computer Business Europe*; Venezuela's *Computerworld Venezuela*; the US's *Computerworld*, *Hot CoCo*, *inCider*, *Infoworld*, *MacWorld*, *Micro Market-world*, *PC World*, *RUN*, *73*, *80 Micro*, *Focus Publications* and *On Communications*.

STAFF

EXECUTIVE EDITOR
Susan Philbrick

MANAGING EDITOR
Steve Jewett KA1MPM

TECHNICAL EDITOR
Perry Donham KW10

ASSISTANT MANAGING EDITOR
Chris Schmidt KA1MPL

INTERNATIONAL EDITOR
Richard Phenix

EDITORIAL ASSISTANT
Carole Macioci

ART DIRECTOR
Dianne Ritson

DESIGNER
Sue Hays

ASSOCIATES
Robert Baker WB2GFE
John Edwards KI2U
Bill Gosney KE7C
Dr. Marc Leavey WA3AJR
Bill Pasternak WA6ITF
Peter Stark K2OAW
Peter Putman KT2B

ADVERTISING
1-800-441-4403

SALES MANAGER
Jim Gray W1XU

ASSISTANT SALES MANAGER
Nancy Ciampa

MARKETING MANAGER
Hope Currier

GRAPHIC SERVICES DIRECTOR
Christine Destrempe

GRAPHIC SERVICES MANAGER
Dennis Christensen

MANUFACTURING MANAGER
Susan Gross

TYPESETTING SUPERVISOR
Linda P. Canale

SYSTEMS SUPERVISOR
Andrea Florence

PRESIDENT/CEO
James S. Povec

VICE PRESIDENT/FINANCE
Roger Murphy

VICE PRESIDENT/
PLANNING AND CIRCULATION
William P. Howard

BUSINESS MANAGER
Matt Smith KA1IEI

CIRCULATION MANAGER
Frank Smith

DIRECT AND NEWSSTAND SALES
MANAGER
Raino Wirein
1-800-343-0728

DIRECTOR OF CREDIT SALES
AND COLLECTIONS
William M. Boyer

FOUNDER
Wayne Green W2NSD/1

PUBLISHER
John C. Burnett

KENWOOD

...pacesetter in Amateur radio

Scan the World



R-2000

All-mode receiver.

- Covers 150 kHz–30 MHz in 30 bands.
- All mode: USB, LSB, CW, AM, FM.
- Digital VFO's: 50-Hz, 500-Hz or 5-kHz steps. F. LOCK switch.
- Ten memories store frequency, band, and mode data. Each memory may be tuned as a VFO.
- Lithium batt. memory back-up.
- Memory scan.
- Programmable band scan.
- Fluorescent tube digital display of frequency (100 Hz resolution) or time.
- Dual 24-hour quartz clocks, with timer.
- Three built-in IF filters with NARROW/WIDE selector switch. (CW filter optional.)
- Squelch circuit, all mode, built-in.
- Noise blanker built-in.
- Large front mounted speaker.
- RF step attenuator. (0-10-20-30 dB.)
- AGC switch. (Slow-Fast.)
- "S" meter, with SINPO scale.
- High and low impedance antenna terminals.
- 100/120/220/240 VAC operation.
- RECORD output jack.
- Timer REMOTE output (not for AC power).
- Muting terminals.

Specifications and prices subject to change without notice or obligation.



R-1000 High performance receiver • 200 kHz-30 MHz in 30 bands • AM, CW, SSB • 3 IF filters • noise blanker • RF attenuator • S-meter • 120-240 VAC • muting terminals • built-in speaker • digital display/clock/timer



R-600 General coverage receiver • 150 kHz-30 MHz in 30 bands • AM, CW, SSB • IF filters • noise blanker • RF attenuator • S-meter with SINPO scale • front mounted speaker • 3 antenna inputs • 100-240 VAC operation • record jack • muting terminals • digital display

LOG BOOK
AMATEUR RADIO

Optional accessories:

- VC-10 VHF converter for R-2000 covers 118-174 MHz
- YG-455C 500 Hz CW filter for R-2000
- HS-4 Headphones
- HS-5 Deluxe headphones
- HS-6 Lightweight headphones
- HS-7 Micro headphones
- DCK-1 DC cable kit for 13.8 VDC operation
- AL-2 Lightning and static arrester
- Service manuals are available for all receivers and most accessories.

Additional information on Kenwood all-band receivers is available from authorized dealers.

KENWOOD

TRIO-KENWOOD COMMUNICATIONS
1111 West Walnut Street
Compton, California 90220

KENWOOD

...pacesetter in Amateur radio



TS-130SE HF transceiver

- 80-10 meters including the new 10, 18 and 24 MHz bands. Receives WWV on 10 MHz.
- 200 W PEP/160 W DC input on 80-15 meters. 160 W PEP/140 W DC on 12 and 10 meters.
- Digital display, built-in.
- IF shift circuit.
- Speech Processor, built-in.
- Narrow/wide filter selection on CW and SSB with optional filters.
- Automatic SSB mode selection.
- RF attenuator, built-in.
- Effective noise blanker.
- Final amplifier protection circuit assures maximum reliability. Output power is reduced if abnormal operating conditions occur.
- Other features: VOX, CW semi break-in with sidetone, one fixed channel, and 25 kHz marker.
- SP-120 external speaker.
- VFO-120 remote VFO.
- YK-88C 500 Hz CW filter.
- YK-88CN 270 Hz CW filter.
- YK-88SN 1.8 kHz narrow SSB filter.
- AT-130 antenna tuner.
- MB-100 mobile mounting bracket.
- MC-30S/MC-35S hand microphones.
- MC-50 desk microphone.

Optional accessories:

- PS-30 or PS-430 matching power supplies.



TS-670 All-mode "Quad Bander"

- Covers 6, 10, 15 and 40 meter bands.
- 10 W output (4 W AM).
- Direct keyboard frequency selection.
- 80 memory channels.
- Programmable scanning.
- IF shift.
- All-mode squelch.
- Noise blanker.
- Narrow-wide filter selection.
- RF attenuator.
- Dual digital VFOs.
- Optional accessories:
 - PS-430 DC power supply.
 - GC-10 general coverage unit, 500 kHz to 30 MHz.
 - VS-1 voice synthesizer.
- FM-430 FM unit.
- YK-88C 500 Hz CW filter.
- YK-88CN 270 Hz CW filter.
- YK-88A 6 kHz AM filter.
- MC-60A deluxe desk microphone.
- MC-80 desk microphone.
- MC-85 multi-function desk microphone.
- VOX-4 VOX unit.
- MB-430 mobile bracket.

Complete service manuals are available for all Trio-Kenwood transceivers and most accessories. Specifications and prices are subject to change without notice or obligation.

KENWOOD

TRIO-KENWOOD COMMUNICATIONS
1111 West Walnut Street
Compton, California 90220

SOS DE USQS

THERE'S BAD NEWS from Laryl KM7Z at the **United States QSL Service (USQS)**. The bad news is that USQS is no more. For those of you not in the know, USQS was an incoming United States QSL bureau, handling DX and stateside cards. I don't imagine that the volume of DX cards coming in was very high (the ARRL bureaus have that end locked up), but the beauty of USQS (and the reason W2NSD/1 kept envelopes there) was the fact that *stateside* hams could send cards to *other* stateside hams in bulk. For free. In fact, if you sent along a few dollars for postage, Laryl would *look up* addresses for you and mail the cards out! Luckily, **Bill Wellborn K4CLA** has stepped in to fill the void with **KIQS** (Bill says to pronounce it "kicks"), which stands for the **K4CLA Incoming QSL Service**. Here's how it works: Send Bill a dollar for four stamped envelopes, which he will keep on file. Sort your outgoing (US only!) cards by call area, then alphabetically by suffix and send them to KIQS. Bill stuffs the on-file envelopes and sends cards out four times a year: in January, April, July, and October. The address for KIQS is 562 Oak Drive, Lexington SC 29072-9059. Laryl's USQS is returning all unused SASEs to their owners.

Hot Shots

IS IT TIME to start a monthly magazine called *Hams In Space*? It seems likely, with the announcement of two more possible missions. In March, 1986, **Dr. Ron Parise WA4SIR** will be aboard shuttle mission 61-E (Astro-1) as a Payload Specialist. Dr. Parise is an astronomer and will be making observations of Halley's Comet and other celestial objects. Ron has let NASA know that he would like to operate a packet-radio station from the shuttle; another first for ham radio! AMSAT is working with Ron in coordinating the operation. **Dr. Owen Garriott W5LFL**, America's first ham in space, is scheduled for a flight on mission 61-K, set for a September, 1986, launch. Owen will undoubtedly seek permission to operate from space.

Look! It's...

HALLEY'S COMET (rhymes with tally, though some swear it rhymes with holly) is getting brighter, and the hoopla surrounding it is getting really intense. There's Halley's Comet T-shirts, Halley's Comet Expeditions (\$1,500-\$5,000), "special" Hal-

ley's Comet telescopes, and so on. Don't think that hams have been forgotten; there is now a Halley's Comet Radio Watch. Project coordinator **Tania Miller WB9TKC** is looking for reports of unusual conditions on all bands, including amateur and CB frequencies, shortwave broadcast bands, and television channels. Your report should include the frequency (or band), time, date, your location, and the abnormal condition. Tania is offering a Comet QSL for your trouble. Because of the enormous hype surrounding the comet's return, many people are expecting a spectacular celestial event, complete with a fiery comet that is visible even during the day. 'Tain't so, friends. You'll need expert advice on where to *look* for the thing, and even then you'll need to look *very closely* to find it; a trip to your local book shop for a Halley's Comet manual (there are about a hundred of them) is in order. And don't rush out and buy a high-priced telescope, no matter *what* the ads claim. The best thing to use is a pair of low-power binoculars.

County Bounty

ARMADILLO COUNTY, TEXAS, has been created by a proclamation from Texas Governor Mark White. Between March 2 and December 31, 1986, any amateur operating along the Texas Independence Trail may give his QTH as Armadillo County, Texas, in order to celebrate the state's sesquicentennial. The **Texas DX Society** will be setting up operations along the trail throughout the year to give everyone a chance to work the new county. And Armadillo will be on the air during the massive **1986 Armadillo Run**, an attempt by the TDXS to activate *every county in the United States* (3,077!) during the 1986 County Hunters phone and CW contests (phone on May 3-4 and CW on July 26-27). These guys are really going to pull it



Texas Governor Mark White (center) creates a new county. That's KZ5M on the left and K5RC on the right. Photo by K5RVK.

off—they've spent the last year or so setting up regional and sectional coordinators all across the country. In 1983, club members operated from every county in Texas (254 counties). In 1984, the project expanded to cover Texas, Arkansas, Louisiana, and Mississippi! If you want up-to-the-minute information about the 1986 Run, get in touch with Tom Taormina K5RC, 3940 Bahler Avenue, Manvel TX 77578.

Canada Tries

CANADIAN AMATEURS got some good news and bad news regarding the Canadian Radio Relay League request for early access to the WARC bands. First, the Minister of Communications said that before any privileges on the 24-MHz band were granted, commercial stations occupying the band would have to be either shut down or moved to another part of the spectrum. Also, certain amendments to the General Radio Regulations would need to be made, something that has in the past taken years to accomplish. Only a month later, the Minister announced that most commercial users of the 24-MHz band had been removed and that the process for amending the rules could begin soon. He also noted that an amendment to the Regulations was already under way to allow amateur use of the 18-MHz band, which had already been cleared of commercial users.

Goldwater Winner

THIS YEAR'S Goldwater Scholarship Award went to 18-year-old Clark Barrow KI4UT, of Cocoa, Florida. Clark plans on a career in satellite communications doing research and development. He is working at NASA's Kennedy Space Center at a job won as a prize in a science contest. Clark said that he will use the \$5,000 prize to help pay for an Electrical Engineering degree from Auburn University.

Weirdness

DON'T TOUCH THAT DIAL! In fact, don't even turn on your receiver! Legislation introduced into the House of Representatives by Robert Kastenmeier (D-Wisconsin) and Carlos Moorhead (R-California) would, if signed into law, make the reception of nearly every type of radio transmission a Federal offense. The **Electronic Communications Privacy Act of**

1985, HR-3378, is the name of this travesty and its backers (mainly the cellular-telephone industry) want to make it a crime to receive any radio signal that does not fall into one of these categories: distress calls, Amateur Radio Service, Police or Fire Radio Service, CB, broadcasts intended for the general public, and walkie-talkies. What this Bill tries to do is extend the laws against wiretapping to the radio spectrum. In fact, *monitoring an amateur-radio phone patch* would be illegal under this proposal. This is obviously absurd, but the Bill has *strong support and not much resistance!* Sit down *right now*, write a letter to your Congressmen, and tell them that you think that HR-3378 is a direct attack on your rights as a citizen of the United States.

30 Days

30 DAYS HATH SEPTEMBER, but not exam applicants, says the FCC. You no longer have to wait 30 days before retaking a license exam that you have failed. The Commissioners felt that, "There is no persuasive evidence in the record that an applicant who has waited 30 days between tests will be better prepared for the next test than one who has waited 27 days, or 13 days, or 7 days, or any other period of time." The existing regulations covering the Volunteer Examination program already specify that questions must change from test to test, so there won't be a problem with someone taking a test on Saturday and seeing the same questions on a Sunday test. And, since each VE Coordinator creates its own tests from a large pool of questions, it's not likely that two VECs will prepare identical exams.

Who's On First?

IT LOOKS LIKE the absolute very first legal amateur signal on the new 900-MHz band was transmitted by K9MK/R, a repeater built by Mike Krzystyniak K9MK/5, Bill Cantrell WD5CVG, and Greg Raven KF5N. These guys, all members of the Motorola Amateur Radio Club, decided to beat everyone to the punch and built a complete repeater system out of surplus Motorola mobile radios in under three weeks! The machine has an input of 908.000 MHz and an output of 920.000 MHz and serves a four-county area near Ft. Worth, Texas. Another Motorola repeater can be found in Chicago on 909.000/921.000 MHz serving the northwest suburbs.

XE Permits

MEXICO IS UNOFFICIALLY granting temporary amateur licenses to US citizens visiting the country. In a story which appeared in the *W5YI Report*, Chris Petroff

N5HQN/XE2BSG reported that the Secretariat of Communications and Transport has authorized the licenses. The temporary permit is valid for the length of the amateur's visit to Mexico as stated on his or her visa. Petroff believed that the permit was for a Class II Mexican license, which allows 250 Watts on HF and 100 Watts on VHF.

Roll 'Em

IF YOU MISSED the action during space-shuttle mission 51-F (Tony England W0ORE and John-David Bartoe W4NYZ), take heart. Copies of the tapes Tony and John-David used to log are now available from the American Radio Relay League. Just send League archivist Karl Townsend the date and orbit number that interests you and he'll generate the tape that you need. (You might want to write or phone first to check out prices. If you write, enclose an SASE.) Videotapes of the SSTV images sent to and from *Challenger* are also available. Robot, the company that manufactured the 1200C scan converter carried on the mission, is working "between the lines," using arcane techniques in an attempt to recover as much of the uplinked video information as possible. In many cases there were so many signals competing on the frequency that only bits and pieces of video appear on the tapes. QSL cards are available from the ARRL for two-way contacts, reception reports, confirmed reception by *Challenger* of uplinked SSTV, and so on. Send an SASE to the ARRL, 225 Main Street, Newington CT 06111.

Erratum

PAGE 82 of our November, 1985, issue contains an error. In our review of the ICOM IC-735, N1BLH says that the rig's microprocessor gets its instructions from a lithium-battery-backed RAM. A conversation with ICOM revealed that this is not the case. Only the memories are battery-backed: The instructions are stored in a ROM.

Prefix Mix

THE PREFIX FOR CT2 AZORES has been changed to CU. The number after the prefix now refers to each of the nine islands of the Azores Archipelago: CU1 Santa Maria, CU2 Sao Miguel, CU3 Terceira, CU4 Graciosa, CU5 Sao Jorge, CU6 Pico, CU7 Faial, CU8 Flores, and CU9 Corvo. CU0 is reserved for repeaters. Some CT2 amateurs now have completely different calls, while others have only a different prefix. There also is a new address for the Azores QSL Bureau: it's Associacao de Radioamadores dos Acores, PO Box 211, 9 503 Ponta Del Gada, Azores Islands.

Status Quo

GORDON GIRTON W6NLG wants the FCC not to issue any more "preferred" call-signs. His petition to the Commission requests that all 1-by-3 K and W calls be removed from the list of available call-signs until all other combinations have been exhausted. Gordon notes that many hams equate 1-by-3 K and W calls with the number of years licensed—most of those calls are held by "old-timers" and can be seen as a sort of status symbol. WA, WB, and WD calls are also covered in the petition. There's been no word from the Commission on this one, yet.

Land of OST

THERE'S A CHANCE that RM-4829 and RM-4831, the Dockets before the FCC dealing with land-mobile use of our 220-MHz allocation, are dead. Tom Stanley, Deputy Chief of the Office of Science and Technology, has been named to fill the OST Directorship vacated by Bob Powers. Both RM-4829 and RM-4831 were being handled by the OST, and it may take quite some time before the new administration decides what should be done about them. Art Reis K9XI, Editor of *220 Notes*, feels that the issue is indeed dead and that the only reason the FCC would bring out either Docket as a Notice of Proposed Rulemaking would be to resolve the question of Land Mobile Service interference to television channel 13.

Free Press

AT THE RISK of causing a strike at the 73 mail room, we're making available yet another freebie! This time your SASE will net a **Genuine FCC Emission Classification List**. No longer will you have to remember all of those silly numbers and letters like J3E, A1A, and F3E—you'll have the entire list right at your fingertips! This list is essential to accurate logging, and no ham should be without it. Get your free copy by sending an SASE to 73 Magazine, Editorial Offices, 80 Pine Street, Peterborough NH 03458, Attn: Emissions.

Thanks

THIS MONTH, "QRX" comes to you courtesy of *Gateway*, *Westlink*, the Personal Radio Steering Group, *220 Notes*, the North Florida ARS *Balanced Modulator*, *The VHF Journal*, and the Arizona Repeater Association *Squelch Tail*. Send your "QRX" items (photos, too!) to 73 Magazine, Editorial Offices, 80 Pine Street, Peterborough NH 03458, Attn: QRX. And have a great 1986!

KENWOOD

...pacesetter in Amateur radio

“Digital DX-terity!”



TS-430S

Digital DX-terity—that outstanding attribute built into every Kenwood TS-430S lets you QSY from band to band, frequency to frequency and mode to mode with the speed and ease that will help you earn that dominant DX position from the shack or from the mobile!



- **Covers all Amateur bands**
160 through 10 meters, as well as the new 30, 17, and 12 meter WARC bands. High dynamic range, general coverage receiver tunes from 150 kHz to 30 MHz. Easily modified for HF MARS operation.
- **Superb interference reduction**
Eliminate QRM with the IF shift and tuneable notch filter. A noise blanker suppresses ignition noise. Squelch, RF attenuator, and RIT are also provided. Optional IF filters may be added for optimum interference reduction.

- **Reliable, all solid state design.**
Solid state design permits input power of 250 watts PEP on SSB, 200 watts DC on CW, 120 watts on FM (optional), or 60 watts on AM. Final amplifier protection circuits and a cooling fan are built-in.
- **Memory channels.**
Eight memory channels store frequency, mode and band data. Channel 8 may be programmed for split-frequency operation. A front panel switch allows each memory channel to operate as an independent VFO or as a fixed frequency. A lithium battery backs up stored information.
- **Programmable, multi-function scan.**
- **Speech processor built-in.**
- **Dual digital VFOs.**
- **VOX circuit, plus semi break-in with sidetone.**

Optional accessories:

- PS-430 compact AC power supply
- SP-430 external speaker
- MB-430 mobile mounting bracket
- AT-130 compact antenna tuner covers 80-10 meters, incl. WARC bands
- AT-250 automatic antenna tuner covers 160-10 meters, incl. WARC bands
- TL-922A 2 kW PEP linear amplifier
- FM-430 FM unit
- YK-88C (500 Hz) or YK-88CN (270 Hz) CW filters
- YK-88SN (1.8 kHz) narrow SSB filter
- YK-88A (6 kHz) AM filter
- MC-42S UP/DOWN hand mic.
- MC-60A/80/85 deluxe desk mics.
- SW-2000/200A SWR/power meters
- SW-100A SWR/power/volt meter
- PC-1A phone patch
- HS-4, HS-5, HS-6, HS-7 headphones



KENWOOD

TRIO-KENWOOD COMMUNICATIONS
1111 West Walnut Street
Compton, California 90220

Complete service manuals are available for all Trio-Kenwood transceivers and most accessories. Specifications and prices are subject to change without notice or obligation.

Spectrum Repeater/Link Boards & Sub-Assemblies

New FL-4 UHF Helical Resonators
Installed in Rcvr.,
or FL-4H Preselector Unit

These are professional "Commercial Grade" Units—Designed for Extreme Environments (-30 to 60° C.) All Equipment Assembled & Tested.



For 10M,
2M,
220 MHz,
& 440 MHz



IMPROVED SCT410B TRANSMITTER ASSY.

SCT110 VHF Xmtr/Exciter Board

- 10 Wts. Output 100% Duty Cycle!
- Infinite VSWR proof
- True FM for exc. audio quality
- Designed specifically for continuous rpt. service. Very low in "white noise."
- Spurious—.75 dB. Harmonics—60 dB
- With .0005% xtal.
- **BA-30 30 Wt. Amp board & Heat Sink,** 3 sec. L.P. filter & rel. pwr. sensor.
- **BA75 75 Wt. unit also available.**

SCT110 Transmitter Assembly

- SCT110 mounted in shielded housing
- Same as used on SCR 1000 & 2000X
- Completely asmbld. w/F.T. caps, SO239 conn.
- 10, 30, or 75 Wt. unit.

SCT 410B UHF Transmitter Bd. or Assy.

- Similar to SCT110, 10 Wts. nom.
- **Now includes "on board" proportional Xtal Osc./Oven circuitry for very high stability!**
- **BA-40 40W. UHF AMP. BD. & HEAT SINK**

COMPLETE SHIELDED RCVR. ASSY.
VHF & UHF Receiver Boards
SCR200A-VHF SCR450A-UHF

- **Totally Advanced Design!**
- 8 Pole Front End Fitr. + wide dynamic range—reduces overload, spurious Resp. & Intermod.
- Sens. 0.25 μ V/12dB SINAD typ.
- Sel. -6dB @ \pm 6.5 KHz. -130dB @ \pm 30KHz. (8 Pole Crystal + 4 Pole Ceramic Filtrs.)
- 'S Meter', Discriminator & Deviation Mtr. Outputs!
- Exc. audio quality! Fast squelch! w/0.0005% Crystal. ("Super Sharp" IF Fitr. also avail.)

Complete Receiver Assemblies

- Rcvr. Bd. mounted in shielded housing.
- Completely asmbld & tested, w/F.T. caps, SO239 conn.
- As used in the SCR 1000/2000X. Ready to drop into your system!
- **UHF Rcvr. Assy. Now Available w/Super Sharp FL-4 Helical Resonators. Greatly reduces IM & "out of band" interference!**

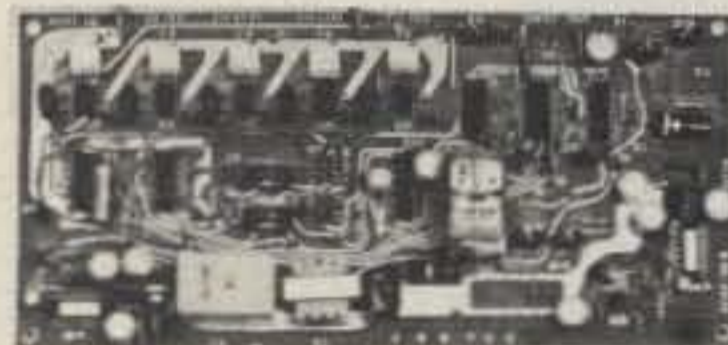

SCAP Autopatch Board

- Provides all basic autopatch functions
- Secure 3 Digit Access; 1 Aux On-Off function, Audio AGC; Built-in timers; etc. Beautiful Audio!
- 0/1 inhibit bd. also available
- Write/call for details and a data sheet

RPCM Board

- Used w/SCAP board to provide "Reverse Patch" and Land Line Control of Repeater
- Includes land line answering circuitry

Lightning Arrester For SCAP

- Gas Discharge Tube shunts phone line surges to ground
- Handles up to 40,000 Amps!
- The Best device available to protect Autopatch equipment from lightning damage. \$17.00 + S/H.

UHF
GaAsFET
option



FL-4H

Receiver Front-End Preselectors

- **FL-6:** 6Hi Q Resonators with Lo-Noise Transistor Amp (2M or 220 MHz)
- **FL-4H:** 4Hi Q helical resonators & Lo-Noise Tr. Amp. in shielded housing. (420-470 MHz)
- **Provides tremendous rejection of "out-of-band" signals w/out the usual loss!** Can often be used instead of large expensive cavity filters.
- Extremely helpful at sites with many nearby transmitters to "filter-out" these out-of-band signals.



SCR 500 VHF/UHF LINK/CONTROL RCVR.

- SCR200A or SCR450A rack mounted
- Available with or without meters and power supply

ID250A CW ID & Audio Mixer Board

- Improved! Now includes "audio mute" circuit and "Emergency Power" ID option.
- 4 input AF Mixer & Local Mic. amp.
- PROM memory—250 bits/channel.
- Up to 4 different ID channels!
- Many other features. Factory programmed.

CTC100 Rptr. COR Timer/Control Bd.

- Complete solid state control for rpt. COR, "Hang" Timer, "Time-Out" Timer, TX Shutdown/Reset, etc.
- Includes inputs & outputs for panel controls & lamps.

Repeater Tone & Control Bds.

For SCR1000/4000 & CTC100/ID250 only

- **TMR-1 "Kerchunker Killer" or "Time Out Warning Tone" Bd.**
- **TRA-1 "Courtesy Tone Beeper" Bd.**
- **PSM-1 Power Supply Mod Kit** replaces Darlington pass transistor in older SCR1000/4000s.

Call or Write for Data Sheets

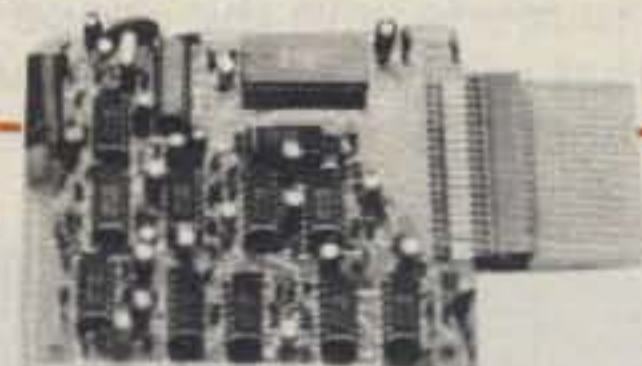

TTC300 TOUCH TONE CONTROLLER

- High performance, Super versatile design
- Uses new high quality Xtal Controlled Decoder IC, w/high immunity to falsing
- Decodes all 16 digits
- 3 ON/OFF Functions per Main Card. Easily expandable to any no. of functions w/Expansion Cards.
- Field Programmable via plug-in Coded Cards
- Latched or pulsed outputs; many unique 3-digit codes available. *Not basically 1-digit as with competitive units.*
- Transistor Switch outputs can directly trigger solid state circuitry or relays, etc. for any type of control function.
- Interfaceable to Auxiliary Equipment
- Low Power Consumption CMOS Technology. 5VDC Input. Gold-plated connectors.



SPECTRUM COMMUNICATIONS

1055 W. Germantown Pk, S1 • Norristown, PA 19403 • (215) 631-1710 • Telex: 846-211

ICOM 144, 220 and 440MHz

MOBILES



The World's Most Compact Mobiles

ICOM's three ultra compact mobiles...the IC-27A 2-meter, the IC-37A 220MHz and the IC-47A 440MHz... are the smallest mobiles available.

Even in such a small package the 25 watt mobiles contain an internal speaker which makes them fully self-contained and easy to mount.

Size. The ICOM compacts measure only 5½"W x 1½"H x 7"D (IC-47A is 9" deep)... which allows them to be mounted in various "compact" locations. Yet the compacts have large operating knobs which are easy to use in the mobile environment.

More Features. Other IC-27A/37A/47A standard features include a mobile mount, IC-HM23 DTMF mic with up/down scan and memory scan, and internally adjustable transmit power. An optional IC-PS45 slim-line external power supply and IC-SP10 external speaker are also available.

Internal Speaker



32 PL Frequencies. The IC-27A/37A/47A come complete with 32 PL frequencies.

9 Memories. The compact mobiles have 9 memories which will store the receive frequency, transmit offset, offset direction and PL tone. All memories are backed up with a lithium battery.

Speech Synthesizer. To verbally announce the receive frequency, an optional UT-16 voice synthesizer is available.

Scanning. The ICOM compacts have four scanning systems...memory scan, band scan, program scan and priority scan. Priority may be a memory or a VFO channel...and the scanning speed is adjustable.



Stacking Mobile Mounts. The IC-27A/37A/47A can be stacked to provide a three band mobile station. Each band is full featured and will operate even when another band is in use.

The IC-27A/37A/47A provide superb performance in the mobile radio environment. See them at your local ICOM dealer.



First in Communications

ICOM America, Inc., 2380-116th Ave NE, Bellevue, WA 98004 / 3331 Towerwood Drive, Suite 307, Dallas, TX 75234

All stated specifications are approximate and subject to change without notice or obligation. All ICOM radios significantly exceed FCC regulations limiting spurious emissions. MOBILE385

More Cheap Talk

*Here's the beginning of the end of your sanity —
 a text-to-speech algorithm that
 lets your computer speak its mind!*

As promised in my article, "Talk Is Cheap" (73, October, 1985), I have developed a text-to-speech algorithm for the speech synthesizer I described, and in this article I will present what I came up with. Before getting into the details, let me review the basic hardware and software which make up "Cheap-Talker."

Hardware

The hardware used is an APPLE II bus-compatible circuit board. The schematic is shown in Fig. 1. It uses the SPO256 voice-synthesizer chip manufactured by Gen-

eral Instruments and marketed by Radio Shack as part no. 276-1784. This chip retails for \$12.95. When you go to Radio Shack to purchase it, make sure you do not mistakenly buy part no. 276-1783. This also is a voice-synthesizer chip but it uses an external ROM to produce only 36 words. It also does not come with the comprehensive technical data pamphlet accompanying 276-1784. The latter will have "SPO256-AL2" stamped on it.

Cheap-Talker also uses an MC6821 parallel interface adapter for communica-

tions with the Apple bus. Port B is used to transfer data from the computer to the synthesizer. The CB2 line provides a negative-handshaking pulse whenever data is written into port B. This signals the synthesizer that data is ready. The LRQ (Load Request) line is connected to bit 7 of port B so it can be tested easily to find out if the synthesizer is ready for yet more data.

I've also used the LM386 audio amplifier as recommended in the data sheet. It works very well, providing an adequate volume for normal indoor use. This circuit

can be constructed by the freehand etching of a circuit board or wire-wrapping on a protoboard. I have done both with equal success.

Software

The software driver used to make the chip work is shown in Listing 1. The entire driver program and allophone buffer fits in just 208 bytes. The program alone is only 48 bytes. This program, when called at location \$300 (768 decimal), will send the allophone codes in the allophone buffer located in locations \$341-\$3CF (833-975 decimal) to the synthesizer, one at a time. Location \$340 (832 decimal) contains the number of allophones to be sent; it allows 142 allophone codes to be sent, which is more than enough for most messages composed of a number of words. Most words contain fewer than 20 allophone codes. Since the text-to-speech algorithm translates only one word at a time, there is plenty of room in the buffer to speak even the longest of words.

The INIT portion configures port B of the 6821 chip to have bits 0-5 in the output mode and bits 6-7 in the input mode. Bit 7 is used to monitor the LRQ pin on the synthesizer to find out when it is ready for another allophone. The CB2 pin is put in

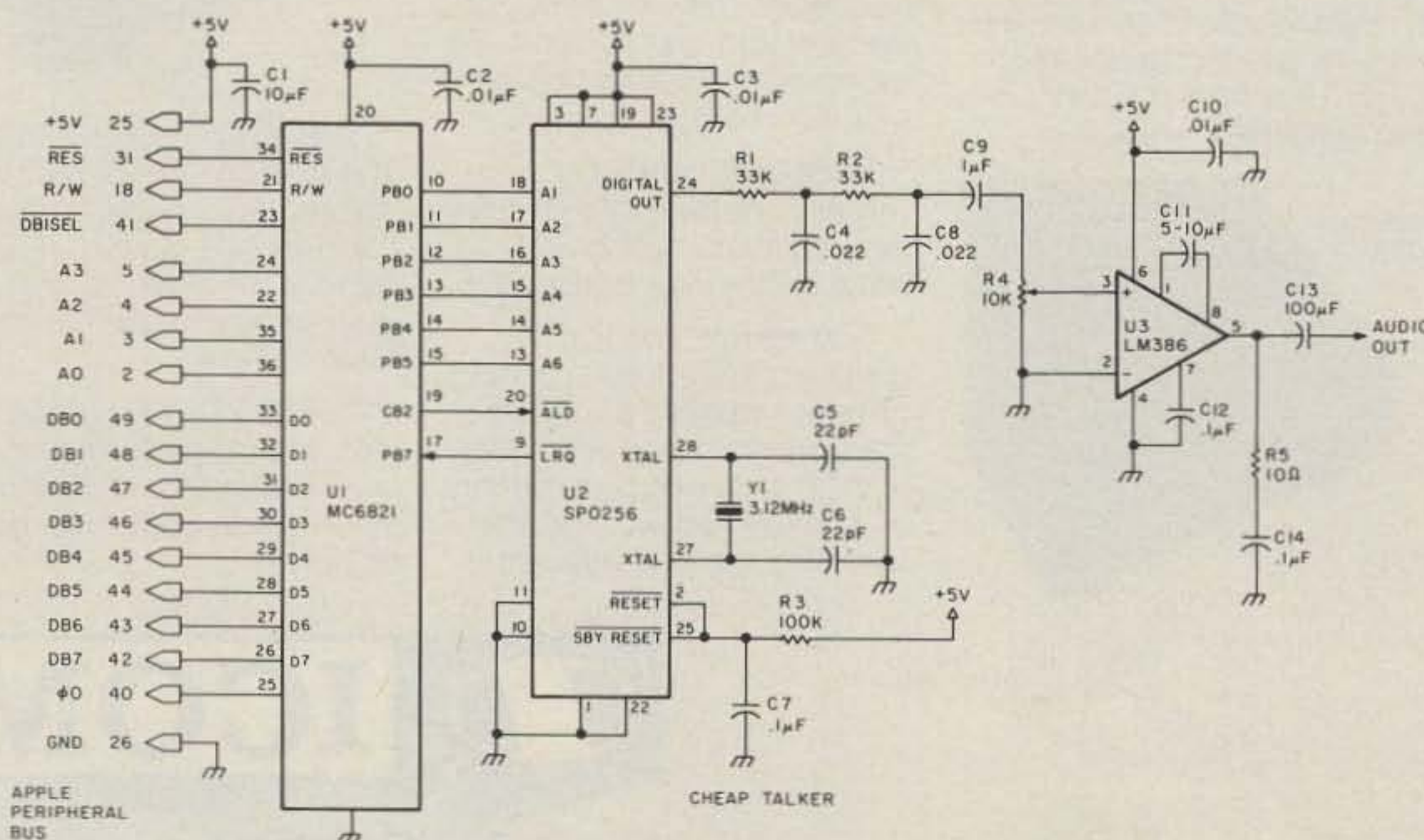

Fig. 1. Schematic of the Cheap-Talker.

BACK ISSUES

October 1984

Fall antenna issue—9 skyhooks!

November 1984

Color Computer SSTV, TVI cure

December 1984

Touchtone data display, transistor tutor, line conditioner

January 1985

ICOM mods, extra VIC-20 memory, shoestring RTTY

February 1985

OSCAR uplink amp, HF helicals, 6-meter CB

March 1985

Volunteer exams, talking repeater controller

April 1985

Dayton Hamvention special! Ishmod's Journal, the amazing Hat-Tenna

May 1985

Antennas! A baker's dozen

June 1985

Special issue—RTTY, 9N1MM profile

July 1985

Dayton in pictures, world's largest array, add-on digital display

August 1985

Build a ham transceiver, razor-blade antenna, HW-101 updates

September 1985

1985's Hottest Antennas—Nine skywires!

October 1985

25th Anniversary Special! Inspecting floppy disks, WWII spy radio, 1296-MHZ downconverter

November 1985

Holiday Shopping Guide, short 160m antenna, HF-to-Oscar transceiver, simple signal generator

In each back issue, you'll also find our regular features as well as reviews and new product announcements.

Each back issue costs \$3.50 plus \$1.00 shipping and handling. On orders of 10 or more back issues, there is a flat \$7.50 shipping and handling fee. Send your check or money order to 73, Attn: Back Issue Orders, 80 Pine St., Peterborough, NH 03458.

BACK ISSUES

"When You Buy, Say 73"

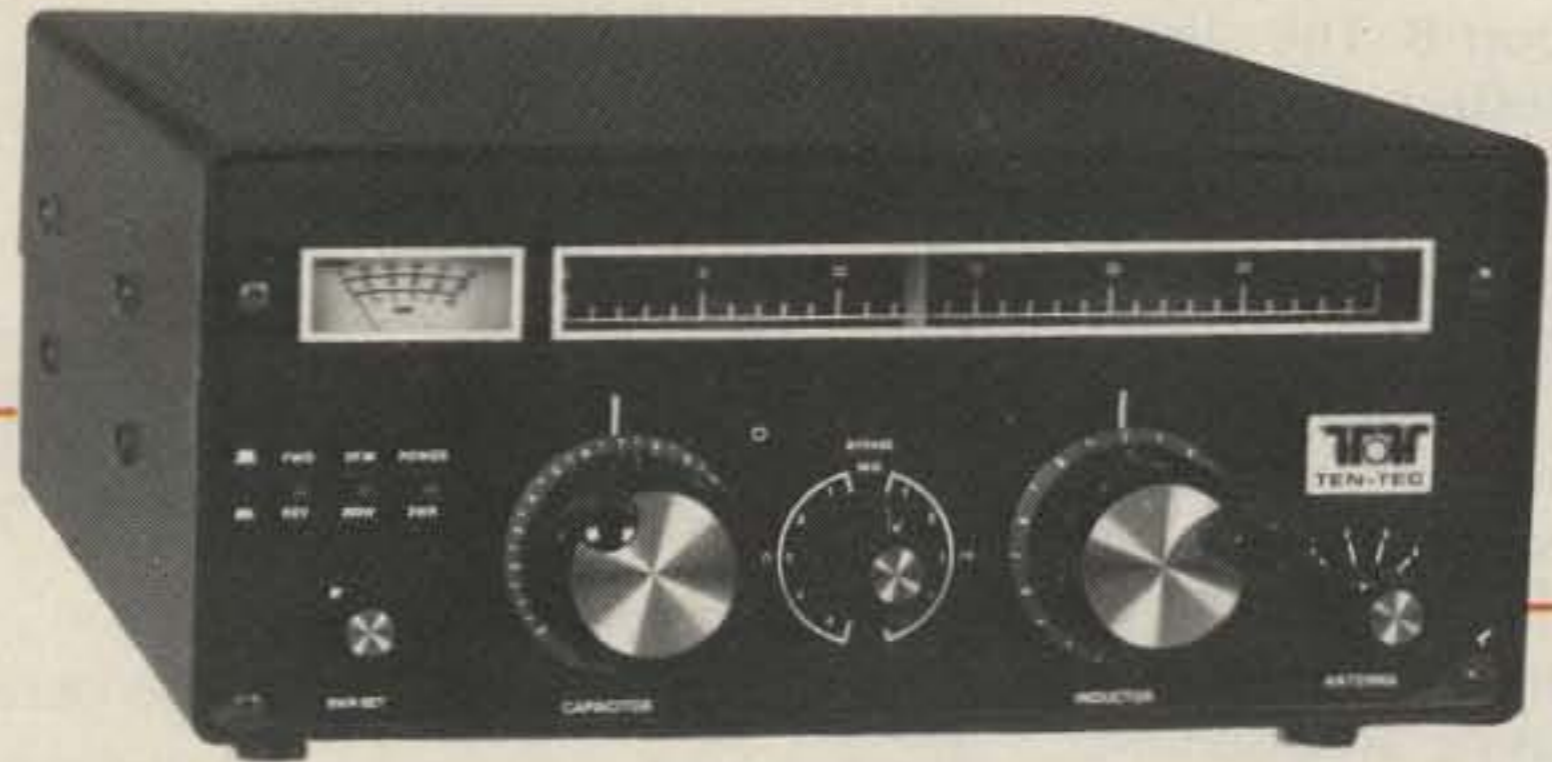

NEW!

EASY, FUN KIT!

New 2 kW tuner kit from TEN-TEC ends constant retuning, guarantees best match, and saves \$80! Model 4229 Only \$219

Here's the best antenna tuner in amateur radio!

The best quality components, best design, and the best value.



- Reversible "L" circuit guarantees best possible match and widest bandwidth—you may need to tune only once to cover the higher bands and only two or three times on lower bands.
- Finest quality parts—ceramic insulators—ceramic inductor form—heavy duty ceramic switch with silver contacts—silver plated roller inductor—
- Built-in SWR bridge shows ratios from 1:1 to 5:1
- Built-in 2 kW dual-range watt meter shows power levels from 10 to 2000 watts
- Handles 2 kW PEP, 1 kW CW
- Frequency range 1.8—30 MHz continuous coverage
- Built-in balun—matches variety of antennas, balanced or unbalanced, to 50 ohm unbalanced outputs
- Built-in bypass switch
- 4-position antenna selector
- Coax connectors plus post terminals
- Lighted linear dial scale for easy tuning
- Black finished aluminum cabinet with stainless steel bail (5½" h × 12¾" W × 13¼" d)
- Also available assembled as Model 229 in slightly different styling at \$299

See your TEN-TEC dealer or write for details:

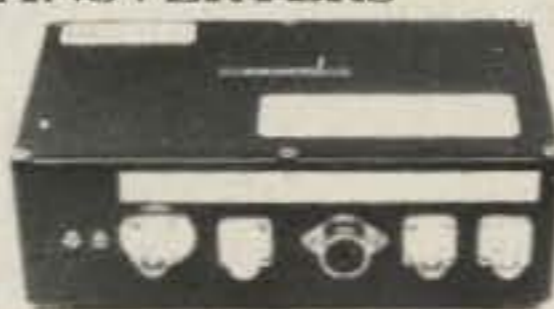
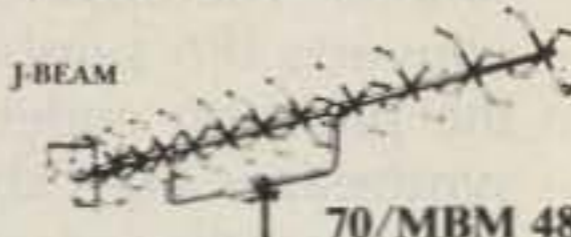

TEN-TEC, INC.

Highway 411 East, Sevierville, TN 37862.

VISA		WORK THE U.H.F. BANDS		MasterCard	
TRANSVERTERS		ANTENNAS (incl. 50 ohm balun)		POWER AMPLIFIERS	
				2meters:	
MML144-28	\$189.95	2M-10XV22M	\$69.95	MML144-200-S	\$399.95
MML144-28(R)	\$319.95	70cm-70/MBM28	\$39.95	MML144-100-LS	\$249.95
MML432-28(S)	\$279.95	70/MBM48	\$64.95	MML144-100-S	\$209.95
MML1296-144G	\$329.95	70/MBM88	\$94.95	MML144-50-S	\$149.95
MML1268-144	\$259.95	23cm-268-1Y	\$49.95	MML144-30-LS	\$109.95
		1296-1Y	\$49.95		
				70cm:	
				MML432-100	\$379.95
				MML432-50	\$199.95
				MML432-30-L	\$219.95
		Spectrum International, Inc. Post Office Box 1084S Concord, Mass. 01742 USA		Send \$4.00 stamp for full details of all our VHF, UHF & MHz kits. WAVE items.	
				(617) 263-2145	

the "pulse on write" mode which sends a negative pulse out when data is written into port B. This signals the synthesizer that the allophone data is ready.

Note that the addresses for the PIACRB (Control Register B) and PIADPRB (Data Direction and Peripheral Register B) registers are offset in lines 15 and 16 for use in slot 3 of the Apple. If you are using an assembler which uses similar nomenclature, you could change the slot by changing the \$30 to \$x0, where x is the slot number. If you are typing in the hexadecimal values for the program, you would change the \$BF in locations \$303 and \$30D to \$8F + \$n0 where n is the slot number. You would also change the \$BE in locations \$308 and \$327 to \$8E + \$n0.

The SPEAK routine takes the allophones and sends them to the synthesizer via the PRONOUNC routine. SPEAK uses the value in location \$340 to initialize the Y register as a counter to keep track of the number of allophones sent. The X register is used as a pointer to the various values in the allophone buffer.

The PRONOUNC routine saves the allophone data in the accumulator on the stack while it checks the LRQ line to see if the synthesizer is ready for the next allophone. It does this by reading the value in bit 7 of Peripheral Register B which, as was mentioned earlier, is set up as an input. If bit 7 is a 0, then the synthesizer is ready to receive data via Peripheral Register B.

This simple hardware/software combination forms the basis of the speech synthesizer system I call Cheap-Talker. The text-to-speech algorithm and rules I will describe next will use it to produce unlimited speech based on English words sent to it.

```

0000 1      TTL "CHEAP-TALKER"
0000 2 1
0000 3 *****
0000 4 * CHEAP-TALKER *
0000 5 * DRIVER SOFTWARE FOR *
0000 6 * SPO-256 VOICE SYNTHESIZER *
0000 7 * BY THOMAS C. JOHNSON *
0000 8 * WBAHQX *
0000 9 * DEC 7, 1984 *
0000 10 *****
0000 11 1
0000 12      ORG $300
0000 13 1
0000 14 1
0000 15 1
0000 16 PIADPRB EQU $C0BE+$30 ; SLOT 3 DATA DIRECTION AND OUTPUT BUFFER
0000 17 PIACRB EQU $C0BF+$30 ; SLOT 3 CONTROL REGISTER
0000 18 SOUNDS EQU $340 ; ALLOPHONE BUFFER- $340 CONTAINS NO. OF ALLOPHONES TO FOLLOW
0000 19 1 ; $341-$3CF CONTAIN THE ALLOPHONES TO BE SPOKEN
0000 20 1
0000 21 1
0000 22 INIT:
0000 A9 00 23 LDA #0
0000 B0 0F C0 24 STA PIACRB ; ENABLE DATA DIRECTION REGISTER
0000 B1 0F 3F 25 LDA #$3F
0000 B2 0F 0E C0 26 STA PIADPRB ; BITS 0-5=OUTPUTS, BITS 6-7 INPUTS
0000 B3 0F 2C 27 LDA #$2C
0000 B4 0F 0F C0 28 STA PIACRB ; CB2 IN PULSE MODE
0000 B5 0F 1
0000 B6 0F 1
0000 B7 0F 1
0000 B8 0F 1
0000 B9 0F 1
0000 BA 0F 1
0000 BB 0F 1
0000 BC 0F 1
0000 BD 0F 1
0000 BE 0F 1
0000 BF 0F 1
0000 C0 0F 1
0000 C1 0F 1
0000 C2 0F 1
0000 C3 0F 1
0000 C4 0F 1
0000 C5 0F 1
0000 C6 0F 1
0000 C7 0F 1
0000 C8 0F 1
0000 C9 0F 1
0000 CA 0F 1
0000 CB 0F 1
0000 CC 0F 1
0000 CD 0F 1
0000 CE 0F 1
0000 CF 0F 1
0000 D0 0F 1
0000 D1 0F 1
0000 D2 0F 1
0000 D3 0F 1
0000 D4 0F 1
0000 D5 0F 1
0000 D6 0F 1
0000 D7 0F 1
0000 D8 0F 1
0000 D9 0F 1
0000 DA 0F 1
0000 DB 0F 1
0000 DC 0F 1
0000 DD 0F 1
0000 DE 0F 1
0000 DF 0F 1
0000 E0 0F 1
0000 E1 0F 1
0000 E2 0F 1
0000 E3 0F 1
0000 E4 0F 1
0000 E5 0F 1
0000 E6 0F 1
0000 E7 0F 1
0000 E8 0F 1
0000 E9 0F 1
0000 EA 0F 1
0000 EB 0F 1
0000 EC 0F 1
0000 ED 0F 1
0000 EE 0F 1
0000 EF 0F 1
0000 F0 0F 1
0000 F1 0F 1
0000 F2 0F 1
0000 F3 0F 1
0000 F4 0F 1
0000 F5 0F 1
0000 F6 0F 1
0000 F7 0F 1
0000 F8 0F 1
0000 F9 0F 1
0000 FA 0F 1
0000 FB 0F 1
0000 FC 0F 1
0000 FD 0F 1
0000 FE 0F 1
0000 FF 0F 1

```

Listing 1.

Algorithm

The algorithm I came up with was inspired by work done at the United States Naval Research Laboratory described in a 100-page report entitled "Automatic Translation of English Text To Phonetics By Means Of Letter-To-Sound Rules." That's quite a title, but it's also quite a fascinating report.

In this report, an algorithm and 329 rules which translate English words into the International Phonetic Alphabet (IPA) are described. The algorithm also converts IPA symbols into the phonetic codes of the synthesizer the Laboratory was using (the Federal Screw Works Votrax VS-6 audio response unit). The software developed for the algorithm was written and described in SNOBOL, and as a result I did not find it very useful in writing my algorithm for the 6502 microprocessor. I did, however, rely heavily on

the rules they developed and devised my own algorithm which would utilize those rules and generate the allophone codes used by the SPO256 chip.

The algorithm I developed (called Translator) is written in 6502 assembly code and occupies 2,186 bytes. If a 16K card is available, then it resides in the card at \$D000. Otherwise it resides at \$7600. It is composed of 37 subroutines, each having a specific purpose. A chart showing the subroutines and their relationships is shown in Fig. 2.

Each subroutine calls upon the subroutine connected to it in the row below it to accomplish its task. For example, TRANSLATE, the main routine, calls these routines to do its job: ILLEGALS, COUNTCHR, FINDRULE, GETRULE, TESTRULE, CHKRULE, ADVRP, DEBUG, APPEND, and SPEAK. In turn, FINDRULE

will call the routines PUNCT and NUMBERS, and so on.

When a word is placed in the word buffer and Translator is called, it analyzes each letter in the word and searches the rules to find those which best match the context of each of the letters and uses the allophones associated with the chosen rules to speak the word. This is done in the following manner (please refer to Fig. 3).

First, TRANSLATE calls COUNTCHR to count the number of characters in the input word string, convert them to uppercase if they are not already, and set the MSB in each one. If there are no characters in the word string, TRANSLATE is finished. Otherwise the variables CC, ALOFON, and ABUF are initialized. CC points to the currently testable character in the input word string. ALOFON points to the next position in the allophone buffer to store an allophone code. ABUF contains the current number of allophones in the allophone buffer to be spoken.

Next, the currently testable character is loaded for analysis. If it is an illegal character which can't be translated, it is ignored, CC is moved to the next character in the word string, and the next character is loaded if it is not the end of the word. If the character was OK, FINDRULE locates the rule group which pertains to the character. Then GETRULE loads sections A, B, C, and D from the rule into separate buffers. TESTRULE tests section B, then A, then C to see if they fit. All of them must pass for the rule to pass.

If the rule passed, it is checked by CHKRULE to see if it has a higher priority than any of the previous rules checked in the group. If it does, it records the address and the priority for comparison by any following rules in the group. After

The Problem Solver...

CELLULAR COMPATIBLE

The RF Wattmeter Model 81000-A from Coaxial Dynamics, Inc. does more than provide accurate rf measurements. Testing of transmission lines, antennas, connectors, filters and related components can reveal unknown problems and assure optimum equipment performance.

For more information on the 81000-A Wattmeter or any of the complete line of Coaxial Dynamics RF products and OEM components please contact Coaxial Dynamics, Inc. Special elements available for cellular frequencies. Call factory for name of local distributor.



COAXIAL DYNAMICS, INC.

15210 Industrial Parkway, Cleveland, OH 44135 • (216) 267-2233
Outside Ohio, WATS: (800) Coaxial, Telex: 980-630

THREE OF AMATEUR RADIOS BEST KEPT SECRETS

KC-1

The finest CW keyer at any price, the famous "Kansas City Keyer" boasts 1500 characters of memory, 14 buffers and full programmability.

"The Contesters Choice"

This 6502 microprocessor design has 32-K of eeprom and 16-K of ram. Using simple user friendly programming, the owner can automate most contest operations, and much more.



Model KC-1

Complete KC-1 systems begin at only \$219.95

GP-1

The "Ground Plane One" is a ten inch diameter, 24 point, cast alu-malloy, buss used to attach the radials of any vertical antenna.

Enjoy the benefits of a professional looking ground system for only \$24.95.

D-LAY-5

An easy to install delay circuit, that works on the CDE/HYGAIN HAM II, III, IV, and TAILTWISTER rotor systems.

This system mounts inside the control box and inserts a five second delay into the brake circuit. Only \$21.95

— ORDER OUR FACTORY DIRECT CATALOG —

LANCE JOHNSON ENGINEERING
P.O. BOX 7363
KANSAS CITY, MISSOURI 64116

OUT NOW!

FREE

THE DICK SMITH ELECTRONIC ENTHUSIAST'S CATALOG

132 PAGES CRAMMED WITH KITS, BOOKS, COMPONENTS, DATA, HAM GEAR AND MORE PLUS BONUS COUPONS WORTH \$2 REDEEMABLE OFF YOUR 1st ORDER

Rush me my copy of the Dick Smith Catalog, I enclose \$1 to cover shipping

Name

Address

City

Zip

DICK SMITH ELECTRONICS INC.
P.O. Box 2249, Redwood City CA 94063



FREE SATELLITE TV



800-4-SATMAN



NEW 24 Page Buyer's Guide With Guaranteed Lowest Prices

- Explains all about FREE 100 channel Satellite TV and how to shop for an earth station!
- Lists GUARANTEED LOWEST PRICES...we will not be undersold, save 30-50% over local dealer prices!
- Tells how to easily and quickly Install-Your-Own earth station and save \$400 or more!
- Shows how to demonstrate and sell earth stations from your home and earn extra money!

uniden

BALCOA

Panasonic

CHAPARRAL

WORLDWIDE

ORTEL

The new SATMAN Buyer's Guide is a necessity for any prospective or current earth station owner who wants to save big money on name brand satellite products and also earn some extra money. Buy direct, Do-It-Yourself, and save with SATMAN. Toll free ordering, no sales tax (IL only), major credit cards accepted, huge in-stock inventories available, and fast UPS shipping anywhere in U.S. Check with SATMAN before you buy...We will not be undersold! Call now for your free 24 page SATMAN Buyer's Guide.

1-800-4-SATMAN

1-309-692-9582 Illinois



SATMAN

5017 N. MELODY • PEORIA, IL 61614 • 1-800-4-SATMAN

clip and save



Catch of the day!

Have you been trawling the bounding main for a new product? We have just netted it—the TP-38 microprocessor controlled community repeater panel which provides the complete interface between the repeater receiver and transmitter. Scuttle individual tone cards, all 38 EIA standard CTCSS tones are included as well as time and hit accumulators, programmable timers, tone translation, and AC power supply at one low price of \$595.00. The TP-38 is packed like a can of sardines with features, as a matter of fact the only additional option is a DTMF module for \$59.95. This module allows complete offsite remote control of all TP-38 functions, including adding new customers or deleting poor paying ones, over the repeater receiver channel.

Other features include CMOS circuitry for low power consumption, non-volatile memory to retain programming if power loss occurs, immunity to falsing, programmable security code and much more. The TP-38 is backed by our legendary 1 year warranty and is shipped fresh daily. Why not set passage for the abundant waters of Communications Specialists and cast your nets for a TP-38 or other fine catch.



\$595.00 each
\$59.95 DTMF module

COMMUNICATIONS SPECIALISTS, INC.
 426 West Taft Avenue • Orange, CA 92665-4296
 Local (714) 998-3021 • FAX (714) 974-3420
 Entire U.S.A. 1-800-854-0547



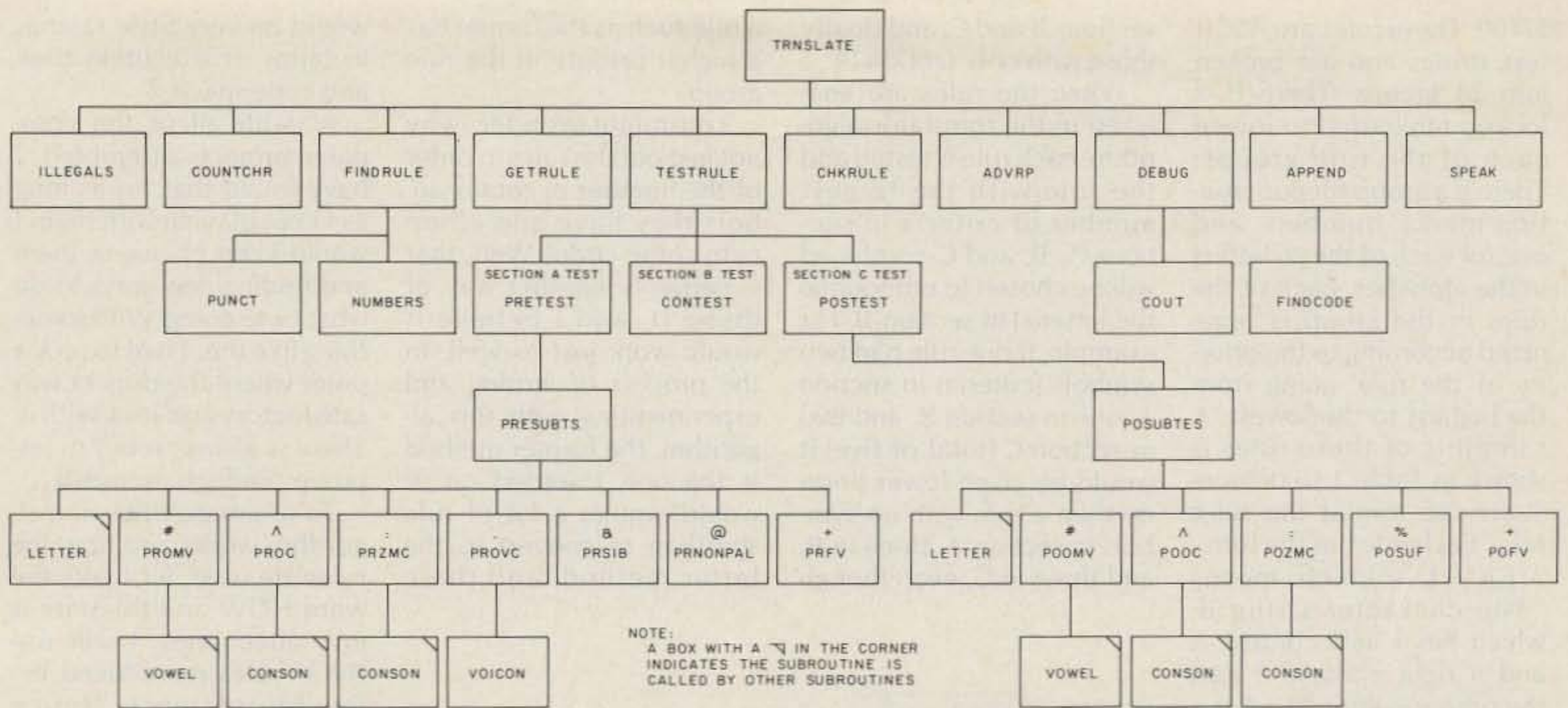

Fig. 2. Subroutine chart, translator text-to-speech algorithm.

that, or if the rule did not pass, ADVRP advances the pointer which points to the current rule in the group to the next rule. If zeros are found, the end of the group has been reached. Otherwise the rule is loaded and tested.

When all the rules have been tested and at least one of them passed, that rule (the one having the highest priority) is again loaded and the DEBUG routine is called. This routine, if the control flag is on, will send the text of the rule to the

screen to show which one has been found for the particular character. If the rule included any allophones in section D (some rules do not have any, indicating the character(s) in section B are silent), they are converted to hexadecimal codes and loaded into the allophone buffer at ALOFON by the subroutine APPEND. CC is moved to the next testable character in the word string.

If it has not reached the end of the word (indicated by the presence of a \$0D or a \$8D carriage return code

in the input word string buffer), the next character is loaded and analyzed. If it is the end of the word, the SPEAK subroutine (driver software in Listing 1) is called to send the allophones to the synthesizer.

Rules

Translator utilizes RULES in order to translate a word into its equivalent allophones. These rules occupy a total of 5,290 bytes. If a 16K card is used, then the rules reside in the card at \$E000; otherwise they are at

TABLE:
; RULE VECTOR LOOKUP TABLE
; ADR generates the address of the designated label in the table.

ADR PNCRULES ; PUNCTUATION RULES
ADR NUMRULES ; NUMBER RULES
ADR ARULES
ADR BRULES
ADR CRULES

PNCRULES:
; Rules for pronouncing punctuation marks (various length pauses).

STR *(!)=PA5*
STR *(,)=PA3*
STR *(?)=PA5*
STR *(;)=PA5*
STR *(:)=PA5*
STR *(')=PA1*
STR *(!)=PA5*
STR *(-)=PA3*
HEX 0000

NUMRULES:
; Rules for pronouncing numbers

STR *(0)=ZZ YR OW *
STR *(1)=WM AX NN1*
STR *(2)=TT2UM2*
STR *(3)=TH RR1LY *
STR *(4)=FF FF OR *
STR *(5)=FF FF AY VV*
STR *(6)=SS SS IH IH PA3YK2SS *
STR *(7)=SS EH EH VV IH NN1*
STR *(8)=EY PA3TT2*
STR *(9)=NN1AA AY NN1*
HEX 0000

ARULES:

STR *(:)(A)^+ =EY *
STR *(A) =EY *
STR *(A) =AI *
STR *(A)^+0=EY *
STR *(AR)=AR *
STR *(A)=AE *
HEX 0000

BRULES:

STR *0(B)0=PA1BB1*
STR *(B) =PA1BB2IY *
STR *(B)=PA1BB2*
HEX 0000

CRULES:

STR *(C) =SS IY *
STR *(CI)A=SH *
STR *(CI)D=SH *
STR *(CI)EN=SH *
STR *(C)+=SS *
STR *(CH)=PA3CH *
STR *(CK)=PA3KK2*
STR *(C)=PA3KK2*
HEX 0000

RULE FORMAT: A(B)C = D

SPECIAL SYMBOLS USED IN SECTIONS A & C (these represent calls to subroutines to check for the following conditions)

One or more vowels (A,E,I,O,U,Y)
Used in sections A and C.

^ One consonant (B,C,D,F,G,H,J,K,L,M,N,P,Q,R,S,T,V,W,X,Z)
Used in sections A and C.

: Zero or more consonants (always passes)
Used in sections A and C.

. One voiced consonant (B,D,G,J,L,M,N,R,V,W,Z)
Used in section A only.

% Suffix (E,ER,ES,ED,ELY,ING)
Used in section C only.

& Sibilant (C,G,J,S,X,Z,CH,SH)
Used in section A only.

@ Nonpal (letters which modify the sound of long U) (D,J,L,N,R,S,T,Z,CH,SH,TH)
Used in section A only.

+ Front vowels (E,I,Y)
Used in sections A and C.

Table 1. Pronunciation rule examples.

Table 2.

\$7F00. These rules are ASCII text strings and are broken into 28 groups. There is a lookup table used to locate each of the rule groups. There is a group for punctuation marks, numbers, and one for each of the 26 letters in the alphabet. Each of the rules in the group is organized according to the priority of the rule, going from the highest to the lowest. A sampling of these rules is shown in Table 1 to demonstrate the format the rules take. Each rule has the form: A(B)C=D—which means "The character string B, which has a left context A and a right context C gets the pronunciation D." B is a letter or group of letters which must match exactly in the source word. A and C are either letters, strings of letters, or special symbols. The special symbols are used to call certain routines to test the appropriate contexts for whichever class of strings is needed. The special symbols used are shown in Table 2.

For example, a # means that one or more vowels must be in the same relative position in the word as the symbol is in the rule. If either A or C is not present, then this indicates that this section of the rule will always pass. A space in section A indicates the beginning of the word, and a space in C indicates the end of the word. D names the allophone codes used to pronounce the letter(s) in section B. These names are later converted into hexadecimal codes to be sent to the speech synthesizer.

As stated above, the rules in each group are organized into four subgroups according to their translation priority. This priority is determined by the contents of sections A, B, and C. Rules with criteria in sections A, B, and C have the highest priority. Rules with criteria in sections A and B and none in C come next, followed by those with criteria only in

sections B and C, and finally those with only section B.

When the rules are analyzed in the translator algorithm, each rule is tested and the rule with the largest number of criteria in sections A, B, and C combined will be chosen to pronounce the letter(s) in section B. For example, if one rule had two symbols (criteria) in section A, one in section B, and two in section C (total of five) it would be given lower priority than a rule with no symbols in section A, three in B, and three in C, even though

a rule such as the former has a higher priority in the rule group.

You might wonder, why not just put the rules in order of the number of total symbols they have and eliminate some code? Well, that is certainly another way of doing it, and I believe it would work just as well. In the process of writing and experimenting with this algorithm, the former method is the one I settled on; it would require a lot of rule shuffling to convert to the latter method, and there

would be very little savings in terms of execution time and code space.

As with all of the computer projects attempted, I have found that for as long as I kept playing with them I would keep changing them and finding new ways to do what I was doing. With something like this, I had to pick a point where the project was satisfactory and stick with it. There is always room to improve. (Enough excuses!)

To summarize how the algorithm works and how the rules are used, let's take the word HOW and translate it into allophones. I will use the H rules reproduced below for reference. Notice the STR before each rule. This is a mnemonic for the LISA™ assembler which tells it to count the number of characters in the quotes and store it in memory at the current address followed by the ASCII codes of the characters.

HRULES:

```
; RULE GROUP FOR LETTER H
STR "(H) = EY CH "
STR "(HAV) = HH1AE VV "
STR "(HERE) = HH1YR "
STR "(HOUR) = OW ER1"
STR "(H)# = HH2"
STR "(HOW) = HH2OW "
STR "(H) = PA1"
HEX 0000 ; END OF RULE
GROUP
```

The first character in the word is H, so the rule group selected is the H rule group. Each rule is located and broken into its component sections (A, B, C, and D) and each section is put into its own buffer. The first rule selected is "(H) = EH CH". Section B will pass because the H in the parentheses matches the H from the word. The A section passes because the H in HOW is the first character. The C section does not pass because the "H" is not the last character. Therefore the rule is not a match.

The next rule is loaded. It is "(HAV) = HH1AE VV". This time section B does not match because the three

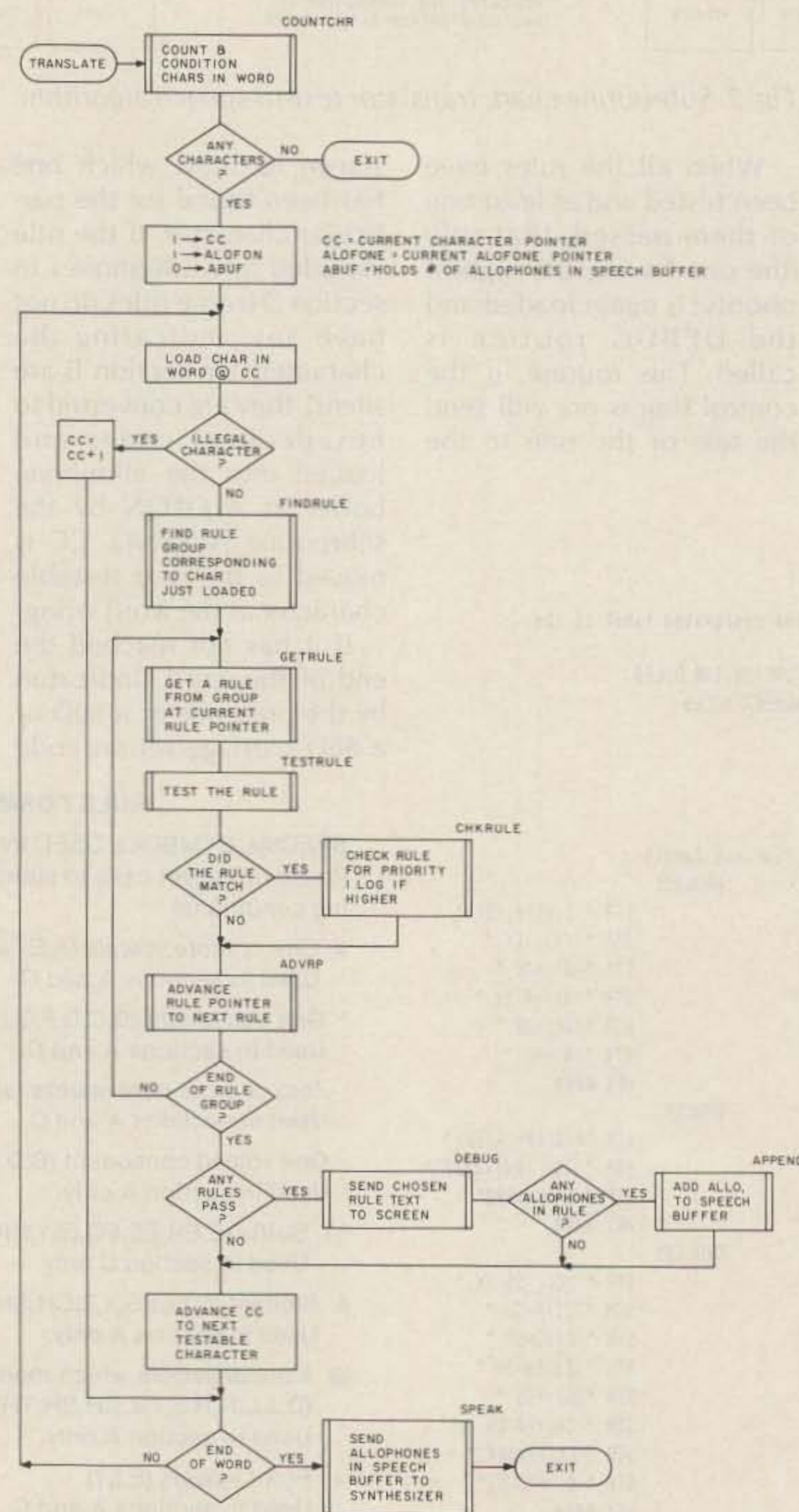

Fig. 3. Translate flowchart.

AMATEUR ELECTRONIC SUPPLY - USED GEAR

★ 10 day Trial (pay only Shipping Charges)

★ 30 day Warranty

★ Full Trade-in within 3 months on New Gear

AEA		ENCOMM	
MBA-RO Reader	\$129 e	HC-400L Ant tuner	\$139 m
ASTRON		FM-2030 2m FM Xcvr	179 m
RS-12A 9A ps	\$ 49 f	FM-2033 2m FM Xcvr	199 m
CLIFFORD		ST-144uP 2m FM HT	199 m
XXRD 20A ps	\$ 59 w	HAL	
COLLINS		RKB-1 RTTY keyboard	\$ 49 m
75S-3 Ham Rcvr	\$269 f	ST-6/AK-1 Demod/keyer	149 v
75S-3B Ham Rcvr	299 c	ST-5000 Demodulator	149 m
32S-3 Transmitter	329 c	ST-6000 Demod/hi tones	389 v
30L-1 Linear	499 c	DS-3000KSR Term vers 2	369 m
312B-4 Station control	189 fc	DS-3000KSR Term vers 3	469 e
KWM-2 Xcvr	439 mc	ARQ-1000 Error terminal	599 m
516F-2* AC supply	149 mwfc	HENRY RADIO	
*Not sold separately			
KWM-380 sn 552/blower/	1895 v	2KD-5 Linear amp	\$689 f
mars/warc/1.8/update 4/84		TP-400 DC ps; Drake TR-4	49 v
DAIWA		ICOM	
CNW-518 Ant tuner	\$189 mw	IC-701 Xcvr w/ps	\$399 m
CNA-1001 Auto ant tuner	199 mcv	IC-701 Xcvr only	299 f
DENTRON		IC-720A Xcvr	599 m
160-10AT Ant tuner	\$ 89 c	IC-720A/CW/AM filts	649 m
MLT-2500 Ant tuner	249 f	C-730 Xcvr	469 wf
Clipperton L Linear	459 m	C-730/FL-30 SSB pbt	499 v
DRAKE		C-740/FL-45 cw filt	589 m
R-4A Ham Rcvr	\$149 f	C-740/internal ps	649 v
R-4B Ham Rcvr	179 mwfcv	C-740/int ps/2 CW filts	689 w
R-4C Ham Rcvr	249 mw	IC-751/CW filter Xcvr	969 m
MS-4* Speaker	19 mwfcv	IC-751/int ps/voice syn	1049 v
*Not sold separately			
4NB Blanker	49 w	PS-20 Power supply	159 m
FL-250 250 Hz filter	35 w	PS-35 Internal ps	99 w
FL-1500 1.5 KHz filter	35 w	SP-3 Speaker	29 v
SC-2 2m rcv conv	59 m	RC-10 Ext controller	19 m
SC-6 6m rcv conv	59 wf	R-70/FM SW Rcvr	399 f
CPS-1 Conv ps	19 m	R-71A/fm/rem/dc/cw/ssf	689 w
SCC-1 VHF calib	19 w	HP-1 Headphones	19 m
CC-1 Conv console	29 m	IC-505 6m portable	319 f
TC-6 6m xmit conv	175 w	IC-551 6m Xcvr	299 m
R-7/nb/aux/4 filters	899 m	IC-560 6m Xcvr	349 m
T-4X Transmitter	149 mwfc	IC-22S 2m FM Xcvr	99 c
T-4XB Transmitter	169 wfcv	IC-25A 2m FM red LED	199 w
T-4XC Transmitter	219 mwv	IC-25A 2m FM grn LED	219 c
TR-4 Xcvr	229 mwcv	IC-271H/int ps 2m Xcvr	699 m
TR-4C Xcvr	269 wfc	IC-280 2m FM Xcvr	129 c
TR-4CW/RIT Xcvr	369 w	IC-45A 440 FM Xcvr	199 v
AC-3* AC supply	59 mwfc	IC-47A 440 FM Xcvr	329 m
AC-4* AC supply	79 mwfc	IC-451A 440-450 Xcvr	469 m
*Not sold separately			
TR-5 Xcvr	369 mc	IC-471A 430 Xcvr	559 m
TR-5/500 Hz filter	399 m	AG-1 440 preamp	59 m
TR-7 Xcvr	499 wfc	AG-25 2m preamp	59 m
TR-7/500/1.8 filters	549 f	ML-1 2m 10w amp DEMO	59 v
TR-7/nb/aux/300/500/NB	629 e	KENWOOD	
TR-7/NB/500/1.8/4	629 e	TS-120S Xcvr	\$349 m
TR-7/NB/500/1.8/6	629 m	TS-130S Xcvr	399 mf
TR-7/fan/aux/500/1.8/6	679 m	TS-130SE w/fan Xcvr	429 m
PS-7* Power supply	169 mwcv	TS-520 Xcvr	369 wc
*Not sold separately			
PS-75 Power supply	89 m	TS-520S Xcvr	389 mfc
MS-7 Speaker	29 e	TS-520SE Xcvr	429 mwcv
SP-75 Speech proc	79 fc	TS-520SE/CW filter	459 m
MN-2700 2kw PEP tuner	229 v	YK-88SN 1.8 SSB filter	35 w
550 Rcv only terminal	199 e	TS-530S Xcvr	469 m
9000E Terminal	399 m	TS-820/DG-1 Dig Xcvr	449 f
729SRD Desk mic	19 m	TS-820S Dig Xcvr	469 mfc
1525EM TTP mic	29 e	TS-830S Xcvr	589 f
ETO		DFC-230 Dig freq control	119 f
Alpha 76A Linear	1249 w	DFC-230 (new close-out)	169 ⁹⁵ mwfc
ELECTRA BEARCAT		VFO-230 Dig remote VFO	199 e
BC-100 Pocket scanner	\$149 m	VFO-240 Remote VFO	119 m
		PC-1 Phone patch	39 f
		AT-230 Ant tuner	129 f
		TS-930S Xcvr	898 c
		TS-930S/tuner Xcvr	998 fe

TS-930S/AT/am/2 cw filts	1098 m
TL-922 Linear (air freight)	869 f
BS-5 Pan kit	49 e
R-300 SW receiver	149 v
R-600 SW receiver	229 m
R-1000 SW receiver	269 w
TS-600 6m Xcvr	369 m
TS-700A 2m Xcvr	289 mc
TS-700S 2m Xcvr	369 f
TR-7600 2m FM Xcvr	129 c
TR-7625 2m FM Xcvr	179 c
TR-7850 2m FM Xcvr	229 c
TW-4000A 2m/440/vs/enc	429 m
TR-8400 440 FM Xcvr	229 mc
TR-8400/TTP mic	249 m
RM-76 Microproc	49 m
KPS-7 7A ps	29 m
MC-30S Hand mic	19 v
MC-60A Desk mic	55 wc
SW-2000 SWR/PEP watt	69 m
MS-1 Mobile cgr DEMO	34 v
MFJ	
422 Keyer/paddle	\$ 69 f
484 Memory keyer	89 w
MICROLOG	
ACT-1 Terminal	\$229 wv
MIDLAND	
13-510A 2m FM/CES scan	\$169 e
MIRAGE	
MP-1 PEP wattmeter	\$ 79 w
MURCH	
UT-2000A Tuner	\$119 w
PANASONIC	
RF-4900 SW receiver	\$269 m
RF-6300 SW receiver	299 w
RF-B600 SW receiver	369 m
REGENCY	
EC-175 Freq counter	\$ 89 f
SBE	
SB-450 440 FM Xcvr	\$ 79 m
SONY	
ICF-2001 SW receiver	\$159 f
ICF-2002 SW receiver	169 mwfc
ICF-2010 SW receiver	229 m
SPECTRONICS	
DFD-K Dig disp; Kenwood	\$ 69 c
DD-1T Dig disp; Tempo	69 m
SWAN/CUBIC	
PSU-6 Power supply	\$ 99 f
TV-2C 2m Xvtr (6m IF)	149 m
FP-4 Phone patch	39 f
TEMPO	
Tempo One Xcvr	\$189 mwcv
AC One* AC ps	69 mwcv
*Not sold separately	
RBF-1A SWR bridge	19 w
TEN-TEC	
505 Argonaut Xcvr	\$199 c
509 Argonaut Xcvr	239 m
206A Calibrator	19 m
251 9A supply	49 m
525/1.8 filt Argosy Xcvr	369 e
225 9A power supply	89 m
570 Century/21 Xcvr	189 mwfc
574 Century/21 digital	249 m
276 Calibrator	19 mwv
Triton II Xcvr	229 mf
546C/500/1.8 Omni Xcvr	599 v
252M/O Power supply	79 m
262G Power supply	89 mc
560 Corsair Xcvr	699 m
560/2 cw filts Corsair	769 m
263 Remote VFO	139 m
255 Power supply	119 m
227 Ant tuner	59 m
277 Ant tuner/SWR	59 w

444 Hercules Linear	1069 m
214 Desk mic	29 wv
700A Hand mic	19 w
USI	
1400C 14" color monitor	\$199 m
YAESU	
FL-101 Transmitter	\$229 wc
FT-101 Xcvr	379 fc
FT-101B Xcvr	389 mf
FT-101E Xcvr	449 mwcv
FT-101E/CW filter	479 w
FT-101E/CW/AM filts	499 m
FT-101EE Xcvr	399 fc
FT-101EX Xcvr	389 mf
FT-101F Xcvr	449 mfc
FT-101ZD Dig Xcvr	469 f
FT-101ZD Mk III Xcvr	549 w
FV-101 Remote VFO	89 f
FV-101Z Remote VFO	79 m
SP-101 Speaker	19 m
SP-101PB Spkr/patch	49 w
SP-120 Speaker	19 m
ERB Relay box	19 f
FP-700 Power supply	99 m
FT-901DM Xcvr	549 mfc
FT-902DM Xcvr	749 m
SP-901 Speaker	19 m
FV-901DM Remote VFO	169 m
SP-102 Speaker	49 m
FC-102 Ant tuner	189 m
FT-107M/DMS Xcvr	469 m

FT-107M/DMS/int ps	569 w
FP-107E External ps	99 m
FV-107 Remote VFO	89 m
FT-707 Xcvr	369 mf
FT-707/CW filter	399 m
FP-707 Power supply	99 m
FT-980 Xcvr	998 mc
FT-980/cw/am filts	1049 m
SP-980 Speaker	39 m
FT-ONE/fm/ram/4 filters	1469 v
FT-ONE/fm/ram/4 filts/kyr	1499 w
FL-2100B Linear	249 f
HF/726 HF module	159 e
FTV-707 Xvtr w/2m	189 w
FRG-7000 SW Rcvr	289 m
FRG-7700/mem SW Rcvr	369 w
FT-620B 6m Xcvr	289 m
FT-625RD 6m Xcvr	449 w
FT-225RD 2m Xcvr	449 w
FT-720RVH 2m FM Xcvr	169 w
FT-720RU 440 FM Xcvr	199 e
FP-80 4.5A ps	49 w
FT-207R 2m FM HT	129 e
YM-34 Desk mic	19 m
YM-50 TTP mic	39 m

SATELLITE TV EQUIPMENT

WILSON
YM-400 Receiver \$149 m

11-5-85

(1) This list was prepared from an inventory taken on the date shown. The letters after the prices indicate in which store the equipment was located at that time. The quantities vary. In some cases there are several of an item; others, only one. Due to the lead and distribution time of this publication, some of the items may have already been sold by the time you see this ad. However, due to the number of trades we are involved in each day, some items are in stock that are not listed. (2) We reserve the right to sell certain power supplies and accessories only with matching transmitters or transceivers, depending on our stock situation. (3) Sometimes used gear is serviced after we receive your order. Please allow for a few days delay in shipping your order. (4) No trades on used gear. (5) Used gear policies do not apply to New Equipment specials, Closeouts, etc.

USED AES SHOP TEST EQUIPMENT

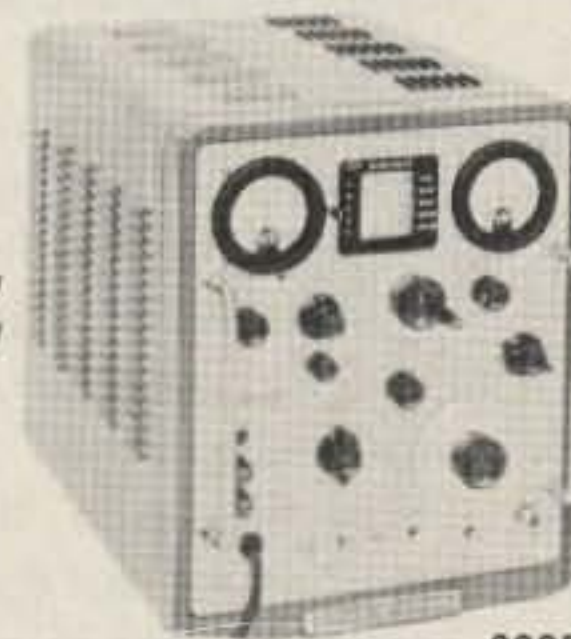

608E



FM-10CS

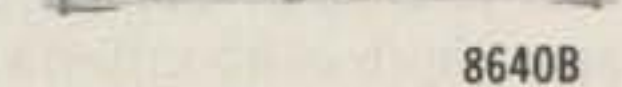

8640B

HEWLETT-PACKARD
608E 10-480MHz sig gen 1295
8640B .5-1024MHz sig gen w/options 002/003 4995

SINGER-GERTSCH
FM-10CS w/RFM-10A, FIM-3 & ODM-1 3995
OAM-1 AM module/FM-10 195

HELP WANTED

We are looking for an experienced Electronic Technician to repair Amateur Radio equipment at our Milwaukee Headquarters. On-the-job training, good benefits, will consider helping with moving expenses, prefer non-smoker. Send resume and picture to:

AES® P.O. Box 16729, Milwaukee, WI 53216

Location

m = Milwaukee, WI 53216; 4828 W. Fond du Lac Ave ... (414) 442-4200
w = Wickliffe, OH 44092; 28940 Euclid Ave. (216) 585-7388
f = Orlando, FL 32803; 621 Commonwealth Ave (305) 894-3238
c = Clearwater, FL 33515; 1898 Drew Street. (813) 461-4267
v = Las Vegas, NV 89106; 1072 N. Rancho Drive. (702) 647-3114
e = Chicago, IL Erickson Communications (Associate)... (312) 631-5181

Local Phone

Nationwide

In-State

1-800-558-0411 1-800-242-5195
1-800-321-3594 1-800-362-0290
1-800-327-1917 1-800-432-9424
1-800-634-6227



Little Board™ \$249

The World's Least Expensive CP/M Engine

CP/M 2.2
INCLUDED



- 4 MHz Z80A CPU, 64K RAM, Z80A CTC, 4-32K EPROM
- Mini/Micro Floppy Controller (1-4 Drives, Single/Double Density, 1-2 sided 40/80 track)
- 2 RS232C Serial Ports (75-9600 baud & 75-38, 400 baud), 1 Centronics Printer Port
- Power Requirement: +5VDC at .75A; +12VDC at .05A / On board -12V converter
- Only 5.75 x 7.75 inches, mounts directly to a 5-1/4" disk drive
- Comprehensive Software Included:
 - Enhanced CP/M 2.2 operating system with ZCPR3

- Read/write/format dozens of floppy formats (IBM PC-DOS, KAYPRO, OSBORNE, MORROW...)
- Menu-based system customization
- Operator-friendly MENU shell
- OPTIONS:
 - Source Code
 - TurboDOS
 - ZRDOS
 - Hard disk expansion to 60 megabytes
 - SCSI/PLUS™ multi-master I/O expansion bus
 - Local Area Network
 - STD Bus Adapter

AMPRO
COMPUTERS, INCORPORATED

IBM®, IBM Corp.; Z80A®, Zilog, Inc.;
CP/M®, Digital Research; ZCPR3™ & ZRDOS™,
Echelon, Inc.; Turbo DOS®, Software 2000, Inc.

67 East Evelyn Ave. • Mountain View, CA 94041 • (415) 962-0230 • TELEX 4940302

characters in the parentheses do not match the three characters starting with H in the word HOW.

The next rule is loaded: "(HERE) = HH1YR ". Again, section B does not match.

The next rule is the same way, but the next rule, "(H)# = HH2", seems to have a chance. Section B certainly matches. Section A also matches by default because there is no criteria to be met—anything may be in front of the H for this rule to pass. Section C has a # in it which means that one or more vowels must follow the H in HOW in order for the section to pass. This it certainly does because there is one O following the H. The rule passes, and the address and priority of the rule (2) are held for future reference. Remember that the priority given to a rule is the total number of symbols in sections A, B, and C.

And now the next rule, "(HOW) = HH2AW ", is loaded for testing. Section B has H, O, and W in it which

perfectly matches the three characters starting with H in HOW. Section A has no criteria and therefore passes as does section C. This rule passes and the priority (3) is compared to the current highest (2). Since it is higher, the address for this rule and its priority replace the previous maximums.

The final rule, "(H) = PA1", also passes, but its priority is less than the current maximum of 3 so it is ignored. When the zeros are read in, that indicates the end of the rule group has been reached.

With all of the rules in the H group having been tested, the rule chosen for translation is the "(HOW) = HH2AW " rule. Therefore, those two allophones are converted into their respective hexadecimal codes and added to those (if any) in the buffer which holds the codes to be sent to the synthesizer. Notice that all of the allophone names (HH2, AW) have exactly 3 characters in them.

This makes it easier for the Translator program to find and convert them into their hexadecimal codes.

The next thing is to advance the pointer (which points to the character which is being tested) to the next testable character. In this case, it skips over the O and the W because their pronunciations were included in the translation of the H, since they were all in section B. The pointer would therefore move to the next character past the W. But since there are none, the translation is complete and the allophone codes are sent to the synthesizer. (If the word had been HOWDY, the rule group for D would have been located and the process repeated for all the rules in that group, and then the Y group, if necessary.)

Final Comments

This project took me considerably more time and effort to produce than did the first Cheap-Talker project, but the rewards were greater. It is fascinating to be able to allow any program to generate understandable speech without having to maintain a high overhead in terms of memory. I think this project is more usable in diverse applications than the dictionary version described in my first article.

As I stated before, there are many ways to improve this project, but I hope I have been able to give ideas which will kindle the experimenter's spirit in you. Please drop me a note and let me know what you're up to, and if I can answer any questions not covered here (I'm sure there are some), let me know.

The programs described in this article are not listed here, of course, since the combined lengths of the algorithm and rules were pushing 8K bytes of memory. That's about 2200 lines of assembly listing, or 70 pages, which is a little too

long to publish in a magazine article! If you wish to have the source code for everything described here, I will send it by mail for \$25.00 (\$26.50 for Californians, \$30.00 for those outside of the US).

I will send you a DOS 3.3 disk which will include (1) object code for the driver and translator programs and the rules for use with systems with or without a 16K card (the disk automatically loads the appropriate code); (2) source code for the above software in LISA assembler format; (3) source text for the same in DOS 3.3 text files for conversion to other assemblers; (4) a small artificial intelligence/speech synthesis demonstration program in Basic, and (5) a small Basic program for testing the pronunciation capabilities of the translator.

If you do not own an Apple computer and would like just a source listing of the programs on paper, I can send that to you for \$15.00 (\$15.90 for Californians, \$20.00 for those out of the country).

I hope this project will provide some useful ideas and enjoyment for you. Keep talkin'! ■

References

- 1) H. S. Elovitz, R. W. Johnson, A. McHugh, and J. E. Shore, "Automatic Translation of English Text to Phonetics by Means of Letter to Sound Rules," United States Naval Research Laboratory Report 7948, 1976 (see Note).
- 2) Steve Ciarcia, "Build a Third-Generation Phonetic Speech Synthesizer," *Byte*, March, 1984, page 28.
- 3) Steve Ciarcia, "Build the Microvox Text-to-Speech Synthesizer," part 1, *Byte*, September, 1982, page 64; part 2, October, 1982, page 40.

Note: This document is available for \$13.00 from the Sales Department, National Technical Information Service, 5285 Port Royal Rd., Springfield VA 22161. It should be ordered as item AD-AO21929. The price includes shipping. (Price and terms may change without notice.)

SNOWTELLIN' WHAT WE'RE SELLIN'

Hard to get through on our 800 number? Call before 10 a.m. or after 5 p.m., or call our regular number. If you pay for the call and order, we'll credit your order with \$1.

KENWOOD

HF TRANSCEIVERS



NEW TS-940S HF Transceiver CALL
With General Coverage Receiver

TS-930S HF Transceiver CALL
With General Coverage Receiver

TS-430S HF Transceiver SUPER SPECIAL
With General Coverage Receiver

TS-830S Transceiver CALL
160-10 Meter With Power Supply

TS-530SP 160-10 Meter XCVR CALL
With Power Supply & Notch Filter

RECEIVERS

R-2000, R-600, R-1000, R-11 CALL
General Coverage Receivers

VHF/UHF



TR-7950/7930 CALL
2-meter Mobile Units, 45 or 25 Watts

TR-9130 2m All-mode, 25 Watts CALL

TS-711A/TS-811A CALL
All-mode Transceivers
2m or 70cm mobile or base station

HANDHELDS

TR-2600A 2m FM Transceiver CALL
With memories, LCD, scan

TH-21A, 21AT/TH-41A, 41AT CALL
2m/70cm Ultra-compact FM Transceiver

YAESU

NEW SCANNER

FRG 9600 499.95
Continuous Coverage
60 MHz-905 MHz, All mode

HF TRANSCEIVERS



FT 757 HF XCVR with mic 699.95
with General Coverage RCVR
includes CW keyer, AM/FM, CW filter

SWL RECEIVER

NEW FRG 8800 SWL Receiver 510.00
VHF Converters, Active Antennas available

HANDHELDS

FT 209RH 2m HT 299.95
FREE FTS-6 Tone Encoder with FT 209RH

FT 203 2m HT with TTP CALL

FT 103 220 MHz HT with TTP CALL

FT 703 440 MHz HT with TTP CALL

All accessories in stock

VHF/UHF

NEW FT 270RH 2m, 45-watt 369.95
Very small mobile rig

NEW FT 2700RH 25-watt 499.95
Dual-band 2m and 440

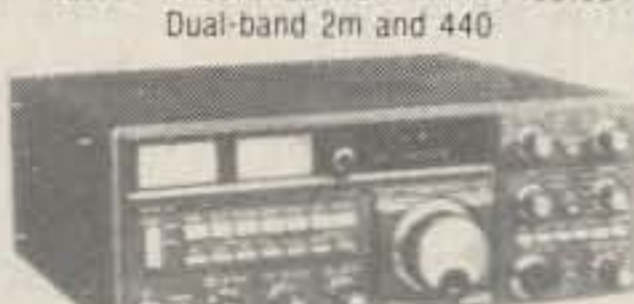

FT 726R For 2m 759.95
(Optional modules for 6m, 430, 440 MHz)
Great for Satellite Work

ICOM

HANDHELDS

IC 02AT 2m HT, 10 Memories CALL
IC 04AT 440 HT/Touchtone CALL
IC 2AT 2m HT/Touchtone 199.95
IC 3AT 220 MHz HT/Touchtone 229.95
IC 4AT 440 MHz HT/Touchtone 229.95

SWL RECEIVERS

R71 Limited Quantities 599.95
General Coverage Receiver

VHF/UHF

NEW IC 3200 2m/440 bands 489.95
IC 271H 100-watt 2m XCVR 732.95
IC 27A 2m compact mobile 309.95
IC 290H 25-wt all-mode 2m XCVR 479.95



IC 271A Special 599.95
All-mode 2m Transceiver

HF TRANSCEIVERS



NEW IC 735 HF XCVR CALL

IC 751 HF XCVR/Gen Cov RCVR 1099.95
With PS35 installed 1199.95

IC 745 769.95
HF XCVR/Gen Cov RCVR

MARINE

M12 12-ch Programmable HT 219.95
M2 76-channel Synthesized HT 261.95
M80 25-watt all-channel Scanner 387.26
M80C Commercial M80 429.95
New M5 all-channel HT 325.95

SANTEC

KDK

FM 240 2m, 25-watt 299.95
STLC Leather Case for ST 142 34.95
SM3 Speaker Mic for ST 142 34.50

SANTEC

ST200ET 440 MHz handheld 199.95

ST400ET 144MHz handheld 175.95

TEN-TEC

Century 22 CW XCVR 350.00

2510 Model B 469.95

Satellite Station for Oscar 10

CORSAIR II Model 561 1149.95

ARGOSY II 525D Digital 565.95

TRITON 425 HF Amp 1.5kW CALL

SCANNERS

REGENCY

New R1060 10-ch, 6-band 99.95

MX4000 mobile 30-900 MHz 299.95

HX1200 45-ch Handheld 209.95

HX2000 Handheld 120-900 MHz 279.95

MX3000 30-ch, 6-band mobile 199.95

MX5000 20-ch 25-512 MHz cont 354.95

BEARCAT

New 100XL Handheld 225.00

260 16-ch mobile 180.00

2020 40-ch/aircraft 219.00

210XW 219.00

300 50-ch scanner/aircraft 209.00

SONY RECEIVERS

2002 SWL Receiver 199.95

2010 SWL Receiver 279.95

4910 SWL Receiver 89.95

ANTENNAS

CUSHCRAFT

A3 3-element 10-15-20m 205.00

A4 4-element 10-15-20m 264.95

R3 10-15-20m Vertical 256.95

214B SSB/215WB FM 2m Boomers 73.00

ARX-2B 2m Ringo Ranger 34.95

A3219 2m Boomer 88.00

KLM

KT34A 4-element 10-15-20m 334.95

KT34XA 6-element 10-15-20m 479.95

2m-11X 11-element 2m 59.95

2m-16LBX 16-element 2m 91.95

MOSLEY

CL-33 3-element Triband Beam 265.95

TA-33 3-element 10-15-20m 239.95

Pro 37 7-element 10-15-20m 465.95

HUSTLER

6-BTV 10-80m Vertical with 30m 128.95

5-BTV 10-80m Vertical 108.95

MOBILE RESONATORS Standard Super

10 and 15 meter 11.95 17.95

20 meters 15.50 21.95

30 and 40 meters 17.95 25.95

75 meters 19.95 36.95

HY-GAIN

391S TH7DX 7-ele 10-15-20m CALL

395S Explorer 14 10-15-20m CALL

Order Hy-Gain tower, Hy-Gain antenna, & Hy-Gain rotor—get free shipping on all.

MORE ANTENNAS

AEA Isopoles CALL

AVANTI HM 151 3G 2m on-glass 31.95

LARSEN LM-150 5/8 Mag Mount 39.95

MINIQUAD HQ-1 141.95

BUTTERNUT HF6V 10-80m Vert 112.95

BUTTERNUT HF4B 2-ele Beam 189.95

FOR OSCAR by Cushcraft & KLM CALL

TOWERS



Self-supporting towers:

HBX40 40-feet with Base 198.00

HBX48 48-feet with Base 264.00

HBX56 56-feet with Base 335.00

HDBX40 Higher load with Base 248.00

HDBX48 Higher load with Base 325.00

Other BX, HBX, HDBX in stock

Guyed foldover towers:

FK2558 58-feet, 25G 940.00

FK4554 54-feet, 45G 1296.00

Other sizes at similar savings.

Foldovers shipped freight paid

10% higher west of the Rockies.

Straight Sections:

20G Straight Section 37.95

25G Straight Section 48.95

45G Straight Section 109.00

Complete Tower Packages CALL



Call for our low prices

CABLE BY SAXTON

RB213 Mil Spec 29*/ft

RG8/U Foam 95% Shield 25*/ft

8-wire Rotator 2 #18, 6 #22 17*/ft

Mini-8 95% Shield 13*/ft

CABLEWAVE HARDLINE Call

ACCESSORIES

BENCHER PADDLES

Black/Chrome 38.95/48.95

ASTRON POWER SUPPLY

RS7A 49.95 RS20M 104.95

RS12A 69.95 RS35M 149.95

RS20A 89.95 VS20M 124.95

RS35A 133.95 VS35M 169.95

RS50A 189.95 RS50M 209.95

TELEX HEADPHONES

Procom 250 Headset/Mic 72.90

Procom 450 Padded phones 35.55

Procom 350 Ultralight set 58.95

HMC-2 underchin phone 12.68

SWL-610 light headphone 8.75

Others in stock CALL

SUPER SPECIALS THIS MONTH

B & W

375 6-position Coax Switch 24.50

425 1 kW Low Pass Filter 28.50

DAIWA/MCM/J.W. MILLER

CN-520/CN-540 Meters 59.95/69.95

CN-620B/CN-630 Meters 106.00/126.00

CNW-419 Antenna Tuner 500 W 174.95

AMPHENOL

Connectors of all kinds in stock CALL

ROTATORS

Alliance HD73 105.00

Kenpro KR500 Elevation Rotator 159.95

Hy-Gain Ham IV CALL

Hy-Gain Tailtwister T*x CALL

Hy-Gain CD4511 CALL

Hy-Gain Heavy-duty 300 CALL

Buy an HF Beam & get an HD73 for \$99.95

AMPLIFIERS

TOKYO HY-POWER

VHF & UHF amps CALL for Quotes

HL30V 2m Amp 2 in, 30 out CALL

HL82V 2m Amp & Preamp 10-80 CALL

DAIWA

LA-2035R 2m Amp with preAmp 74.95

MIRAGE

B23A 2m Amplifier 2-30 84.95

B1016 2m Amplifier 10-160 242.95

B3016 2m Amplifier 30-160 199.95

D1010N UHF Amp/N connectors 279.95

B215 2m Amp, 2 in, 150 out 245.95

A1015 6m Amp, 10 in, 150 out 242.95

AMERITRON HF AMPS

AL80A 1200 watt 659.95

AL84 HF Amp 160-15 389.95

AL1200 1.5 kW Amp 1399.95

KENWOOD TL922 2kW CALL

AMP SUPPLY

LA 1000A 160-15m Amp 389.95

AT 1200A 1200 PEP Tuner 169.95

LK 500ZB 2.5 kW hipersil 1132.95

VOCOM AMPLIFIERS

2 watts in, 30 watts out 2m Amp 69.95

2 watts in, 60 watts out 2m Amp 107.95

2 watts in, 120 watts out 2m Amp 169.95

200mW in, 30 watts out 2m Amp 84.95

New VHF/UHF Amps from TE Systems

with Low Noise GaAs FET Preamp

Call for Quotes

HAL
CWR 6850 Telereader 746.95
CRI 100 RTTY/CW interface 214.95
CRI 200 RTTY/CW interface 259.95

PACKET
Kantronics controller 199.95
AEA PKT-1 controller 450.00
AEA PK-64 controller 199.95

HARDWARE
MFJ 1224 with MFJ C-64/V-20 Soft 79.95
MFJ 1229 CALL
Kantronics Interface II 210.95
AEA CP-100 interface 284.95
AEA MP1 Micropatch 119.95
AEA CP1 interface 179.95
Kantronics UTU 169.95
Kantronics UTU-XT CALL

PACKAGES
Microlog AIR-1 Vic-20/C-64 179.95
AEA CP1 C-64 with Amtor 229.95

SOFTWARE
Kantronics Hamtext
Vic-20, C-64, Apple CALL
Kantronics Hamsoft/Amtor
Vic-20, C-64, TRS-80 color, Atari 69.95
Kantronics Hamsoft
Vic-20, Apple, Atari, TRS-80C, TI-99 CALL
Microlog Air Disk
Vic-20 and C-64 Disk 39.95
Cartridge 56.95

AEA
MBA Text Vic-20 or C-64 79.95
MBA-for 64 89.95
Marstext Vic-20 or C-64 79.95
Dr. DX by AEA 95.95
Dr. QSO by AEA 71.95

HAM DATA Amateur Software for the VIC-20 and Commodore 64 Specify tape or disk.

	C-64	VIC-20
Contest Log	24.95	24.95
Antenna Design	9.95	—

Try an Inverted-Psi Wire

Get the DX edge on 80m with a radiation angle that's almost too low!

Capacitance hats have always appealed to me, especially with vertical antennas. I don't think we take enough advantage of these devices and this is particularly true at the lower-frequency bands such as 1.8 MHz and 3.5 MHz.

Some commercially-manufactured vertical antennas have capacitance hats, usually with a radius of less than 1 foot. This is much too small to have any effect except perhaps at 21 and 28 MHz. A capacitance hat can actually be quite large without producing any detrimental effect on the performance of an antenna; a 0.1-wavelength radius is quite practical.

This article describes the theory of operation of an antenna that I call the "inverted psi" because of its physical shape. The antenna

uses a loading inductor and a large capacitance hat to provide low-angle radiation for DX on (in this case) the 80-meter band. The antenna is just 16 feet high, but it performs almost as well as a full-sized quarter-wave-length vertical.

Capacitive Loading

A capacitance hat at the end of any antenna will reduce the impedance at the end, raising it at the center. The larger the capacitance hat, the more pronounced this effect will be. If the capacitance hat is made too large, the current in the radiating portion of the antenna will drop too much and the low-angle radiation (in the case of a vertical antenna) will be impaired. But this does not happen to any significant extent until the radius of the capacitance

hat exceeds 0.1 electrical wavelengths. At 3.5 MHz, this radius is more than 26 feet!

In general, the maximum allowable radius of a capacitance hat, designated by r and denoted in feet, is equal to $93.6/f$, where f is the frequency in megahertz. Table 1 shows the maximum allowable radius of a capacitance hat for various amateur bands from 1.8 through 29.7 MHz, assuming we can get away with 0.1 wavelengths.

You will notice, no doubt, that no commercially-made antennas have capacitance hats this large.

Why use a capacitance hat with a vertical antenna? Because it greatly increases the effective height and improves the performance accordingly. This is not just theoretical speculation; it is a practical, useful fact. The performance of the inverted psi justifies this statement.

Because of geographical

limitations I was able to use only two wires as the capacitance hat for my 80-meter vertical antenna. Ideally I would have employed four radial elements, but the antenna had to be put along the edge of a dock to take advantage of a salt-water ground plane. (If I had put any wires out into the water and the authorities had noticed, there would have been serious repercussions.)

Fig. 1 is a schematic illustration of the 80-meter inverted psi that I constructed. The vertical element is a little less than 16 feet high. The two capacitance-hat wires are about 22 feet long; this makes the antenna resonant at about 3.600 MHz.

The antenna is also resonant as a quarter-wave radiator at 14 MHz. The height of the vertical radiator was not chosen by accident. I like both 20 and 80 meters.

Antennas of this type can also be designed for 40 or 160 meters. Some years ago

Frequency (MHz)	Radius (Feet)
1.8 (band edge)	52.0
2.0 (band edge)	46.8
3.5 (band edge)	26.7
4.0 (band edge)	23.4
7.0 (band edge)	13.4
7.3 (band edge)	12.8
10.125 (band center)	9.24
14.0 (band edge)	6.69
14.35 (band edge)	6.52
18.118 (band center)*	5.17
21.225 (band center)	4.41
24.94 (band center)	3.75
28.85 (band center)	3.24

* Not authorized for use as of time of this writing.

Table 1. Maximum capacitance-hat radius for antennas according frequency, assuming 0.1 wavelengths as the largest tolerable.

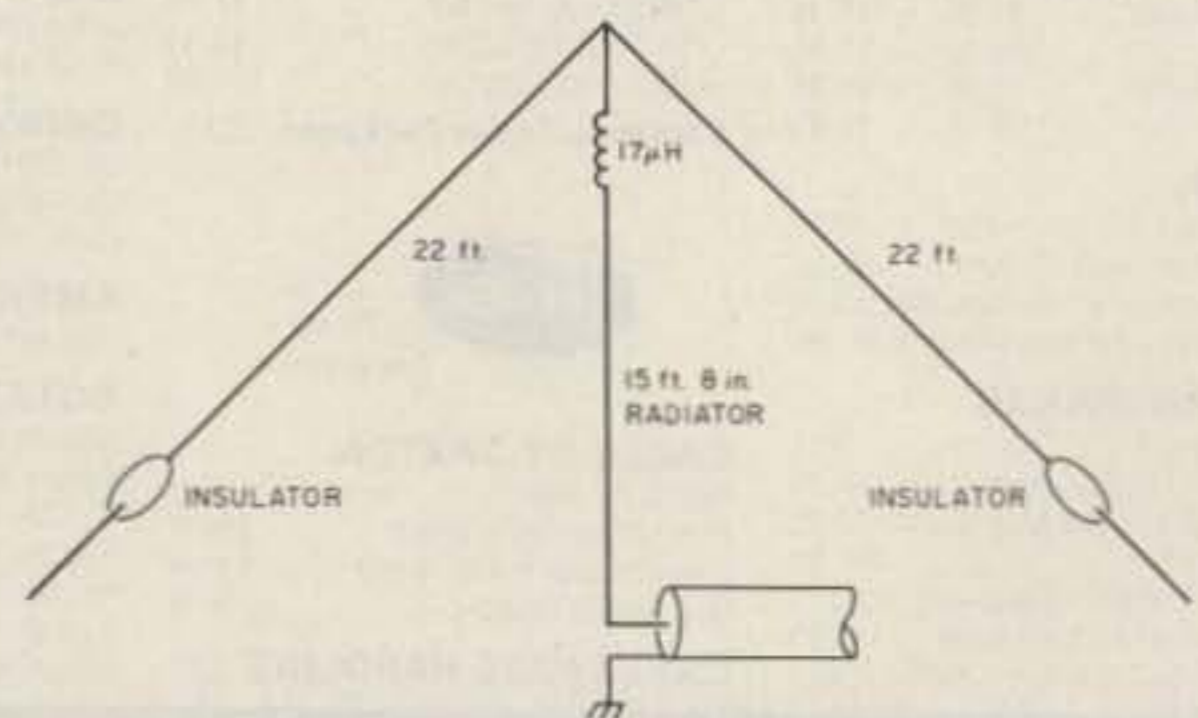

Fig. 1. Schematic illustration of the inverted-psi design for 80 meters.

I built a 10-foot version of this antenna for 40 meters and it worked very well, even with a marginal ground system. (I do not have the real estate to put up a 160-meter inverted psi—yet.)

Ideally, a capacitance hat would take the form of a solid metal disk at the top of a vertical radiator (Fig. 2). If the height of the vertical radiator is h feet and radius of the disk is r feet, then the effective height, h^* , in feet, is approximately $h + 2r$.

That is the ideal case. The inverted psi is a little less than ideal, but the two 22-foot top-hat wires obviously increase the effective height by at least 22 feet. More probably (I didn't have an impedance bridge to precisely figure it out), the effective height is increased by about 1.5×22 , or 33 feet. Along with the 16-foot radiator, that would result in an effective height of $16 + 33$, or 49 feet. Almost a full-size quarter-wave vertical antenna!

The above is a little bit speculative. The real test of an antenna is not done on paper, but by putting it on the air and seeing how it works.

I built the antenna in a couple of hours one evening, had supper, fell asleep, woke up at 6:00 in the morning, turned on my receiver, and heard a ZL on 3.507 MHz. Promising.

Grounding

A good ground system is essential for the performance of any $\frac{1}{4}$ -wave antenna. An extensive radial system should be used. Ideally, this would consist of a metal plate having a radius of at least an electrical quarter wavelength and either buried just beneath or laid on top of the ground. I was fortunate enough to live in a place where this kind of "super ground" was almost provided to me by nature: I was staying in an oceanfront home. Salt water has con-

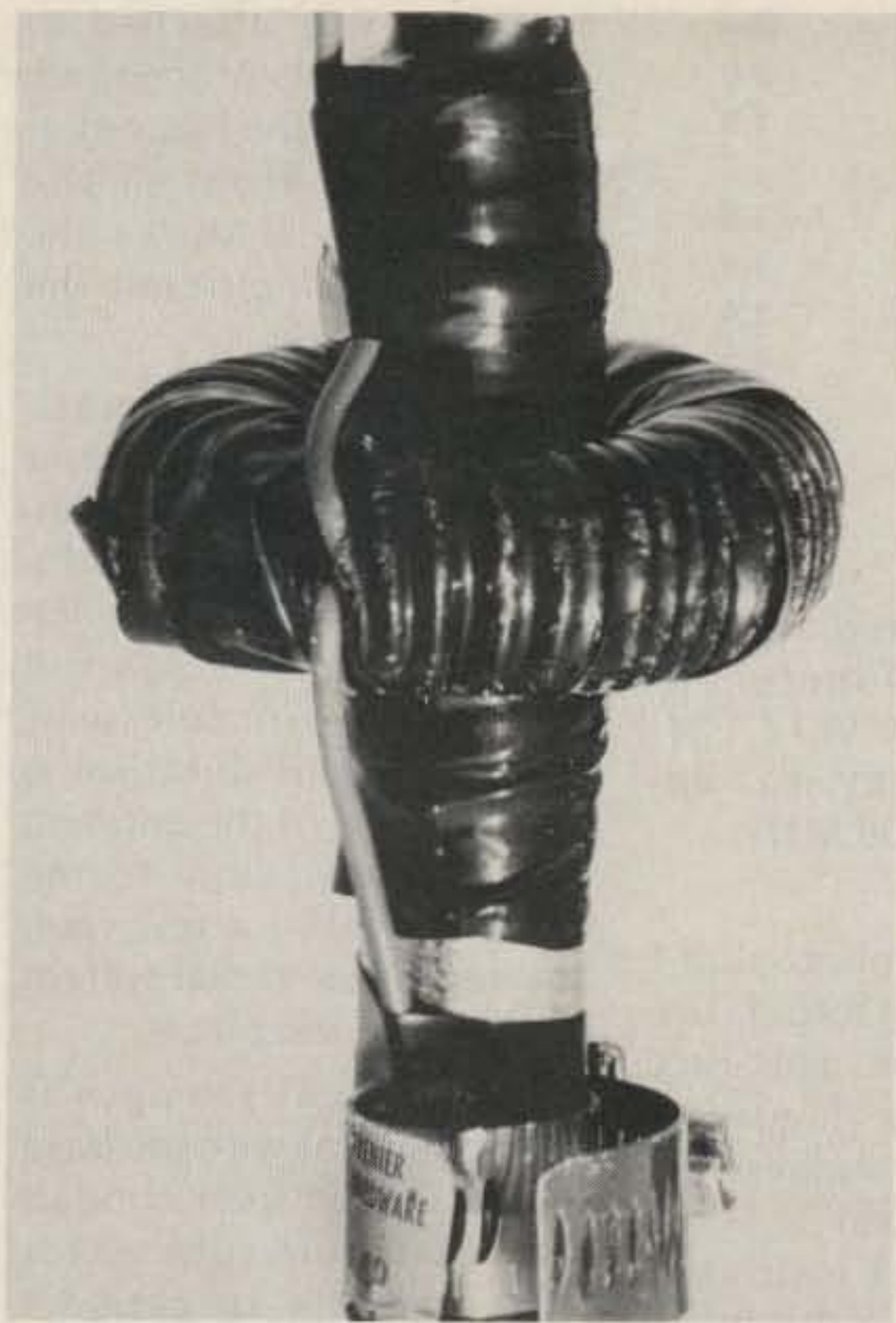

Photo A. Top coil assembly for the inverted psi.

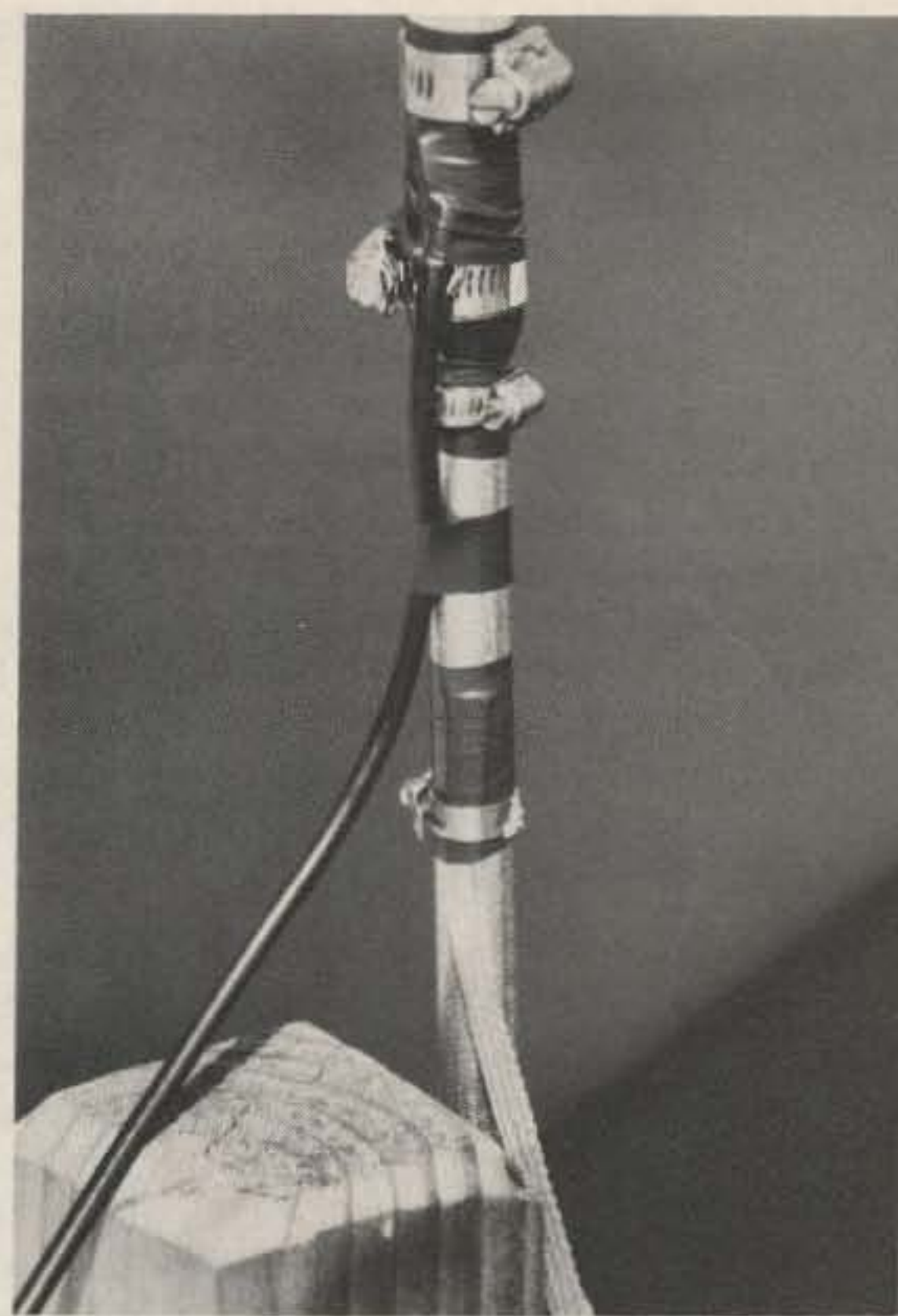

Photo B. This is the base assembly used at W1GV/4.

ductivity many times that of even the best earth.

I used two 30-foot lengths of tinned ground braid immersed in the salt water and running outward from the antenna base in opposite directions (Fig. 3). The tinned braid would not corrode as quickly as plain copper, I figured. This proved to be true. The braid was about 1 cm in width, and this provided good contact with the salt water. A massive radial system was not used and, as it turned out, the antenna

worked very well simply because of the salt water. If you don't have access to a salt-water ground, however, I would recommend that you install as many radials as possible, making them all as long as possible.

Construction of the Top Loading Apparatus

I used a loading coil at the top of the antenna in conjunction with the two 22-foot capacitance-hat wires.

It occurred to me that I could use a toroidal loading coil. I obtained a Palomar Engineers T-200-2 powdered-iron toroid core and wound 38 turns of heavy, insulated wire on it, obtaining an inductance of 17 μ H. (This value was determined by experiment, but I will spare you the details of the painful story: "Put it up, take it down, cut a few turns off, put it up, take it down...")

Being sure that the toroi-

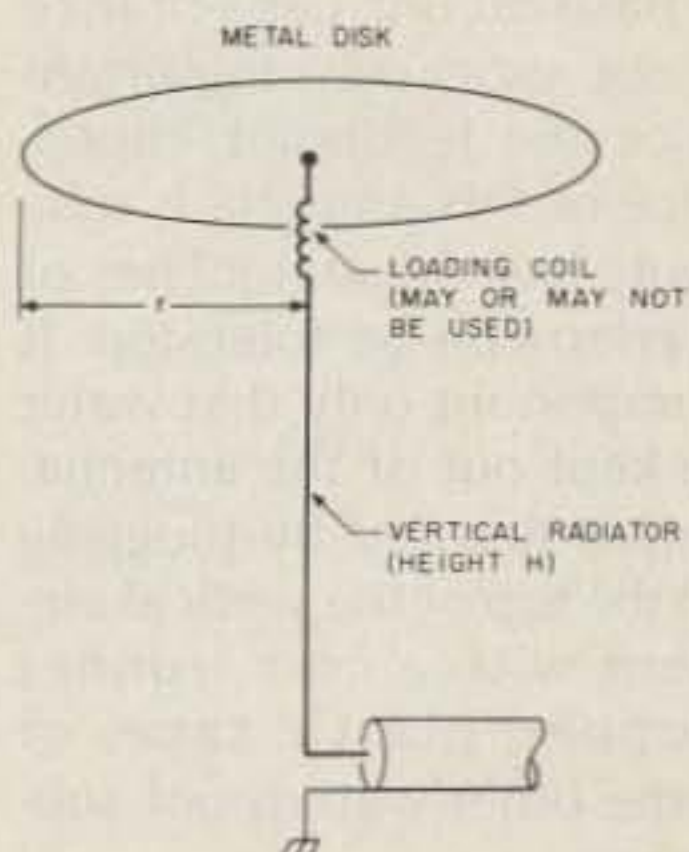

Fig. 2. Ideally, a capacitance hat would take the form of a solid metal disk at the top of a quarter-wave radiator.

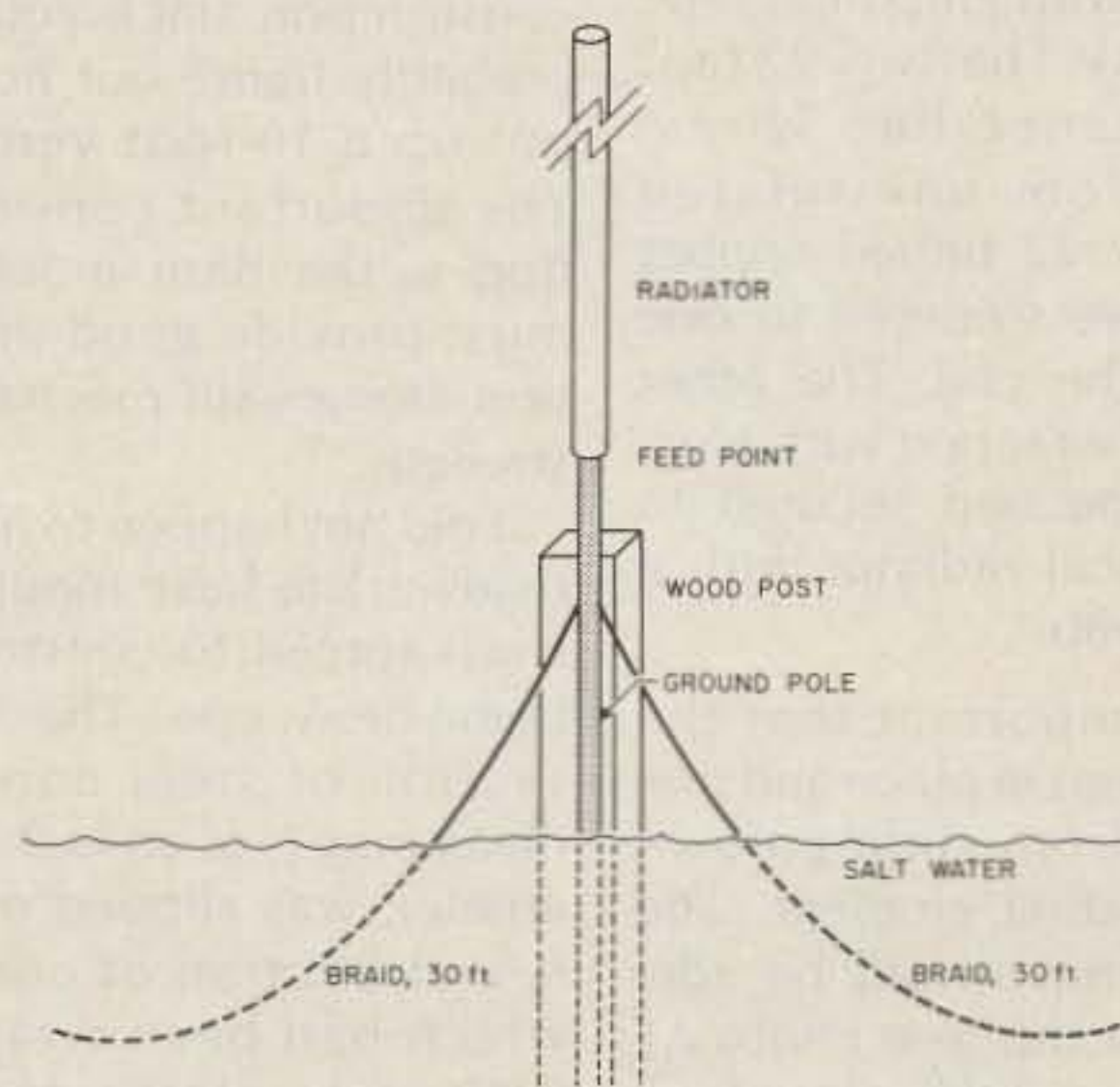

Fig. 3. Grounding scheme used at W1GV/4. The salt water proved to be an excellent ground plane.

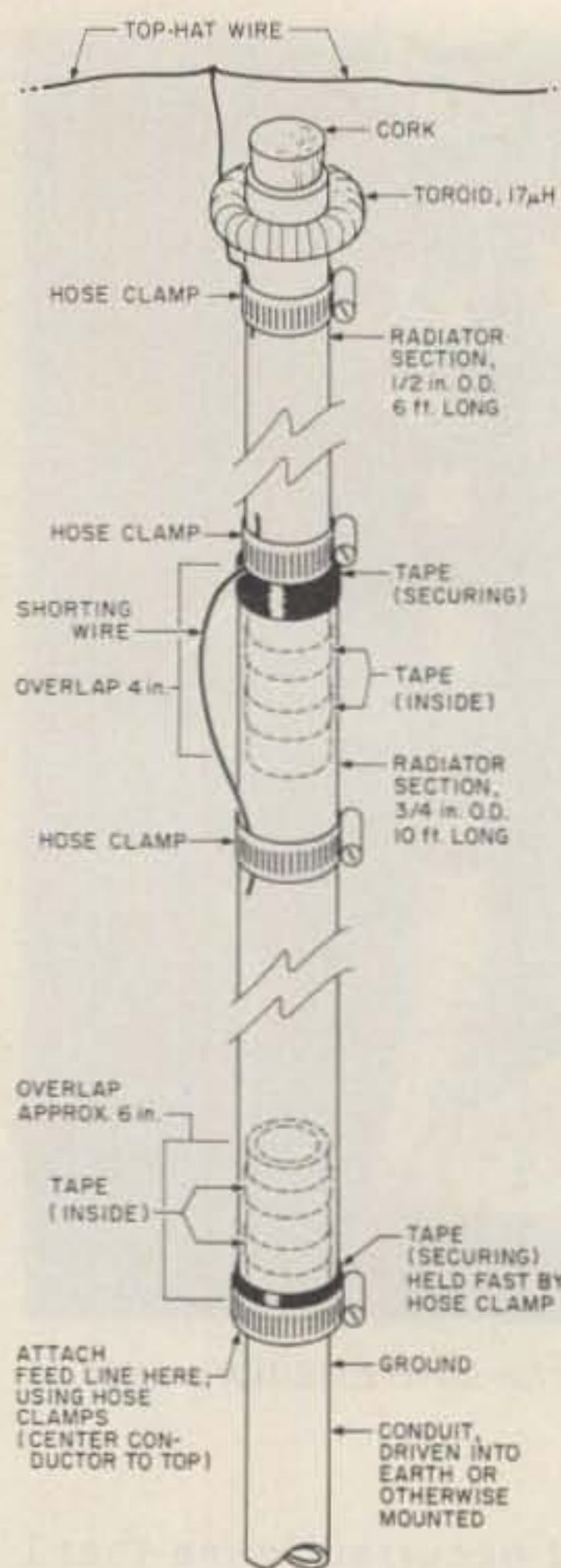

Fig. 4. Diagram of antenna construction, including base assembly. The center conductor of the feedline is connected to the bottom of the 10' section of 3/4" conduit. The coax braid is connected to the top of the lower 1/2"-o.d. section.

dal coil was large enough to fit around the vertical radiator section (which was 1/2" o.d.), I placed it there and secured it with electrical tape (Photo A). The two 22-foot capacitance-hat wires, made from uninsulated AWG no. 22 tinned copper wire, were soldered to one end of the coil. The other end was wrapped with electrical tape and secured to the vertical radiator with a hose clamp.

It is important that the coil be kept in place and prevented from sliding down the radiating element. The hose clamp would be adequate for this (see Photo A), but I put a little extra tape around the vertical radiator for good measure. (You will

Frequency (MHz)	Swr
3.500	2.0
3.525	1.8
3.550	1.7
3.575	1.5
3.600	1.4
3.625	1.4
3.650	1.5
3.675	1.6
3.700	1.9
3.725	2.1
3.750	2.3

Table 2. Measured swr values for the 80-meter inverted psi at W1GV/4. Center frequency was approximately 3.600 MHz.

notice from the photo that I also wrapped the toroidal inductor with tape. This isn't really necessary. I guess I have a certain fondness for black plastic tape.)

The toroidal inductor might not handle the maximum legal power limit. I don't know how much power it will take, although I am reasonably sure it will work with several hundred Watts. I tested this antenna (and used it for general operation) with only 20 Watts of rf output. Another of my loves is QRP. (Do I hear someone saying 20 Watts is QRO?)

Construction

The parts list shows what was needed for the construction of the inverted psi for 20 and 80 meters at W1GV/4. I won't go into a lot of detail regarding the construction since you can probably figure out how to put up a 16-foot vertical. The important consideration is the base mount: It must provide good insulation along with mechanical strength.

I did not happen to have a ready-made base mount, so I was forced to construct a home-brew one. The lower section of steel conduit, measuring 3/4 of an inch in diameter, was slipped over a 1/2-inch section of conduit which had been wrapped with some plastic tape to provide insulation as well as a tight fit. The 1/2-inch section

of tubing was attached to one of the posts of the dock and rested on the bottom of the canal in front of the house. Photo B shows the base mount including the coaxial feedline.

Fig. 4 shows schematically how the base mount was put together. The conduit could be driven into the ground, attached to a fence post, or anchored down in any other reasonable way. The main consideration is that the base of the antenna be reasonably close to the ground—within a few feet, at most, of the radial system or other ground plane.

Mechanical strength is also important with the base mount. I used steel conduit (not aluminum tubing) for this antenna because I couldn't find any aluminum tubing at local hardware stores. This proved to be a good thing, however, since the Florida Keys can get quite windy (55 knots is not unusual) and I was not able to guy this antenna because of its location. The antenna withstood 55-knot winds without incident. For extra strength, you might want to guy the antenna from the top with two pieces of twine or nylon cord in addition to the two top-hat wires. A well-guyed antenna of this kind would probably withstand hurricane-force winds, unless struck by a falling tree branch or other windblown object.

Base-mount capacitance is not especially important since the feedpoint impedance of this antenna is relatively low. Several inches of overlap can be tolerated. It is important only that water be kept out of the antenna. This is ensured by plugging up the top of the vertical element with a cork, rubber stopper, plastic tape, or some other waterproof substance.

Tuning

This antenna will not function over the entire 80m

band since it is an inductively-loaded antenna and is physically shortened. Besides, the 80-meter band is, in terms of percentage, the widest of our high-frequency bands, and even a full-sized antenna won't display a low standing-wave ratio (swr) over the whole range of frequencies.

The inverted psi, given a good ground plane, should have a 2:1 swr bandwidth of 150 to 250 kHz. Table 2 shows measured swr values at W1GV/4, using RG-58/U coaxial-cable (52-Ohm) feedline. The center frequency was chosen by trimming the two top-hat wires a few inches at a time. Naturally, I started out by trimming off way too much wire and had to splice some back on (Murphy 344:24-26). Note: It is not imperative that the two top-hat wires be exactly the same length. A small difference will not have any effect on antenna performance.

The top-hat wires can be brought down at any angle greater than about 45 degrees with respect to the vertical radiator. At W1GV/4, the angle was about 60 degrees. You can run them out horizontally if you wish, but don't bring them down at any angle sharper than that at which the ends of the top-hat wires nearly touch the ground—that's about 45 degrees—and do not electrically connect the ends of the wires to anything metallic! The swr curve as well as the center frequency of the antenna will depend to some extent on the angle at which the wires are brought down. The bandwidth will also be affected somewhat: The larger the angle (the more nearly horizontal the wires), the greater the bandwidth.

The information in Table 2 was obtained at W1GV/4 with an intended center frequency of 3.600 MHz, roughly in the middle of the CW/RTTY/AMTOR band.

WE SHIP WORLDWIDE

Barry Electronics Corp.

WORLD WIDE AMATEUR RADIO SINCE 1950

Your one source for all Radio Equipment!

For the best buys in town call:
212-925-7000
Los Precios Mas Bajos en
Nueva York...



KITTY SAYS: WE ARE NOW OPEN 7 DAYS A WEEK.
Saturday & Sunday 10 to 5 P.M.
Monday-Friday 9 to 6:30 PM Thurs. to 8 PM
Come to Barry's for the best buys in town.



ICOM

IC-R71A, 751, 745, 27A/H, 37A, 47A, R-7000,
127A, 271A/H, 3200A, 471A/H, 735

Ring in the New Year
With the best of Barry's New Gear

KENWOOD



R-600, R-1000, R-2000, TS-940 S/AT
TS 430S, TR-3600A, TR 7950,
TW-4000A. Kenwood Service/Repair.
TH21/31/41AT, TM-211A/
411A & TS-711A/811A

COMPU-FIRE EXTINGUISHERS
EXL-5000E RTTY/AMTOR TERMINAL

VoCom/Mirage/Daiwa
Tokyo Hy-Power
Amplifiers &
5/8λ HT Gain
Antennas IN STOCK



Soldering
Station,

48 Watts, \$68
JBC soldering line in stock.
MICROLOG-AIR I, Air Disk,

KANTRONICS
UTU, Interface II,
Challenger, Packet Comm.



EIMAC
3-500Z
572B, 6JS6C
12BY7A &
4-400A

AEA 144 MHz
AEA 220 MHz
AEA 440 MHz
ANTENNAS

BIRD
Wattmeters &
Elements
In Stock



Alinco
Power Supplies

AMERITRON AMPLIFIER AUTHORIZED DEALER



Computer Interfaces
stocked: MFJ-1224
AEA CP-1, PKT-1, DR.DX
CP-100, PK-64, Dr. QSO,
Morse University



ALPHA AMPLIFIERS

Complete Butternut Antenna Inventory In Stock!

DIGITAL FREQUENCY COUNTERS
Trionyx-- Pro-Com Engineering
Model TR-1000 0-1 GHz 1200HH
0-600 MHz 0-1.3 GHz 1296HH

Long-range Wireless
Telephone for export in stock

BENCHER PADDLES, BALUNS, AUDIO FILTERS, IN STOCK

MIRAGE AMPLIFIERS
ASTRON POWER SUPPLIES
Saxton Wire & Cable



SMART PATCH

CES-Simplex Autopatch 510-SA Will Patch FM
Transceiver To Your Telephone Great For
Telephone Calls From Mobile To Base. Simple
To Use - \$319.95.

PRIVATE PATCH III in stock
CELLULAR 'PHONES STOCKED
FLUKE 77 Multimeter

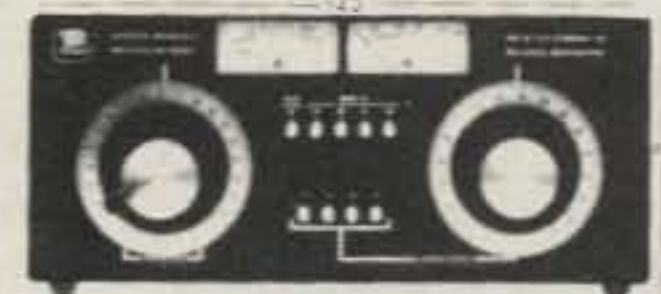

Nye MBV-A 3 Kilowatt Tuner

SANTEC
ST-222/UP
ST-20T
ST-442/UP
HT-7



MFJ Models
422, 313, 1224 & 941D



MURCH
Model
2000 A,
A-LS, B
in stock

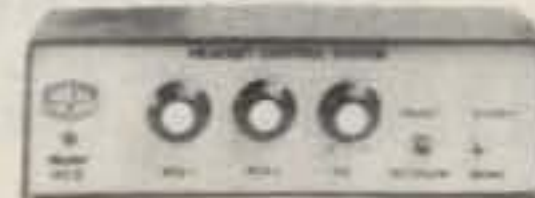

HEIL
EQUIPMENT
IN STOCK



New TEN-TEC
2591HT, Corsair II, Argosy II, Century 22

Tri-Ex Towers
Hy-Gain Towers
& Antennas, and
Rotors will be
shipped direct to
you FREE of
shipping cost.

MAIL ALL ORDERS TO BARRY ELECTRONICS CORP., 512 BROADWAY, NEW YORK CITY, NY 10012.

New York City's LARGEST STOCKING HAM DEALER COMPLETE REPAIR LAB ON PREMISES

"Aqui Se Habla Espanol"

BARRY INTERNATIONAL TELEX 12-7670
MERCHANDISE TAKEN ON CONSIGNMENT
FOR TOP PRICES

Monday-Friday 9 A.M. to 6:30 P.M. Thursday to 8 P.M.
Saturday & Sunday 10 A.M. to 5 P.M. (Free Parking)

AUTHORIZED DIST. MCKAY DYMEK FOR
SHORTWAVE ANTENNAS & RECEIVERS.

IRT/LEX-"Spring St. Station"

Subways: BMT-"Prince St. Station"

IND-"F" Train-Bwy. Station"

Bus: Broadway #6 to Spring St.

Path-9th St./6th Ave. Station.

Commercial Equipment
Stocked: ICOM, MAXON,
Midland, Standard, Wil-
son, Yaesu. We serve
municipalities, busi-
nesses, Civil Defense,
etc. Portables, mobiles,
bases, repeaters...

Local
Ham Club
Speeches
Given

We Stock: AEA, ARRL, Alpha, Ameco, Antenna Specialists, Astatic,
Astron, B & K, B & W, Bash, Bencher, Bird, Butternut, CDE, CES, Collins,
Communications Spec. Connectors, Covercraft, Cushcraft,
Daiwa, Dentron, Digimax, Drake, ETO (Alpha), Eimac, Encomm, Heil-
Sound, Henry, Hustler (Newtronics), Hy-Gain, Icom, KLM, Kantronics,
Larsen, MCM (Daiwa), MFJ, J.W. Miller, Mini-Products, Mirage,
Newtronics, Nye Viking, Palomar, RF Products, Radio Amateur Callbook,
Robot, Rockwell Collins, Saxton, Shure, Telex, Tempo, Ten-Tec,
Tokyo Hi Power, Trionyx TUBES, W2AU, Waber, Wilson, Yaesu Ham and
Commercial Radios, Vocom, Vibroplex, Curtis, Tri-Ex, Wacom Duplexers,
Repeaters, Phelps Dodge, Fanon Intercoms, Scanners, Crystals, Radio
Publications.

WE NOW STOCK COMMERCIAL COMMUNICATIONS SYSTEMS

DEALER INQUIRIES INVITED. PHONE IN YOUR ORDER & BE REIMBURSED.

COMMERCIAL RADIOS stocked & serviced on premises.

Amateur Radio Courses Given On Our Premises, Call

Export Orders Shipped Immediately. TELEX 12-7670

Don't expect your swr curve to be *identical* with that in the table even if you happen to choose the same center frequency. But if you get results that are *dramatically* different, say, a minimum swr of 4:1 or a bandwidth of only 20 kHz, then something is wrong and you should re-check your installation.

Performance

After the tuning and swr-checking phase, it was finally time to start operating with the inverted psi. As I said, I did some casual listening at first and heard a ZL near the bottom of the band. I hadn't ever heard a ZL on 80 meters before, although I must confess I hadn't ever tried that hard for DX on this band. I tried to call him with my 20-Watt output, but to my dismay I noticed that I had neglected to plug my keyboard into the transmitter (Murphy 345:7-8). By the time I had yanked the transmitter off the shelf and

- Parts List**
- 2 Steel conduit or aluminum tubing, 1/2" o.d., 10 ft. long*
 - 1 Steel conduit or aluminum tubing, 3/4" o.d., 10 ft. long
 - 1 Toroid core, powdered-iron, Palomar Engineers T-200-2 or equivalent, wound for 17-uH inductance
 - 2 22-foot lengths of wire, type not critical, AWG no. 22 to 18
 - 2 Insulators for ends of top-hat wires
 - 10 Hose clamps (you can never have too many of these), 1" diameter.
 - 1 Roll of electrical tape
 - 1 Base-mount apparatus, constructed to your own taste
 - 1 Cork for top of antenna
 - 1 Length of coaxial cable, 50-Ohm preferred
 - 1 Roll of strong twine or nylon cord for securing top-hat wires
 - 1 Long roll of wire for radial system (if ground mount used)
 - 1 Ground rod (if earth ground used)
 - 1 Roll of heavy ground braid (if salt-water ground used)
 - 1 Standard tool kit

*One of which is cut to 6-foot length

plugged the keyboard in, the ZL was gone (Murphy 345:9). But other opportunities would come up.

Several fairly distant stations were worked with good reports. A VE1 gave me a 589; he was in a direction almost opposite the salt-water ground plane. Numerous stateside and VE stations were contacted with

ease, and they gave me reports that, in most cases, were as good as or better than those I gave them. (I admit to being stingy: "Good signals" are, I think, S6, right?)

I did not run more than 20 Watts of rf output at any time while using this antenna. For one thing, I had modified my transmitter so

that I couldn't even if I was tempted; secondly, as I've said, I like QRP. And there is another thing. I have a terrible fear of potential TVI/RFI victims who swear a lot and who own guns.

The antenna worked quite well on 20 meters, not to my surprise since it is a full-sized quarter-wave radiator there. If you plan to use this antenna on 14 MHz, you should put the base mount as close to the ground plane as you can manage. In my case, it was 3 to 5 feet above the level of the salt water (depending on the tide), and hence the swr was rather high—the resonant frequency being below the bottom of the band and, moreover, the swr varied as the tide went in and out. Still, worldwide DX was no problem. The antenna would no doubt have worked even better at 14 MHz if I had made it a little shorter to compensate for the elevation of the base. ■



26th Annual

TROPICAL HAMBOREE

FEBRUARY 8-9, 1986

EDWARDS BUILDING, ARNOLD BUILDING AND COLISEUM
DADE COUNTY YOUTH FAIR GROUNDS
TAMIAMI PARK, MIAMI, FLORIDA



- FREE PARKING 15,000 VEHICLES
- 1000 INDOOR SWAP TABLES W/POWER
- AMATEUR RADIO & ARRL PROGRAMS
- LICENSE EXAMS
- QCWA HOSPITALITY CORNER
- CONSUMER ELECTRONIC DISPLAYS
- SATELLITE DISH GARDEN
- HAMBOREE DEALER SPECIALS

- 300 RV SPACES WITH FULL HOOKUPS
- 200 COMMERCIAL EXHIBIT BOOTHS
- DX FORUM & DINNER
- PACKET RADIO DEMONSTRATION
- RCA FL. SECTION LUNCHEON
- COMPUTERS AND SOFTWARE
- 2 DAYS OF PROGRAMS FOR NON-HAMS
- TRAFFIC HANDLERS BREAKFAST

Registration: \$5.00 Advance . . . \$6.00 Door (Valid Both Days)

Swap Tables, 2 Days: \$16.00 Each, Includes Power, Plus Registration Ticket

RV Parking: \$10.00 Per Day, Includes Water, Power, & Sanitary Hook-ups

Hotel Reservation Cards for Special Rates Available - Dec. 1st
(Advance Price Deadline on Registration Tickets, January 20th)

MAKE CHECKS PAYABLE TO: DADE RADIO CLUB, INC., P.O. BOX 350045, MIAMI, FL 33135

4 PAGE BROCHURE AVAILABLE — DEC. 1st.

Exhibit Booth Information: Evelyn D. Gauzens, W4WYR, Chairman
2780 N.W. 3 Street, Miami, FL 33125

Telephone:
305-642-4139

ASTRON POWER SUPPLIES

• HEAVY DUTY • HIGH QUALITY • RUGGED • RELIABLE •

RS and VS SERIES SPECIAL FEATURES

- SOLID STATE ELECTRONICALLY REGULATED
- FOLD-BACK CURRENT LIMITING Protects Power Supply from excessive current & continuous shorted output.
- CROWBAR OVER VOLTAGE PROTECTION on all Models except RS-4A.
- MAINTAIN REGULATION & LOW RIPPLE at low line input Voltage.
- HEAVY DUTY HEAT SINK • CHASSIS MOUNT FUSE
- THREE CONDUCTOR POWER CORD
- ONE YEAR WARRANTY • MADE IN U.S.A.

PERFORMANCE SPECIFICATIONS

- INPUT VOLTAGE: 105 - 125 VAC
- OUTPUT VOLTAGE: 13.8 VDC ± 0.05 volts (Internally Adjustable: 11-15 VDC)
- RIPPLE: Less than 5mv peak to peak (full load & low line)

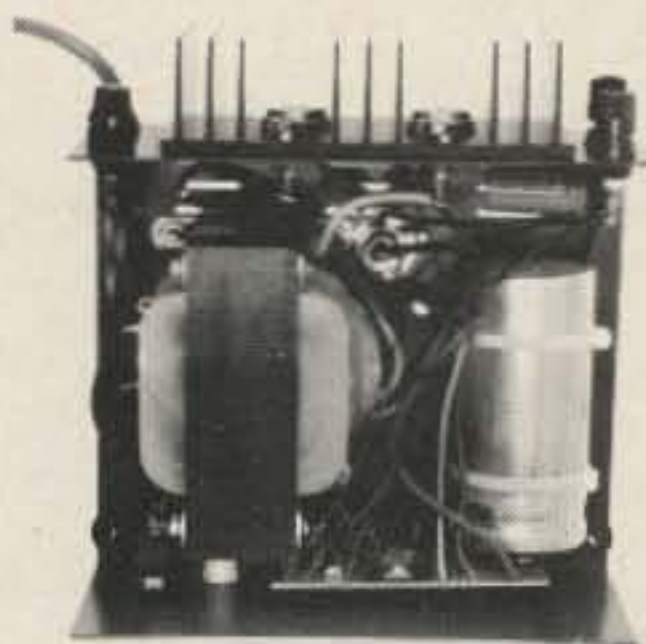

INSIDE VIEW - RS-12A



MODEL RS-50A



MODEL RS-50M



MODEL VS-50M

RM-A Series



MODEL RM-35A

19" X 5 1/4" RACK MOUNT POWER SUPPLIES

Model	Continuous Duty (AMPS)	ICS* (AMPS)	Size (IN) HXWXD	Shipping Wt. (lbs.)
RM-35A	25	35	5 1/4 x 19 x 12 1/2	38
RM-50A	37	50	5 1/4 x 19 x 12 1/2	50
• SEPARATE VOLT & AMP METERS				
RM-35M	25	35	5 1/4 x 19 x 12 1/2	38
RM-50M	37	50	5 1/4 x 19 x 12 1/2	50

RS-A SERIES



MODEL RS-7A

MODEL	Continuous Duty (Amps)	ICS* (Amps)	Size (IN) H x W x D	Shipping Wt (lbs)
RS-4A	3	4	3 3/4 x 6 1/2 x 9	5
RS-7A	5	7	3 3/4 x 6 1/2 x 9	9
RS-7B	5	7	4 x 7 1/2 x 10 3/4	10
RS-10A	7.5	10	4 x 7 1/2 x 10 3/4	11
RS-12A	9	12	4 1/2 x 8 x 9	13
RS-20A	16	20	5 x 9 x 10 1/2	18
RS-35A	25	35	5 x 11 x 11	27
RS-50A	37	50	6 x 13 3/4 x 11	46

RS-M SERIES



MODEL RS-35M

- Switchable volt and Amp meter

MODEL	Continuous Duty (Amps)	ICS* (Amps)	Size (IN) H x W x D	Shipping Wt (lbs)
RS-12M	9	12	4 1/2 x 8 x 9	13
RS-20M	16	20	5 x 9 x 10 1/2	18
RS-35M	25	35	5 x 11 x 11	27
RS-50M	37	50	6 x 13 3/4 x 11	46

VS-M SERIES



MODEL VS-20M

- Separate Volt and Amp Meters
- Output Voltage adjustable from 2-15 volts
- Current limit adjustable from 1.5 amps to Full Load

MODEL	Continuous Duty (Amps) @13.8VDC@10VDC@5VDC	ICS* (Amps) @13.8V	Size (IN) H x W x D	Shipping Wt (lbs)
VS-20M	16 9 4	20	5 x 9 x 10 1/2	20
VS-35M	25 15 7	35	5 x 11 x 11	29
VS-50M	37 22 10	50	6 x 13 3/4 x 11	46

RS-S SERIES



MODEL RS-12S

- Built in speaker

MODEL	Continuous Duty (Amps)	ICS* Amps	Size (IN) H x W x D	Shipping Wt (lbs)
RS-7S	5	7	4 x 7 1/2 x 10 3/4	10
RS-10S	7.5	10	4 x 7 1/2 x 10 3/4	12
RS-10L (For LTR)	7.5	10	4 x 9 x 13	13
RS-12S	9	12	4 1/2 x 8 x 9	13
RS-20S	16	20	5 x 9 x 10 1/2	18

Selcal and State Machines

WA7NBF takes the mystery out of this powerful technique with a hands-on selective-calling project.

Neil A. Robin WA7NBF
21 Canter Lane
Sherwood OR 97140

The majority of hams have been exposed to the popular VHF/UHF FM equipment on the market today. If you've purchased

any, you'll more than likely choose to have the touch-tone™ pad as part of the equipment. Most of us think of the pad as an important part of the two-meter environment because of the frequent availability of autopatch.

However, there are many other uses for the touchtone

pad. One that has been of great interest to me is what is commonly referred to as Selcal (selective calling). We have several repeaters in Oregon (which are on high mountains) with wide coverage and high traffic. I frequently like to listen to these repeaters for calls coming my way, but don't like all the

chatter hour after hour. Selcal will give me the quiet I want without missing calls.

Here's how it works: The receiving station has its audio output interrupted by a circuit which must sense a unique sequence of touchtones sent from the transmitter before it reconnects the audio to the loudspeaker. Whoever is calling at the transmitter must send this code before making a voice call. The specific circuit that senses these tones is called a dual-tone multiple-frequency decoder (DTMF). ("DTMF" is the more technical definition of the touch-tone signals.)

The integrated circuits that do this task are very popular in the telephony business; they are the same circuits used to sense the dialing of your modern telephone. DTMF was cleverly designed so that it minimizes the chance of voice operation "tripping" the circuit. It works on the principle of sending two very precise audio tones over the circuit at the same time. The specifications of these tones are held to tight tolerances.

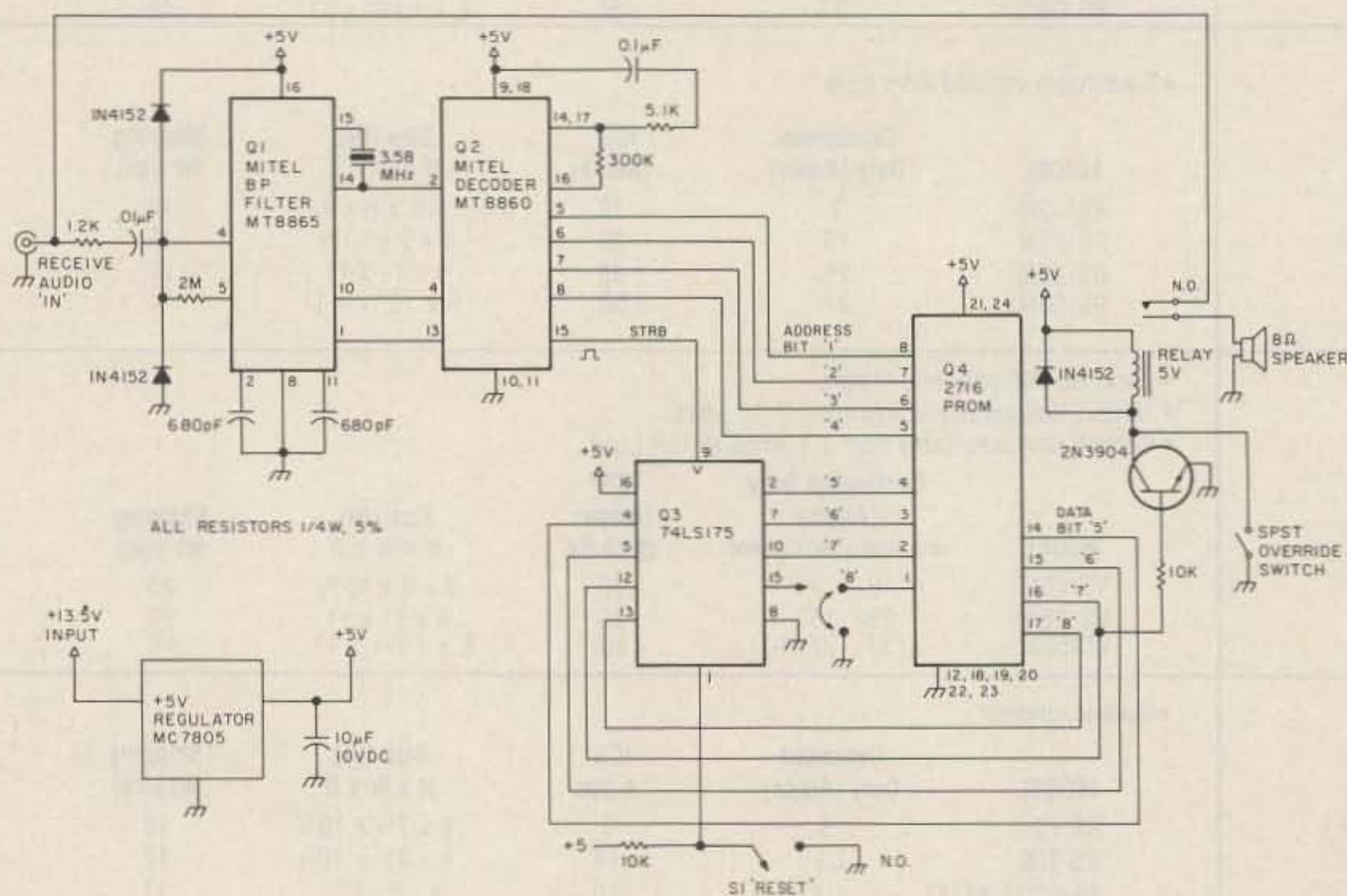

Fig. 1. Selcal schematic.

If you wish to monitor a frequency, then you need to place a decoder on the speaker output of your VHF/UHF rig along with a sequence decoder that detects the proper (secret) keying sequence. An outboard speaker is then wired so that only when the correct sequence is received does it get connected to the receiver audio. All stations calling for you must use the previously-defined sequence to enable your equipment and turn on the speaker.

Once you are done with the contact, you place the decoder in service again and the speaker is disconnected so that you remove all further audio. It's a great way to make life a little easier when you must monitor a repeater. It's great for husband and wife teams (my XYL is a ham), as you can keep in touch throughout the day. It can also be handy for emergency service teams. You can use the Selcal concept to call all the members in time of need using one common Selcal code sequence.

Another frequent use of the touchtone pad is for power-controlling purposes. You may use a sequence of DTMF tones to control any number of electrical devices in your ham shack or elsewhere. We truly have a very powerful tool on the front of our VHF/UHF hand-helds and mobile rigs. The controlling capability is already built into the rig; all we have to do is put it to use. If you let your imagination run wild, it's amazing what you can dream up as possible applications, but in order to keep this article short I will concentrate only on the implementation of Selcal.

DTMF Decoder

The first thing needed in implementing a system is a method of decoding the DTMF signals at the receiver audio. That is relatively easy today. We have modern VLSI integrated circuits which will do the job su-

DTMF Character	Binary Output
D	0000
1	0001
2	0010
3	0011
4	0100
5	0101
6	0110
7	0111
8	1000
9	1001
0	1010
*	1011
#	1100
A	1101
B	1110
C	1111

Table 1. Logic of simple state machine.

perably. Several vendors have them on the market. The one used here is a set of two chips, Mitel MT8865 and MT8860. The first is a DTMF filter and the second is the actual decoder. Mitel informs me that this chip pair now sells for \$28.00 in single-unit quantities. They also have a single-chip version.

The schematic of how they are connected is shown in Fig. 1. The output of Q2 is a simple 4-bit binary data word plus a strobe pulse. The strobe, pin 15, tells the remaining circuitry that it has received a valid DTMF signal and it has lasted long enough to ensure that it is not just random noise. You will notice in Table 1 the binary code that represents each of the unique DTMF codes. This particular chip set decodes all 16 of the tones. Many ham rigs have provision for sending only 12 codes; they leave off the codes for A, B, C, and D. As a result of these chips, we have converted the tones received into a 4-bit binary number. Not very complicated, is it?

Selcal Security

To make a Selcal system secure, it is a good idea to have a long sequence of characters to enable your system. I use a series of four which gives a unique pattern that would occur randomly

GOAL

IF—

Input 1 goes high (logic 1) first and it is followed by input 2 going high while 1 remains high,

THEN—

Enable output high for one clock cycle

Address	Data Out	
0000	00	State 1 (reset state)
0001	01	
0010	00	
0011	00	State 2
0100	00	
0101	00	
0110	00	
0111	10	State 3
1000	00	
1001	00	
1010	00	
1011	00	
1111	00	

Table 2. Mitel MT8860 decoder output.

only once in 65,536 tries. If someone wanted to find out what code I'm using, it would be easier for them to buy a chip set and decode it off the air directly. Also, by having several characters to enable the system, the probability of false triggering through voice patterns or noise is greatly reduced.

In the example, I use an enable sequence of 2-5-8-0 and a disable sequence of 5-6-6. The normal method of decoding a sequence is to use combinational or conventional logic. This usually takes the form of a digital comparator, a shift register, and a matrix of switches to set the code required for matching. This requires a fair amount of circuitry, particularly when you have to decode seven characters as mentioned above. An elegant method of doing this is

called a "state machine" and offers some interesting advantages. First, the state machine is implemented with only two off-the-shelf low-cost integrated circuits. Many sequences can be decoded—far more than described here—with no additional circuitry.

State Machine

The idea behind the state machine needs a little study for those who have worked only with combinational logic. First, most state machines are implemented with just two components: a PROM (Programmable Read Only Memory) and a set of type-D flip-flops. They work on the principle of establishing well-defined states for the logic. The states will progress from one to the next based upon the program that has been burned into

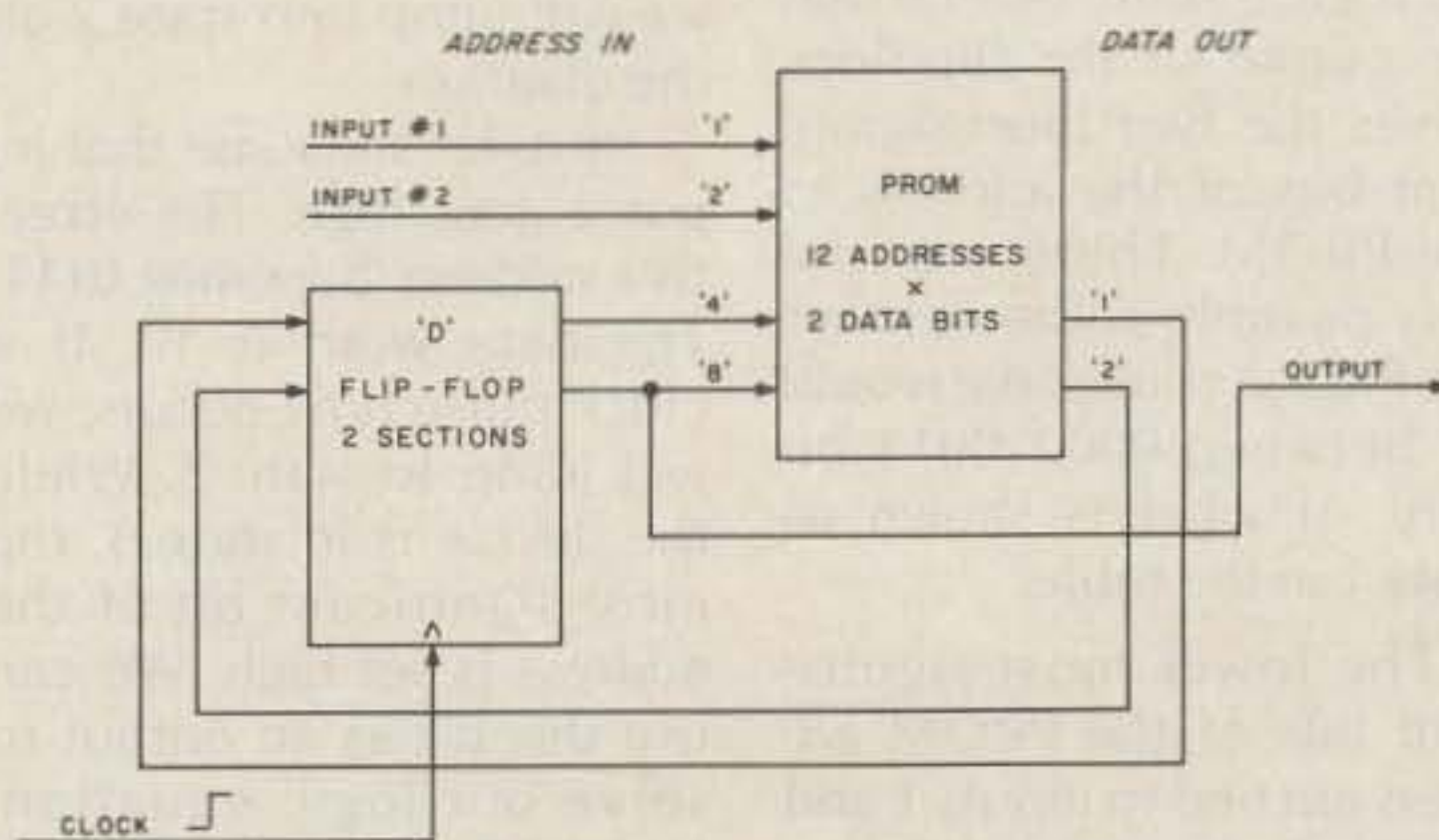

Fig. 2. The simple "state machine."

the PROM, the clocking signal, and the state of the input signals. The idea is well known to people who design microprocessors or other fast sequential logic but is unknown to most electronics experimenters.

To explain how a simple state machine works, let's refer to Fig. 2 and Table 2. First, assume that we have the design task of implementing the logic statement (goal) outlined in the table. Notice that this is not a simple AND gate; it demands that the sequence of input 1 precede 2 by an undetermined amount. Also, be aware that this logic is clocked rather than dc in nature. For anything to happen, the clock pulse must occur.

From this point on, it is important to abandon the idea that the clock must be a periodic signal. Rather, it will be the signal from our DTMF decoder that tells us that a valid code has been received. This is an important characteristic that makes a state machine a good way of implementing a Selcal circuit. The state machine advances only after we press a touchtone key at the transmitter. From a timing point of view, it will be random.

Now assume that we have programmed our 12-address-by-2-bit PROM with the code shown in the Table 2 truth table. The reason for this particular code will become obvious shortly. We will start with the output of the two type-D flip-flops in the logic 0 state. Notice that the output of the flip-flops drives the two most-significant bits of the address to the PROM. Therefore, the only possible addresses that the PROM could take would be between 0000-0011 binary, or what is shown as state 1 in the table.

The lower most-significant bits of the PROM address are tied to inputs 1 and 2. Hence, the state of the input signals controls, in part,

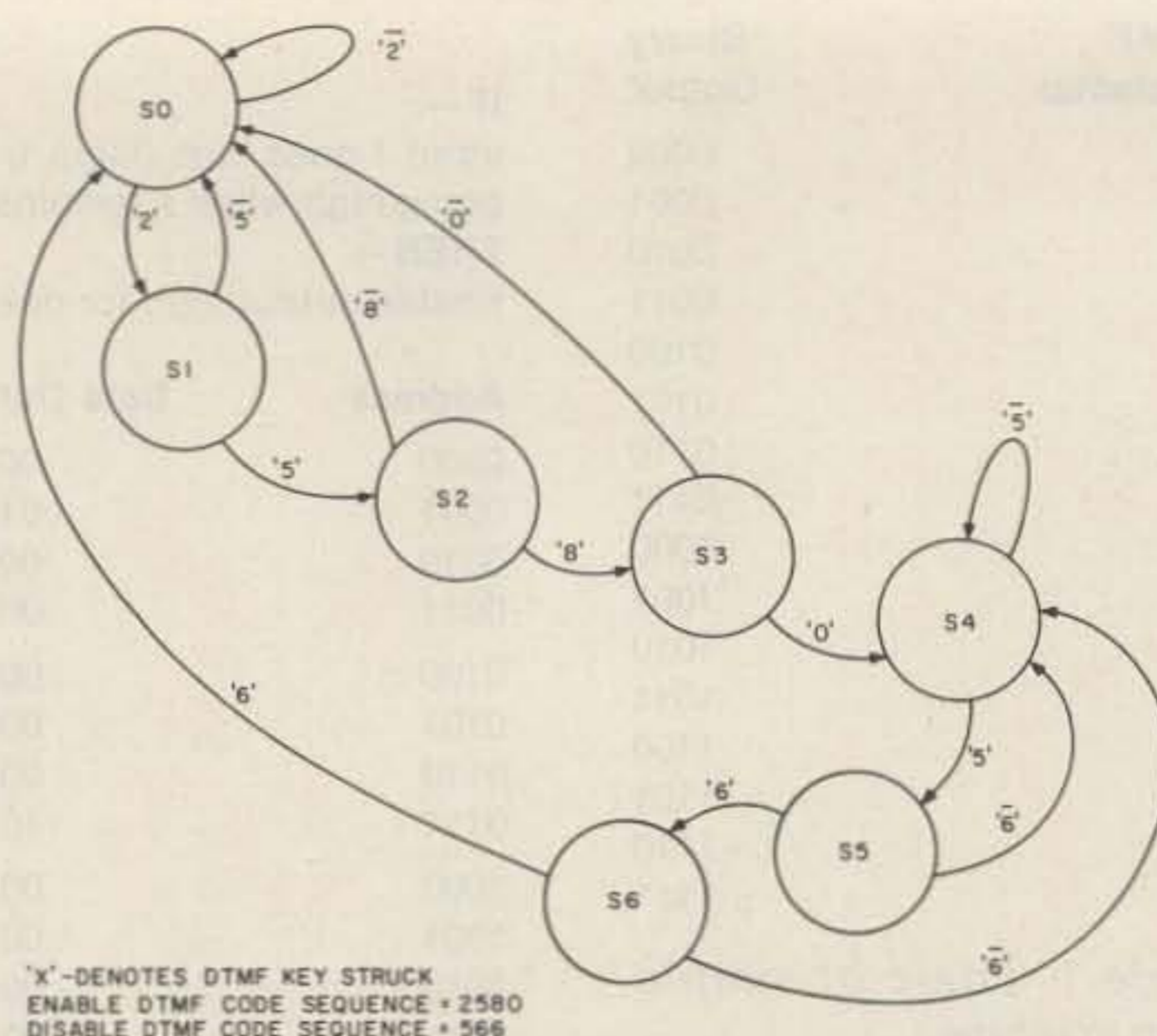

Fig. 3. Selcal state program.

the PROM address. If the states of the inputs are both low, the effective address of the PROM will be 0000. Now notice that the data word out of the PROM for that address is 00. In addition, the output of the PROM is also fed back to the input of the D flip-flops so that when a positive transition of the clock pulse occurs, the two most-significant bits of the PROM address will be updated.

In the example so far, they will be updated to 00 since that was the output of the PROM just before the clock pulse. The effective address of the PROM remains 0000. We also can say that the device remains in state 1. Now let's change input 1 to logic 1. The effective address is now 0001, but notice that the data word is now 01. If a clock pulse occurs at this time, the new effective address will become 0101 and we will jump into state 2 on the diagram.

Next, let's assume that input 2 goes high. The effective address becomes 0111. The data word is 10. If a clock pulse now occurs, we will jump to state 3. While the device is in state 3, the most-significant bit of the address is set high. We can use this bit as an output to solve our logic equation. Notice that it remains high until the next clock, which

then will drive the circuit back to state 1 in all cases since the data word is 00 for every condition of the input lines. The next effective address must be somewhere in state 1.

Now we'll go back to state 2 and see what would happen if input 2 didn't go high during this state. The effective address would be 0101 and the data word would be 00. The next clock pulse would load the flip-flops with 00 which would, of course, drive the most-significant address bits back to the state 1 condition. We see that the logic was not satisfied and the output was never driven to state 3. It should now be clear that to get an output-high condition, the proper sequence of events in this particular goal statement must be satisfied. If they are not, the logic forces you to keep jumping back to the reset state—state 1.

Many variations of these concepts exist. It is suggested that the reference at the end be used if you wish further information. One common difference that you find on most state machines is that the output usually is taken from the data word directly. In this example, it's easier to take it from the flip-flops. Most machines are based on this simple idea of a PROM and D

flip-flops. The great advantage is the simplicity of the hardware and thus the very low cost.

Selcal or Bust

Now that we have the foundation of the concepts, let's put it to practical use. Suppose that we want to build a Selcal circuit that will activate our receiver speaker whenever the DTMF sequence of 2-5-8-0 is received and will disable it when 5-6-6 is received. We will use a 2716 PROM (UV erasable) which can be purchased for \$2.95, plus a 74LS175 quad-D flip-flop which is about \$0.75. See Fig. 1. The PROM is very popular with the computer hobbyist and has a configuration of 2048 addresses by 8 bits. We will use it as if it really were only 128 addresses by 4 bits. We have far more capability in this device than we need, but on the other hand it's cheap and we may want to expand our circuit with more exotic capabilities at a later date. A great place for experimentation.

The state machine is driven by the Mitel MT8860—Q2 in Fig. 1. The output of this chip follows the truth table in Table 1. These four bits will be used as the four least-significant address bits of the PROM. The next three most-significant bits will be derived from the output of the D flip-flops (3 each). The inputs to the flip-flops result from bits 5, 6, and 7 out of the PROM data word. Bit 8 is also routed to one of the flip-flops in Q3 but is used for future expansion only. Data output bits 1-4 will not be used and are not shown. (They could be used as outputs if desired.)

Earlier, I mentioned that the clock to a state machine may be from a random event. Here we'll derive the clock from the strobe command out of Q2. This signal goes high when a valid DTMF tone has been de-

tected, so it may be somewhat random. The relay to connect the loudspeaker is driven off bit 7 of the data word. The entire circuit including the DTMF decoder requires only four integrated circuits.

The first step in programming the PROM is to introduce the concept of the "state diagram." This is shown in Fig. 3. It is much like a flowchart, but we specifically refer to each condition as a "state" or address subsection in the PROM. It is an excellent diagram to show what happens when an invalid code is received.

State 0 (S0) is the reset state. The only way to advance to state 1 (S1) is to receive a 2 in the DTMF code. Once in state 1, you must receive a DTMF 5 code to advance to state 2, etc. Notice what happens if you are in state 1 and something other than DTMF 5 is received: You resort back to state 0. By studying this diagram, you will see that the only code sequence that will allow you to advance to state 4 will be 2-5-8-0.

State 4 is the address range, \$40-4F (a \$ ahead of a number means it is in hexadecimal). Bit 7 is used as an output, hence the speaker is turned on. In fact, it will remain on until the 5-6 sequence occurs, and will be unconditionally off after the 5-6-6 sequence and the state diagram shows a return to state 0. The PROM program is shown in the PROM program listing. To change to some other sequence you need only change the program.

The listing is shown in hexadecimal. The PROM was programmed using an assembler on the Apple II computer. With only 128 addresses needed, it could be done manually. The computer is handy, as it makes the programming very simple. If you don't have a PROM burner in your ham shack, locate a fellow ham who is into both ham radio

and computers. More than likely it won't take long to find someone who can help. Also try the local computer club.

The actual hexadecimal addresses are located on the left-hand side of the listing. Notice the state labels, S0, S1, S2, etc., after the line numbers. They point to the beginning of the address group that represents that particular state. Since IC Q2 determines the lowest 4 bits of the effective PROM address, each state will have a total of 16 possible addresses. One of the data words in each group of 16 will point to the beginning of the next state if that particular effective address is chosen.

For example, assume you are resting in state 1, and Q2 sends a 0001 to the PROM. This is the equivalent to a DTMF 1 from Table 1. The effective address will now be \$11. This is true because Q3 must be statically holding a \$01 (to force it to state 1) plus the 0001 code from Q2. Location \$11 produces, from the listing, a data word of \$00. When the next clock pulse occurs from pin 15 of Q2 (which means a valid DTMF tone is received), a \$00 will be loaded into Q3 and the PROM address

range will return to the state 0 address range.

Now let's go back again and assume we are currently resting in state 1 and this time a DTMF 5 occurs. This puts 0101 into the lower 4 bits of the PROM and makes the effective address \$15. Now, at the time of pin 15 strobe, the data word of \$20 will be presented to Q3 and the machine will go into state 2. We are hence progressing down the state diagram in Fig. 3 to solve for the unique combination of 2-5-8-0.

You will notice that once you get to state 4, bit 7 of the data word will be high. With bit 7 connected to the base resistor of the 2N3904, the relay will be enabled. This relay controls the speaker. The relay will remain enabled until the unit is either manually reset by pressing push-button S1 or by sending the reset code which will cause the machine to progress to S5, S6, and a return to S0.

A word about state 7 is needed. You'll notice on the state diagram that we never call the state 7—so why was it coded into the PROM? The PROM is hard-wired so that addressing bits 9, 10, and 11 are held at logic 0.

That restricts the possible addressing range to the lowest 128 addresses, which is \$7F in hexadecimal. When power is applied, we want to be sure that the machine comes up in a recoverable state. S7 is a possible power-up state since it is in the possible address range. When in S7, Q3 will force the PROM into S0 the next time a signal comes from pin 15 of Q2. Likewise all other states can be shown to be recoverable.

Another way would be to cause a reset to Q3 upon power-up. This would always guarantee that state 0 was reached, but without state 7 there is still the possibility of a lockup. The best solution is to use both. I didn't incorporate an auto-power-up reset in the circuit since it self-recovers if you have a power failure. The manual reset push-button, S1, is used for local reset in the event the caller did not send the reset sequence, 5-6-6.

Notice the jumper at pin 15 of Q3. In this example, the Q4 address bit 8 is grounded rather than being connected to pin 15. This restricts the address range as mentioned above to 128. When this jumper is connected to extend the addressing range to 256, it represents the latched 8th bit of the data word. It could be used for an additional control circuit. In addition, the lower 4 bits of the Q4 data word serve no purpose in this design, but could easily be used for additional control circuits. With Q3 being four bits wide, and Q2 supplying four bits, the maximum address range is 256.

The PROM has a capacity of 2048. To extend the useful range to its maximum capability, some additional storage registers are needed. This could be done by adding another 74LS175 or by feeding some of the data bits back into the addressing lines. That is beyond the scope of this introductory article.

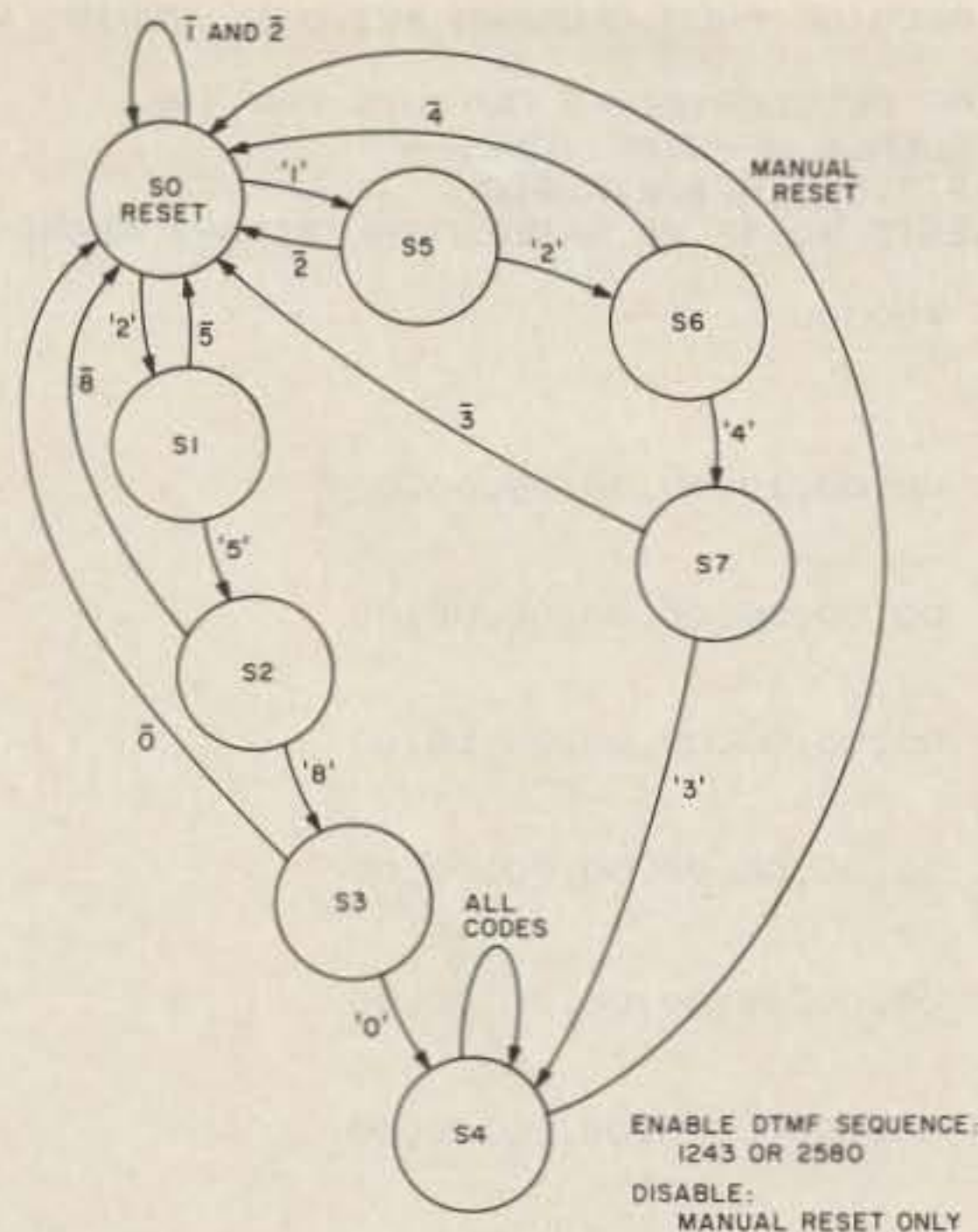

Fig. 4. Dual-sequence Selcal.

```

1  */DTMF STATE MACHINE FROM PROGRAM #V2.0-N. ROBIN, WA7NBF
2  *
3  *THE MITEL DTMF DECODER GIVES OUTPUTS FOR THE
4  *FOLLOWING SEQUENCE OF DTMF TONES--
5  *D,1,2,3,4,5,6,7,8,9,0,*,#,A,B,C
6  *WHICH REPRESENTS $0-$F AS SEQUENTIAL BINARY ADDRESSES
7  *
8          ORG  $0000
9  *
0000: 00 00 10
0003: 00 00 00
0006: 00 00 10 S0      HEX  00,00,10,00,00,00,00,00
0008: 00 00 00
000B: 00 00 00
000E: 00 00 11      HEX  00,00,00,00,00,00,00,00
0010: 00 00 00
0013: 00 00 20
0016: 00 00 12 S1      HEX  00,00,00,00,00,20,00,00
0018: 00 00 00
001B: 00 00 00
001E: 00 00 13      HEX  00,00,00,00,00,00,00,00
0020: 00 00 00
0023: 00 00 00
0026: 00 00 14 S2      HEX  00,00,00,00,00,00,00,00
0028: 30 00 00
002B: 00 00 00
002E: 00 00 15      HEX  30,00,00,00,00,00,00,00
0030: 00 00 00
0033: 00 00 00
0036: 00 00 16 S3      HEX  00,00,00,00,00,00,00,00
0038: 00 00 40
003B: 00 00 00
003E: 00 00 17      HEX  00,00,40,00,00,00,00,00
0040: 40 40 40
0043: 40 40 50
0046: 40 40 18 S4      HEX  40,40,40,40,40,50,40,40
0048: 40 40 40
004B: 40 40 40
004E: 40 40 19      HEX  40,40,40,40,40,40,40,40
0050: 40 40 40
0053: 40 40 40
0056: 60 40 20 S5      HEX  40,40,40,40,40,40,60,40
0058: 40 40 40
005B: 40 40 40
005E: 40 40 21      HEX  40,40,40,40,40,40,40,40
0060: 40 40 40
0063: 40 40 40
0066: 00 40 22 S6      HEX  40,40,40,40,40,40,00,40
0068: 40 40 40
006B: 40 40 40
006E: 40 40 23      HEX  40,40,40,40,40,40,40,40
24  *
25  *STATE S7 IS NOT USED BUT STILL MUST BE INCLUDED FOR
26  *POWER UP INITIALIZING.
0070: 00 00 00
0073: 00 00 00
0076: 00 00 27 S7      HEX  00,00,00,00,00,00,00,00
0078: 00 00 00
007B: 00 00 00
007E: 00 00 28      HEX  00,00,00,00,00,00,00,00

```

PROM program listing

Construction

The crystal shown in the diagram for Q1 is a standard low-cost TV sub-carrier type. The ICs use different sockets: two with 16 pins, one with 18 pins, and one with 24 pins for the 2716. All of these parts should be easy to obtain by mail order or any store that caters to the computer hobbyist. The silicon diodes can be any general-purpose small-signal type, and the capacitors are not critical.

The relay was found in my

junk box, but any type that is compatible with the power supply and the driver transistor will work. The actual circuitry uses only +5 volts. Since my receiver runs off +13.5 volts, I chose to power the unit with a packaged +5-volt regulator, the MC7805C. It costs about \$0.95. The layout is noncritical, but some care should be taken to avoid static in handling the IC devices. It is recommended that a metal box be used for an enclosure since strong rf fields in the immediate vicinity can cause erratic operation. Use shielded audio input lines,

and be sure that the power leads have rf bypassing.

Although this unit uses only four ICs, Mitel now has a single-chip DTMF decoder, the MT8870, which sells for about \$20.00 and could reduce the count to three devices. I've not experimented with it. (The West Coast sales office can be reached at (408)-249-2111.)

Emergency Calling

An important additional feature that could be designed into the PROM program is a dual-access code. The first would be your own

private sequence such as 2-5-8-0, and the second would be common to all your members, say 1-2-4-3. Fig. 4 shows the state diagram of this hypothetical example. Whenever a sequence of 1-2-4-3 is received, all members of your organization would have their Selcal circuit activated. Whenever the 2-5-8-0 is sent, you would be the only one to have your system enabled. This is a powerful way to organize an emergency services net, for example. Reset would occur manually.

Disadvantages

Although the state machine is very cheap to reproduce, it suffers when you change to a new coding sequence since you must burn a new PROM. I personally don't consider this a problem because I have equipment handy to do the job. Many people may not. At first you may think of it as complicated, but it just takes getting used to thinking in terms of state-machine implementations instead of conventional logic. You'll be happy later because of simpler circuits and greater reliability. The state machine is more familiar to computer types rather than old-time rf guys, but on the other hand, this may be a good way to learn.

Operation

A few things have been noted in the use of the circuit. First, it's always a good idea to start the DTMF sequence with some unused key. In the above example, this could be "#". The sequence then would be: #-2-5-8-0. The reason is that noise may have taken the state machine to state 1 or 2. Any non-valid key will drive the state back to 0. From that point on, you know the proper sequence to follow. This helps ensure that you start out in a reset state.

The second observation is that if you have reached state 4, you cannot get back

- ★ TECHNICAL FORUMS
- ★ ARRL AND FCC FORUMS
- ★ GIANT 3-DAY FLEA MARKET
Starting Noon Friday
All Day Saturday and Sunday
- ★ LICENSE EXAMINATIONS
- ★ NEW PRODUCTS AND EXHIBITS
- ★ GRAND BANQUET
- ★ ALTERNATIVE ACTIVITIES
- ★ SPECIAL GROUP MEETINGS
- ★ YL FORUM
- ★ PERSONAL COMPUTER FORUM
- ★ CW PROFICIENCY AWARDS
- ★ AMATEUR OF YEAR AWARD
- ★ SPECIAL ACHIEVEMENT AWARDS

DAYTON Hamvention®

April 25, 26, 27, 1986

Hara Arena and Exhibition Center — Dayton, Ohio

Meet your amateur radio friends from all over the world at the internationally famous Dayton HAMVENTION.

Seating will be limited for Grand Banquet and Entertainment on Saturday evening so please make reservations early.

If you have registered within the last 3 years you will receive a brochure in January. If not, write Box 44, Dayton, OH 45401.

Nominations are requested for Radio Amateur of the Year and Special Achievement Awards. Nomination forms are available from Awards Chairman, Box 44, Dayton, OH 45401.

For motel rates and reservations write to Hamvention Housing, 1980 Kettering Tower, Dayton, OH 45423-1980. Housing information phone, (513) 223-2612.

NO RESERVATIONS WILL BE ACCEPTED BY TELEPHONE.

All other inquiries write Box 44, Dayton, OH 45401 or phone (513) 433-7720.

ALL Flea Market spaces will be sold in advance ONLY. NO spaces sold at gate. Entrance for set-up available starting Wednesday. Special Flea Market telephone (513) 223-0923.

Bring your family and enjoy a great weekend in Dayton.

Sponsored by the Dayton Amateur Radio Association, Inc.

ADMISSION

\$8 in advance, \$10 at door.
(Valid for all 3 days)

BANQUET

\$14 in advance, \$16 at door.

FLEA MARKET SPACE

\$20 in advance.
(Valid for all 3 days)

Checks for advance registration to
Dayton HAMVENTION
Box 2205, Dayton, OH 45401

Registration processing
starts Jan. 1, 1986.

(Admission tickets must be ordered
with Flea Market spaces.)

Your Ham Tube Headquarters!

TUBES BOUGHT, SOLD AND TRADED
SAVE \$\$\$—HIGH \$\$\$ FOR YOUR TUBES

Call Toll Free 800-221-0860
Tubes

3-400Z	\$85.00	7360	\$13.75
3-500Z	85.00	6550A	7.50
4-400A	80.00	8072	125.00
4CX250B	59.00	8156	12.50
572B	57.00	8643	82.50
811A	12.00	8844	26.50
813	30.00	8873	195.00
6146B	8.50	8874	225.00
6360	4.25	8877	595.00
6883B	8.00	8908	14.50

Semiconductors

MRF 245/SD1416	\$30.00	MRF 644	\$23.95
MRF 454	18.95	SD1088	19.95
MRF 455	13.95	2N305575
		2N6084	12.50

RF Connectors

PL259	10/\$4.95	M358	2.50 ea.
PL258	10/8.95	M359	1.75 ea.
UG175/176	10/1.60	Type "N" Twist on	
UG255/u	2.50 ea.	(RG8/u)	\$4.75 ea.
UG273/u	2.25 ea.	Minimum Order	\$25.00

Allow \$3.00 min. for UPS charges

CeCo

COMMUNICATIONS, Inc.

2115 Avenue X Brooklyn, NY 11235

Phone (718) 646-6300

SERVING THE INDUSTRY SINCE 1927

Call CECO For Your CCTV Security And Color Production Requirements

AMATEUR TELEVISION



KPA5 1 WATT 70 CM ATV TRANSMITTER BOARD

- **APPLICATIONS:** Cordless portable TV camera for races & other public service events, remote VCR, etc. Remote control of R/C airplanes or robots. Show home video tapes, computer programs, repeat SSTV to local ATVers. DX depends on antennas and terrain typ. 1 to 40 miles.
- **FULL COLOR VIDEO & SOUND** on one small 3.25x4" board.
- **RUNS ON EXTERNAL 13.8 VDC** at 300 ma supply or battery.
- **TUNED WITH ONE CRYSTAL** on 426.25, 434.0, or 439.25 mHz.
- **2 AUDIO INPUTS** for a low Z dynamic and line level audio input found in most portable color cameras, VCRs, or home computers.
- **APPLICATION NOTES & schematic** supplied for typical external connections, packaging, and system operation.
- **PRICE ONLY \$159** delivered via UPS surface in the USA. Technician class amateur license or higher required for purchase and operation.

WHAT IS REQUIRED FOR A COMPLETE OPERATING SYSTEM? A TV set with a TVC-2 or TVC-4 420-450 mHz to channel 3 downconverter, 70 cm antenna, and coax cable to receive. Package up the KPA5, add 12 to 14 vdc, antenna, and any TV camera, VCR, or computer with a composite video output. Simple, eh?

CALL OR WRITE FOR OUR COMPLETE CATALOG & more info on atv downconverters, antennas, cameras, etc., or who is on in your area.

TERMS: Visa, Mastercard, or cash only UPS COD by telephone or mail. Telephone orders & postal MO usually shipped within 2 days, all other checks must clear before shipment. Transmitting equipment sold only to licensed amateurs verified in 1984 Callbook. Calif. include sales tax.

(818) 447-4565 m-f 8am-6pm pst.

P.C. ELECTRONICS

Tom W6ORG Maryann WB6YSS



2522 Paxson Lane
Arcadia CA 91006

DOCKING BOOSTER

Converts Your HT to a Powerful Mobile Unit



30 or 50 watts output
16 DB GaAs FET
pre-amp
Fits on most
car doors
Mic hang-up clip
Icom, Yaesu,
Kenwood
2 Meters & 70 cm

\$149⁹⁵

CMC COMMUNICATIONS, INC.
5479 Jetport Industrial Blvd. • Tampa, FL 33614
Phone: 813-885-3996

to state 0 without sending cancel code 5-6-6 or hitting the reset push-button. Here again, use an unused key first before you send the 5-6-6, e.g., #-5-6-6. This will force the machine back to state 4 before you send the correct sequence to reset the circuit.

If you intend to use this device through a repeater, be sure to get permission from the control operator. Give him your access code, out of courtesy. If he's aware of the code you're using he can tell you if you have selected any sequence that could cause problems with the repeater-control system. This is particularly true when using a random reset code. One that I always try to avoid is the "*". Many repeaters begin their autopatch operation with an asterisk.

I've checked with the FCC as to the acceptability of using the described concept and they see no problem. If

you're considering using the DTMF tones for controlling electrical circuits, check with the amateur rules as to acceptance.

Another operational approach seems to be to leave the squelch open when the Selcal is enabled so that when you do hear the receiver hissing noise, even if you were out of the room, you know that someone has tried to call. When you attach the Selcal to your rig, the local built-in speaker should automatically be disconnected. All rigs I've seen work in this fashion so you shouldn't have any modifications to make to your radio equipment.

There are many variations to the above circuit. Let your imagination flow and let me know all the good ideas that result. Happy Selcalling! ■

Reference: *Designing Logic Systems Using State Machines*, Christopher R. Claire, McGraw-Hill Book Co.

NEW from BARKER & WILLIAMSON!

1.8 - 30 MHz. Continuous Coverage Antenna for Commercial and Amateur Service

Model AC 1.8 - 30

The AC 1.8 - 30 Antenna uses only 80 feet horizontally, and, when space is limited, can be shortened even further with only slight loss of radiation efficiency.

U.S. Patent
4,511,898

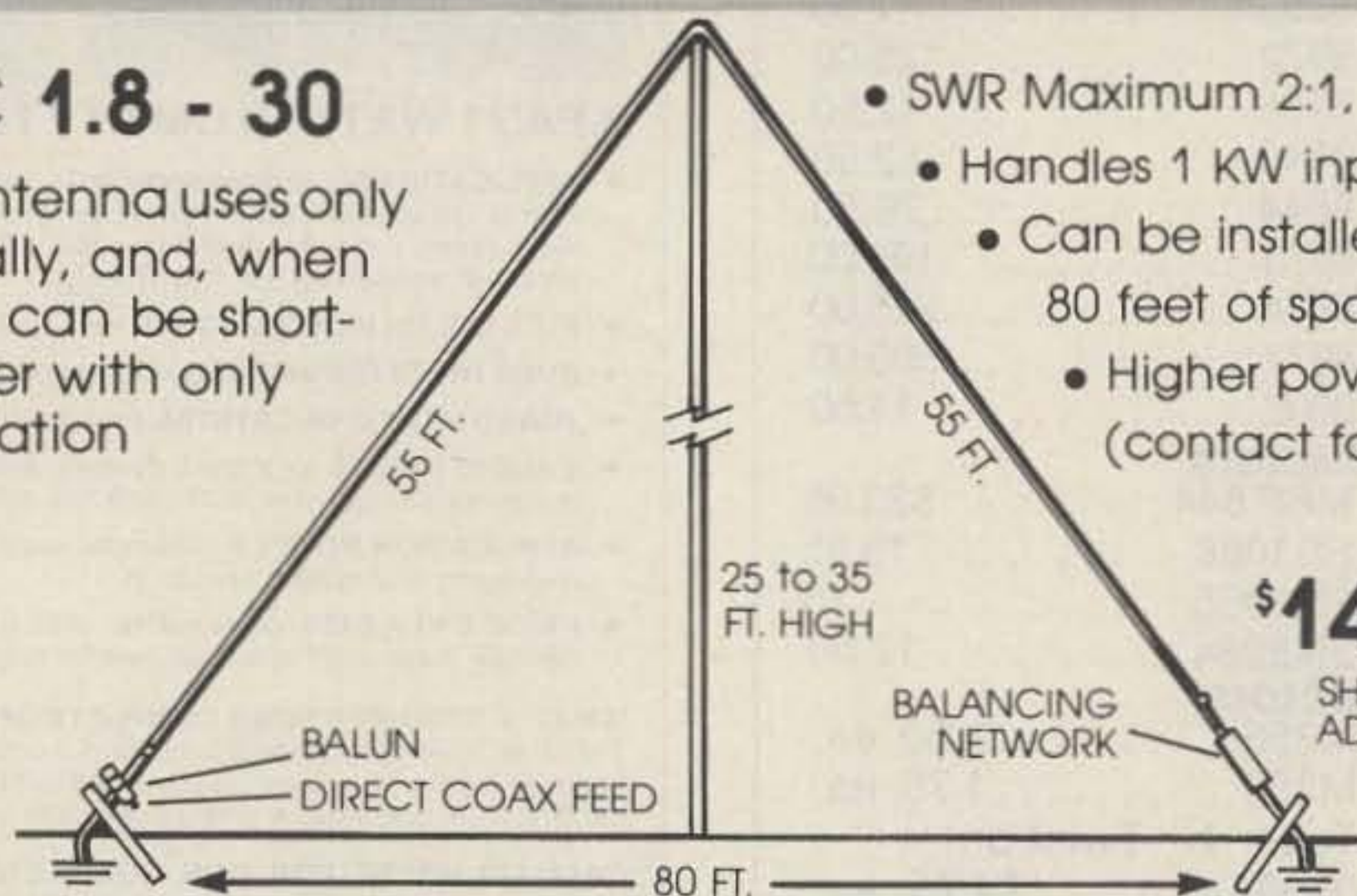

- SWR Maximum 2:1, 1.4:1 Average
- Handles 1 KW input ICAS
- Can be installed in approximately 80 feet of space
- Higher power models available (contact factory)

\$149.⁵⁰

SHIPPING AND HANDLING
ADD \$4.00



BARKER & WILLIAMSON

Quality Communication Products Since 1932
At your Distributors write or call, 10 Canal Street, Bristol PA 19007
(215) 788-5581

ALL OUR PRODUCTS MADE IN USA



★ QUALITY PARTS ★ DISCOUNT PRICES ★ FAST SHIPPING!

ALL ELECTRONICS CORP.

SEND FOR
FREE
NEW 1986 CATALOG...
48 PAGES!

EDGE CONNECTORS
ALL ARE 1.56" SPACING.

- 22/44 EDGE CONNECTOR
PC style \$2.00 each
10 for \$18.00
- 22/44 EDGE CONNECTOR
solder lug style \$2.50 each
- 28/56 EDGE CONNECTOR
PC style \$2.50 each
10 for \$22.00
- 36/72 EDGE CONNECTOR
PC style \$3.00 each
- 43/86 EDGE CONNECTOR
PC style \$4.50 each

TRANSISTORS

- 2N706 4 for \$1.00
- 2N2222A 3 for \$1.00
- PN2222A 4 for \$1.00
- 2N2904 3 for \$1.00
- 2N2904 3 for \$1.00
- 2N2905 3 for \$1.00
- MJ2955 \$1.50
- 2N3055 \$1.00
- PMD 10K40 \$1.00
- TIP 121 75¢
- TIP 125 75¢

***SPECIAL PRICE* TRANSISTOR**

PN3569 TO-92 N.P.N.
plastic transistor
100 for \$8.00
1000 for \$60.00
LARGE QUANTITIES AVAILABLE

TRANSFORMERS

- 120 volt primaries
- 5.6 volts @ 750 ma. \$3.00
- 6 volts @ 150 ma. \$1.25
- 12 v.c.t. @ 200 ma. \$2.00
- 18 volts @ 650 ma. \$3.50
- 18 volts @ 1 amp \$4.50
- 24 v.c.t. @ 200 ma. \$2.50
- 24 v.c.t. @ 400 ma. \$3.00
- 28 v.c.t. @ 15 amps \$20.00
- 30 v.c.t. @ 2 amps \$5.00

WALL TRANSFORMERS

- all plug directly into 120 vac outlet
- 4 VDC @ 70 ma. \$2.00
- 6 VAC @ 500 ma. \$3.50
- 6 VDC @ 750 ma. \$6.50
- 9 VDC @ 500 ma. \$5.00
- 12.5 VAC @ 265 ma. \$3.00
- 24 VAC @ 250 ma. \$3.00
- MULTI-VOLTAGE @ 500 ma. \$3.00
- 3.4 1/2, 6.7 1/2, 9 or 12 VDC \$7.50

MINI-BOX

Pomona #2104
\$1.00 EACH

Heavy-duty black phenolic project box with cover and screws. 2 1/4" X 1 1/2" X 1 1/2"

FUSES

- 3AG (AGC) SIZE
1, 1 1/2, 2, 2 1/2, 3, 4, 5, 6 AMP
- GMA SIZE
1, 2, 3, 4, 5 AMP
- 5 of any ONE amperage 75¢

SOUND AND VIDEO MODULATOR FOR T.I. COMPUTER



T.I. # UM1381-1. Designed for use with T.I. computers. Can be used with video sources. Built-in A/B switch. Channel 3 or 4 selection switch. Operate on 12 vdc. Hook-up diagram included.
\$10.00 EACH

SLIM LINE COOLING FAN



Etri # 99XM182 low noise fan. Measures 3 3/4" square x 1" deep. 21 cfm. 23 db. 1700 rpm
SPECIAL PRICE . . . \$12.50 each

2K 10 TURN MULTI-TURN POT SPECTROL #MOD 534-7161 \$5.00 EACH

SOLID STATE BUZZER



Star #SMB-06L
6 vdc
TTL compatible
\$1.00 each
10 for \$9.00

± 12 Vdc or 24Vdc POWER SUPPLY

DELTRON MODEL GD12/15-1.7
Dual plus and minus 12Vdc open frame power supply. Can be used as 24Vdc @ 1.5 amp. INPUT: either 115 Vac or 230 Vac
Fully regulated computer grade supply.
7" x 4 1/4" x 2 1/4"
\$12.50 each 10 for \$110.00

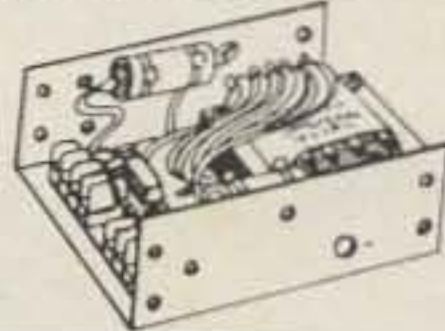

SPECIALS OF THE MONTH

ALL 1/4 WATT RESISTORS
1000 pcs of one value \$7.50

ALL 1/2 WATT RESISTORS
1000 pcs of one value \$9.50

1 AMP 50 VOLT DIODES
IN4001 TAPE AND REEL
100 for \$4.50
1000 for \$30.00

D STYLE CONNECTORS
DB25 PLUS 10 for \$11.00
100 for \$100.00

DB25 SOCKET 10 for \$12.50
100 for \$110.00

SOLDER TAIL I.C. SOCKETS
24 PIN 10 for \$2.50
100 for \$22.00
1000 for \$200.00

8" P.A. SPEAKER

C.T.S. Model 8B3079 \$5.00 each
8 ohms coil
3.0 oz. ferrite magnet
Typical response range: 100 - 10,000 hz.
Power rating 15 watts max.
Drilled to mount line matching transformers

CASE OF 8 SPEAKERS \$32.00

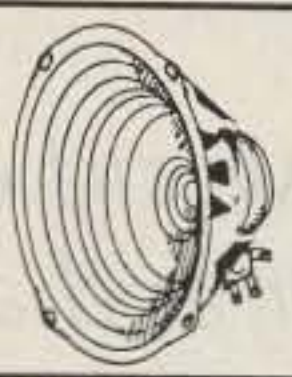

LINE CORDS

- TWO WIRE**
6' 18/2 SPT-1 flat 3 for \$1.00
- 6' 18/2 SPT-2 flat
- 6' 16/2 SJT round \$1.25 each
- THREE WIRE**
6' 18/3 flat \$1.50 each
- 8' 18/3 round \$2.00 each
- 8' 16/3 round \$4.00 each

RELAYS

10 AMP SOLID STATE
CONTROL: 3 - 32 vdc
LOAD: 140 vac 10 amp
SIZE: 2 1/2" x 1 1/4" x 1 1/4"
\$9.50 EACH 10 FOR \$90.00

ULTRA-MINIATURE 5 VDC RELAY
Fujitsu # FBR211NED005M20
High sensitivity
COIL: 120 ohms
CONTACTS: 1 amp
Mounts in 14 pin DIP socket
\$1.25 each 10 for \$10.00

MINIATURE 6 VDC RELAY
Aromat #RSD-6V
Super Small S.P.D.T. relay
GOLD cobalt contacts rated
1 amp @ 30 vdc. Highly sensitive, TTL direct drive possible. 120 ohm coil.
Operate from 4.3 - 6 vdc.
COIL: 120 ohms \$1.50 each
1 1/16" x 1 1/32" x 7/16" 10 for \$13.50

13 VDC RELAY
CONTACTS: S.P.N.C.
10 amp @ 120 vac
Energize coil to open contact
COIL: 13 vdc 650 ohms
SPECIAL PRICE \$1.00 each

4PDT RELAY
14 pin KH style
3 amp contacts
USED but fully tested \$1.70 each
Specify coil voltage desired
Either 24 vdc or 120 vac
LARGE QUANTITIES AVAILABLE
SOCKETS FOR KH RELAY 75¢ each

RECHARGEABLE NI-CAD BATTERIES

- AAA SIZE 1.25V 500MAH \$1.85
- AA SIZE 1.25V 500MAH \$1.85
- AA with solder tab \$2.00
- C SIZE 1.2V 1200MAH \$3.50
- D SIZE 1.2V 1200MAH \$3.50

UNIVERSAL CHARGER

Will charge 4-AA, C, D, or AAA ni-cads or one 9 volt ni-cad at one time.
\$11.00 per charger

***SPECIAL PRICE* DUAL L.E.D. DISPLAYS**

560 high, 7 segment L.E.D. read-outs. Mount in 24 pin DIP sockets
MAN-6640 orange, c.c. 75¢ each
FND-5148 red, c.c. 75¢ each
DL-527 red, c.a. 75¢ each

3 1/2" SPEAKER
8 ohm impedance. Full range speaker. 8 oz magnet. 4" diagonal mounting centers.
\$2.50 each 10 for \$20.00

SPRING LEVER TERMINALS
Two color coded terminals on a sturdy 2 1/4" x 3 1/4" bakelite plate. Great for speaker enclosures or power supplies.
75¢ EACH 10 for \$6.00

CASSETTE MECHANISM

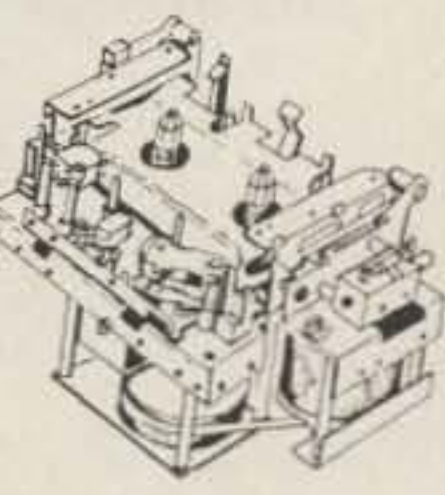

New, stereo cassette mechanism includes record/playback and erase heads. 2-12VDC motors, drive belts, pulleys, 3-12VDC solenoids, pinch wheels and other mechanical parts. These parts, used on other current model decks, would cost several times our selling price if purchased separately. Build your own audio or data recorder or use for spare parts. 5 1/4" X 3 1/2" X 3 1/4"
\$7.50 EACH 2 FOR \$12.50

MINIATURE TOGGLE SWITCHES
ALL ARE RATED 5 AMPS @ 125 VAC

- S.P.D.T. (on-on)**
PC style non-threaded bushing. 75¢ each 10 for \$7.00
- S.P.D.T. (on-on)**
Solder lug terminals. \$1.00 each 10 for \$9.00 100 for \$80.00
- S.P.D.T. (on-off-on)**
Solder lug terminals. \$1.00 each 10 for \$9.00 100 for \$80.00
- S.P.D.T. (on-off-on)**
PC style non-threaded bushing. 75¢ each 10 for \$7.00
- S.P.D.T. (on-on)**
PC lugs threaded bushing. \$1.00 each 10 for \$9.00 100 for \$80.00
- D.P.D.T. (on-on)**
Solder lug terminals. \$2.00 each 10 for \$19.00 100 for \$180.00

STANDARD JUMBO DIFFUSED T 1 1/2

- RED 10 for \$1.50 100 for \$13.00
- GREEN 10 for \$2.00 100 for \$17.00
- YELLOW 10 for \$2.00 100 for \$17.00

FLASHER LED

5 volt operation red jumbo T 1 1/2 size \$1.00 each

BI-POLAR jumbo T 1 1/2 size 2 for \$1.70

LED HOLDERS
Two piece holder for jumbo LED 10 for 65¢ 100 for \$5.00

CLEAR CLIPLITE LED HOLDER
Make LED a fancy indicator. Clear. 4 for \$1.00

D.P.S.T. LIGHTED ROCKER SWITCH

115 vac lighted rocker snap mounts in 1 1/2" x 1 1/2" hole. Orange lens. 16 amp contact. \$1.50

MINI-PUSH BUTTON

S.P.S.T. momentary normally open 1/8" bushing. Red button. 35¢ each 10 for \$3.00

SNAP ACTION SWITCH

Cherry elect. #E-21 N.O. or N.C. 0.1A contacts. Suitable for alarms and other low energy circuits. 1 1/8" lever.
45¢ EACH 10 FOR \$4.20

ROTARY ACTION MICRO

OMRON #C-5G3-C41
Clockwise action micro used in coin operated mechanisms and low torque operations.
RATED: 5 amps @ 125 Vac.
\$1.25 each 10 for \$11.00
LARGE QUANTITIES AVAILABLE.

TI SWITCHING POWER SUPPLY

Compact, well-regulated switching power supply designed to power Texas Instruments computer equipment.
INPUT: 14 - 25 vac @ 1 amp
OUTPUT: + 12 vdc @ 350 ma.
- 5 vdc @ 1.2 amp
- 5 vdc @ 200 ma
SIZE: 4 1/4" x 4 1/4" x 1 1/4" high \$5.00 each

13.8 VDC REGULATED POWER SUPPLY

These are solid state, fully regulated 13.8 vdc power supplies. Both feature 100% solid state construction, fuse protection, and L.E.D. power indicator. U.L. listed.
2 amp constant, 4 amp surge \$18.00 each
3 amp constant, 5 amp surge \$25.00 each

D.C. CONVERTER

Designed to provide a steady 5 vdc @ 240 ma. from a battery supply of 3.5 to 6.25 volts.
2 1/16" x 1 1/16" x 1 1/16"
\$1.50 each

7 CONDUCTOR RIBBON CABLE

Spectra-strip red marker strip. 28 ga. stranded wire.
\$5.00 per 100' roll

ALL ELECTRONICS CORP.
LOS ANGELES, CA STORE
905 S. Vermont Ave.
213 380-8000

VAN NUYS, CA STORE
6228 Sepulveda Blvd.
818 997-1806

MAIL ORDERS TO:
P.O. BOX 20406
Los Angeles, CA 90006

TWX - 5101010163 ALL ELECTRONIC
EASYLINK MBX - 62887748

TOLL FREE ORDERS ONLY
1-800-826-5432
(ORDER ONLY)
(IN CALIFORNIA: 1-800-258-6666)
ALASKA, HAWAII, OR INFORMATION
(213) 380-8000 NO C.O.D.!

QUANTITIES LIMITED
MINIMUM ORDER \$10.00
USA: \$3.00 SHIPPING
FOREIGN ORDERS:
INCLUDING SUFFICIENT SHIPPING
CALIF. RES. ADD 6 1/2%



Little or No Resistance

Explore the strange world of superconduction, where current flows forever and a picosecond is an eternity.

A new electronic technology is emerging in many laboratories around the world. This new technology, superconducting electronics, is as different from semiconductors as the now vanishing technology of vacuum tubes. Superconducting electronics is made possible by a number of unusual conditions that may occur in electronic circuits when they are

cooled to extremely low temperatures.

A number of metals and alloys lose all resistance to electric currents at temperatures a few degrees above absolute zero (-273°C). In a superconducting circuit, a current can be maintained almost indefinitely once started. Alternating currents may still experience some impedance at superconducting tempera-

tures, but these impedances are very low compared to those that are encountered in conventional circuits.

Not only temperature, but magnetic fields and current density also determine a material's ability to become superconducting. As current densities increase, a material becomes more susceptible to the squelching of superconductivity which can be caused by a magnetic field. Increasing current densities and magnetic-field strength also reduces the temperature at which a certain material will become superconducting.

An extremely small particle may appear to have passed through a barrier without punching a hole in it. This phenomenon is called tunneling. For the electron, tunneling is possible provided that the barrier is less than a few hundred atomic diameters wide. A thin film of isolating material between two films of conducting material is a tunnel junction. At room temperatures, a tunnel junction

may show a resistance of several hundred Ohms.

In 1962, an English scientist, Brian Josephson, predicted the behavior of a tunnel junction at extremely low temperatures. He believed that at superconducting temperatures, the tunnel junction itself would become superconducting. In this condition, no resistance or voltage could be measured across the junction. Brian Josephson predicted that a small magnetic field could turn the superconducting tunnel junction back to its resistive state. He also predicted that the superconducting tunnel junction would return to its resistive state if the current rose above a certain value, which he called the critical current.

The superconducting tunnel junction could thus be switched back and forth between its superconducting and resistive states by controlling the current through a small loop of conducting material near the tunnel junction. This control current would cause a magnetic field ex-

Photos courtesy of IBM

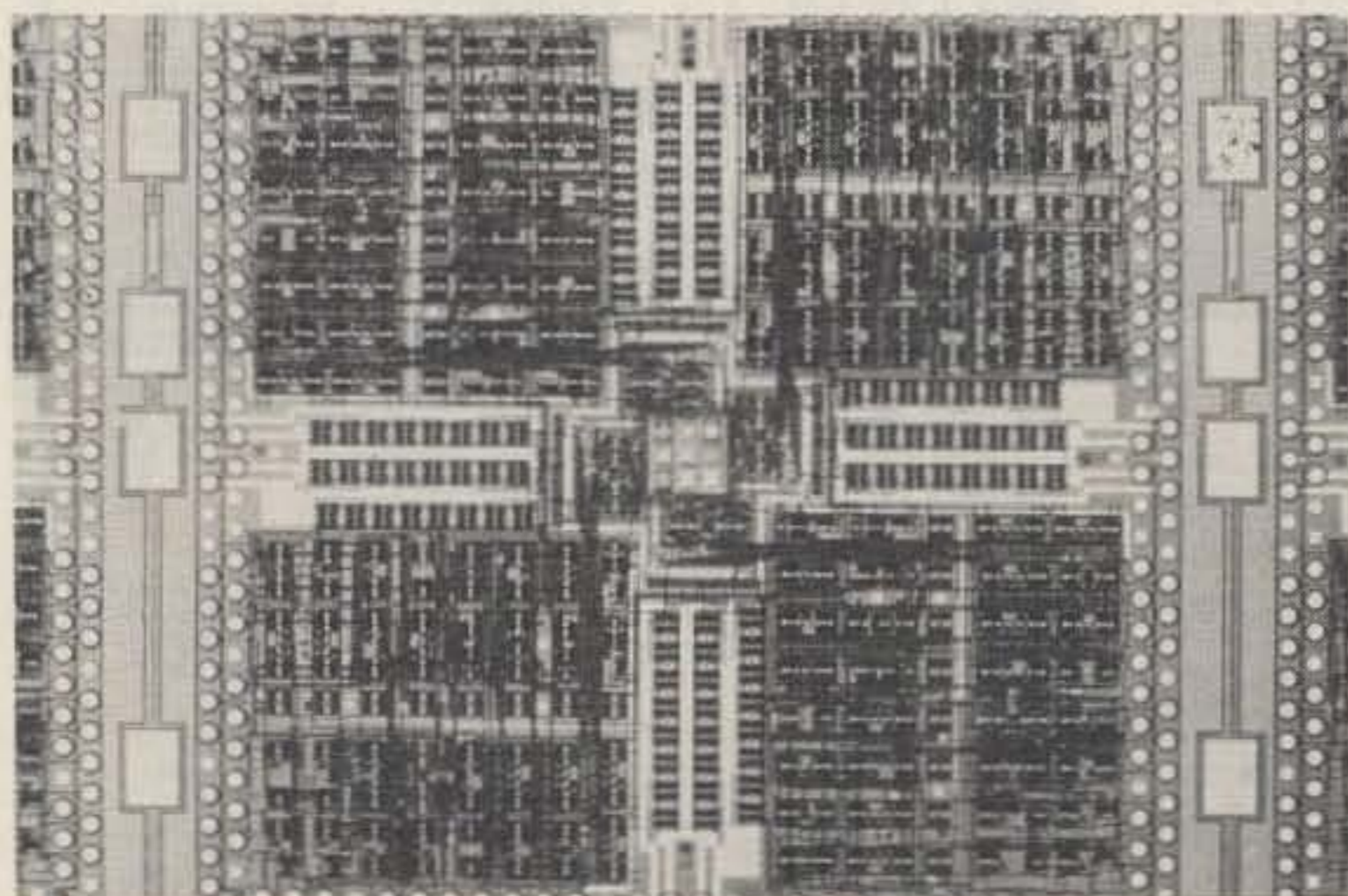

Photo A. An experimental Josephson circuit chip, made at IBM's Thomas J. Watson Research Center in Yorktown Heights NY. The chip contains 300 Josephson-Junction logic circuits and their power supplies. The overall power dissipation of this chip is only a few milliwatts.

ceeding the value which the superconducting junction would tolerate whenever the junction was to return to its resistive state. This new electronic device was soon observed in the laboratory and was named the Josephson Junction, after its discoverer. In 1973, Brian Josephson, together with two other pioneers in superconducting electronics, Leo Isaki and Ivar Giaever, received a Nobel prize in physics.

The Josephson Junction has several remarkable properties which make it an attractive component in super-fast computers. A Josephson Junction can switch its state faster than any other electronic component. The fastest Josephson Junctions have been observed to have switching speeds around 10 picoseconds. This corresponds to a frequency of 100 gigahertz.

Very fast computers must also be very compact in order to reduce the time which is required for a signal to move from one part of the computer to another. Each component in a super fast computer develops heat that must be dissipated. There are limitations to the amount of heat that can be dissipated from a small space, so a super fast computer with too many components in a small space could literally melt itself. The power consumption of a Josephson Junction is only about one thousandth of that of comparable semiconductor devices. The amount of heat which would have to be dissipated from a super fast computer using Josephson Junctions is, therefore, much easier to manage than the heat from a comparable semiconductor computer. The extremely low impedance which is encountered in superconducting wires and transmission lines is also making

this technology attractive for super fast computers.

The Josephson Junction can be used as a voltage-controlled oscillator. If a voltage is established across a Josephson Junction, an alternating current will appear. The frequency of this alternating current is voltage dependent. The maximum frequency of such oscillators is far into the microwave region. This effect will also work in reverse. If an alternating current is coupled across a Josephson Junction, a voltage will appear that is proportional to the frequency of the alternating current. The output of a Josephson-Junction vco is of very low amplitude and would need a great deal of amplification before it could be used in most analog applications.

The Josephson Junction is more sensitive to magnetic fields than any other device. This led to the first commercial application of the technology. Magnetometers using these junctions have been on the market for several years.

A Josephson Junction is a latching device. Once it has changed state, it will remain in that state until the current through the junction is interrupted. But in contrast to semiconductors, Josephson Junctions work equally well with currents of either polarity. By using an alternating current as power supply, the latching effect can be cancelled. Each time the ac crosses zero, the Josephson Junction returns to its original state. In a computer circuit using Josephson-Junction technology, the alternating current which supplies the power to the junctions can also serve as the clock of the computer.

A new superconducting electronic device was presented by its inventor, Dr. Sadeg M. Faris of IBM, in

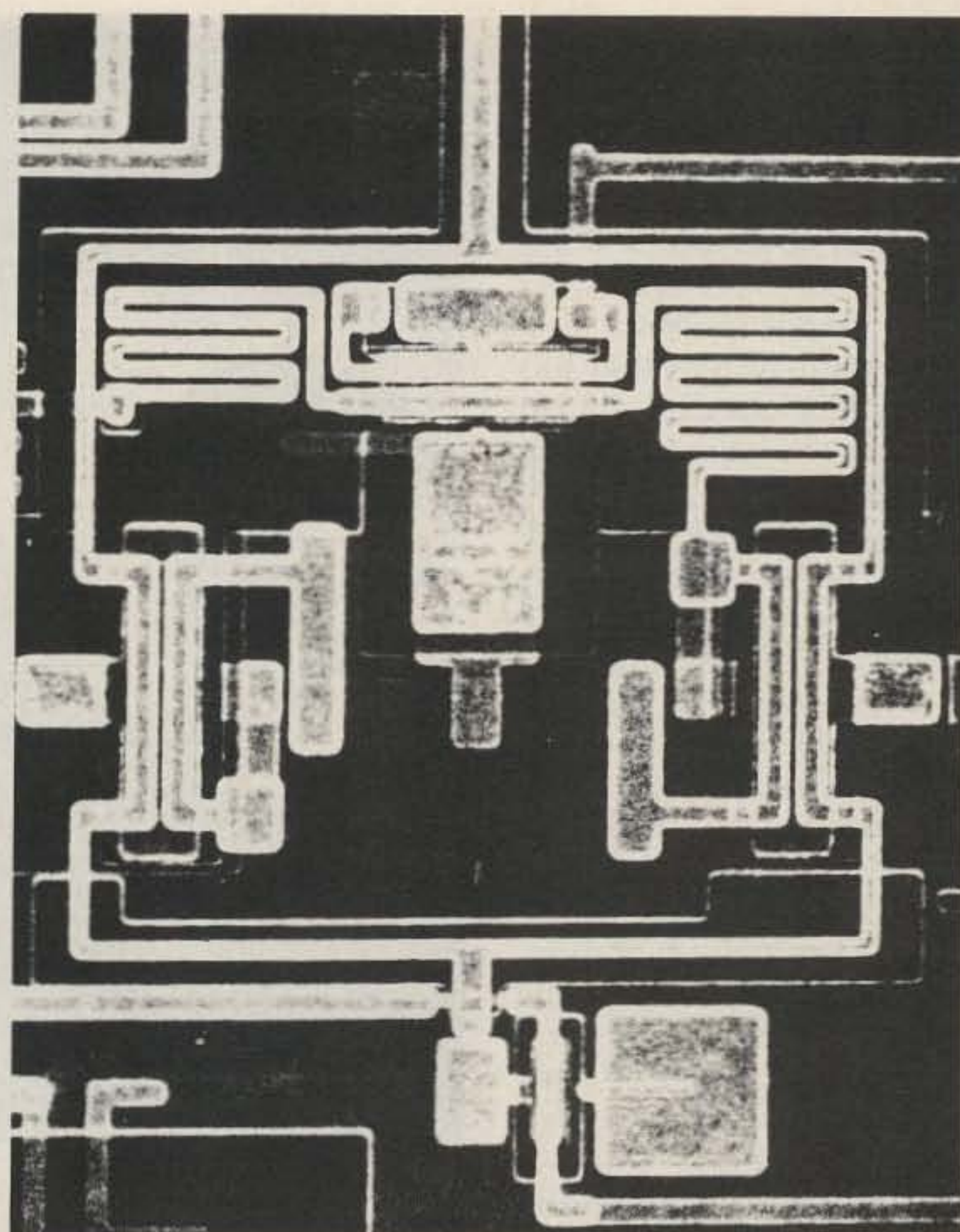

Photo B. This Josephson circuit is used in an oscilloscope system which is capable of measuring extremely fast signals. The Josephson Junction is the small circle in the center.

January of 1983. This device, which is similar to the transistor in semiconductor technology, is called a quiteron. The quiteron uses two tunnel junctions and consists of three thin films of conducting material which are separated by two even thinner barriers of insulating material. A small change in the current between two of the conducting films will result in a large change in the output voltage from the quiteron circuit. So far, quiteron amplifiers have shown a power gain of only 10, but the gain figure is expected to improve as these circuits become more refined. The quiteron is very fast, like the Josephson Junction, and is capable of processing signals into the gigahertz range. The power dissipation of a quiteron is very small compared with semiconductor amplifiers.

Superconducting technology is found also in circuits that have to pass very large currents. The strongest man-made magnets use superconducting coils. Extremely high current densities are possible in such coils (10^6 Amperes per square centimeter). The strongest superconducting magnets are capable of producing magnetic fields in excess of 8 Teslas, whereas the strongest conventional electromagnets are able to deliver only .3 Teslas.

Superconducting magnets are found in most laboratories that are attempting to develop fusion power. In order to generate power by fusing hydrogen atoms into heavier atoms, extremely high temperatures have to be attained. All solid walls would evaporate long before such temperatures could be

reached. But superconducting magnets may be able to generate magnetic fields that are so strong that these can act as substitutes for solid walls in fusion-power experiments.

An experimental levitated train system that has been developed in Japan uses superconducting magnets to lift the train. The train is, therefore, suspended in the air a few inches above the track. Due to the absence of mechanical friction, speeds of 320 mph have been reached in this levitated train system.

In the future, superconducting coils may be used for storage of electrical energy. Extremely high current densities are possible in such a storage system, and this may make it competitive with other power-storage systems. Once a current has been started in a superconducting storage coil, this can be sustained with very little loss for several days.

Modern electrical generators can be very efficient; up to 98 percent of the mechanical energy may be converted to electricity. But even higher efficiencies are possible by using superconducting magnets in the generators. Such generators may reach efficiencies of 99.5 percent. For large electrical generators, these savings may cause superconducting magnets to be competitive

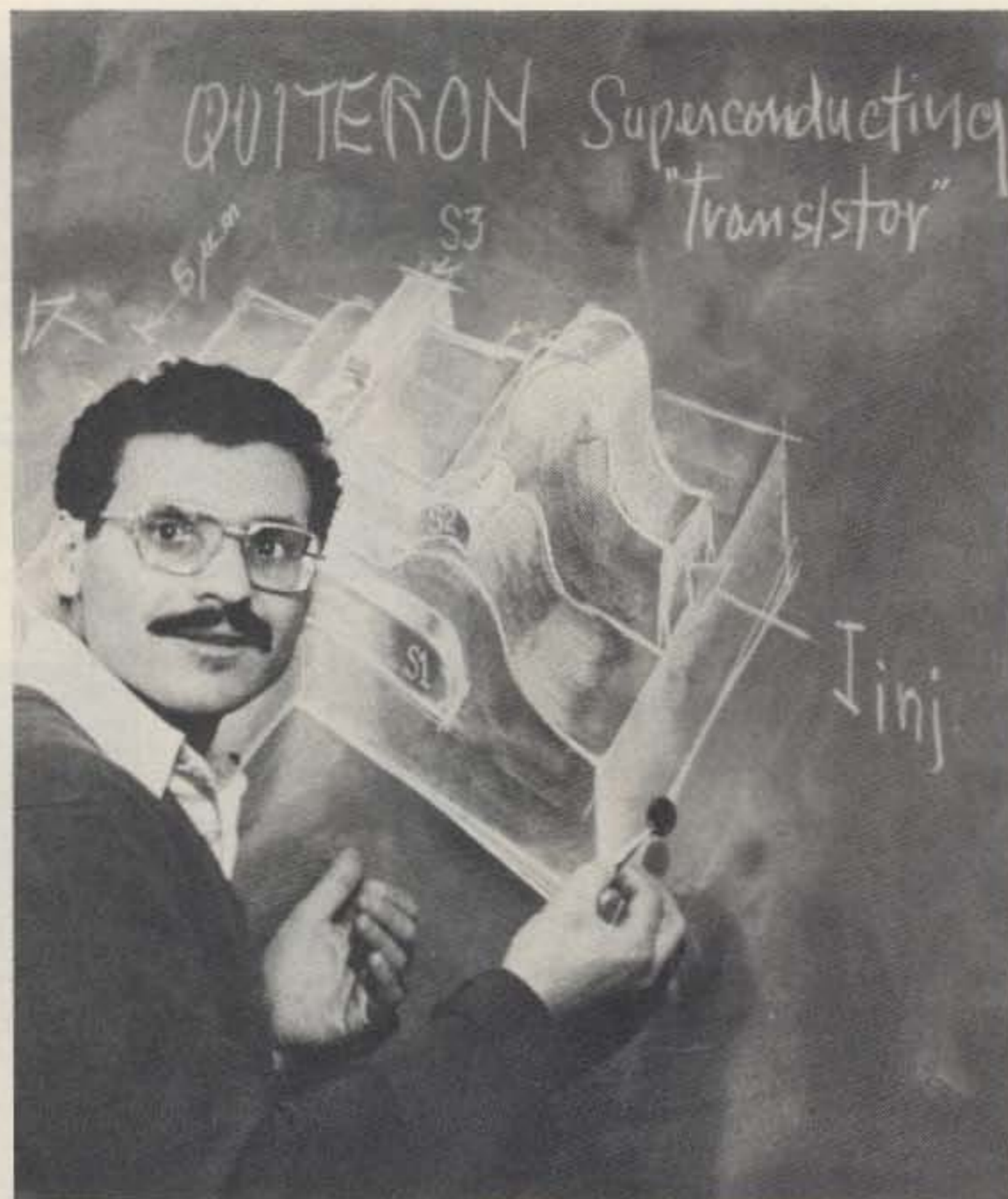

Photo C. The inventor of the quiteron, Sadeg M. Faris, and his new electronic device. The quiteron is a superconducting equivalent to the transistor, but works according to entirely different principles.

with conventional magnets, despite the higher construction costs. Superconducting magnets may also become cost-effective in large electrical motors.

The main obstacle to a wide use of superconducting circuits is obviously the need to keep these circuits cooled to superconducting temperatures. Most refrigeration systems use liquid helium, which maintains the superconductors at a

temperature of 4.2° Kelvin, the boiling point of helium. Helium is fairly expensive, and these refrigeration systems are not yet very reliable.

Many scientists believe that new superconducting materials will be developed which can become superconducting at higher temperatures than existing materials. A major milestone would be reached if one could discover a mate-

rial which would turn into a superconductor at a temperature of 25° Kelvin or higher. This temperature is the boiling point of liquid hydrogen, and hydrogen-based refrigerators are likely to be much less expensive and more reliable than those that use helium as a refrigerant. The highest superconducting temperature which has yet been achieved is found in a niobium-germanium alloy. This alloy becomes superconducting at 23° Kelvin.

The Josephson Junction may be used as a very sensitive detector at microwave frequencies. Cooled parametric amplifiers have been used for EME work. Some years from now, superconducting components and refrigerators may become available from surplus stores and other sources. It is then possible that some new uses for superconducting electronics will be found in amateur-radio stations. ■

References

- Roger Davidheiser, "Analog Use of Superconducting Microelectronics Nears," *Microwave System News*, October, 1982.
- Herb Brody, "Superconductors: Finally Ready for Business?," *High Technology*, February, 1983.
- Juri Matisoo, "The Superconducting Computer," *Scientific American*, May, 1980.
- R. T. Miller, "Josephson Power Supply Patented," *IBM Research Highlights*, July, 1978.

PACKET RADIO	PAC/NET SYSTEM
	PAC/NET SYSTEM \$240.00 System Tested 4.5 x 6" board complete with all ICs and programmed EPROMs personalized for each purchaser. Requires only single 8-10 volt 1/2 amp power. 1 year guarantee of hardware/software/AX.25 standard RS232 serial ASCII at any user baud rate. RS232 HDLC for 202 modem used for AFSK or direct to RF equipment for FSK.
ASCII—USA/AX.25 HDLC CONVERTER USA/AX.25 is the AMRAD approved digital format STANDARD used on amateur packet radio networks.	Custom Systems Custom Programming BILL ASHBY AND SON K2TKN—KA2OEG 201-658-3087 BOX 332 PLUCKEMIN N.J. 07978
PAC/NET board only \$80.00 Assembled/Tested. No ICs. 90day warranty	
Package of all ICs except 2-2716 EPROMs \$80.00	

INTRODUCING SACCK
(for the C-64)
Semi-Automatic CW Contest Keyboard
(WITH INTERFACE)

SACCK is a POWERFUL semi-automatic CW keyboard with its own INTERFACE.

SACCK comes with many AUTOMATIC features that makes CW contesting and rag chewing both easy and fun.

A few of the many OUTSTANDING features are:
 10 MESSAGE BUFFER • DUPE CHECKING WITH PROPER MESSAGE PLACED IN THE XMIT BUFFER AUTOMATICALLY • AUTOMATIC TEXT INSERTION • ON LINE CODE SPEED CHANGE • CHAR., WORD, LINE AND MESSAGE XMIT OPTIONS AND MUCH MUCH MORE!

ATTENTION C-128 OWNERS!

ALL OF CRUMTRONIC'S POWERFUL HAM SOFTWARE WILL SOON BE AVAILABLE FOR THE C-128 IN THE C-128 MODE.

FOR FREE FACT SHEETS WRITE:

CRUMTRONICS
SOFTWARE DIVISION
 P.O. BOX 8187
 FORT WAYNE, IN 46896

COD ORDERS CALL: 219/745-0350 OR 219/485-2718
 CRUMTRONICS is our name, logging is our game.



WANTED: OLD THINKER TOYS.

CW Communications, ComputerLand and The Computer Museum invite you to send in your early personal computers, software, and memorabilia — you could win a free trip to The Computer Museum in Boston

Your old, dusty "thinker toy" may now be ready to become a treasured museum piece. The Computer Museum in downtown Boston — an international museum dedicated entirely to computing — is searching for the very best and most unique relics of the personal computer revolution.

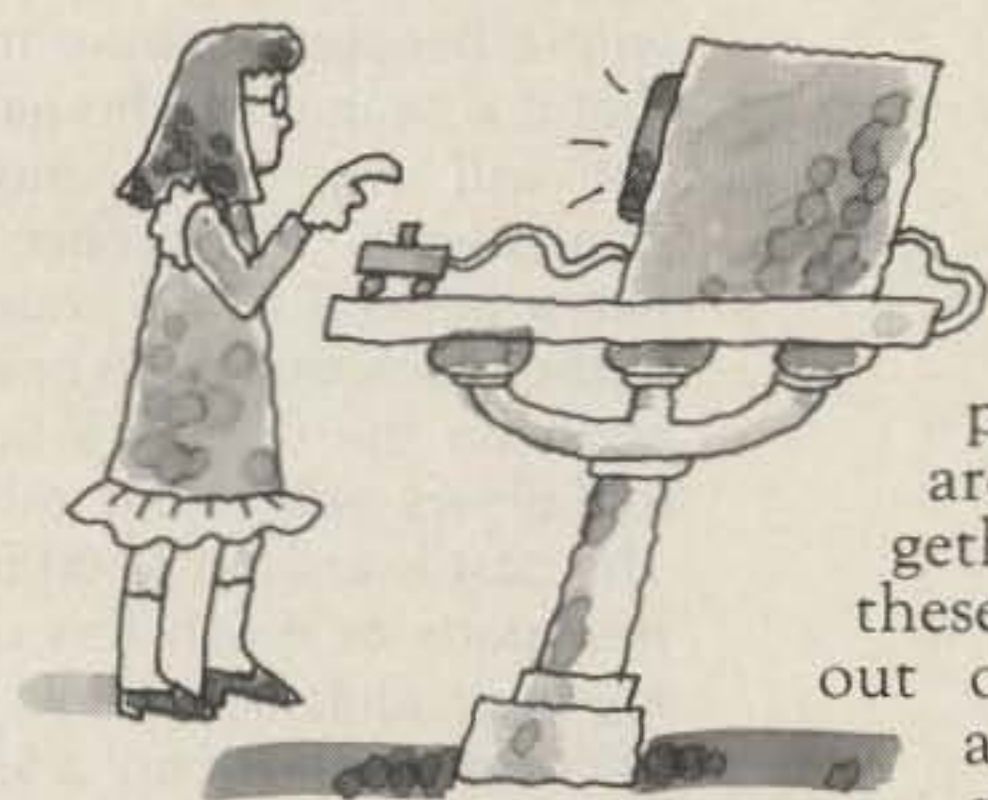

ComputerLand, CW Communications, and The Computer Museum are working together to bring these early relics out of your attic and into the collection of

The Computer Museum. The museum is especially looking for kit machines, prototypes, programs, output, newsletters and memorabilia of early computing from around the world. A selection of the finest items will be used to create an exhibit on the

ComputerLand

**The
Computer
Museum**

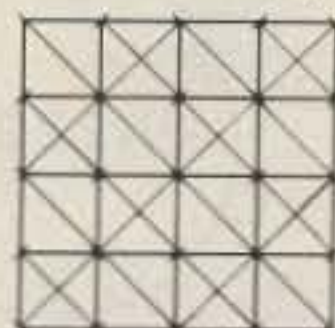

CW COMMUNICATIONS/INC.

Entries will be judged on significance, rarity, date, completeness and condition. Items particularly sought include pre-1980 machines, early serial numbers (get those number 1's out), machines made for purchase outside of North America (even modern machines are sought in this category); first releases of software such as first releases of operating systems, languages and mass-marketed and original applications; and pre-1980 photographs, newsletters, manuals and other records. The Computer Museum is a private non-profit educational institution. All donations are tax-deductible according to the provisions of the Internal Revenue Service. Thinker Toys is a registered trademark of George Murrow & Murrow Designs, Inc.

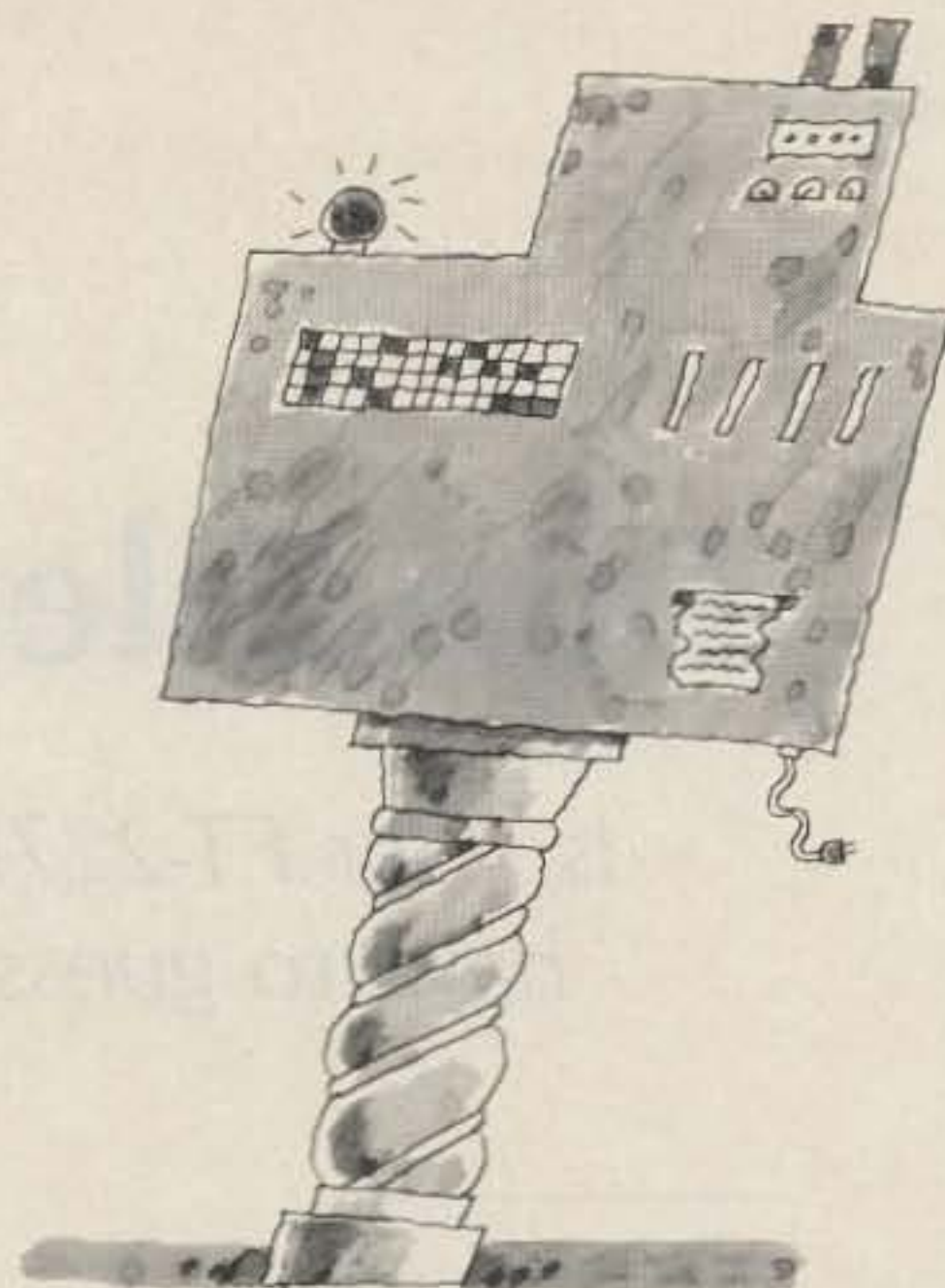

evolution of personal computers and a catalog highlighting the Museum's collections. If your submission is accepted for addition to the Museum collection, you will be invited to the grand opening of the exhibit and will receive a bound edition of the catalog. If your item is selected as one of the five best "finds", you will also receive an all-expense-paid trip to Boston for the grand opening party.

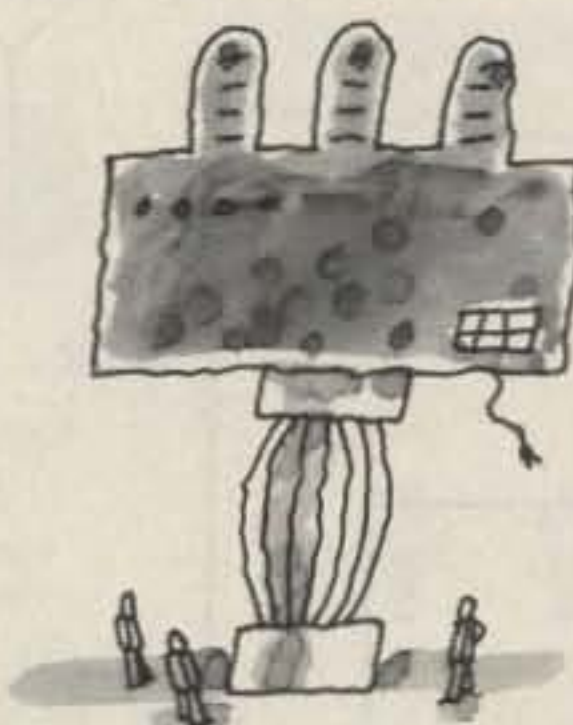
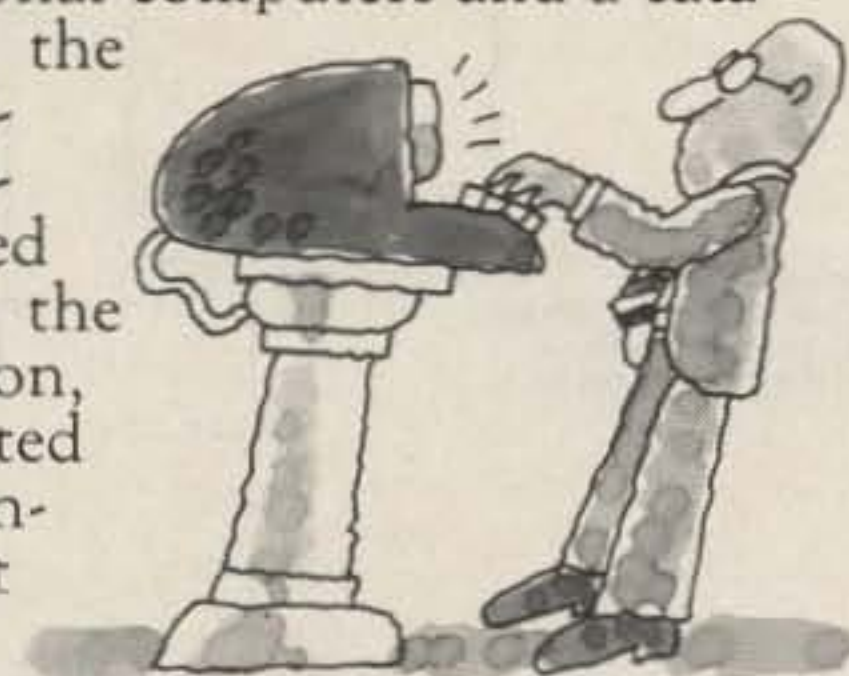

So, get up to the attic, down to the cellar and into your closets, and tell us what you find! Call or write the Museum for an official entry form, or send a photo and description of your items by March 1, 1986

to: The Computer Museum, Personal Computer Competition, 300 Congress St., Museum Wharf, Boston, Massachusetts USA 02110, (617) 426-2800, Telex: 62792318.

Run Silent, Run Beep

Is your FT-227RB scanning? You won't have to guess with this easy add-on.

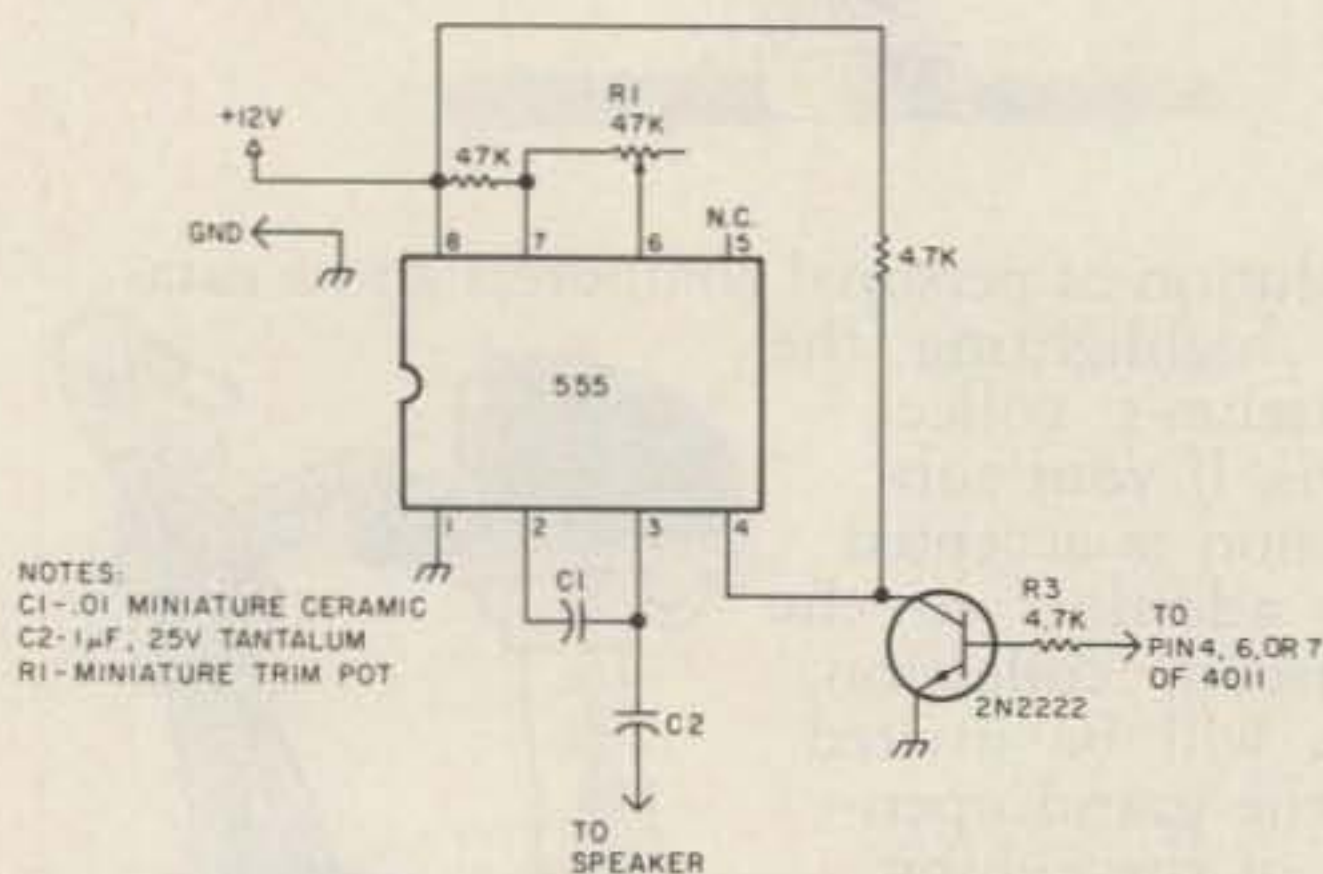

Fig. 1. Schematic.

If you are driving and are over forty (years old, not mph), you may have noticed how difficult it is to read a small digital display

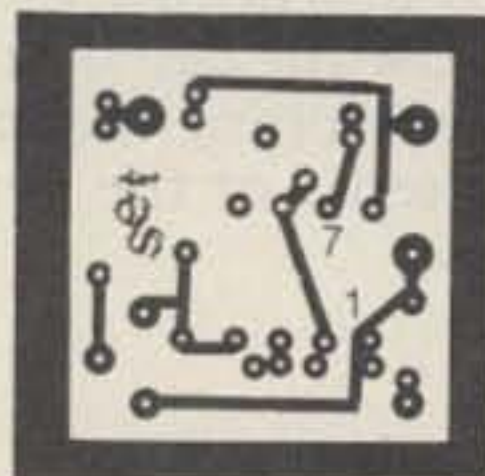

Fig. 2. PC board.

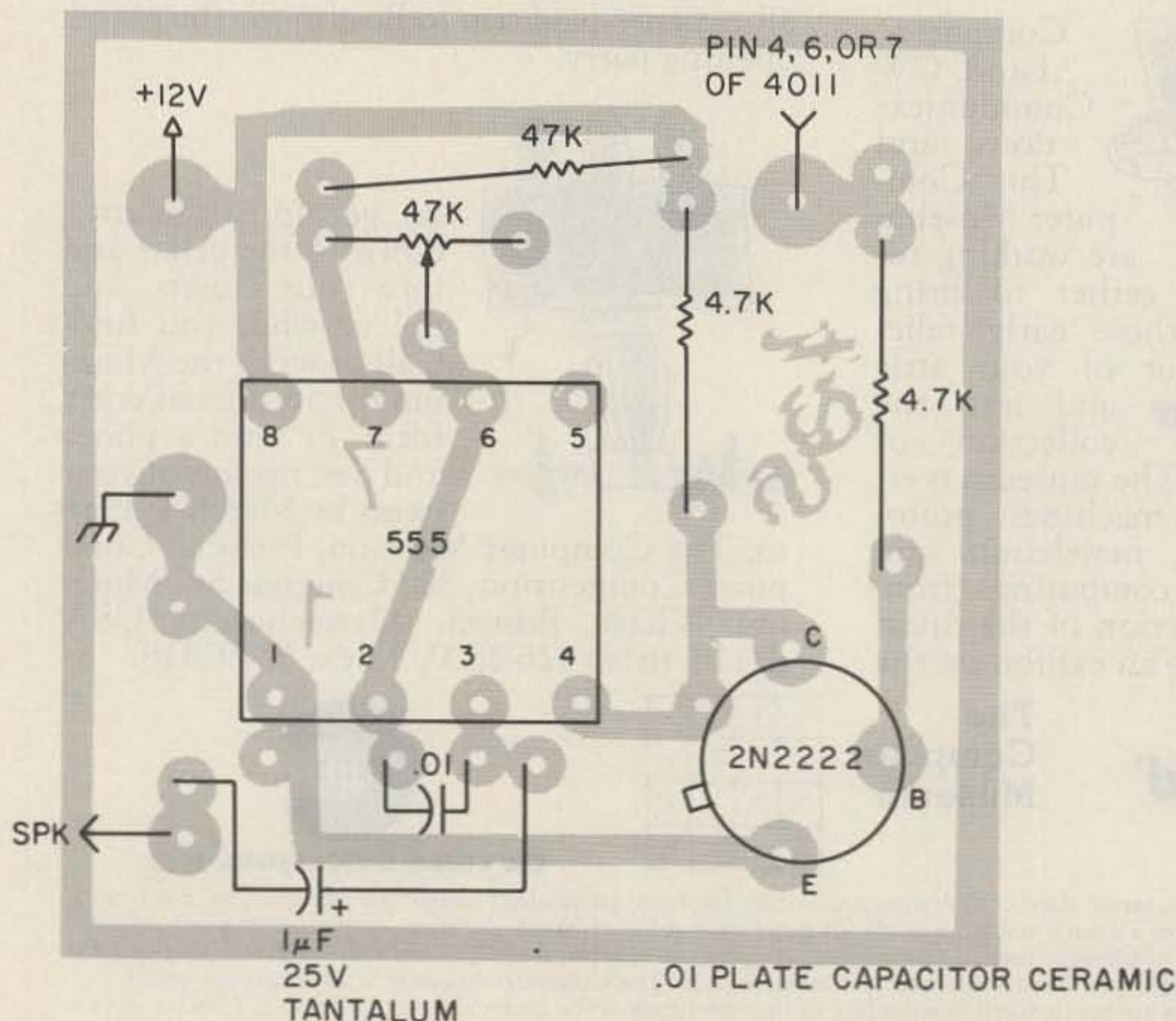

Fig. 3. Component layout.

while in motion. In most cars the dial is not in the driver's line of sight, and in my case, I get tired of asking my wife if the display is scanning. It is dangerous when I am alone and have to take my eyes from the road to see the display. Also, sometimes a short noise stops the scanning, or the mike button doesn't start as it should.

I know that the talking dial is coming, but in the meantime, for safety, I have equipped my Yaesu 227 RB with a beeper to assure me that it is scanning. This gadget will work with most transceivers. The beeper is like a birdcall or the sound of the synchronization operation on the Collins S-line (old-timers will recall this). The cost is around \$4.00 for new parts or much less using your junk box. Look at the diagram: It is only a 555 integrated-circuit oscillator and a 2N2222 transistor inverter. I installed my unit in place of the optional tone squelch. If you have the squelch, install the beeper near the speaker in the bottom part of the transceiver.

In the 227 RB do the following: Open the top cover by removing the five Phillips screws. You will note a piece of gray cardboard fastened with three screws. Remove them, lift out the cardboard, and then raise the edge of the printed circuit nearest the dial only enough to

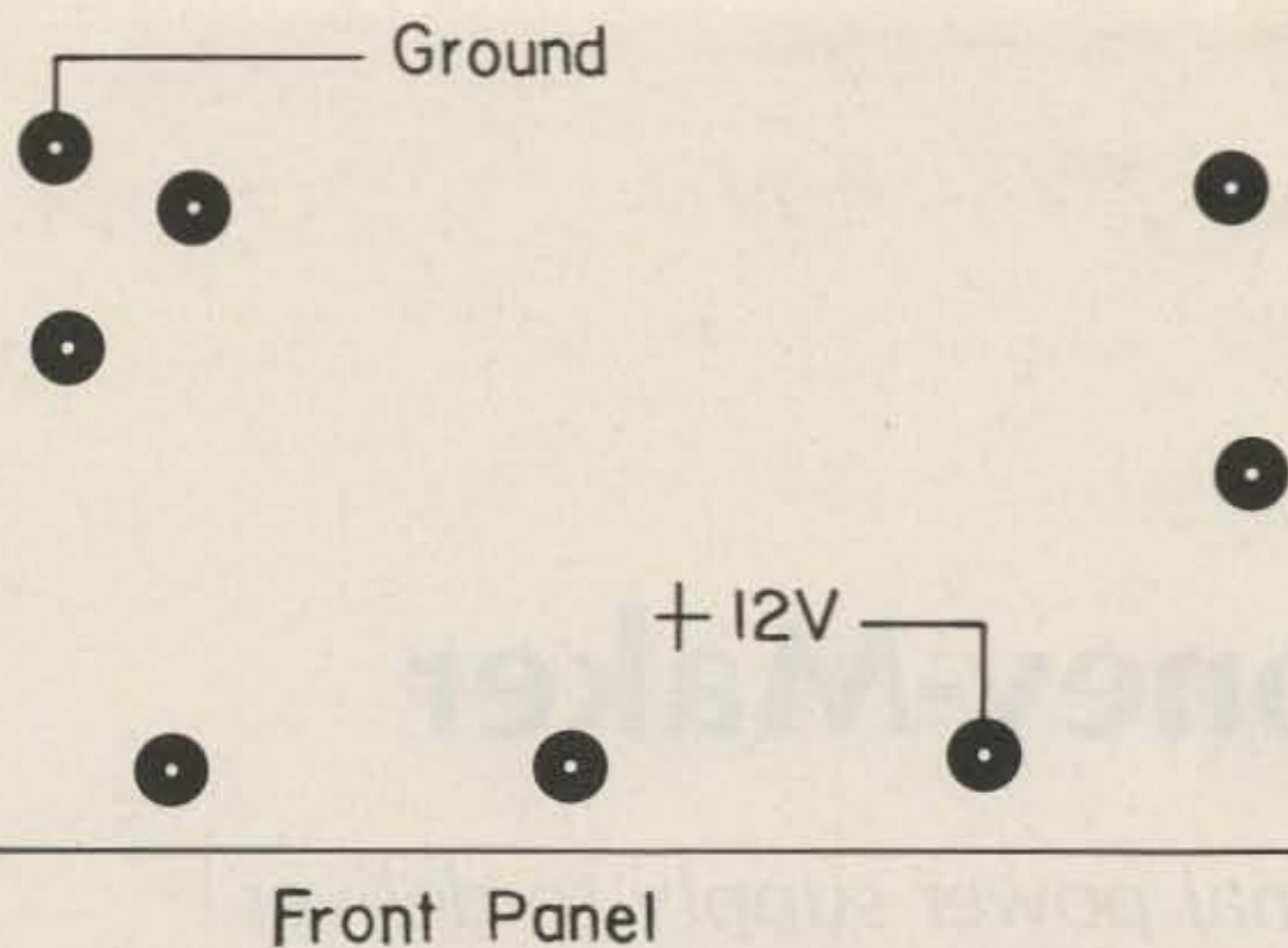

Fig. 4. Tone-squelch pin locations, seen from the dial side.

locate the MSM4011 integrated circuit. This IC is the scanning oscillator; it is in the center of the board and has 14 pins. Note that pins 4, 6, and 7 are tied together on the foil side.

At this point you should carefully solder a 4-inch piece of insulated wire if the beeper is to be located in place of the tone squelch, or a longer one to reach the speaker area if your beeper will be located there. The use of a small battery-powered or insulated iron is recommended as the IC is a CMOS.

Install the finished printed circuit by connecting the two wires (for the ground and the +12 V) to the pins indicated in the tone-squelch pin diagram (Fig. 4). The wire from the

beeper that goes to the speaker is connected at the accessory jack, pin number 1. This pin is the one with a blue wire and a small ceramic condenser to the chassis. The last one is connected from pin 4, 6, or 7 of the MSM to R3 of the beeper. Fasten the circuit to the transceiver PC board with two drops of RTV. If you are locating it near the speaker, make the same connections with longer wires, routing them around any hot transistor. When the work is finished, connect the antenna and the 12 volts and try the scanning button. You should hear a low-volume beep when scanning. With the trimpot, adjust the tone to your taste. I am sure you will find this modification very helpful. ■

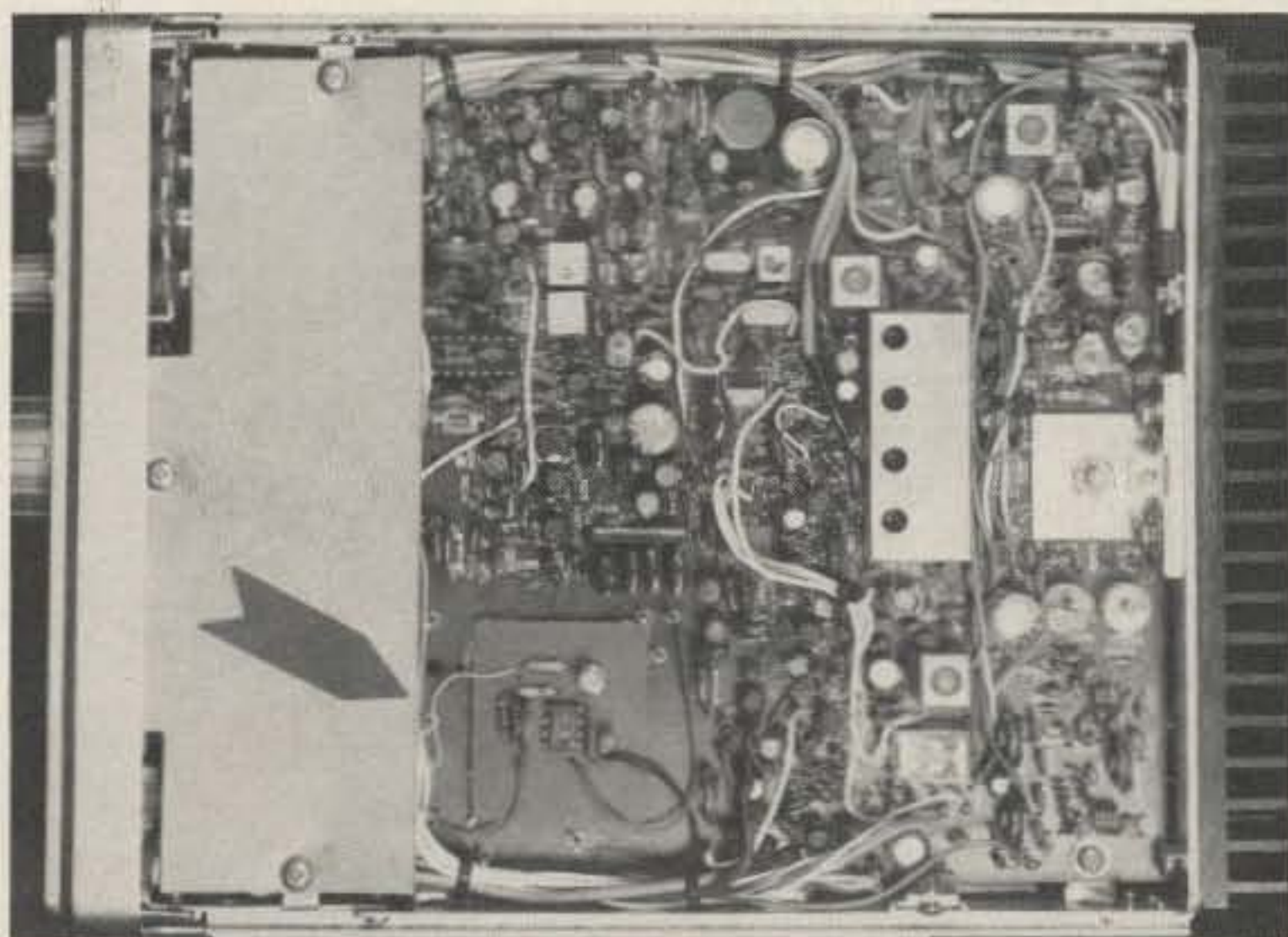

Photo A. Circuit installed in the place of the optional tone squelch on the Yaesu 227 RB.

"When You Buy, Say 73"

We Give You VHF Without VHC*

(* - Very High Cost)

Presenting Microwave Modules, the low-cost way to full-featured multi-mode operation on 50 Mhz, 144 Mhz, and 432 Mhz.

Expand your HF transceiver's capabilities for less than the cost of a VHF multimode radio.

All models feature:

- 25 Watts RF output
- Low Noise GaAsFET front end
- Transmit ALC circuit
- RF sensed VOX TR switching
- All-mode operation—SSB, CW, FM, AM
- Easy hook-up to your present HF transceiver



New MMT 144/28R GaAsFET
144 Mhz Transverter
List Price \$325.00
(Other Models Available)

AVAILABLE FROM:

THE "PX" SHACK

VHF/UHF
EQUIPMENT

Ivars Lauzums KC2PX
52 Stonewyck Drive
Belle Mead, New Jersey 08502
(201) 874-6013



Hours: 11am - 3pm
6pm - 10pm

MICROWAVE
MODULES LTD

Parts List

Resistors, all 1/8 or 1/4 Watt		(Jameco prices)
1	47k	\$.11
2	4.7k	.22
1	Trimmer pot. 47k	.39
Capacitors		
1	C1—.01 μ F miniature ceramic	.08
1	C2—1 μ F, 25 volts tantalum	.29
IC/Transistor		
1	NE555P	.35
1	2N2222	.33

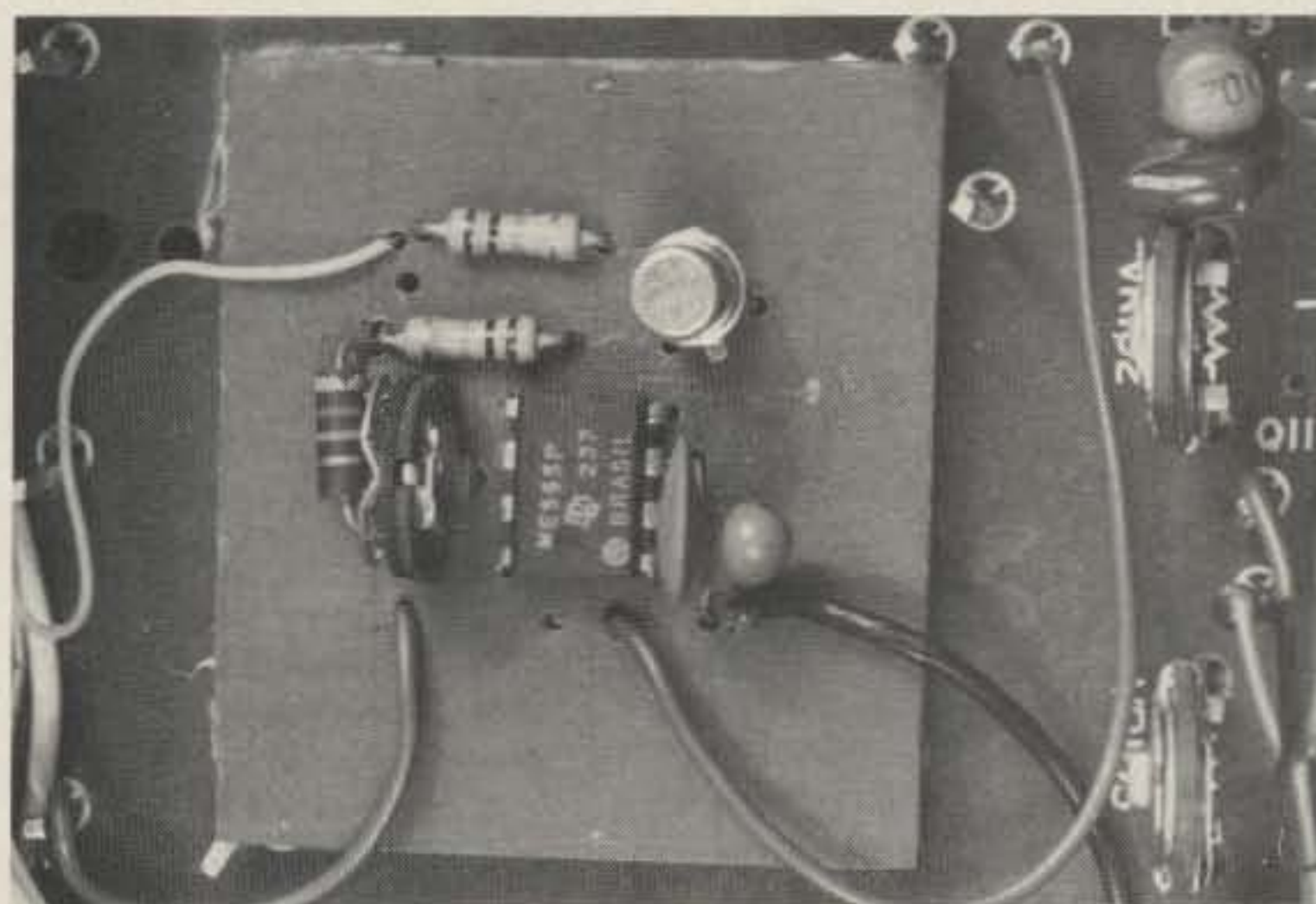

Photo B. Assembled printed circuit board.

A Better Money-Maker

WA6TTY stiffens up his original power supply to deliver a solid 13.8 volts at 20 Amps. The cost? Under three bucks!

Kenneth D. Wyatt WA6TTY
Ehrhorn Technical Operations
PO Box 888
Canon City CO 81212

This article describes a simple method of improving the output regulation of the "Money-Maker Power Supply" (73, November, 1982).

I have been using the unmodified supply for the past four years with good results. At a full load of 20 Amps, however, the output voltage drops by up to one volt. Numerous readers have noted this anomaly. W4CNQ wrote and suggested using a Fairchild 78GU1C voltage regulator instead of the LM317. Although the 78GU1C is not as widely available, it does improve the regulation re-

markably. The reason for this is its fourth "sense" lead.

The basic problem with the original power-supply circuit was the voltage drop across the base-emitter junction of the pass transistors (see Fig. 1). When biased into the active region, there is normally a base-to-emitter junction voltage of about 0.7 volts. As the collector current increases, this voltage differential also increases. For power transistors it can be as much as 1.5 volts or so.

The original circuit applies a regulated voltage from the LM317 to the pass-transistor bases. At low current levels, the base-emitter drop is fairly constant; thus the output voltage stays fixed. As the output current increases, the voltage drop

increases and causes the output to drop slightly.

The revised voltage-regulator circuit is shown in Fig. 2. The major difference is the addition of a voltage-sensing input to the regulator IC. This sense lead is connected directly to the positive output terminal of the supply. As the output voltage decreases with more load, the sense lead tells the regulator IC to boost the base voltage to the pass transistors. This feedback loop cancels out the voltage drop and the output voltage will stay nearly constant.

The 78GU1C may be purchased from Circuit Specialists, Inc., PO Box 3047, Scottsdale AZ 85257. The part costs \$2.10, and \$1.25 must be included for shipping (1983 catalog). Note that the part is mislabeled in their

1983 catalog as "78G11C". The device is housed in a TO-220 package. The pin connections are shown in Fig. 3. The 78GKC may be used as an alternate part (TO-3 case). The price is \$2.75.

Circuit Description

I used a 78GU1C as the voltage regulator. A 2N3055 was used to boost the drive

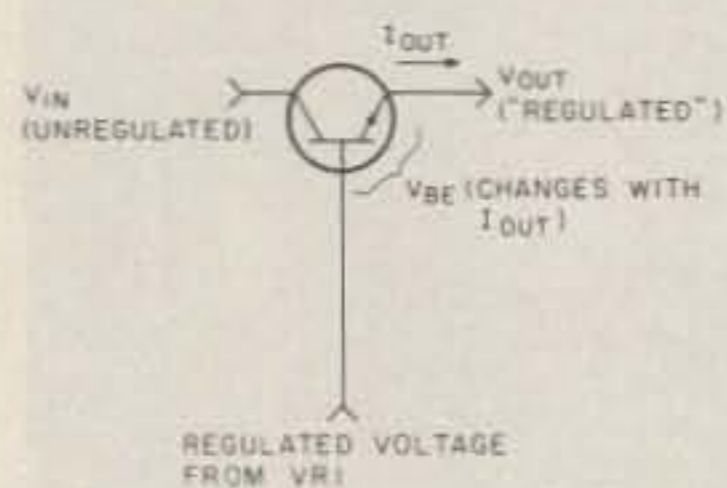

Fig. 1. Pass-transistor circuit. As the output current increases (I_{out}), the base-to-emitter voltage drop will increase (V_{be}). This will cause the output voltage (V_{out}) to decrease slightly.

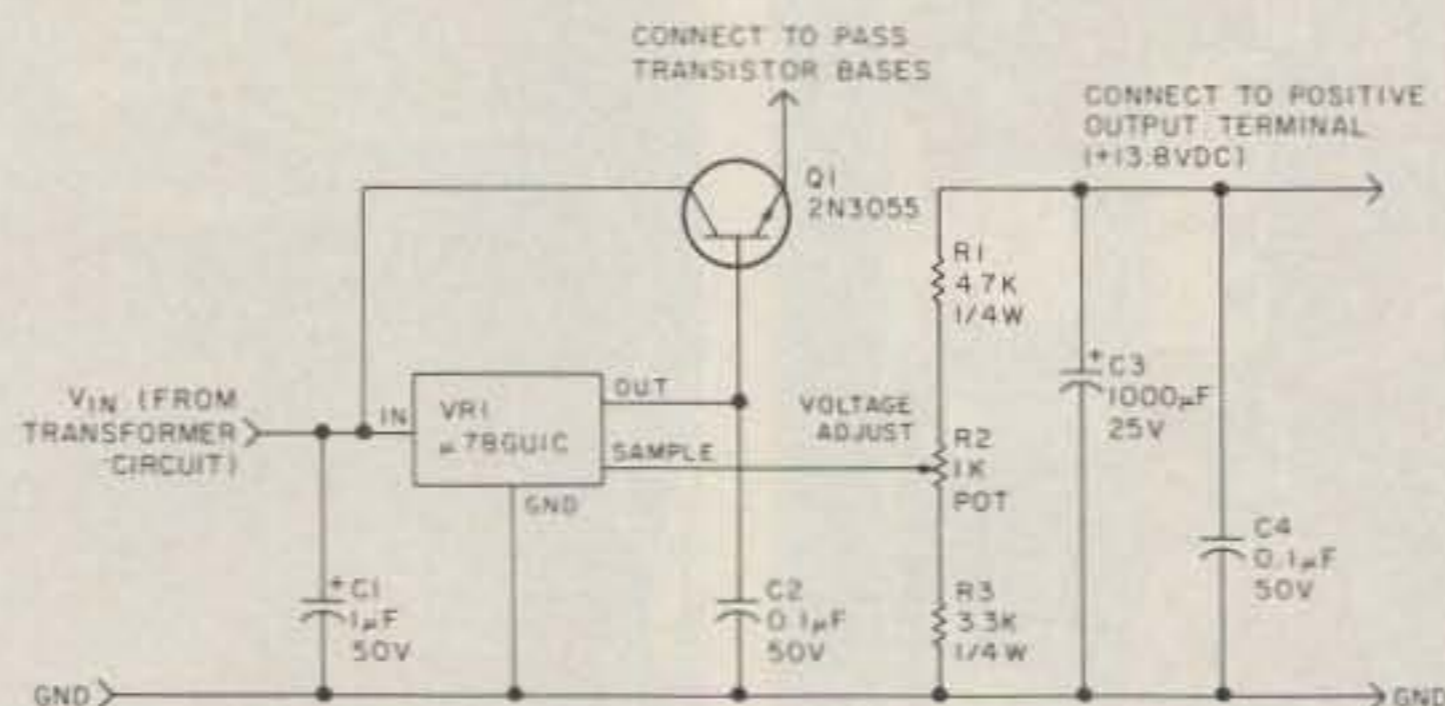

Fig. 2. New regulator circuit. The addition of a sample input on the voltage regulator creates a feedback loop which tends to keep the output voltage of the supply steady.

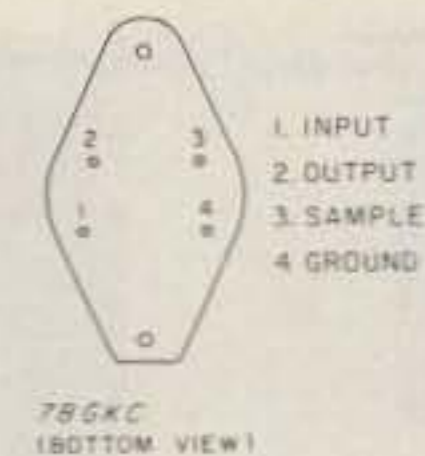
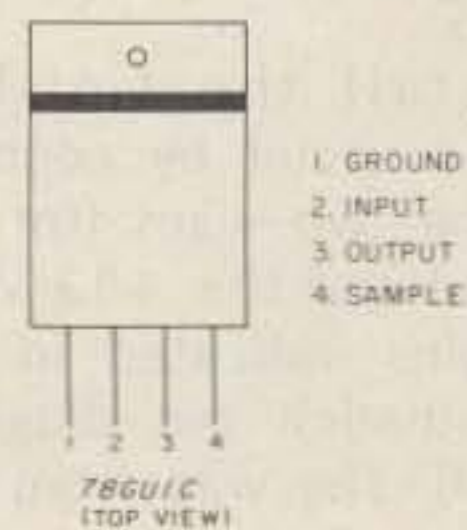

Fig. 3. Base diagrams. Note that the pin connections for the two voltage regulators are different.

current to the pass-transistor bases. Two bypass capacitors (C1 and C2) are mounted as close as possible to VR1. They prevent rf from upsetting the regulator and also act to prevent the regulator from oscillating. Resistors R1, R2, and R3 form a voltage divider for the sample input to the regulator. For the values shown, the output voltage is adjustable from 10.8 to 14.0 volts dc. Capacitors C3 and C4 filter out any noise or rf from the sample input.

Once all the new components are collected, it is time for surgery. Remove the original voltage-regulator circuit from the power supply. This will consist of VR1, R1, R3, C3, and C4. Refer to Fig. 3 in the original article. R2, C3, and C4 may be reused in the new circuit.

Next, install the new VR1 and Q1 to the chassis. Isolate Q1 from the chassis using mica or plastic insu-

lators. Don't forget to use a little silicone grease in the junction area. Finally, wire the remaining components in a point-to-point fashion using a terminal strip if required. Make sure that all four capacitors are mounted close to VR1.

Double-check all added wiring and remove any load from the supply. Adjust R2 for 13.8 V dc at the output terminals. Now reconnect your radio and you should be in business.

Conclusion

My supply stays in regulation out to 18 Amps. After that point it starts dropping down slightly. Your supply may differ a little due to transformer type or construction technique.

I guess the moral of the story is that it's OK to use LM317s for low-current applications, but use feedback techniques (78GU1C) for high-current applications. ■

Your Second Best Piece Of Monitoring Gear



Next to your receiver, a subscription to **Monitoring Times** is your most valuable tool for communications monitoring. This fact-filled monthly tabloid (hardware not included!) is written just for you, the listener, bringing you 36 pages of concise information on how to improve your listening post, where to look for those elusive signals, exciting home-brew projects—and more!

Subscribe Today!

\$12-1 year • \$22-2 yrs. • \$31-3 yrs.
Canadians please add \$2 per year.
Foreign subscribers please add \$11 per year for surface mail, or \$27 per year for air mail.

Free Sample Available Upon Request

Call Now Toll-Free!

Dial 1-800-438-8155 (cont. US except NC) to place your subscription for 2 or 3 years on Mastercard or Visa. Or for 1-year subscription, mail your check to Grove, Dept. K, 140 Dog Branch Road, Brasstown, N.C. 28902. Office ph. 704-837-9200.

the HAM STATION

P.O. Box 4405
220 N. Fulton Ave.
Evansville, IN 47710

Stores Hours
MON-FRI 9AM-6PM
SAT 9AM-3PM

WARRANTY SERVICE CENTER FOR:
ICOM, YAESU, TEN-TEC

TERMS:

Prices Do Not Include Shipping.
Price and Availability Subject to
Change Without Notice
UPS COD \$2.50 Per Package

USED EQUIPMENT

AZDEN	
PCS-300 2M H.T.	\$174.95
PCS-3000 w/Remote Cable	199.95
PCS-4000	199.95
DENTRON	
GLT 1000C Tuner	\$139.95
80-10 At Tuner	29.95
DRAKE	
UV-3 (2M & 440) TT MIC, PS-4	\$429.00
1.5 KHZ Filter	25.00

ENCOMM	
ST 144 2M H.T.	\$185.00
HT 1200 2M H.T.	139.50
ST-440 440 MHZ H.T.	179.95
ST-7T 440 MHZ H.T.	109.95
HL-32V 2/30 Amp	59.95
ST-8BC Base Chgr	19.00
HAL	
MPT-3100 (NO MONITOR)	\$1775.00
CT2200/KB2100	525.00
CRI-200 Interface	199.95
HEATHKIT	
SB-200 Amp	\$329.95
HR-1680 RCVR	79.95
HM-102 WATT MTR	40.00
VL 1180 10/80W 2M Amp	89.95
IM-4190 VHF-UHF MTR	89.95
ICOM	
745/PS	\$715.00
720A/CW	599.95
740/PS	639.95
740 XCVR	549.95
730, PBT, CW	509.95
730 XCVR	459.95
260A 2M All Mode	269.95
255A 2M	185.00
3AT 220 MHZ	189.95
PS 15 Power Supply	99.95
Phone Patch 720, 730, 740	99.95
2AT-2M H.T.	159.50
KANTRONICS	
Interface II	\$179.95
Varifilter	49.95
Miniterminal	109.95
Amtor Soft (VIC 20)	29.29
KENWOOD	
TS820S	\$459.95
TS120S	369.95
TS520, CW	419.95
TS520SE	429.95
TS520	389.95
TR2600 2M H.T.	229.95
TR2400 2M H.T.	169.95
TR8400 440 MHZ	229.95

KENWOOD	
RM-76 MicroProcessor	45.00
BS-5 Pan Kit	49.00
DC Module (520 or 820)	55.00
PC-1 Phone Patch	49.00
ST-1 Basechgr-2400	39.00
SPKR/MIC-2400	25.00
SPKR/MIC-2500	25.00
TEN-TEC	
Titan Amp	\$1850.00
OMNI-C	599.95
OMNI A/B	299.95
Century 22	289.00
Century 21	209.00
214 Electret MIC	35.00
2591 2M H.T.	189.95
YAESU	
FT980	1150.00
FT901DM, CW, Fan	579.95
FT901DM, Fan, CW, SSB Filters	599.95
FV-901DM Remote VFO	169.00
FT101ZD, CW, Fan	549.95
FT101ZD MKII, Fan	549.95
FT101ZD MKIII	549.95
FT101Z, CW, Fan	459.95
FV101Z Remote VFO	105.00
FT101E	449.00
FT101B	369.50
FT107M/DMS/FP107E PS.	569.00
FL101/FR101S	350.00
YC-601 Dig. Readout	175.00
FT221 2 MTR All Mode	269.95
207R 2M H.T.	139.50
FBA-2 Sleeve	3.75
FL-110 Amp	149.95
YD 148 Desk Mic	29.00
FP-757 HD	140.00
MISC	
Cubic Astro 150	\$329.95
Collins 75S-3/CW Narrow	249.95
Collins 32S-3 XMTR/516F-2	399.95
Microlog Air-1 w/Amtor 64	189.00
55 FT. Crank up (8 SQ. FT.)	399.95
Hygain CD-45 Rotator	109.95

MISC	
Vic 20 Computer	55.00
KDK-2016/TT MIC	169.95
Shure 444 MIC	29.00
Welz SP-600 MTR	89.95
DEMONSTRATORS	
AEA	
MBA-20 Text	\$ 45.00
AMERITRON	
AL-1200 Amp	\$1225.00
ENCOMM	
ST200 ET 2M H.T.	\$ 159.95
ST-442 440 MHZ H.T.	249.95
HT-7 440 MHZ H.T.	79.95
ST-4QC 4-6 HR Base Chgr	54.95
HAL	
CRI-200 Computer Interface	\$225.00
CRI-100 Computer Interface	199.95
ICOM	
751/PS	\$1089.95
NYE	
MB-V Tuner	\$399.00
VOCOMM	
25/100W 2M Amp	\$109.95
YAESU	
270RH/Voice	\$350.00
SP980 Spkr/Filters	42.50
NC-8 Base Chgr	79.95
AEA CLOSE-OUT	
AMT-1 Interface	\$279.95
KT-3 Keyer/Trainer	109.95
Woodpecker Blanker	109.95
DRAKE	
7000-E CW, Rtty, Ascil	\$299.95
ENCOMM	
ST-442 440MHZ H.T.	\$259.95
ST-222 220MHZ H.T.	259.95
ICOM	
PS 20 PS./Spkr	\$149.95
7070 Interface	89.95
KANTRONICS	
Radio-Tap SWL Interface	\$129.95

For Orders and Price Checks Call 800-523-7731

Indiana call 1-812-422-0231
Service Dept. 1-812-422-0252

The Commodore Cable Caper

*Need a printer cable? Strapped for cash?
 Don't just sit there — build the darn thing!*

So you need a printer interface for your Commodore 64. Have you seen what they're asking for one? Well, between my junk box and the local parts house, I built one for a whole lot less than the \$60.00 asking price on the one I saw.

The Commodore 64 already has an RS-232C interface built in. It's part of the user port. The only problem is that the voltage levels at the user port are TTL, and we need RS-232C levels.

Now hold on a minute. Just what are these levels I keep rambling about? And what is this RS-232C? First, the TTL levels are the voltage levels the computer talks to itself with. They are usually a +5 volts dc for a

mark, or logic one, and 0 volts dc for a space, or logic zero. RS-232C is a little more complicated. Rather than discuss everything about RS-232C, let's just look at the basics.

RS-232C is a standard. It was set up by the Electronics Industries Association (EIA) to provide a standard interface for computer and peripheral manufacturers. The standard interface allows one manufacturer's computer to be used with another's printer or another's modem, etc. The standard, however, is not required. Some manufacturers don't use it. Those manufacturers that do, generally use a DB25 connector. As can be seen in Table 1, each pin has a designated name and

function. Rather than discuss all of the pins, let's look at the three pins we'll be using for our printer interface.

The three pins we'll be using are pin 2, pin 3, and pin 7. Pin 2 is Transmitted Data (TD), which carries the data transmitted from the computer to the outside world. Pin 3 is Received Data (RD), which carries the data received by our computer from the outside world. Pin 7 is Signal Ground, which provides a ground return path for TD and RD.

The voltage levels used on the Transmitted-Data and Received-Data pins are

also defined by the RS-232C standard. A mark, or logic one, will be a voltage level between -3 and -25 volts. A space, or logic zero, will be a voltage level between +3 and +25 volts. Since the RS-232C and TTL voltage levels are different, we need something to convert the levels from one to the other.

Several manufacturers build integrated circuits to do this conversion. The ones we'll be using are manufactured by Motorola. They are the MC1488 and the MC1489. The MC1489 is a quad line receiver. It is used to convert the received data

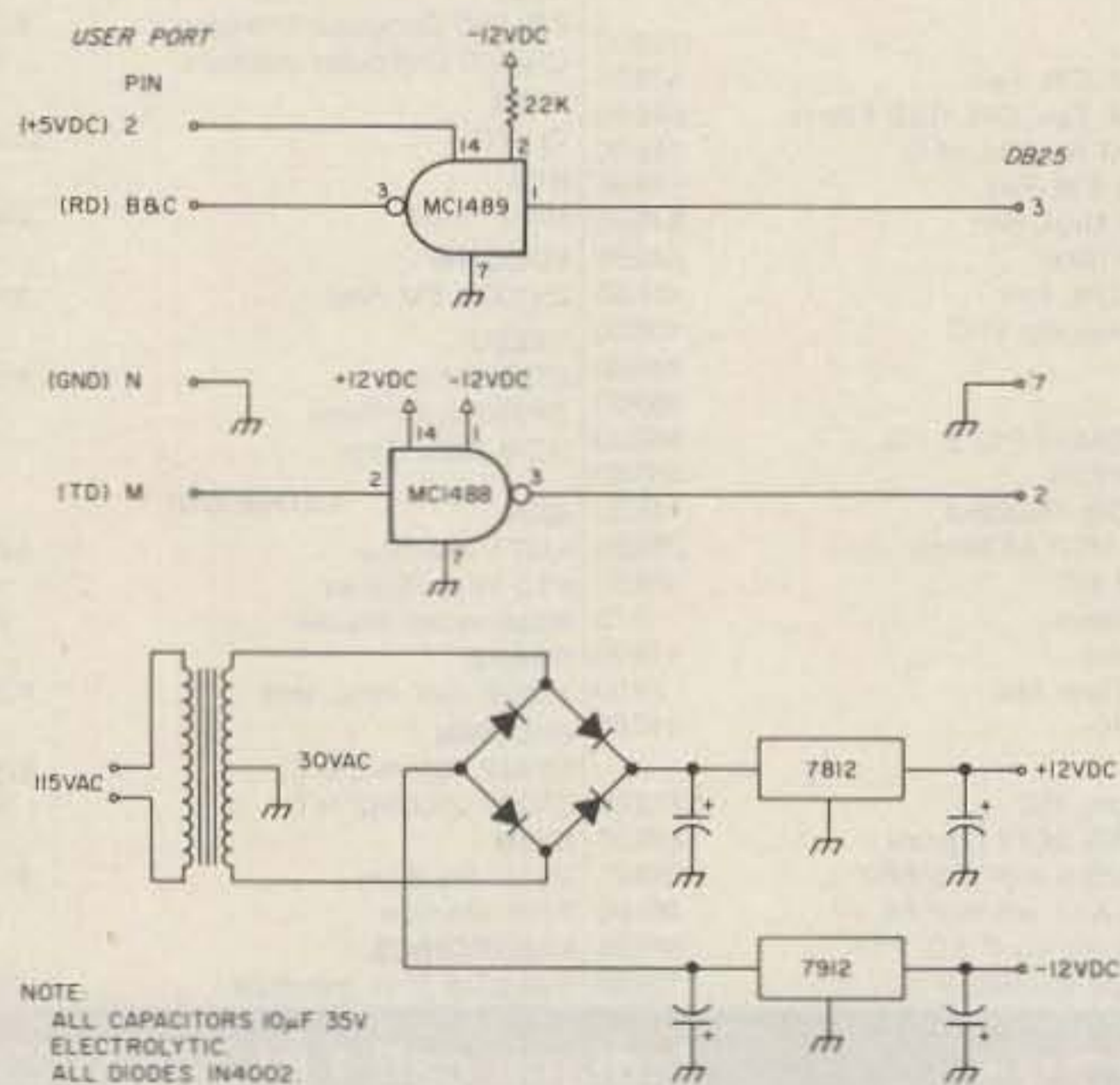

Fig. 1. Schematic.

Pin	Name	Function
1	FG	Frame ground
2	TD	Transmitted data
3	RD	Received data
4	RTS	Request to send
5	CTS	Clear to send
6	DSR	Data set ready
7	SG	Signal ground
8	DCD	Data carrier detect
9		Reserved
10		Reserved
11		Unassigned
12	(S)DCD	Secondary data carrier detect
13	(S)CTS	Secondary clear to send
14	(S)TD	Secondary transmitted data
15	TC	Transmitter clock
16	(S)RD	Secondary received data
17	RC	Receiver clock
18		Unassigned
19	(S)RTS	Secondary request to send
20	DTR	Data terminal ready
21	SQ	Signal quality detect
22	RI	Ring indicator
23		Data rate select
24	(TC)	External transmitter clock
25		Unassigned

Table 1. RS-232C pin designations.

1 =	50
2 =	75
3 =	110
4 =	134.5
5 =	150
6 =	300
7 =	600
8 =	1200
9 =	1800

Table 2. Data rate conversion.

from RS-232C levels to TTL levels. The MC1488 is a quad MDTL line driver. It is used to convert the transmitted data from TTL levels to RS-232C levels.

That's enough theory for now; let's look at the schematic (Fig. 1). As you can see, the circuit is fairly simple. All that's needed is a plus and minus 12-volt-dc power supply, one resistor, the two chips, and a couple of connectors. Since the circuit is so simple, go ahead and build the darn thing. When you're finished, come back here and finish reading. We still need to discuss some software.

Well, now that you've finished building the printer interface, you're going to need some software to make it work. There's a pretty good program on page 357 of the *Commodore 64 Programmers Reference Manual*. If typed in exactly as shown, it will transmit and receive ASCII data at 300 bits per second. If 300 is too slow or too fast for what you want to do, it's real easy to change. Line 100 reads like this: 100 OPEN 5,2,3,CHR\$(6)

The number 6 in parentheses is what sets the computer to 300 bits per second. By changing this number to one of the numbers shown in Table 2, you can operate your computer from 50 to 1800 bits per second.

Other programs should work equally well. You'll probably find one that works better. Anyway, this one will get you started. Hope you enjoy building and using your printer interface as much as I did. ■

PACKET RADIO GOES PORTABLE

GLB ELECTRONICS

presents



Model PK1-L

- LOW 25 mA Current drain.
- Designed for portable or solar-powered stations.
- Miniature size—Lightweight
- Rugged all metal, shielded enclosure.
- On-board Lithium Battery RAM backup.
- On-board watchdog for reliability.
- Standard DB-25 Connectors.
- Output signal indicates "Connected" Status.
- Does not require squelched audio.
- Comes with 8K of RAM.
- Remote Command Mode for Unattended operation.
- Hardware command lockout for security.
- Commands compatible with our Model PK1.
- Retains all other features of the Model PK1.
- Extra I/O lines for special applications.

Power requirement:
9 to 15 Volts DC @ 25 mA typical

Dimensions:
4.6 X 5.90 X 1.0 inches

Total Weight:
12 ozs.

PK1L—Wired and Tested
List— \$239.95
Amateur net— \$209.95

GLB MODEL TNC-2A KIT

Just when you thought TAPR TNC-2 Kits were a thing of the past, GLB — the first commercial producer of Packet Controllers — Joins the "TAPR Revolution" at last!

Hardware
Software
Documentation

by TAPR

GLB Model TNC-2A Kit

COMPLETE KIT ONLY

\$169.95

+ shipping

Contact GLB for information on our full line of Packet Controllers



GLB ELECTRONICS, INC.

151 Commerce Pkwy.,
Buffalo, NY 14224
716-675-6740 9 to 4

Copy Worldwide Short-wave Radio Signals on Your Computer

Remember the fun of tuning in all those foreign broadcast stations on the short-wave radio? Remember those mysterious sounding coded tone signals that baffled you? Well, most of those beeps & squeals are really digital data transmissions using radioteletype or Morse code. The signals are coming in from weather stations, news services, ships & ham radio operators all over the world. Our short-wave listener cartridge, the "SWL", will bring that data from your radio right to the video screen. You'll see the actual text as it's being sent from those far away transmitters.

The "SWL" contains the program in ROM as well as radio interface circuit to copy

Morse code and all speeds/shifts of radioteletype. It comes with a cable to connect to your radio's speaker/earphone jack, demo cassette, and an excellent manual that contains a wealth of information on how to get the most out of short-wave digital DXing, even if you're brand new at it.

For about the price of another "Pac-Zapper" game, you can tie your Commodore 64, 128 or VIC-20 into the exciting world of digital communications with the Microlog SWL. \$64. Postpaid, U.S. MICROLOG CORPORATION, 18713 Mooney Drive, Gaithersburg, Maryland 20879. Telephone: 301 258-8400.

MICROLOG

INNOVATORS IN DIGITAL COMMUNICATION

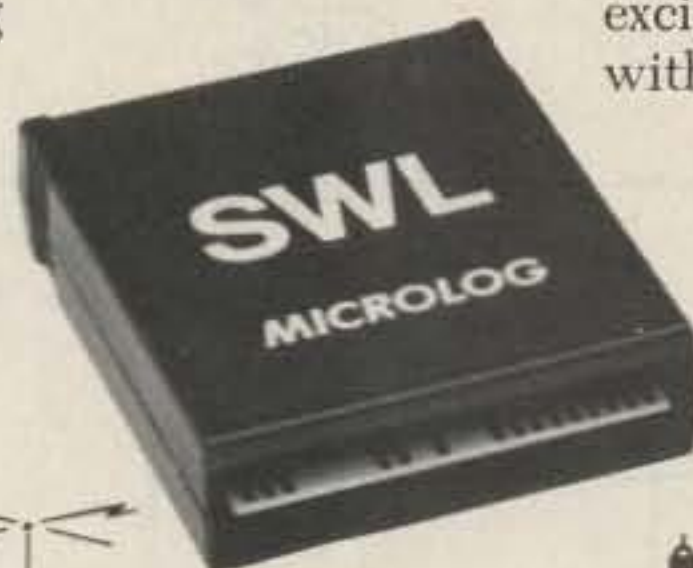

The Perfect RTTY Filter

Its tunable shift covers 80 to 1160 Hz with a flat gain and Q. And you can build it for less than ten dollars!

Have you ever noticed just how un-standard the so-called standard RTTY shifts are in practice? 170-Hz shift seems to mean anything less than 400 Hz. In the past, every time I tuned in a nonstandard-shift RTTY signal, be it commercial or amateur, my longing for tunable filters only increased.

My quest for tunable RTTY filters has ranged from switched-capacitance active types (they never worked right) to an audio heterodyne system that was

too complex to be worth the effort.

When I saw W9ODK's "Shoestring RTTY" TU using state-variable filters (73, January, 1985), the thought came to mind that such filters might be made tunable. The question was: Could the SVF maintain both Q and gain over the range needed to tune RTTY shifts of about 50 to 1200 Hz? A check of the filter design equations confirmed that such a filter should be possible, so two were built and tested. After

a few kinks were worked out, a final unit was fabricated and installed in my demodulator.

The result was a continuously tunable filter allowing coverage of shifts from 80 to 1160 Hz. Tests showed both gain and Q to be nearly flat across the entire range.

The Circuit

Since many modern receivers have fixed bfo offsets and cannot pass the higher frequencies attendant to wider shifts, the final

design was adjusted for so-called "low tones" (mark = 1275 Hz.)

The circuit (see Fig. 1) consists of two complete filters, each using a TLO84 BiFET quad op amp. The mark filter is fix-tuned at 1275 Hz while the space unit is tunable from 1355 to 2415 Hz. The pot used to tune the variable filter is a 100k dual-ganged, 41-step Radio Shack model (217-1732). The pot is billed as a "Stereo Control" and each section has a 40-percent-loudness tap which is unused.

R5 and R6 could be eliminated if a suitable 50k pot is available. Several junk-box pots were tried but produced poor results because the gangs were not evenly matched.

R3 and R4 should be closely matched as should

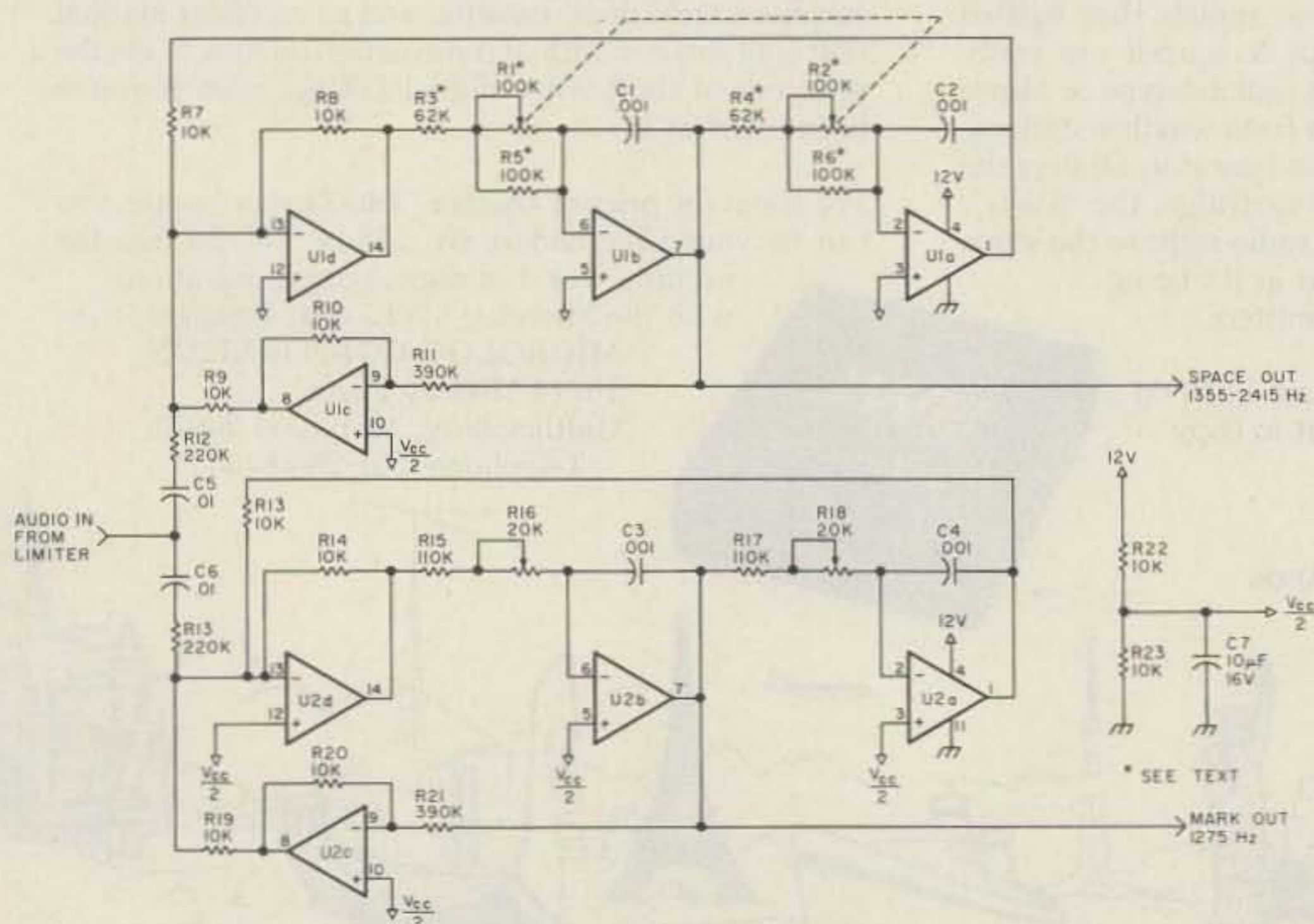

Fig. 1. Tunable RTTY filter.

Filter Center Frequency (Hz)	Shift (Hz)
1355	80
1445	170
1600	325
1700	425
1825	550
1975	700
2125	850
2275	1000
2375	1100

Table 1. Common shifts and their corresponding space-filter center frequencies.

R5 and R6. These resistors will determine the high and low end of the filter tuning range.

Construction

Just about any circuit-fabrication method can be used. I built mine on a PC card as a direct plug-in replacement for an existing filter card. The tuning pots replaced the filter switch on the front panel. Whatever the method of construction, keep in mind that some layouts may require the taming effects of ferrite beads on some or all of the inputs, outputs, bias lines, and the power-supply lead.

Also, do not lace or bundle the tuning control leads. The stray capacitance may cause problems, especially if the leads have to be more than a few inches long. Use polystyrene or mylar™ capacitors for C1 through C4. I used 15-turn PC trimpots for R16 and R18, but that is not really necessary.

Parts List		
C1-C4	.001 mylar or polystyrene	\$.48
C5, C6	.01 disc ceramic	.16
C7	10-uF, 16-V electrolytic	.18
R1, R2	Dual-gang 100k pot (RS 271-1732)	1.79
R3-R15	1/4-Watt resistors	.78
R16, R18	PC-mount, 20k trimpots	.50
R17, R19-R23	1/4-Watt resistors	.36
U1, U2	TLO84 BiFET quad op amp	3.90
Misc.	2 14-pin DIP sockets, hookup wire, PC board, etc.	1.00
		\$9.15

Parts available from Radio Shack, and Jameco Electronics, 1355 Shoreway Rd., Belmont CA 94002.

To align the fixed filter, feed in a 1275-Hz signal and adjust R7 and R8 for maximum output.

The variable filter should not need any alignment. To check it, however, feed in different tones and adjust the tuning control for maximum output. In each case, the output voltage should not change with frequency. Also, the output voltage should equal that obtained from the fixed filter, although a slight falloff may be noted at the extreme end of pot rotation. If the read-

ings vary by more than a few tenths of a volt, check to see that both gangs of the tuning pot track together.

Results

While the gain and Q of the space filter are nearly flat across the entire tuning range, some interaction and phase shifting will be noted on shifts less than 125 Hz. This is easily overcome with a slight retuning of the receiver.

The filter is easiest to use when coupled with an oscilloscope. Tune the receiver

until the mark signal yields maximum scope deflection, then rotate the filter-tuning control until the correct pattern or maximum space deflection is obtained. After years of switching filters, it takes a little getting used to.

Of course, if these filters are used with an AFSK generator for transmitting, make sure the tones transmitted are the same as those received. Otherwise, you will not be transmitting and receiving on the same frequency.

If the filter control is calibrated, then you can tell if that signal is 800- or 875-Hz shift. See Table 1 for a list of space-filter center frequencies and the corresponding shifts. The list can be used as a calibration guide.

With these filters, straddle tuning is no longer necessary. No matter what the shift, the maximum signal is being delivered to the detectors. ■



**508 Central Ave.
Westfield, N.J. 07090
(201) 654-8008**

<p>15 Pin Header & Mating Socket, Vert MT/PC</p> <p>.156" Centers 5/1.00 Crystal Clock Oscillator 50 3, 300uF 35V Axial-1 1/2" 7/8" Nich 2/.95</p> <p>Coils For Radio Elec's Feb. 84 TV Project, Toko #S T-1, T-2, L-1 (12uH) & L-2 (.071uH) Complete Set Of All 4 Coils..... 8.50</p> <p>MC1330—Prime (Moto) 2/1.00 BFQ-85 Transistor 1.50 Disc Caps .001uf 20/1.00 74123-Prime (Nat) 3/1.00 470uf 35V (Radial) 3/1.00 470uf 16V (Axial) 4/1.00 2N3904 10/1.00 2N3906 10/1.00 1N914 40/1.00 1N4148 40/1.00 1N5231B (5.1V Zener Diode) 5/1.00 Voltage Regulators (Prime TO-220) 7805, 7812, 7824, 7905, 7912—Mix or Match—3/1.00 Mica Insulators For TO-220 Pkg. 20/1.00 Voltage Reg's (Unmarked, 60% Prime) May Include Positive/Neg & Adjust 15/1.00 78L08 Voltage Reg (DM106, TO-92) 20/1.00 PN2222A 20/1.00 2N3055 50 2N5308 20/1.00</p> <p>15 Cent (.15) Per IC TTL</p> <p>7403 7442 74126 7404 7450 74151 7410 7474 74163 7437 7476 74365 7438 7495 74393 7440 74107</p> <p>15 Cent (.15) Per IC 74LSXX</p> <p>74LS02 74LS32 74LS158 74LS08 74LS74 74LS257 74LS10 74LS86 74LS257 74LS20 74LS153 74LS273</p> <p>20 Cent (.20) Per IC CMOS</p> <p>4001B, 4011B, 4050B 10/1.00 MC838 (DTL) 40 Opto Isolator (H11G2-6PIN DIP) Specs 1.45 2716 Eprom 1.95 2732 Eprom 2.45 2764 Eprom 4.95 27128 EPROM 4.95 256K Dram 150ns Prime Hitachi (Ideal For Mac Upgrades & Expansion Projects) 4.95 8243 (I/O Expander IC) W/Specs 2.95 UDN 6118 (Display Driver IC-Specs) 85 UDN 6128 95 UCN 4116B—Osc/Freq Div Clock IC-Specs-5/1 UCN 4801 (8 Chan Bi-Mos Latch/Driver)-1.00 LM339 45 LM380 (ULN2280) 45 555 Timers (Ti) 4/1.00 NE556 (Dual Timer-Moto) 50 741J Op Amp (Mini Dip Hi Rel Pkg) 4/1.00 LM1310 (Unmarked, Tested Prime) 50</p>	<p>LM1889 95 LM3900 45 AM/FM Radio IC (#2204 W/Specs-Hobby) 15/1.00</p> <p style="text-align: center;">IC Sockets</p> <p>8 PIN/.07 14 PIN/.13 16 PIN/.15 18 PIN/.17 20 PIN/.19 22 PIN/.21 24 PIN/.22 28 PIN/.24 40 PIN/.39</p> <p>7 Segment Display (3" Common Cath) 15 7 Segment Display (.6" Common Anni) 65 Tri State LED's 3/1.00 Jumbo Red LED's—Diffused Lens, Prime (Ti), All 100% Prime-15/\$1, 100/\$6, 1,000/\$57.50 LED Mounting Clips & Rings 15/1.00 Texas Inst/#994A Keyboard-Inc/Data For Pins Made When Each Key Depressed 4.95 Dip Switch-12 Position 2/1.00 Dip Switch-8 Position 4/1.00 Keyboard Push Button Tops 30/1.00 Audio Cable 30 Feet/1.00 22AWG Wire 50 Feet/1.00 27AWG Wire 50 Feet/1.00 Mini Lubricator (& Lubricant) 1.00 Molex Pins (7 Pin/Strip) 100/\$2.50/\$4.1K/\$56 Clock Module—Crystal Controlled, Green Display/12VDC/Time Set Switches/Data-4.95 Rotary Switch (5 Position, 5A 125V)-3/1.00 Giant Alpha Numeric Display 1-1/2" x 2" 7X5 (35 Total) Red LED Matrix/Specs-4.95 11 LED Bar Graph Display-2-3/4" Rect LED's (Specify Red, Grn, Amb) Specs 2.69 Seven Amp (7) Tapped Transformer—Can Be Wired For (7.5V, 9V, 15V, 18V) Reg Shpg. 8.95 Wall Plug Transformer-24V 525mA 1.50 6.3V 1.2A Transformer 1.20 12V Center Tap Transformer 2.50 8A, 200V Bridge, Qk Disc. (GI)95 1N4007 20/1.00 1N5059 (200V 1 Amp) 15/1.00 1N5060 (400V 1 Amp) 10/1.00 Zener Diodes-20V 1W 30/1.00 Zener Diodes-13V 1W Glass 30/1.00 2560.0KC Crystal 50 3.579545 Color Burst Crystal (HC-18) 50 1.0 Mhz Crystal 1.95 6.0 Mhz Crystal 1.95 TO-5 Heat Sinks (Bern) 10/1.00 TO-18 Heat Sinks (Bern) 10/1.00 Super Sub-Mini Ceramic Caps (All 100V) 0015uf 100V (152) 30/1.00 0022uf 100V (182) 30/1.00 0027uf 100V (272) 30/1.00 0033uf 100V (332) 30/1.00 0039uf 100V (392) 30/1.00 0056uf 100V (562) 30/1.00 0082uf 100V (822) 30/1.00 4.7uf 40V Lytic (Radial) 20/1.00 47uf 25V Lytic (Radial) 10/1.00 1000uf 185V Twist Lock 1.00 3200uf 50V (Ideal For Power Supplies)-1.00 5600uf 25V (Comp Grade 3-5/8" X1)-3/1.00 .1uf 50V Monolithics 10/1.00 22uf 50V Monolithics 20/1.00</p>	<p>Chip Caps—Set of 4, 2 Each 2.7 & 3.3pf-1.00 .33uf 100V Dip Mylar 10/1.00 1,000 PC Resistor Ass't (30 Values) 1/2W-\$3 Pots-1 Meg, Linear Taper 5/1.00 Motion Detector Bds (Inc IC-S2) 7/10.00 Mot Det (IC Only-ULN2232A) 3/\$2-20/10.00 Protect Box/Lid For Detector 1.95 Miniature Speaker For Detector65 Extensive Construction Article For Det. \$1 TV Knobs 15/1.00 Ammeter (0-15 A.C. Amperes) 4.95 Volt/OHM Meter MVMNT (0-1K OHM, 0-300V) 2.95 6V Miniature Gear Motor 50 RF Chokes-1.8uh, 8.2uh, 12uh, 22uh-10/1.00 22/44 Pin Edge Card Connector 50 Sld. Cont.—50, 100K; 1.2, 2, 5M 5/1.00 BNC "T" Connector (UG-274) 95 Mixed Connector Ass't 10/1.00 1.5AMP 50V Bridge (GI, TO-5 Pkg) 50 25AMP 200V Bridge (Solder Lug Term) 1.50 Zenith TV Replacement IC Special \$1 Each 221-42, 221-43, 221-45, 221-48, 221-69, 221-79, 221-87, 221-96, 221-104, 221-105, 221-106, 221-140 25D900 (Horiz Output W/Damper Diode)-2.95 25C1172B (Toshib-Horiz Output Trans)-1.95 Winegard 4 Bay Bowtie UHF Antenna-19.50 IC Storage (Bug Box (Holds) 30 IC's-1.75 Precision (Multi-Turn) Trim Pots (Copal), 100 OHM, 500 OHM, 1K, 2K, 5K, 10K, 20K, 50K, 100K, 200K, 500K, 1M-85 Each-3/\$2 Piher PT-10V Hor Mt (Single Turn) Trimmers 100 OHM, 1K, 10K, 25K, 50K, 100K 4/\$1 Heat Sensitive Switch/150° C 10/1.00 Mixed Coil Ass't 10/1.00 Buzzers 3/1.00 Chip Resistor (6.8K) 20/1.00 Chip Resistor (470K) 20/1.00 Chip Cap (330pf) 20/1.00 Jumbo Red LED W/Built In Resistor-30/\$1 MRF 901 (Hobby Grade-60% Good) 10/1.00 IC Ass't (Hobby Grade, Some Marked)-30/\$1</p>																						
<p>74SC374-D Type Flip-Flop, Non/Inv 74SC533-Transparent Latch-Inverted 74SC534-D Type Flip-Flop, Inverted 74SC540-Octal Buffer/Line Driver-Inv 74SC541-Octal Buffer/Line Driver-N/I 74SC563-Transparent Latch, Inverted 74SC564-D Type Flip-Flop, Inverted 74SC573-Transparent Latch, Non/Inv 74SC574-D Type Flip-Flop, Non/Inv Data Book For All Above #s 2.50</p>																								
<p>Cypher IV Micro-Controller Kit-\$129.50</p> <ul style="list-style-type: none"> • 4 MHz, 8-Bit Microprocessor (NAT 1NS8073) • Control Basic Interpreter On-Chip • Auto-Start Operation At Power-On • Fast 16-Bit Multiply And Divide • RS-232, Supports CRT & Serial Link • 24 Bi-Directional I/O Lines (8255A) • RAM Memory-2K Expandable To 16K • Eprom Memory-Expandable To 16K • Built In Eprom Programmer • Parr (Centronix) Printer Interface • Optional Real-Time Clock W/Backup 																								
<p>Pay TV Hardware Installation Kit Blow Out As Low As \$2.95 + \$3.50 Shipping Per Unit</p> <p>All Kits Contain 5 F Connectors, 300 to 75 OHM Balun, 300 OHM Terminal Block 2 Ft 75 OHM Patch Cord 2 Ft 300 OHM Twin Lead, Nylon Cable Ties, And UHF Antenna</p> <p>Model #4124-\$2.95 Includes All Of The Above Plus 25 Feet Coaxial Cable And Mounting Hardware For Indoor Wall/Ceiling Installation</p> <p>Model #4880-\$2.95 Includes All Of The Above Plus 25 Feet Coaxial Cable And Attractive Expandable Pole/U-Bolt For Easy Indoor Installation</p> <p>Model #4845-\$3.95 Includes All Of The Above Plus 65 Feet Coaxial Cable And All Necessary U-Bolt Hardware</p>																								
<p style="text-align: center;">MODEL 705 Digital Multimeter</p> <table border="1" style="width: 100%; border-collapse: collapse;"> <tbody> <tr> <td>DC Voltage</td> <td>100uV to 1000V</td> <td rowspan="2" style="text-align: center; vertical-align: middle;">\$51.95</td> </tr> <tr> <td>AC Voltage</td> <td>100uV to 750V</td> </tr> <tr> <td>DC Current</td> <td>0.1uA to 10A</td> <td rowspan="2"></td> </tr> <tr> <td>AC Current</td> <td>0.1uA to 10A</td> </tr> <tr> <td>Hi-Lo Resistance</td> <td>0.1Q to 20MQ</td> <td></td> </tr> <tr> <td>Capacitance</td> <td>1pF to 20uF</td> <td></td> </tr> <tr> <td>Diode Test</td> <td>forward voltage testing</td> <td></td> </tr> <tr> <td>Hv test</td> <td>transistor testing</td> <td></td> </tr> </tbody> </table>			DC Voltage	100uV to 1000V	\$51.95	AC Voltage	100uV to 750V	DC Current	0.1uA to 10A		AC Current	0.1uA to 10A	Hi-Lo Resistance	0.1Q to 20MQ		Capacitance	1pF to 20uF		Diode Test	forward voltage testing		Hv test	transistor testing	
DC Voltage	100uV to 1000V	\$51.95																						
AC Voltage	100uV to 750V																							
DC Current	0.1uA to 10A																							
AC Current	0.1uA to 10A																							
Hi-Lo Resistance	0.1Q to 20MQ																							
Capacitance	1pF to 20uF																							
Diode Test	forward voltage testing																							
Hv test	transistor testing																							
<p style="text-align: center;">UHF-TV PREAMP</p> <p>(As featured in Radio Electronics March/May articles, 1982)</p> <p><i>This inexpensive antenna mounted preamp can add more than 25 dB of gain to your system. Lots of satisfied customers and repeat orders for this high quality kit, which includes all component parts, PC BD, Case, Power Supply and Balun \$34.50 Assembled Version \$57.50</i></p>																								
<p>Terms: MICRO-MART accepts Visa, MC and telephone COD's. Minimum order \$10.00. Shipping—U.S. orders, \$2.00. Canada and other countries \$3.50 (includes ins.) Shipping rate adjusted where applicable. NJ residents add 6% sales tax.</p> <p style="text-align: center;">MICRO-MART • 508 CENTRAL AVE., WESTFIELD, NJ 07090 • (201) 654-8008</p>																								

1986 CALLBOOKS



The "Flying Horse" has a great new look!

It's the biggest change in Callbook history!
Now there are 3 new Callbooks for 1986.

The North American Callbook lists the amateurs in all countries in North America plus those in Hawaii and the U.S. possessions.

The International Callbook lists the calls, names, and address information for licensed amateurs in all countries outside North America. Coverage includes Europe, Asia, Africa, South America, and the Pacific area (exclusive of Hawaii and the U.S. possessions).

The Callbook Supplement is a whole new idea in Callbook updates. Published June 1, 1986, this Supplement will include all the activity for both the North American and International Callbooks for the preceding 6 months.

Publication date for the 1986 Callbooks is December 1, 1985. See your dealer or order now directly from the publisher.

- | | |
|---|---------|
| <input type="checkbox"/> North American Callbook
incl. shipping within USA | \$25.00 |
| incl. shipping to foreign countries | 27.60 |
| <input type="checkbox"/> International Callbook
incl. shipping within USA | \$24.00 |
| incl. shipping to foreign countries | 26.60 |
| <input type="checkbox"/> Callbook Supplement, published June 1st
incl. shipping within USA | \$13.00 |
| incl. shipping to foreign countries | 14.00 |

SPECIAL OFFER

- | | |
|---|---------|
| <input type="checkbox"/> Both N.A. & International Callbooks
incl. shipping within USA | \$45.00 |
| incl. shipping to foreign countries | 53.50 |

Illinois residents please add 6 1/4% sales tax.
All payments must be in U.S. funds.

RADIO AMATEUR
callbook INC.



Dept. B
925 Sherwood Dr., Box 247
Lake Bluff, IL 60044, USA

Tel: (312) 234-6600

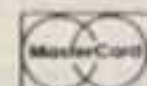
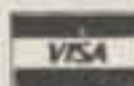

A Classic Beauty!

Treat yourself to the D-104 Silver Eagle.

The world renowned D-104 stands alone as the performance leader in base station amateur microphones. The T-UP9-D104 Silver Eagle is also recognized for its outstanding beauty.

A bright, vibrant appearance reflects elegance and style. All exterior parts plus the base and handle are chrome plated to a jewel-like finish.

As a result of Astatic's 50 years of technology, this microphone is also extremely versatile. Factory wired, it can be easily converted to electronic or relay operation. Adjustable gain provides optimum modulation.

The D-104 Silver Eagle will make any rig look as good as it sounds. For more information, see your Astatic dealer or write.



Astatic Corporation
P. O. Box 120 • Conneaut, OH 44030-0210 • (216) 593-1111
In Canada: Canadian Astatic, LTD.
1220 Ellesmere Rd., Unit 2
Scarborough, Ontario M1P 2X5 • (416) 293-2222



Radio equipment
not included

Also Available
Floor Space: 51" Wide by 30" Deep
\$199.50

... at last ... your shack organized!

A beautiful piece of furniture — your XYL will love it!

\$184.50 S-F RADIO DESK
Deluxe - Ready to Assemble

Designed with angled rear shelf for your viewing comfort and ease of operation.

FINISHES: Walnut or Teak Stain.
Floor Space: 39" Wide by 30" Deep

Additional Information on Request.
Checks, Money Orders, BankAmericard
and Master Charge Accepted.

F.O.B. Culver City. (In Calif. Add 6% Sales Tax.)

DEALER INQUIRIES INVITED

S-F Amateur Radio Services

4384 KEYSTONE AVENUE • CULVER CITY, CALIF. 90230 — PHONE (213) 837-4870





HF Equipment	Regular	SALE
IC-735 HF transceiver/SW rcvr/mic	849.00	729 ⁹⁵
PS-55 External power supply	160.00	144 ⁹⁵
AT-150 Automatic antenna tuner	349.00	314 ⁹⁵
FL-32 500 Hz CW filter	59.50	
EX-243 Electronic keyer unit	50.00	
IC-745 9-band xcvr w/ 1-30 MHz rcvr	999.00	769 ⁹⁵
PS-35 internal power supply	160.00	144 ⁹⁵
EX-241 Marker unit	20.00	
EX-242 FM unit	39.00	
EX-243 Electronic keyer unit	50.00	
FL-45 500 Hz CW filter (1st IF)	59.50	
FL-54 270 Hz CW filter (1st IF)	47.50	
FL-52A 500 Hz CW filter (2nd IF)	96.50	89 ⁹⁵
FL-53A 250 Hz CW filter (2nd IF)	96.50	89 ⁹⁵
FL-44A SSB filter (2nd IF)	159.00	144 ⁹⁵
HM-10 Scanning mobile microphone	39.50	
SM-6 Desk microphone	39.00	
HM-12 Extra hand microphone	39.50	
MB-12 Mobile mount	19.50	



IC-751 9-band xcvr/1-30 MHz rcvr	1399.00	1089
PS-35 Internal power supply	160.00	144 ⁹⁵
FL-32 500 Hz CW filter (1st IF)	59.50	
FL-63 250 Hz CW filter (1st IF)	48.50	
FL-52A 500 Hz CW filter (2nd IF)	96.50	89 ⁹⁵
FL-53A 250 Hz CW filter (2nd IF)	96.50	89 ⁹⁵
FL-33 AM filter	31.50	
FL-70 2.8 kHz wide SSB filter	46.50	
HM-12 Extra hand microphone	39.50	
SM-6 Desk microphone	39.00	
RC-10 External frequency controller	35.00	
MB-18 Mobile mount	19.50	

IC-720A 9-band xcvr • (CLOSEOUT) •	1349.00	699 ⁹⁵
PS-15 20A external power supply	149.00	134 ⁹⁵
FL-32 500 Hz CW filter	59.50	
FL-34 5.2 kHz AM filter	49.50	
BC-10A Memory back-up	8.50	
SM-5 8-pin electret desk mic	39.00	
MB-5 Mobile mount	19.50	

Other Accessories:	Regular	SALE
PS-15 20A external power supply	149.00	134 ⁹⁵
CF-1 Cooling fan for PS-15	45.00	
EX-144 Adaptor for CF-1/PS-15	6.50	
PS-30 Systems p/s w/cord, 6-pin plug	259.95	234 ⁹⁵
OPC Opt. cord, specify 2, 4 or 6-pin	5.50	
SP-3 External base station speaker	49.50	
SP-5 Remote speaker for mobiles	25.00	
CR-64 High stab. ref. xtal (745/751)	56.00	
PP-1 Speaker/patch (specify radio)	139.00	129 ⁹⁵
SM-8 Desk mic - two cables, Scan.	69.95	
AT-100 100W 8-band auto. antenna tuner	349.00	314 ⁹⁵
AT-500 500W 9-band auto. antenna tuner	449.00	399 ⁹⁵
AH-1 5-band mobile antenna w/tuner	289.00	259 ⁹⁵
GC-4 World clock • (CLOSEOUT) •	99.95	79 ⁹⁵



HF linear amplifier	Regular	SALE
IC-2KL 160-15m solid state amp w/ps	1795.00	1299
6-meter VHF Portable	Regular	SALE
IC-505 3/10W 6m SSB/CW portable	449.00	399 ⁹⁵
BP-10 Internal Nicad battery pack	79.50	
BP-15 AC charger	12.50	
EX-248 FM unit	49.50	
LC-10 Leather case	34.95	
VHF/UHF base multi-modes	Regular	SALE
IC-551D 80W 6-meter SSB/CW	699.00	599 ⁹⁵
EX-106 FM option	125.00	112 ⁹⁵
BC-10A Memory back-up	8.50	
SM-2 Electret desk microphone	39.00	
IC-271A 25W 2m FM/SSB/CW	699.00	569 ⁹⁵
AG-20 Internal preamplifier*	56.95	
IC-271H 100W 2m FM/SSB/CW	899.00	759 ⁹⁵
AG-25 Mast mounted preamplifier*	84.95	
IC-471A 25W 430-450 SSB/CW/FM xcvr	799.00	699 ⁹⁵
AG-1 Mast mounted preamplifier*	89.00	
IC-471H 75W 430-450 SSB/CW/FM	1099.00	969 ⁹⁵
AG-35 Mast mounted preamplifier*	84.95	

For a Limited time!
 With the purchase of an IC-271A/H or IC-471A/H get the matching PREAMP* for only • \$1.00 Extra.

Accessories common to 271A/H and 471A/H	Regular	SALE
PS-25 Internal power supply for (A)	99.00	89 ⁹⁵
PS-35 Internal power supply for (H)	160.00	144 ⁹⁵
PS-15 External power supply	149.00	134 ⁹⁵
SM-6 Desk microphone	39.00	
EX-310 Voice synthesizer	39.95	
TS-32 CommSpec encode/decoder	59.95	
UT-15 Encoder/decoder interface	12.50	
UT-15S UT-15S w/TS-32 installed	79.95	

VHF/UHF mobile multi-modes	Regular	SALE
IC-290H 25W 2m SSB/FM, TTP mic	549.00	479 ⁹⁵
IC-490A 10W 430-440 SSB/FM/CW	649.00	579 ⁹⁵

VHF/UHF/1.2 GHz FM	Regular	SALE
IC-27A Compact 25W 2m FM w/TTP mic	369.00	299 ⁹⁵
IC-27H Compact 45W 2m FM w/TTP mic	409.00	359 ⁹⁵
IC-37A Compact 25W 220 FM, TTP mic	449.00	329 ⁹⁵
IC-47A Compact 25W 440 FM, TTP mic	469.00	399 ⁹⁵
PS-45 Compact 8A power supply	112.95	99 ⁹⁵
UT-16/EX-388 Voice synthesizer	29.95	
SP-10 Slim-line external speaker	29.95	
IC-3200A 25W 2m/440 FM w/TTP	549.00	489 ⁹⁵
UT-23 Voice synthesizer	29.95	
AH-32 2m/440 Dual Band antenna	32.95	
Larsen PO-K Roof mount	20.00	
Larsen PO-TLM Trunk-lip mount	20.18	
Larsen PO-MM Magnetic mount	19.63	

IC-1271A 10W 1.2 GHz SSB/CW Base	999.00	889 ⁹⁵
ATV-1200 ATV interface unit	TBA	
PS-25 Internal power supply	99.00	89 ⁹⁵
EX-310 Voice synthesizer	39.95	
UT-15S CTCSS encoder/decoder	79.95	
IC-120 1W 1.2 GHz FM Mobile	499.00	449 ⁹⁵
ML-12 1.2 GHz 10W amplifier	339.00	299 ⁹⁵

Repeaters	Regular	SALE
RP-3010 440 MHz, 10W FM, xtal cont.	999.00	899 ⁹⁵
RP-1210 1.2 GHz, 10W FM, 99 ch. synth	1199.00	1089
Duplexer 1210 1.2 GHz duplexer	1199.00	1089
Cabinet for RP-1210	249.00	



Order Toll Free Use your Credit Card!

Hand-held Transceivers	Regular	SALE
Deluxe models		
IC-02AT for 2m	349.00	289 ⁹⁵
IC-04AT for 440 MHz	379.00	319 ⁹⁵
Standard models	Regular	SALE
IC-2A for 2m	239.50	189 ⁹⁵
IC-2AT with TTP	269.50	199 ⁹⁵
IC-3AT 220 MHz, TTP	299.95	239 ⁹⁵
IC-4AT 440 MHz, TTP	299.95	239 ⁹⁵

Accessories for Deluxe models	Regular	
BP-7 425mah/13.2V Nicad Pak - use BC-35	67.50	
BP-8 800mah/8.4V Nicad Pak - use BC-35	62.50	
BC-35 Drop in desk charger for all batteries	69.00	
BC-60 6-position gang charger, all batts	SALE 359.95	
BC-16U Wall charger for BP7/BP8	10.00	
LC-11 Vinyl case	17.95	
LC-14 Vinyl case for Dlx using BP-7/8	17.95	
LC-02AT Leather case for Dlx models w/BP-7/8	39.95	

Accessories for both models	Regular	
BP-2 425mah/7.2V Nicad Pak - use BC35	39.50	
BP-3 Extra Std. 250 mah/8.4V Nicad Pak	29.50	
BP-4 Alkaline battery case	12.50	
BP-5 425mah/10.8V Nicad Pak - use BC35	49.50	
CA-2 Telescoping 2m antenna	10.00	
CA-5 5/8-wave telescoping 2m antenna	18.95	
FA-2 Extra 2m flexible antenna	10.00	
CP-1 Cig. lighter plug/cord for BP3 or Dlx	9.50	
DC-1 DC operation pak for standard models	17.50	
LC-2AT Leather case for standard models	34.95	
RB-1 Vinyl waterproof radio bag	30.00	
HH-SS Handheld shoulder strap	14.95	
HM-9 Speaker microphone	34.50	
HS10 Boom microphone/headset	19.50	
HS-10SA Vox unit for HS-10 & Deluxe only	19.50	
HS-10SB PTT unit for HS-10	19.50	
ML-1 2m 2.3w in/10w out amplifier	SALE 79.95	
SS-32M Commspec 32-tone encoder	29.95	

Receivers	Regular	SALE
R-7000 25-2000 MHz, 117V AC	899.00	789 ⁹⁵
RC-12 Infrared remote controller	TBA	
R-71A 100 kHz-30 MHz, 117V AC	\$799.00	649 ⁹⁵
RC-11 Infrared remote controller	59.95	49 ⁹⁵
FL-32 500 Hz CW filter	59.50	
FL-63 250 Hz CW filter (1st IF)	48.50	
FL-44A SSB filter (2nd IF)	159.00	144 ⁹⁵
EX-257 FM unit	38.00	
EX-310 Voice synthesizer	39.95	
CR-64 High stability oscillator xtal	56.00	
SP-3 External speaker	49.50	
CK-70 (EX-299) 12V DC option	9.95	
MB-12 Mobile mount	19.50	



HOURS • Mon. thru Fri. 9-5:30; Sat. 9-3
 Milwaukee WATS line: 1-800-558-0411 answered evenings until 8:00 pm Monday thru Thursday.
Please use WATS lines for Ordering
 use Regular lines for other Info and Service dept.

Order Toll Free: 1-800-558-0411 In Wisconsin (outside Milwaukee Metro Area) 1-800-242-5195

AMATEUR ELECTRONIC SUPPLY Inc.®

4828 W. Fond du Lac Avenue; Milwaukee, WI 53216 - Phone (414) 442-4200

AES BRANCH STORES

WICKLIFFE, Ohio 44092 28940 Euclid Avenue Phone (216) 585-7388 Ohio WATS 1-800-362-0290 Outside Ohio 1-800-321-3594	ORLANDO, Fla. 32803 621 Commonwealth Ave. Phone (305) 894-3238 Fla. WATS 1-800-432-9424 Outside Florida 1-800-327-1917	CLEARWATER, Fla. 33575 1898 Drew Street Phone (813) 461-4267 No In-State WATS No Nationwide WATS	LAS VEGAS, Nev. 89106 1072 N. Rancho Drive Phone (702) 647-3114 No In-State WATS Outside Nevada 1-800-634-6227	CHICAGO, Illinois 60630 ERICKSON COMMUNICATIONS 5456 N. Milwaukee Avenue Phone (312) 631-5181 Outside Illinois 1-800-621-5802
--	---	---	---	--

Double Your Computing Power!

Try "parallel processing" with a second CoCo keyboard.

This article describes how to add a second keyboard to your computer. It is simple in that no code conversion is attempted. The second keyboard is simply placed in parallel with the first. This will be of special interest to amateur-radio operators using the Color Computer.[®] They no longer will have to have the computer sitting in front of their radios taking up valuable desk space.

My wife and I run a secretarial service here in the

Cleveland, Ohio, area. We have found our CoCo to be invaluable in this word processing area. The TRS-80C makes the thousand-dollar machines look like a big waste of money. Why buy a big, sometimes dedicated, machine when you can run two or even three CoCos for the same price? I do not believe that we realize how many computers like ours are out there in businesses. More public-domain programs to demonstrate the business end of the Color

Computer would drive this home.

Although not into games, I do use the computer for code conversion on my amateur-radio system. As an avid code/radioteletype enthusiast, I cannot imagine going back to a keyer or mechanical teletypewriter. My Yaesu FT-980 radio is microprocessor controlled. The various ports are brought out of the radio and can be controlled by another microprocessor. The possibilities are exciting.

My problem was described by the old adage, "You can't mix business with pleasure." The CoCo had been kept on the radio desk. This allowed me to enter

business documents while still keeping an ear to the radios. At times the CoCo really became a nuisance as it took up so much desk space; moving it to the side is difficult due to the wires and cables.

Checking some of the local computer outlets, I found their units to be (typically) way overpriced. Keyboards are available through mail order, but matching enclosures could not be found. Many of these keyboards would require reformatting to work with the Color Computer.

This was when our 16-month-old daughter came by with her "computer" — the old bubble-bump key-

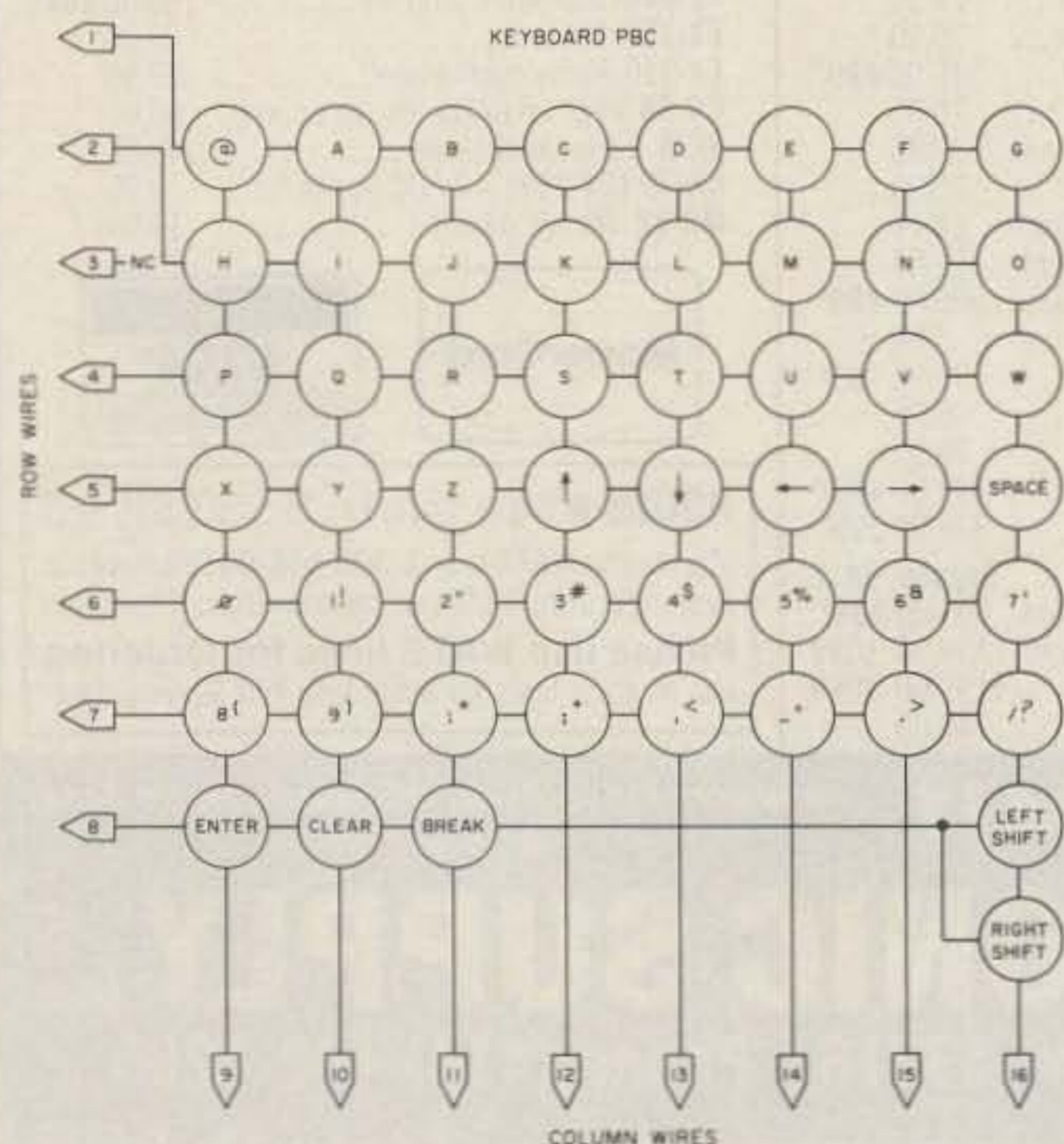

Fig. 1. To test your new keyboard, connect a battery-operated test lamp or an ohmmeter between any row and any column wire. Ensure that the respective key operates. For example, if wire 4 and wire 13 are checked, key T should establish continuity. Repeat for each row and column wire.



Photo A. The new addition to the radio shack.

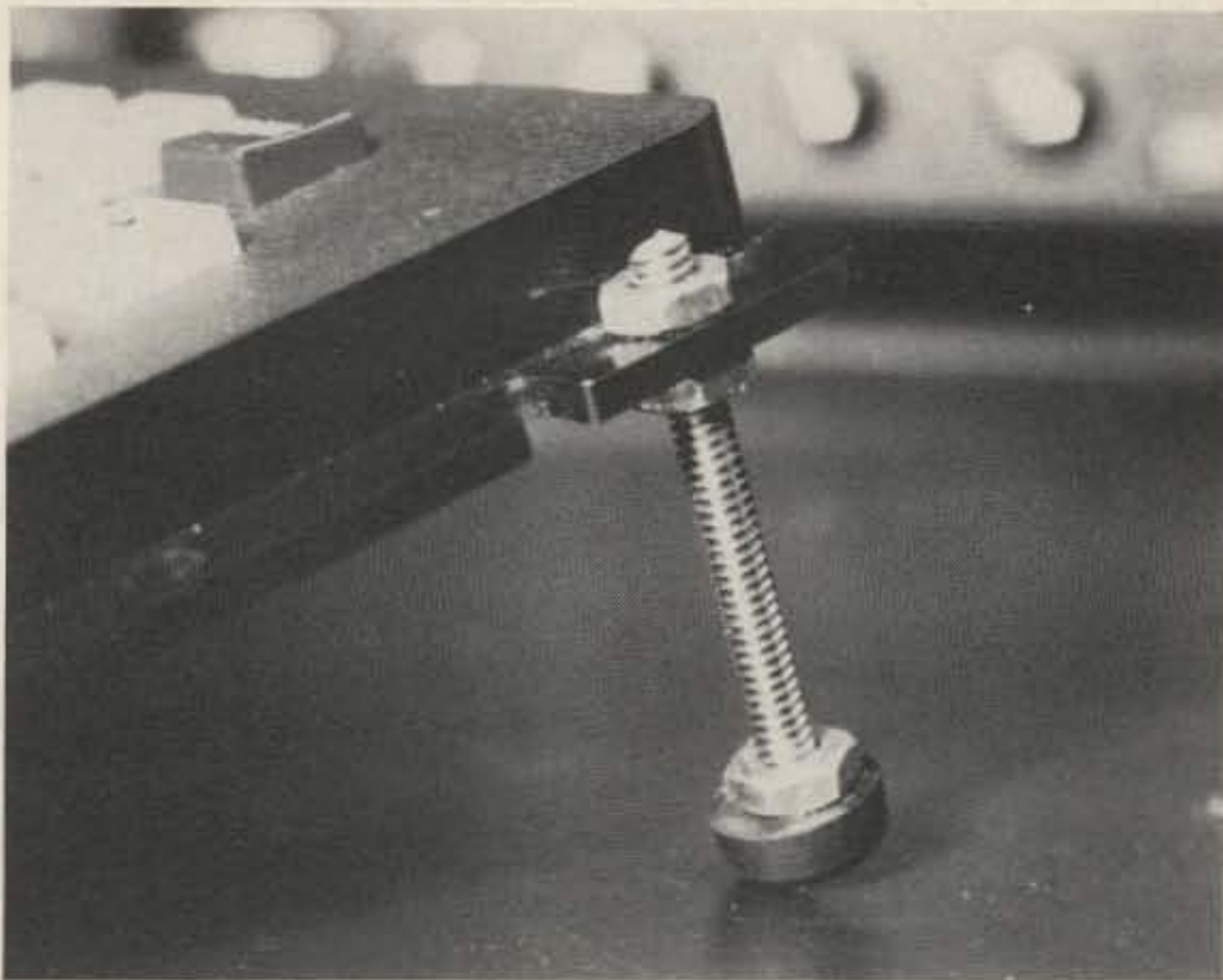

Photo B. Keyboard rear leg with rubber foot.

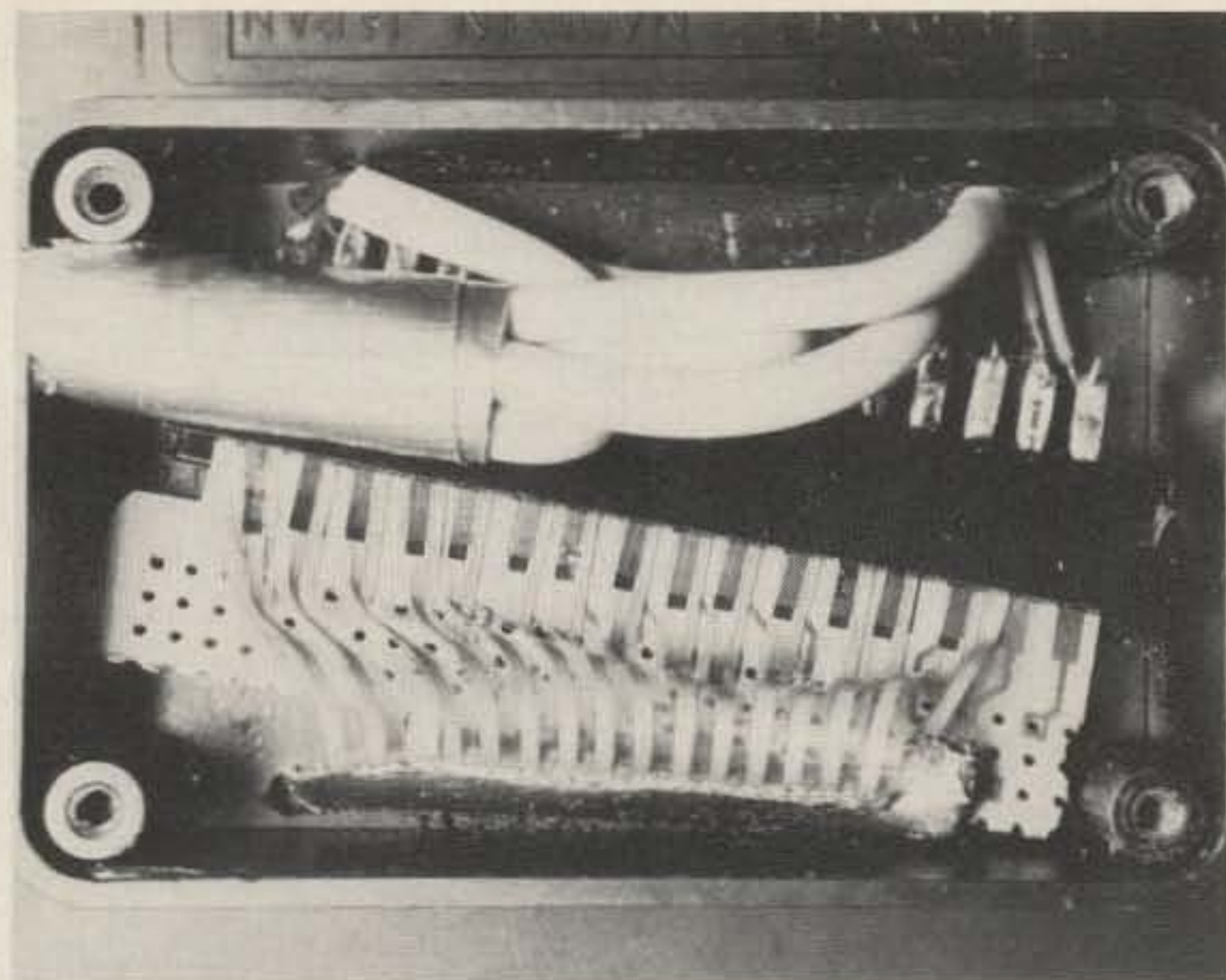

Photo C. Box for connections.

board which I had given her when I modified my computer by giving it a real typewriter keyboard. My wife yelled, "Indian giver!" as I took the old keyboard into the workshop.

Modifying the Keyboard

The keyboard is a small, self-contained unit not needing an enclosure. However, you will need a box to keep the connections immobilized. If they are bumped and jiggled, they will eventually fail. The mounting brackets on the side provided a location for hardware rigged to hold the keyboard at the proper angle.

All parts were scavenged from various junk boxes. A parts list is an excellent breeding ground for creativity. If you do not have a part, try to come up with something you can substitute for it. If you do not have rubber feet for the keyboard, perhaps you can locate some rubber-like material from

somewhere else, or check the attic and basement for some discarded appliance that may have rubber feet you could use.

The keyboard is connected to the computer via the 16-conductor ribbon cable coming out of the back of the connector box. (Pin 3 of this cable is not used: I write about 16 conductors only because of the type of wire that I used. You may substitute 15-conductor cable anywhere that 16-conductor cable is called for.)

Cut a slit in the bottom of the box for the ribbon cable to fit through. Measure the cable and mark the box. Drill a hole at one end of the mark, fit a coping-saw blade into it, and carefully cut the line. If you do not have a coping saw, perhaps the slit could be made (in a plastic box) using a hot knife or soldering iron. A hand moto-tool would be ideal for this step. Wrap tape around the ribbon conductor to protect

the cable from chafing on the edges of the slit in the box.

The following step, cutting and gluing the ribbon cable, is not necessary if you can locate a proper connector for it. You cannot solder against the plastic of the cable; it just disintegrates.

The connection to the keyboard is formed using a card-edge socket and a plug-in board for this socket. Since the spacing of the connections on the ribbon cable is different from the spacing on the plug-board, the ribbon cable connections will

be repositioned to match the plug-in board. With a pair of scissors, cut the conductors of the ribbon cable apart. Feed the cable through the slit and glue the box to the back of the keyboard.

Sixteen-conductor cable will be run from the second keyboard to the computer. This cable can be hard to find, but it is easy to fabricate. Rotor cable in 3, 4, and 5 conductors is available at most department stores. Four-conductor phone line can be found at Radio Shack and is quite flexible.

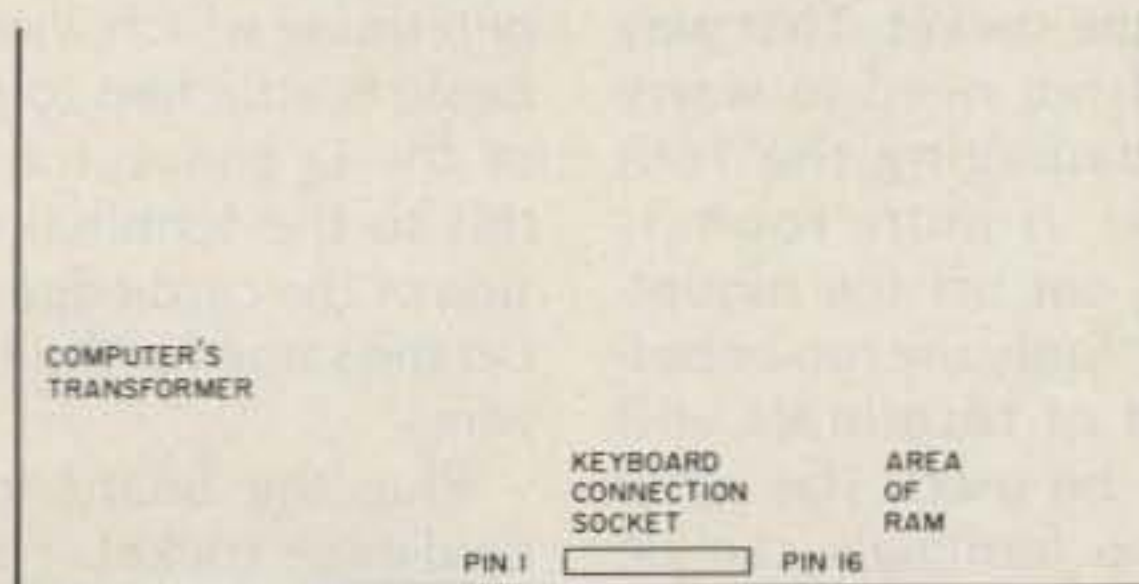

Fig. 2. Front of the computer.

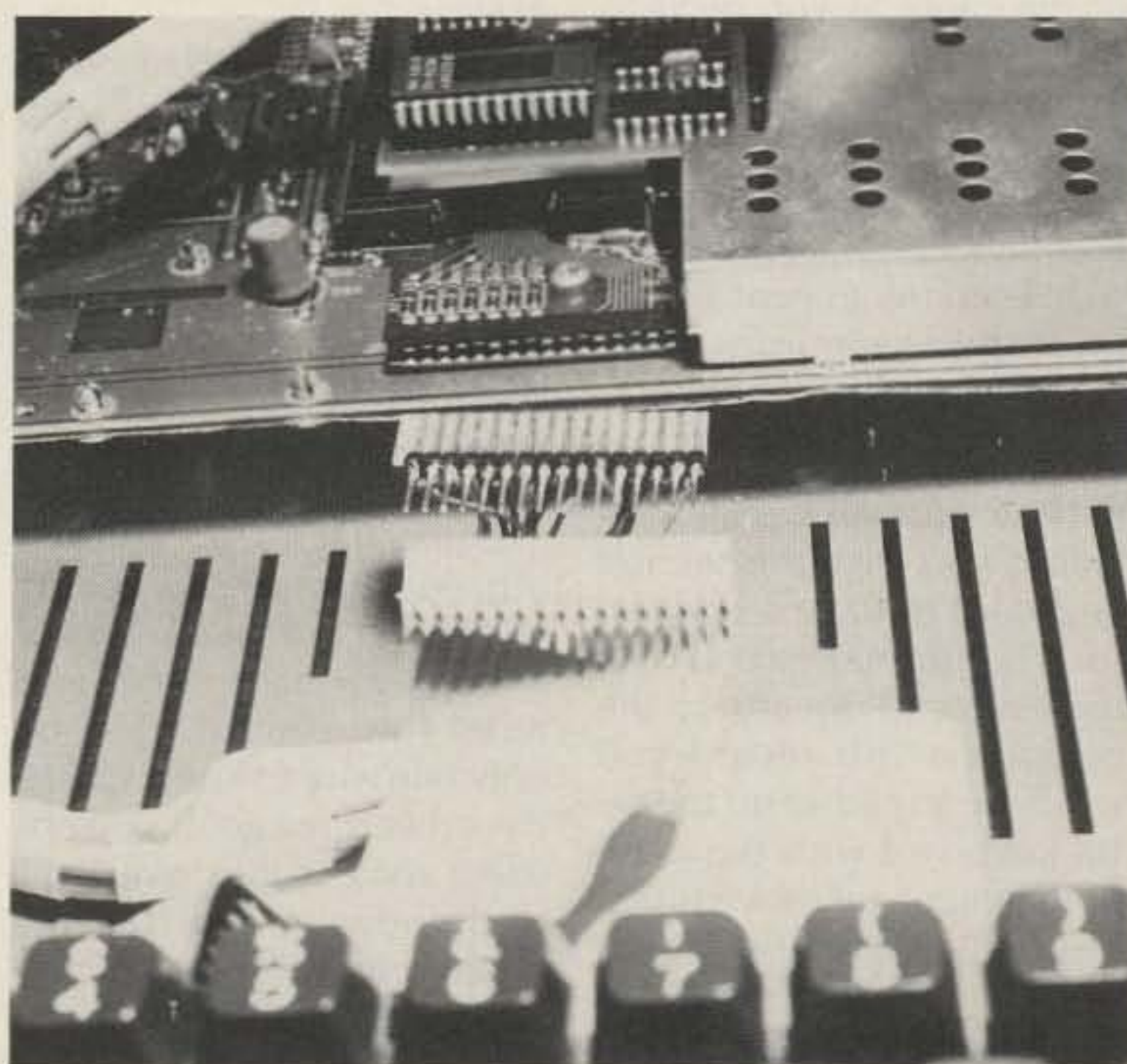

Photo D. Keyboard connectors come into the bottom of the computer.

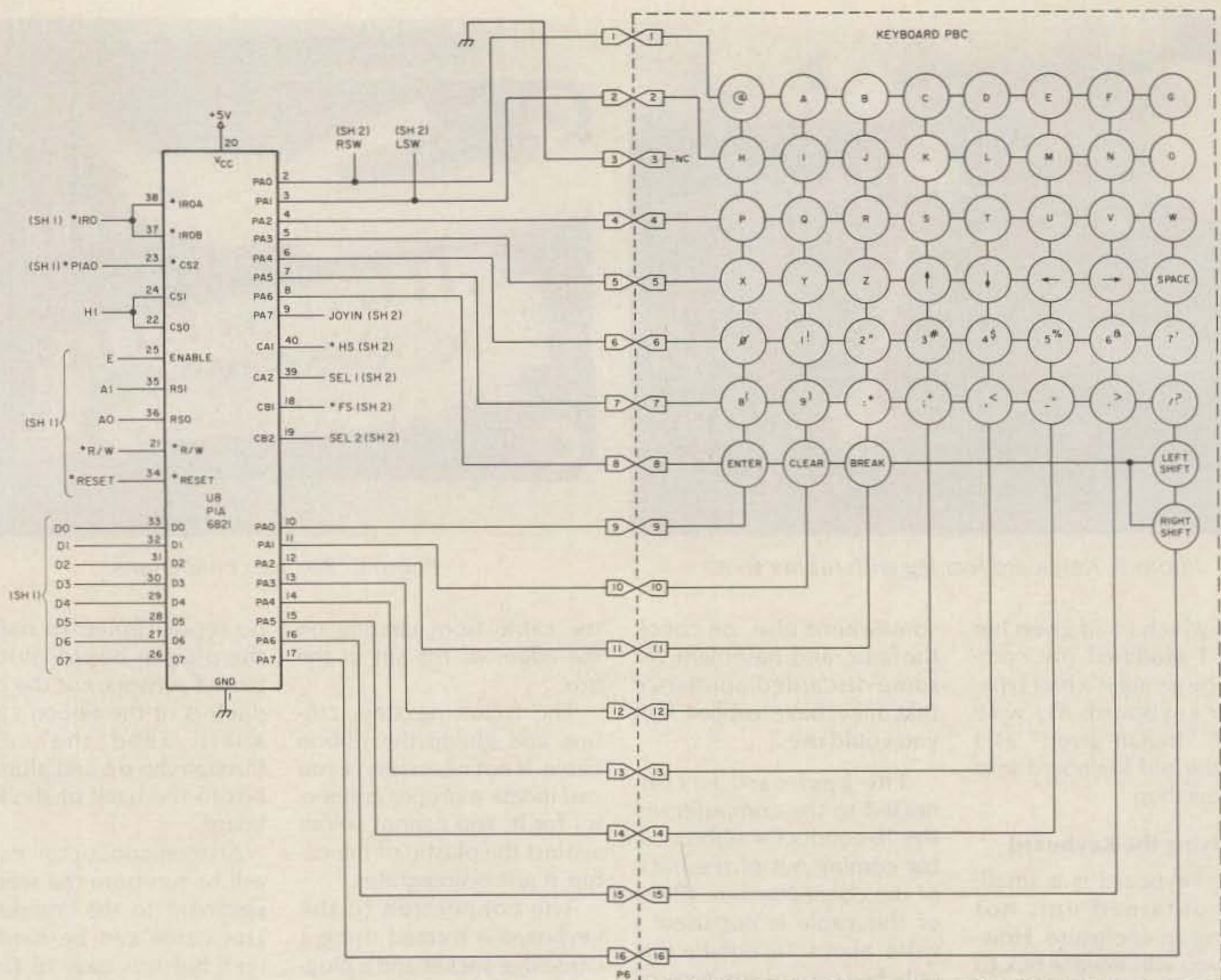

Fig. 3.

Determine how far you want to go with the keyboard and cut as many runs of the cable as you need to make the 16 conductors. I used 4-wire phone line, 25 feet long; four runs made 16 conductors. Tape the cables together every six inches or so to keep things neat. Masking tape is cheaper than electrical tape for this purpose.

Now you will have to decide if you wish the second keyboard to have a connector. The alternative is to wire the keyboard directly to the computer. This means you will have to gather up the extra keyboard with the computer when you move them. Skip the next few steps, which are for the connector, if you are not going to use one.

Cut another 16-conductor

cable; this time make it two feet long. It will be used inside the computer. Set it aside.

A 25-pin D connector is used in these steps. These connectors are difficult to solder. A small soldering iron and tweezers will make the job easier. Shorts can be avoided by using as little heat as possible so that the insulation on the wires is not burned away.

Solder each set of wires in a predetermined order. If you solder red, black, green, and yellow each time, you need find the position of only one wire to know where the other three go. If you are using rotor cable, you will find one wire is different. Again, pay attention to the order in which they are installed.

Use the female connector for the back of the com-

puter. If something falls on the computer, it is less likely to short the female connector than the male.

Take one end of the 16-conductor cable you fabricated and solder it to the male D connector. Install the hood over this connector. Set the cable aside.

If the box that was installed on the back of the keyboard is too small to fit the card-edge socket, the socket will have to be cut. Cut between the 17th and 18th set of terminals on one side of the socket. That way you will not need to worry about damaging the 16th terminal. If more room is needed, cut off the mounting hole. Only the top or bottom set of terminals will need to be used. The other set of 16 terminals can be cut off.

Cut the plug-in board per-

pendicular to the terminals. Leave enough to be able to grasp the board to plug it in. If you cut the connector, cut the board's length to match.

Using the plug-board as a guide, glue the ribbon cable terminals over the plug-board terminals. Super glue, if used carefully, works fine. The connector will be tight due to the additional material of the ribbon conductors so be sure your glue will hold.

Use an ohmmeter or battery-operated test lamp to determine which wire of the cable is attached to pin one of the D connector. Solder this to the terminal on one side of the card-edge socket. Do the same for the 15 other wires.

Plug the board into the card-edge socket. Place the connection into the box. If it is loose, a drop of glue will

secure it. File a hole in the top of the box for the cable to come out. Put tape over the cable so it fits tightly in the hole. Put the cover on the box.

Glue two rubber feet on the bottom front edge of the keyboard. Threaded rod is used to lift the back of the keyboard to the proper angle. Cut the rod so that it gives an angle that will suit you. Two nuts secure the rod to the top of the keyboard. Put a nut onto the bottom of one of the rods and screw a rubber foot on after the nut. Glue the nut to the foot. Do the same for the other rear foot. A dab of glue to all the nuts will keep things secure.

Modifying the Computer

Unplug the computer and take the top off. The female D connector is installed on the rear of the cover over the output ports. Install it with the flange on the inside of the cover.

Mark where the hole should be placed and cut it out. A coping saw works well here, too. File the hole clean and make sure it is large enough to allow the male connector to fully seat in the matching cover. If the hole is too small, the connector will get hung up on the cover plastic and will not fully seat. Drill the two mounting holes.

Prior to mounting the connector, attach the two-foot piece of 16-conductor wire. Two washers on the outside of the connector's mounting bolts will keep them from digging into the plastic of the computer case. Bolt the connector in.

Attach the connectors together. Use Fig. 1 to check the keyboard for proper operation. Put a bit of tape over the wires to indicate their respective pin numbers as you check.

Remove the CoCo's keyboard. (I had replaced the

original with a Hi-Tek keyboard which came with an adapter that slides into the CoCo's keyboard connector. It was a very easy job connecting the cable to this connector. I just slid it out a bit, soldered the wires to the very back of the pins, and slid the connector back in. If you do not have this adapter, try sliding the wires into the connector with the wires of the other keyboard and tape the two sets of wires together.)

Now is a good time to check for problems with your typewriter keyboard. Sometimes the larger keys, the <Enter>, <Shift>, and <Space Bar>, will begin to bind. On most units the key-tops are easily pulled off. A dab of Vaseline will restore proper operation.

Button up the computer and plug it in.

One More Thing...

You now have a second,

small keyboard on your computer. As you can see in Photo A, it can easily be moved out of the way of the radios. I will eventually change to an "expensive-grade" keyboard, but for now the CoCo's old keyboard fulfills all my needs.

Oh, one more thing. If one feels guilty about stealing a keyboard from a toddling daughter, just take her out for some ice cream. The whole TRS-80C probably will be hers before long. ■

Parts List

An old (or new!) CoCo keyboard
16-conductor cable (see text)
Small plastic box (270-230)*
Male D connector (276-1547)
Female D connector (276-1548)
Hood for D connector (276-1549)
Card-edge socket (276-1551)
Card-edge board (276-152)
Four rubber feet
About 6" of threaded rod
Six nuts to fit the rod
Masking tape
Super glue
* Radio Shack part numbers.

Hi Pro Repeaters ELCO

MAGGIORE ELECTRONIC LAB.

Manufacturers of Quality Communications Equipment

- Repeaters
- Links
- Remote Base
- Low Band, VHF, UHF
- Receivers
- Transmitters
- Antennas



Hi Pro 'E'

EXPANDABLE REPEATER SYSTEM

- Standard and Computerized Controllers
- Standard and Computerized Auto Patches
- Duplexers

- A NEW CONCEPT IN REPEATER DESIGN, THE Hi Pro "E" IS AN EXPANDABLE REPEATER WITH THE FOLLOWING FEATURES: A BASIC REPEATER WHICH WOULD INCLUDE A COMPLETE RECEIVER, TRANSMITTER, COR, FRONT PANEL CONTROLS AND INDICATORS, LOCAL SPEAKER AND MIC JACK AND CAPABLE OF FUTURE EXPANSION. ALL HOUSED IN AN EXTREMELY RUGGED, ENCLOSED, 19-INCH RACK MOUNTABLE CABINET.
- THIS SYSTEM CAN BE EXPANDED AT TIME OF PURCHASE OR CAN BE AN AFTER-PURCHASE ADD ON. THE ADD ONS ARE—HIGHER POWER, 110/220 VAC POWER SUPPLY, IDENTIFIER, AUTO PATCH, OR COMPUTER CONTROLLERS. IN ADDITION TO THESE ADD ONS AN ADDITIONAL RECEIVER AND TRANSMITTER CAN BE MOUNTED INTERNALLY FOR USE AS CONTROL LINKS, REMOTE BASE OR DUAL BAND OPERATION, ETC.
- AN EXTENSION PANEL IS AVAILABLE FOR LOCAL MONITORING OF THE REPEATER AND CONTAINS ALL NECESSARY METERING, STATUS LIGHTS AND INDICATORS. ALL ADD ONS ARE AVAILABLE FROM THE COMPANY AND ARE COMPLETE INCLUDING INSTRUCTIONS. THE Hi Pro "E" IS AVAILABLE IN NOVEMBER.

MAGGIORE ELECTRONIC LAB.

590 Snyder Ave.. West Chester, PA 19382 Phone (215) 436-6051 Telex 499 0741 MELCO

WRITE OR CALL FOR OUR COMPLETE CATALOG

Working 2ICTU

Can RTTY get any simpler?

Those of you expecting a rare DX story are probably going to be disappointed. But if you're interested in trying RTTY and have a computer, you should find this article interesting. If your computer has a serial port, you can put it on the air with just two ICs and a handful of small parts. This provides a very simple and, most important, inexpensive way of trying your hand at RTTY.

Some time ago I built a function generator to help

out with various projects around the shack. It's based on an EXAR 2206 IC which does all the work. While studying the spec sheets on this device, I noticed that it could also be used for FSK generation. Further digging around showed that EXAR also makes an IC that will demodulate FSK tones. These two devices seemed ideal for the construction of an ultra-simple TU that would interface my computer to my ham station. So, armed with the excellent data sheets

provided by EXAR, I set out to build a RTTY terminal unit. The result is a compact and simple AFSK TU that works surprisingly well.

The 2ICTU serves a number of purposes around the shack. In addition to the fun of making RTTY contacts over the air, it has proved a useful accessory for my computer. It allows me to

send programs over the air, which is a neat way of sharing my latest programming wizardry with friends who have otherwise-incompatible hardware. It also provides a way of backing up my more important software by running it out to audio tape. That way, if my disk drives or main tape unit go fratz, I am not completely out in the cold while

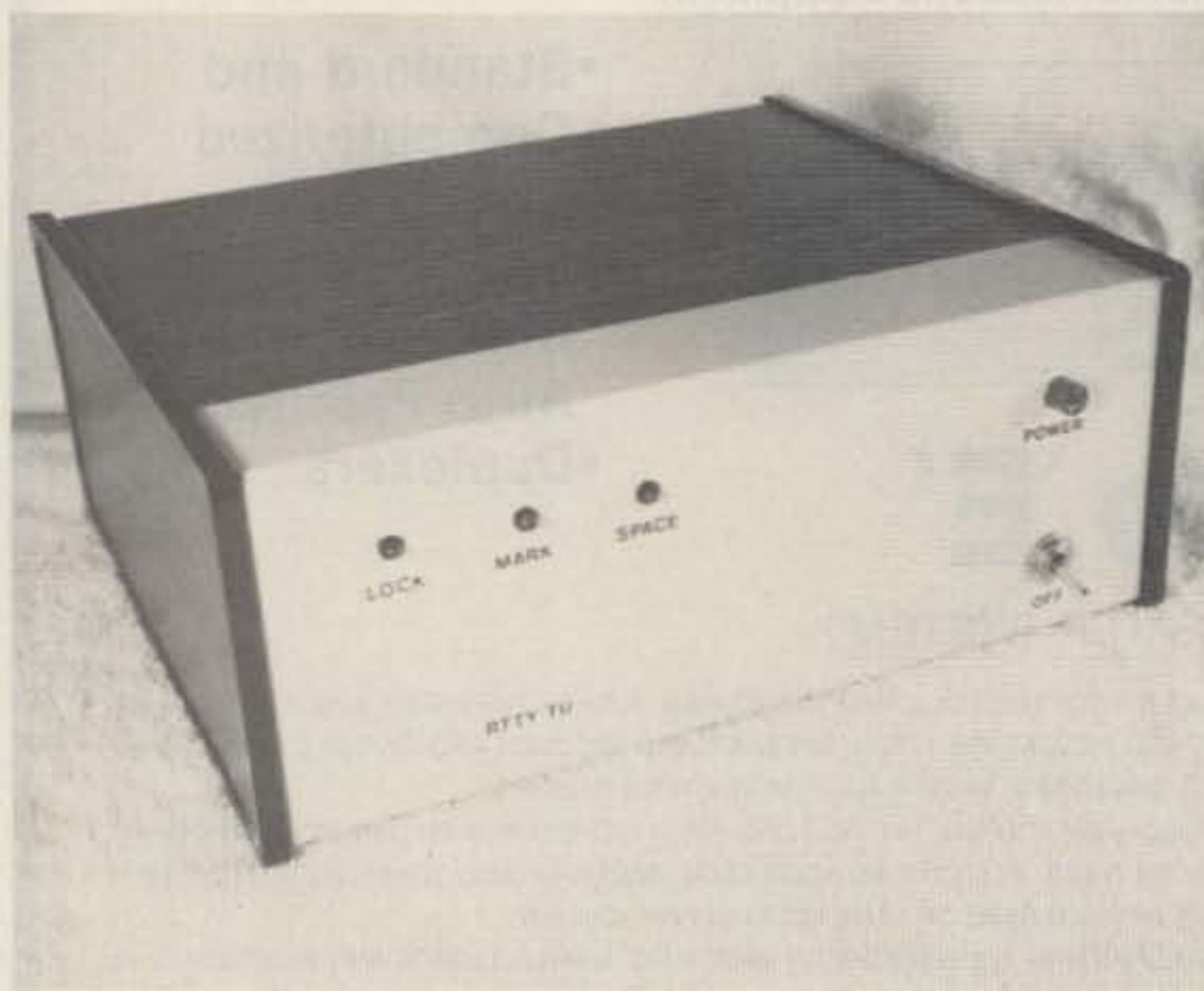

Photo A. The completed 2ICTU. I like to give my projects a professional look, so I use Ten-Tec enclosures. They cost a little more, but I believe they are worth it. The mark and space LEDs were never implemented; they're not really necessary.



Photo B. The rear panel with the multitude of connectors for the various inputs and outputs. The 5-pin DIN connector is used for the hookup to the serial port. The label indicates the 3 pins used: transmit data, receive data, and ground. The switch is for reversing the "sense" of the RTTY signal via the exclusive OR gates on the serial board. The audio-level trim pots are visible below the audio and tape outputs. The "audio" input and output are used for the connections to the rig.

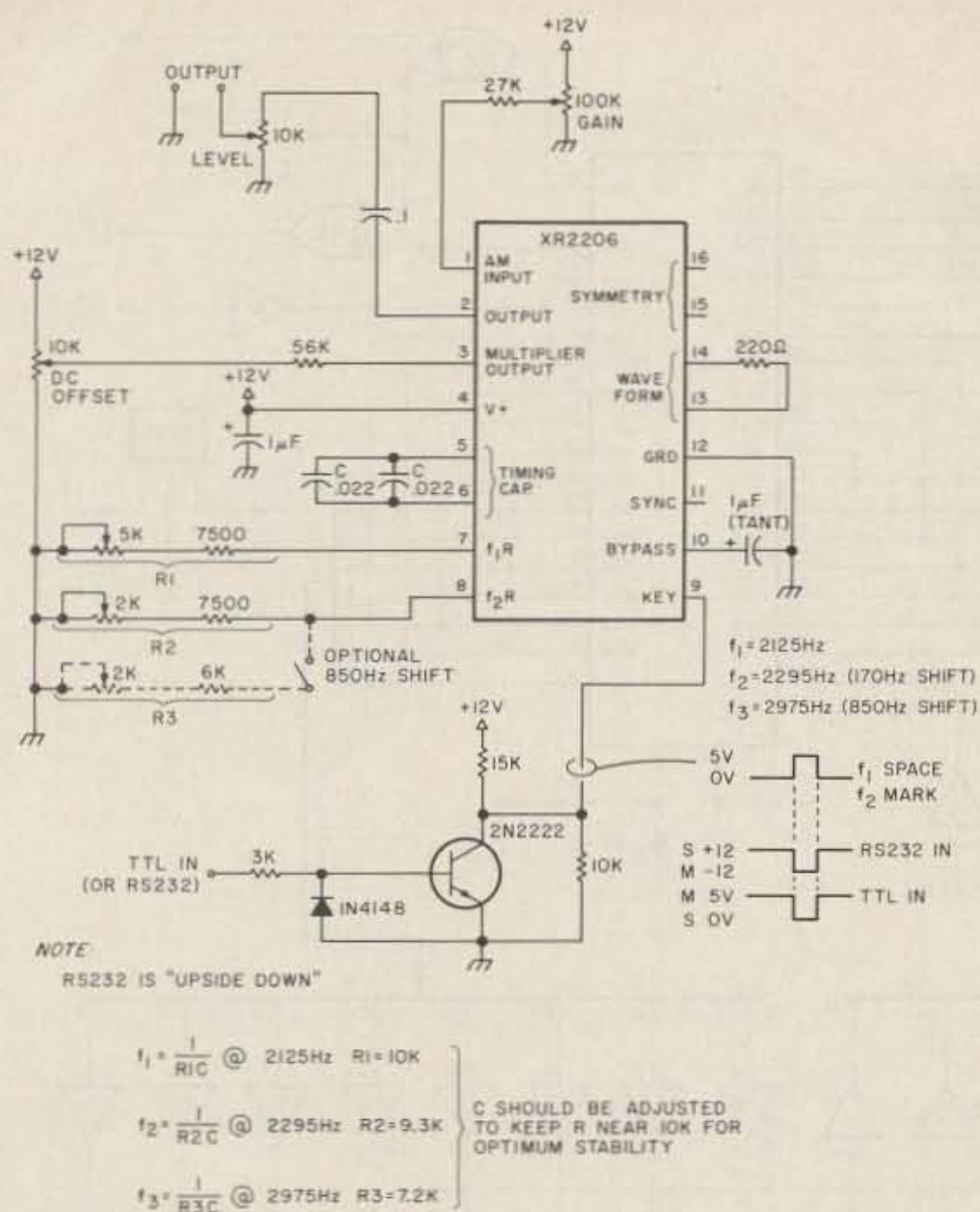

Fig. 1. The AFSK unit.

repairing them. Backup on a completely different medium such as this is the most secure way of protecting yourself from total disaster.

For those of you who may not have a serial port with a controllable baud-rate generator on your system, I have also included my general-purpose serial port. It is designed for the S-100 bus, but with a little thought can be modified for any computer. The configuration of the hardware makes it particularly easy to modify for the Commodore 64 or VIC-20 or any other 6502-based system. I have included the necessary circuit changes for those of you with these computers who might like to build the 2ICTU.

The modular concept of the 2ICTU should make it easy for you to extract only those parts required by your particular combination of computer and radio gear. It also allows you to plug in any additional items you

might like, such as additional filters, blinking lights, etc.

The software is what really makes the 2ICTU shine. A good software package makes this minimal hardware perform like a much more expensive unit. What's more, since it's my package, I can get into it and tinker around to my heart's delight. Anything I want to add or change is a simple matter of changing the coding to customize it to suit my needs and desires. I wrote some simple machine-language routines to interface the computer to the 2ICTU for storing and recalling data and programs on audio tape. The "bells and whistles" program for the RTTY operation is written in Fig-Forth and provides many of the features of store-bought units, including split video for transmit, receive, and status portions of the screen.

Construction can be by whatever method you like; there's nothing critical or tricky about the circuits. Nor-

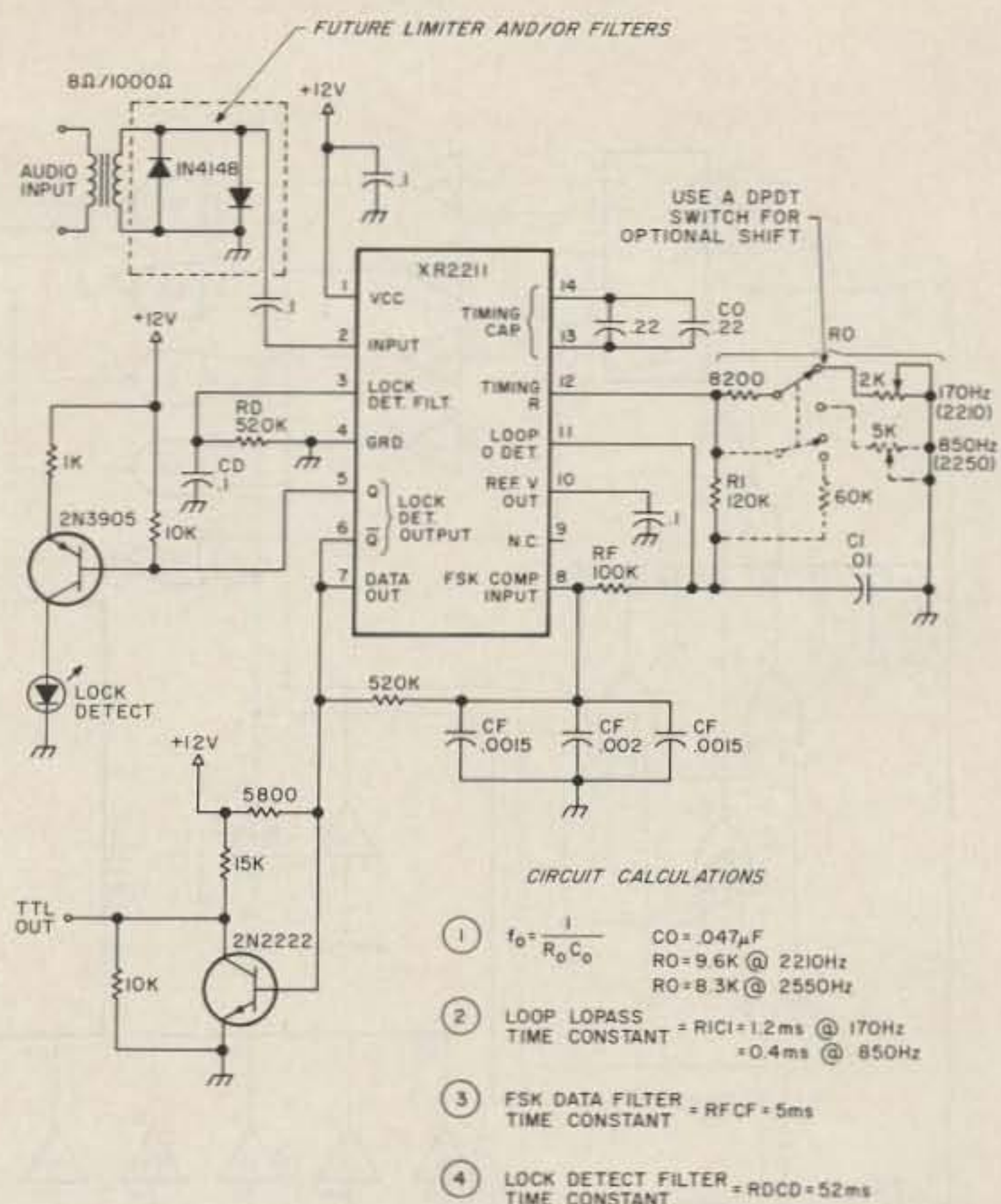

Fig. 2. The AFSK demodulator.

mal good building practices should provide you with a quality finished product. I built the 2ICTU on a surplus wire-wrap card and it has performed flawlessly for the past two years.

The AFSK Unit

The AFSK unit is an EXAR 2206 IC (see Fig. 1). This single chip does all the work and requires only that we add the required timing components to obtain the necessary frequency outputs. The schematic is straightforward and the only critical parts are, as usual, the timing capacitors—they should be polystyrene for maximum stability. No CW ID is provided since there are many and varied ways of accomplishing this depending on the hardware available in your particular circumstance. You should have little trouble adding one that suits your system. I built the 2ICTU for narrow-shift operation only, but have included the necessary parts for both narrow and wide shifts.

I won't bore you with a

lengthy technical description of the circuit since the schematic is pretty self-explanatory. I recommend that you obtain the excellent data sheets provided by EXAR when you get your ICs. They will provide all the information you might want about this device. Indeed, the circuit shown is basically taken from the applications part of these sheets.

Tune-up is best accomplished with an oscilloscope and a frequency counter. First, adjust the dc offset and the gain trimmers for the best looking sine wave at pin 2. Next apply +5 volts to the input and adjust the mark frequency trimmer for 2295 Hz at pin 2. Then ground the input and adjust the space timing trimmer for 2125 Hz at pin 2. If you included the parts for the 850-Hz shift, also adjust the mark frequency for it. Finally, readjust the dc offset and gain controls for the best looking output. Keep the gain at the minimum level that provides a clean signal.

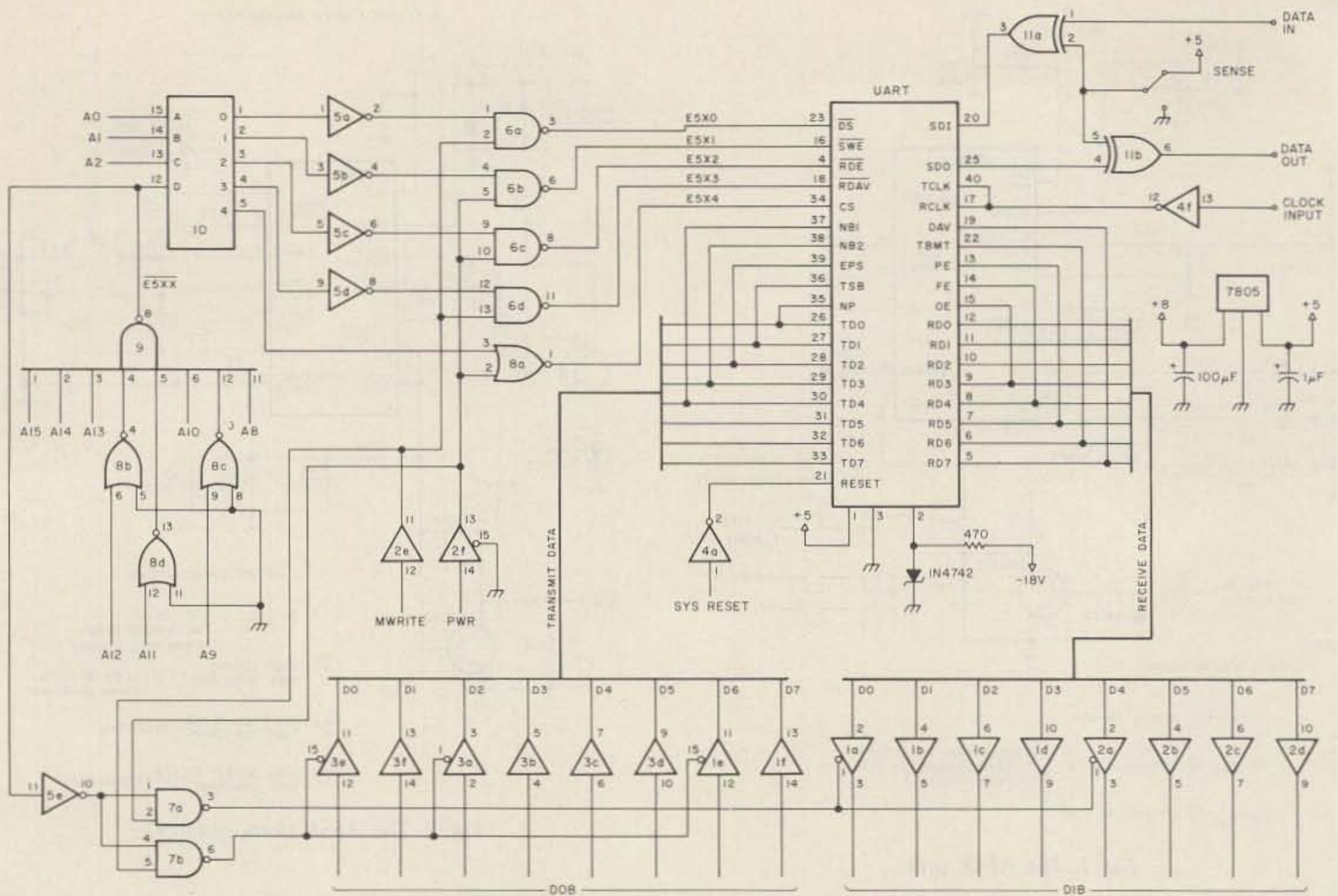

Fig. 3. The general-purpose serial port.

The 2206C provides an extremely stable and clean AFSK output. No distortion is introduced at the critical frequency transition point since the output is phase-continuous during this time.

The Demodulator

The demodulator circuit is as simple as the AFSK generator (see Fig. 2). I left plenty of space on my board for future filtering circuits but found that the built-in one

works so well that I just never got around to it. An EXAR IC does all the work again, but this time it is the 2211. Once again, I recommend that you obtain the data sheets with the IC. They contain a wealth of information and will give you all the technical data you might want.

capacitors should be polystyrene for maximum stability. My system required only TTL levels so I did not include the added complexity of an RS-232 output (although the AFSK unit will accept RS-232 input levels). If your port requires these levels, you will have to add the necessary parts.

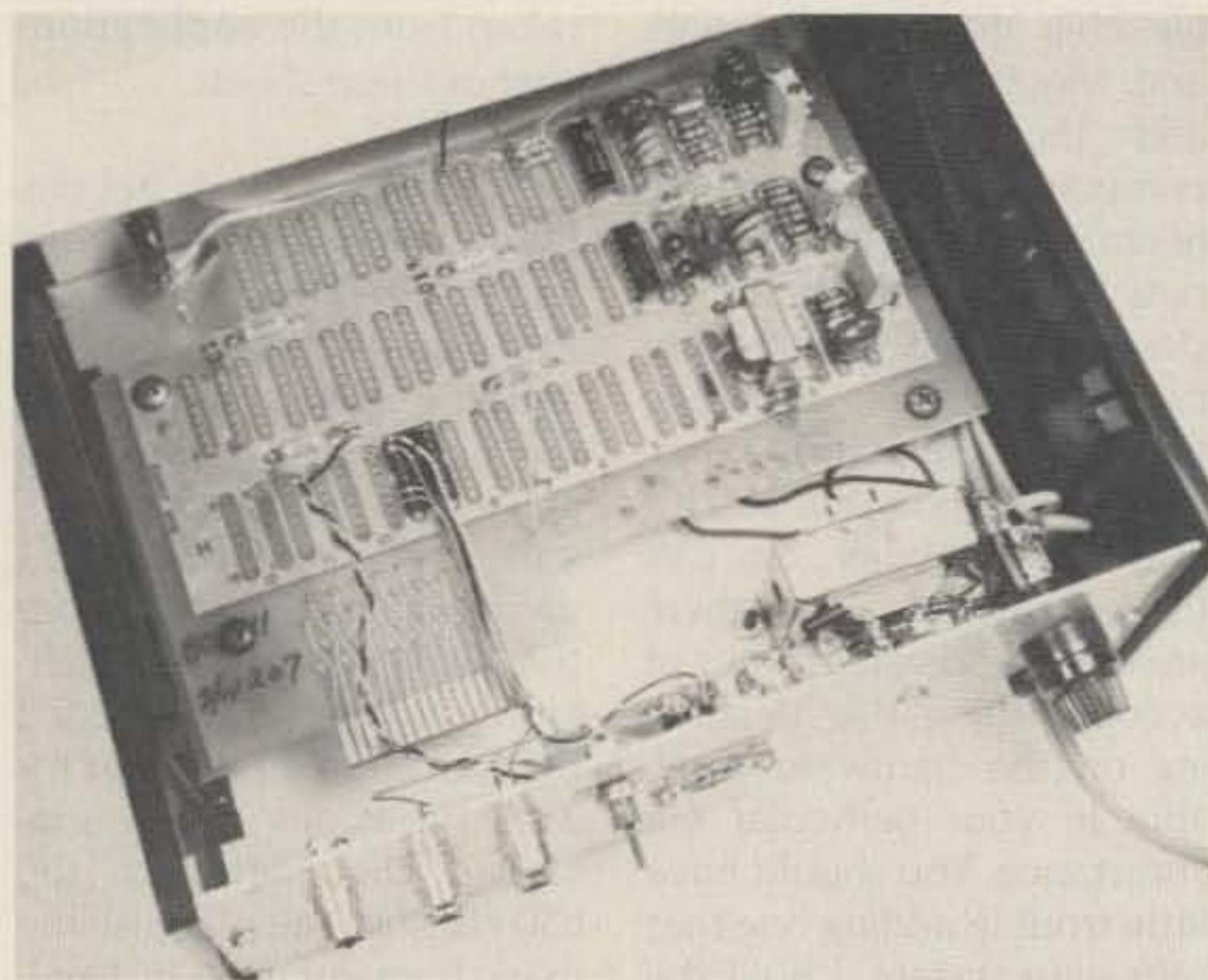

Photo C. The innards of the 2ICTU. As seen, there is plenty of room for expansion! The two EXAR ICs can be seen at the upper-right corner. In the lower-right corner is the 12-volt power supply. Just about anything will do since very little power is required.

The gang of capacitors hanging off pin 8 provides the necessary FSK data filtering. Calculated values for these things seldom come out near anything standard, so the parallel group gets us close. As before, timing ca-

To tune the demodulator you will need only a frequency counter to adjust the center frequency of the internal vco. You do this with the lock-detect filter disconnected and no input signal. The easiest way is to remove the IC from its socket (you did use sockets, didn't you?) and carefully bend pin 3 out just enough so that it is out of the socket when you plug it back in. Now jumper pins 10 and 2 together, apply power, and adjust the trimmer (or trimmers) for the correct frequency at pin 3. This will be 2210 Hz for narrow and 2550

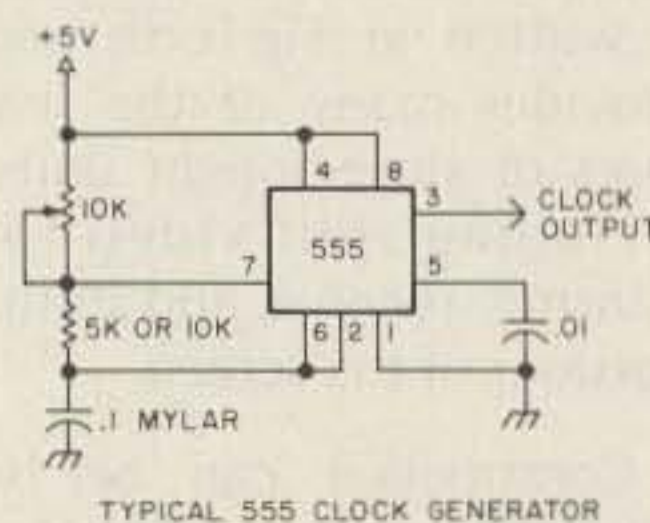

Fig. 4. Typical 555 clock generator.

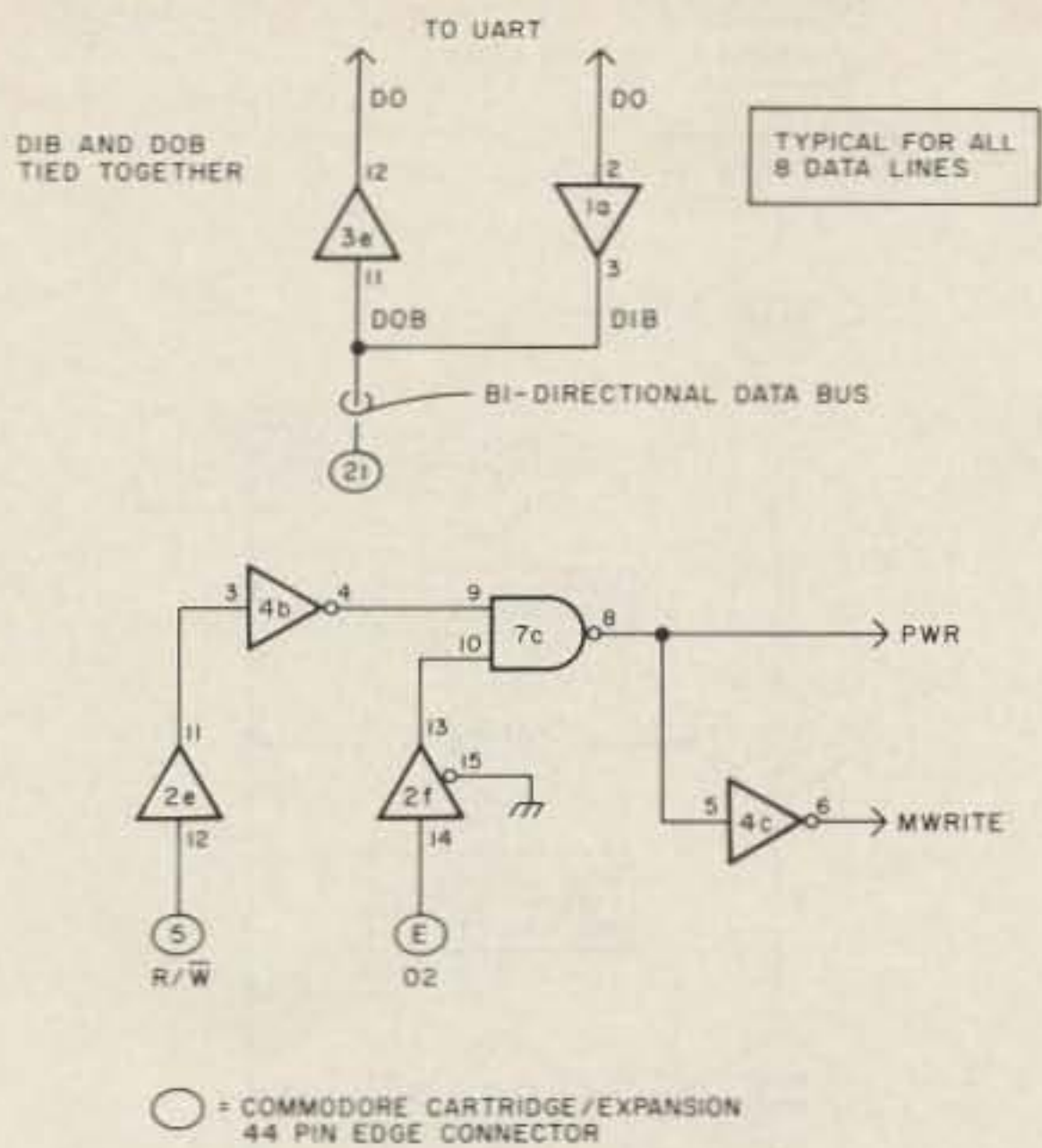

Fig. 5. Serial-port connection for Commodore computers.

Hz for wide shift. When done, restore pin 3 to its normal position.

In operation, tune the received signal until the lock-detect LED is on continuously. A flickering LED indicates improper tuning or a signal that is too weak. While the 2ICTU will certainly not match the performance of expensive commercial terminal units, I was quite surprised at how weak and noisy a signal the 2211 will copy. It does reasonably well even in QRM when the signal you wish to tune is stronger than the surrounding ones.

General-Purpose Serial Port

The serial port is not quite as simple as the 2ICTU (see Fig. 3). Still, it's pretty straightforward and not difficult to build. It uses a plain old garden-variety UART which does the majority of the work. The other ICs provide the necessary buffering and address decoding. The exclusive OR gates on the serial input and output provide for selectable "sense" on the RTTY signal.

The serial port as shown was designed for the S-100 bus. It does not, however, use the standard S-100 port-addressing method. I chose instead to implement it as a few memory addresses at

the unoccupied end of my RAM space. I prefer memory-mapped I/O, and it suits the 6502 microprocessor used in my system. If your computer uses all available memory space or if the addresses shown are used, you will have to revise the addressing scheme to suit your system.

The address decoding is done by ICs 8, 9, and 10. As shown, they decode one page of addresses between E500 and E5FF hex. Only 5 locations are actually used.

The first location, E500 hex, is the transmit-register buffer of the UART. Data written here is converted to serial output at pin 25 of the UART. The necessary start, stop, and parity bits are determined by the word previously stored in the control register at E504 hex.

The second location, E501 hex, is the UART's status register. Reading this address places the status of the UART's operations in the high 5 bits of the returned-data byte. The overrun, framing, and parity-error bits are returned in bits 3, 4, and 5 respectively. If any of these are set, an error is indicated. Bit 6 is the "transmit buffer empty" flag. This bit must be interrogated and must be true prior to writing any new data to the trans-

mit-register buffer at E500 hex. Bit 7 is the "data available" flag for received data. A true condition indicates that the UART has received a data word and it is available in the received-data buffer at E502 hex. Bits 0, 1, and 2 have no meaning. Bits 6 and 7 were chosen for the two busiest functions because they are simple to use for control of program execution in the 6502.

The third location, E502 hex, is the actual location of the received data. After determining that data is available, by bit 7 of E501 being true, a read of E502 returns the received-data byte.

After reading the received data, a write must be performed to location 4, E503 hex. This clears the data available flag for the next byte. The data written has no meaning since it is not actually used.

The fifth location, E504 hex, is the control register of the UART. A data word written here sets the various parameters required for the UART's operation. Bit 0 controls the use of a parity bit. When it is reset, or equal to zero, no parity is generated or checked. Bit 1 controls

the number of stop bits appended to each serial byte transmitted and the number checked on each received byte. Zero equals one stop bit, while a 1 equals two stop bits, or, in the case of 5-bit words, one and one-half stop bits. Bit 2 is used to choose even or odd parity when parity is selected via bit 0. Bits 3 and 4 determine the length of the transmitted or received word. 00 equals 5-bit words, 01 equals 6-bit words, 10 equals 7-bit words, and 11 equals 8-bit words. Bits 5, 6, and 7 are not used. The control register is write-only. Once a control word is stored here it will remain active until it is changed. For Baudot code, I normally store an 03 hex and for 8-bit ASCII I store 19 hex.

Parts of ICs 5, 6, and 8 are used to gate the appropriate read and write signals to the UART. Two gates of IC 7 and one from IC 5 are used to control which set of buffers is activated, depending on whether a read or write operation is being performed. IC 11 is used to control the sense of the transmitted and received word for true or inverted RTTY. The actual control is performed by a

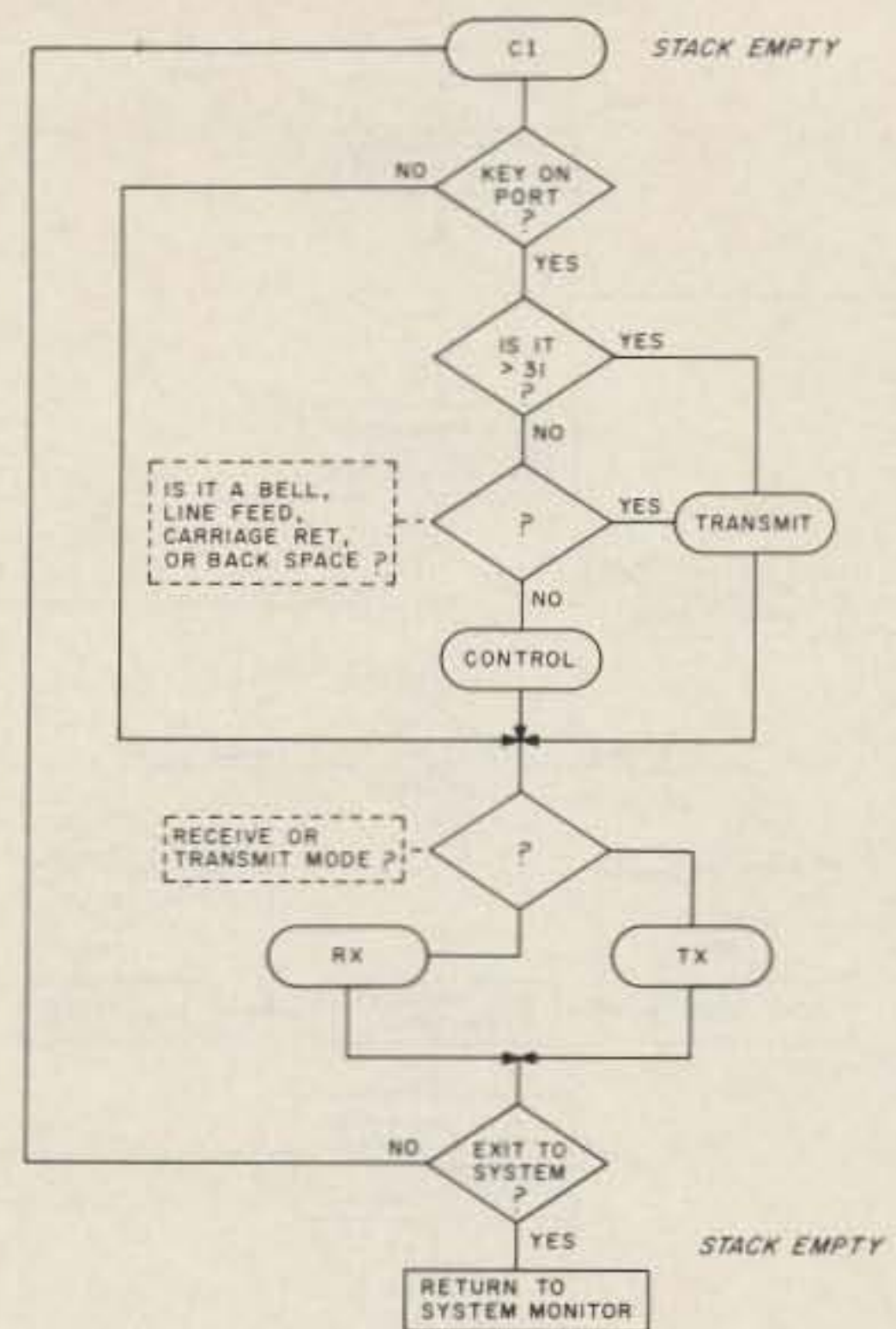

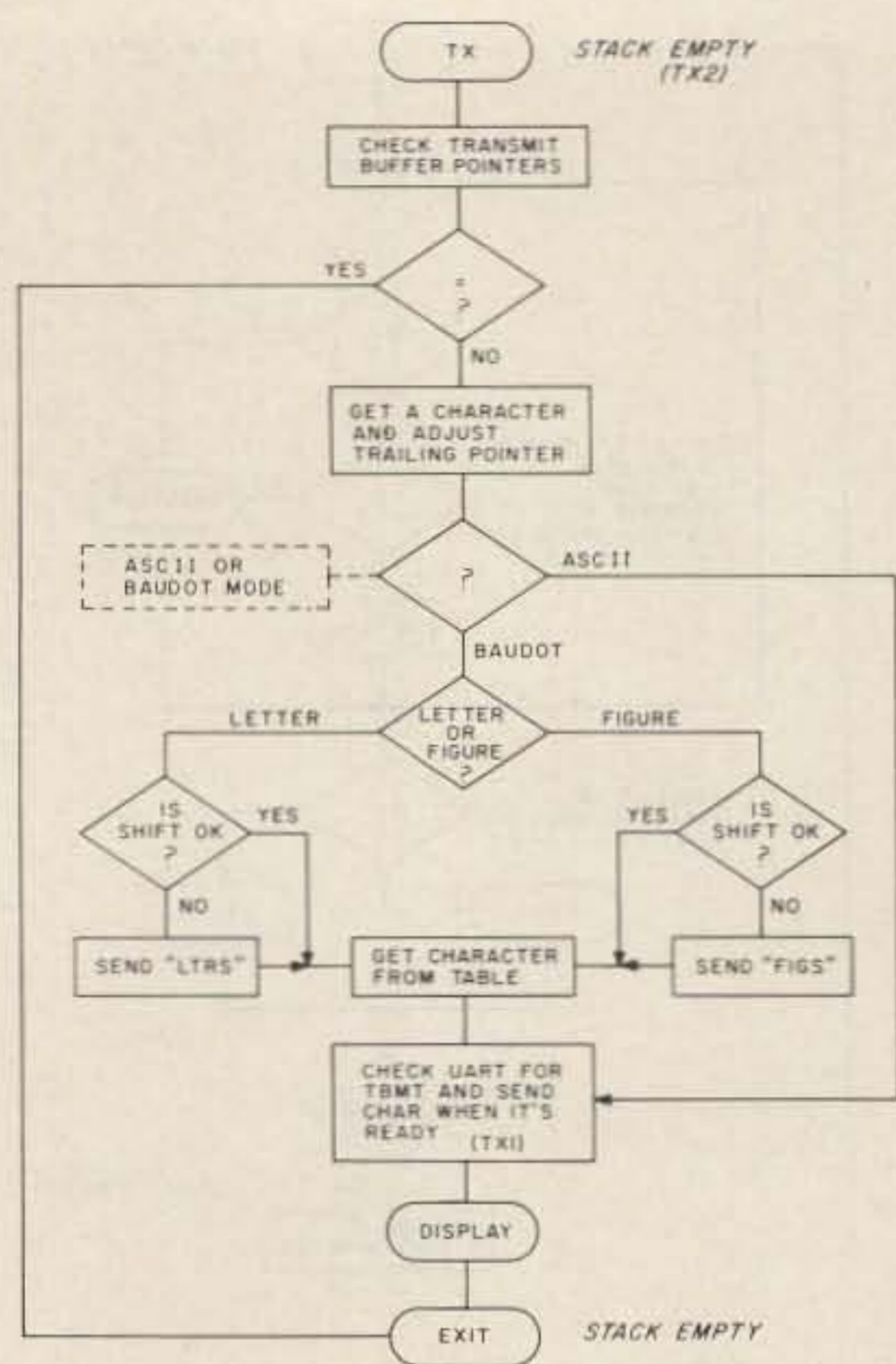

Fig. 7(a). The transmit module (TX).

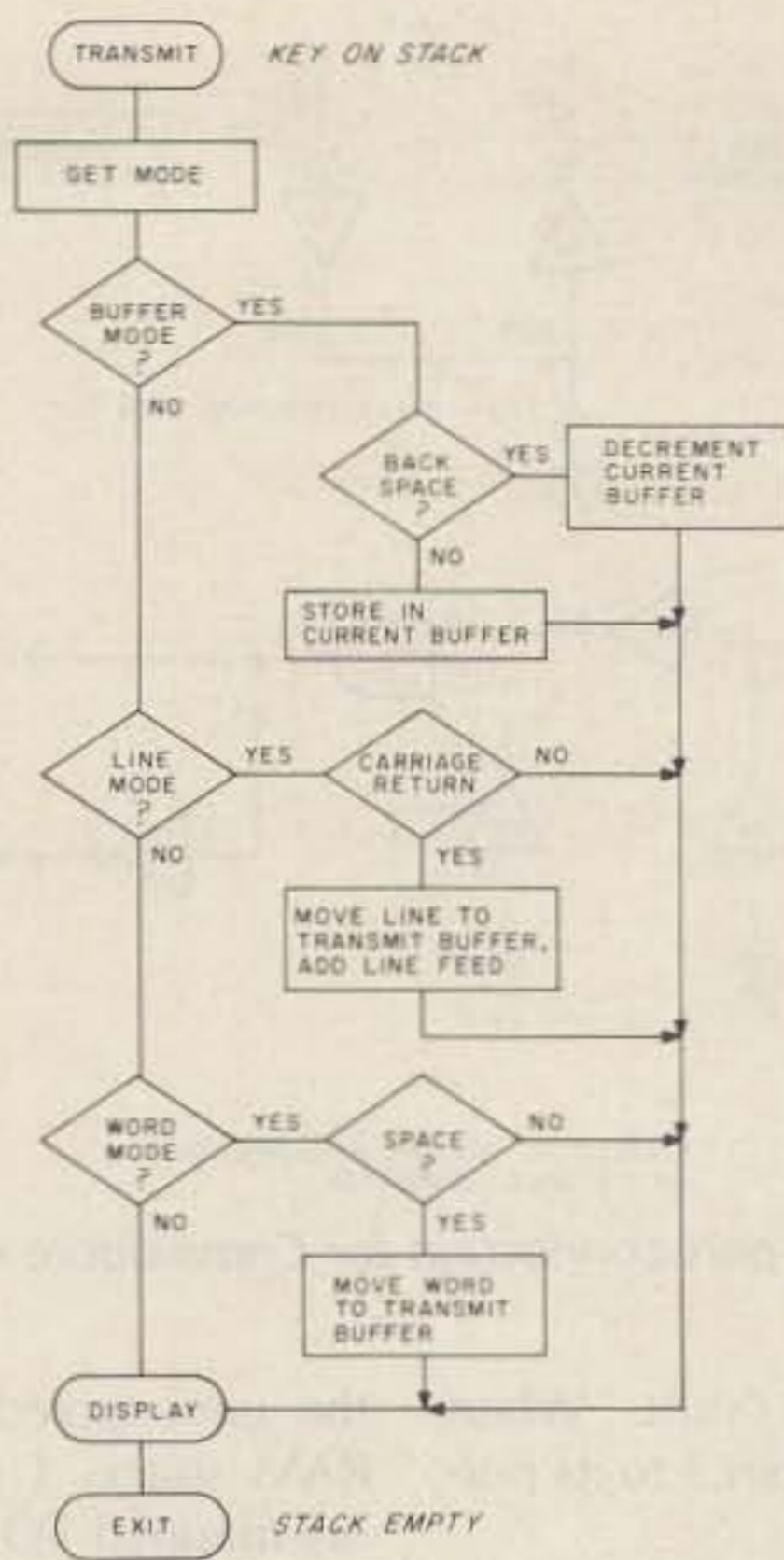

Fig. 7(b). The transmit-buffer control (TX).

SPDT switch located on the front (or in my case, the rear) panel of the TU. The data input, IC 11, pin 1, is connected to the FSK demodulator output and the data output (IC 11, pin 6) is connected to the FSK generator input.

I use 6522 VIAs for my system I/O. These are similar to the ports used in the Commodore 64 and VIC computers. The neat thing about these devices is that they each contain a pair of software-controllable timers. These timers are extremely useful, particularly where the 2ICTU is concerned. One of the timers can be configured to output a controlled square wave at bit 7 of the B port. By loading the appropriate 16-bit numbers in the count registers, I can generate any of the frequencies needed to operate the serial port for RTTY. The numbers I use for my 1-MHz system are 686 decimal for 60 words per minute (45 baud), and 282 decimal for 100 words per minute (110 baud). These numbers probably will differ on your system since no two clocks are ever quite the same. Differ-

ent timer types also require different approaches. I found that the best way to determine the correct figures was to connect a frequency counter to the output and experiment with different values until I found the ones that gave frequencies closest to the ones I desired.

If no timers are available on your system you will have to provide a 555 or similar type clock generator for each of the two popular baud rates. A typical circuit is shown in Fig. 4. The clock frequencies required are 16 times the baud rate or 720 Hz for 60 wpm and 1760 Hz for 100 wpm. Two separate 555s are easier because, as you can see, the two frequencies do not share a common multiple.

Those of you with Commodore computers can modify my serial port for your computers quite easily. It is necessary only to combine the two data buses (DIB and DOB) into a single bi-directional bus and to synthesize the S-100 MWRITE and PWR signals as shown in Fig. 5. Your system reset signal will work as is. The 6526

ports in the Commodore computers contain a pair of timers like those in the 6522. You should be able to use these by connecting pin C of your user port to the UART's clock input at pin 13 of IC 4. The timer will, of course, have to be configured and initialized by your software. To configure the timer, load a C0 hex into the auxiliary-control register. The ACR is located 11 (decimal) locations above the base address of the port. Then load the 16-bit-count word into the counter latches at base +6 (low order) and base +7 (high order). The timer is started by storing the high order count into base +5 and stopped by storing zero into the ACR (base +11) or by doing a reset.

Software

That brings us to the software required to make this minimal hardware perform like an expensive RTTY unit. As I stated earlier, my software for RTTY operation is written in Fig-Forth. I urge any of you thinking about trying Forth to do so. It is an excellent language for just

about any application. Like any new language, it may seem confusing and difficult to understand at first, but once you've worked with it for a while, you'll find it quite easy and natural to use. The RTTY program is contained in 25 screens of text. Each screen is a 1024-byte block of ASCII data arranged as 16 lines of 64 characters. I have included only the flowcharts with this article in the interest of keeping it compact.

For those who desire a complete listing, I can provide one if you send \$5.00 to cover the cost of duplication and mailing. Also, I can write the screens onto 8-inch disks for single-density CP/M or OS/2 systems if you send a disk and \$5.00. Obviously, the disk would only be of use to those of you with working versions of Forth. If you don't have Forth, or wish to try it, then you should be able to write the program from the flowcharts in your favorite language. Whatever language is used, it must be able to keep up with the many real-time events taking place si-

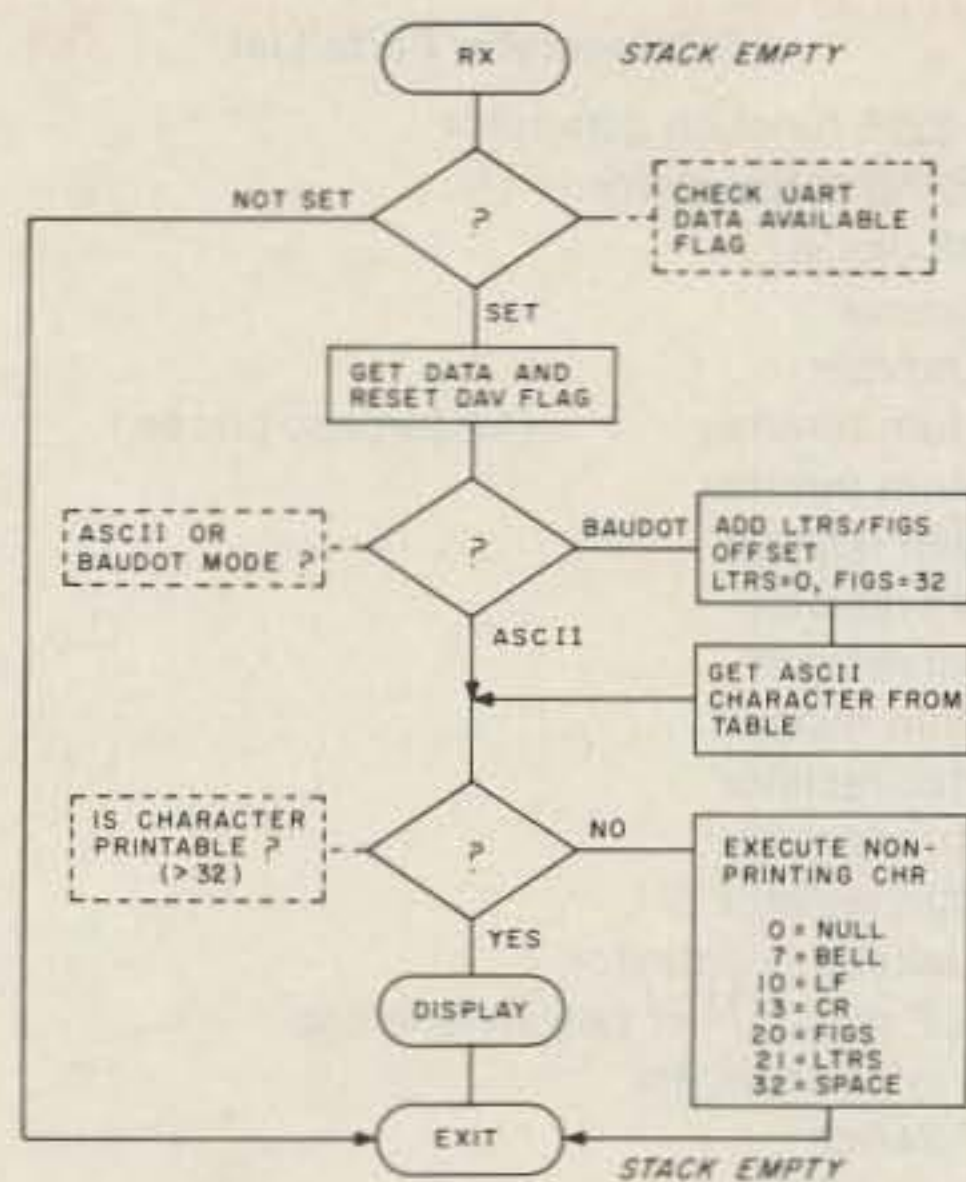

Fig. 8. The receiver module (RX).

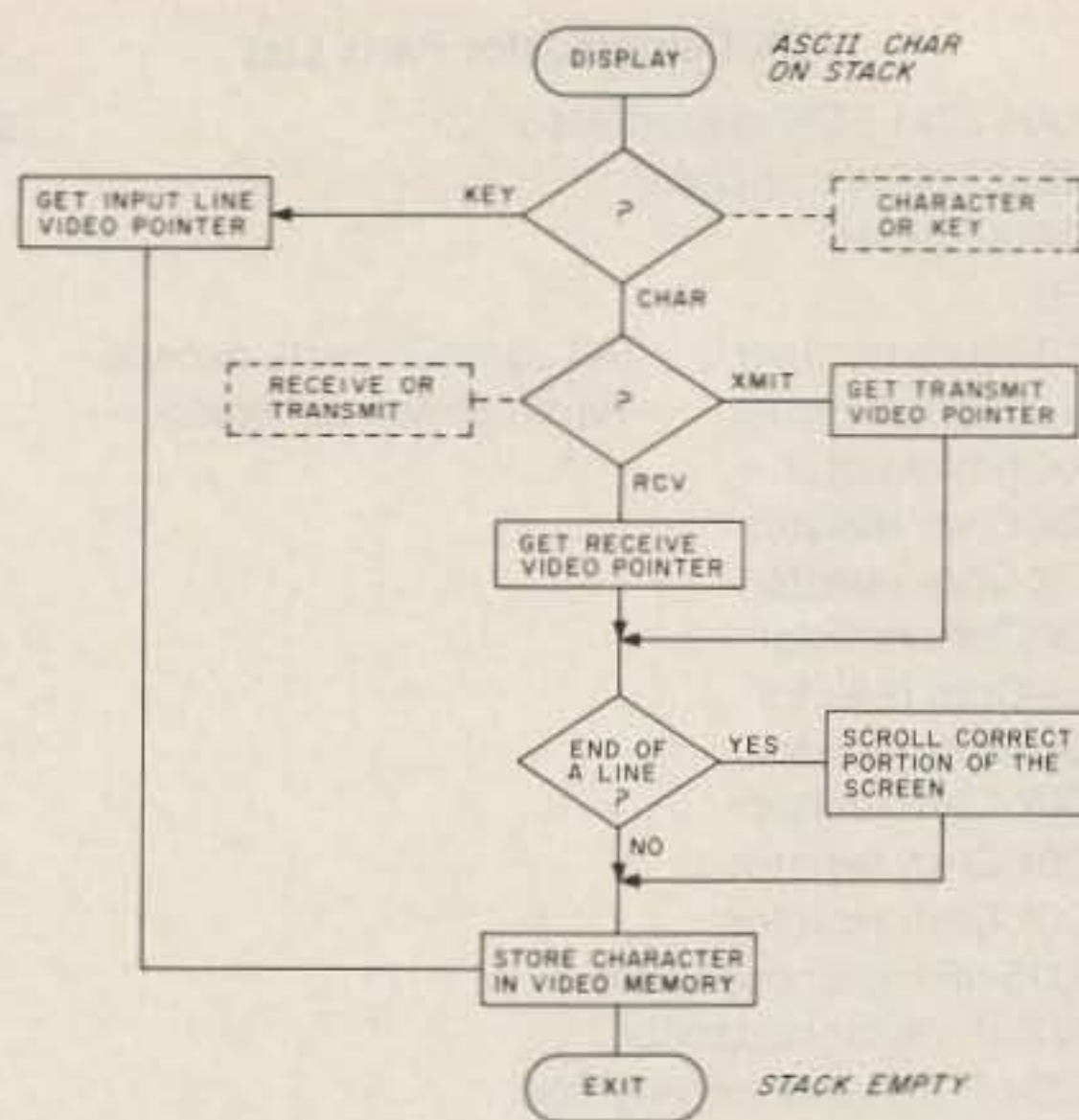

Fig. 10. The display module (DISPLAY).

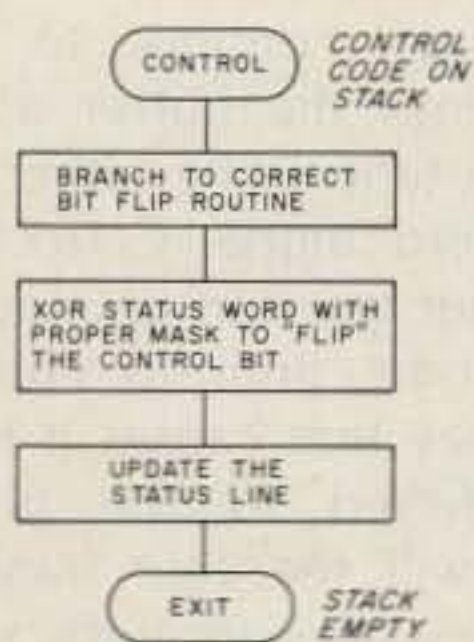

Fig. 9. The control module (CONTROL).

multaneously. A slower language may have to resort to interrupt routines in some key areas. Forth is fast enough that it can handle everything "on the fly."

The program consists of six main modules. These are named CI, TX, RX, CONTROL, DISPLAY, and TRANSMIT. CI is the command interpreter. TX is the routine that constructs the data byte to be transmitted. RX decodes the received byte and either displays it or executes some function. CONTROL accepts a control character from the keyboard and performs the requested action, such as changing baud rates, activating automatic unshift on space, etc. DISPLAY handles the printing of characters on the video monitor and the line printer. And finally, TRANSMIT keeps track of which buffer transmit data is stored in and taken from.

The heart of the program

is the command interpreter, or CI (see Fig. 6). All program functions begin and end here. CI's main task is to accept input from the keyboard and to take some action based on it. If no key is present, the routine examines a flag to see if we are currently transmitting data. If we are, it transfers control to TX to see if it is ready to send another character. If we're not transmitting, control is transferred to RX to see if it has a received-data byte for us. Both of these routines process one character at a time and then return to CI.

If CI detects a key input, it gets the key data and decides what to do with it. Certain control codes may be transmitted, so these are passed to TRANSMIT for placement in the current buffer. Other control codes tell the program what we would like to do, such as turning the printer on or off, changing the transmit buffer pointer, etc. These are passed to the CONTROL module. If the key data is not a control character, then it is passed directly to TRANSMIT which stores it in the current buffer for TX to send when its turn comes.

TX checks the current buffer pointer to see if there is anything for it to send—see Fig. 7(a). If there is not, it simply returns to CI. How-

ever, if there is, a number of things happen. First, we must check a flag to see if the intended transmission should be in Baudot or ASCII. If it's ASCII, we simply send it on its way since that's the way we stored it in the buffer. But if it's Baudot, we have some work to do first. We must look at the character and decide if it's a letter or figure. Once this is decided, we send the proper shift, if necessary, and then convert the ASCII character to its equivalent Baudot code. Finally, we send it on its way through the ether to the fellow ham anxiously awaiting it on the other end of the QSO. This is done by checking our UART for a "transmit buffer empty" condition and, when it's ready, simply storing the data byte at E500 hex. The UART then converts it to serial data and sends it to the 2ICTU where it is converted to the proper audio tones for transmission by your ham station. We also simultaneously show it on the transmitted-text portion of the video monitor and print it on the printer if so desired.

When RX (Fig. 8) is called by CI, it first looks at the UART status register to see if a received character is ready. If not, it exits immediately back to CI. If it does find the data-available flag set, it gets the character

from E502 hex and then resets the DAV flag by writing to E503 hex. RX now checks to see how it is to interpret this data byte. It must first decide if it's ASCII or Baudot. If it's Baudot, we must determine if it is a letter or figure, then convert it to the correct ASCII code. Now we have to determine if it's a control character or a printable character. If it's control, we take the appropriate action, and if not, we pass it to the display module. The display routines print it in the received-text portion of the video screen and, if hard copy is desired, on the printer.

CONTROL (Fig. 9) accepts legal control codes and sets the desired parameters to direct the decisions required of all the other routines. It does this by maintaining a 16-bit status word which is used by the other modules. Each bit of the status word represents a control function's current status. The other modules simply have to examine this status word to decide how they are to perform. All control functions are "toggle type." This means that they can be accessed at any time during program execution since all we have to do is "flip" them. The next time the bit is examined, the proper adjustment in operation is made. I am currently using only 7 of

FSK Demodulator Parts List

1	EXAR 2211 FSK demodulator IC	\$ 3.95
1	2N2222 NPN transistor	.17
2	1N4148 diode	.14
1	LED	.20
1	2k 10-turn trimmer (All Jameco parts except	1.19
1	5k 10-turn trimmer Radio Shack generator.)	1.19
1	1k-Ohm resistor	.06
1	5.8k-Ohm resistor	.06
1	8.2k-Ohm resistor	.06
2	10k-Ohm resistor	.12
1	15k-Ohm resistor	.06
1	60k-Ohm resistor	.06
1	100k-Ohm resistor	.06
1	120k-Ohm resistor	.06
2	520k-Ohm resistor	.12
2	.0015-uF mylar capacitor	.30
1	.022-uF mylar capacitor	.13
2	.022-uF mylar or polystyrene	.26
1	.01-uF mylar	.12
3	.1-uF mylar	.81
1	14-pin socket	.43
1	SPDT switch	1.49
1	8-Ohm to 1000-Ohm audio transformer	1.29
1	2N3905 PNP transistor (or 2N3906)	.20

the 16 available bits. Bit zero is used as a letters/figures flag by the transmit routines. Bit 1 indicates that the buffer mode is engaged. Bit 2 determines line or word mode. Bit 3 activates the Baudot unshift on space feature. Bit 4 is used to control the printer. Bit 5 is the receive/transmit indicator, and bit 6 tells us if we're in ASCII or Baudot mode. In addition, there are control inputs to choose the transmit buffer and to change the baud rate. The last thing CONTROL does before returning to CI is to update the status line at the top of the video monitor. This line always shows the current status of all switches and activities.

The DISPLAY module (Fig. 10) receives characters from the other modules and prints them in the proper location on the video monitor, and on the line printer if so requested. My system uses memory-mapped video so that it was relatively simple to set up the split-screen display. If you use a serial terminal, you will have to write a display module to suit your hardware. My screen is split into four sections. The top line is the status line, as mentioned before. It is dis-

played in reverse video so that it will stand out. This is followed by a blank line and then 8 lines of receive space. Beneath the receive space is another blank line and then 4 lines that display data as it is being transmitted. The very bottom line is the transmit-buffer input line.

In use, you simply select the operating mode you desire and then have fun. While in receive mode, you can watch text as it comes in and type your response into one of the transmit buffers

Serial Port Parts List

1	1602 or equal UART	\$ 4.95
2	74LS00 IC 6 and 7	.50
1	74LS02 IC 8	.25
2	74LS04 IC 4 and 5	.50
1	74LS30 IC 9	.29
1	74LS42 IC 10	.55
1	74LS86 IC 11	.39
3	74LS367 IC 1, 2, and 3	1.47
1	4742 zener diode	.23
1	7805 voltage regulator	1.35
1	heat sink	.39
1	100-uf electrolytic 16 V	.24
1	1-uF tantalum 35 V	.29
6	.1-uF ceramic bypass	.48
1	SPDT switch	1.49
7	14-pin WW sockets	3.15
4	16-pin WW sockets	2.76
1	40-pin WW socket	1.99

Miscellaneous connectors and cable wire-wrap card to suit your system

FSK Generator Parts List

1	EXAR 2206 function generator	\$ 3.95
1	2N2222 NPN transistor	.17
1	1N4148 diode	.07
2	10k trimmer	2.20
1	100k trimmer	1.10
1	5k 10-turn trimmer (All Jameco prices.)	1.19
2	2k 10-turn trimmer	2.38
1	220-Ohm resistor	.06
1	3k-Ohm resistor	.06
1	6k-Ohm resistor	.06
2	7.5k-Ohm resistor	.12
1	15k-Ohm resistor	.06
1	27k-Ohm resistor	.06
1	56k-Ohm resistor	.06
2	1-uF tantalum capacitor	.58
2	.0222-uF mylar TM or polystyrene cap	.24
1	.1-uF mylar capacitor	.27
1	SPDT switch	1.49
1	16-pin socket	.47
1	Enclosure of your choice	—
1	12-V-dc power supply	—

to send when your turn comes. I have 3 buffers on my system, but more can easily be added. I have one large one (500 bytes) for general text and two smaller ones for specific information such as QTH, rig, etc. The transmit-buffer pointer is circular which means that typing the key to increment the pointer to the next buffer eventually gets you to the one you want. The status line keeps you informed as to which one is active. You can then either fill that buffer or send it as desired. When your turn comes to transmit, you simply type a control T to start sending.

You can continue to type text into the buffer at the same time using either line or word mode. Corrections to your text can be made at any time prior to entering the key that causes it to be transferred to the buffer. You will see your transmitted text appear on the video just as it is being sent. All controls are always available to you at any time during operation of the program. This makes for quite convenient operating.

That pretty well covers the 2ICTU and the RTTY software that makes it perform. This was a very rewarding project from both the hardware and software standpoints. The modular approach to both also provides a very flexible system, one which can grow and change as desired. I will be glad to respond to any questions or comments if you will be so kind as to include an SASE.

I think you will find the 2ICTU a very convenient way to try the fascinating world of radioteletype without spending too many of those hard-earned dollars. Even if you are not interested in the 2ICTU, the serial port has many other uses, such as driving printers, modems, and the like. 73. ■

BARTER 'N' BUY

Individual (noncommercial) 25¢ per word
Commercial 60¢ per word

Prepayment by check or money order is required with your ad. No discounts or commissions are available. Please make your payment to 73. Rates for multiple insertions are available on request.

Advertising must pertain to amateur radio products or services. No special layouts or positions are possible. All advertising copy must be submitted typewritten (double-spaced) and must include full name and address. Copy limited to 100 words, maximum. Count only words in text. Address, free.

73 cannot verify advertising claims and cannot be held responsible for claims made by the advertiser. Liability will be limited to making any necessary corrections in the next available issue.

Copy must be received in Peterborough by the 5th of the second month preceding the cover date.

Make checks payable to 73 Magazine and send to: Jim Gray, Advertising Department, 73 Magazine, 80 Pine St., Peterborough NH 03458.

MOBILE IGNITION SHIELDING. Free literature. Estes Engineering, 930 Marine Drive, Port Angeles WA 98362. BNB006

MILITARY TECHNICAL MANUALS for old and obsolete equipment. 60-page catalog, \$3.00. Military Technical Manual Service, 2266 Senasac Ave., Long Beach CA 90815. BNB045

HAM RADIO REPAIR, tube through solid state. Robert Hall Electronics, PO Box 8363, San Francisco CA 94128; (408)-729-8200. BNB219

QSLs to order. Variety of styles, colors, card stock. W4BPD QSLs, PO Drawer DX, Cordova SC 29039. BNB260

THE DX'ERS MAGAZINE. Up-to-date, informative, interesting. Compiled and edited by Gus Browning W4BPD, DXCC Honor Roll Certificate 2-4. Send for free sample and subscription information today. PO Drawer DX, Cordova SC 29039. BNB261

CASH PAID for traffic/speed radar equipment. Write or call: Brian R. Esterman, PO Box 8141, Northfield IL 60093; (312)-251-8901. BNB271

FIND OUT what else you can hear on your general-coverage transceiver or receiver.

Join a shortwave radio listening club. Complete information on major North American clubs and sample newsletter, \$1.00. Association of North American Radio Clubs, 1500 Bunbury Drive, Whittier CA 90601. BNB310

INDIVIDUAL PHOTOFAC FOLDERS: #1 to #1400, \$3.00 postpaid. AJL, 414 Chestnut Lane, East Meadow NY 11554. BNB312

IMRA—International Mission Radio Association. Forty countries, 800 members. Assists missionaries with equipment loaned, weekday net. 14.280 MHz, 2:00-3:00 pm Eastern. Brother Bernard Frey, 1 Pryer Manor Road, Larchmont NY 10538. BNB326

ELECTRON TUBES: receiving, transmitting, microwave all types available. Large inventory means next-day shipment in most cases. Daily Electronics, PO Box 5029, Compton CA 90224; (213)-774-1255. BNB330

RADIO TRANSCRIPTION DISCS WANTED. Any size, speed. W7FIZ, Box 724—WG, Redmond WA 98073-0724. BNB347

CABLE CONVERTERS. Lowest price. Dealer inquiries accepted. Quantity discounts. Free catalog. P.G. Video Corp., 61

Gatchell St., Dept. 73, Buffalo NY 14212. BNB349

TR-7 USERS—NB-7 noise blanker, new, \$65 ppd. SL-300 CW filter, new, \$50 ppd. HS-75 headset by Drake, new, \$14 ppd. Tony Musero K3UKW, (215)-271-8898. BNB380

CABLE TV CONVERTERS and equipment. Plans and parts. Build or buy. Free information. C & D Electronics, PO Box 1402, Dept. 73, Hope AR 71801. BNB383

QSL CARDS: 100 for \$5.00, 500 for \$18.00. For a sample, send an SASE to Ken Hand WB2EUF, PO Box 708, East Hampton NY 11937. BNB388

KENWOOD 430S OWNERS! Stop 430S scanner on busy frequencies. When clear, resume automatically! Squelch-activated! Reviewed QST 6/85, 73 2/85, Worldradio 12/84. \$19.95; \$29.95 assembled. \$2.50 shipping. JABCO Stop Scan, R1 Box 386, Alexandria IN 46001. BNB396

SSB SQUELCH for any radio! Improved circuitry! Active filters! 2 1/2" x 5 1/2". \$54.95 plus \$2.50 shipping. JABCO Squelch-It, R1 Box 386, Alexandria IN 46001. BNB397

SURPLUS AND MORE SURPLUS. Thousands of items, free bargain-packed flyers. ETCO Electronics, Plattsburgh NY 12901. BNB399

BUILD A COMPUTER-AIDED-DESIGNED 6-dB stacked vertical omnidirectional 2-meter antenna for less than \$50.00 using hardware-store materials. Send \$5.00 for detailed plans and parts list. John De Armond WD4OQC, PO Box 3657, Cleveland TN 37311. BNB400

73 MAGAZINE SALE. All issues from start to date. 303 magazines! \$100, you pay shipping. Joe Strollin, 21 Ellen St., Norwalk CT 06851. BNB403

XEROX MEMORYWRITER—parts, assemblies, boards, manuals. Free help with service problems. W6NTH, Box 250, Benton AR 72015; (501)-776-0920. BNB404

DIGITAL AUTOMATIC DISPLAYS for FT-101s, TS-520s, Collins, Swan, and all oth-

ers. Six 1/2" digits. 5" wide by 1-1/4" high metal cabinet. \$1.00 for information. Be specific. Grand Systems, Dept. A, PO Box 3377, Blaine WA 98230. BNB405

VHS T-220+ VIDEOCASSETTES. Instructions and detailed plans for "rolling your own" from readily available materials. \$4.00 postpaid. Pete Haas, PO Box 702, Kent OH 44240. BNB406

DOCKING BOOSTERS, the most fantastic HT accessory, only \$129.95! Digital-display swr meters and bar-graph power-output indicators, only \$84.95! Hi-Mound keying mechanisms, most extensive line of straight keys, paddles, and mobile keys! Write for free catalogue of specialized communications products. Skywave Radio Systems, PO Box Q-1, 943 Boblett, Blaine WA 98230. BNB407

HAPPY NEW YEAR from the crew at Junior High School 22 on Manhattan's Lower East Side. Be a winner in '86! Send us your QSL via WB2JKJ and we might send you our QSL Of The Week Award. BNB408

EXPERT REPAIRS. ICOM, Motorola, GE, Yaesu, Kenwood, Johnson. Tone board installed. FCC licensed. \$39.50/hr. 2-hour maximum without prior approval. Ship via UPS or US Postal Service to Aston Lee, 144-07 Sanford Avenue, Apt. 1A, Flushing NY 11355. BNB409

WANTED: Motorola HT-220s and HT-100s, VHF or UHF. PO Box 4344, Chatsworth CA 91313. BNB410.

RK4D32 TUBES, \$35.00 each. Inquire on others. Wanted: Gonset aircraft monitor, reasonable. Levy, 101 East Driftwood #26, Fredericksburg TX 78624; (512)-997-2534. BNB411

HAM TRADER YELLOW SHEETS, in our 24th year. Buy, swap, sell ham-radio gear. Published twice a month. Ads quickly circulate—no long wait for results. SASE for sample copy. \$10.00 for one year (24 issues). PO Box 2057, Glen Ellyn IL 60138-2057. BNB412

WANTED: ICOM IC-SP2 speaker, AN/URA-17A, support brackets, and plug sets. C. T. Huth, 229 Melmore St., Tiffin OH 44883. BNB413

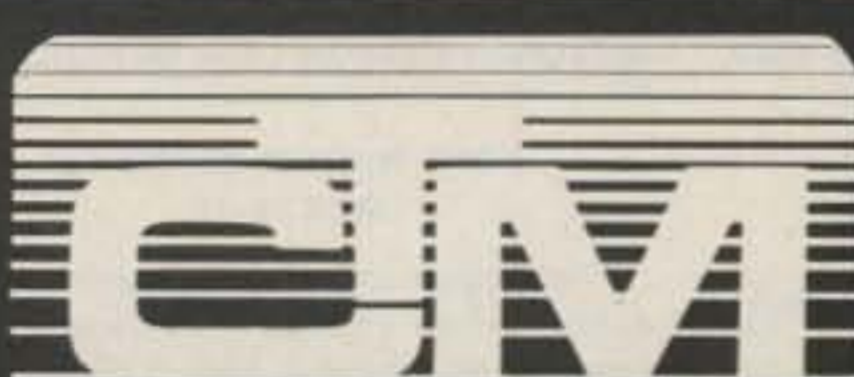

"...received my moneys worth with just one issue..."
—J. Trenbick

"...always stop to read CTM, even though most other magazines I receive (and write for) only get cursory examination..."
—Fred Blechman, K6UGT

U.S.A.	\$15.00 for 1 year
Mexico, Canada	\$25.00
Foreign	\$35.00(land) - \$55.00(air)
(U.S. funds only)	
Permanent (U.S. Subscription)	\$100.00
Sample Copy	\$3.50

CHET LAMBERT, W4WDR
1704 Sam Drive • Birmingham, AL 35235
(205) 854-0271



The Mean Little Kit

This 24-piece kit of computer/electronic tools includes 7 screwdriver sizes, adjustable wrench, 2 pair pliers, wire stripper, knife, alignment tool, stainless rule, hex key set, scissors, 2 flexible files, burnisher, soldering iron, solder aid, coil of solder, and desoldering braid. Highest quality padded zipper case measures approximately 6 x 9 x 1-3/4" inside. Send check or money order, or charge VISA or MASTERCARD. We pay the shipping charges. Guaranteed satisfaction. Free tool catalog on request.

Order JTK-6 \$88.00

Jensen Tools Inc.
Dept. 158 7815 S. 46th St.
Phoenix, AZ 85044-5399 (602) 968-6231

MAKE CIRCUIT BOARDS THE NEW, EASY WAY



WITH TEC-200 FILM

JUST 3 EASY STEPS:

- Copy circuit pattern on TEC-200 film using any plain paper copier
- Iron film on to copper clad board
- Peel off film and etch

convenient 8 1/2" x 11 size
With Complete Instructions
SATISFACTION GUARANTEED
5 Sheets for \$3.95 10 Sheets only \$5.95
add \$1.00 postage NY Res. add sales tax

The MEADOWLAKE Corp.
Dept. 3, P.O. Box 497
Northport, New York 11768

SPECIAL EVENTS

Listings in this column are provided free of charge on a space-available basis. The following information should be included in every announcement: sponsor, event, date, time, place, city, state, admission charge (if any), features, talk-in frequencies, and the name of whom to contact for further information. Announcements must be received by 73 Magazine by the first of the month, two months prior to the month in which the event takes place. Mail to Editorial Offices, 73 Magazine, Pine St., Peterborough NH 03458.

SOUTH BEND IN JAN 5

A hamfest will be held on January 5, 1986, at Century Center, on US 33 North between the St. Joseph Bank Building and the river, downtown South Bend IN. Table space is \$1.00 per foot. Talk-in on .52/.52, .99/.39, .93/.33, .69/.09, and 145.29. For more information, contact Wayne Werts K9IXU, 1889 Riverside Drive, South Bend IN 46616; (219)-233-5307.

WAUKESHA COUNTY WI JAN 11

The West Allis Radio Amateur Club will sponsor the Midwinter Swapfest on Saturday, January 11, 1986, beginning at 8:00 am, at the Waukesha County Expo Center Forum. Take I-94 to Co. F, south to FT, and west to Expo. Admission is \$2.00 in advance and \$3.00 at the door. Four-foot tables are \$3.00 in advance, \$4.00 at the door. For tickets or more information, send an SASE to WARAC Swapfest, PO Box 1072, Milwaukee, WI 53201.

VA STATE FAIRGROUNDS JAN 12

The Richmond Amateur Telecommunications Society will sponsor the ninth annual Richmond Frostfest on Sunday, January 12, 1986, from 8:30 am to 3:30 pm, at the Virginia State Fairgrounds. Admission is \$4.00. Flea-market spaces are \$4.00; \$8.00 with an 8-foot table. VEC exams will be held on Saturday. For more information, write the Richmond Frostfest, PO Box 1070, Richmond VA 23208, or call Bill Scruggs N4DDM at (804)-272-8206.

OAK PARK MI JAN 12

The Oak Park ARC will sponsor a radio swap on Sunday, January 12, 1986, from 7:30 am to 4:00 pm, at Oak Park High School, 14300 Oak Park Boulevard, Oak Park MI 48231. For more information, contact David Lefko WB8RGQ, 875 S. Pontiac Trail #103, Walled Lake MI 48088.

HOSARC 13TH JAN 19

The Hall of Science Amateur Radio Club will operate special-event stations using

the call WB2JSM on January 19, 1986, from 1500 to 2100 UTC, to commemorate HOSARC's thirteenth anniversary. SSB operation will be in the first 25 kHz of the 40-, 20-, 15-, and 10-meter General phone bands. CW operation will be in the first 25 kHz of the 80-, 40-, 15-, and 10-meter Novice bands and in the first 5 kHz of the 30-meter band. For a commemorative certificate, QSL with a large SASE (44 cents or 1 IRC) to HOSARC QSL Manager, Arnie Schiffman WB2YXB, 81-22 250th Street, Bellrose NY 11426.

YONKERS NY JAN 26

The Yonkers Amateur Radio Club will hold an electronics auction on Sunday, January 26, 1986, from 9:00 am to 3:00 pm, at Lemko Hall, 556 Yonkers Avenue, Yonkers NY. Admission is \$3.00; children under 8 are free. Inspection is from 9:00 am to 10:00 am and the auction will begin at 10:00 am. Talk-in on 146.865/R, 440.150/R, and 146.52. For more information, contact the YARC, 53 Hayward Avenue, Yonkers NY 10704; (914)-969-1053.

SOUTHFIELD MI JAN 26

The Southfield High School ARC will hold its 20th annual Swap and Shop on January 26, 1986, from 8:00 am to 3:00 pm, at Southfield High School, 24675 Lahser, Southfield MI. Admission is \$2.50. Two 8-foot reserved tables are \$20.00. Each additional table is \$10.00. For more information, write Robert Younker, Southfield High School, 24675 Lahser, Southfield MI 48034.

TEACHER IN SPACE JANUARY

The Concord Brasspounders ARC will operate W10C to commemorate Christa McAuliffe's teacher-in-space flight of the space shuttle. Operation will be from 1300 UTC on Saturday to 1259 UTC Sunday during the first weekend following the launch of the shuttle with Christa aboard. Anticipated launch date is January 22, 1986. Suggested frequencies are: phone—7.285, 14.285, 21.385; CW—7.050, 14.050, 21.050; Novice—7.105. For a certificate, send an SASE to W10C, PO Box 2214, Concord NH 03301.

BATTLE OF KWAJALEIN AND ROI-NAMUR FEB 1-10

The Kwajalein Amateur Radio Club will

operate special-event station KX6BU from 0600 UTC on February 1, 1986, until 0600 UTC on February 10, 1986, to commemorate the 42nd anniversary of the Battle of Kwajalein and Roi-Namur. Frequencies will be: SSB—28.550, 21.350, and 14.250; CW—28.050, 21.050, 14.050, and 7.025. For \$6.00, stations working KX6BU will be issued a certificate, a QSL, and a 64-page book describing the Battle of Kwajalein and Roi-Namur. \$3.00 will bring a QSL and a certificate. All requests should be sent to: KX6BU, Box 444, APO San Francisco 96555-008.

PUNXSUTAWNEY PHIL FEB 2

The Punxsutawney Amateur Radio Club will operate special-event station KA3CUY on Sunday, February 2, 1986, beginning at 9:00 am EST, to commemorate Groundhog Day 1986. Frequencies are 3.950 and 7.230 MHz ± QRM. KA3CUY will carry a recording of the official proclamation for the next 6 weeks' weather (as determined by Punxsutawney Phil). For a certificate, send a QSL and a large SASE to PARC, RD 5, Box 14, Brookville PA 15825.

ST. CATHARINES ONT FEB 8

The Niagara Peninsula ARC will hold its annual hamfest and flea market on Saturday, February 8, 1986, beginning at 8:00 am, at the UAW Hall, Bunting Road, St. Catharines, Ontario. Talk-in on 147.240/.840. For more information, contact NPARC, Box 692, St. Catharines, Ontario L2R 6Y3, Canada.

MARLBORO MA FEB 16

The Algonquin ARC will hold its annual hamfest/electronic flea market on Sunday, February 16, 1986, beginning at 10:00 am, in the Marlboro Junior High School cafeteria. Admission is \$1.00. Tables are \$7.50 in advance and \$10.00 at the door. Seller setup begins at 8:30 am. Talk-in on .01/.61 and .52. For reservations or more information, contact the AARC, PO Box 258, Marlboro MA 01752; (617)-393-9920.

SPOONER WI FEB 16

The Wild Rivers ARC will hold its mid-winter swapfest on Sunday, February 16, 1986, from 10:00 am to 3:00 pm, at the Spooner Experimental Farm, east of Spooner WI on Highway 70. Exams will be given. Tables are available. Talk-in on 147.81/.21. For more information, contact Tom Young KD9FC, Route 5, Box 5239, Hayward WI 54843.

MANSFIELD OH FEB 16

The Mansfield Midwinter Hamfest/Auc-

tion will be held on Sunday, February 16, 1986, beginning at 7:00 am, at the Richland County Fairgrounds, Mansfield OH. Admission is \$3.00 in advance and \$4.00 at the door. Tables are \$5.00 in advance and \$6.00 at the door. Talk-in on 146.34/.94 (W8WE). For tickets or more information, contact Dean Wrasse KB8MG, 1094 Beal Road, Mansfield OH 44905; (419)-589-2415 after 3:00 pm EST.

FRIDLEY MN FEB 22

The Robbinsdale ARC will sponsor the fifth annual Midwinter Madness Hobby Electronics Show on February 22, 1986, from 7:00 am to 2:00 pm, at Totino-Grace High School, 1350 Gardena Avenue NE, Fridley MN. Admission is \$3.00 in advance and \$4.00 at the door. 8-foot tables are \$8.00; 1/2 tables are \$4.00. Exams will be given. Talk-in on 147.60/.00 (K0LTC) and .52 simplex. For more information or to register, contact the Robbinsdale ARC, PO Box 22613, Robbinsdale MN 55422, or call Bob at (612)-533-7354.

GLASGOW KY FEB 22

The Glasgow Swapfest will be held on Saturday, February 22, 1986, beginning at 8:00 am, at the Glasgow Flea Market Building, two miles south of Glasgow KY, just off Highway 31E. Admission is \$2.00; no extra charge for exhibitors. The first table is free, and each additional table is \$3.00. Talk-in on 146.34/.94. For more information, contact Mike Goad N4HCO, Route 4, Box 354, Glasgow KY 42141.

CHICOPEE MA MAR 2

The Mount Tom Amateur Repeater Association will hold its annual flea market on March 2, 1986, from 8:00 am to 3:00 pm, at the Knights of Columbus Elder Council 69, Granby Road, Chicopee MA. Admission is \$1.00; ladies and children under 12 are free. Tables are \$7.00 in advance and \$8.00 at the door. For more information, contact MTARA, PO Box 3494, Springfield MA 01101.

ST. LOUIS MO MAR 14

The Jefferson Barracks ARC will sponsor its 26th annual amateur-radio auction on Friday, March 14, 1986, beginning at 7:30 pm, at Concordia Turners Hall, 6432 Gravois, St. Louis MO. For more information, contact the Jefferson Barracks ARC, 1624 Union Road, St. Louis MO 63125.

FORT WALTON BEACH FL MAR 15-16

The Playground ARC will hold its 16th annual North Florida Ham/Swapfest on Saturday and Sunday, March 15-16, 1986, at the fairgrounds, Fort Walton Beach FL. Admission is \$3.00; XYLs and children are free. Tables will be available. Talk-in on 146.19/.79. For more information, contact Hud Huddleston KF4BU, 925 Forest Avenue, Fort Walton Beach FL 32548; (904)-862-2566.

WIRELESS REMOTE CONTROL EXTENSION SYSTEM
XTRA-LINK™

Control your TVRO, VCR, or CABLE TV from Any Room!

Works on most infrared controlled devices. Immediate Shipping — Wholesale & Retail

MERRIMAC
SATELLITE 608-493-2291
MERRIMAC, WI 53561

VISA MASTERCARD DISCOVER

TO ORDER & INFO

NEW 20-PAGE CATALOG FREE

7 MILLION TUBES

Includes all current, obsolete, antique, hard-to-find receiving, transmitting, industrial, radio/TV types. **LOWEST PRICES.** Major brands in stock.

Unity Electronics Dept. S
P.O. Box 213, Elizabeth, N.J. 07206



PORTAQUADS

2-MTR & 220 MHz
FOLDS INTO CASE CA. ADD
SPECIFY BAND \$73.95 6% TAX

RADIO ENGINEERS
3941 MT. BRUNDAGE AVE.
SAN DIEGO CA. 92111



MOBILE ANTENNA HOTLINE
(919) 226-0496

Mobile 2M Antennas: 1/2-wave w/mag mount	\$19.95	
1/4-wave w/mag mount	\$12.95	
2M Base Station Antenna: 1/2-wave Ground Plane w/mast bracket	\$15.00	
Mobile HF Antennas (less mount)	\$13.95 ea.	
#9180-75M	#9130-30M	#9115-15M
#9140-40M	#9120-20M	#9110-10M
MOUNTS for Mobile HF	\$13.95	
#240 Bumper strap mount	\$10.75	
#240 Bumper clip mount	\$10.75	
#274 Side body mount for trucks and campers	\$6.95	
#243 Mount for fiberglass body	\$13.95	

MOBILE ANTENNAS & ACCESSORIES
(Div. of AC/DC Electronics)
Route 1, Box 406C Burlington, NC 27215

LETTERS

WISE UP

I just read Rick C. Wilson's letter, "I Hate Code" (73, March, 1985). I wonder if Rick would hate the code so much if he knew that by passing a few code tests (he says he already knows a lot about electronics) he could command a cushy job on a world-ranging freighter.

I wonder how much he would hate the code if a military conflict should rear its ugly head.

Sure, it's tough to apply your butt to a hard chair and try to copy the stuff when it's dot for dot and dash for dash. Once it gets learned, though, it opens up a whole new world. Get yourself wised up, Mr. Wilson.

Paul L. Schmidt W9HD
Bloomfield IN

STOP HIDING

I love my simplex autopatch. There, I said it and I'm glad. Now that it's out of the closet, let the other hams enjoying this delightful device stop hiding and not feel guilty in its use.

I fully realize that the incorrect use of simplex autopatch (on, say, 2 meters) can lead to an abuse of our privileges, but I feel that the proven maturity of licensed amateur-radio operators will prevail and it will be used properly.

A lot of misunderstanding, traced to cliquish repeater groups who found their uniqueness in offering patches, is now ended. They may feel that this privilege shall only belong to them—how dare an individual try to bypass them!

I'm tired of reading of the restrictions in advertising that the manufacturers of simplex devices must follow, and above all, I dislike the reluctance of the ham fraternity to openly discuss their use.

Answering the phone while driving is as much fun as DXing, contesting, or any other facet of our hobby. Besides, we are only using one frequency versus the repeater using two. With the BSR

touchtone™ appliance controller, I can call my phone and have the unit shut off, thus satisfying FCC requirements.

Don't put restrictions on its use. There is enough room in the spectrum for everybody.

Mike Herbstman KM2F
New York NY

RE DISPLAY REPLAY

I cannot help but wonder what Roger Grandbois ("Letters," October, 1985) was trying to prove. Mr. Grandbois, manufacturer of digital display systems, was so determined to belittle the "What You See is Where You're At" frequency-display project (73, July, 1985) that he overlooked the more obvious virtues of the project. To me, it seems apparent that the purpose of the project was to provide the experimenter/builder with an inexpensive solution to the problem of display resolution as opposed to the purchase of a more advanced receiver or commercial display adapter. The prescribed project executes this task like a champ. Nevertheless, Mr. Grandbois insists on stating the obvious shortcomings of the project while espousing his own product.

As presented, the July '85 project does exhibit change in sidebands and will only work on single-mix superheterodyne receivers. True, these problems exist. But with the use of moderate circuit additions, the frequency display will find a place in more complicated applications. It is a fair assumption that any experimenter with a reasonable understanding of radio receivers will arrive at the same conclusion. Carl Anderson ("Letters," October, 1985) provided us with a modification of the display's counting direction. This modification furthers the applications of Mr. Miller's project. Undoubtedly, some other ingenious Gus will engineer additions that will beat the aforementioned technical problems.

I was inspired and taught by radio amateurs of the "old school." That is the prac-

tice of construction and experimentation. Mr. Miller provided a fine construction article of a very practical project. My fellow radio builders will agree.

Mark Foltarz KA4JYV
Tampa FL

Mark—Good news! Thomas Miller has designed a "universal" version of his display. Look for it in an upcoming issue of 73.—KW10.

MORE! MORE!

I was fascinated by Victor Layton's article, "Above Intercept," in the October, 1985, issue. I was a flight-control officer at Watton during the time the event took place.

The 25th Bomber Group was a most unusual group in the 8th Air Force. Besides the undercover work that Layton wrote about, we also helped to perfect blind-bombing techniques, LORAN, and Mickey. We did photo and weather reconnaissance and were pathfinders for bomber missions. If there was anything secretive to be done, I'm sure we did it. (As a small point of digression, I should state that President Roosevelt's son, Elliott, was our commanding officer.)

I wrote to Mr. Layton and sent him a lot of history and information about the 25th Bomber Group at Watton, and he sent back a nice reply. I'm sure he could tell many more exciting stories. "Above Intercept" was a departure from the usual technical articles and brought back a feeling of nostalgia. More! More!

William Bernstein KA2OVR
Great Neck NY

FULL ADVANTAGE

If we are to attract new people to amateur radio, we need to be able to demonstrate that we know how to use the privileges that we have to our full advantage. One improvement that would benefit the beginner would be to establish a national CW calling frequency in the middle of the 10-meter Novice band, 28.150 MHz.

Henry J. Hampel KA0TUP
St. Louis MO

TO K7UGA:

Dear Senator Goldwater:

I share your concerns over the declining (and aging) amateur-radio population, and I agree with your proposed alternatives to a no-code license; these proposals are echoed almost everywhere in the ham literature.

What bothers me is that two critical points have not yet (to my knowledge) been addressed. Without careful consideration of these points, we may be solving the *wrong* problem, and we may be doing irreparable harm to amateur radio as a result.

1. I keep hearing that the average age of a licensed amateur-radio operator is near 46, and that it is increasing more than one year, each year.

Averages, by themselves, can be very misleading. I have never seen a standard deviation, nor have I seen a comparison to a population of non-hams with the same sexual, geographic, and economic distributions. I'm not a statistician, but would these data show us that hams are actually increasing their population relative to the one above? Would these data perhaps illuminate the reasons for decline? Why am I the only ham asking these questions?

2. The problem is not limited to amateur radio: Robert Burnham said (see "Forum," September, 1985, *Astronomy Magazine*), "If we don't get the children interested in astronomy, there'll be no next generation of astronomers." Within the last six months, *Live Steam Magazine* (a voice of model steam-engine enthusiasts) published bar charts and graphs based on profiles of club members' records from around the country. The projections (don't let the oily fingernails fool you; their presentation was the best I've seen) clearly showed that they were in a dying hobby if something wasn't done about it, and pretty soon.

I am writing to you, Senator, and sending copies to every major amateur-radio publication because I want my concerns to be considered by a majority of hams *before* we make changes to our hobby.

I believe we may make a hasty, disastrous change to amateur radio unless we examine *our* problem more closely, and examine *the* problem more carefully.

Alex Vrenios KX9I
Mundelein IL

FUN!

John Edwards KI2U
PO Box 73
Middle Village NY 11379

SATELLITES REVISITED

I'm reluctant to admit this, but I think that I'm becoming something of an audio voyeur. In a way, I think most hams are. After all, shortwave listening is nothing more than audio voyeurism, and "copying the mail," be it on a repeater or on the HF bands, falls into the same general category.

But I believe I've probably taken audio voyeurism to its ultimate limit. As regular "Fun!" readers know, a few months ago I acquired a satellite-TV system. After a few weeks of watching Peruvian-rules football, music videos in Esperanto, and Dr. Gene Scott, I began to yearn for something a bit more esoteric. It was at that point that I

discovered the world of SSB on C-band satellites.

A friend told me that if I hooked a good-quality communications receiver, like my Kenwood R-100, to the baseband output of my satellite receiver, I could pick up all sorts of interesting signals transmitted on SSB. The sort of signals, my friend claimed, that are far more interesting than the exploits to be found each evening on F4, 12. Better yet, he said, each transponder offers 36 MHz of frequency space. Yes, friends, 36 MHz on some 16 satellites, each with approximately 24 transponders. That's equivalent to 384 HF spectrums!

This is where my audio voyeurism comes in. As you probably know, most long-distance telephone calls are transmitted by satellite these days. What you may not know, however, is that many of the satel-

lites used are the same ones that home satellite installations receive. Therefore, a satellite earth station connected to an SSB receiver results in a lot of interesting listening.

The Communications Act of 1934, as amended, prohibits listeners from divulging the contents of telephone communications. However, if you happen to accidentally tune across these signals, as I often do, and you happen to hear some really juicy conversations, as I often do, there isn't very much the FCC can do about it. After all, as a radio amateur, I have a definite need to tune across the complete spectrum of most satellite transponders, and if in the course of my technical explorations I happen to hear some heavy breathing going on, it isn't my fault. Let MCI, AT&T, and the others scramble their transmissions, I'm going to continue my experimentation. I'll keep quiet, but I'll keep listening.

So there you have it. Audio voyeurism taken to its limit. As for me, I'm just waiting for Picturephone to make its grand return (heh-heh).

ELEMENT 1 MULTIPLE CHOICE

1) How wide is a standard US baseband video signal?

- 1) 4.0 MHz 3) 14 MHz
2) 4.2 MHz 4) 40 MHz

2) Satellite receivers typically use GaAsFET transistors. The acronym GaAsFET stands for:

- 1) Gallium Arsenide Field Effect Transistor
2) Gallic Arsenic Field Effect Transistor
3) Germanium Arsenide Field Effect Transistor
4) Gas Arsenic Field Effect Transistor

3) In a satellite receiver, a phase-locked-loop (PLL) circuit is often used as:

- 1) a video enhancement circuit
2) a low-noise amplifier
3) a composite video generator
4) an FM demodulator

4) DOMSATS:

- 1) are operated by AT&T
2) are operated by RCA
3) are operated by COMSAT
4) is a generic term for domestic satellites

5) Name the 73 Magazine columnist who founded his own national TV system on the Turks and Caicos Islands.

- 1) Bill Gosney
- 2) Chod Harris
- 3) Robert Baker
- 4) Bob Cooper

ELEMENT 2 TRUE-FALSE

- | | True | False |
|--|-------|-------|
| 1) A satellite's "foot-print" refers to its signal strength at various points on the earth's surface. | _____ | _____ |
| 2) The "look angle" is the angle above the horizon at which a satellite signal arrives at an earth station's location. | _____ | _____ |
| 3) Geosynchronous satellites are immobile. | _____ | _____ |
| 4) "Shrouding" is a synonym for "dish." | _____ | _____ |
| 5) "Sky noise" is a type of man-made interference. | _____ | _____ |
| 6) "Adaptive deviation multiplex" is a satellite video format. | _____ | _____ |

- 7) Teletext and videotex are usually transmitted on the vertical blanking interval (VBI) of a satellite-TV signal. _____
- 8) US satellites can only transmit NTSC video. _____
- 9) In microwave reception the term "TI" usually stands for "terminated interconnect." _____
- 10) Dishes roughly two meters in diameter are routinely used for video reception. _____

ELEMENT 3 SCRAMBLED WORDS

Unscramble these words relating to satellites:

- | | |
|------------|---------------|
| POMRCAATRO | RRRBUSCAIE |
| HOFNEERD | RATSLET |
| PACES | KAIN |
| ROCAS | BRITO |
| OORRT | RETDOWNNREVOC |

ELEMENT 4 FILL IN THE BLANK

- 1) "Sun outages" occur _____ a year.
- 2) Small dishes have a _____ beamwidth.

- 3) Large dishes have a _____ beamwidth.
- 4) The driven element in a microwave antenna can also be called a _____.
- 5) One uses a _____ to convert a satellite's microwave signal to a VHF frequency.

THE ANSWERS

- Element 1:**
1—2, 2—1, 3—4, 4—4, 5—4.
- Element 2:**
1—True If you're outside of the footprint, you can't receive the satellite's signal.
2—True And where you point your antenna.
3—False They move at 7,000 miles per hour, the same rate at which the earth rotates.
4—False Walls or screens around a dish that prevent side interference.
5—False Microwave radiation that comes from deep space.
6—False It's a method used for transmitting stereo audio signals.
7—True It's those little white dots you see on the black line between the picture frames.
8—False They can also handle PAL, SECAM, and the rest.
9—False Terrestrial interference.

10—False Usually for data or audio reception.

Element 3:
(Reading from left to right): COMPARATOR, SUBCARRIER, FEEDHORN, TELSTAR, SPACE, ANIK, OSCAR, ORBIT, ROTOR, DOWNCONVERTER.

Element 4:
1—twice
2—wide
3—narrow
4—probe
5—downconverter

SCORING

Element 1:
Five points for each correct answer.

Element 2:
Two and one-half points for each correct answer.

Element 3:
Two and one-half points for each correct answer.

Element 4:
Two and one-half points for each correct answer.

How did you do?
1-20 points—Beyond the horizon
21-40 points—Suffering from a sun outage
41-60 points—Minimal reception
61-80 points—Some sparklies
81-100 points—Closed-circuit copy

73 AWARDS

Bill Gosney KE7C
2665 North Busby Road
Oak Harbor WA 98277

It's hard to believe the years which have passed since our initial announcement of the famous 73 Awards Program portfolio. Since its introduction by yours truly, KE7C, in 1979, we've seen the program grow to become one of the most sought-after challenges facing amateurs today!

Consisting of six domestic and five DX operating achievements, the program has captured the interest of rag-chewers, DXers, and contesters alike.

The requirements for each award are not as easy as one might first imagine. Once you qualify for an award, you know for sure you've earned it. Here are the five DX awards:

DX COUNTRY CLUB AWARD

1. Available to licensed amateurs and SWL stations worldwide.
2. To be valid, all claimed contacts must be made in a single calendar year (January 1 through December 31), beginning January 1, 1979.
3. This award is issued for phone, CW, and mixed-mode. Should the applicant wish to recognize a single-band or mixed-band accomplishment, he must state his preference when making application.
4. A minimum of 73 DX countries must be worked and confirmed from the 73 Magazine WTW (Work the World) DX Listing.
5. Annual endorsement stickers are available for each succeeding year in which application is made and a minimum of 73 DX countries are worked.
6. To apply, prepare a list of claimed contacts in prefix order. Include each station's callsign, date and time of contact in UTC, mode, and band of operation.
7. Do not send QSL cards. Have your list

of contacts verified by two amateurs or a notary public.

8. Award fee is \$5.00 for each award. Do not send IRCs or foreign currency. Endorsements are granted for a fee of \$2.50. Checks on foreign banks must be payable in US funds.

9. Forward your application and fee to: Bill Gosney KE7C, 73 Awards Manager, 2665 N. Busby Road, Oak Harbor WA 98277.

DX CAPITALS OF THE WORLD

1. This award is made available to licensed amateurs and SWL stations throughout the world.
2. All claimed contacts must be made on or after January 1, 1979. There are no band or mode restrictions. Special recognition will be given for single band or mode if requested at the time application is made.
3. To qualify, applicants must work and confirm a minimum of 50 different national capital cities in the world. Only capital cities of those countries appearing on the WTW DX listing qualify. Should a country be contacted and its capital city not commonly be known, go ahead and list it in your application. The awards editor reserves the right to make a final determination.
4. To apply, make a list of contacts in prefix order. Indicate the station callsign, date and time in UTC, band and mode of operation, the name of the national capital city, and the DX country.
5. Do not send QSL cards. Have your list of contacts verified by two amateurs or a notary public.
6. Award fee is \$5.00 and must be payable in US funds. IRCs or foreign currency can no longer be accepted.
7. Forward your application and award fee to: Bill Gosney KE7C, 73 Awards Manager, 2665 N. Busby Road, Oak Harbor WA 98277.

TEN-METER DX DECADE AWARD

1. The 10-Meter DX Decade Award is made available to licensed amateurs and SWL stations worldwide.
2. All contacts must be made on the 10-meter band using only low-power (20 Watts of output or less) equipment. External amplifiers may not be used.
3. To be eligible, all contacts must be made on or after October 1, 1978. Contacts may be made on AM, SSB, CW, or 10-meter FM. Mixed-mode contacts may also be claimed. Crossmode contacts do not qualify.
4. To qualify, a minimum of ten DX countries must be worked from the WTW DX Listing. Endorsements will be given for 25, 50, 75, and 100 confirmed countries.
5. To apply, prepare a list of claimed contacts in prefix order. Include the callsign of each station worked, the date and time in UTC, band, mode, and a brief description of the equipment used in making each contact.
6. Do not send QSL cards. Have your application verified by two amateurs or a notary public.
7. Award fee is \$5.00 in US funds only. Sorry, we cannot accept IRCs or foreign currency. Endorsements are \$2.50 each.
8. Forward your application and award fee to: Bill Gosney KE7C, 73 Awards Manager, 2665 N. Busby Road, Oak Harbor WA 98277.

SPECIALTY COMMUNICATIONS ACHIEVEMENT AWARD (CLASS A-1)

1. This is made available to licensed amateurs and SWL stations throughout the world.
2. To be eligible, all contacts must be made on or after January 1, 1979. Only communications via SSTV, RTTY, EME (Earth-Moon-Earth), and/or OSCAR will be recognized for award credit. Contacts between stations on OSCAR and EME may be made using the mode authorized in your country. Mixed-mode contacts are not valid, however.
3. To qualify, applicants must work a minimum of ten DX countries from the WTW DX Countries Listing. Special recognition will be made for those exceeding the ten-country minimum.

ognition will be made for those exceeding the ten-country minimum.

4. To apply, prepare a list of claimed contacts in callsign prefix order. Include the date and time in UTC, the band and mode of operation, and a description of your equipment and antenna system used to make the contacts.

5. Do not send QSL cards. Have your list of contacts verified by two amateurs or a notary public.

6. The award fee is \$5.00 in US funds only. IRCs or foreign currency is not acceptable. Foreign checks must be payable in US funds.

7. Forward your application and award fee to: Bill Gosney KE7C, 73 Awards Manager, 2665 N. Busby Road, Oak Harbor WA 98277.

SPECIALTY COMMUNICATIONS ACHIEVEMENT AWARD (CLASS A)

1. Available to licensed amateurs and SWL stations throughout the world, this award requires all contacts be made on or after January 1, 1979.
2. Only communications via SSTV, RTTY, EME (Earth-Moon-Earth), and/or OSCAR satellite will be recognized for this award. Contacts between stations on OSCAR and EME may be made using any authorized mode allowed in your country. Mixed-mode contacts are not valid.
3. To qualify, applicants must work and confirm contact with each of the 50 US states. There are no band requirements. Specific band accomplishments will be recognized, however, if requested at the time application is made.
4. To apply, the applicant must prepare a list of claimed contacts in alphabetical order by state. Include the date and time in UTC, the band and mode of operation, and a description of the equipment and antenna system used.
5. Do not send QSL cards. Have your list verified by two amateurs or a notary public.
6. Award fee is \$5.00 in US funds only. Sorry, we cannot accept IRCs or foreign currency.
7. Forward your application and award fee to: Bill Gosney KE7C, 73 Awards Man-

WORK THE WORLD DX LISTING

AFRICA

A2 Botswana
 C5 Gambia
 C9 Mozambique
 CN Morocco
 CN2 Tangier
 CR3 Guinea Bissau
 CT3 Madeira Is.
 D2, 3 Angola
 D4 Republic of Cape Verde
 D6 Comoros
 EA8 Canary Islands
 EA9 Ceuta and Melilla
 EA9 Ifni
 EA9 Rio de Oro
 EL Liberia
 ET2 Eritrea
 ET3 Ethiopia
 FB8W Crozet
 FB8X Kerguelen Is.
 FB8Z Amsterdam & St. Paul
 FH Mayotte
 FR Glorioso Island
 FR Juan de Nova, Europa
 FR Reunion
 FR Tromelin
 H5 Bophuthatswana
 IG Lampedusa Island
 IH Pantelleria Is.
 J2, FL8 Djibouti
 S7 Seychelles
 S8 Transkei
 S9 Sao Tome and Principe
 ST Sudan
 ST0 South Sudan
 SU Egypt
 TJ Cameroon
 TL Central African Empire
 TN Congo
 TR Gabon
 TT Chad
 TU Ivory Coast
 TY Benin
 TZ Mali
 VK0 Heard Island
 VQ9 Aldabra Island
 VQ9 Chagos (Diego Garcia)
 VQ9 Desroches
 VQ9 Farquhar
 XT Upper Volta
 ZD7 St. Helena
 ZD8 Ascension Island
 ZD9 Gough Island and
 Tristan de Cunha
 ZE, Z2 Zimbabwe
 ZS1, 2, 4, 6 South Africa
 ZS2 Prince Edward Island
 ZS2 Marion Island
 ZS3 Southwest Africa
 (Namibia)
 3B6, 7 Agalega & St. Brandon
 3B8 Mauritius
 3B9 Rodriguez Island
 3C Equatorial Guinea
 3C0 Annobon
 3D6 Swaziland
 3V Tunisia
 3X Republic of Guinea
 3Y Bouvet Island
 5A Libya
 5H Tanzania
 5N Nigeria
 FR Malagasy Republic
 5T Mauritania
 5U Niger
 5V Togo
 5X Uganda
 5Z Kenya
 6O Somali
 6W Senegal
 7P Lesotho
 7Q Malawi
 7X Algeria
 8Q, VS9 Maldivian Islands
 9G Ghana
 9J Zambia
 9L Sierra Leone
 9Q Republic of Zaire
 9U Burundi
 9X Rwanda

EUROPE

C3 Andorra
 CT Portugal
 CT2, CU Azores

DA-DL

DM, DT, Y2-9 Federal Republic of Germany
 EA German Democratic Republic
 EA6 Spain
 EI Balearic Islands
 EJ0 Republic of Ireland
 F Aran Is.
 FC France
 G Corsica
 GD England
 GI Isle of Man
 GJ, GC Northern Ireland
 GM Jersey
 GM Scotland
 GM Orkney Oslands
 GM Shetland Islands
 GU, GC Guernsey
 GW Wales
 HA Hungary
 HB Switzerland
 HB0 Liechtenstein
 HV Vatican
 I Italy
 IC Ischia
 IA Tuscan Archipelago
 IS Sardinia
 IT Sicily
 JW Bear Is.
 JW Svalbard Is.
 JX Jan Mayen
 LA Norway
 LX Luxembourg
 LZ Bulgaria
 M1, 9A San Marino
 OE Austria
 OH Finland
 OH0 Aland Is.
 OJ0 Market Reef
 OK Czechoslovakia
 ON Belgium
 ON Faeroe Islands
 OZ Denmark
 PA Netherland
 SM Sweden
 SP Poland
 SV Greece
 SV Crete
 SV Dodecanese
 SV Mount Athos
 TF Iceland
 UA, UK1, 3, 4, 6 European RSFSR
 UA1, UK1 Franz Josef Land
 UA2, UK2F Kaliningradsk
 UB, UK, UT, UY5 Ukraine
 UC2, UK2 White RSFSR
 UO5, UK50 Moldavia
 UP2, UK2B, P Lithuania
 UQ2, UK2G, Q Latvia
 UR2, UK2R, T Estonia
 YO Romania
 YU Yugoslavia
 ZA Albania
 ZB Gibraltar
 1A0 Sov. Mil. Order of Malta
 3A Monaco
 4U ITU, Geneva
 9A (See M1)

OCEANIA

A3 Tonga Republic
 CR8 Portuguese Timor
 C2 Republic of Nauru
 DU Philippines
 FK New Caledonia
 FO French Polynesia
 FW Wallis & Fortuna Islands
 H4, VR4 Solomon Islands
 JD, KA1 Minami Torishima
 JD, 7J1 Okino Torishima
 KB, KH1 Baker, Howland, American
 Phoenix
 KC6 Eastern Carolines
 KC6 Western Carolines
 KG6, KH2 Guam Island
 KG6R, KH0 Rota
 KG6S, KH0 Saipan
 KG6T, KH0 Tinian
 KH6 Hawaiian Islands
 KH7 Kure Island
 KJ, KH3 Johnston Island
 KM, KH4 Midway Island
 KP6, KH5K Kingman Reef
 KP6, KH5 Palmyra
 KS6, KH8 American Samoa
 KW, KH9 Wake Island
 KX Marshall Islands

P2

T2, VR8 Papua New Guinea
 VK Tuvalu Island
 VK Australia
 VK Lord Howe Island
 VK9 Willis Island
 VK9 Christmas Island
 VK9 Keeling, Cocos Island
 VK9 Mellish Reef
 VK9 Norfolk Island
 VK0 Macquarie Island
 VR1, T31 British Phoenix Islands
 VR1, T30 Gilbert Island
 VR1, T30 Ocean Island
 VR3 Christmas Island
 VR3, T32 Line Island
 VR6 Pitcairn Island
 VR7 Line Island, South and Central
 VR8 (See T2)
 VS5 Brunei
 YB, YC, YD Borneo
 YB, YC, YD Celebes
 YB, YC, YD Java
 YB, YC, YD Sumatra
 YB, YC, YD West Irian
 YJ New Hebrides
 ZK1 North Cook Island
 ZK1 South Cook Island
 ZK2 Niue Island
 ZL New Zealand
 ZL Auckland & Campbell
 ZL Chatham Island
 ZL Kermadec
 ZM7 Tokelaus
 3D2 Fiji Islands
 5W Western Samoa

ASIA

A4X Oman Is.
 A5 Bhutan
 A6 United Arab Emirates
 A7 Qatar
 A9 Bahrain
 AP Pakistan
 BV Taiwan
 BY China
 CR9 Macao
 EP Iran
 HL, HM North Korea
 HL, HM South Korea
 HS Thailand
 HZ, 7Z Saudi Arabia
 JA-JR Japan
 JR6, KA6 Okinawa (Ryukyu Is.)
 JD, KA1 Ogasawara
 JT Mongolia
 JY Jordan
 KA US Military in Japan
 OD Lebanon
 S2 Bangladesh
 TA Turkey
 UA, UK, UV, UW9-0 Asiatic RSFSR
 UD6, UK6C, D, K Azerbaïdhan
 UF6, UK6F, O, Georgia
 Q, V Armenia
 UG6, UK6G Turkoman
 UH8, UK8H Uzbek
 UI8, UK8I Tadjik
 UJ8, UK8J, R Kazakh
 UL7, UK7 Kirghiz
 UM8, UK8M, N Hong Kong
 VS6 Kamaran Is.
 VS9K India
 VU Andaman & Nicobar
 VU7 Laccadives
 VU7 Kampuchea
 XV Vietnam
 XW Laos People's Dem. Rep.
 XZ Burma
 YA Afghanistan
 YI Iraq
 YK Syria
 1S Spratly
 4S Sri Lanka
 4W Yemen
 4X, 4Z Israel
 5B4, ZC Cyprus
 7O People's Dem. Rep. of Yemen
 8Z4 Neutral Zone
 Saudi Arabia/Iraq
 9H Malta
 9H4 Gozo & Comino
 9K Kuwait
 9M2 West Malaysia

9M6

9M8 North Borneo
 9N Sarawak
 9V Nepal
 Singapore
 Abu Ail, Jabal Attair

NORTH AMERICA

C6 Bahamas
 CO, CM Cuba
 FG Guadeloupe
 FG, FS Saint Martin
 FM Martinique
 FO Clipperton Is.
 FP St. Pierre & Miquelon
 HH Haiti
 HI Dominican Republic
 J3, VP2G Grenada & Dependencies
 KC4, KP1 Navassa Is.
 KG4 Guantanamo Bay
 KL7 Alaska
 KP4 Desecheo
 KP4 Puerto Rico
 KS4, KP3, HK0 Serrana Bank & Roncador Cay
 KV, KP2 Virgin Islands
 OX, XP Greenland
 PJ6, 8 Saba Is.
 VE Canada
 VE1 Sable Is.
 VE1 St. Paul Is.
 VO Newfoundland, Labrador
 VP2A, V2 Antigua, Barbuda
 VP2D, J7 Dominica
 VP2E Anguilla
 VP2K St. Kitts
 VP2L, J6 St. Lucia
 VP2M Montserrat
 VP2S, J8 St. Vincent & Dependencies
 VP2V British Virgin Islands
 VP5 Turks and Caicos Islands
 VP9 Bermuda
 W, K, N, A United States of America
 XE Mexico
 XF4 Revillagigedo Islands
 ZF Grand Cayman Islands
 6Y Jamaica
 4U HQ, United Nations
 8P Barbados

SOUTH AMERICA

CE Chile
 CE0A Easter Is.
 CE0X San Felix
 CE0Z Juan Fernandez
 CP Bolivia
 CX Uruguay
 FY French Guiana
 HC Ecuador
 HC8 Galapagos Is.
 HK Colombia
 HK0 Bajo Nuevo
 HK0 Malpelo Is.
 HK0 San Andres & Providencia
 HP Panama
 HR Honduras
 HR0 Swan Is.
 KZ Canal Zone
 LU Argentina
 OA Peru
 PJ Bonaire
 PJ Netherlands Antilles
 PY Brazil
 PY0 Fernando de Noronha
 PY0 St. Peter & St. Paul
 PY0 Trinidad & Martim Vaz Is.
 PZ Surinam
 TG Guatemala
 TI Costa Rica
 TI9 Cocos Is.
 VP1, V3 Belize
 VPB Falkland Is.
 VP8, LU South Georgia Is.
 VP8, LU South Orkney Is.
 VP8, LU South Sandwich Is.
 VP8, LU South Shetland Is.
 VP8W South Grahamland
 YN, HT Nicaragua
 YS Salvador
 YV Venezuela
 YV0 Aves Is.
 ZP Paraguay
 8R Guyana
 9Y Trinidad and Tobago

WORK THE WORLD DX AWARD

To enhance the enjoyment of working DX, the editors of 73 take special pleasure in introducing the most complex and probably one of the most sought-after DX awards available today—the Work the World DX Award.

1. The WTW Award is available to licensed amateurs and SWL stations worldwide.

2. To be valid, all contacts must be made on or after January 1, 1979. There are no band or mode restrictions. Special single-band or -mode achievements may be recognized if you make your request the same time application is made.

3. The Work the World program consists of six individual continental awards (North American, South American, European, Oceanic, Asian, and African), each of which is a worthy single accomplishment by itself. To be eligible for the 7th and ultimate award (the WTW Award), applicants first earn the continental recognition. Once all six awards have been applied for, the WTW award will be issued at no charge to the applicant. The operator who earns WTW recognition has truly "worked the world."

4. Requirements for the individual continental awards: North American Award—a minimum of 13 North American countries; South American Award—12 South American Countries minimum; European Award—a minimum of 12 European countries; African Award—12 African countries minimum; Asian Award—12 Asian countries minimum; Oceanic Award—a minimum of 12 Oceanic countries.

5. To apply, prepare a list of claimed contacts for each continent. List contacts in prefix order. Include the date and time in UTC and the band and mode of operation.

6. If you are submitting your sixth continental award, please alert the award manager to this fact.

7. Do not send QSL cards. Have your list of contacts verified by two amateurs or a notary public.

8. Each continental award is \$5.00 in US funds only. We are sorry, but we can no longer accept IRCs, or foreign currency. Checks written on foreign banks must be payable in US funds.

9. Forward your application(s) and fee(s) to: Bill Gosney KE7C, 73 Awards Manager, 2665 N. Busby Road, Oak Harbor WA 98277.

Now here are the six domestic awards also being sought after by award seekers throughout the world. These awards are not meant to be an overnight venture and they were designed to not duplicate any in existence today. Each offers its own degree of difficulty and creates a sense of accomplishment.

ANNUAL WORKED ALL USA AWARD

1. If you're looking for a stateside award with a challenge, the USA Award is definitely the one. The annual Worked All USA

Award is available to licensed amateurs and SWL stations throughout the world.

2. To qualify, applicants must work each of the 50 US states within the same calendar year (January 1 through December 31). Annual endorsements will be awarded each subsequent year to applicants who verify their claim.

3. All valid contacts must be made on or after January 1, 1979. There is an award for single-band accomplishments on 2, 6, 10, 15, 20, 30, 40, 75, and 160 meters. A mixed-band award is also available.

4. To apply, prepare a list of claimed contacts in alphabetical order by state. List the state, the callsign of the station worked, the date and time in UTC, and the band and mode of operation.

5. Do not send QSL cards. Have your list of contacts verified by two amateurs or by a notary public.

6. The fee for this award is \$5.00 in US funds. Annual endorsements are \$2.50. We are sorry but we can no longer accept IRCs or foreign currency. Checks written on foreign banks must be payable in US funds only.

7. Forward your application and award fee to: Bill Gosney KE7C, 73 Awards Manager, 2665 N. Busby Road, Oak Harbor WA 98277.

THE Q-5 AWARD OF EXCELLENCE

If you frequent the American Novice bands, you will be pleased to learn of this award. This award is not meant to be an overnight accomplishment. Stations meeting the challenge of this award will be proud to display it in their shacks. It depicts the excellence and superiority of a station's transmitted signal as it is heard throughout the various US call districts.

1. The Q-5 Award is available to licensed amateurs and SWL stations throughout the world.

2. To qualify, applicants must work all ten US call districts and receive no less than a Q-5 readability report. A valid RST might be 599, 579, 549, etc., while an RST of 459, 449, or 469 would not qualify.

3. To be valid, all contacts must be made operating CW on those frequencies assigned the American Novice. Contacts must be made on or after January 1, 1979.

4. There are no band restrictions; however, applicants may request special band endorsement at the time application is made.

5. To apply, prepare a list of claimed contacts, logging each one in order of US call district worked. Include the station callsign, date and time in UTC, the frequency, and most importantly, the RST as noted on the confirmation card.

6. Do not send QSL cards. Have your list verified by two amateurs or a notary public.

7. Award fee is \$5.00 in US funds. No IRCs or foreign currency. Checks written on foreign banks must be payable in US funds.

8. Forward your application and award fee to: Bill Gosney KE7C, 73 Awards Manager, 2665 N. Busby Road, Oak Harbor WA 98277.

DISTRICT ENDURANCE AWARD

If any of you feel our awards are too easy for you, take a hard look at this award! Looks simple, huh? Don't be deceived. Try pursuing it; it will drive you right up the wall with frustration.

For the District Endurance Award, you'll need to find yourself an accurate timepiece, as you'll have exactly 60 minutes to work all ten US call districts. If you surpass the time limit, you'll have to start all over again. It definitely takes some planning; perhaps even some band changing.

Oh, one last important point. All contacts must be made independent of nets and net-type operations and must not be made while a contest is underway! Any takers?

1. The District Endurance Award is available to licensed amateurs and SWL stations worldwide.

2. To be valid, all contacts must be made on or after January 1, 1979. There will be no band or mode restrictions. If you are fortunate to work all contacts on a single band, however, we will be happy to recognize that feat if you mention it at the time application is made.

3. To qualify, applicants must work all ten US call districts in one hour or less. The time will commence the moment the first contact is established (callsign and RST is exchanged) and ends the moment the 10th call-district contact is made. Call districts can be worked in any order so long as all ten districts are worked within the 60-minute period.

4. To apply, applicants must state in their applications that all contacts were made independent of net or contest operation. Applicants must prepare a list of claimed contacts in callsign order by district. Include the date and time in UTC, the band and mode of operation, and the state.

5. Do not send QSL cards. Have your claimed list of contacts verified by two amateurs or a notary public.

6. Award fee is \$5.00 and must be payable in US funds. No IRCs or foreign currency. Checks written on foreign banks must be payable in US funds only.

7. Forward your application and award fee to: Bill Gosney KE7C, 73 Awards Manager, 2665 N. Busby Road, Oak Harbor WA 98277.

TEN-METER 10-40 AWARD

What would an awards program be without a stateside QRP incentive? Designed especially for owners of converted CB equipment, the 10-40 Award is probably the roughest worked-all-states award in existence. If you don't believe it, ask those who've tried numerous times and failed.

1. This award is available to licensed amateurs and SWL stations throughout the world.

2. To be valid, all contacts must be made on the ten-meter band using low power (20 Watts of output or less.) External amplifiers are prohibited. Contacts must be made on or after October 1, 1978, on AM, SSB, CW, or FM. Crossmode contacts will not count.

3. To qualify, applicants must work and confirm at least 40 US states.

4. To apply, make a list of contacts made in alphabetical order by US state beginning with Alabama. Include the call of the station worked, the date and time in UTC, the mode of operation, and a brief description of the equipment and antenna system utilized to make the contacts.

5. Do not send QSL cards. Have your list verified by two amateurs or a notary public.

6. Award fee is \$5.00 in US funds. IRCs and foreign currency are not acceptable. Checks written on foreign banks must be in US funds only.

7. Forward your application and award fee to: Bill Gosney KE7C, 73 Awards Manager, 2665 N. Busby Road, Oak Harbor WA 98277.

CENTURY CITIES AWARD

Designed as a dual worked-all-states effort, 73 presents the Century Cities Award. The applicant who has earned this recognition has accomplished probably the greatest feat available in WAS award programs.

1. Sponsored by 73 Magazine, this award is available to licensed amateurs and SWL stations throughout the world.

2. All contacts must be made on or after January 1, 1979, to be valid.

3. To qualify, the applicant must work and confirm a minimum of two cities or towns in each of the 50 US states, for a total of 100.

4. To apply, prepare a list of contacts in alphabetical order by state. Include the callsign, the date and time of the contact in UTC, the band, and the city.

5. Do not send QSL cards. Have your claimed contact list verified by two amateurs or a notary public.

6. Award fee is \$5.00 in US funds. Do not send IRCs or foreign currency, as they are no longer acceptable. Checks written on foreign banks must be payable in US funds.

7. Forward your application and award fee to: Bill Gosney KE7C, 73 Awards Manager, 2665 N. Busby Road, Oak Harbor WA 98277.

How does 73 process award applications? Upon receipt of an application, each entry is carefully scrutinized for authenticity. They must be sent to the Awards Manager in the proper format as noted in the award rules.

If your application is approved, a worksheet is prepared. A copy is sent to 73 headquarters to process your certificate. There your award is given a personal touch and later mailed to your door. A copy of the worksheet is also mailed to the applicant to acknowledge receipt of the application.

Should an applicant feel it is necessary to follow up an application, send your inquiry to 73 Magazine, c/o Carole Macioci, 80 Pine Street, Peterborough NH 03458. Always enclose a stamped business-size envelope with your letter.

We hope you enjoy the challenges of the 73 awards program. We ask that you share it with your amateur friends.

REVIEW

YAESU FT-209RH HANDIE-TALKIE

I needed a new 2-meter radio. My trusty Kenwood TR-7730 had been sold a year

ago to help pay for a new car, and I had since saved up enough money to get back into VHF. But I needed something different. A full-featured radio with scanning,

memories, DTMF pad, and the like was preferred.

Since I also travel by air a lot, I wanted a radio I could run around with without having to lug around a rig and big power supply. Also, having been bit by the packet bug, I needed a way to monitor the local digipeater (only fair since it had my call on it).

The obvious solution seemed to be one of the new generation of moderate-power (5 Watts), computer-controlled handie-

talkies. You know the kind I'm talking about—the ones with the fancy keyboards and the digital ashtrays. I never really had a very high opinion of these units. To me, an HT was supposed to be a basic transceiver with a few crystal-controlled channels (or a thumbwheel-selected synthesizer) to be used as a status symbol at swapfests or for monitoring a few frequencies. These new units struck me as, well, wimpy. I also remember the terrible reliability problems these units had when

they first hit the market a few years back. Now they had to be considered.

As I started my search for a full-featured HT at one of the recent area ham conventions, I found I had more than enough reason to be skeptical. Looking down the aisles of the exhibitors' hall, I saw most of the wearers of one brand looking like Leaning Towers of Pisa because the units were so heavy on their belts. Another rig had some nice features but ran on a screwy voltage: An adaptor had to be purchased to run the thing off 12 V. Still another HT looked great and was the next model up from a very popular basic HT, but the only place I saw them was at the exhibitors' table because none of the distributors could get them imported!

Then I ambled over to the Yaesu booth and saw their FT-209RH.

Inside the Box

Your hard-earned cash buys you the radio, a soft case, a rubber ducky antenna, a standard-size battery pack, and a wall charger as standard equipment. Major options include a speaker/mike, headset/mike, several styles of charger/dc-supply combinations, battery packs (including one that holds six AA-size dry cells), and a tone-squelch (i.e., PL™) encoder/decoder. I decided to get a speaker/mike and a couple of extra battery packs with my unit. All told, I spent a shade under \$400 for the package.

Physically, the business end of the FT-209RH (*sans* battery pack) is almost exactly the same size as the ICOM 2A/AT without its battery pack (I use the 2AT for comparison here because they are so common—almost everyone has at least seen one). With a standard-size battery pack on both units, the Yaesu is maybe a half inch taller. Weight is also close, the Yaesu, with the standard battery pack, being heavier by a small, but noticeable margin. The two units are virtually identical in size and weight when using a smaller battery pack on the 209. The 209 is also noticeably thinner and lighter when compared to its older brother, the FT-208.

The rubber ducky is ordinary, with a BNC connector. The carrying case is a rather flimsy plastic affair. It covers the 209's display with clear plastic but leaves the keyboard "out in the open" with a cut-out section. And it fits worse than a Joliet Special.

Batteries

The standard battery pack runs 12 V and is rated at 500 mAh, producing 5 W from the transmitter. An available smaller NiCd pack runs 10.8 V at 425 mAh and reduces the transmitter's output to about 3.5 W. The dry-cell pack reduces transmitter power to about 2.5 W.

The battery charger that comes with the 209 is a small wall transformer type. It's a trickle charger, taking about 15 hours to charge the standard NiCd pack fully. It *cannot* be used to charge the smaller pack; a separate charger is required. Yaesu offers a drop-in charger that will charge either NiCd pack in under 1.5 hours (then maintain the charge on trickle) and simultaneously operate as a dc supply.

The NiCd packs themselves have two small sockets (of different types so they can't be connected incorrectly) and four metal plates on the bottom. One socket is for dc (the HT will accept 6–15 V dc) direct to the radio. A circuit in the battery pack regulates the proper voltage to the HT. The other socket is for battery charging. The small plates on the bottom of the pack are used with the drop-in charger. The dry-cell pack is just a simple holding case. There are no connections underneath, therefore

it is not possible to run a 12-V-dc supply through it like the NiCds.

Receiver

This is a pretty hot little receiver for a handie-talkie. Less than .1 μ V was enough to break the squelch with an intelligible signal. Sensitivity was measured at .18 μ V for 12 dB S/N, 1 μ V for 30 dB S + S/N.

Unfortunately, the good sensitivity seems to have lowered the 209's immunity to intermod somewhat. Subjectively, the unit seems to be more susceptible than other HTs, especially when connected to a base-station antenna.

Selectivity came in at -6 dB for \pm 7.5 kHz and -60 dB for \pm 15 kHz.

Transmitter

The transmitter section will produce a good solid 5 Watts on high power with the 500-mAh (12-V) battery. A 13.8-V-dc supply will squeeze out a bit more. The manual says the low-power mode will run 500 mW, but my unit runs 700 mW. Low power output is adjustable, but a maintenance manual is pretty much required to find the spot.

The transmitter output is also very clean. Spurious transmissions are down over 70 dB and the second harmonic is -60 dB from the carrier frequency. Tested with a 1000-Hz tone, deviation runs a little over 4.7 kHz. Touchtones™ from the keyboard deviate about 3.3 kHz, just right for most repeater autopatches.

I had quite a scare while making the second-harmonic measurement mentioned above. The spectrum analyzer used for making the measurement showed the display shown in Photo B. It appeared that the second harmonic was only 30 dB below the carrier frequency. Hardly a sparkling specification! I called for a "second opinion." Sure enough, the second device showed a very respectable -60 dB. Turns out a notch filter was needed with the original analyzer. A lesson to be learned for all those making test measurements!

Functions

Make no mistake, the FT-209RH can do a lot of things. Ten memories. Priority channel. Calling channel. Programmable tone squelch (with the tone option). A *zillion* scanning modes. In fact, there are so many functions that it can take a while to learn all the commands! Even Yaesu doesn't know everything it can do: They concede the point in the last paragraph in the owner's manual.

There are controls on literally every side of the 209, including behind and even underneath! The top of the unit holds the usual volume and squelch controls, high/low power switch, sockets for external mike and speaker, and VOX controls (used with the optional headset/mike). Two minor gripes: There are no plugs to seal the mike and speaker sockets when not used, and the VOX switches are "active," even when there is no VOX headset/mike connected. Accidentally activating the VOX switch will cause a VOX-delayed end of transmission after releasing the PTT switch (neither the internal mike nor the optional speaker/mike will operate in a VOX mode).

A master reset button is located in a tiny recessed hole on the back of the HT. Pushing a small pointed object like a pin into the hole while the 209 is turned on will reset the radio's functions. This is the "boy, I really screwed something up" button.

Another small button *underneath* the radio sets the smallest scan step. The battery pack must be removed for access and, like the reset button, a small pointed object must be inserted.

The PTT button is located on the left

side of the radio. A momentary-contact lamp button on the right side illuminates the LCD display and signal-strength meter for viewing in low-light conditions.

Front Keyboard

There are three main uses for the keyboard: to transmit DTMF tones, to enter frequencies, and to access HT functions. All the keys except the F (Function) key have two functions.

While the 209 is transmitting, the keyboard will act as a 16-digit DTMF encoder. The usual numbers * and # are marked on the keyboard. The auxiliary tones are accessed with the I (down arrow), M, D, and F buttons.

The keyboard is used for entering frequencies, either for direct selection or for loading into memory. Frequencies are entered from the lowest MHz on down, terminated by hitting the D (for dial) button. For example, entering 6025D would set the frequency to 146.025 MHz. All four digits need not be entered: Pressing 65D will set the HT to 146.500 MHz. Note that nothing happens until that D button is pushed. The next logical step in frequency selection is entering an offset if a repeater will be used. Selecting an offset (+ or -) will shift the transmitter 600 kHz, or any other desired offset selected with the Shift (Function then Reverse keys) function. The Reverse key allows monitoring of a repeater input or "upside-down" operating. The selected offset will remain even if the dial frequency is changed.

The selected frequency and offset (and even a selected subaudible tone frequency with the optional tone module) may be placed into one of the ten memory channels by pressing the desired channel number (0–9) followed by the M key. Memory frequencies are recalled by pressing the channel number followed by the MR key. Memory channel 0 may be recalled instantly with just the * key. Yaesu suggests this channel be set to a calling frequency.

There may be more ways to scan frequencies with an FT-209RH than you can possibly use. The entire band may be scanned. The memories may be scanned. The band between two memory channels may be scanned. You can manually scan. There is auto stop on busy channels (with auto resume), and auto stop on clear channels (with auto resume). You can operate on a dial frequency while monitoring a memory channel or mask memory chan-



Photo A. Yaesu's FT-209RH.

nels so they won't be scanned at all. Sheesh! Scanning is initiated using the up- and down-arrow keys (I and i), with the type of scanning (manual, stop-on-clear, or stop-on-busy) selected with a small slide switch on the lower edge of the keyboard, and the mode of scanning depending on whether a dial frequency or memory channel is currently displayed.

There are several controls that are intended for the operator rather than the radio (or at least aren't related to either of the two topics above). Slide switches control the function of the signal/battery-level indicator and a keyboard lockout. A "beep" on keypress may be turned on or off. But by far the mode that really makes me want to jump up and down and shout "oh boy, this is great!" is the battery-save feature. When the 209 is in the save mode,

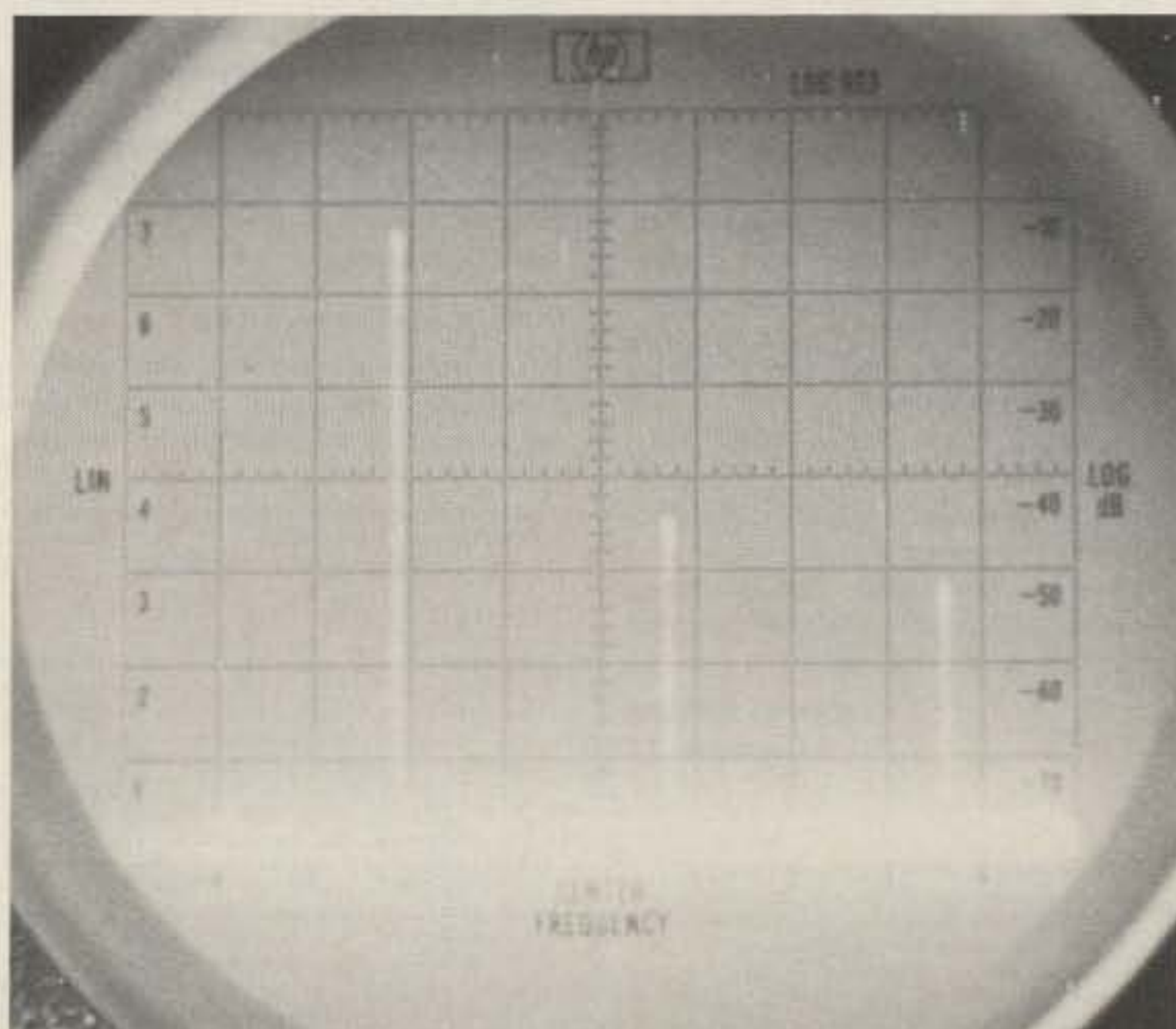

Photo B. What's wrong with this display?

the HT will shut off the receiver circuits and almost everything else except some timers and related stuff for a front-panel-selected amount of time, up to three seconds. It will then reactivate for 300 ms to see if there is receiver activity. If not, it goes "back to sleep" for another cycle. If there is activity, the mode will stand by until the channel is quiet for at least five seconds, when it will start again. Current drain in the save mode is a miniscule 6 mA! Given a 500-mAh battery, it is possible to monitor for several days without changing batteries.

Unfortunately, the save mode will not work during scanning, although it is possible to effectively monitor two frequencies in the save mode by using the radio's "priority channel" function. The function switches the receiver from a dial frequency to a selected memory channel for 300 ms every 5 seconds under normal conditions. In the save mode the frequency will alternate between the dial frequency and the memory channel every time the receiver "wakes up."

Some Final Thoughts

It takes a while to memorize all of the commands available to someone using an FT-209RH. For me, the learning curve was much longer for the 209 than for other radios I have used. Some of the commands may be unnecessarily complex. I think Yaesu could have made the 209 much more user-friendly. For example, the VOX functions could have been put in a less prominent place than the top of the unit. A PTT button lock would have been nice, too.

I've touched only the major functions of the FT-209RH. I could probably go on for another couple of pages if I were to describe all the possible permutations. Suffice it to say that during normal operation, very little extra work is required. Once everything is set, there's not much reason to change anything. And judging from on-the-air reports, this HT "sounds good."

I did run into a problem which could only be attributed to a lapse in quality control. The transmitter would mysteriously cut out if the HT was held a certain way or if it was shook. Opening the unit (not for the faint of heart), I found the cause to be a wire not properly soldered to the antenna connector's center conductor. To be fair to Yaesu, I should point out that the times I needed to speak to someone at their Ohio Service Center I was treated promptly and politely.

All that said, I still really like the FT-209RH. After all the commands are mastered, it is a very versatile, powerful unit. It can do everything a base-station rig can do, and then some. The memories and some of the memory-scan functions are particularly useful. The battery-save feature is something that should be in every HT... I'm spoiled now. Borrow somebody's Yaesu FT-209RH for a few days and take it for a test run. But be sure to ask for the owner's manual, too.

I'd like to thank Steve KE5O, Paul WA5JMZ, and Chris WB5ITT for their comments, suggestions, and help in the preparation of this review.

For more information, contact Yaesu Electronics Corp., 6851 Walthall Way, Paramount CA 90723; (213) 633-4007.

Mark Herro WB9LSS
Beaumont TX

- 1 - Microvolts/dBm Conversions
- 2 - Frequency/Wavelength Conversions
- 3 - System Received Signal Levels
- 4 - Gain of Parabolic Antenna
- 5 - Propagation Calculations
- 6 - Return to DOS

Fig. 1. Main menu from "Radio System Calculations."

HORSE SENSE SYSTEM DESIGN SOFTWARE

I recently had an opportunity to evaluate "Radio System Design Calculations" and "Radio Interference Analysis," two new software packages from Gerald Townsend at Horse Sense Software. Both are available for several microcomputers and both cost about \$35.00, depending upon your particular configuration. I tried them out on an IBM PCjr with an RGB monitor and an Okidata Microline 93 printer.

Radio System Design Calculations

This package is a collection of conversion programs and calculations designed to save wear and tear on your pencil. Five major categories may be selected from a main menu (see Fig. 1), and each category consists of one to six subprograms. All of the programs are menu-driven and I found the instructions to be clear and presented in a logical order (a big shortcoming for many programs of this type!).

I felt that only three of the five programs in the main group were useful—Frequency/Wavelength Conversions, System Received Signal Levels, and Propagation Calculations. Of the remaining two categories, Gain of Parabolic Antennas is the most trivial. Simple formulae like the one for parabolic gain are best evaluated by hand or on a scientific calculator, not by a program running on an \$800 computer. Microvolts/dBm Conversions, my other pan, just wasn't useful in my application; the program is quite handy if you need to change dBm to microvolts into various impedances.

Normally, I would have included Frequency/Wavelength Conversions on my list of trivia, but after a few test runs I was convinced of its utility. It's a simple matter to use the familiar $492/\text{frequency}$ to get the half wavelength of a dipole in free space, but this routine gives you everything you need to know, including the half and quarter wavelengths for two common coaxial cables, and it does it much faster than a calculator.

Propagation Calculations and System Received Signal Levels are the other two winners in the package. The first will grind out facts about any radio site you can devise, including path loss between sites, distance to real and radio horizons, and required antenna heights for a given horizon. Combine these parameters with the Signal Levels program (which produces a microvolts-at-the-receiver value for a given receiver and signal path) to get the answer to questions like, "How will raising my repeater's antenna by ten feet affect the repeater's performance?" and, "What coverage will a new repeater site give?" It seemed a bit tedious hopping back and forth between programs, but it actually took only a second or less.

Radio Interference Analysis

This software design tool was designed specifically for the land-mobile site planner and is not as practical for amateur

use as "Radio Systems Design Calculations." It consists of two modules, one for intermodulation analysis and the other for image-response analysis. The two modules share a common database which contains transmitter/receiver information for a particular site (such as an amateur repeater installation which coexists with commercial users). Site files are built and saved in a simple step-by-step fashion, and there are ample opportunities to review and revise your entries.

The intermodulation analysis program uses a two-pass process for either 3rd- or 5th-order products. The first pass considers two transmitters operating at the same time and the second looks at three transmitters. In both instances all of the products produced by the hypothetical mixing of the transmitted frequencies are checked against each receiver's frequency. Products which fall within a specified receiver susceptibility range (the default is 30 kHz) are flagged and sent to the printer. Fig. 2 is a sample 5th-order three-transmitter printout which was generated by a site file included on the program diskette. The number-crunching took about four minutes and the program executed about 135,000 calculations.

The image-response section compares all of the transmitters in the site file against a receiver with a user-specified receive and i-f frequency. Again, problems are flagged and sent to the printer. Both high-side and low-side injection schemes are considered.

A tutorial mode may be selected from the main menu which steps the user through all of the input and output of the intermodulation analysis. Output is sent to the screen rather than to the printer, and changing values and parameters is made extremely simple. This mode is an excellent way to get the "feel" of the program and learn a bit about intermodulation products in the process.

Last Thoughts

Both "Radio System Design Calculations" and "Radio System Interference Analysis" are well-documented, and the latter includes long sections discussing various methods of site management and a thorough review of basic intermodulation product calculations. I think that "Interference" will not make a big splash on the amateur scene, but I do recommend it to repeater owners and coordination bodies as a useful tool in repeater-site preparation and management. "Design Calculations," on the other hand, has several handy features that make the package well worth \$35.

The two programs are available on disk (and tape, in some cases) for the Apple II, Commodore 64, IBM PC and PCjr, Kaypro II, and Radio Shack's Color Computer, Model 3/4, and Model 2/16. Contact Horse Sense Software, PO Box 214, Gardiner MT 58030 for current prices and formats.

Perry Donham KW1O
73 Staff

```
*****
*** Three transmitter - 5th Order products falling within the specified
Susceptibility range of + or - 30 KHz.
*****
```

Transmitters involved/products	Users & Freq. affected.
2X 165.5875 -2X 164.8 + 164.825 = 166.4	NPS 1--- 166.375 MHz.
2X 165.5875 -2X 164.8 + 164.825 = 166.4	NPS 2--- 166.375 MHz.
2X 164.125 -2X 164.825 + 166.975 = 165.575	NPS 3--- 165.5875 MHz.
2X 164.125 -2X 164.825 + 166.975 = 165.575	NPS 4--- 165.5875 MHz.
2X 417.475 -2X 417.375 + 166.975 = 167.175	NPS 5--- 167.15 MHz.
3 X 165.5875 - 164.8 - 164.825 = 167.1375	NPS 5--- 167.15 MHz.
3 X 164.8 - 163.125 - 164.125 = 167.15	NPS 5--- 167.15 MHz.
2X 417.475 -2X 417.375 + 166.975 = 167.175	NPS 6--- 167.15 MHz.
3 X 165.5875 - 164.8 - 164.825 = 167.1375	NPS 6--- 167.15 MHz.
3 X 164.8 - 163.125 - 164.125 = 167.15	NPS 6--- 167.15 MHz.
2X 164.125 -2X 166.975 + 417.375 = 411.675	NPS A LINK--- 411.575 MHz.
2X 164.125 -2X 166.975 + 417.475 = 411.775	NPS B LINK--- 411.775 MHz.
2X 164.8 -2X 165.5875 + 166.375 = 164.8	USFS F1--- 164.825 MHz.
3 X 165.5875 - 164.8 - 167.15 = 164.8125	USFS F1--- 164.825 MHz.
2X 164.8 -2X 165.5875 + 166.375 = 164.8	USFS F2--- 164.825 MHz.
3 X 165.5875 - 164.8 - 167.15 = 164.8125	USFS F2--- 164.825 MHz.

Fig. 2. Sample 5th-order intermodulation analysis.

TEL MK-800 MEMORY KEYS

A few years back, the state of North Carolina created a large industrial park at the center of the triangle formed by Raleigh, Durham, and Chapel Hill. It became known as the Research Triangle Park. The park was supposed to encourage old businesses to move in and new ones to form. One of the newer businesses is Triangle Electronics Laboratories. A ham-oriented business, they recently came out with the MK-800, which they claim is the most cost-effective digital memory keyer on the market. Having had the opportunity to use one, I heartily agree.

The MK-800 was billed as a "complete memory keyer designed for the experienced contest operator as well as the Novice." While not a Big Gun contest, I have participated in several using a simple, home-brew digital keyer. I felt that I was ready to move up into the world of memory keying and was able to give the MK-800 a shakedown during the 1985 ARRL DX contest.

The unit arrived from TEL packed in a sturdy cardboard box and was cushioned with foam peanuts. Nothing unusual about that, but the end of the power cord was wrapped in its own cushioning layer to keep it from scratching the keyer's case. That was a touch that I'd never seen before and it hinted of a good attention to detail. An eleven-page, spiral soft-bound manual came with the keyer.

Ignoring the manual, just for the moment, I examined the MK-800. It was a compact, two-tone plastic package. The front-panel layout was esthetically quite pleasing. There has been a bad trend lately towards making everything look as if it was either army surplus or crammed with millions of front-panel buttons that only a gnat could push. The MK-800, on the other hand, has a clean, functional, yet friendly look. In the upper center there is an LED display window housing two easy-to-read red LEDs. The upper left corner is home to the sending-speed control. Across the bottom, eight square push-button switches give you control over the most frequently used operating functions. The feel of the switches is very good, very solid, with just the right amount of feedback. Red LEDs over each switch convey information to the user. The switches and knobs are labeled with a pleasant style that is easy to read from a normal operating distance. The unit's colors, black, white, and grey, are arranged in such a way as to give it some personality, yet they allow it to harmoniously blend with almost any station.

So it was a nice paperweight, but was it any good as a keyer? I began to hook it up. Turning it over, I examined the rear panel. Across the top of the machine there are (from left to right) the sidetone switch, a +12-volt jack, a remote-control jack, and the key, paddle, and transmitter relay jacks. Across the bottom we have the power switch and the sidetone tone and volume adjustments.

It was time to consult the manual. A quick scan found that page 2 had a description of the required connections. The paddle input wanted a 1/4-inch stereo phone plug with the tip as dits, the center as dahs, and the shield common. Since that was the same setup as my home-brew keyer, I was able to use my existing cable. (The MK-800 does not come with any cables or connectors, so be ready for a trip to Radio Shack unless you get lucky, as I did.) I also noticed that the paddle inputs are TTL-compatible, so the unit could be controlled by a home computer.

The transmit relay is a fast reed relay. It is wired so that it floats relative to the MK-800's chassis ground. This allows it to be

safely plugged into just about any kind of rig. The keyer end requires another 1/4-inch stereo phone plug. The tip and the center are the relay contacts, while the shield is connected to the MK-800 chassis ground. I made up a cable with connectors and hooked the keyer to my rig.

Checking the connections, I powered up the MK-800 and my rig (a Swan 350). Since I was operating at home, I ran the unit off the standard 110-volt-ac mains. The inclusion of a 110-volt power supply, as well as a +12-volt input, is another example of Triangle Electronics Laboratories bucking a bad trend. All too often we see reasonably priced rigs with exorbitantly priced "optional" power supplies. It seems that many manufacturers expect us to run our equipment off good karma.

When the power switch was on, the MK-800 performed a dramatic power-up test. The indicator LEDs lit up, the two big numeric LED displays started displaying numbers, and finally the unit beeped. It was so much fun to watch that I turned the power off and on again. When the self-test was finished, the numeric display had a "00" on it, indicating that the keyer was ready to go. So I squeezed the paddles and was rewarded with a clean-sounding string of dits and dahs. The MK-800 does not have any transmitting weight adjustments. Instead, it sends according to the recognized standard of one dah being three dit lengths long. The dit length is set by the front-panel speed control. The keyer is iambic, sending alternating dits and dahs when both paddles are squeezed. It also has a 1-dot or -dash memory and is self-completing.

So far it functioned like my home-brew keyer. It was time to try out some of the advanced features. First I took the opportunity to adjust the tone and volume of the sidetone. These adjustments are done on the back of the unit and require a small screwdriver to turn the miniature potentiometers. This would be inconvenient except that these adjustments almost never need changing once they are set.

Flipping through the manual, I found the section labeled "Function Switches." Unfortunately, although there is a good deal of text for each switch, it is unclear and difficult to read. However, it seemed to be saying that all I had to do was press the load switch followed by a memory-select switch and the keyer would load the memory with what I was sending. So I did, and sure enough, it worked. It was much easier than the manual made it out to be, as were all the other functions. It appears that the folks at TEL are great engineers but could use some technical writers.

The MK-800 has six memories. Each memory will hold up to 99 characters. Memories are loaded by pushing the load button, followed by a memory-select button. The large numeric display shows the number of characters entered and is incremented each time a new character is sent to the keyer. When the entire message has been entered, you tell the keyer you are finished by pushing the reset button or any of the memory-select buttons. If you push the reset button the keyer just stops loading and goes back into dumb-keyer mode with your message in memory. If you push a memory-select button the keyer begins sending the contents of the selected memory.

Memory number six is special. It can be configured (via jumpers) to send a three-digit serial number. The leading zeros can be suppressed and all zeros can be sent as the letter O. The serial number can be pre-loaded, automatically incremented, or automatically repeated. Or, if you want, it can be left as a plain memory.

Ninety-nine characters make quite a



The MK-800 memory keyer from Triangle Electronics Laboratories.

long message. It doesn't take much familiarity with statistics to calculate the chances of sending a message that long without errors. Fortunately, the MK-800 has provisions for human fallibility. When the inevitable error occurred, I was ready, having already read about the delete button. Each time this switch is pressed, the last character in the memory is deleted. Loading resumes at the place that was occupied by the deleted character.

Once the message was loaded, I pushed the memory-select button. The keyer immediately began sending my message, while the display showed a countdown of the number of characters left to send. Pushing the pause button once stopped the transmission when the current character finished. While the unit was paused, I could send code manually with the paddles. Pushing the pause button a second time allowed the message to continue to completion.

When the message was completely sent, the LEDs displayed "00." I pushed the memory-select button a second time, repeating my test message. This time I tried out the break-in function. While the message was going out, I began sending with the paddles. The keyer immediately stopped its transmission and gave me control of the transmitter relay. While the Swan 350 does not have a break-in feature for CW, it was nice to see that the keyer could handle it.

I was ready to go on the air. First, I loaded up the memories with various convenient messages. Message one was simply "CQ." Message two was "DE" and message three was "KF4PV." This may appear a bit fragmented to the casual observer, but there is method to this madness. The MK-800 lets you string your messages together. For example, by pushing the sequence 1-1-1-2-3-3-3 I could send "CQ CQ CQ DE KF4PV KF4PV KF4PV" and tack on a "K" manually. By manually sending my contact's callsign and pushing the sequence 2-3, I could reply "VR6TC DE KF4PV." (Note—supplied callsign is purely wishful thinking.) The MK-800 allows you to string up to 99 messages together.

After the rest of the memories were loaded with the usual stuff about rigs and weather, it was time to tune up. Putting the Swan into the CW/Tune mode, I pushed the MK-800's tune button. The rigs keyed and meters were dipped. Pushing the tune button a second time unkeyed the rig. Just in case you are forgetful, the

tune function turns itself off after ten to fifteen seconds. My unit timed out after thirteen.

I hunted around for a clear frequency, and finally finding one, pushed 1-1-1-2-3-3-3. After a couple of repetitions, a Pennsylvania station answered and we had a pleasant QSO. I was able to keep up a smooth flow, mixing manual and memory keying. My contact, when asked for a critical signal report, said that there was no click and that the signal was easy to read. This indicated that the lack of weighting was no problem and that the relay keying circuit did not change the keying waveform.

The MK-800 makes CW a lot more fun. It's slightly strange to watch your rig sending the obligatory rig and weather discussion in perfect code while you're sitting back with coffee and a magazine. Just don't forget to take over when it finishes.

It was time to get ready for the DX contest. Besides the usual things one needs to plan, I now had to work out my message strategy. Among other things, I decided that one memory needed to contain the word "test." When I tried to enter it, though, I suddenly began having troubles. The machine would load "eist" or "eht" or other nonsense, but not "test."

The MK-800's one-year parts and labor warranty states that the unit should be mailed back to Triangle Electronics Laboratories in case of trouble, but since the contest was coming up soon and Durham is relatively close by, I decided to get in touch with the folks directly first. I described my problems, and the next day was given a new EPROM to substitute for the one in the unit. Once it was installed, the problem with "test" went away completely.

It seems that I had found a problem in the Morse receiving algorithm used in the keyer. "Why should a keyer have a Morse receiver?" was my reaction. To read the straight key, was the answer. The MK-800 performs a running statistical analysis on the straight-key input. It keeps track of the lengths of time that the key is held down and the length of time between key-down periods. Based on the observed times and statistical summing of the past times, it decides whether a dit or dah has been entered. This way it can track a relatively sloppy fist, adjust to changing speeds, and tell when to insert a space if auto-space is selected. (As a test, I hooked another keyer to the input of the MK-800 and sent varying speeds of code to the MK-

800. The speed was increased from three to fifty words per minute in four seconds. The MK-800 tracked perfectly.) This does cause one limitation, namely that after power-up or reset, the first word received by the unit must contain both dits and dahs.

My problem was caused by a bug in the receiving program. Even though I was using the paddle inputs, these are eventually routed through the receiving program. The problem only occurred when the first word after reset did not contain a character with dits and dahs. It lasted only for the first word. Subsequent words were received correctly. However, the problem was found and fixed in less than a day by the unit's designer, and all units now use the new, correct software. Even allowing for the fact that I did not have to deal with the US Mail, this still ranked as the fastest warranty work I'd ever seen.

Finally, contest day was here. I had put up a new vertical for twenty meters and quick tests showed that it was loading and working well. I hooked up the MK-800, loaded the message buffer (with no problems this time), and fired up the rig. Calling CQ was effortless, and responding to stations calling CQ was also very easy. I had a 3x5 card that showed the order in which to push the memory buttons for CQs or replies. Things were going well as far as keying was concerned, but I wasn't having much success against the megawattners and their thousand-element beams up ten miles. So I cranked up the power from two hundred Watts in to four hundred Watts in. That's when the trouble started.

The keyer's relay suddenly began locking up. Every time I keyed the rig, it stayed until I manually switched back to receive mode. Putting the transceiver back to lower power fixed the problem. Back at high power, the relay locked up again. On a hunch, I disconnected the MK-800 and hooked up my old keyer. Sure enough, the old keyer is aluminum. Somehow, at high power, rf was leaking into the MK-800.

Next, I hooked up a straight key to the Swan. When I touched it, it was hot. Connecting the MK-800 again, I switched back to my longwire antenna. The MK-800 now did not lock up. I went outside and checked out the new vertical and found that there was a poor ground connection. This was causing loose rf in the shack and the plastic keyer case let it through. However, since then I have been unable to make the MK-800 lock up when it was keying a rig connected to a properly grounded antenna.

So the MK-800 keyer functioned very well in a contest, as well as in casual QSOs. I also used it to help train a class of Boy Scouts in Morse code. Here, the really useful feature was the battery backup for the messages. I could load the memories at home with long strings of straight and random text, unplug the unit, and carry it to the Novice class. Nearly six hundred characters at five words per minute will keep a class busy long past the point where they're actually learning anything, so I never ran out of material for the Scouts. In fact, I was able to use the same messages three weeks in a row without having to reload them.

In conclusion, the MK-800 is a very good keyer, with more features than any other keyer that I've seen in its price class (\$150). The AEA keyer in the same price class has no memories or power supply. The next higher up AEA unit has ten memories, still no power supply, and costs \$50 more than the MK-800. The MK-800 has six memories, automatic serial number, continuous-output speed control, paddle or straight-key input, and input editing functions. The straight-key input speed is com-

WHAT DO YOU THINK?

Have you recently purchased a new product that has been reviewed in 73? If you have, write and tell us what you think about it. 73 will publish your comments so you can share them with other hams, as part of our continuing effort to bring you the best in new product information and reviews. Send your thoughts to Review Editor, 73 Magazine, Peterborough NH 03458.

pletely independent of the output speed and can vary over a very wide range. It has battery backup for the memories and can operate from +12 V dc or 110 V ac. It is a joy to use and looks good in the shack. The only disadvantages are the somewhat confusing manual and the lack of an ear-phone jack for the sidetone speaker, but they can be lived with. I recommend the MK-800 to anyone who wants a good, high-performance digital keyer at a good price.

For more information, contact *Triangle Electronics Laboratories, 7016 Windover Drive, Durham NC 27712; (919) 471-6738.*

Laszlo Morocz KF4PV
Chapel Hill NC

ICOM IC-27A

It all began several months ago when I realized that the summer just wouldn't be complete without a two-meter transceiver in the car. You know how it is: vacation plans that include a lot of driving, scenic tours with visitors from abroad, trips to the beach, short hops into Boston, and the usual daily trips to and from work, the grocery, etc. Obviously, I'd planned to spend a lot of time in the car and wanted a radio that would keep me in touch with my friends via the local repeaters, or even direct/simplex. New England is full of repeaters, and in spite of the rugged terrain you aren't ever out of "sight" of at least one repeater—usually several.

What to buy? The choices are staggering, with at least five or six major manufacturers trying to produce the best and most desirable radio at the lowest possible price. I wanted a full-feature mobile unit with about 25 Watts output, small in size, lightweight, neat in appearance, as well as versatile and convenient. Finally, I decided to opt for the ICOM IC-27A, mainly because of its diminutive tuck-away-anywhere size and its reputation with hams who spend a lot of time on the air from their cars.

The radio comes in two packages: an accessory box and the foam-encased transceiver. The accessory box contains a microphone, a power cord, a short length of coax with connector, and an assortment of plugs and connectors. The power cord is fused. The foam-protected transceiver is packaged with its mobile mounting bracket already in place.

The handsome dark-gray and chrome IC-27A measures a scant 1½" x 5½" x 7" and weighs a mere 42 ounces. You will like the mounting bracket which allows you to disconnect the transceiver by merely rotating two levers on the sides of the inverted-U-shaped mount.

General Features

The push-to-talk mobile microphone is furnished with a sixteen-button touchtone™ pad for repeater access of autopatch dialing. Just in case your favorite repeater has Private Line™ access, the IC-27A is ready with 32 on-board PL tones, selectable by the main tuning knob and storable in memory. Speaking of memories, there are 9 of them backed up by a seven-year lithium battery. Each memory is capable of storing the receive frequency, the transmit offset, the offset direction, and the PL tone of your choice. There is a scanning feature which you can set to scan either memory channels or vfo channels. There is also a priority-scan function, a convenient arrangement whereby you can select a particular channel and cause the radio to receive that channel whenever a signal appears on it, regardless of where else the radio may be "listening" or scanning. The IC-27A has dual-vfo capability, selectable by front-panel push-button, allowing you to set cer-



The IC-27A.

tain frequencies with vfo A and other frequencies with vfo B. To switch from one to the other merely requires the button to be pushed, a welcome and helpful convenience, especially in an emergency situation.

Transmitter and Receiver Features

The transmitter has two output power levels: 5 Watts and 25 Watts. Under modulation, the deviation is ±5 kHz from center frequency. Spurious emission is more than 60 dB below the carrier level, and the audio quality provided by the 600-Ohm electret condenser microphone is very good indeed. Simplex or duplex operation is selectable, and any offset within the band is programmable in 100-kHz steps.

The frequency coverage of 144 to 148 MHz is provided by a microcomputer-based, 5-kHz/step, digital PLL synthesizer. Frequency stability is within ±1.5 kHz between temperature limits of 14 and 140 degrees Fahrenheit and voltage limits of 11.75 and 15.85 volts dc. Power requirements while transmitting are nominally 13.8 V dc (negative ground) at 6 Amps maximum. Receiving current draw is 0.4 A squelched and 0.6 A with squelch open.

The receiver is a double-conversion superheterodyne using a first intermediate frequency of 10.695 MHz and a second intermediate frequency of 455 kHz. Sensitivity is given two ways: less than 0.2 microvolts for 12-dB Sinad, or less than 0.4 microvolts for 20-dB quieting. The squelch sensitivity is less than 0.15 microvolts. What all of this means to you is that it is a mighty sensitive little critter that can let you hear what you need to hear when you want to hear it. The spurious-response rejection ratio is more than 60 dB, and the receiver selectivity is more than 15 kHz at -6 dB, and more than 30 kHz at -60 dB. This means a filter shape factor of about 2:1, which allows excellent rejection of normally-deviated adjacent-channel signals. You can expect audio output power of up to 2 Watts—enough for normal quiet-car listening.

Scanning

As mentioned earlier, the memory-scan function allows you to monitor nine different preselected channels. The programmed-scan function permits scanning between two programmed frequencies, and full-range scan allows the entire band to be scanned. You can change the scanning speed, and the auto-stop function terminates scanning either when a signal is received or when a channel is free. Priority scan may be operator-selected to stop at a memory channel or a vfo channel, and by using sampling techniques, you can easily check to see if a particular frequency (channel) is occupied or free.

One available option of the IC-27A is a speech synthesizer to verbally announce the receive frequency by simply pushing a

button. This permits you to know where you are at any time without the need to take your eyes off the road.

Using Your IC-27A

Here is where you will need to read the manual—several times if you're anything like me. There are so many features and functions that you can't "intuit" the thing and expect to get full performance from it. Like all modern rigs, it requires a learning process to furnish you with its entire capability, so we might just as well start with a short how-to paragraph or two.

The Vfo/Memory switch changes the rig from a memory channel to vfo and back again with a simple push. When you are in the memory-channel mode, a small M appears in the display, and the memory-channel number also appears. Note, however, that even in the vfo mode the memory-channel number still appears. The Vfo switch selects either vfo A or vfo B for tuning. In the out position, vfo A is selected and the vfo A indicator is illuminated in the display. When depressed, the switch selects vfo B, and the vfo indicator goes off. Personally, I would rather have the display show vfo B under these circumstances, but this is a minor point, since if no display is there, you know you're on vfo B.

In vfo operation, the front-knob tuning allows you to step the frequency up in 5-kHz (Tuning Rate switch in) and 15-kHz increments (Tuning Rate switch out). If you tune past the upper band limit of 148 MHz, the frequency automatically reverts to the lower limit of 144 MHz, and vice versa.

If you want to go from, say, 146 MHz to 147 MHz in a quick jump, all you have to do is press the 1 MHz Up button and you're there. To return to the 146-MHz frequency, just keep on depressing the button and the rig will cycle through 147 and 148, back to 144 and 145, and finally to 146 MHz.

The Memory Write/Offset Check button has dual functions. In the simplex mode (when neither DUP - nor DUP + is displayed) pushing this button writes the displayed vfo frequency into the displayed memory channel. Note that each memory channel stores the operating frequency, the offset frequency, the offset direction, and the subaudible tone frequency, if any. When you are in the duplex mode, pressing this button displays the offset transmit frequency and allows you to listen to the repeater input (while you hold the button down).

The Offset Write button, when held down, causes the offset frequency to be displayed. This can be changed by pressing either the - Duplex, the + Duplex, or the 1 MHz Up button. Each push of the - Duplex button decreases the offset frequency by 100 kHz and each push of the + Duplex button increases it by 100 kHz. Pushing the 1 MHz Up button increases the offset by 1 MHz.

The + Duplex and - Duplex buttons set the offset frequencies in the respective directions by 600 kHz automatically, unless

the Offset Write button is also pushed as mentioned before.

The Priority switch turns the priority frequency on or off. Here's a very nice feature: Let's say you are in QSO on a vfo channel, but want to see what's going on, if anything, on a priority channel. Or you're waiting for a friend to call. Just set that channel into memory and push the Priority button. The rig will check that priority channel every five seconds—automatically—for just a moment, enough to allow you to hear your friend when he (or she) calls. Conversely, if you are communicating on a memory channel, this switch will allow you to momentarily look at a vfo (previously set) frequency.

The Rf Power switch sets your transmitter to 25-Watt output in the out position, and to 5-Watt output in the in position.

The Tone Select button, when held in, displays the subaudible tone number on the frequency display panel and causes the Tone indicator to illuminate. While holding this switch on, you can rotate the main tuning knob and select the desired tone frequency.

The frequency display is four large 7-segment display digits representing the digits between 10 MHz and 10 kHz (46.91 representing 146.91 MHz, for example). The small 50, when illuminated, represents the final 5 kHz of the frequency.

The S/Rf indicator indicates S units in receive, and rf-power output in transmit. Note that this is a relative indication only and does not measure output power in Watts.

In the receive mode, when the squelch is opened by an incoming signal, a small green LED lights up.

The Tone indicator lights when any tone number other than 00 is set into the rig.

Rear-Panel Controls and Features

You will notice immediately that both the power connector and the antenna connector are at the ends of flexible cables rather than fixed to the rear panel. I asked Evelyn Garrison about this when I saw her at ICOM Day—Rivendell. She told me that the reason for this arrangement is so that the rear of the rig can be mounted nearly flush with a wall or a panel. Neat idea. If you happen to use an external speaker, you can plug it into the panel jack provided.

Underneath the access cover there are several switches and buttons. The CPU Reset switch resets the central processing unit of the microprocessor into its original condition... when the power is on. The Scan Speed switch sets the scanning speed to fast or slow, while the Scan-Stop Interval switch sets the interval to either about 9 seconds (long) or 3 seconds (short). The Vfo-Scan Mode switch can be set to PS (programmed scan) or FS (full scan) modes. A really neat feature is the Scan-Stop Function switch which allows the scan to stop on a busy channel or an empty channel.

When your unit is first turned on, the display will read "47.00" (representing 147 MHz) and the memory display will read "0" (representing memory channel 0). In the upper-left corner of the front panel, the M/Vfo switch can be pushed to display the M if you want to select a memory channel. You'll probably want to use the vfo at first, so don't push the switch.

Next, rotate the main tuning control to set the desired frequency into the display, using the desired tuning rate of either 5-kHz or 15-kHz steps, selected with the Tuning Rate control switch.

If you'd like to set up another frequency in the other vfo, just push the Vfo switch (marked A/B), also located in the upper-left corner and dial in the new frequency on

that vfo. Now you can have either frequency displayed (or in use) by merely pushing the A/B switch alternately. However, before you transmit, you should check to see which offset frequency is set up in the duplex mode, and whether it is plus or minus the displayed frequency. If neither DUP- nor DUP+ is displayed, push the desired button so that your desired offset is displayed. For 146-MHz operation, the offset will usually be DUP- (transmit frequency below the receive frequency). Next, push the M W button at the lower-left panel location to see whether the proper (normal) 600 kHz is displayed. If so, you will be in business for most repeaters. If it is not the desired 600 kHz, then you will have to set the desired offset into the unit. To do this, press the Offset Write button in the lower-left portion of the panel, and, while holding it in, push the

DUP- button until "0.60" (600 kHz) appears. In the same manner, other offsets can be selected. Finally, check your transmit frequency by pressing the M W button to display it. Let's say you have set up 146.25/146.85 as your channel pair. The display should show DUP- and 46.85. Then, pressing the M W button should show 46.25, which is correct. Now, pressing the mike button (you have plugged in your antenna, I hope) should allow you to access the repeater.

Simplex operation is achieved by merely depressing either DUP- or DUP+ until the display shows no offset. Your transmit frequency will then be the displayed frequency.

On The Air

One of the things you'll want to know is, "How do I sound on the air?" This is where

the IC-27A comes into its own. Audio quality reports have always stressed a very clean and easy-to-understand signal, with plenty of talk power. . .but no reports of over-deviation. In other words, you'll get through clearly if they can hear you at all. Sometimes, when the going gets "scratchy" and there is a drop out of your signal to the repeater, you may have to "say again, please," but you really didn't expect miracles, did you?

On the receive side, I personally like the recovered audio. For all practical purposes it is quite adequate, even plentiful, *except* in a noisy car with a lot of wind noise, traffic noise, or general conversation going on among your children or friends. However, none of the current rigs I know can solve this problem with their tiny, built-in speakers. There is one solution, of course, and it's the one I prefer—an earphone and micro-

phone headset, one of the featherweight varieties of the type used by pilots or astronauts. ICOM just happens to have one of these little gems, and it exactly fills the bill for mobile use.

So, what can we conclude from all of this? I would like to say that the main premise has been realized: a go-anywhere, reliable, full-featured, and compact 2-meter radio that has built an enviable reputation for itself by virtue of its performance.

A good friend, who has used his IC-27A for the last year or so, swears by this rig as being the best he has ever used. It's a constant companion in his car—as it is in mine.

Suggested retail price for the IC-27A is \$369.00. For more information, contact ICOM America, Inc., 2380-116th Ave. NE, Bellevue WA 98004.

Jim Gray W1XU
73 Staff

PACKET TERMINAL PROGRAM

- SPLIT SCREEN
- TEXT EDITOR
- TEN BUFFERS
- PRINTER OUTPUT
- DISK SAVE
- FILE TRANSFER

REQUIRES: TRS-80 I/III/IV w RS-232 & TNC

\$20.00 PREPAID

THE MARTIN CO. (206)653-9596
P.O. BOX 982 MARYSVILLE, WA 98270

1986 CALL BOOKS

U.S. Edition \$18.95
Foreign Edition \$17.95
If Ordered Before Dec. 1, 1985

NCN ELECTRONICS
436 Valley Rd., West Orange, N.J. 07052
(201) 674-8148

SYNTHESIZED SIGNAL GENERATOR

MADE IN USA



MODEL SG-100F
\$429.95 delivered

- Covers 100 MHz to 199.999 MHz in 1 kHz steps with thumbwheel dial
- Accuracy +/- 1 part per 10 million at all frequencies
- Internal FM adjustable from 0 to 100 kHz at a 1 kHz rate
- External FM input accepts tones or voice
- Spurs and noise at least 60 dB below carrier
- Output adjustable from 5-500 mV at 50 Ohms
- Operates on 12 Vdc @ 1/2 Amp
- Available for immediate delivery • \$429.95 delivered • Add-on accessories available to extend freq range, add infinite resolution, AM, and a precision 120 dB attenuator
- Call or write for details • Phone in your order as fast COD shipment.

VANGUARD LABS
196-23 Jamaica Ave., Hollis, NY 11423
Phone: (718) 468-2720

ALL BAND TRAP "SLOPER" ANTENNAS!

FULL COVERAGE! ALL BANDS! AUTOMATIC SELECTION with PROVEN Weatherproof sealed Traps - 18 Ga Copperweld Wire! GROUND MOUNT SLOPERS - No Radials needed! Ground to rod or house water faucet! Connect Top to Trees, Buildings, Poles, etc at ANY angle from Straightup to 60 degrees for excellent "SLOPER" DX Antenna Gain or bend it anywhere you need to! 2000 Watt PEP Input, max. Permanent or portable Use Installs in 10 minutes. SMALL - NEAT - ALMOST INVISIBLE - No one will know you have a Hi-Power DX Antenna. Ideal For COND'Os APARTMENTS- RESTRICTED AREAS - Pre-tuned for 2-1 or less SWR over ALL bands (except 80-160-300kc) No adjustments needed - EVER. COMPLETELY ASSEMBLED, with 50 ft RG-58U Coax feedline and PL259 connector - Built in lightning arrestor - ready to hookup! FULL INSTRUCTIONS!

No. 1080S - 80-40-20-15-10 - 1 trap 49 ft. - \$49.95
No. 1040S - 40-20-15-10 - 1 trap 26 ft. - \$48.95
No. 1020S - 20-15-10 - 1 trap 13 ft. - \$47.95
No. 1016S - 160-80-40-20-15-10 - 2 traps 83 ft. - \$79.95

SEND FULL PRICE FOR PP DEL IN USA (Canada is \$5.00 extra for postage etc) or order using VISA, MASCARD - AMER EXP. Give Number Ex Date. Ph 1-308-236-5333 weekdays. We ship in 2-3 days (Per Cks 14 days) Guaranteed 1 yr - 10 day money back trial.

WESTERN ELECTRONICS
Dept. A7 Kearney, Nebraska 68847

SOTRON ANTENNAS

**BIG ON PERFORMANCE
SMALL ON SPACE**

MODELS FROM 160-10 METERS
NO TUNERS! NO RADIALS!

PERFECT FOR LIMITED SPACE
APPLICATIONS: BOATS, APARTMENTS,
VACATION HOMES AND MORE.

80-METER..... \$63⁹⁵ plus \$4⁷⁵ Shipping
*40-METER..... \$52⁹⁵ plus \$3⁷⁵ Shipping
ASK FOR PRICES ON OTHER MODELS

*SEE REVIEW IN OCTOBER 73

BILAL COMPANY

S.R.2, BOX 62, DEPT. 73
EUCHA, OK 74342 (918) 253-4094

SWLS—HAMS

CALL TODAY FOR ALL
YOUR SWL & HAM NEEDS

- RECEIVERS
- ANTENNAS
- TRANSCEIVERS
- RTTY
- PUBLICATIONS
- SWL

YAESU • KENWOOD • ICOM

HARDIN ELECTRONICS
5635 EAST ROSEDALE
FORT WORTH, TEXAS 76112
1-800-433-3203
IN TEXAS 817-429-9761

1986 HAM RADIO PHOTO CALENDAR

Contest Dates, Forms, Maps
Displays photo each month
8.5"x11", spiral bound to hang flat. Photos of operators, stations are 7x10. Room for notes, skeds.
Great for home or as gift sent with your greetings!
Send \$7.93 (DX=\$9.00)
KB1T Radio Specialties
B-1015 Amherst NH 03031

SEND 25¢ FOR OUR
VERY COMPETITIVE PRICE SHEET



Amateur Communications Etc.

Hours:
Mon-Fri 8:30 am-5:00 pm
Sat-CST 9:00 am-2:00 pm

2317 Vance Jackson Rd
San Antonio TX 78213
(512) 734-7793

INDIANA HAMFEST

SUNDAY, MARCH 9, 1986

Open at 8:00 A.M.

Located on the Indiana State Fairgrounds
Indianapolis, IN

The crossroads of four interstate highways
I-65, I-69, I-70, and I-74.

All Indoors - Heated - Free Parking - Paved Parking Lots
Forums - Commercial and Flea market dealers
Talk-in on the "Mighty 525" - 145.25 MHz
Come and Enjoy a show by our "Quality" Dealers

THE MOST AFFORDABLE REPEATER

ALSO HAS THE MOST IMPRESSIVE PERFORMANCE FEATURES

(AND GIVES THEM TO YOU AS STANDARD EQUIPMENT!)

Band	Kit	Wired
10M,6M, 2M,220	\$680	\$880
440	\$780	\$980



FEATURES:

- SENSITIVITY SECOND TO NONE; 0.15 uV (VHF), 0.2 uV (UHF) TYP.
- SELECTIVITY THAT CAN'T BE BEAT! BOTH 8 POLE XTAL FILTER & CERAMIC FILTER FOR > 100dB AT ± 12KHZ. HELICAL RESONATOR FRONT ENDS TO FIGHT DESENSE & INTERMOD.
- OTHER GREAT RECEIVER FEATURES: FLUTTER-PROOF SQUELCH, AFC TO COMPENSATE FOR OFF-FREQ TRANSMITTERS, SEPARATE LOCAL SPEAKER AMPLIFIER & CONTROL.
- CLEAN, EASY TUNE TRANSMITTER; UP TO 20 WATTS OUT (UP TO 50W WITH OPTIONAL PA).

HIGH QUALITY XMTR & RCVR MODULES FOR REPEATERS, LINKS, TELEMETRY, ETC.

- R144/R220 FM RCVRS for 2M or 220 MHz. 0.15uV sens.; 8 pole xtal filter & ceramic filter in i-f, helical resonator front end for exceptional selectivity, > 100dB at ± 12kHz, best available today. Flutter-proof squelch. AFC tracks drifting xmtrs. Xtal oven avail. Kit only \$138.
- R451 FM RCVR Same but for uhf. Tuned line front end, 0.3 uV sens. Kit only \$138.
- R76 FM RCVR for 10M, 6M, 2M, or 220. As above, but w/o AFC or hel. res. Kits only \$118. Also avail w/4 pole filter, only \$98/kit.
- R110 VHF AM RECEIVER kit for VHF aircraft or ham bands or Space Shuttle. Only \$98.
- T51 VHF FM EXCITER for 10M, 6M, 2M, or 220 MHz. 2Watts continuous, up to 3W intermittent. \$68/kit.
- T451 UHF FM EXCITER 2 to 3Watts. Kit only \$78. Xtal oven avail.
- VHF & UHF LINEAR AMPLIFIERS. For either FM or SSB. Power levels from 10 to 45 Watts to go with exciters & xmtg converters. Several models. Kits from \$78.

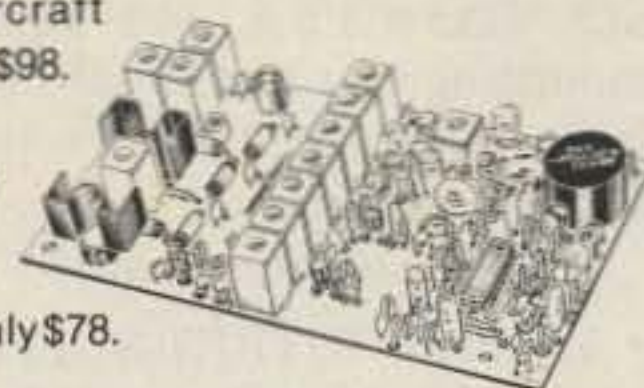

NOW—FCC TYPE-ACCEPTED TRANSMITTERS & RECEIVERS AVAILABLE FOR HIGH-BAND & UHF. CALL FOR DETAILS.

RECEIVING CONVERTERS

Models to cover every practical rf & if range to listen to SSB, FM, ATV, etc. NF = 2dB or less.

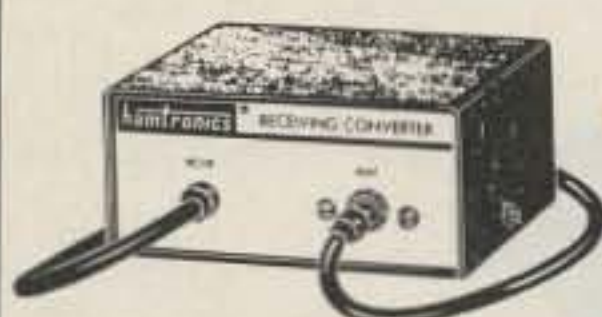

Antenna Input Range	Receiver Output
28-32	144-148
50-52	28-30
50-54	144-148
144-148	28-30
145-147	28-30
144-144.4	27-27.4
146-148	28-30
144-148	50-54
220-222	28-30
220-224	144-148
222-226	144-148
220-224	50-54
222-224	28-30

VHF MODELS

Kit with Case	\$49
Less Case	\$39
Wired	\$69

UHF MODELS

Kit with Case	\$59	432-434	28-30
Less Case	\$49	435-437	28-30
Wired	\$75	432-436	144-148
		432-436	50-54
		439.25	61.25

LOW-NOISE PREAMPS



Hamtronics Breaks the Price Barrier!

*
No Need to Pay \$80 to \$125 for a GaAs FET Preamp.

FEATURES:

- Very Low Noise: 0.7dB VHF, 0.8dB UHF
- High Gain: 13 to 20dB, Depending on Freq.
- Wide Dynamic Range for Overload Resistance
- Latest Dual-gate GaAsFET, Very Stable

MODEL	TUNES RANGE	PRICE
LNG-28	26-30 MHz	\$49
LNG-50	46-56 MHz	\$49
LNG-144	137-150 MHz	\$49
LNG-160	150-172 MHz	\$49
LNG-220	210-230 MHz	\$49
LNG-432	400-470 MHz	\$49
LNG-800	800-960 MHz	\$49

MINIATURE PREAMPS

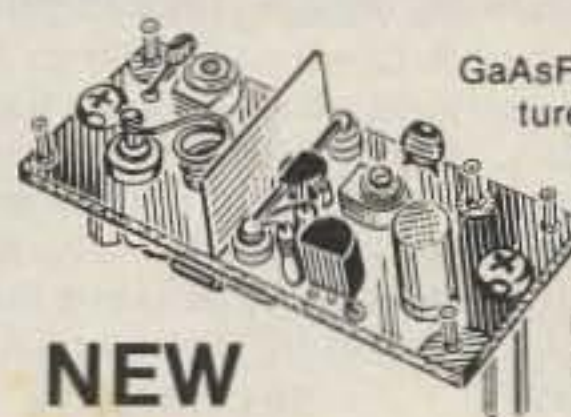

GaAsFET Preamps with features similar to LNG, except designed for LOW COST and SMALL SIZE: only 5/8"W x 1-5/8"L x 3/4"H. Easily mounts inside many radios.

NEW

MODEL	TUNES RANGE	KIT	WIRED
LNW-144	120-150 MHz	\$19	\$34
LNW-160	150-200 MHz	\$19	\$34
LNW-220	200-270 MHz	\$19	\$34
LNW-432	400-500 MHz	\$19	\$34

SCANNER CONVERTERS Copy 806 MHz band on any scanner. Wired/tested ONLY \$88.

TRANSMIT CONVERTERS

For SSB, CW, ATV, FM, etc. Why pay big bucks for a multi mode rig for each band? Can be linked with receive converters for transceive. 2 Watts output vhf, 1 Watt uhf.

For VHF,
Model XV2
Kit \$79
Wired \$149
(Specify band)

Exciter Input Range	Antenna Output
28-30	144-148
28-29	145-146
28-30	50-52
27-27.4	144-144.4
28-30	220-222*
50-54	220-224
144-146	50-52
50-54	144-148
144-146	28-30

For UHF,
Model XV4
Kit \$99
Wired \$169

28-30	432-434
28-30	435-437
50-54	432-436
61.25	439.25
144-148	432-436*

*Add \$20 for 2M input

VHF & UHF LINEAR AMPLIFIERS. Use with above. Power levels from 10 to 45 Watts. Several models, kits from \$78.

HELICAL RESONATOR PREAMPS

Low-noise preamps with helical resonators reduce intermod and cross-band interference in critical applications. 12 dB gain.

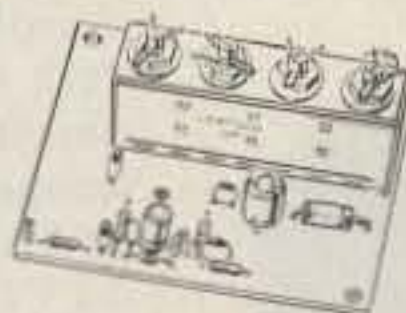

Model	Tuning Range	Price
HRA-144	143-150 MHz	\$49
HRA-220	213-233 MHz	\$49
HRA-432	420-450 MHz	\$59
HRA-()	150-174 MHz	\$54
HRA-()	450-470 MHz	\$64

IN-LINE PREAMPS

NEW

GaAsFET Pre-amp with features like LNG. Automatically switches out of line during transmit. Use with base or mobile transceivers up to 25W. Tower mtg hdwr incl.



MODEL	TUNES RANGE	KIT	WIRED
LNS-144	120-150 MHz	\$68	\$98
LNS-160	150-180 MHz	\$68	\$98
LNS-220	200-240 MHz	\$68	\$98
LNS-432	400-500 MHz	\$68	\$98

ACCESSORIES

- MO-202 FSK DATA MODULATOR. Run up to 1200 baud digital or packet radio signals through any FM transmitter.
- DE-202 FSK DATA DEMODULATOR
- COR-2 KIT With audio mixer, local speaker amplifier, tail & time-out timers.
- COR-3 KIT with "courtesy" beep".
- DTMF DECODER/CONTROLLER KITS
- AUTOPATCH KITS. Provide repeater auto-patch, reverse patch, phone line remote control of repeater, secondary control.
- CWID KITS
- SIMPLEX AUTOPATCH

- Send \$1 for Complete Catalog (Send \$2.00 or 4 IRC's for overseas mailing)
- Order by phone or mail • Add \$3 S & H per order (Electronic answering service evenings & weekends)
- Use VISA, MASTERCARD, Check, or UPS COD.

hamtronics, inc.

65-D MOUL ROAD • HILTON NY 14468

Phone: 716-392-9430

Hamtronics® is a registered trademark

John J. Meshna Jr., Inc.

P. O. Box 62 19 Allerton St. E. Lynn, Ma. 01904 Tel: (617) 595-2275

COMPUTER TERMINAL BUILDING BLOCK \$50.00

This is a great beginning for a computer terminal. It is a brand new, Panasonic, 9" TTL input monitor complete with its own self-contained, switching power supply, and a removeable (four screws) triple output power supply. The whole assembly runs on 115/230 V, 50/60 Hz. Now for some specifics: 9" green phosphor, TTL input monitor, attached regulated 12 VDC, 1.5 A power supply used exclusively to run the monitor and an attached triple output switching power supply with outputs of 5 VDC @ 3.5 A, +12 VDC @ 500 ma, and -12 VDC @ 500 ma. The assembly has mounting feet and should be a snap to make a case for. Comes with hook up data. New, factory boxed. We are offering this to you 4 ways:

- COMPLETE SET-UP AS SHOWN, including monitor, low voltage supply and triple output supply. SPL-116-38, 14 Lbs., \$50.00, 5/\$225.00
- TRIPLE OUTPUT SUPPLY ONLY, SPL-117-38, 3 Lbs. \$15.00
- 9" MONITOR ONLY, (you supply low voltage input) SPL-114-38, 10 Lbs. \$25.00
- 9" MONITOR W/LOW VOLTAGE SUPPLY ONLY, SPL-115-38, 12 Lbs. \$40.00

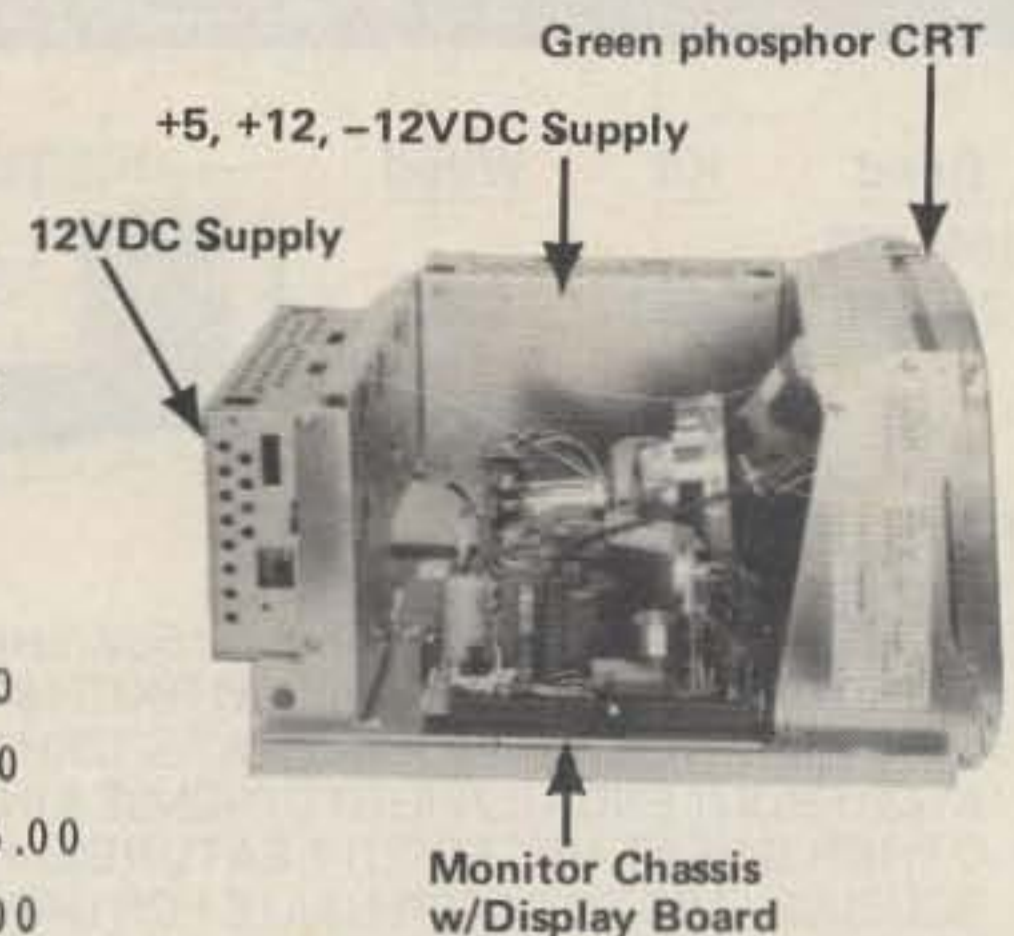

We are now selling guaranteed working, starlight scopes which allow sight in almost total darkness. They are so named because they incorporate a light amplification tube which uses the available star or moon light to allow you to see - without being seen. The scope has a spectral response of 4,500 to 8,000 angstroms, resolution of 50 lines/mm, viewing area of 25mm, standard 50mm F1.4 lens, optional telephoto 135mm F2.8 lens, cross hair reticle and optional carrying case. A great tool for security and naturalist applications. Runs on 9VDC transistor radio battery. Due to the nature of this device and people only having a one time use for it, we cannot accept returns for refund, credit or exchange on this item. To our knowledge, this is the least expensive starlight scope on the market. Includes 90 day warranty.

STARLIGHT SCOPE	SPL-130A-39	\$1,200.00
Optional Telephoto Lens, 135mm F2.8	SPL-131A-39	\$85.00
Optional Fitted Carrying Case	SPL-132A-39	\$65.00

ATTENTION:

SECURITY PERSONNEL
NATURALISTS
HOBBYISTS

NEW SEE-IN-THE-DARK EQUIPMENT!



5 1/4" HARD DRIVE CONTROLLER CARD

Finally, affordable, intelligent disc drive controllers are available at low, low surplus prices. The OMTI 20C controller boards we offer are unused, late style, surplus from a now defunct system house. OMTI is a division of Scientific Micro Systems. These boards will handle up to (2) 5 1/4 inch Winchester type hard drives that utilize a standard 34 pin SASI interface. Perfect for using with the above Seagate ST 506 drive, or other hard drives from 5 megabytes of storage on up. The controllers have buffered slew/seek modes, overlapped seeks, auto seek & verify, extensive fault detection, auto head & cylinder switching, full sector buffering, 256/512 bytes/sector, 33 or 18 sectors/track (jumper selectable), programmable disc parameters and much more. The board runs on +5 vdc & +12 vdc.. We supply users manual & pinout data. Guaranteed O. K.. Shpg. wt. 3 lb. OMTI 20 C \$150.00 each 2/\$275.00 Qty. pricing available.

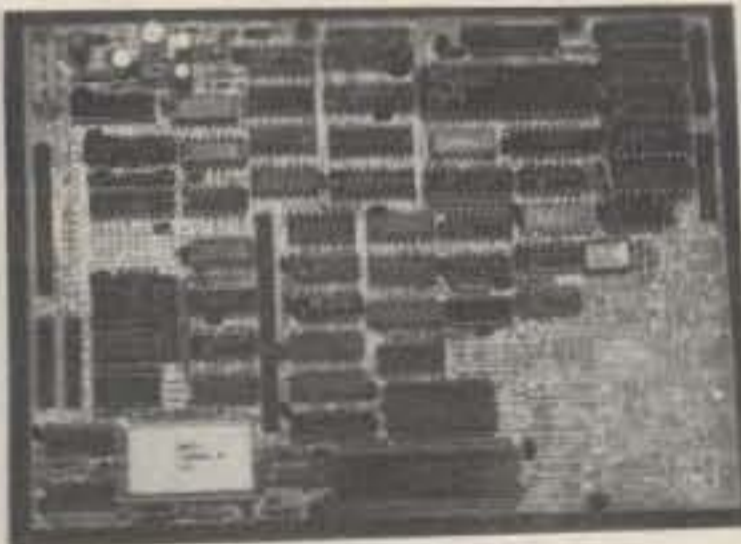

HIGH POWER SURVEILLANCE IR SCOPE

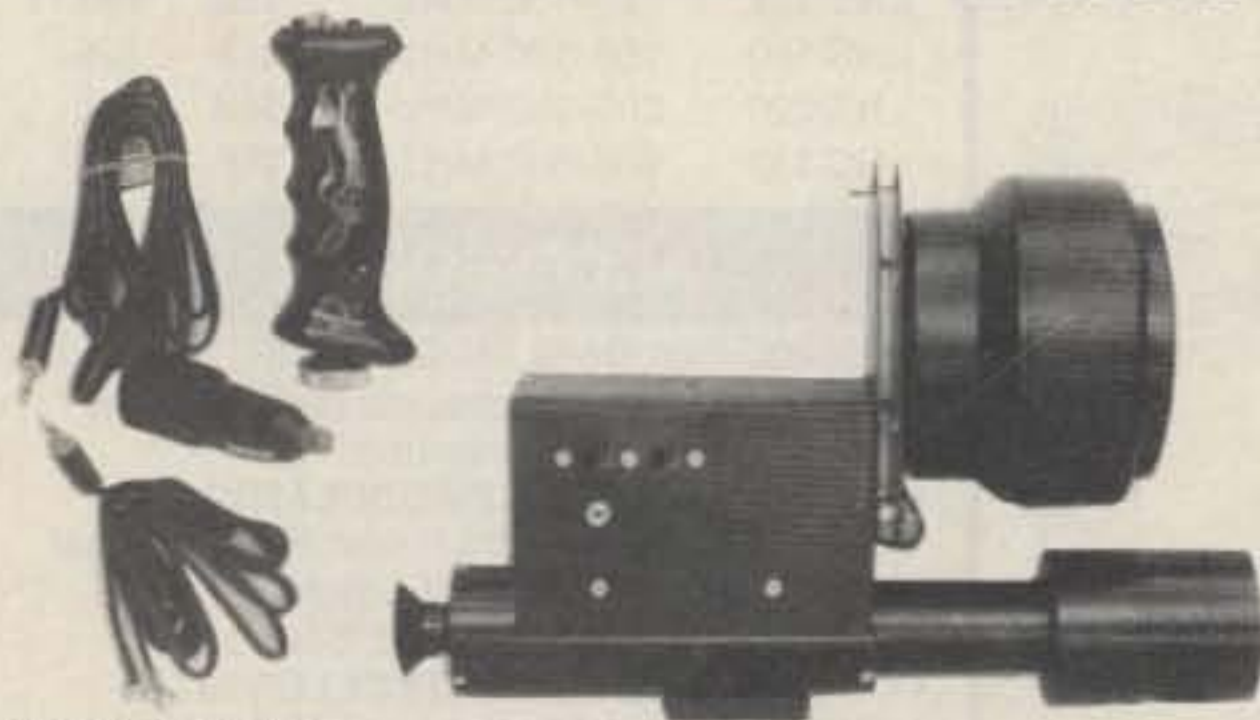

This Infra-Red scope was designed specifically for long range surveillance use. The built-in, totally invisible, 50 watt halogen lamp IR source is coupled with a premium grade type 6032 image converter tube, 265 mm f4.2 lens, and 16 power military spec., color corrected eyepiece make this an ideal unit for viewing of clandestine activities or animals. The scope is capable of detection at more than 300 feet, recognition at 300 feet and positive facial identification at 150 feet. It runs on 12 VDC which makes it ideal for mobile use. It comes with a removeable hand grip which allows for tripod mounting, 2 power cords for cigarette lighter or battery terminals, instructions and a 90 day warranty. Listed below are accessories which make this a very versatile instrument. The scope and accessories are new and guaranteed functional. Net wt. 5-1/4 Lbs.

IR Scope part no. ELD Shpg. Wt. 7 Lbs. \$735.00 ea.

ACCESSORIES:

12 VDC GELL BATTERY for above. Shpg. Wt. 6 Lbs. \$35.00

BIOCULAR EYEPIECE which can be used in place of the standard eyepiece. This allows the scene being produced by the IR viewer to be seen by the operator up to 4 ft. away. 2 Lbs. \$89.95

MALE "T" f1.6 CAMERA DAPTER for SLR cameras Shpg. Wt. 1 Lb. \$129.00

MALE "C" to FEMALE "T" ADAPTER for CCTV, requires use of above male "T" f1.6 adapter. Shpg. Wt. 1 Lb. \$29.95

Free 72 page catalogue available or send \$1.00 for 1st class service to P. O. Box 62 E. Lynn, Ma. 01904. Phone (617) 595-2275 to place your order by phone. MC, VISA, or American Express charge cards accepted.

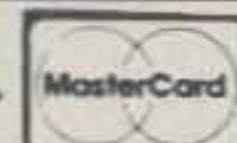

RAMSEY

THE FIRST NAME IN ELECTRONIC TEST GEAR



\$30⁰⁰ OFF

Save \$30 on the RAMSEY 20MHz Dual Trace Oscilloscope

Unsurpassed quality at an unbeatable price, the Ramsey oscilloscope compares to others costing hundreds more. Features include a component testing circuit for resistor,

capacitor, digital circuit and diode testing • TV video sync filter • wide bandwidth & high sensitivity • internal graticule • front panel trace rotator • Z axis • high sensitivity x-y mode • regulated power supply • built-in calibrator • rock solid triggering

Was \$399.95 NOW ONLY **\$369⁹⁵** high quality hook on probes included



NEW RAMSEY 1200 VOM MULTITESTER

Check transistors, diodes and LEDs with this professional quality meter. Other features include, decibel scale • 20K volt metering system • 3 1/2" mirrored scale • polarity switch • 20 measuring ranges • safety probes • high impact plastic case

\$19⁹⁵ test leads and battery included



NEW RAMSEY D-4100 COMPACT DIGITAL MULTITESTER

Compact sized reliability and accuracy. This LCD digital multimeter easily fits in your pocket, you can take it anywhere. It features full overload protection • 3 1/2 digit LCD readout • recessed input jacks • safety probes • diode check function • 2000 hours battery life

\$22⁹⁵ test leads and battery included

NEW 35 MHz DUAL TRACE OSCILLOSCOPE



A heavy duty and accurate scope for service as well as production use. Features include • wide frequency bandwidth • optimal sensitivity • extremely bright display • delayed triggering sweep • hold off • ALT trigger • single sweep • TV sync • 5X magnification • XY or XYZ operation • HF/LF noise reduction

3500 Dual Trace Oscilloscope \$499⁹⁵ includes 2 high quality probes

ALL OSCILLOSCOPES INCLUDE 2 PROBES

NEW 15 MHz DUAL TRACE PORTABLE OSCILLOSCOPE

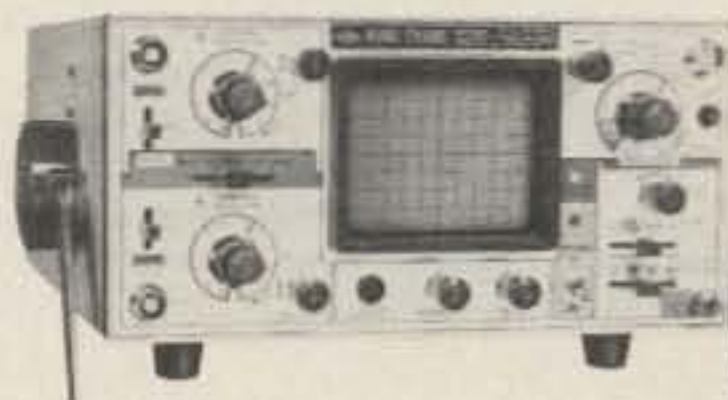

Ideal for field/bench applications, this scope can display up to 15 MHz signals. Internal battery pack allows up to 2 hours operation on a single charge. Features include • built-in battery charger • 5X horizontal magnification • high brightness CRT • front panel trace rotator • internal rechargeable battery pack

2500 Portable Oscilloscope \$449⁹⁵ includes 2 high quality probes

MINI KITS—EASY TO ASSEMBLE, FUN TO USE BEGINNERS & PROS WILL HAVE A GREAT TIME WITH THESE KITS

FM MINI MIKE



A super high performance FM wireless mike kit! Transmits a stable signal up to 300 yards with exceptional audio quality by means of its built in electret mike. Kit includes case, mike, on-off switch, antenna, battery and super instructions. This is the finest unit available.

FM-3 Kit **\$14.95**
FM-3 Wired and Tested **19.95**

Color Organ

See music come alive! 3 different lights flicker with music. One light each for, high, mid-range and lows. Each individually adjustable and drives up to 300 W. runs on 110VAC.

Complete kit, ML-1 **\$8.95**

Video Modulator Kit
Converts any TV to video monitor. Super stable, tunable over ch 4-6. Runs on 5-15V. accepts std. video signal. Best unit on the market! Complete kit, VD-1 **\$7.95**



Super Sleuth

A great attention getter which alternately flashes 2 jumbo LEDs. Use for name badges, buttons, warning panel lights, anything! Runs on 3 to 15 volts. Complete kit, BL-1 **\$2.95**

A super sensitive amplifier which will pick up a pin drop at 15 feet! Great for monitoring baby's room or as general purpose amplifier. Full 2W rms output, runs on 6 to 15 volts, uses 8-45 ohm speaker. Complete kit, BN-9 **\$5.95**

CPO-1
Runs on 3-12 Vdc 1 wall out, 1 KHZ good for CPO, Alarm, Audio Oscillator. Complete kit **\$2.95**

FM Wireless Mike Kit

Transmits up to 300' to any FM broadcast radio, uses any type of mike. Runs on 3 to 9V. Type FM-2 has added sensitive mike preamp stage.

FM-1 Kit **\$3.95** FM-2 Kit **\$4.95**

Whisper Light Kit

An interesting kit, small mike picks up sounds and converts them to light. The louder the sound, the brighter the light. Includes mike, controls up to 300 W, runs on 110 VAC.

Complete kit, WL-1 **\$6.95**

Tone Decoder

A complete tone decoder on a single PC board. Features: 400-5000 Hz adjustable range via 20 turn pot, voltage regulation, 567 IC. Useful for touch-tone burst detection, FSK, etc. Can also be used as a stable tone encoder. Runs on 5 to 12 volts. Complete kit, TD-1 **\$5.95**

Universal Timer Kit

Provides the basic parts and PC board required to provide a source of precision timing and pulse generation. Uses 555 timer IC and includes a range of parts for most timing needs.

UT-5 Kit **\$5.95**

Mad Blaster Kit

Produces LOUD ear shattering and attention getting siren like sound. Can supply up to 15 watts of obnoxious audio. Runs on 6-15 VDC

MB-1 Kit **\$4.95**

Siren Kit

Produces upward and downward wail characteristic of a police siren. 5 W peak audio output, runs on 3-15 volts, uses 3-45 ohm speaker. Complete kit, SM-3 **\$2.95**

60 Hz Time Base
Runs on 5-15 VDC. Low current (25ma) 1 min/month accuracy TB-7 Kit **\$5.50**
TB-7 Assy **\$9.95**

30 Watt 2 mtr PWR AMP

Simple Class C power amp features 8 times power gain. 1 W in for 8 out, 2 W in for 15 out, 4 W in for 30 out. Max output of 35 W, incredible value, complete with all parts, less case and T-R relay.

PA-1, 30 W pwr amp kit

\$22⁹⁵
6⁹⁵

TR-1, RF sensed T-R relay kit

Power Supply Kit

Complete triple regulated power supply provides variable 6 to 18 volts at 200 ma and +5 at 1 Amp. Excellent load regulation, good filtering and small size. Less transformers, requires 6 3V (a 1 A and 24 VCT. Complete kit, PS-3LT **\$6⁹⁵**

CT-70 7 DIGIT 525 MHz COUNTER

Lab quality at a breakthrough price. Features • 3 frequency ranges each with pre amp • dual selectable gate times • gate activity indicator • 50mV @ 150 MHz typical sensitivity • wide frequency range • 1 ppm accuracy

\$119⁹⁵ wired includes AC adapter
CT-70 kit **\$99.95**
BP-4 nicad pack **8.95**

CT-50 8 DIGIT 600 MHz COUNTER

\$169⁹⁵ wired
CT-50 kit **\$139.95**
RA-1 receiver adapter kit **14.95**

CT-90 9 DIGIT 600 MHz COUNTER

The most versatile for less than \$300. Features 3 selectable gate times • 9 digits • gate indicator • display hold • 25mV @ 150 MHz typical sensitivity • 10 MHz timebase for WWV calibration • 1 ppm accuracy

\$149⁹⁵ wired includes AC adapter
CT-90 kit **\$129.95**
OV-1 0.1 PPM oven timebase **59.95**
BP-4 nicad pack **8.95**

CT-125 9 DIGIT 1.2 GHz COUNTER

\$169⁹⁵ wired includes AC adapter
BP-4 nicad **\$8.95**

DM-700 DIGITAL MULTIMETER

Professional quality at a hobbyist price. Features include 26 different ranges and 5 functions • 3 1/2 digit, 1/2 inch LED display • automatic decimal placement • automatic polarity

\$119⁹⁵ wired includes AC adapter
DM-700 kit **\$99.95**
MP-1 probe set **4.95**

PR-2 COUNTER PREAMP

The PR-2 is ideal for measuring weak signals from 10 to 1,000 MHz • flat 25 db gain • BNC connectors • great for shifting RF • ideal receiver/TV preamp

\$44⁹⁵ wired includes AC adapter
PR-2 kit **\$34.95**

PS-2 AUDIO MULTIPLIER

The PS-2 is handy for high resolution audio resolution measurements, multiplies up in frequency • great for PL tone measurements • multiplies by 10 or 100 • 0.01 Hz resolution & built-in signal preamp/conditioner

\$49⁹⁵ wired
PR-2 kit **\$39.95**

PS-10B 1 GHz PRESCALER

Extends the range of your present counter to 1 GHz • 2 stage preamp • divide by 1000 circuitry • super sensitive (50 mV typical) • BNC connectors • 1 GHz in, 1 MHz out • drives any counter

PS 10-B Prescaler \$79⁹⁵
wired includes AC adapter

ACCESSORIES FOR RAMSEY COUNTERS

- Telescopic whip antenna—BNC plug . . . \$ 8.95
- High impedance probe, light loading . . . 16.95
- Low pass probe, audio use 16.95
- Direct probe, general purpose use 13.95
- Tilt ball, for CT-70, 90, 125 3.95



PHONE ORDERS CALL
716-586-3950

TELEX 466735 RAMSEY CI



RAMSEY ELECTRONICS, INC.
2575 Baird Rd.
Penfield, N.Y. 14626

TERMS: • satisfaction guaranteed • examine for 10 days; if not pleased, return in original form for refund • add 6% for shipping and insurance to a maximum of \$10.00 • overseas add 15% for surface mail • COD add \$2.50 (COD in USA only) • orders under \$15.00 add \$1.50 • NY residents add 7% sales tax • 90 day parts warranty on all kits • 1 year parts & labor warranty on all wired units.

NEW PRODUCTS

ARCISOFT PUBLISHES SATELLITE HANDBOOK

The 1986 *Space Satellite Handbook* from ARCsoft Publishers details 5,612 payloads, platforms, rockets, and pieces of debris in orbit around the Earth, moon, and sun.

Data from NASA, NORAD, and the Smithsonian Observatory are included in this paperback book. Objects are listed with their international number, popular name, launch date, and country of origin. Orbital parameters including period, inclination, apogee, perigee, and NASA radio frequency are shown for each entry.

Complete details about the *Handbook* are available from *ARCsoft Publishers, PO Box 132AM, Woodsboro MD 21798.*

SANTEC ST-20T

Encomm, Inc., has announced a new addition to the Santec line of hand-held radios. The ST-20T covers 142-150.995 MHz with an output power of 5 Watts. Two seven-digit autodial memories allow auto-



The Santec ST-20T, available from Encomm, Inc.

matic dialing through a repeater's auto-patch. A 16-key keyboard provides access to 32 functions.

For complete information about the ST-20T, contact *Encomm, Inc., 1506 Capital Avenue, Plano TX 75074.*

ONE-TUBE RADIO KIT

A new one-tube radio kit is available from Antique Electronic Supply. The kit comes complete with all of the parts necessary to make a working radio, including a tube and a mounting board. Batteries and headphones are optional. The kit provides the radio experimenter or antique-radio buff the opportunity to learn early electronic construction techniques.

A 20-page catalog of tubes, parts, and books (including information about the kit), is available from *Antique Electronic Supply, 688 West First Street, Tempe AZ 85281; (602)-894-9503.*

TEC-200 IMAGE FILM

TEC-200™ image film, produced in West Germany and sold in the US by the Meadowlake Corporation, is part of a new system for creating printed-circuit etching patterns. TEC-200 film is placed in a standard photocopy machine. A PCB pattern from a magazine or book is transferred to the TEC-200, and then the pattern is transferred to a copper board by using a hot iron. After the film is removed, the board may be etched with any common etching agent. The resist is then removed with a standard solvent.

For detailed information about TEC-200 image film, contact *Meadowlake Corporation, 25 Blanchard Drive, Northport NY 11768; (516)-757-3385.*

MFJ VIDEO TITLER

MFJ Enterprises has announced their Video Effects Titler (VET), a computer-based stand-alone titler for professional and home-video use.

The VET allows the superimposition of 30 pages of color titles over a camera image, or titles may be added over existing video footage during editing. Each page holds eight lines of sixteen upper- and lowercase letters. Each character may be one of 15 colors. Title pages are retained in memory when the VET is turned off or unplugged.



MFJ's Video Effects Titler.

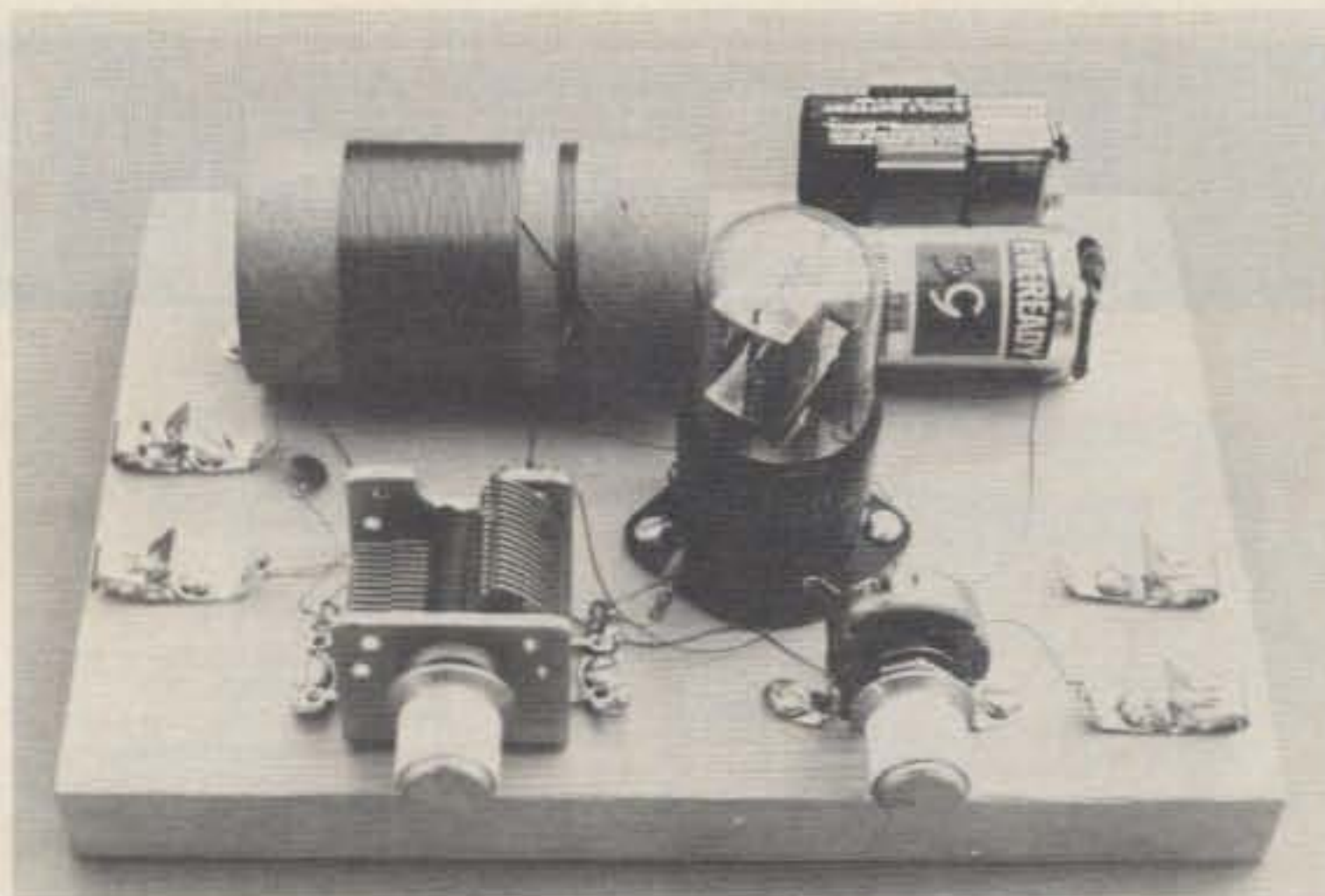

A one-tube receiver from Antique Electronic Supply.

For more details, contact *MFJ Enterprises, Inc., 921 Louisville Road, Starkville MS 39759; (800)-647-1800.*

DAVLE TECH CRIMPING KIT

Davle Tech, Inc., has introduced the CTK-8 crimping kit. The kit includes a crimping tool and an assortment of insulated terminations. The crimping tool will handle insulated or uninsulated terminals, will cut small bolts and wires up to 10 AWG, and will strip the insulation from wires between 10 and 22 AWG.

For complete information, contact *Davle Tech, Inc., 2-05 Banta Place, Fair Lawn NJ 07410; (201)-796-1720.*

EVERETT/CHARLES SUPER MODEM 1200

The Super Modem 1200, available from Everett/Charles Marketing, is a 300/1200-baud modem designed for use with RS-232C-compatible computers and terminals. It is functionally equivalent to the Hayes modem, and uses both Bell 103 and 212A standard tones. Other features include autodial, redial, touchtone™ or pulse dialing, and full- or half-duplex operation.

For complete details, contact *Everett/Charles Marketing Services, Inc., 6101 Cherry Avenue, Fontana CA 92335; (800)-443-1860.*

DSE SATELLITE RECEIVER KIT

The Australis I satellite receiver kit is now available from Dick Smith Electronics. The kit has been designed to make construction and alignment as simple as possible—only a standard multimeter and a signal source are required. The front and

rear panels are silk-screened, and the circuit board is solder-masked fiberglass with a screened component overlay.

For more information about the Australis I, contact *Dick Smith Electronics, PO Box 8021, Redwood City CA 94063.*

CES BEAMCALC SOFTWARE TOOLBOX

Communications Electronics Specialists, Inc., has announced the CES BeamCalc Software Toolbox for the Commodore 64 and Apple II computers. The software calculates beam headings from the operator's location to any location in the world. Also displayed are the latitude and longitude of the selected location, the distance in statute and nautical miles, the time difference from UTC, the DX zone number, postal rates, the number of IRCs required for a postal reply, and QSL bureau information.

Other programs in the Toolbox handle line-of-sight calculations, satellite tracking, moon tracking, and solar-phenomena predictions.

For more information, call or write *CES, Inc., 803C South Orlando Avenue, Winter Park FL 32789; (800)-327-9956.*

CTCSS ENCODER ADDS DIP-SWITCH PROGRAMMING

Selectone Corporation has redesigned their model ST-130 Digitone CTCSS encoder to include a six-position DIP switch for tone programming. The new model provides 37 CTCSS frequencies between 67 Hz and 250.3 Hz. The unit operates on 5.5 V dc and draws less than 2 mA. The output level is adjustable to a maximum of 1 V rms. The ST-130 is compatible with all standard CTCSS systems, including Private Line™ and Channel Guard™.



The Australis I satellite receiver from DSE.

DELTA-ZULU IC-2AT CASE

Crowley Manufacturing has introduced the Delta-Zulu soft-vinyl case designed to fit the IC-2AT/3AT/4AT series of hand-held radios. A clear plastic window gives access to the keypad, and a zippered battery door allows the user to change the battery pack without removing the case. There are openings on the top and back of the case for controls and plugs. The Delta-Zulu case is available in either black or burgundy and can be used with or without a belt clip.

For more information, contact *Crowley Manufacturing Company, 95 Federal Street, Lynn MA 01905.*

MICROWAVE MODULES 2M GaAsFET MULTIMODE

Microwave Modules of Liverpool, England, has announced the MMT144/28R solid-state multimode transverter. The MMT144/28R can be used with any 28-30-MHz transceiver having a low-level (.25-300-mW) power output.

The receive section includes a noise-matched NEC GaAsFET preamplifier and a high-level double-balanced mixer, providing excellent strong-signal-handling



Microwave Modules' MMT144/28R 2m transverter.

characteristics and immunity to cross modulation.

The transmit converter provides an output of 25 Watts and incorporates an alc circuit to ensure a clean signal. A visual indication of relative power output is given by an LED bar-graph display.

Dc power requirements are 13.8 V dc at 6 Amps. The alc range is 20 dB. The receiver's noise figure is 2 dB or better with a third-order intercept point of 19 dBm.

For more information, please contact *The PX Shack, 52 Stonewyck Drive, Belle Mead NJ 08502; (201)-874-6013.*

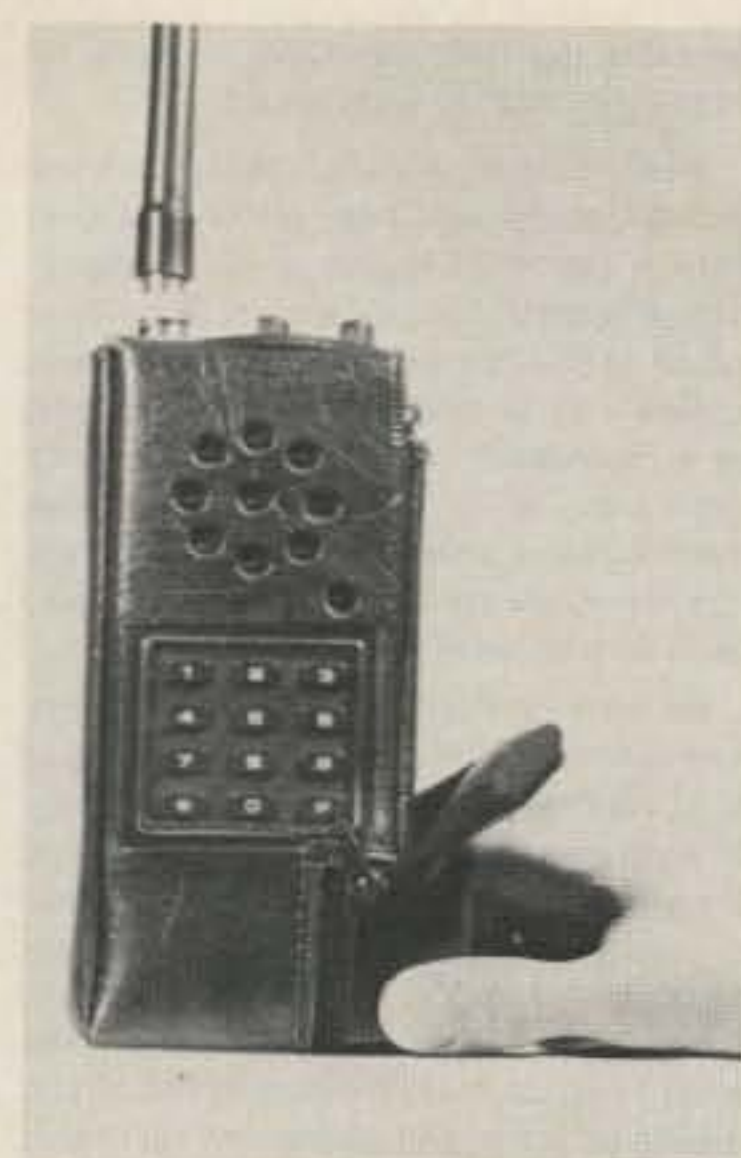

Crowley Manufacturing's Delta-Zulu HT case.

For more information, please contact *Selectone Corporation, 28301 Industrial Blvd., Suite L, Hayward CA 94545.*

RTTY LOOP

*Marc I. Leavey, M.D. WA3AJR
6 Jenny Lane
Pikesville MD 21208*

Happy New Year, one and all! I do hope that this year will bring each and every one of you everything that your hearts desire! For many of you, that wish has been a program to put your personal computer onto RTTY, and I hope that this column has helped more than a few of you fulfill that wish.

Now with that said and with a bit of a lump in my throat, let me quickly apologize to those of you whom I am about to upset. By means of an allusion last month, I hinted that a particularly delicious computer would be the subject of this month's software review. Unfortunately, I am still waiting for at least one response to an inquiry I sent out. So, rather than just spin my wheels, let me tell those of you who have managed to appropriate or acquire a big blue box (IBM PC or compatible) what's in the RTTY cards for you.

A couple of years ago, when an owner of an IBM-style computer wrote me for RTTY information, all I had to say was "tough luck," but now, with the proliferation of these machines in the hands of hams, all this has changed.

A rather typical looking station is an IBM PC with 128K of RAM, serial communications card, RS-232-to-TTL drivers based on a 1489-1488 chip pair, and all this feeding a Flesher TU-170 interfaced to the ham rig.

Software in use at this station is a program advertised by Bob Johnson AA4L, 11305 Rums Hill, Raleigh NC 27614, which is apparently available for a formatted disk and a few dollars. It is rumored to be available as well on several bulletin boards, usually called "TTY22."

The program provides 60-, 75-, and 100-wpm Murray (Baudot) transmission, several disk messages, and can key the transmitter via RS-232 signals and the 1489-

1488 pair. The display is not split-screen; receive and transmit data are interspaced. However, there is a buffer to type ahead for transmit while receiving.

One of the hams using this program tells me that he has added a storage slot for the callsign of the current station being worked, function keys to switch speeds, disk recording of callsigns after a QSO with duplicate checking, disk message interrupt, and "several other things." In addition, he eliminated some of the "cumbersome" features, like a start-up logo, speed-select menu, and such. Just shows you what can be done with some of the user-supplied software traded and modified on "the boards."

Another of you tells me that his IBM PC interfaces to his rig through a CP-1 and uses the Hamcom program, version 3A, from Emile F. Alline, Jr. NE5S, of Metairie LA. I am told that this program encompasses Murray, ASCII, and CW, as well as code practice. Saving data to disk, printing out to the printer, and storage of "canned" messages are also supported. Sounds like another interesting program, although I have no idea as to the cost.

Another program in use is by Glenn Welman KF4NB, 3301 Pastern Ct., Lexington KY 40513, and is distributed as "freeware." In the literature, which I have seen an abstract of, the author says to share the program with others who are interested in RTTY, but not to sell or barter the program. When the program is passed along, only the unmodified version, along with the guidelines, should be included. A self-addressed stamped envelope to the author will get you the latest update, and any and all contributions will be accepted.

The program requires an IBM PC or compatible, with at least one drive and 128K of RAM, an asynchronous communications adapter, and DOS version 1.1 or better. It would appear that the program will function on a PCjr with some limitations.

Display is in either monochrome or color, with 80x25 and 40x25 character modes available. The split-screen has receive data on top, and transmit on bottom, and run-time information (including current date and time and elapsed time since the last ID) is in the center of the screen. Meanwhile, the bottom of the screen contains error codes, information messages, and function-key information.

It even maintains the old CR-CR-LF-LTRS end-of-line sequence required by manual teleprinters!

Baud rates equivalent to Murray 60, 67, 75, and 100 words per minute are supported, as well as ASCII baud rates of 100, 110, 300, 1200, and more! There's even a 4K buffer for you to fill from the keyboard while receiving.

All this in a program that apparently is available for the asking, for which the author only asks you to send him what you think it's worth. Sounds good!

Now, as to the hardware itself, a few of you have found it less than perfect for amateur use. One of you tells me that rf in the shack gets the PC excited. That was cured by grounding the keyboard, monitor, and CPU cabinet to a six-foot ground rod driven into the basement floor. Another of you must be having similar problems, in that there is so much rf in the shack, that

RTTY output must be limited to ten Watts or so, or else...

My thanks this month to Bo Barry W4GHV of Las Cruces NM, Elliot Hamilton WA9JIQ of Arlington Heights IL, Anson R. Hyde, M.D. K4EK of Virginia Beach VA, and our old friend from the 68xx camp, Clay Abrams K6AEP, of San Jose CA, for their many contributions regarding their experiences with the PC.

Other machines have not been so lucky, however, and I still am at a loss for our friends running the Osborne 1. Is anyone out there running an Osborne 1 on RTTY? This column has several devoted—but frustrated—readers who would love to put their attachés on RTTY but lack the software. Any knowledgeable folks out there? Let me know. Thanks.

Ditto on the Timex/Sinclair. It seems that a lot of folks picked one of these little computers up for a song or got one as a premium with this or that electronic (or nonelectronic) purchase and now look wistfully at the keyboard and display and wonder. Well, so do I. I have received questions, but few answers. If anyone is running one of these wonders on RTTY, drop me a line, OK?

Okay, folks, listen up—now I've got a problem. A few months ago, I mentioned that Bill Davidson KW4J is using a partic-



The RTTY corner of C. A. Waterhouse W4INM's shack.

ular RTTY program on his TI-99/4A. I need to contact you, Bill, and can't find your address anywhere. So, if Bill is reading this month's column, or someone is reading it who knows Bill and can get this to his attention, I would appreciate a little note in the mail or via CompuServe. Thanks.

Received a note from Robert Holland, M.D., Ph.D. K7PCJ who is having some trouble finding the XR-2206 function generator used in the simple AFSK generator detailed here a few months back. Well, when I wrote that column the chip was hanging prominently on the wall at my local Radio Shack. Unfortunately, it has been dropped from their latest catalog. It is still quite available, however, from a variety of sources. James Electronics includes it in their blister-packed wall display available from a number of local outlets, as does Digi-Key and a number of other parts suppliers. Look around at some of your local electronics stores and you may be surprised.

Ron Vickery, one of our readers from Eilenboro NC, writes a few, as he puts it, "basic questions." He has acquired an old Allied R-100 general-coverage receiver and wonders if he can use it on RTTY. Ah, Allied Radio—that sure brings back memories. Back in my Novice days we used to pick our parts from thick newsprint catalogs produced by Allied, Lafayette, and several others. Now, but a memory. Oh

well, back to the question. Ron says that the receiver has a beat-frequency oscillator (bfo) and implies that it receives sideband as well. But, he keeps seeing where the ads push digital dials and such for mucho buckolas.

Ron, if the receiver receives sideband it should work fine on RTTY. Receiving the two modes requires much the same technique, and drift that would render a RTTY signal unreceivable would render a sideband signal unintelligible. What you will need is any of the "interface" boxes that we used to call terminal units, or TUs, also known as demodulators. This box takes the audio, tapped from the earphone jack or speaker, and converts it into the on-off or plus-minus voltages of a TTY loop or RS-232 computer interface.

You said that you have a CoCo (TRS-80 Color Computer), and that will be a fine computer to get onto RTTY with. We will be covering some of the available software in the very near future right here, so stay tuned.

On the air with AMTOR, Larry Hawes KA4QZQ of Venice FL is looking for the best filtering between the receiver and his AMTOR unit. Well, Larry, I guess the key word is "active." Those little op amps and chips have pretty much replaced the boards of donuts that we used to have in the days of 88-mH toroidal coils. I have seen a number of active-filtering schemes,

and I don't have any current information as to which is the "best," and why. Will try to print what I can, though, as your cohorts let me know what they are using. (Hint, hint.)

Getting kids into amateur radio has always seemed like a good thing to do, and David Peterson in Osseo, Wisconsin, is doing just that by incorporating amateur radio into his high-school communications class at Osseo-Fairchild High School. I do wish you the best of luck, and hope that the material I sent you at your request will be a help.

While it isn't exactly RTTY, I have never been bound by that before, so let me tackle a question sent in by Guy Roussel, M.D., of Lincoln, Maine. Guy is interested in the WEFAX program, a program designed to decode weather and other facsimile transmissions and display them on the screen of a CoCo. Specifically, he would like to find a version of the program for the Commodore 64 computer. Well, sorry, Guy, but when I put that question to Marty Goodman, M.D., one of the sources of the program, he told me that the program just cannot be adapted to the C-64. Problems include the less powerful CPU in the C-64, as well as other restrictions in hardware. With hardware prices falling, why not bite the bullet and switch over? I think you will be surprised at the power of the 6809 CPU, which can even run a sophisticated sys-

tem like the UNIX-like OS-9 and still be friendly enough to play games.

Well, I asked about a "shack of the month" photo, and here is the first one. This is the RTTY corner of C. A. Waterhouse W4INM. He has a number of Teletype® Model 32 and 33 machines and agrees with me that there is no such thing as a "standard" call control unit. It looks like quite a setup; one only wonders what the XYL says when all the machines are chattering away! Thanks for the photo, and I look forward to receiving others.

As always, I enjoy all your comments and questions, which have been coming in both via mail and CompuServe. I'm trying to keep up with the responses, and I think the stack on my desk is smaller than ever. Of course, electronic mail is normally answered on the same day, so send it to 75036,2501 on CompuServe, and I'll see what I can do. Yes, the reprint list is still available for a self-addressed, stamped envelope. It grows every now and then, so if you think you might be missing something, I won't be upset if you ask for another. Just drop me a line, with an SASE to the above address.

More next month on a variety of topics. With the spectrum ranging from grease-bangers to computers to WEFAX, I guess you never know what might turn up in "RTTY Loop."

ABOVE AND BEYOND

Peter H. Putman KT2B
84 Burnham Road
Morris Plains NJ 07950

Before I go on with this month's column, let me say that while I do consider myself a bit more proficient on VHF/UHF than the average ham, being an "expert" of sorts doesn't protect one from our dear friend Mr. Murphy when he decides to play havoc with a station. Let's now consider a case in point: The use (and misuse) of mast-mounted preamplifiers.

Why use a mast-mounted preamp at all? (Why, indeed, I've been asking myself, as you'll soon see!) There are a few reasons, but the primary reason is to provide sufficient preamplification of weak signals to overcome transmission-line losses.

Let's assume you are trying to work weak signals on 432 MHz. Assume for the moment that your receiver front end has a noise figure of 3 dB. Assume also that you are using a run of 8214 Belden coax and have feedline losses of 3 dB. If you want to hear a signal in the noise or at the threshold of your receiver noise, you've got to make up at least 9 dB of gain someplace! This would overcome the 3 dB loss of your feedline and also the additional noise generated by such a preamp, leaving you with about 3-5 dB of additional signal to work with, placing that same signal at about S_{1/2} copy. Still not a great signal, however.

The problem is that you can't use the preamp at the receiver input, for you've already added 3 dB of loss in your feedline to the already weak signal, putting it 6 dB below the threshold at which you can detect it (3 dB below the noise figure, which is also 3 dB!)

The answer is to put the preamp at the antenna, or tower head. Only here can the full benefits of a preamp be realized in such a situation, for the signal is already

3 dB stronger when it arrives just by overcoming feedline loss. Assume you feel that a signal must be at least S₁ for you to be able to copy it clearly. Then your preamp must be able to supply at least 12 dB of gain: 3 dB to overcome your receiver's noise figure, 3 dB to overcome the feedline loss, and 6 dB to raise the signal from noise threshold to about S₁ copy.

This presupposes that your preamp generates no noise—which is not the case. It, too, will generate a certain amount of noise, and this noise will have to be added to the overall calculations. Now let's get a bit more up-to-date and revise those figures to take into account the latest developments in receiver front-end design, transmission lines, and preamplifiers.

Now your 432-MHz receiver has a noise figure of 2 dB, using the latest in microwave bipolar transistors. And you've spent a few bucks on a GaAsFET preamp with a claimed noise figure of 1 dB. You've al-

ready made up 3 dB of difference right there over the previous setup. And you also decide to change to Belden 9913 coaxial cable, which gives you only 1.5 dB of loss.

Now you have to overcome a total of 4.5 dB instead of 6-8 dB using the previous setup (and that assumes the previous setup used a preamp with noise figure of 2 dB). If your preamp has a claimed gain figure of 15 dB, that means that the net gain at the receiver front-end stage (after overcoming front-end noise) is 10.5 dB, which is almost a two-S-unit increase! Now the signal that was in the noise is clearly readable. Quite a difference from before!

Of course, you can make additional improvements by going to lower-loss transmission lines and bigger antenna arrays. The problem is that there will always be another signal "just in the noise" to confound and frustrate you. Ah, the problems of the UHF aficionado...

To get back to the story, I decided that a mast-mounted preamp was just the ticket. Murphy was standing behind me at the ticket window, looking over my shoulder. Was I in for it!

By way of setting the scene, I use a Kenwood TS-430S at 28 MHz as my i-f for a

432-MHz microwave module. The noise figure of said module is about 1.7 dB. I also use an array of four F9FT 21-element yagis on an H-frame to yield about 20 dB or so over an isotropic dipole.

The transverter and antennas are connected by about 70 feet of Prodelin 1/2" Spiroline cable, which has about 1.5 dB of loss per 100' run. My loss then calculates to about 1 dB, meaning that I would have to overcome about 2.7 dB of noise and loss to compensate. If I wanted to bring a signal that was "in the noise" up to about S₁, I would need a total of 9 dB of gain.

Another 6 dB would raise it to S₂, so the total gain of the preamp would have to be about 16 dB (assuming -1 dB for the noise generated by the preamplifier). The Advanced Receiver Research 432 VDG seemed like just the thing, as it claimed 16 dB of gain with a .5 dB noise figure.

Initially, I tried two Dow-Key relays to put the preamp in the line on receive and take it out on transmit. The relays were SPDT types, and a footswitch in the shack operated them along with the transverter standby switch and amplifier bias control. When 26 volts was sent up the tower, the relays energized and the preamp was bypassed. This worked fine for about one day before Murphy got to it. Apparently, a spike got into the GaAsFET and blew it to pieces, for I hadn't sufficiently protected against spikes by using bypass capacitors and diodes across the relay coils. SCORE: Murphy 1, KT2B 0.

No problem. I connected a 1N4004 rectifier and bypass capacitor across each relay contact and, after repairing the blown device, re-installed the preamp on the tower. So far, so good. This particular lashup lasted almost a week before Murphy discovered the rf-sensed keying line in my MMT 432/28S transverter. While demonstrating the station to a friend, the microphone gain was inadvertently set too high, and the TS-430 keyed, driving the transverter sufficiently so that the Mirage D1010N amplifier I was using fired a bolt of about 50 Watts up the feedline to the input of the preamp. Kaboom! SCORE: Murphy 2, KT2B 0.

Long hours of research and thought



Photo A. The ARR sequencer. The two RCA jacks bring in the PTT line and key the bias for the amplifier. Additional closures are available through the terminal strip.

You read about it first in the New Products section of ham radio:

"Many methods have been offered for learning Morse Code, some good and some not so good. **This is a good one.**"

- ➔ Have you plateaued at 10-13 WPM? MASTER the code in 40% less time.
- ➔ The method based on the scientific principles of Skill Acquisition and Perceptual Learning

Adopted by the U.S. MILITARY as the new training standard

Four cassettes teach the entire alphabet in 25 trials at 20 WPM!
Includes numbers, punctuation, special characters, and an all new intro tape.

Send _____ set(s) @ \$19.95 each
IL res. add \$1 sales tax (5%)

Name _____

Call _____ Class _____

Address _____

City _____ State _____ Zip _____

Mail to: TSG; PO Box 3897; Carbondale, IL 62902

Send ck./M.O. in U.S. \$\$\$

We pay postage

Allow 4 wks delivery
Dealer inq. welcome

73-2

New for
KENWOOD TH-21A, 31A, 41A
a *Fastcharger* by
Charge-Rite
safely charges in 15 minutes



INTRODUCTORY PRICE

\$54.95

+ \$3.00 shipping and handling
FL res. add 5% sales tax

Features:

- Charges in 15 minutes
- Constant Current
- Automatic Voltage cut-off
- Battery doesn't heat-up
- 12v-14vdc input
- Charge from any point in discharge cycle without developing "memory"
- Proven in daily use

Optional AC adapter with DC and mobile cords available \$19.95.

Charge-Rite

Call and talk with
Paul WB4WIG or
Dr. "S", WA4DRV

P.O. Box 4175, Vero Beach, FL 32964 (305) 234-4448

THE VHF SHOP

ORDERS QUOTES **1-800-HAM-7373**

Information & Pa. Residents
Call (717) 474-9399

ASTRON — SALE!			
RS-7A	45.00	RS-35A	123.75
RS-12A	62.75	RS-35M	138.95
RS-12M	78.95	VS-35M	156.95
RS-20A	79.95	RS-50A	179.95
RS-20M	96.45	RS-50M	203.25
VS-20M	114.95	VS-50M	223.95

KLM			
2M16LBX,220-22LBX,432-30LBX-90.50			
2M-14C-85.50		2M-22C-108.50	
435-18C-110.50		435-40CX-144.50	

KENPRO ROTORS			
KR400/KR500		125.95/154.95	
KR-5400/KR-5600		247.50/309.95	

HENRY AMPS	
2 KD CLASSIC	965.00
2002A/2004A Less Relay	1250./1350.
3002A/3004A Less Relay	2100./2100.

AMP SUPPLY	
LK-500ZB	1,097.95
LK-800A	\$2,045.00
MIRAGE-FREE UPS BROWN ON ALL MIRAGE	
A1015 - 235.50	C-22A - 85.95
B23A - 83.95	C-106 - 169.95
B215 - 245.90	C-1012 - 246.95
B108 - 149.95	D-24N - 177.50
B1016 - 235.50	D-1010N - 279.50
B3016 - 199.50	D-3010N - 251.00
MP-1 - 99.95	MP-2 - 99.95

TONNA F9FT ANTENNAS ARE BACK! WE ARE THE EXCLUSIVE U.S. DISTRIBUTOR INTRODUCTORY SPECIAL:
1269/1296 QUAD ARRAY COMPLETE WITH 4-23el YAGIS; 'H' FRAME; POWER DIVIDER; PHASING LINES; CONNECTORS.
GREAT FOR OSCAR MODE 'L' OR TERRESTRIAL APPLICATIONS. REGULARLY 339.95 SALE PRICE 215.95

OTHER GREAT, HIGH PERFORMANCE ANTENNAS BY TONNA (CALL FOR SPEC. SHEET!!)			
5 EL. 6 METER YAGI	69.95	13 EL. 2MTR YAGI	59.95
21 EL. 70cm YAGI	56.95	23 EL. 1296/69 YAGI	46.95
(ATV MODELS IN STOCK)		17 EL. 2MTR SUPER YAGI	88.95
70cm OSCARTWIST	68.95	55 EL. 1296 SUPER YAGI	68.95
2 x 19 EL.(38el.)		9 ± 19 el OSCAR ANTENNA 2M & 70cm ON A COMMONBOOM-GREAT FOR STACKING	75.95
		19 EL. 70cm YAGI	44.95
		2MTR OSCARTWIST	65.95
		2 x 9 EL. (18el)	

WATCH OUR AD FOR NEW LINES!!

FOR THE BEST DEAL IN TOWN CALL THE BEST NUMBER AROUND 1-800-HAM-7373

CUSHCRAFT AOP-1 OSCAR PAK-133.95 RINGO RANGER II (2-220-440)-33.95
KENWOOD TS-940S/AT - CALL US! YAesu FT 757GX XCVR ... CALL US
KENWOOD TR2600A H.T. - CALL US! YAesu FT 726R CALL US

KENWOOD
FACTORY AUTHORIZED DEALER
CALL US FOR AMERICA'S LOWEST PRICE ON ALL YOUR KENWOOD NEEDS (FREE UPS BROWN ON KENWOOD GEAR)

CUSHCRAFT			
215WB - 73.00	A-3	200.45	
4218XL - 91.00	A-4	267.45	
R-3 - 250.95	40-2CD	267.45	

CUE DEE THE SWEDISH BOOMER
USED BY MANY TOP '10' CONTESTERS
144-15AN 2MTR15EL. 75.95

PARABOLIC			
1296-28 IW TRANSVERTER		339.95	
1269-144 3W UP CONV.		319.95	
1296 DUAL TUBE AMP CAVITY		439.95	
2PORT POWER DIVIDERS (2-220-432)		50.95	
4PORT POWER DIVIDERS (2-220-432)		55.95	
1296 2PORT DIVIDER		57.95	
1296 4PORT DIVIDER		62.95	
1269/96 DISH FEEDS		89.95	
2304 DISH FEEDS		89.95	
1296 SLUG TUNERS		65.95	

YAesu — FACTORY AUTHORIZED DEALER CALL FOR THE BEST DEAL AROUND ON 'THE RADIO' FULL LINE (FREE UPS BROWN ON YAesu GEAR)

MUTEK LTD.
DO YOU OWN AN ICOM VHF XCVR? DO YOU WANT TO IMPROVE THE RECEIVER - TRY OUR MUTEK FRONT END BOARD - YOU'LL BE GLAD YOU DID!
RPCB211/251 RD FRONT END 143.95
FOR ICOM 211 OR 251
RPCB271 FRONT END FOR ICOM 271A OR 271H 168.95
RPCB225 FRONT END FOR YAesu 221/225 143.95
SLNA 50S 6MTR PREAMP 84.95
SLNA-144S 2MTR PREAMP 84.95
100WRF SWITCHED, N.F.<ldB,GAIN 15db. 172.95
SBLA144E 2MTR MAST MOUNT R.F. SWITCHED PREAMP,250W THRU POWER, N.F.<ldB15dbG 169.95
GLNA 433E 70CM MAST MOUNT R.F. SWITCHED PREAMP,50W THRU N.F.<ldB G=15db 172.95
GFBA-144E 2MTR MAST MT. PREAMP, 1KW THRU POWER G=15db N.F.<8db WITH AMP SEQUENCER 289.95
GLNA-432E 70cm MAST MT PREAMP, 500W THRU, G=15db N.F.<ldB. WITH AMP. SEQUENCER 299.95
HIGH D.R. DBM XVRTRS FOR±2MTRS COMING SOON!

SSB ELECTRONIC	
K6001 6 To 10 DBM RCV CONV.	115.95
K2001 2 To 10 DBM RCV CONV.	115.95
K7001 70cm To 10 DBM RCV CONV.	115.95
K2301G 23cm To 10 or 2 RCV CONV.G.F.FRONT END AND DBM	159.95
TV-144-28-10 10W 2MTX XVRTR	209.95
TV-432-28-10 10W 70cm XVRTR	299.95
TV-220-28-10 10W 1¼M XVRTR Coming Soon	
DX-144 PREAMP N.F.<.4db	130.95
DX-220 PREAMP N.F.<.5db Coming Soon	
DX-432 PREAMP N.F.<.5db	130.95
(WON DAYTON 1985 N.F. CONTEST)	
DX-1296S PREAMP N.F. .5db	156.95
DX-2320 PREAMP N.F.<.8db	166.95
PA-2310 1269/1296 10W LINEAR AMP.	275.95
LT-23S 1296 10W LINEAR TRANSVERTER	610.95
2MIF	610.95
LSM-24 1269-2 OSCAR MODE L XMIT CONV. 1W	
OUTPUT, 2M.I.F.	299.95
MICROLINE 13 ½W 2.3GHZ XVRTR SYSTEM 2M.I.F.	410.95
MICROLINE 13 3W 2.3GHZ XVRTR SYSTEM, 2M.I.F.	675.95
SLA-13 2304 3W AMP	285.95

MAST MOUNTED PREAMPS:
MV144V 250W R.F.SWITCH WITH 12V SUPPLY INTERFACE 175.95
MV432V 150W R.F.SWITCH WITH INTERFACE 185.95
MV-144S-01 1KW THRU PWR WITH SEQUENCER 309.95
MV-432S-01 500W THRU PWR WITH SEQUENCER 319.95
MV-1296S 100WTHRU PWR WITH SEQUENCER 349.95
OTHER HIGH QUALITY PRODUCTS IN STOCK-CALL FOR CATALOGUE

TERMS: Prices are subject to change without notice. Some COD's may require a deposit prior to shipment. Unauthorized returns will not be accepted. Authorized returns will be subject to a 15% handling charge at our discretion. Orders placed will be considered firm and non-cancellable. Refunds will NOT be issued in cash or bank credit, but will be issued against future purchases. All prices are FOB Mountaintop, PA or point of origin. Prices do not include shipping unless indicated. We are not responsible for damages to merchandise by the delivery carrier.

16 S. Mountain Blvd Rt 309 HOURS: Monday thru Friday 9 AM-3:30 PM
Mountaintop, Pa 18707 Saturdays 10 a.m. - 12 p.m.

"24 HOUR PHONE SERVICE MC/VISA/C.O.D FOR YOUR CONVENIENCE!"

brought this revelation: Why not energize the relays on receive and have them drop-out on transmit! This would provide additional protection against lightning strikes and mysterious voltage transients floating about when the station was off the air. Additionally, should the preamp fail while in use, I had but to cut off the operating voltage and it would be permanently bypassed by the coax relays. A stroke of genius!

In addition, I would employ a system of cascading relays to ensure that everything was keyed in the proper sequence—preamp out, relays switched, amplifier bias set, and finally, transverter in standby. (Needless to say, I disconnected the rf-sensing feature to avoid problems in that area!)

A chassis was fabricated for the sequencer. Four relays were scrounged from the junk box, and a power supply and switching circuit were devised. Each relay was a DPST type, which allowed me to use the second set of contacts to key the next relay in line. In theory, it should provide enough delay for everything to key up in order and prevent another rf blast into the preamp. When the transmit line was released, the relays would release in sequence, or so I hoped.

It just didn't work out that way, however, when Murphy got through with it. After several weeks of serious 432 DXing, he payed another visit to the shack and somehow got the sequence all jumbled up. Sure, they all keyed in the right order, but dropped out in the wrong order, and eventually one relay got caught in the wrong position. SCORE: Murphy 3, KT2B 0.

Shortly after this, I happened to be at the Dayton Hamvention and came across Jay Rusgrove W1VD at Advanced Receiver Research. I suspect it was because of me that he had just introduced a new product: a mast-mounted amplifier sequencer, using linear circuits to achieve a consistent ramping effect so that all devices connected to it would key-up and drop-out at the same time, every time.

At \$49.95 it seemed reasonable. (I had already spent almost that in GaAsFET repairs!) I purchased his last unit. The unit was installed in a box with all connections brought out to one end for easy access (see photo A). The unit employs four relays as it comes from ARR: one SPST normally-closed relay, and three SPST normally-open relays.

The first relay supplies the voltage to the preamp and antenna relay, while the next three key-up and set bias, set PTT lines, or put transverters into standby. The unit employs a 555 timer to ensure a solid closure no matter how short the PTT interval is. This in turn drives an LM3900 which functions as an integrator to provide a linear up and down ramp effect to drive the two dual comparators, types LM319.

Each has a threshold-voltage level on its input and each changes state on the up and down ramps according to that trigger voltage, keying the appropriate relay. The entire sequence takes about 30 millisec-

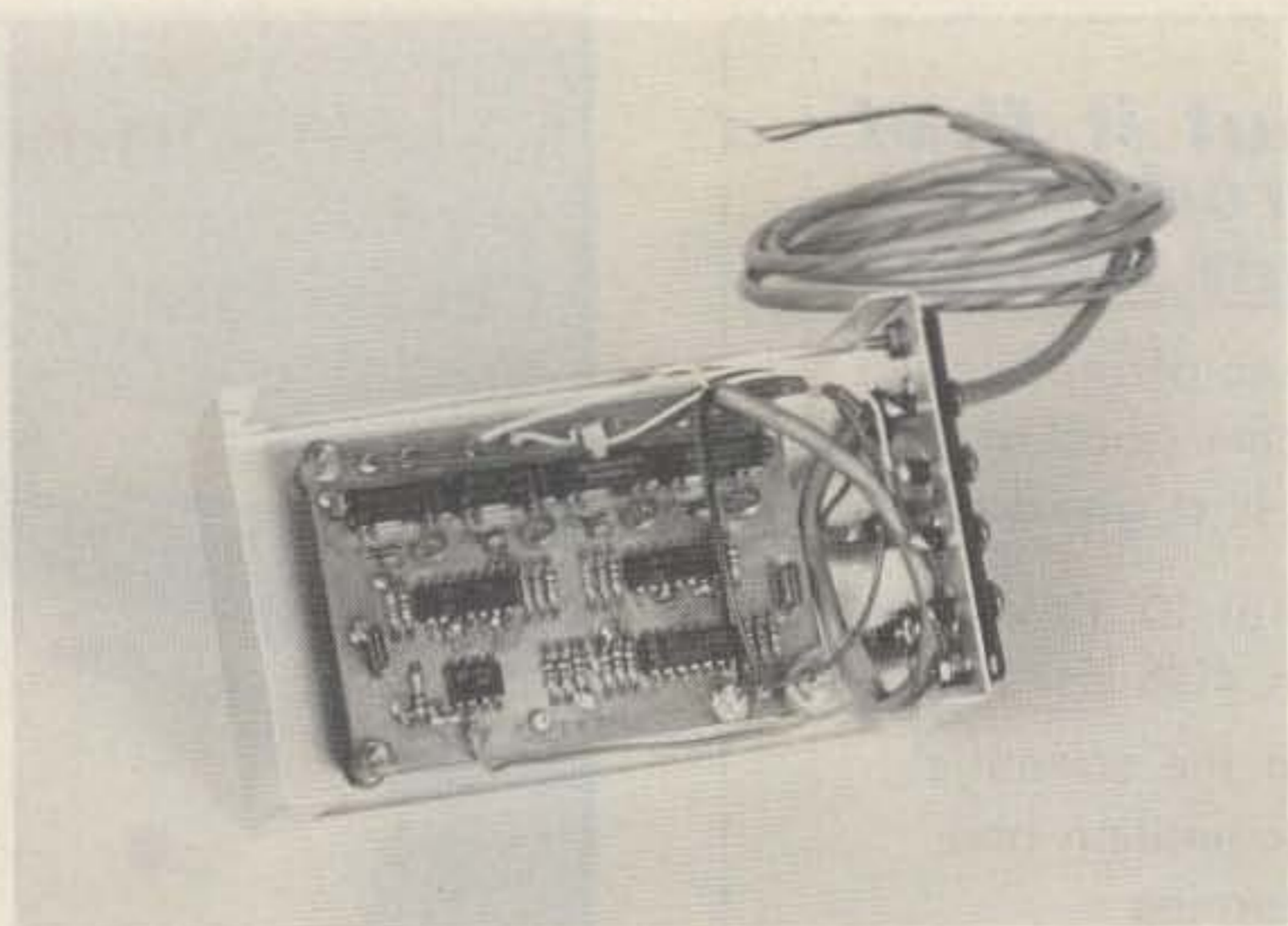

Photo B. The sequencer with cover removed. Two SPST NO-type relays are installed, upper left on the circuit board.

onds, which is enough to ensure that everything is settled before rf is applied.

Although Jay recommends that the preamp and antenna relay be keyed at the same time through the first relay, which is the SPST NC type, I couldn't do this (because of problems with different supply voltages) until I used a voltage-dropping scheme at the tower head. The 432 VDG preamp uses a 5-volt regulator and 28 volts would have been too much to handle, so I dropped the voltage with a zener and resistor to about 15 volts. Unfortunately, I forgot to consult with Murphy after consulting with Jay, and he apparently got miffed. After about three weeks of moderately reliable operation, the zener either failed or the resistor opened. SCORE: Murphy 4, KT2B 0.

I called Jay again and advised him of the problem. After a short discussion (no, he didn't offer me stock in the company) I ordered a second SPST NC relay. My idea was first to remove the voltage from the preamp (13.8 V dc) and then release the voltage from the relays (26 V dc). The unit was modified accordingly, and Photo B shows a close-up of the sequencer with the new relay installed.

The Magnecraft type W171DIP relays on the upper-left portion of the board are both SPST NC types, and the W107DIP relays to the right are both SPST NO. The order of firing is left to right on transmit and right to left on receive. The power cord goes to a companion power supply which provides 13.8 and 26 volts for both the transverters and the mast-mounted preamp combination.

Believe it or not, this setup made it all the way through the September VHF Contest. I was able to work my weak signals—including WB4SLM from Grid EM85 in western North Carolina, over 500 miles away. Finally, I could reap the benefits of a mast-mounted GaAsFET without fear of accidentally blowing up the preamp.

Murphy was stumped! Had I actually

thwarted him at last? Not exactly, as it turned out. Murphy had one more card to play.

You guessed it. I blew up the sequencer. Apparently, while I was testing a few 4CX250 power tubes at 432 MHz for output, one bad tube either shorted out or went into oscillation. Something got into the grid bias line, and the relay which keyed the operating bias of -135 volts shorted internally, arcing through the LM319 comparator and taking the LM3900 integrator with it. As an added bonus and at no additional charge for his services, Murphy made sure that the preamplifier got a blast from the tube. SCORE: Murphy 5½, KT2B 0. (The 1/2 point was for the sequencer!)

Which brings us to the present. A recent trade brought in about 50' of 7/8" Andrew heliax cable, and another trade brought the two N connectors required. It can handle lots of power, doesn't generate any noise, and will give me another 1 dB of gain just by its lower loss rating. Best of all, I don't have to sequence it. Murphy is fuming now and has packed his bags to head out to parts unknown.

Let me add that I haven't given up on the idea of a mast-mounted preamplifier, however. A second ARR sequencer is in the line keying the transverter and amplifier bias, so I can confirm that the previous problem is not likely to happen again before I install my sixth preamp on the tower. Besides, think of the weak signals I could work with a 16-dB preamp and 7/8" hardline from a 20-dB array at 50 feet...

From the mailbag this month comes a letter by way of the Philippines. Jose Antonio B. Conde of Cebu City writes to tell of the increased activity on 144-MHz FM. Most operators, he says, use the ICOM 27A and small yagis. Other operators employ Kenwood TR-7950 rigs, and with all the conversation and QRM it makes for a lively situation on 144 MHz.

He also suspects that there are a few bootleggers around (no surprise here, we've got plenty on 2-meter FM, Tony!) but most QRM is not really intentional; it's just the product of too many stations on a small band.

Tony also inquires as to what could be purchased in the \$500-\$600 range in US dollars to outfit a good VHF-multimode station.

Well, in this country, Tony, you could put together an ICOM 271 multimode and KLM or Cushcraft beam for about \$600 and change. Or you could use an ICOM 290H and Mirage amplifier together with that same beam for about \$675.00. Of course, there are lots of used pieces of equipment

around. By far the cheapest way to get on 2m SSB is to use a 144-MHz transverter with a low-band radio; such a transverter, amplifier, and antenna in US dollars would run about \$425, giving you 100 Watts to a good-sized yagi. Hope this answers your question.

Frank White W8OY from Mentor, Ohio, writes in to inquire where he can locate RG-17 or RG-18 coaxial cable. For those readers who are unfamiliar with this type, it's a 50-Ohm, 3/4"-diameter, armor-jacketed transmission line that was quite popular with the armed services. It resembles garden hose, and the braid on the outside is quite strong and difficult to break through.

Frank, I don't know of any direct sources but here are some addresses you might try to locate this cable, or an acceptable substitute:

Madison Electronics Supply	Nemal Electronics
3621 Fannin Street	12240 NE 14th Ave.
Houston TX 77004	Miami FL 33161
(1-800-231-3057)	(1-305-893-3924)

Certified Communications	Texas Towers
4138 South Ferris	1108 Summit Ave.
Fremont MI 49412	Suite 4
(1-616-924-4561)	Plano TX 75074
	(1-800-272-3467)

Frankly, for the cost of such cable you might be better advised to use either 1/2" hardline or Belden 9913 RG-8/U coax. Either is more plentiful and both can handle up to a kW on 144 MHz with minimal loss.

Addendum

The reading public can be quite unmerciful at times, but in this case it is justified. Yours truly made a few bonehead statements in the October, 1985, "Above and Beyond" column regarding stacking of beams for extra gain in VHF and UHF operation.

Perhaps the biggest mistake was to try and condense a complex topic into a few paragraphs. I'll try to address a few mistakes as quickly as I can: First of all, increasing the size of an array at VHF or UHF (or at any frequency, for that matter) *increases* rather than *decreases* the aperture of the array (much like using a lower F-stop number on a camera lens; as you "open up" the aperture, more light is transmitted). Secondly, the front-to-back ratio can remain the same or improve, depending on the construction of the array. Thirdly, in many cases optimal gain achieved in stacked arrays actually can increase the side-lobe pattern, not decrease it. Side lobes *can* be decreased by changing the spacing between different elements of the array, but at the cost of gain. Also, the pattern of the antenna will change with the above adjustments. About the only thing I will say with certainty is that stacking beams does offer increased forward gain, and the gain figure as well as the radiation angle will vary depending on the distance between each element of the array (such as between four identical 432-MHz yagis).

As was stated in the October column, the recommended minimum spacing between yagis in such an array is at least half the boom length. For some of the newer long-boom high-gain yagis, this figure changes considerably. Again, the spacing between yagis will determine not only gain but radiation angle as well, often increasing apparent gain over long paths to more than 3 dB. Your best bet is to read more about it; there are several articles by Joe Reiser W1JR that deal with the subject more scientifically in the April and May, 1985, issues of *Ham Radio*. I'll try to present a more detailed and technically accurate treatment of this subject in a future column.

HAM HELP

I'm looking for a schematic and service information for a CR1/43044 transmitter/receiver manufactured by the Colonial Radio Corporation.

Mickey Knight N4LVN
144 Del Ray Court
King NC 27021

I am looking for an owner's manual or service information for a Hammarlund HQ-170 receiver. Please let me know how much it will cost.

Columbia Communications
PO Box 8117
Lowell MA 01853

COMMUNICATE

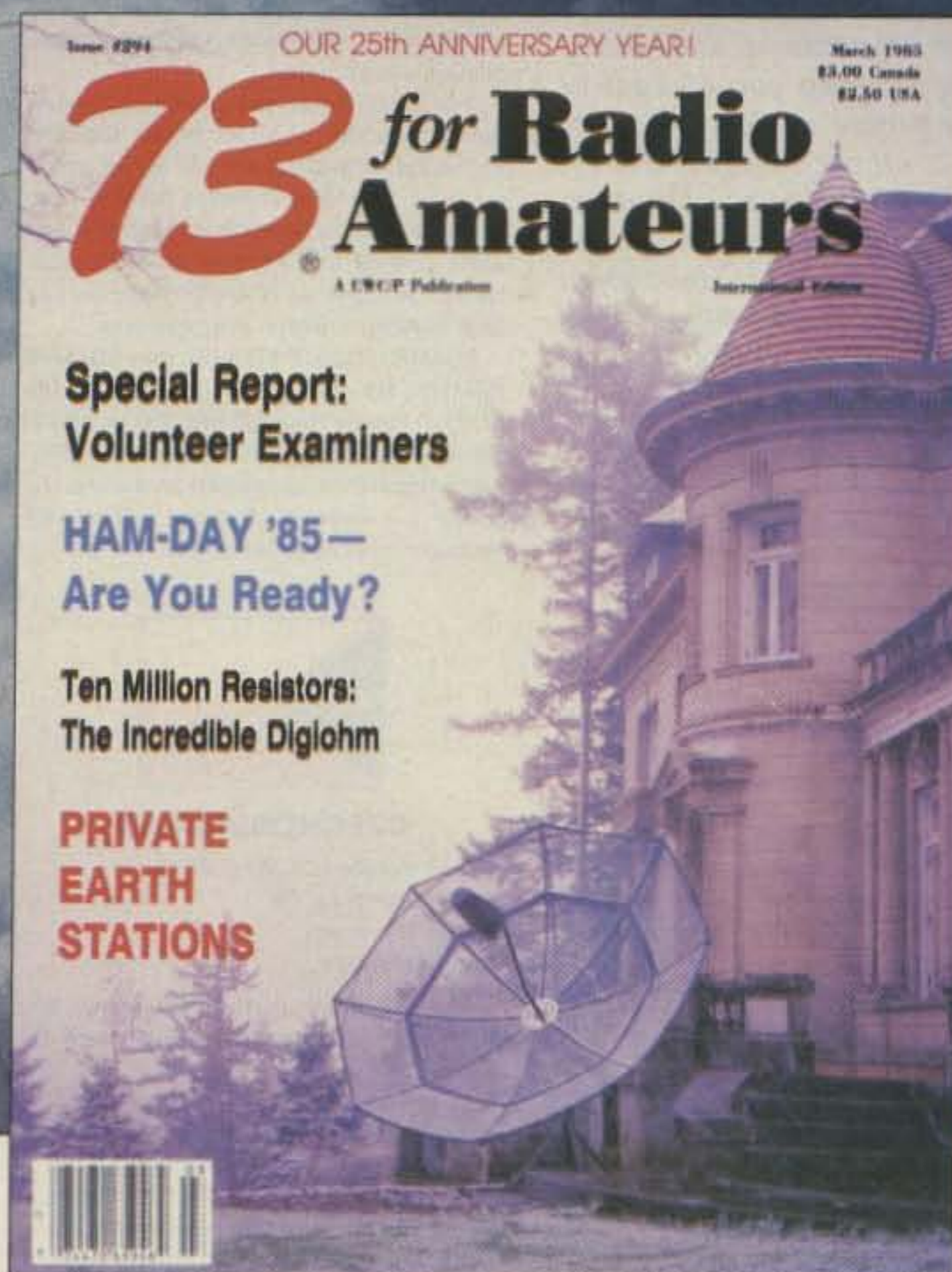
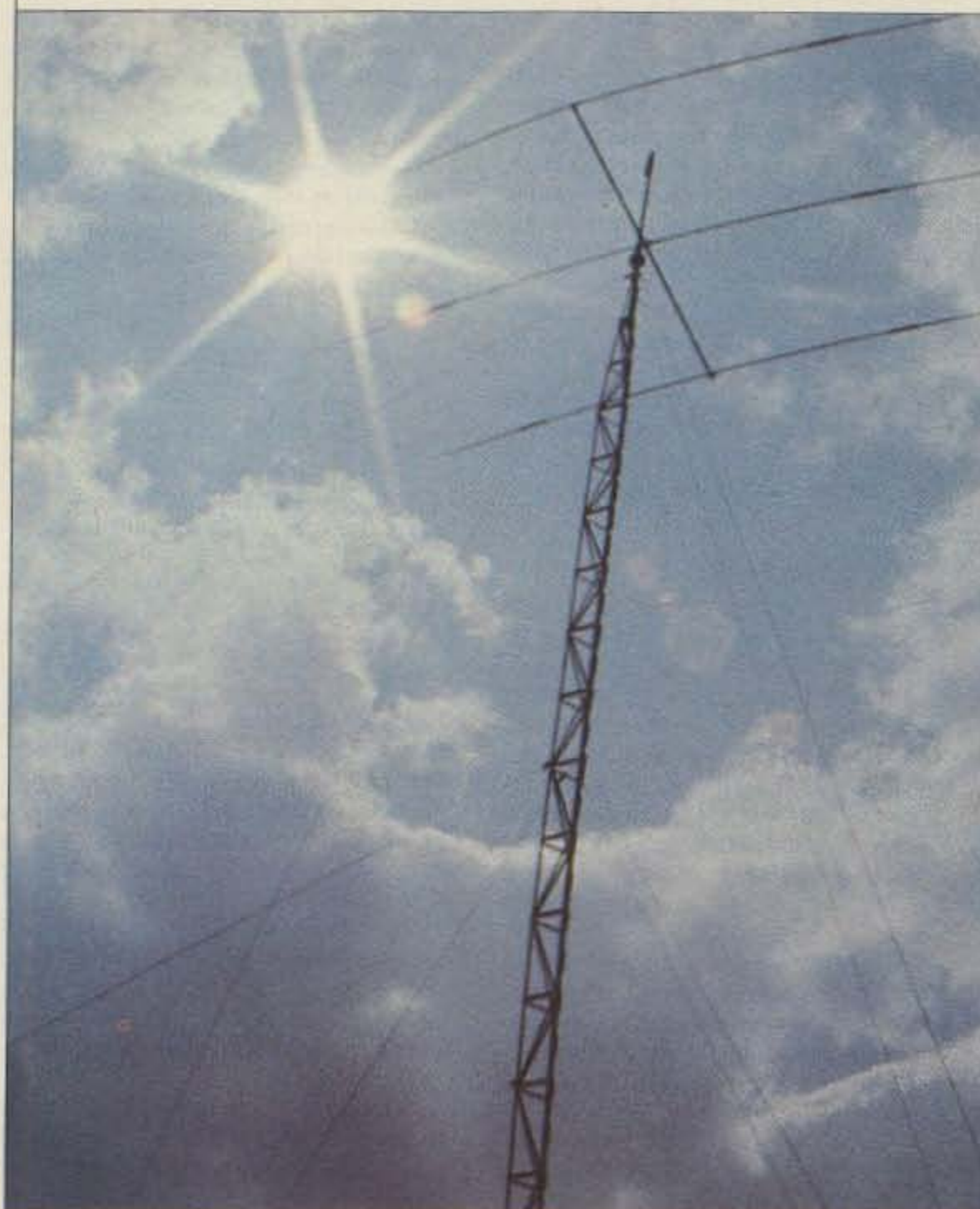

FIRST WITH US,
THEN THE WORLD!

Better communications start with your subscription
to **73 for Radio Amateurs**

YES! Start my no-risk subscription today and send me 12 issues
of 73 for \$19.97. I'll save 33% off the newsstand price!

CHECK/MO Bill Me (please make check payable to 73)

Name _____

Address _____

City _____ State _____ Zip _____

Canada & Mexico \$22.97, 1 year only, US funds drawn on US bank.
Foreign surface \$39.97, 1 year only, US funds drawn on US bank.
Foreign airmail, please inquire. Please allow 6-8 weeks for delivery.

73 for Radio Amateurs
PO Box 931, Farmingdale, NY 11737

361R6

Each month, 73 brings you ham-radio news from around the world. In this collection of reports from our foreign correspondents, we present the latest news in DX, contests, and events, as well as keep you abreast of the technical achievements of hams in other countries.

If you would like to contribute to your country's column, write to your country's correspondent or to 73 Magazine, Pine Street, Peterborough NH 03458, USA, Attn: International Editor.



CYPRUS

Aris Kaponides 5B4JE
PO Box 1723
Limassol, Cyprus

Radio activity in Cyprus during the last few months was rather restricted, mainly due to propagation. But the regular dozen or so 5B4s were active mainly on 20m. Also during this summer, many foreign hams who came on holiday were working 5B4. These were mostly British, German, and other European amateurs. They usually operated on 2m with small HTs, but some operated also on HF from the shacks of 5B4 stations.

A very pleasant visit to my QTH was that by Frank DJ0QZ, who operated from my shack on HF. Also, I had another visit from a very good friend with whom I had lots of QSOs, OM Ezzat SU1ER, who also was visiting Cyprus as a tourist. Ezzat also met other 5B4s in Nicosia, who entertained him at their local radio club. We do hope that visiting amateurs in Cyprus will contact 5B4s when they arrive. We are sure that they will find the friendship and brotherhood that comes out of our hobby.

An activity organized by CARS for the first time ever was a national VHF contest. This took place in the 2nd week of August, and the winner will receive the CARS president's cup. We do hope to have more contests in the future.

Some interest is shown currently in RTTY and satellite operation. On RTTY, regular operators 5B4OP in Nicosia, and 5B4JE in Limassol with his harmonic, George 5B4OV. There also are a few other RTTY operators, but they are not very active. On satellite work we have Akis 5B4OA working OSCAR 10. Other OSCAR users are 5B4HF and 5B4KP (when he is in Cyprus). Trying to get ready for OSCAR are 5B4NG, 5B4RU, and 5B4CV. 5B4JE hopes to operate OSCAR 10 from the shack of 5B4CV, and during the winter will have a go at RS satellites. I would like to thank, through this column, Giannis SV1DO, who sent me a program for OSCAR and gave me all the recent Keplerian elements. It gave me a few moments of excitement and pleasure when I heard OSCAR for the first time.

Official permission was given to Cyprus amateurs for the use of special prefix

5B25 by any station wishing to do so—from the 16th of August until the end of last year—to commemorate the 25th anniversary of the independence of the Republic of Cyprus. It seemed to be a popular prefix because when 5B4s appeared on the bands using it, terrific pileups were created.

ZC4 activity at the moment comes mostly from the base of Dhekella. Stations at the Episkopi base are not active at the moment. ZC4AP was heard coming from the Akrotiri base, and my very good friend Andy ZC4AM told me that as of October he will be active as ZC4AM/P from the salt lake of Akrotiri within the base area.

ZC4MR, 5B25JE (5B4JE), and 5B25MF (5B4MF) are checking regularly with the W7PHO Family Hour net with the very good company of Len KB2HK, net controller. Let's hope that propagation during the winter will improve, and we will be very happy to meet new stations on this net.

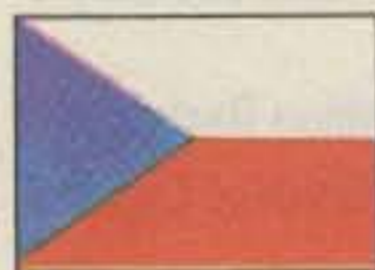

CZECHOSLOVAKIA

Rudolf Karaba (OK3KFO ARC)
Komenského 1477/8
955 01 Topolcany
Czechoslovakia

The evaluation of the best Czech and Moravian radio amateurs takes place annually. One Friday in January, 1985, the best radio amateurs met in Tisnov to receive prizes for their many years of service. The placings were determined by a vote of the members of the Czechoslovak Central Council of radio amateurs. First place was won by a world champion in radio-orientation racing and a master of sports, Ing. Mojmir Sukenik, with 270 points. Pavel Sir OK1AIY received 183 points and second place for his work on UHF. Third place went to Ing. Karmasin OK2FD for his work on HF (166 points).

In the 1984 VK/ZL RTTY DX Contest, three Czech radio clubs achieved the top scores in the multi-multi category. They occupied the first 3 places in the world in this order: OK3KJF, OK3RJB, and OK3KXJ.

Besides that, OK2-21478 won first place in the world in the SWL category. OK1DRX improved his RTTY operation by means of a ZX-Spectrum computer, and by means of this computer made contact with OK1VAT in the 145-MHz band.

AMSAT-OSCAR 10

From the end of April till the beginning of October, 1984, Jenda OK2EH, operating CW, made 150 contacts with 56 DXCC countries. He has been using electronic equipment of a multiplier type with an REE30B electron tube. The receiver is an MWEc with a converter. The antennas are a 12-element yagi for receiving and a 15-element yagi or a spiral antenna with 10 turns for transmission. All of them are adjustable in azimuth and elevation.

Radio club OK1KRA wrote that it had worked the following Czechoslovak stations: OK1AIY, OK1KHI/P, OK1DIG, OK1KTL/P, OK1DKS, OK1DTL, OK2AQK, OK3AU, and OK3RMW. OK1KRA is the first station from Czechoslovakia and the first from the socialist states that has worked 57 DXCC countries.

Some remarks made by an operator at OK1VPZ:

- It is necessary to listen closely. Our antennas are a 16-element F9FT yagi and a 2 x 9-element F9FT yagi crossed for a circular polarization with a preamplifier.

- For these antennas, it is necessary to have an exact prediction of the position of the satellite. It would be best to use a computer.

In one and a half years, Ondrej OK3AU has made, in mode B, about 2500 contacts with 67 countries. He has worked under other call signs as well: OK5MIR, OK5KWA, and OK0WY. Ondrej confirmed the sad reality that unnecessary overloading of the converter in mode B has not been changing for the better at all—on the contrary, the number of stations using enormous erp without improving their receiver system has increased.

Vlasta OK2VPA from Opava has also been working through AO-10/B, where she has made 100 contacts. She is most proud of her contact with the VS6XLA in Hong Kong.

RS SATELLITES

At present, during the period of quiet sunspots, there are good conditions for working via the RS satellites. At the beginning of 1985, OK3AU, OK3FH, and OK3ZFA were working regularly on them. Also, stations from Bohemia and Moravia, OK1DJW, OK1BMW, and OK2AQK, appeared. From time to time, some unique stations with special prefixes (EU, EO, EW, EV), station UA0KAJ from Kamchatka, and the JW stations from Spicberg can be heard.

Michal OK2BXF from Brno made contacts with 28 countries through the RS satellites. He made some contacts with an erp of 5 Watts through RS5. He heard himself with 15 mW of erp through the now-nonfunctioning RS6.

According to unofficial information, new satellites RS9 and RS10 have been successfully examined in Kaluga near Moscow. They ought to be launched into space at the end of 1985. The satellites will be equipped with two converters each: 145/29 MHz and 21/29 MHz.



FEDERAL REPUBLIC OF GERMANY

Ralf Beyer DJ3NW
Opferkamp 14
3300 Braunschweig
Federal Republic of Germany

TRAINING FOR SPACELAB

On Saturday, August 17, 1985, a Cessna 207 aircraft took off from Cologne at 1105 hours local time with astronauts Ernst Messerschmid DG2KM and Reinhard Furrer DD6CF aboard, in preparation for their radio-amateur activity during Spacelab mission D1. The flight was organized by the German Aerospace Research Establishment (DFVLR) in cooperation with the MBB-ERNO company and the University of Bremen. The purpose of this flight was to test the 70-cm/2m transceiver that the astronauts would use aboard Spacelab and to get the astronauts familiar with the pileup to be expected during their space flight.

The flight took about 4 hours and 50 minutes and covered a large part of Germany. A route of 1100 kilometers was flown at an altitude of up to 11,000 feet. Practically everybody in Germany had a chance to get in contact with the aircraft,

and even radio amateurs from Austria, Belgium, The Netherlands, and France were calling.

The astronauts used the call DF0LRK/air-mobile. This was the first radio-amateur activity from an aircraft to be authorized by the German FCC.

As usual, few radio amateurs were able to contact the astronauts directly. Many calls were taped, and it is hoped that the analysis of the 3-hour recordings will reveal about 300-400 callers. All stations identified will receive a QSL.

Messerschmid's comment, "They are calling faster than I can think!" showed that the astronauts really got a live demonstration of what may be expected during their space flight.

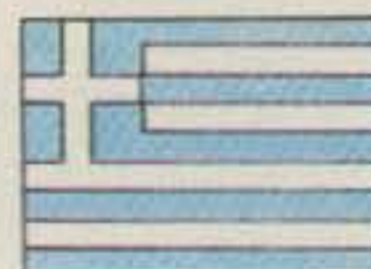

GREECE

Manos Darkadakis SV1IW
Box 23051
Athens 11210
Greece

The RAAG has a new address: Eleftherias Square 23-24, 105 53 Athens, Greece. Also there are two phone numbers: 3234527 and 3234624. Anyone who would like to be informed about reciprocal licensing, etc., is invited to write or phone.

Keep in mind that band allocations are not the same everywhere and information obtained from RAAG officials will prove to be very useful—especially when somebody wants to operate on the 2-meter band.

The annual meeting of IFATCA (air traffic controllers) was held last year in Athens from March 16-22. From the Royal Olympic Hotel (where the meeting took place), J4ATC was activated while the meeting was on, by W1BFA and PR0GJA. Although there was something missing in the call (should have been J41ATC), the station attracted a lot of DXers worldwide. I would like also to mention that Spyros Stefanou SV1IR was responsible for organizing this meeting; he did an excellent job.

A couple months ago, I was telling you about SV1JG, who took part in the CQ Worldwide WPX SSB contest. Today I feel proud to say that Greece, for the very first time in its radio history, has a continental winner in the single-operator allband category. Cliff, with his special call, J41JG, scored 1,667,576 and took first place in Europe. We hope next time Cliff will reach an even better position.

A new repeater will be active very soon from Enos Mountain on the island of Kefalonia. The new repeater operates on repeater channel 2 (145,650/050) and it is hoped that along with R8 it will cover all the Ionian sea area and the nearby mainland.

By the way, we are about to use up the string of two-letter call sign endings. If I am not mistaken, SV1ZZ has been issued already; we all expect to hear SV1ZZZ very soon.

MT. ATHOS

I would like to discuss a situation which has given a lot of trouble to many SV DXers, including myself, and some RAAG officials, too. As most of you know, Greece supports four DXCC countries—Mainland (SV), Dodecanese (SV5), Crete Island (SV9), and Mt. Athos (SV/A). To really understand the story, you need to know that since Mt. Athos is a rare place

not only to operate from but even to visit, there is always big demand for a QSO with this DXCC country.

In order to go there, you need a proper license from the Greek PTT which is conditional and requires a written permission from the Holy Community to be valid. Because of a very complex situation, it is very difficult to get permission to operate from there (a signature is needed from every leader from the 20 monasteries). The last organized and valid operation was back in 1980, by SV1DC, SV1IW, and SV1JG.

Since then a lot of Greek and foreign amateurs have tried to get permission but with no luck. To be truthful, it looks like somebody told the Holy Community of Mt. Athos that the only purpose of expeditions is for green stamps and IRCs! Personally, I believe that this is the reason for no permits since then.

Despite this, in 1984, DJ5CQ went there without a written permit from the monks and operated for a while. In 1985, DL7FT did the same thing. He claimed that nobody had had a written permit for the last 10 years.

This was going too far. I sent the German league a letter of protest and a copy of the original license which I obtained in 1980 from the monks, along with translations in German and English.

A little after this, another presumptive DXer followed for another two-day show. (Remember him as KF1O/CE0X?) That was another suitor for Penelope's hand. (You will understand if you know Greek ancient history.)

The conclusion, after all these attempts, was to force the RAAG to write a letter to the Greek Ministry of Telecommunications and ask it not to issue a license for Mt. Athos anymore unless the applicant has a written permit from the monks in hand! Apart from that, I sent informative letters along with copies of my license and translations in English and German to all major DX Bulletins and magazines in an effort to prevent people from wasting their time and money.

Mt. Athos is a fine place to visit and a real fine spot to operate from. Will we ever be allowed back?



GUAM

Edward L. Campbell KB6DAW/KH2
300a Rendova
APO San Francisco 96334

HAFADA ADAI FROM GUAM

Since propagation is poor and it looks like it is not going to get any better for a while, I thought it appropriate to bring up nets again—this time because there have been some good check-ins on them. And again, I will give times and frequencies that they are on.

To start off, I am a regular check-in for the 220 net with P29JS as net control. Lately, he has been on holiday and is back on Norfolk Island. His call now is VK9NS, but he will be returning soon. In his absence, VI2HD and I have been sharing the duties as net control.

Here are some of the check-ins that you will find on the net: VK9NL, FW8AF, 9M2MM, FT8XB, 3B8CA, YJ8RG, and 9V1TL, to name a few.

We have been blessed to have most of the DXpeditions check in with us, such as

HC8E, 6Y5NR/KP1, and XF4—just to name a few. So if you hear of an expedition, you might look for it on the net.

Also, those that have propagation at 1100Z can look on 14.195 for RF0FWW every Wednesday, for his net. 5X5GK has tried to check in the last couple of weeks. Also 9N1RNK has been known to check in.

I have had a chat with XU1SS, and they are beginning to be up on the air a little more. You will find them around 1100Z at about 14.195. They do a lot of CW, so you might get a CW contact.

Have been trying to check in with the PHO net, but it is hard to get in with most of the antennas pointed into Europe. Now this is at 2100Z. I have had some luck turning my antenna over Europe and getting in that way. Now TZ6FE has been checking into the net quite often. So if you need that one, look for him at 2100Z. Maybe some day I will get to work him. So you might look into this part of the world from time to time—you might be surprised!

I did put out that I was trying to go to Johnston Island for a DXpedition, but it was turned down. I went on a DXpedition to KH9 Wake Island from October 22 until November 4. The calls were as follows:

- KB6DAW/KH9 for SSB contacts
- KA6DAW/NH9 for the CQ WW Contest only
- NY6M/AH9 for CW contacts

NY6M is now on KH2, and his name is Gary Dein. And he is a good CW man.

All QSLs should go to the address above.

Well, more next time. 73 and hafa adai from Guam Island, where America's day begins!



HONG KONG

P. J. Weaver VS6CT
10A Bonaventure House
91 Leighton Road
Hong Kong

Sunday, June 2nd, dawned bright and clear with a 15-knot wind from the east. A Cessna 172 was airborne from Kaitak at 0830 to reconnoiter the course to a rock called Pedro Blanco, 50 miles to the east of Hong Kong. Hong Kong's first offshore power-boat race from a position south of Aberdeen out to Pedro Blanco Rock and return, a distance of 120 miles, was scheduled to start at noon.

There were ten power boats entered for the race, the largest being a Cigarette 27' and the smallest a Fletcher 21' with two 120-hp outboards. For safety purposes, mark boats were to be established every ten miles of the course. These boats were a real mixture: from the largest, a Techma 68', down to a Bertram 38'. All were well-found boats, and on each would be a radio amateur to handle communications, ship to ship and ship to aircraft, operating on channel 10, 156.5 MHz; all the hams were to keep in touch through the repeater on 145.650 MHz.

At 0900, the first mark boat started eastward, and by 1030 hours, it reported seas of up to 6 feet at times. When the aircraft had made its run the tide and wind had been running together, but with the turn of the tide at 0900, the wind against the fast ebb produced a short steep sea which the mark boats found difficult to cope with. By 1100, it was apparent that the mark boats were not able to get to their assigned positions.

The committee put on their thinking caps, and at 1130, having recalled the mark boats through ham radio, changed the course to run inside Hong Kong waters: It would be three times around a triangle from Lamma Island, just south of Aberdeen, to the Soko Islands, and thence to Potoi Island to make up to the original 120 miles.

It was still very bumpy going upwind, and Ramesh Murjani, the organizer, in his Cigarette 27' was the only finisher on a circuit shortened to two laps (80 miles).

Our thanks to Hong Kong hams VS6IC, VS6XPQ, VS6DK, VS6XPZ, VS6XPT, VS6DM, VS6GW, VS6CT, and Macau ham XX9WW, without whose assistance even the abbreviated race could not have been held.

In my last report I mentioned that Hong Kong was following the United Kingdom with a class B license for 30 MHz and above. At this time there are over 150 class B licensees.

A new club has been formed within the Hong Kong Telephone Company's Sports and Social Association due to the enthusiasm of one ham, Marvin Chan King Tung VS6XNR, to whom full credit must go, as without his drive and interest the club could never have started. They now have over 350 members, all employees of the Telephone Company, keen to pass the necessary examination and get their licenses. They will shortly establish a club station and be very active with their assigned callsign of VS6TS; they also have their own club repeater on two meters.

With the increase in local hams there is

a need for more repeaters, and the current two could well be expanded to four by the end of this year.

Just a brief reminder if you intend to visit Hong Kong and would like to operate. A visitor's license is readily available, so bring a copy of your home license with you next time you visit. The callsign assigned is your home call VS6. Call me at home on 5-772313, or Ed Nance VS6DX on 5-231358, for full details and information about what's happening in Hong Kong when you get here.



SWEDEN

Rune Wande SM0COP
Frejavagen 10
S-155 00 Nykvarn
Sweden

WORLDWIDE QTH LOCATOR

The origin for the QTH-locator (grid) system used by the European VHF/UHF enthusiasts was in the 1950s. For many VHFers, chasing QTH locators (such as IT50d, giving fairly good accuracy on the position of the QTH) has become an obsession comparable with the most avid HF-band chasers of new DXCC countries.

The original QTH-locator system had its drawbacks. It was designed for Europe, and if extended to cover worldwide, the system had to repeat itself, i.e., the same QTH-locator designation could mean quite different locations.

The increasing interest in using the QTH locators, not only as needed during VHF contests, but also because of the increased coverage of the world's surface that VHF/UHF operators have achieved, made it obvious in the mid 70s that a worldwide system should be designed.

Maidenhead Locator System

The European VHF managers held a meeting in Maidenhead, United Kingdom, in April, 1980, where Folke Rosvall SM5AGM presented the more than 20 proposals for a new locator system which had been received. The VHF managers found that the system proposed by G4ANB with the modification by SM5AGM should be put forward to IARU for adoption.

Folke SM5AGM started the work on an international scale for a worldwide locator system by presenting his ideas at the VHF-manager meeting held in Amsterdam, Netherlands, in 1976. In October of

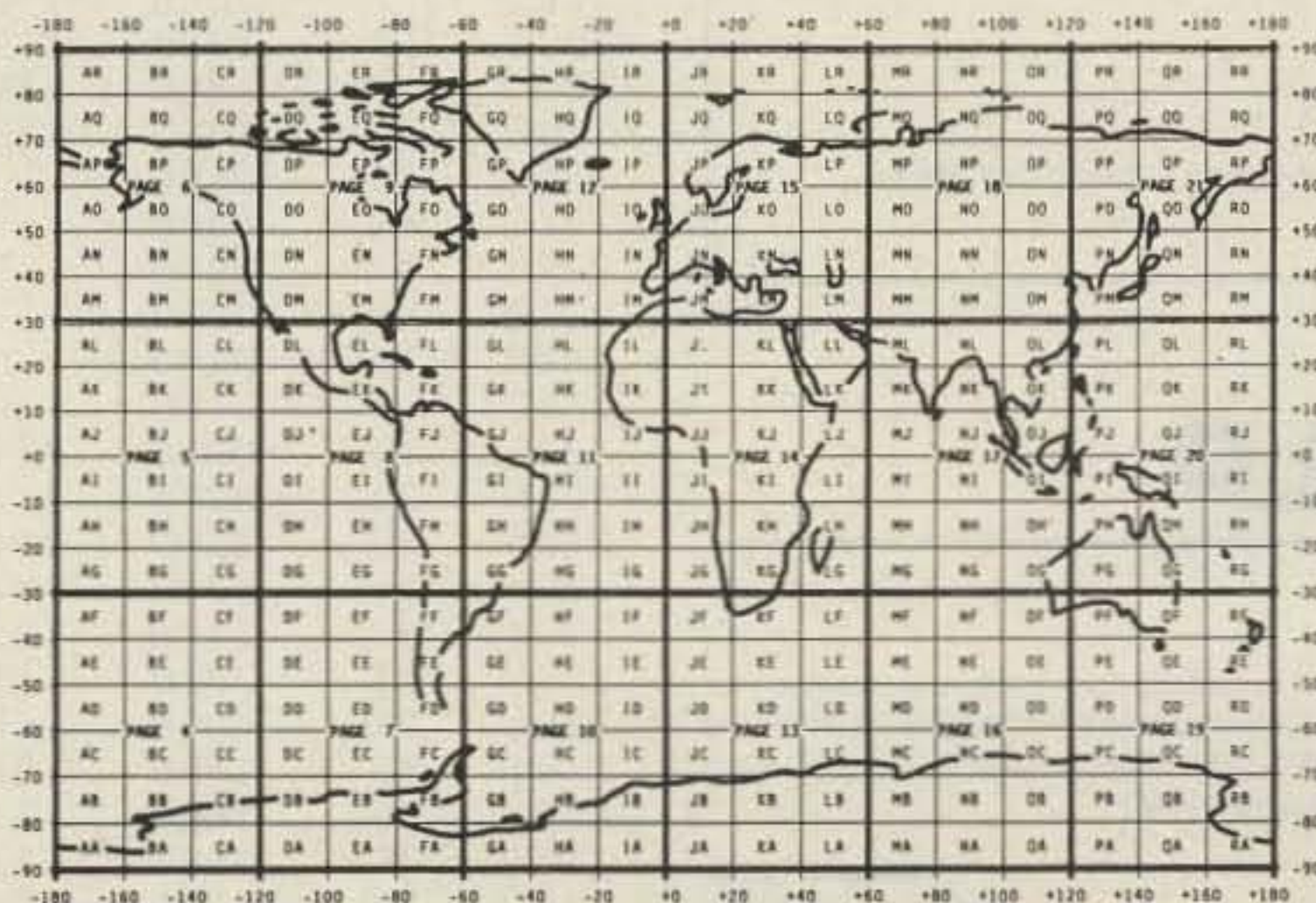

World map of the fields.



Folke Rosvall SM5AGM.

AMATEUR TELEVISION

NEW 70 CM ATV TRANSCEIVER

ALL YOU NEED IN ONE BOX

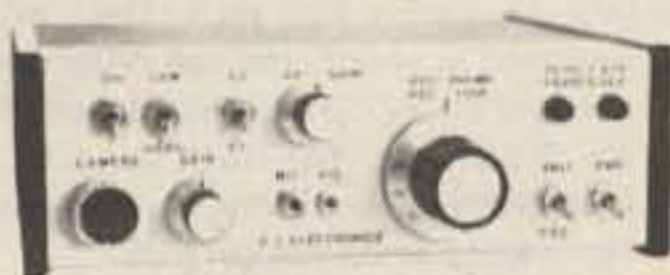

\$299 delivered
TC70-1

- **FULL COLOR, SOUND, & LIVE ACTION** just like broadcast TV. Get on this exciting amateur video mode at our affordable ready to go price.
- **WHAT IS REQUIRED FOR A COMPLETE OPERATING SYSTEM?** The TC70-1s downconverter outputs to any TV on ch 3 for receiving. Connect a good 70 cm antenna and low loss coax. Plug in any composite video source you want to transmit: Camera, VCR, computer, etc. Plug in any low Z dynamic mic or use color camera mic for Standard 4.5 MHz TV sound. Connect to 13.8 vdc for base, mobile, or portable. See chapt. 20 1985 ARRL Handbook. That's it!
- **WHAT CAN YOU DO WITH THE TC70-1 ATV TRANCEIVER?** Show the shack, projects, computer program listings, home video tapes, repeat Space Shuttle audio and video if you have a TVRO, repeat SSTV or RTTY, Weather Radar, do public service events such as parades, marathons, races, CAP searches and rescues... the list goes on. DX depends on antennas and terrain, typically 1 to 40 miles. We have video compensated RF linear amps for 20 (\$119) or 50 (\$189) watts pep for greater DX.
- **FEATURES:** Small 7x7x2.5". Push to Look (PTL) T/R switching. GaAsfet downconverter tunes whole 420-450 MHz band. Two switch selected video & audio inputs... RCA phone jacks and 10 pin color camera jack. Xmit video monitor output. Over 1 watt pep RF output on one or two (add \$15) selected crystal controlled frequencies. 439.25, 434.0, or 426.25 MHz.

CALL OR WRITE FOR OUR CATALOG for more info or who is on in your area. We stock antennas, modules, and everything you need on ATV.

TERMS: Visa, MC, or cash only UPS CODs by phone or mail. Checks must clear bank before shipment. Price includes UPS surface shipping in cont. USA, others add 3%. Transmitting equipment sold only to licensed Tech class or higher amateurs, verifiable in 1985 call book or copy of new license.

(818) 447-4565 m-f 8am-6pm pst.

P.C. ELECTRONICS

Tom W6ORG Maryann WB6YSS



2522 Paxson Lane
Arcadia CA 91006

from page 4

have to agree with them. After all, Chet's *Computer Trader Magazine* stands to increase its circulation due to the heightened (and free) publicity, and the equipment manufacturers also get to look good by donating prizes. In the end, the contest is just a way of using ham radio to increase sales.

An Answer?

You might have noticed that I applied a general rule of thumb in each of the four instances to decide whether it constituted commercialism or not. You can call this Donham's Law if you like: *If the action could eventually result in money exchanging hands, it is a definite no-no.* The solution to the problem of commercialism in our hobby is to place in the amateur rules this strict definition of business communications.

The new rule would not differentiate between commercial ventures and non-profit organizations (note that TAPR is nonprofit). The sole criterion would be the exchange of funds. No exceptions. With such a definition in place, much of the junk that we hear on the bands would disappear—then maybe these bells would stop ringing in my head.

Perry Donham

HAM HELP

I am looking for automobile and motorcycle amateur-radio callsign license plates for my collection. I will pay postage. I also have a few plates to trade.

W. C. Spenn KD5AK
Box 33081
San Antonio TX 78265

I'm looking for a computer interface for a Commodore-64 like the MFJ-1226 or the MFJ-1228. Also, I need a manual for a Heathkit HW-7.

Edward Turner
4376 W. Coolidge Rd.
Coleman MI 48618

1979 Folke proposed a system with 20° x 10° units, 2° x 1° smaller units, and 6' x 3' smallest units. Quite independently, G5ANB had designed a similar system.

The locator consists of two letters (the field) followed by two numbers, the square in the field, and two letters giving the position within the small square in the field. This system gives the position of the QTH with an accuracy of better than four kilometers (2.5 miles). On the HF bands and for the Field Award, it is enough to know the large unit, the field, i.e., the two first letters.

Folke has been the driving force for this worldwide locator system. Without his persistent work and refusal to let the opposition kill this effort, a worldwide locator system would probably still be far in the future.

The Field Award— A New Challenge

Now it is time to start collecting fields for the new Field Award issued by SSA, the Swedish National Amateur Radio Organization. The Maidenhead Locator System has been adopted by all three IARU Regions and has worldwide coverage.

Altogether there are 324 fields, and you surely will not work all of them in a year or two, if ever. 262 fields are covered by some kind of land, 8 fields are covered by permanent ice without land, and 54

fields are covered by open sea. Stations operating /MM and polar expeditions will be needed for working all fields!

What is my Locator or Field?

The *World Atlas* containing all 32,400 Maidenhead locator squares, produced by SM5AGM, will readily give you most fields by knowing the QTH of the station you have worked. If you want to have your own full locator, the booklet includes a computer program for the necessary calculations. You must find out your longitude and latitude in degrees and minutes.

If you have any questions on either the Field Award or the *World Atlas*, write to The Field Award Manager, SSA, Ostmarks-gatan 43, S-123 42 Farsta, Sweden. Please include an SASE or SAE plus IRCs.

Any questions about the locator system, including a request for finding out your own locator (do not forget to include your longitude and latitude) can be sent to Folke Rosvall SM5AGM, Vasterskarsringen 50, S-184 00 Akersberga, Sweden. Please include an SASE or SAE plus an appropriate number of IRCs to cover his expenses. Folke compiles a "Worked Locator Field List" on a quarterly basis. Why don't you send your score per band to Folke to be included in the list!

Whenever working a station on any band, always exchange Maidenhead locators or at least the two letters for the field.

SATELLITES

USING THE AO-10 APOGEE PREDICTIONS

Apogee predictions for the month of January are provided for three sections of the United States: Washington DC at 39N 77W, Kansas at 39N 95W, and California at 38N 122W. Times are in UTC and apogee in this case is mean anomaly 128 rounded to the nearest whole hour. Use the chart as a guide in aiming your antenna, then fine-tune the azimuth and elevation values to peak the satellite's beacon signal. If you require more accurate orbital predictions, contact AMSAT at PO Box 27, Washington DC 20044.

AMSAT-OSCAR 10 APOGEE PREDICTIONS January 1986

ORBIT	DAY	TIME	WASH		KANSAS		CALIF	
			AZ	EL	AZ	EL	AZ	EL
2249	1	0000	206	12	189	17	162	16
2251	1	2300	196	16	178	18	152	13
2253	2	2300	189	16	172	16	147	9
2255	3	2200	179	17	161	15	138	4
2257	5	2100	168	17	151	11	130	0
2259	6	2000	157	14	142	7		
2261	7	2000	152	11	137	3		
2263	8	1900	143	7				
2265	9	1800	134	2				
2267	10	1800	130	0				
2272	13	0400					227	1
2274	14	0300					219	7
2276	15	0300					214	9
2278	16	0200					204	14
2280	17	0100			218	6	194	17
2282	18	0100	226	0	213	9	188	17
2284	19	0000	219	6	203	13	177	18
2286	20	0000	213	8	197	14	171	17
2288	20	2300	204	12	187	16	160	15
2290	21	2200	194	15	176	17	151	11
2292	22	2100	183	17	166	16	142	7
2294	23	2000	173	17	155	13	133	1
2296	24	2000	166	15	150	10		
2298	25	1900	156	13	141	5		
2300	26	1800	147	9	133	-0		
2302	27	1800	142	5				
2304	28	1700	134	0				
2309	31	0300					230	0

TNT

RADIO SALES INC.

CALL TOLL FREE FOR QUOTES

1-800-328-0250

1-612-535-5050

(IN MINNESOTA—COLLECT)

EXPLOSION OF VALUES!

ICOM **KENWOOD**

KANTRONICS **TELEX HY-GAIN**

MIRAGE **HUSTLER**

AEA **KLM**

SANTEC **ROHN**

KDK **MFJ**

NYE VIKING **AMERITRON**

WELZ **BENCHER**

LARSEN **BUTTERNUT**

CALL NOW!
1-800-328-0250
 FOR ABSOLUTE
LOWEST PRICE BUSTERS!

INVENTORY REDUCTION PRICED TO GO!

We must make room for your trade-ins. Check now for lowest prices on previously owned bench-tested equipment!

NEW! ICOM R7000 RCVR

Covers continuous 25 mhz to 2 ghz!
99 memories—scans—etc., etc.
Loaded with features. Available November, 1985.

VISA/MASTER CARD
FREE SHIPPING
ON MOST RIGS FOR CASH!



S.A.S.E. FOR OUR
"BENCH-TESTED"
USED EQUIPMENT LISTING

MON-FRI 9 AM - 6 PM CENTRAL TIME
SATURDAY 9 AM - 5 PM

4124 West Broadway, Robbinsdale, MN 55422 (Mpls./St. Paul)

MOVING?

Let us know 8 weeks in advance so that you won't miss a single issue of **73**.

Attach old label where indicated and print new address in space provided. Also include your mailing label whenever you write concerning your subscription. It helps us serve you promptly. Write to:

73 for Radio Amateurs

Subscription Department
P.O. Box 931
Farmingdale NY 11737

- Extend my subscription one additional year for only \$19.97
 Payment enclosed Bill me

Canada and Mexico \$22.97/1 yr. only US funds drawn on US bank. Foreign Surface \$39.97/1 yr. only US funds drawn on US bank. Foreign Airmail, please inquire.

If you have no label handy, print OLD address here:

Name _____

Address _____

City _____ State _____ Zip _____

print NEW address here:

Name _____

Address _____

City _____ State _____ Zip _____

AFFIX LABEL

ATTENTION SUBSCRIBERS

We occasionally make our mailing list available to other companies or organizations with products or services which we feel might be of interest to you. If you prefer that your name be deleted from such a list, please fill out the coupon below or affix a copy of your mailing label and mail it to:

C.W. Communications/Peterborough
73 for Radio Amateurs
P.O. Box 931
Farmingdale, NY 11737

Please delete my name from mailing lists sent to other companies or organizations.

Name _____

Address _____

City _____ State _____ Zip _____

73 for Radio Amateurs

BEST OF MFJ

MFJ 24 HOUR LCD CLOCKS

These MFJ 24 hour clocks make your DXing, contesting, logging and SKEDing easier, more precise.

Read both UTC and local time at a glance with the MFJ-108, \$19.95, dual clock that displays 24 and 12 hour time simultaneously. Or choose the MFJ-107, \$9.95 single clock for 24 hour UTC time.

Both are mounted in a brushed aluminum frame, feature huge easy-to-see 5/8 inch LCD numerals and a sloped face that makes reading across-the-shack easy and pleasant.



MFJ-108
\$19.95

MFJ-107
\$9.95



You can read hour, minute, second, month and day and operate them in an alternating time-date display mode. You can also synchronize them to WWV for split-second timing. Both are quartz controlled for excellent accuracy.

They are battery operated so you don't have to reset them after a power failure, and battery operation makes them suitable for mobile and portable use. Long life battery included. MFJ-108 is 4 1/2 x 1 x 2 in. MFJ-107 is 2 1/4 x 1 x 2 in.

RTTY/ASCII/AMTOR/CW MFJ-1229 COMPUTER INTERFACE \$179.95



Everything you need is included for sending and receiving RTTY/ASCII/CW on a Commodore 64 or VIC-20 and your ham rig. You get MFJ's most advanced computer interface, software on tape and all cables. Just plug in and operate.

The MFJ-1229 is a general purpose computer interface that will never be obsolete. An internal DIP switch, TTL and RS-232 ports lets you adapt the MFJ-1229 to nearly any home computer and even operate AMTOR with appropriate software.

A crosshair "scope" LED tuning array makes accurate tuning fast, easy and precise.

You can transmit both narrow (170 Hz) and wide (850 Hz) shift while the variable shift tuning lets you copy any shift (100-1000 Hz) and any speed (5-100 wpm, 0-300 baud ASCII).

Automatic threshold correction and sharp multipole active filters give good copy under severe QRM, weak signal and selective fading.

There's an FM (limiting) mode for easy trouble-free tuning that's best for general use and an AM (non-limiting) mode that gives superior performance under weak signals and heavy QRM.

A handy Normal/Reverse switch eliminates re-tuning while checking for inverted RTTY.

An extra sharp 800 Hz CW filter really separates the signals for excellent copy.

12 1/2 x 12 1/2 x 6 inches. Uses floating 18 VDC or 110 VAC with MFJ-1312, \$9.95.

MFJ PORTABLE ANTENNA

MFJ's Portable Antenna lets you operate 40, 30, 20, 18, 15, 12, 10 meters from apartments, motels, camp sites, vacation spots, any electrically clear location where space for full size antenna is a problem.

A telescoping whip (extends 54 in.) is mounted on self-standing 5 1/2 x 6 3/4 x 2 1/4 inch Phenolic case. Built-in antenna tuner, field strength meter, 50 feet coax. Complete multi-band portable antenna system that you can use nearly anywhere. 300 watts PEP.

MFJ-1621
\$79.95



MFJ ANTENNA BRIDGE MFJ-204B \$79.95

Now you can quickly optimize your antenna for peak performance with this portable, totally self-contained antenna bridge that you can take to your antenna site—no other equipment is needed.

You can determine if your antenna is too long or too short, measure its resonant frequency and antenna resistance to 500 ohms. It's the easiest and most convenient way to determine antenna performance available today to anyone. There's nothing else like it and only MFJ has it. Built-in resistance bridge, null meter and tunable oscillator-driver (1.8-30 MHz). Uses 9 V battery. 4 x 2 x 2 inches.

REMOTE ACTIVE ANTENNA

The authoritative "World Radio TV Handbook" rates the MFJ-1024 as "a first-rate easy-to-operate active antenna ... Quiet, with excellent dynamic range and good gain ... Very low noise factor ... Broad frequency coverage ... the MFJ-1024 is an excellent choice in an active antenna".

54 inch remote active antenna mounts outdoor away from electrical noise for maximum signal and minimum noise pickup. Often outperforms long-wire hundreds of feet long. Mount anywhere—atop houses, buildings, balconies, apartments, ships.

Use with any radio to receive strong clear signals from all over the world. 50 KHz to 30 MHz. High dynamic range eliminates intermodulation. Inside control unit has 20 dB attenuator, gain control.

Switch 2 receivers and auxiliary or active antenna. "On" LED. 6 x 2 x 5 in. 50 ft. coax. 12 VDC or 110 VAC with MFJ-1312, \$9.95.

MFJ-1024
\$129.95

200 WATT VERSA TUNER

MFJ's smallest 200 watt Versa Tuner matches coax, random wires and balanced lines from 1.8 thru 30 MHz. Works with all solid state and tube rigs. Very popular for use between transceiver and final amplifier. Efficient air-wound inductor gives more watts out. 4:1 balun, 5x2x6 in.

MFJ-901B \$59.95



ROLLER INDUCTOR TUNER



MFJ-989 \$329.95

Meet the "Versa-Tuner V", the compact roller inductor tuner that lets you run up to 3-KW PEP and match everything from 1.8 to 30 MHz.

Designed to match the new smaller rigs, the MFJ-989 is the best roller inductor tuner produced by MFJ. Our roller inductor tuner features a 3-digit turn counter plus a spinner knob for precise inductance control for maximum SWR reduction. Just take a look at all these other great features! Built-in 300 watt, 50 ohm dummy load, built-in 4:1 balun and a built-in lighted meter that reads SWR and forward and reflected power in 2 ranges (200 and 2000 watts). Accuracy ±10% full scale. Meter light requires 12 VDC. 6 position antenna switch. 10 3/4 x 4 1/2 x 15 inches.

MFJ "DRY" DUMMY LOADS

MFJ-262
\$64.95



MFJ-260
\$26.95

MFJ's "Dry" dummy loads are air cooled—no messy oil. Just right for tests and fast tune up. Non-inductive 50 ohm resistor in aluminum housing with SO-239. Full load to 30 seconds, de-rating curve to 5 minutes. MFJ-260 (300 watt), SWR 1.1:1 to 30 MHz, 1.5:1, 30-160 MHz, 2 1/2 x 2 1/2 x 7 in. MFJ-262 (1 KW), SWR 1.5:1 to 30 MHz, 3x3x13 inches.

MFJ ELECTRONIC KEYS

MFJ-407
\$69.95



MFJ-407 Deluxe Electronic Keyer sends iambic, automatic, semi-auto or manual. Use squeeze, single lever or straight key. Plus/minus keying. 8 to 50 WPM. Speed, weight, tone, volume controls. On/Off, Tune, Semi-auto switches. Speaker. RF proof. 7 x 2 x 6 inches. Uses 9 V battery, 6-9 VDC or 110 VAC with AC adapter, MFJ-1305, \$9.95.

ORDER ANY PRODUCT FROM MFJ AND TRY IT-NO OBLIGATION. IF NOT SATISFIED, RETURN WITHIN 30 DAYS FOR PROMPT REFUND (less shipping).

• One year unconditional guarantee • Made in USA
• Add \$5.00 each shipping/handling • Call or write for free catalog, over 100 products.

MFJ

MFJ ENTERPRISES, INC.
Box 494, Mississippi State, MS 39762

TO ORDER OR FOR YOUR NEAREST DEALER, CALL TOLL-FREE

800-647-1800

Call 601-323-5869 in Miss. and outside continental USA Telex 53-4590 MFJ STKV



AFFORDABLE PACKET RADIO FROM MFJ

An identical TAPR TNC 2 clone with a new cabinet and added features ... for an incredible \$129.95.

MFJ-1270 **\$129.95**



Join the exciting packet radio revolution and enjoy error-free communications ... for an incredible \$129.95.

MFJ brings together efficient manufacturing and TAPR's (Tucson Amateur Packet Radio) leading edge technology to bring you affordable packet radio. You get a nearly identical clone of the widely acclaimed TAPR TNC 2 with identical software and hardware. It's in a new cabinet and includes a TTL serial port for extra versatility.

All you need is your rig, home computer with a RS-232 serial port and a terminal program. If you have a Commodore 64, 128 or VIC-20 you can use MFJ's optional Starter Pack to get on the air immediately. You get interfacing cable, terminal software on tape or disk and complete instructions ... everything you need to get on packet radio. Order MFJ-1282 (disk) or MFJ-1283 (tape), \$19.95 each.

Unlike machine specific TNCs, you never have to worry about your MFJ-1270 being obsolete because you change computers or because packet radio standards change. You can use any computer with an RS-232 serial port and an appropriate terminal program. If packet radio standards change, software updates will be made available as TAPR releases them. Also speeds in excess of 56K bauds are possible with a suitable external modem! Try that with a machine specific TNC or one without hardware HDLC as higher speeds come into widespread use. You can also use the MFJ-1270 as an inexpensive digipeater.

It features the latest AX.25 Version 2.0 software, hardware HDLC for full duplex, true Data Carrier Detect for HF, 16K RAM, simple operation plus more.

Join the packet radio revolution now and help make history. Order the MFJ-1270 today.

Here are MFJ's latest and hottest products for improving your station's performance.

SUPER KEYBOARD

MFJ-496
\$169.95



Price slashed 50% to \$169.95! Get a full feature Super Keyboard that sends CW/RTTY/ASCII for the price of a good memory keyer.

You get the convenience of a dedicated keyboard—no program to load—no interface to connect—just turn it on and it's ready to use.

This 5 mode Super Keyboard lets you send CW, Baudot, ASCII, use it as a memory keyer and for Morse Code practice. You get text buffer, programmable and automatic message memories, error deletion, buffer preload, buffer hold.

TRIPLE OUTPUT LAB POWER SUPPLY

MFJ-4002 \$149.95



Lab quality power supply gives you plenty of voltage and current for all your analog and digital circuits. 3 completely isolated outputs: 2 variable 1.5-20 VDC at 0.5 amp and a fixed 5 VDC at 1 amp. Connect in series or parallel for higher voltage and current. It's short circuit protected, has excellent line (typ. 0.01%/V) and load regulation (typ. 0.1%). Lighted meters monitor volt./cur. 12x3x6 in. 110 VAC.

CROSS-NEEDLE SWR/WATT METER

MFJ-815 \$59.95

MFJ's cross-needle SWR/Wattmeter gives you SWR, forward and reflected power—all at a single glance! SWR is automatically computed

—no controls to adjust. Easy-to-use push buttons select three power ranges that give you QRP to full legal limit power readings. Reads 20/200/2000 W forward, 5/50/500 W reflected and 1:1 to 1:5 SWR on easy-to-read two color scale. Lighted meter. Needs 12 V. ±10% full scale accuracy. 6½ x 3¼ x 4½ inches.



2 KW COAX SWITCHES

Instantly select any antenna or rig by turning a knob. Organizes coax cables and eliminates plugging and unplugging. Unused terminals are grounded to protect your equipment for stray RF, static and lightning. 2 KW PEP, 1 KW CW. For 50 to 75 ohm. Negligible loss, SWR, and crosstalk gives high performance. SO-239s. Convenient desk or wall mounting.

MFJ-1702, \$19.95. 2 positions. Cast aluminum cavity construction gives excellent performance up to 500 MHz with better than 60 dB isolation at 450 MHz. Heavy duty, low loss switch has less than 20 milliohm contact resistance, less than 0.2 dB loss and SWR below 1:1.2. 2 x 2½ x 1 inches.

MFJ-1701, \$29.95. 6 positions. White markable surface for recording ant. positions. 8½ x 1½ x 3 in.

MFJ-1702
\$19.95



\$29.95 MFJ-1701



ANTENNA CURRENT PROBE

MFJ-206 \$79.95

This new breakthrough MFJ Antenna Current Probe lets you monitor RF antenna currents—no connections needed! Determine current distribution, RF radiation pattern and polarization of antennas, transmission lines, ground leads, building wiring, guy wires and enclosures.

- Indicate transmission line radiation due to high SWR, poor shielding or antenna unbalance.
- Detect re-radiation from rain gutters and guy wires that can distort antenna field patterns.
- Detect RF radiation from ground leads, power cords or building wiring that can cause RFI.
- Determine if ground system is effective.
- Pinpoint RF leakage in shielded enclosures.
- Locate the best place for your mobile antenna.
- Use as tuned field strength meter.

Monitors RF current by sensing magnetic field. Uses an electrostatically shielded ferrite core, FET RF amplifier, op-amp meter circuit for excellent sensitivity, selectivity. 1.8-30 MHz. Has sensitivity, bandswitch, tune controls, telescoping antenna for field strength meter. 4 x 2 x 2 inches.

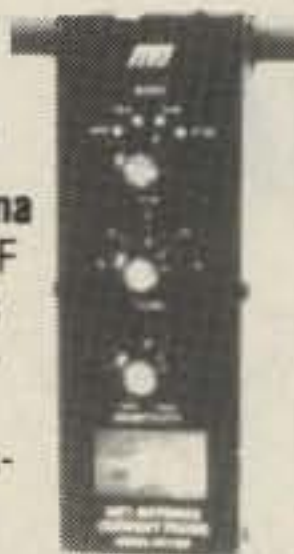

MFJ's Best VERSA TUNER

MFJ-949C \$149.95



MFJ's best 300 watt tuner is now even better! The MFJ-949C all-in-one Deluxe Versa Tuner II gives you a tuner, cross-needle SWR/Wattmeter, dummy load, antenna switch and balun in a new compact cabinet. You get quality conveniences and a clutter-free shack at a super price.

A new cross-needle SWR/Wattmeter gives you SWR, forward and reflected power—all at a single glance. SWR is automatically computed with no controls to set. Has 30 and 300 watt scale.

Run up to 300 watts RF output—and match coax, balanced lines or random wires from 1.8 thru 30 MHz. Tune out SWR on dipoles, vees, long wires, verticals, whips, beams/quads. 10x3x7 in.

DIGITAL SWR/WATTMETER

MFJ-818
\$89.95



Fully automatic Digital SWR/Wattmeter reads SWR 1:1 to 1:9.9 directly and instantaneously—no SWR knob to set. Huge 0.6 inch bright orange digits make across-the-room reading easy. 12 segment LED bar graph wattmeter gives instantaneous PEP readings up to 200 watt RF output.

Good, bad, mismatch tri-color LEDs indicate SWR conditions. Small size (5½ x 4¼ x 1 in.) and easy-to-read digital display makes it ideal for mobile use. For 50 ohm systems. 1.8-30 MHz. 12 VDC or 110 VAC with MFJ-1312. \$9.95.

MOBILE ANTENNA MATCHER

MFJ-910 \$19.95

Lower your SWR and Get more power into your mobile whip for solid signals and more QSOs. Your solid state rig puts out more power and generates less heat. For 10-80 meter whips. Easy plug-in installation. Complete instructions. Fits anywhere. 2½x2½ in.



ORDER ANY PRODUCT FROM MFJ AND TRY IT-NO OBLIGATION. IF NOT SATISFIED RETURN WITHIN 30 DAYS FOR PROMPT REFUND (less shipping).

• One year unconditional guarantee • Add \$5.00 each shipping/handling • Call or write for free catalog, over 100 products.

MFJ

MFJ ENTERPRISES, INC.
Box 494, Mississippi State, MS 39762

TO ORDER OR FOR YOUR NEAREST DEALER, CALL TOLL-FREE

800-647-1800

Call 601-323-5869 in Miss. and outside continental USA Telex 53-4590 MFJ STKV



CONTESTS

Robert Baker WB2GFE
15 Windsor Dr.
Atco NJ 08004

WORLD SSB CHAMPIONSHIPS

Announcing the January Classics—the 1986 running of the World SSB Championships! The first and only contests of their kind, these five (5) individual single-band events are world-renowned and amongst the most challenging events on the bands today. Winners of each contest determine the World Champion for 15-, 20-, 40-, 75-, and 160-meter single sideband:

January 11, 1986
0000-2400 UTC

5th 40-Meter World SSB Championship

January 12, 1986
0000-2400 UTC

5th 75-Meter World SSB Championship

0000 UTC January 18, 1986,
through 2400 UTC January 19, 1986

7th 160-Meter World SSB Championship

January 25, 1986
0000-2400 UTC

2nd 15-Meter World SSB Championship

January 26, 1986
0000-2400 UTC

2nd 20-Meter World SSB Championship

Stations may be worked only *once per event*. All contacts must be two-way SSB. All stations, regardless of operating class, may operate the entire contest period.

OPERATOR CLASS:

(a) single operator, single transmitter, SSB only; (b) multi-operator, single transmitter, SSB only.

EXCHANGE:

Stations within the 48 continental US

states and 13 Canadian provinces or territories transmit RS report and state, province, or territory. All others, including Alaska and Hawaii, transmit RS report and ARRL DXCC country.

QSO POINTS:

5 QSO points for contacts *within* your own continent.

10 QSO points for contacts *outside* your own continent.

MULTIPLIERS:

1 multiplier point is earned for each continental US state (48 max.), Canadian province or territory (13 max.), or ARRL DXCC country (excluding the United States and Canada).

SUGGESTED FREQUENCIES:

21.250-21.350; 14.175-14.250; 7.050-7.080 (DX); 7.175-7.250 (W/VE); 3.760-3.790; 3.805-3.875; 1.830-1.850; 1.855-1.900 MHz.

DX WINDOW:

For the purpose of this event, DX window frequencies are reserved for *split-band operation only*. W/VE stations are *not* to transmit in the window at all. DX stations *may* transmit but *must* receive outside the window frequencies. DX windows include 7.080-7.090, 3.790-3.805, 1.825-1.830, 1.850-1.855, and 1.907-1.913 MHz.

FINAL SCORE:

Total QSO points × multiplier points = claimed score.

ENTRIES:

Entries *must* include (1) a contest log, (2) a dupe sheet for 100 or more contacts, (3) a list of multipliers, and (4) a summary

RESULTS

1985 New Jersey QSO Party Top-Scoring Stations

New Jersey	Out-Of-State
WA2WJY 27,450	W5PWG 1,152
NC2V 25,920	K4FHQ 629
W2MYA 18,792	KY7M 592
K2AA 11,858	K4BAI 576
KA2VAZ 10,948	W0GAX 576
	N1PL 544

sheet as outlined below. Be sure to *include* your soapbox comments and a black and white photo for possible publication.

SUMMARY SHEET:

Summary sheets must contain (1) contest callsign, (2) your state, province, territory, or ARRL DXCC country, (3) station owner's name and mailing address, (4) a list of station equipment and antenna(s), (5) the operator class, (6) total QSOs, (7) total QSO points earned, (8) total US states worked, (9) Canadian provinces and territories worked, (10) the total of ARRL DXCC countries worked, (11) total multiplier points, and (12) your claimed contest score.

ENTRY DEADLINE:

Entries should be mailed to the appropriate contest chairman listed below. Entries must be **POSTMARKED NO LATER THAN FEBRUARY 20, 1986**. Late entries will be registered as check logs.

DISQUALIFICATION:

Contestants may be disqualified if they run illegal power, cause deliberate interference, fail to comply with the rules for the DX window, attempt to achieve a scoring advantage, or if duplicate contacts not cancelled exceed more than 3% of the total contacts made. Decisions of the contest committee are final. Disqualified stations will be barred from these events for one year thereafter.

PENALTIES:

A penalty of 100 QSO points will be assessed for each duplicate contact counted in a contestant's claimed score.

AWARDS:

A minimum of 100 QSOs must be worked in an event to be eligible for a con-

test award. Plaques will be issued to the World Championship Stations. Awards will be issued in each operator class, in each continental US state, Canadian province and territory, and ARRL DXCC country represented.

RULES AND FORMS:

Contestants are encouraged to use official contest forms. To obtain your own copy of the rules and each contest form, send an SASE to: *Contest Rules and Forms*, Billy Maddox KA6JJK/3, 1162 Bayview Vista Drive, Annapolis MD 21401.

Mail Your Entry To:
15-Meter Contest Chairman
Gary Vest WA3KCY
Star Route, Box 34
Holliday TX 76366

40-Meter Contest Chairman
Dennis Younker NE6I
43261 6th Street East
Lancaster CA 93535

160-Meter Contest Chairman
Harry Arsenault K1PLR/4
704 Curtiss Drive
Garner NC 27529

20-Meter Contest Chairman
Chuck Ingram WA6R
44720 N. 11th Street East
Lancaster CA 93535

75-Meter Contest Chairman
Ron Johnson KC7PA
68 South 300 West
Brigham City UT 84302

ARRL STRAIGHT KEY NIGHT Starts: 0000 UTC January 1 Ends: 2400 UTC January 1

Sponsored by the ARRL, this is a friendly meeting on the air using straight keys. Suggested areas of operation on 80, 40, and 20 meters are 60 to 80 kHz from the lower band edges and 10 kHz from the lower Novice band edges. When participating, use "SKN" instead of RST preceding the three-digit report to clue in passersby. Following SKN, send a list of stations worked plus your vote for best fist heard during the period. Note, your vote does not have to be from the stations worked; it can be another station you've heard working SKN. This is not a contest, so quick contest-like exchanges are discouraged. Include a vote for the most interesting QSO besides your best-fist vote

CALENDAR

Jan 1	ARRL Straight Key Night
Jan 5	ARRL Midnight Special
Jan 11	5th Annual 73 40-Meter World SSB Championship
Jan 11-12	Hunting Lions In The Air Contest
Jan 11-12	QRP CW Contest
Jan 11-12	ARRL VHF Sweepstakes
Jan 12	5th Annual 73 75-Meter World SSB Championship
Jan 18-19	7th Annual 73 160-Meter World SSB Championship
Jan 18-19	Antenna Experimenter's Contest Sprint
Jan 18-19	North Dakota QSO Party
Jan 25-Feb 2	ARRL Novice Roundup
Jan 25	2nd Annual 73 15-Meter World SSB Championship
Jan 25-26	Michigan YL QSO Party
Jan 26	2nd Annual 73 20-Meter World SSB Championship
Jan 26-27	Classic Radio Exchange
Feb 1-3	New Hampshire QSO Party
Feb 8-9	Dutch PACC Contest
Feb 8-9	YL-ISSB QSO Party—Phone
Feb 15-16	ARRL International DX Contest—CW
Feb 22	RTTY World Championship
Mar 1-2	ARRL International DX Contest—Phone
Mar 15-16	YL-ISSB QSO Party—CW
Apr 12-13	CARF Commonwealth Phone Contest
Apr 14	ARRL 144-MHz Sprint
Apr 22	ARRL 220-MHz Sprint
Apr 30	ARRL 432-MHz Sprint
May 8	ARRL 1296-MHz Sprint
May 17	ARRL 50-MHz Sprint
Jun 7-8	ARRL VHF QSO Party
Jun 28-29	ARRL Field Day
Jul 1	CARF Canada Day Contest
Jul 12-13	IARU Radiosport Championship



BADGER STATE
Smoke Signals
Serving Amateur Radio in Wisconsin

NEWSLETTER OF THE MONTH

Imagine our surprise when we opened the latest *Badger State Smoke Signals*—and a pair of 3-D glasses fell out! The glasses, donated by a local television station, allowed us to see the Yellow Thunder (Wisconsin) ARC's Field Day operation as if we were actually there! To our knowledge this is the first time that 3-D pictures have appeared in a radio club newsletter.

But the flashy pictures are not the only reason that *Smoke Signals* is this month's winner. We've been consistently impressed by the quality and breadth of the coverage given amateur radio by Editor Ken Ebnetter K9ZZ. *Smoke Signals* is a publication that serves all of the radio clubs in Wisconsin, so Ken obviously has a great deal of information to draw from. Each issue we've seen has been lively reading, and we'd like to congratulate Ken and his crew for putting out such a great publication.

To enter your club's newsletter in 73's Newsletter of the Month Contest, send it to 73 Magazine, Editorial Offices, 80 Pine Street, Peterborough NH 03458, Attn: Newsletter of the Month.

Kantronics UTU-XT

**NOW — for ANY computer,
the intelligent terminal unit
that can change its spots.**

Can you imagine a terminal unit (TU) that has user programmable parameters? Would you like to be able to vary the MARK and SPACE tones you use by computer control, save these parameters for next time, and be able to change the center frequency and bandwidth of the CW detector? All this can be done with the **Universal Terminal Unit-XT by Kantronics.**

Imagine a **CW/RTTY/ASCII/AMTOR** machine that operates with a TNC-like command structure, including **54 commands.** The UTU-XT does just that with a 6303 microcomputer, 2K of RAM, NOVRAM, and 128K of EPROM embedded inside.



UTU-XT is also compatible to any computer with an RS232 or TTL (C-64) serial port — the circuit is built in. This allows you the flexibility to change computers at any time.

UTU-XT operates CW from 6-99 WPM, RTTY from 45 to 300 baud. ASCII from 110 to 300 baud, and AMTOR modes A, B, and L. Selective RTTY and SELFEC are included.

Suggested retail \$359.95

Kantronics

1202 E. 23rd Street (913) 842-7745
Lawrence, Kansas 66046

here is the next generation Repeater

MARK 4CR

The **only** repeaters and controllers
with REAL SPEECH!

No other repeaters or controllers match Mark 4 in capability and features. That's why Mark 4 is the performance leader at amateur and commercial repeater sites around the world. Only Mark 4 gives you Message Master™ real speech • voice readout of received signal strength, deviation, and frequency error • 4-channel receiver voting • clock time announcements and function control • 7-helical filter receiver • extensive phone patch functions. Unlike others, Mark 4 even includes power supply and a handsome cabinet.

Call or write for specifications on the repeater, controller, and receiver winners.

Create messages just by talking. Speak any phrases or words in any languages or dialect and *your own voice* is stored instantly in solid-state memory. Perfect for emergency warnings, club news bulletins, and DX alerts. Create unique ID and tail messages, and the ultimate in a real speech user mailbox — only with a Mark 4.



MICRO CONTROL SPECIALTIES

Division of Kendecom Inc.
23 Elm Park, Groveland, MA 01834 (617) 372-3442

and mail a report to ARRL Headquarters, Newington CT 06111 by January 10, 1986.

ARRL MIDNIGHT SPECIAL Starts: 0400 UTC January 5 Ends: 0600 UTC January 5

During the first hour use 80 CW; during the second hour use 75 phone. Work stations once on each mode. Suggested frequencies are 3540-3570 and 3855-3895. Exchange 3-digit consecutive serial number beginning with 001 plus name. Final score equals total number of QSOs worked with no multiplier. Mail entries by February 3, 1986, to ARRL Headquarters, Newington CT 06111. Top scores will be listed in QST.

HUNTING LIONS IN THE AIR CONTEST Starts: 0000 UTC January 11 Ends: 1200 UTC January 12

The contest is sponsored by Lions Clubs International and coordinated by Lions Club Rio de Janeiro Arpoador—Brazil. Participation in the contest is open to all duly-licensed radio operators, Lion and non-Lion. There are two modes: phone and CW. Participation in both modes is allowed but points are counted separately. All amateur stations participating must operate within their licensing regulation. Separate categories will exist for single-operator and radio clubs/societies. Multi-operators may participate as long as they do not operate simultaneously with the same prefix. However, each callsign used must be listed on the log.

Use 80, 40, 20, 15, and 10 meters. Associates of the Lions Club of Rio de Janeiro Arpoador will operate mainly within the first 50 kHz of each band and around 14.270, 21.270, and 28.550. Only one QSO with the same station on each band and each mode may be counted. Remember that phone and CW are counted separately!

EXCHANGE:

RS(T) and sequential QSO number. When contacts are made with Lions, Leos, or Lionesses, the name of the club contacted should be clearly identified.

SCORING:

QSOs within the same continent count 1 point, while those between different continents count 3 points. Score 10 extra bonus points for each QSO with a member of a Lion, Lioness, or Leo Club from a different country or 5 points within the same country. Score 20 bonus points for a QSO with a member of the Lions Club Rio de Janeiro Arpoador or for each QSO with a member of the Melvin Jones Memorial Radio Club of the United States. Score 25 extra points if contact is made with the Arpoador official station with callsign PY1LCA.

Contacts between Brazilian stations and members of the Arpoador club, as well as North American stations and Melvin Jones Memorial Radio Club, will count only 5 extra points. Contacts between Brazilian stations and the Arpoador official station (PY1LCA) will count only 10 extra points. Contacts between members of the Arpoador club, as well as contacts between members of the Melvin Jones Memorial Radio Club, will not count any bonus points.

AWARDS:

For both categories, the Lions Club International will present trophies for first, second, and third place on both modes. For single operators, fourth through tenth places will receive plaques. In addition, each log sent by participants with a mini-

mum of 15 contacts will receive a special certificate.

ENTRIES:

Keep a separate log for each mode and clearly indicate the operating category. Each participant will note in the logs the callsign and information exchanged. Confirmation of contacts will be made by comparing the logs of participants. Participants should send their logs by air mail not later than February 15, 1986, to: Contest Committee, Rio de Janeiro Arpoador Lions Club, Rua Sao Francisco Xavier No. 246, Apt. 407, 20551, Rio de Janeiro, RJ, Brazil.

MICHIGAN QRP CLUB CW CONTEST

Starts: 1500 UTC January 11
Ends: 1500 UTC January 12

The contest is open to all amateurs and all are eligible for the awards. This is a CW-only, allband QRP contest. Use all bands from 160 to 10 meters, excluding WARC bands. Each station will be competing within his own state, province, or country in one of the following categories: (1) one Watt or less output power; (2) five Watts or less output power; (3) over five Watts output power.

EXCHANGE:

RST, state, province, or country, plus power output.

SCORING:

Each contest is worth one QSO point. Multiply by the number of states, provinces, and countries worked per band for total points. If operating 100%-natural or battery emergency power, use a bonus multiplier of 1.5 times total points.

AWARDS:

Certificates will be awarded to the highest-scoring station in each state, province, and country.

ENTRIES:

Log information must include: full log data with a separate log for each band, name and address, equipment used, and power output. Logs must be received no later than six weeks after the end of the contest. Please include an SASE or two IRCs for contest results if desired. Send all logs to: Chris Hethorn KM8X, 6818 Meese Dr., Lansing MI 48910.

ARRL VHF SWEEPSTAKES Starts: 1900 UTC January 11 Ends: 0400 UTC January 13

Sponsored by the ARRL, this is the 39th annual running of this event. As usual, check QST for any last-minute rule changes. The object of this contest is to work as many amateurs in as many 2-by-1-degree grid squares as possible, using authorized amateur frequencies above 50 MHz. Foreign stations may only work W/VE amateurs.

Operating categories include: (A) single operator, single band; (B) single operator, allband; (C) multi-operator. Single-band entries may submit QSOs made on other bands for ARRL-affiliated club competition credit. Multi-operator stations must have all equipment and antennas located within a 300-meter-diameter circle.

Use of repeater frequencies or retransmission of either signal is not permitted. This also includes soliciting contacts via 2-meter repeaters or on repeater frequencies. Use of national simplex frequency, 146.52 MHz, or immediate adjacent guard frequencies is likewise prohibited. How-

ever, there are no restrictions on the use of 223.50 MHz.

Only recognized simplex frequencies may be used, such as 144.90 to 145.10; 146.49/.55/.58; 147.42/.45/.48/.51/.54/.57 MHz on 2-meters. Local-option simplex channels and frequencies adjacent to these frequencies that do not violate the intent of the above rules or the spirit and intent of the band plans may be used for contest purposes.

Stations may be worked only once per band from any given grid square for credit, regardless of mode. Stations changing grid squares must submit a separate entry for each grid square from which they operate. Crossband QSOs do not count.

Any transmitter used to contact one or more stations may not be used under any other call during the contest period, with the exception of family stations where more than one call is assigned to one location by FCC/DOC. Only one signal per band is permitted at any given time, regardless of mode. While no minimum distance is specified for contacts, equipment should be capable of real communications over at least 1 km. Above 300 GHz, contacts are permitted for contest credit only between licensed amateurs of Technician class or higher using coherent radiation (laser) and employing at least one stage of electronic detection on receive.

Multi-operator stations may not include QSOs with their own operators except on frequencies higher than 2.3 GHz. Even then, a completely different station must exist for each QSO made under these conditions.

EXCHANGE:

Grid-square locator (see the January, 1983, QST, page 49); signal reports are optional. Partial QSOs do not count. Both callsigns, the full exchange, and acknowledgement must be sent and received for credit. Any station located precisely on a dividing line between grid squares must select only one as the location for exchange purposes. A different grid square multiplier cannot be given out without moving the complete station at least 100 meters.

SCORING:

Count one point for complete two-way QSOs on 50 and 144 MHz, two points on 220 or 432 MHz, four points on 902 and 1296 MHz, and eight points on 2.3 GHz or higher. The multiplier is the total number of different grid squares worked per band. Final score is total QSO points times total number of multipliers.

AWARDS:

Suitable awards will be presented to the top-scoring single operator in each ARRL section and on each band in each section for single-band entries. The top multi-operator awards will be made for top scores in each ARRL section where significant effort or competition is evidenced. Multi-operator entries are not eligible for single-band awards.

ARRL-affiliated clubs can compete for gavels on three levels: unlimited, medium, and local. Details are listed in the January issue of QST.

ENTRIES:

Logs must indicate time in UTC, bands, calls, and complete exchanges. Multipliers should be numbered clearly the first time they are worked. Entries with more than 200 total QSOs must include cross-check sheets. All entries must be post-marked no later than 30 days after the contest and mailed to the ARRL, Newington CT 06111. Use ARRL VHF SS forms or a reasonable facsimile. Each entrant agrees to be bound by the provisions of the rules,

the regulations of his or her licensing authority, and the decisions of the ARRL Awards Committee. Disqualifications will be made for excess duplicates and call-sign or exchange errors.

NORTH DAKOTA QSO PARTY 0000-0800 UTC January 18 1600-2400 UTC January 18 0800-1600 UTC January 19

Sponsored by the Red River Radio Association, contestants may work stations once per band and mode.

EXCHANGE:

Signal report and QTH (county for ND stations; state, province, or country for others).

SCORING:

10 points per phone contact, 20 points per CW contact, and 50 points per RTTY contact. ND stations add 250 bonus points for working 5 Novices. Multiplier for ND stations is number of states/provinces/countries worked. Multiplier for non-ND stations is the number of ND counties worked (53 maximum).

FREQUENCIES:

Phone—1.810, 3.905, 7.280, 14.295, 21.380, and 28.500; CW—1.810, 3.540, and 35 kHz up from the band edges; Novice—25 kHz up from the band edges.

ENTRIES:

Mail logs by February 28, 1986, to Mike Beaton KD0A, 2267 Flickertail Drive, Fargo ND 58103. Include a large SASE for results.

RATS NEST AND CROOKED STICK VI ANTENNA EXPERI- MENTER'S CONTEST SPRINT Starts: 2300 UTC January 18 Ends: 0400 UTC January 19

Sponsored by the Issaquah Amateur Radio Club, the object of this contest is to accumulate QSO points by making contacts using a home-brew wire antenna. The antenna may be in any configuration, as long as it includes the use of a crooked-stick support. Maximum transmitting power is 250 Watts dc input.

EXCHANGE:

Name, QTH, type of antenna, and indicate if IARC member.

FREQUENCIES:

CW—7.050 to 7.150; SSB—7.225 to 7.300.

SCORING:

CW QSOs count 5 points, phone 2 points. Each new state, province, or country counts as a multiplier of two. To encourage "Elmering" and participation of everyone interested in amateur radio, new individuals and old-timers alike, the following bonus has been established: Contacts made with an apprentice's assistance, add 2 points. Contacts made by an apprentice (minor coaching allowed) add 5 points.

AWARDS:

Best CW, SSB, Novice/Tech; best with Rats Nest antenna; best Elmer. There is also a personalized Rat Catcher certificate for contacting three or more IARC members.

ENTRIES:

Submit entries by February 1, 1986. Include summary sheet with points per mode, bonus points earned, total points

PACKET EVOLUTION



ANOTHER BREAKTHROUGH FROM AEA

Packet + RTTY = Pakratt™ PK-64.

If you've read about packet, or are already into it, you know how exciting it is. With the hot new Pakratt PK-64 we've just brought a new dimension to packet. The Pakratt PK-64 is a complete, fully assembled and tested packet radio controller which, together with a Commodore 64 or 128 computer, can convert your shack into a packet operations center.

And we've included a new version of our advanced MBA-TOR™ software to make it the first packet controller with AMTOR, Baudot, ASCII and Morse. But an even more exciting part of the Pakratt controller is its great price.

Incredibly Simple To Set Up

Just plug the Pakratt controller into the C-64's game cartridge slot, add a mic connector for connecting to your particular

transceiver, and you're set.

If you're anxious to try it out, our new "quickstart" manual section can get you on the air in under ½ hour.

Simply Powerful

The versatile Pakratt controller shows messages and connect status simultaneously on your Commodore with a unique split-screen display. And it lets you

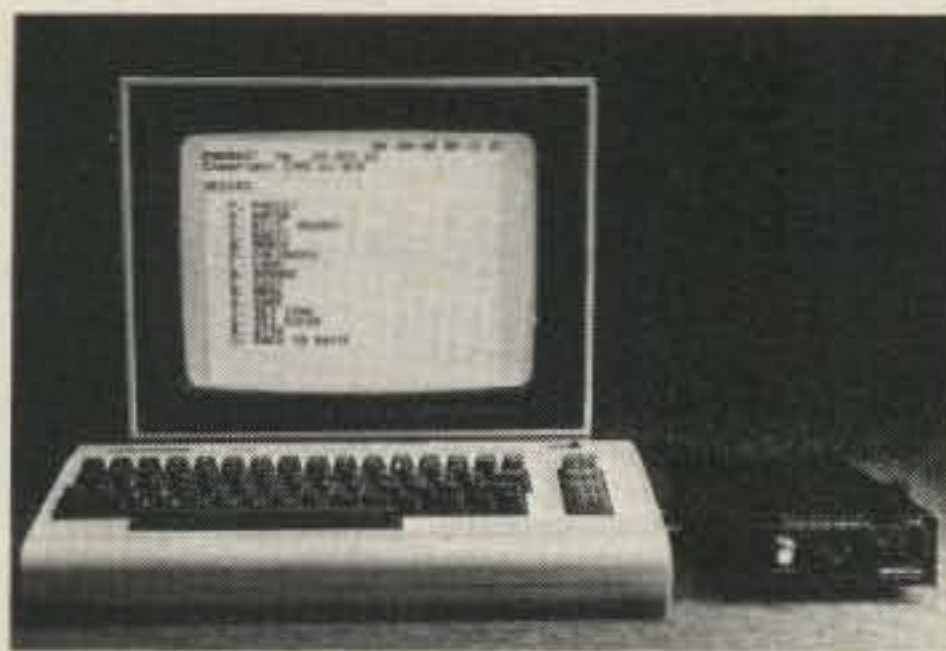

PK-64 shown with HF modem option.
Computer not included.

send letter-perfect text from the text editor software while monitoring incoming messages. The 20K byte QSO buffer stores more than 20 video screens of text!

Disk commands let you save

specific operating parameters for quick set-up for emergency services, clubs, and multiple frequency use. And the Pakratt controller's standard, TAPR style modem gives you 300 and 1200 baud operation with great HF/VHF performance.

We can't possibly list all of the important features of Pakratt here. But the absolutely best part of the Pakratt PK-64 is that it's at your dealer now. So stop reading, run down to your local dealer, and check Pakratt out. Because the real challenge will be to find one after the other hams see it.

Pakratt PK-64. Packet Power from AEA. At amateur radio dealers everywhere.



Advanced Electronic Applications, Inc.
P.O. Box C-2160
Lynnwood, WA 98036-0918
(206) 775-7373
Telex: 6972496 AEA INTL UW

KON #

SEOUL KOREA ZONE 25

HL1TR

JON. W. PARK
C. P. O BOX 8589
Seoul. 100. KOREA

QSL Manager: LASNM

GAMES OF THE XXIVTH OLYMPIAD SEOUL 1988



QSL OF THE MONTH

To enter your QSL, mail it in an envelope to 73, 80 Pine Street, Peterborough NH 03458. Attn: QSL of the Month. Winners receive a one-year subscription (or extension) to 73. Entries not in envelopes cannot be accepted.

earned, name, call, address, complete description of antenna and equipment used, license class, and copy of log sheet. Logs to include time, call, frequency, mode, and exchange. Clearly mark three IARC member contacts to qualify for Rat Catcher Award. Send all correspondence and entries to the Issaquah Amateur Radio Club, c/o Steve Pack WB7VAS, 4609 158th Ave. SE, Bellevue WA 98006.

ARRL NOVICE ROUNDUP
Starts: 0001 UTC January 25
Ends: 2359 UTC February 2

The object of this ARRL-sponsored contest is for Novice and Technician operators in the US to exchange QSO information with as many stations as possible on the 80-, 40-, 15-, and 10-meter Novice/Technician bands. Others work Novices and Technicians only. All stations must operate no more than 30 hours during the contest period. Off periods must be at least 15 minutes; listening time counts as operating time. Times on and off must be indicated in your log.

Operating categories include: (A) single operator—one person performs all trans-

mitting, receiving, and logging functions; (B) multi-operator, single transmitter only—those obtaining any form of assistance, such as relief operators or logging.

EXCHANGE:

Signal report and ARRL section or DX country. Novices should send /N and Technicians /T after their callsigns so others will know their license class.

SCORING:

Count one point for each complete two-way QSO. Work each station once, regardless of band. No crossband contacts are permitted. Multiplier is the number of ARRL sections plus VE8/VY1 and foreign countries. Additional points can be earned if you have qualified for an ARRL Code Proficiency certificate (not FCC). CP credit equals the speed in words per minute indicated on the latest certificate or sticker held by the entrant. Final score is computed by adding your Code Proficiency credit to your total number of QSO points. Then multiply that by your ARRL section/country total for your final score.

AWARDS:

Certificates will go to the top Novice

and Technician in each ARRL section and each single-operator Novice or Technician who submits a valid entry with 200 or more QSOs. Multi-operator or General-class licenses and above are not eligible for awards.

ENTRIES:

Contest forms are available from the ARRL for an SASE. Official forms are recommended. Any entry making more than 200 QSOs must submit duplicate-checking sheets with alphabetical listings of stations worked. Incomplete or late entries will be classified as check logs. Logs should include dates, QSO times, on and off times, complete exchange sent and received, and band. Postmark entries within 30 days after the contest, addressed to the ARRL, Newington CT 06111. Each entrant agrees to be bound by the provisions as well as the intent of the rules, regulations of his/her licensing authority, and the decisions of the ARRL Awards Committee. Usual ARRL disqualification rules apply.

MICHIGAN YL QSO PARTY
Starts: 1800 UTC January 25
Ends: 1800 UTC January 26

Sponsored by The Auto State Young Ladies (TASYLs). No crossband, net, or repeater QSOs are allowed. Each station can be contacted only once.

EXCHANGE:

RS(T), QTH, and TASYL# (for members).

SCORING:

Score one point per QSO and multiply by 2 if on CW. Multiply again by 2 if TASYL member. Multiply QSO points by number of different ARRL sections and DX countries worked.

ENTRIES:

Send logs to TASYL President Verline Ferris K18V, 308 E. Harry, Hazel Park MI 48030. Entries must be received by February 28, 1986.

The TASYL Certificate may also be earned during the QSO Party for working TASYL members. Charter Members 1 through 50 count 2 points, while all other members count 1 point. MI stations need 15 points, VE and other US stations need

10 points, and DX or VHF stations need 6 points. To apply for the award send a signed and dated log showing the date and time of contact, callsigns, frequency, RST, and TASYL number. Certification giving date and QTH must be on the original application and signed by one of the following: 2 licensed amateurs, General-class or higher (non-family), one official of a recognized club, or a notary public. Include \$1.00 to cover mailing costs, etc., and submit applications to Elaine Matyjaszek K8KAK, 1127 Hillcrest Dr., Boon MI 49618.

CLASSIC RADIO EXCHANGE
Starts: 2100 UTC January 26
Ends: 0400 UTC January 27

The purpose of this event is to restore, operate, and enjoy older equipment. A classic radio is one which was built since 1945 which is at least ten years old. The same station may be worked with different equipment combinations on each band on each mode. Non-contestants may be worked for credit.

EXCHANGE:

Name, RST, state/province/country, receiver and transmitter type (home-brew send PA tube, i.e., "807"), and any other points of interest.

FREQUENCIES:

CW—up 60 kHz from the low band edges; phone—3.910, 7.280, 14.280, 21.380, 28.580; Novice/Technician—3.720, 7.120, 28.120.

SCORING:

Multiply total QSOs (all bands and all equipment combinations used) by the total number of different receivers, transmitters, and states/provinces/countries worked on each band and mode. Multiply that total by your classic multiplier (total years old of all receivers and transmitters used—three QSOs minimum per unit; if equipment is a transceiver, multiply age by two).

ENTRIES:

Send logs, comments, anecdotes, etc., to Stu Stephens K8SJ, 1407 Hollywood Road, Sandusky OH 44870. Include an SASE for the *Classic Radio Newsletter* (published twice each year).

VHF POWER AMP
AM-6154/GRT (ITT 3211) 116-149.95 MHz RF amp, 50 watt output from 4-10 W input using Amperex DX393 or Eimac X651Z/8930; has silver-plated cavity in removable drawer. PA tube checked prior to shipment, but not guaranteed for use in modified amps. Requires 115/230 VAC & 20 VDC; 7x19.5x17, 75 lbs sh (UPS in 2 pkgs.). Used, not tested-good condition **\$209.50**

CU-872 HF ANTENNA COUPLER for up to eight 2-32 MHz receivers; 70 ohm output, N connections, test meter, and 20/6922 tubes. 7x9x16.5, 40 lbs sh. Used, **\$49.50**

ZM-11 UNIVERSAL BRIDGE, measures 10 pf-1100 mf Capacitance, 0.1 mH-110 H Inductance, Insulation DC Resistance, Transformer Turns Ratio, DC Leakage, Dissipation, and Q Storage. 115 VAC 60 Hz; 5.8x9x9.8, 18 lbs sh. Used-checked **\$115.00**; Manual partial repro, **\$8.50**

Prices F.O.B. Lima, O. • VISA, MASTERCARD Accepted.
 Allow for Shipping • Send for New FREE CATALOG
 Address Dept. 73 • Phone: 419/227-6573

FAIR RADIO SALES
 1016 E. EUREKA • Box 1105 • LIMA, OHIO • 45802

AUTHORIZED KENWOOD ICOM RADIO DEALER



H. L. HEASTER, INC., 203 Buckhannon Pike, Clarksburg, W. VA. 26301
 Clarksburg Phone (304) 624-5485 or W. VA. Toll-Free 1-800-352-3177
 Harold Heaster, K8BHX, 91 Ridgefield Place, Ormond Beach, Fla. 32074
 Florida Phone (904) 673-4066
 New Nationwide Toll-Free Telephone Number: 1-800-84-RADIO (1-800-84-72346)

Call us for a quotation, We Will Save You Money!!!

MOBILE-TO-TELEPHONE SIMPLEX AUTOPATCH



Here are a few of the many good reasons you should choose **HamPatch™**

- Superior construction; commercial grade
- Highly sophisticated toll restrict
- Automatic tape-recording facility
- 3-digit access; field programmable
- Advanced digital and linear circuitry
- FULL ONE YEAR WARRANTY

HamPatch™ is your best buy.

For further info on this and our other decoding products, call or write:

HXF ELECTRONICS
 Box 73, Station A
 Islington, Ontario
 Canada. M9A 4X1
 Tel. (416) 621-3733

CASE HISTORY!

For 2AT/3AT/4AT w/standard batt.

from **delta zulu**

\$24.95

free U.S. shipping
made in U.S.A.
90 day limited warranty



See through keypad window and instant access to all switches front, top, back plus unique zippered battery door. Fits with or w/o ICOM clip. Looks, feels and fits great. Black or burgundy tailored vinyl. Call (617) 599-3090.

Crowley Mfg. Co. 95 Federal St. Lynn MA 01905

TOUCHTONE™ DECODER KIT

MODEL TTK

\$22.95

- SSI 201 DTMF Receiver
- Receive all 16 DTMF digits
- No additional filtering
- Output BCD or hex format
- Low power (29ma @ 12V)
- Kit includes 3.58Mhz crystal, 22 pin IC socket, resistor, capacitors, data sheet and schematics

4 DIGIT SEQUENCE DECODER

MODEL TSD

\$59.95

- Completely wired & tested
- User programmable
- LED status indicator
- Open collector output
- Control relays, mute audio
- Control link on/off
- Custom IC insures high reliability & small size!
- Fits inside most rigs: runs on 12 VDC (35ma)
- Over 1500 different codes!
- Makes excellent private call on busy repeaters!
- Use it to turn on audio or sound an alarm
- Momentary and latching outputs

MasterCard and Visa accepted, or send check/M.O. Cal. address add 6%; price includes shipping USA. Send to:

ENGINEERING CONSULTING
583 CANDLEWOOD ST., BREA, CA 92621
TEL: 714-671-2009

ENGINEERING CONSULTING INTRODUCES

TOUCHTONE™ DTMF to RS-232-C 300 BAUD INTERFACE

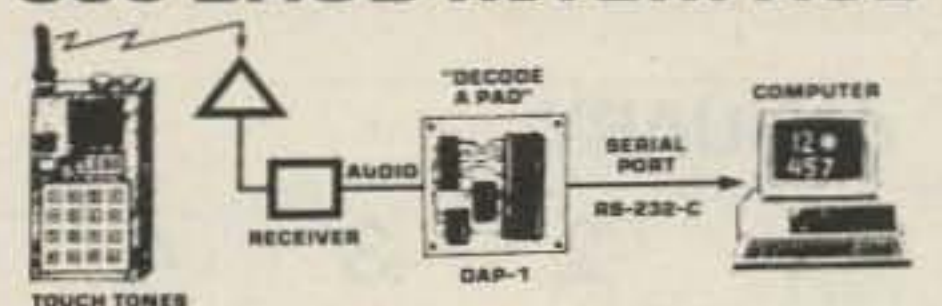

- Use your computer to decode DTMF touchtones.
- Receive all 16 digits as fast as they can be transmitted.
- Easily program your computer in BASIC to decode multi-digit "strings", display digits, sound alarms, observe secret codes, control relays, remote base
- Simple to use: just provide +12 VDC and audio, hook two wires to the RS-232-C serial input on your computer, enter a simple BASIC program and begin to decode.
- Sample BASIC program and instructions included
- LED Indicator

"Decode-A-Pad"
Model DAP-1
Wired and Tested
\$89.95

Includes shipping USA. Cal. addresses add 6%.
VISA and MasterCard accepted, or send check. M.O. to

ENGINEERING CONSULTING
583 CANDLEWOOD ST., BREA, CA 92621
714/671-2009

ENGINEERING CONSULTING INTRODUCES

'REMOTE A PAD'™ MODEL RAP-1

2 FOUR DIGIT DTMF DECODERS, PLUS 16 DIGIT KEYPAD CONTROL

TUNE THE WORLD FROM YOUR HANDHELD VHF/UHF RADIO



- Audio tones from any source, are converted to solid state switches which control any 16 digit keypad of a radio or other device.
- Some examples you can control include the Pro-Search™ Rotator (rotate beam remotely); ICOM IC-701 or ICOM IC-211 when using the RM-2 controller; ICOM 7550 & 751; Azden PCS 4000; handhelds such as Yaesu FT-208, FT-708; ICOM IC-02AT, and many more.
- Anything you can do manually with your 16 digit keypad, the RAP-1 will do remotely using audio touch tones from any source.
- Two (four digit) programmable access codes are used to operate relays or other on/off functions.
- LED decoder status indicators and momentary plus steady state decoder outputs are provided.
- 22 gold pin card edge connector, 16 pin dip socket and ribbon cable are supplied.
- All CMOS low power drain (30ma); SSI 201 Decoder.
- Hook eight wires (4 rows and 4 columns) in parallel with the existing keypad of the radio you wish to control remotely. Connect audio from any source, 12 volts D.C. and you are in control.
- The dual 4 digit decoders will turn your links on and off using your programmable access code.
- Detailed interface diagrams and instructions included with purchase. Interface cable for Pro-Search™ \$9.95 (plugs in acc. socket).

Model RAP-1
\$149.95

'Remote A Pad'™ Remote control interface board and DTMF decoder.

ICOM IC-02AT USER'S "AUDIO BLASTER"™ MODULE

Now Available for IC-2AT



- Module installs inside the radio in 10 minutes.
- Boosts audio to nearly 1 watt!
- Low power drain (4ms stand-by)
- Complete step by step instructions included
- Corrects the LOW audio problem!
- Drive external speakers to full volume, even signals with low deviation!

Model AB-1 **\$19.95**

Price includes postage and handling, U.S.A. CA res. add 6%

Send check or money order to:

ENGINEERING CONSULTING
583 CANDLEWOOD ST., BREA, CA 92621
(714) 671-2009

73 for Radio Amateurs

BACK ISSUES

Special Report:
Volunteer
HAM O
And You
Ten Million
The Incre
PRIVAT
EARTH
STATIONS

1977 to June 1980
..... \$3.00 ea.
July 1980 to Present
..... \$3.50 ea.

Add \$1.00 per magazine for shipping. 10 or more back issues add \$7.50 per order for shipping.

Write for your copy today!

73 for Radio Amateurs
Back Issue Order Dept.
80 Pine Street
Peterborough, NH 03458

RF TRANSISTORS

FRESH STOCK - NOT SURPLUS
TESTED - FULLY GUARANTEED

2-30 MHz 12V (* = 28V)

P/N	Rating	Each	Match Pr.
MRF406	20W	\$14.50	\$32.00
MRF412,IA	80W	18.00	45.00
MRF421	100W	25.00	56.00
MRF421C	110W	—	60.00
MRF422*	150W	38.00	82.00
MRF426,IA*	25W	18.00	42.00
MRF428**	150W	55.00	125.00
MRF433	12.5W	12.00	30.00
MRF435*	150W	42.00	90.00
MRF449,IA	30W	12.50	30.00
MRF450,IA	50W	14.00	31.00
MRF453,IA	60W	15.00	35.00
MRF454,IA	80W	16.00	36.00
MRF455,IA	60W	12.00	28.00
MRF458	80W	20.00	46.00
MRF460	60W	18.00	42.00
MRF464*	80W	25.00	60.00
MRF466*	40W	18.75	48.00
MRF475	12W	3.00	9.00
MRF476	3W	2.75	8.00
MRF477	40W	11.00	25.00
MRF479	15W	10.00	23.00
MRF485*	15W	6.00	15.00
MRF492	90W	18.00	40.00
SRF2072	75W	15.00	33.00
SRF3662	110W	28.00	60.00
SRF3775	75W	15.50	34.00
SRF3795	85W	16.50	37.00
CD2545	50W	23.00	52.00
SD1076	70W	17.00	40.00
SD1451	50W	15.00	36.00

Selected High Gain Matched Quads Available

VHF/UHF TRANSISTORS

Rating	MHz	Net Ea.	Match Pr.
MRF212	10W 136-174	\$16.00	—
MRF221	15W 136-174	10.00	—
MRF222	25W 136-174	14.00	—
MRF224	40W 136-174	13.50	32.00
MRF231	3.5W 66-88	10.00	—
MRF234	25W 66-88	15.00	39.00
MRF237	4W 136-174	3.00	—
MRF238	30W 136-174	12.00	—
MRF239	30W 136-174	15.00	—
MRF240	40W 136-174	18.00	—
MRF245	80W 136-174	28.00	65.00
MRF247	75W 136-174	27.00	63.00
MRF250	50W 27-174	20.00	46.00
MRF260	5W 136-174	7.00	—
MRF261	10W 136-174	9.00	—
MRF262	15W 136-174	9.00	—
MRF264	30W 136-174	13.00	—
MRF607	1.75W 136-174	3.00	—
MRF641	15W 407-512	22.00	—
MRF644	25W 407-512	24.00	54.00
MRF646	40W 407-512	26.50	59.00
MRF648	60W 407-512	33.00	69.00
2N3866*	1W 30-200	1.25	—
2N4427	1W 136-174	1.25	—
2N5591	25W 136-174	13.50	34.00
2N5642*	20W 30-200	13.75	34.50
2N5945	4W 407-512	10.00	—
2N5946	10W 407-512	12.00	—
2N6080	4W 136-174	6.25	—
2N6081	15W 136-174	7.50	—
2N6082	25W 136-174	8.90	—
2N6083	30W 136-174	9.30	24.00
2N6084	40W 136-174	11.75	28.50

TMOS FET

MRF134*	5W 2-200	\$10.50	—
MRF137*	30W 2-200	22.50	—
MRF138**	30W 1.5-150	35.00	—
MRF150**	150W 1.5-150	80.00	—
MRF172*	80 2-200	65.00	—

Selected, matched finals for Kenwood, Yaesu, Icom, Atlas, etc. Technical assistance and cross-reference information on CD, PT, RF, SRF, SD P/Ns.

QUANTITY DISCOUNTS AVAILABLE
WE SHIP SAME DAY C.O.D./VISA/MC
INFORMATION AND CALIF. ORDERS: (619) 744-0728
OUTSIDE CALIF. ORDER DESK: 800-854-1927



RF PARTS

1320-16 Grand Ave., San Marcos
California 92069 (619) 744-0728

DEALER DIRECTORY

Fontana CA

Complete lines ICOM, DenTron, Ten-Tec, Mirage, Cubic, Lunar, over 4000 electronic products for hobbyist, technician, experimenter. Also CB radio, land-mobile. Fontana Electronics, 8628 Sierra Ave., Fontana, CA 92335, 822-7710.

Preston ID

Ross WB7BYZ has the largest stock of amateur gear in the Intermountain West and the best prices. Call me for all your ham needs. Ross Distributing, 78 So. State, Preston ID 83263, 852-0830.

San Jose CA

Bay area's newest amateur radio store. New & used amateur radio sales & service. We feature Kenwood, ICOM, Azden, Yaesu, Ten-Tec, Santec & many more. Shaver Radio, Inc., 1775A S. Winchester Blvd., Campbell CA 95008, 370-6665.

New Castle DE

Factory Authorized Dealer! Yaesu, ICOM, Ten-Tec, KDK, Kenwood, AEA, Kantronics, Santec. Full line of accessories. No sales tax in Delaware. One mile off I-95. Delaware Amateur Supply, 71 Meadow Road, New Castle, DE 19720, 328-7728.

Littleton MA

The reliable ham store serving NE. Full line of ICOM & Kenwood. Drake, Daiwa, B&W accessories. Curtis & Trac keyers. Larsen, Hustler, Telex/Hy-Gain products. Mirage amps., Astron P.S., Alpha Delata protectors. ARRL & Kantronics instruction aids. Whistler radar detectors. Full line of coax fittings. TEL-COM Electronic Communications, 675 Great Rd. (Rt. 119), Littleton, MA 01460, 486-3400/3040.

Derry NH

Serving the ham community with new and used equipment. We stock and service most major lines: AEA, Astron, B&W, Cushcraft, Encomm, Hy-Gain, Hustler, ICOM, Kenwood, KLM, Larsen, Mirage, Mosley; books, rotors, cable and connectors. Business hours 10-7 Monday through Thursday, and 10-5 Friday and Saturday. Rivendell Electronics, 8 Londonderry Road, Derry NH 03038, 434-5371.

DEALERS

Your company name and message can contain up to 25 words for as little as \$150 yearly (prepaid), or \$15 per month (prepaid quarterly). No mention of mail-order business or area code permitted. Directory text and payment must reach us 60 days in advance of publication. For example, advertising for the April '86 issue must be in our hands by February 1st. Mail to 73 Magazine, Peterborough, NH 03458. ATTN: Nancy Ciampa.

MOVING?

SUBSCRIPTION PROBLEM?

Get help with your subscription by calling our new toll free number:

1-800-227-5782

between 9 a.m. and 5 p.m. EST, Monday-Friday.

If possible, please have your mailing label in front of you as well as your cancelled check or credit card statement if you are having problems with payment.

If moving, please give both your old address and new address.

PROPAGATION

Jim Gray W1XU
73 Staff

EASTERN UNITED STATES TO:

	00	02	04	06	08	10	12	14	16	18	20	22
ALASKA							20	20				
ARGENTINA	20	40	40	40	80	80			20	15	15	
AUSTRALIA	20		20		40	40	20	20			15 ¹	15 ¹
CANAL ZONE	15	20	20	40	40		20	20	15	15	15*	15*
ENGLAND	20	40	80	40	40		20	20	20	20	20	20
HAWAII	20		20		40	40	80	20			15 ¹	15 ¹
INDIA						20 ¹	40 ¹	20 ¹				15 ¹
JAPAN	20						20	20				20
MEXICO	15	20	20	40	40		20	20	15	15	15*	15*
PHILIPPINES							20					
PUERTO RICO	15	20	20	40	40		20	20	15	15	15*	15*
SOUTH AFRICA			40 ¹	40 ¹				15	15	15	20	20
U. S. S. R.	40	80	80	40			20	20	20			40
WEST COAST		80	80	40	40	40	20	20	20			

CENTRAL UNITED STATES TO:

ALASKA						80*	40*	20				
ARGENTINA	20		40	40	40					15	15	
AUSTRALIA	15					40	20	20	20			15
CANAL ZONE	20	80	40	40	40	40	20	20	15	15	15	20
ENGLAND	40	40	40	80				20	15	20		40
HAWAII	15	20			40	40	40				15	15
INDIA	15 ¹	20 ¹	20 ¹				40 ¹	20 ¹	20 ¹			
JAPAN						80*	40*	20				
MEXICO	20	80	40	40	40	40	20	20	15	15	15	20
PHILIPPINES								20				
PUERTO RICO	20	80	40	40	40	40	20	20	15	15	15	20
SOUTH AFRICA	20	40*							15	15	20	20
U. S. S. R.	40		40	40				20	20			

WESTERN UNITED STATES TO:

ALASKA	15	20			40	40	40	40	40			20
ARGENTINA	15	20		40	40	40	40	40		15	15	15
AUSTRALIA	15	20	20				40	80*	40	15	15	15
CANAL ZONE	20	20		40	40	40			20	15	15	15
ENGLAND			80*	40					20	20		
HAWAII	15	15			20	20	20	20				15
INDIA		20										
JAPAN	15	20			40	40	40	40	40			20
MEXICO	20	20		40	40	40			20	15	15	15
PHILIPPINES	15	20					40	40		20		20
PUERTO RICO	20	20		40	40	40			20	15	15	15
SOUTH AFRICA	20	40 ¹	40 ¹							15	15	20
U. S. S. R.		40 ¹	40 ¹	40 ¹	40 ¹				20	20		
EAST COAST		80	80	40	40	40	20	20	20			

1 = May be open only once or twice during month.
* = Try next higher band.

G = Good, F = Fair, P = Poor.

JANUARY						
SUN	MON	TUE	WED	THU	FRI	SAT
			1	2	3	4
			P-F	F	F	P
5	6	7	8	9	10	11
G-F	G-F	P	F	P	P	F
12	13	14	15	16	17	18
G	G	G	F	G	G	F
19	20	21	22	23	24	25
P	P	F	G	G	F-P	P
26	27	28	29	30	31	
F	G	G	G	G	G	

ADVERTISERS

AEA/Advanced Electronic Applications	91
All Electronics	35
Amateur Comm., Etc.	71
Amateur Electronic Supply	19, 49
Ampro Computers, Inc.	20
Astatic Corp.	48
Astron Corp.	27
Barker & Williamson	34
Barry Electronics	25
Bencher, Inc.	95
Bilal Co.	71
Bill Ashby & Son	38
CW Communications, Inc.	39
CES, Inc.	96
CeCo Communications	33
CMC Communications	34
Charge-Rite	79
Coaxial Dynamics	15
Communications Specialists, Inc.	16
Computer Trader	61
Connect Systems, Inc.	2
Crowley Mfg. Co.	93
Crumtronics	38
Dayton Hamvention	33
Dick Smith Electronics	15
EGE, Inc.	21
Etron RF Enterprises	72
Engineering Consulting	93
Fair Radio Sales	92
GLB Electronics	45
Grove Enterprises	43
HXF Electronics	92
H.L. Heaster, Inc.	92
Ham Radio Outlet	1
The Ham Station	43
Hamtronics, NY	73
Hardin Electronics	71
ICOM America, Inc.	Cov. II, 11
Indiana Hamfest	71
Jensen Tools, Inc.	61
John Meshna, Jr. Co., Inc.	74
Kantronics	89
KB1T Radio Specialties	71
Kenwood	5, 6, 9, Cov. IV
Lance Johnson Engineering	15
MFJ Enterprises	86, 87
Maggiore Electronic Lab	53
The Martin Co.	71
Meadowlake Corp.	61
Merrimac Satellite	62
Micro Control Specialties	89
Microlog Corp.	45
Micro Mart	47
Mobile Antennas & Accessories	62
NCN Electronics	71
N.P.S., Inc.	72
Nemal Electronics	72
P.C. Electronics	33, 84
The "PX" Shack	41
Palomar Engineers	95
QEP's	72
RF Parts Co.	93
Radio Amateur Callbook, Inc.	48
Radio Engineers	62
Ramsey Electronics	75
73	
Back Issues	13, 93
Mailing List	85
Moving	85
Subscriptions	81, 94
S-F Amateur Radio	48
Satman	15
Slep Electronics	72
Spectrum Communications	10
Spectrum International	13
TSG	79
Ten-Tec	13
TNT Radio Sales	85
Transleteronic	95
Tropical Hamboree	26
Unity Electronics	62
The VHF Shop	79
Vanguard Labs	71
W9INN Antennas	72
Westcom/RF Parts	93
Western Electronics	71
Yaesu Electronics	Cov. III



TAKE THE CURE!

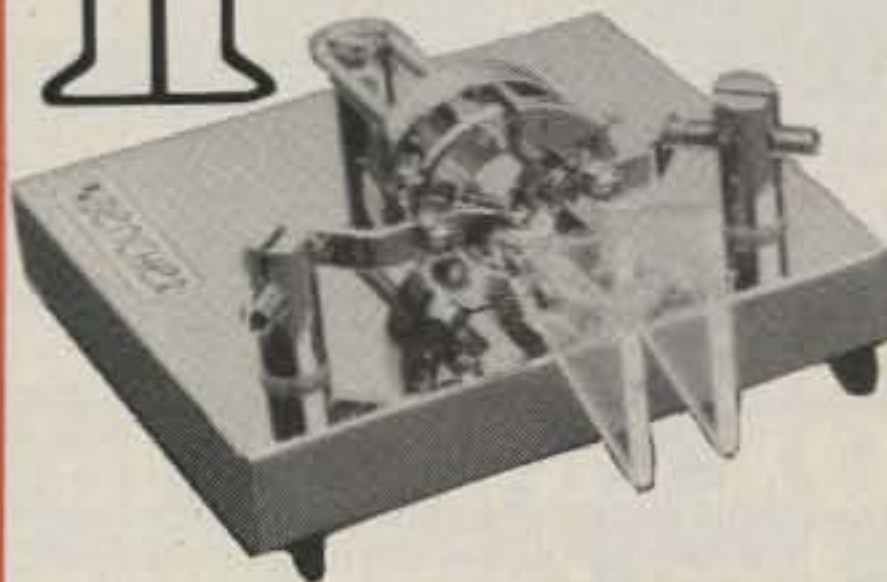

for boring QSO's and blah operating habits. A new Bencher paddle with the amazingly smooth response and perfect tracking that Bencher paddles are famous for is a sure cure for the blahs. Discover the joy that CW can be - see your dealer for one of the excitement machines.

At Bencher, we didn't invent CW— But we perfected it.

BENCHER, INC.



TUBES and IC's

FAST DELIVERY

LOWEST PRICES

call Toll Free (800) 221-5802

In-depth Inventory - Industrial & Receiving Tubes
Here are 2 dozen examples:

3-400Z	\$85.00	8122	\$110.00
3-500Z	85.00	MRF450	12.95
572B	61.50	MRF454	18.95
811A	12.00	MRF455	14.95
6146B	8.75	MRF492	19.95
M2057	15.00	6LF6	8.26
8950	12.50	6JS6C	7.46
807	5.75	6KD6	8.26
6550A	8.25	6MJ6	8.38
4CX250B	60.00	8417	8.38
6DJ8	2.75	7360	13.95
6883B	9.50	6CA7	5.55

Major Manufacturers Factory Boxed and Full line of Sylvania ECG Replacement Semiconductors

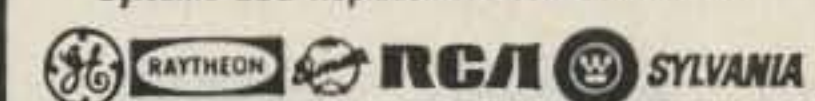

Minimum order \$25.00 Allow \$3 UPS charge

TRANSLETERONIC INC.



Box S, 1365 39th Street, Brooklyn, NY 11218
Tel. 718-633-2800/Watts Line 800-221-5802

FAX # (718) 633-4375

R-X NOISE BRIDGE

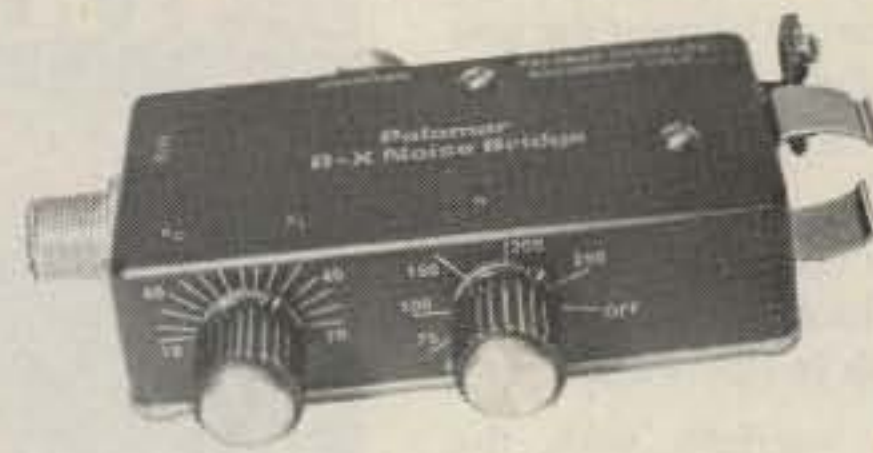

•Learn the truth about your antenna.

The Palomar R-X Noise Bridge tells you if your antenna is resonant or not and, if it is not, whether it is too long or too short. It gives resistance and reactance readings on dipoles, inverted Vees, quads, beams, multiband trap dipoles and verticals from 1 to 100 MHz.

Why work in the dark? Get the instrument that really works, the Palomar R-X Noise Bridge. Model RX-100 \$59.95 + \$4 shipping/handling in U.S. and Canada. California residents add sales tax.

SWR & POWER METER

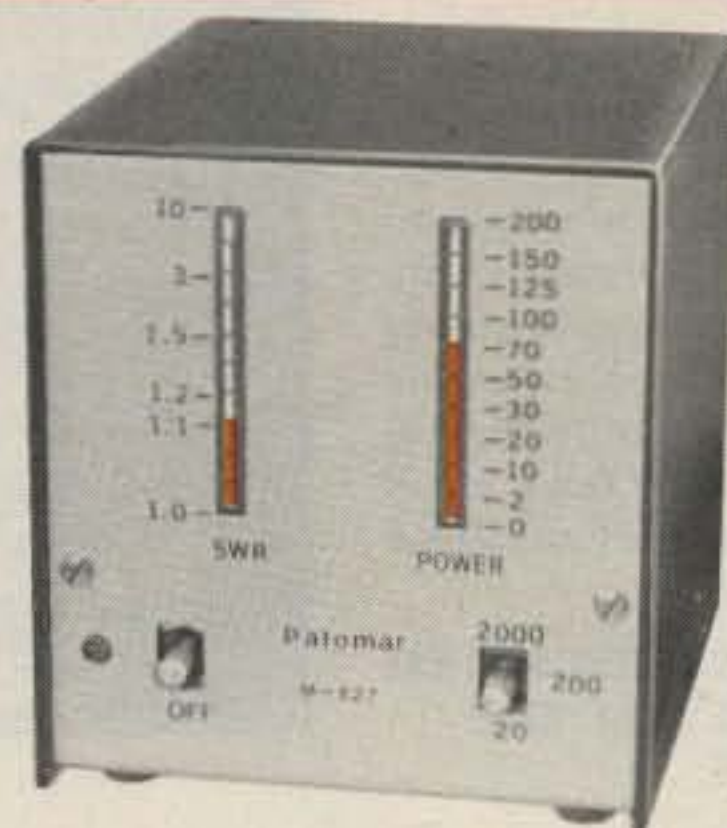

•The only meter that shows PEP output directly, accurately, instantly.

Shows power and SWR on bright red light bars. See PEP and SWR while you talk! Automatic "hands-off" SWR reading. Power ranges 20-200-2000 watts. Works from 1-30 MHz. For 115-v AC, 220-v AC and 12-v DC models also available.

Model M-827 \$129.95 + \$4 shipping/handling in U.S. and Canada. California residents add sales tax.

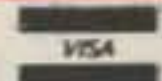
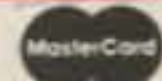

Send for FREE catalog that shows our complete line of noise bridges, SWR meters, pre-amplifiers, loop antennas, VLF converters, audio filters, baluns, RTTY equipment, toroids and more.

PALOMAR ENGINEERS

BOX 455, ESCONDIDO, CA 92025
Phone: (619) 747-3343

What To Look For In A Phone Patch

The best way to decide what patch is right for you is to first decide what a patch should do. A patch should:

- Give complete control to the mobile, allowing full break in operation.
- Not interfere with the normal operation of your base station. It should not require you to connect and disconnect cables (or flip switches!) every time you wish to use your radio as a normal base station.
- Not depend on volume or squelch settings of your radio. It should work the same regardless of what you do with these controls.
- You should be able to hear your base station speaker with the patch installed. Remember, you have a base station because there are mobiles. **ONE OF THEM MIGHT NEED HELP.**
- The patch should have standard features at no extra cost. These should include programmable toll restrict (dip switches), tone or rotary dialing, programmable patch and activity timers, and front panel indicators of channel and patch status.

ONLY SMART PATCH HAS ALL OF THE ABOVE.

Now Mobile Operators Can Enjoy An Affordable Personal Phone Patch. . .

- Without an expensive repeater.
- Using any FM transceiver as a base station.
- The secret is a **SIMPLEX** autopatch, The **SMART PATCH**.

SMART PATCH Is Easy To Install

To install **SMART PATCH**, connect the multicolored computer style ribbon cable to mic audio, receiver discriminator, PTT, and power. A modular phone cord is provided for connection to your phone system. Sound simple? . . . **IT IS!**

With SMART PATCH You are in CONTROL



With **CES 510SA Simplex Autopatch**, there's no waiting for **VOX** circuits to drop. Simply key your transmitter to take control.



SMART PATCH is all you need to turn your base station into a personal autopatch. **SMART PATCH** uses the only operating system that gives the mobile complete control. Full break-in capability allows the mobile user to actually interrupt the telephone party. **SMART PATCH** does not interfere with the normal use of your base station. **SMART PATCH** works well with any FM transceiver and provides switch selectable tone or rotary dialing, toll restrict, programmable control codes, CW ID and much more.

**To Take CONTROL with Smart Patch
— Call 800-327-9956 Ext. 101 today.**

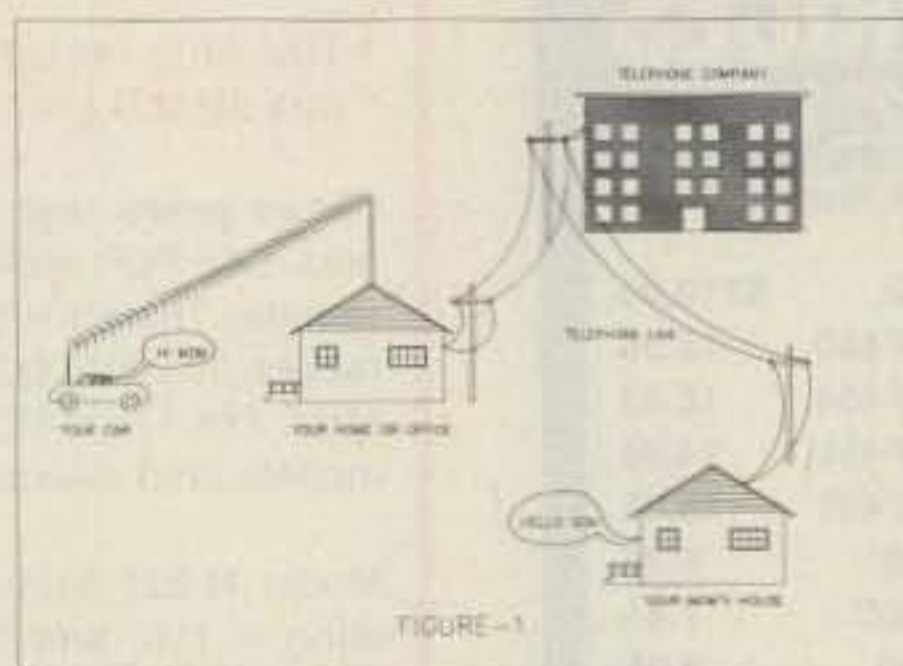

FIGURE-1

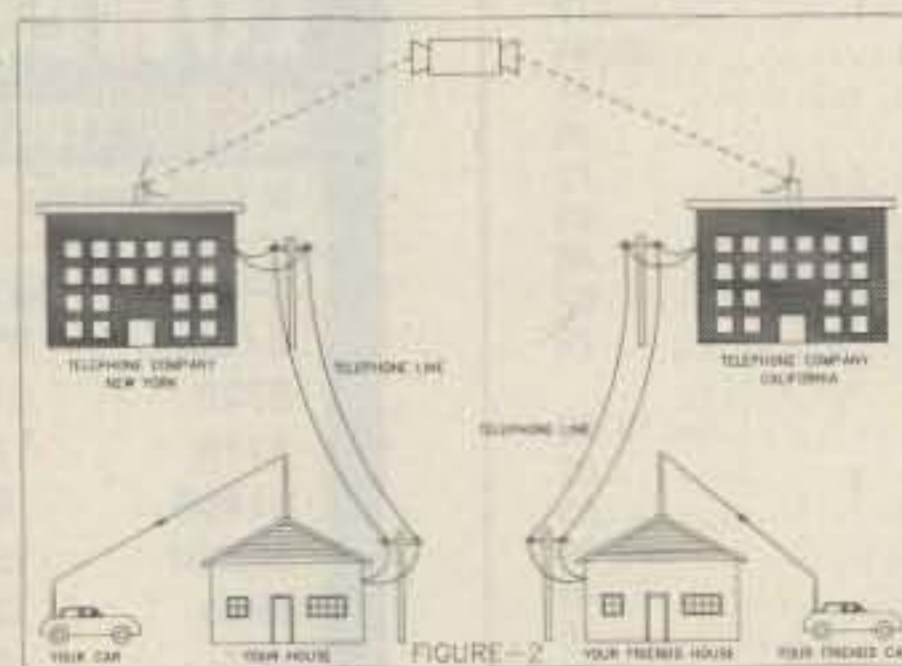

FIGURE-2

How To Use SMART PATCH

Placing a call is simple. Send your access code from your mobile (example: *73). This brings up the Patch and you will hear dial tone transmitted from your base station. Since **SMART PATCH** is checking about once per second to see if you want to dial, all you have to do is key your transmitter, then dial the phone number. You will now hear the phone ring and someone answer. Since the enhanced control system of **SMART PATCH** is constantly checking to see if you wish to talk, you need to simply key your transmitter and then talk. That's right, you simply key your transmitter to interrupt the phone line. The base station automatically stops transmitting after you key your mic. **SMART PATCH** does not require any special tone equipment to control your base station. It samples very high frequency noise present at your receiver's discriminator to determine if a mobile is present. No words or syllables are ever lost.

SMART PATCH Is All You Need To Automatically Patch Your Base Station To Your Phone Line.

Use **SMART PATCH** for:

- Mobile (or remote base) to phone line via Simplex base. (see fig 1.)
- Mobile to Mobile via interconnected base stations for extended range. (see fig. 2.)
- Telephone line to mobile (or remote base).
- **SMART PATCH** uses **SIMPLEX BASE STATION EQUIPMENT**. Use your ordinary base station. **SMART PATCH** does this without interfering with the normal use of your radio.

WARRANTY?

YES, 180 days of warranty protection. You simply can't go wrong. An FCC type accepted coupler is available for **SMART PATCH**.



Communications Electronics Specialties, Inc.

P.O. Box 2930, Winter Park, Florida 32790

Telephone: (305) 645-0474 Or call toll-free (800)327-9956



Celebrate your buying decision with the money you've saved.

When it comes to getting maximum HF performance for your dollar, the choice is clear. Yaesu's FT-757GX.

Nowhere else will you find so many HF features packed into one compact, mobile-ready package. At a price that's got the competition baffled.

For starters, each 757 includes an electronic keyer. 600-Hz CW filter. AM and FM modes. AF speech processor. And a 25-kHz marker generator. All at no extra charge.

And working the DX has never been easier with dual VFOs, single-button VFO/memory swap for split-frequency operation, eight

memories, and push-button quick memory and band scan.

The 757 also lets you listen from 500 kHz to 30 MHz with its high-performance general coverage receiver. The transmitter covers 160 through 10 meters, including the new WARC bands, with 100 watts output on sideband, FM and CW.

CW buffs will enjoy the delights of full QSK operation. Plus the massive heatsink and duct-flow cooling system allow continuous RTTY operation for up to 30 minutes. Use the FP-757HD heavy-duty power supply option for continuous-duty applications.

And of course, there's the 757's highly attractive price. It's the

perfect way to get all the HF performance you desire, with money left over to apply toward other ham gear. Perhaps a power supply for base station use. An antenna or antenna tuner. Or whatever else makes your operation complete.

So ask your dealer today about Yaesu's FT-757GX. The most celebrated HF price/performer on the air.

YAESU

*Yaesu Electronics Corporation
6851 Walthall Way, Paramount
CA 90723 (213) 633-4007*

*Yaesu Cincinnati Service Center
9070 Gold Park Drive, Hamilton
OH 45011 (513) 874-3100*

KENWOOD

...pacesetter in Amateur radio

ALL
NEW!

Power-Full...70 Watts!

TM-2570A/2550A/2530A

Sophisticated FM transceivers

Kenwood sets the pace again!
The all-new "25-Series" brings the industry's *first* compact 70-watt 2-meter FM mobile transceiver. There is even an *auto dialer* which stores 15 telephone numbers! There are three power versions to choose from: The TM-2570A 70-watt model, the TM-2550A for 45-watts, and the 25-watt TM-2530A.

- **First** 70-watt FM mobile (TM-2570A)
- **First** mobile transceiver with telephone number memory and auto-dialer (up to 15 telephone numbers)
- Direct keyboard entry of frequency
- Automatic repeater offset selection according to the ARRL 2-meter band plan — **a Kenwood exclusive!**
- Extended frequency coverage for MARS and CAP (142-149 MHz; 141-151 MHz modifiable)
- 23 channel memory for offset, frequency and sub-tone
- Big multi-color LCD and back-lit controls for excellent visibility

- Front panel programmable 38-tone CTCSS encoder **includes 97.4 Hz** (optional)
- 16-key DTMF pad, with audible monitor
- Center-stop tuning — **another Kenwood exclusive!**
- Frequency lock switch
- **New** 5-way adjustable mounting system
- **Unique** offset microphone connector — relieves stress on microphone cord

- HI/LOW Power switch (adjustable LOW power)
- Compact DIN size

Large heatsink with built-in cooling fan (TM-2570A)



DCL Introducing... Digital Channel Link

Compatible with Kenwood's DCS (Digital Code Squelch), the DCL system enables your rig to **automatically** QSY to an open channel. Now you can automatically switch over to a simplex channel after repeater contact! Here's how it works:

The DCL system searches for an open channel, remembers it, returns to the original frequency and transmits control information to another DCL-equipped station that switches **both** radios to the open channel. Micro-processor control assures fast and reliable operation. The whole process happens in an instant!

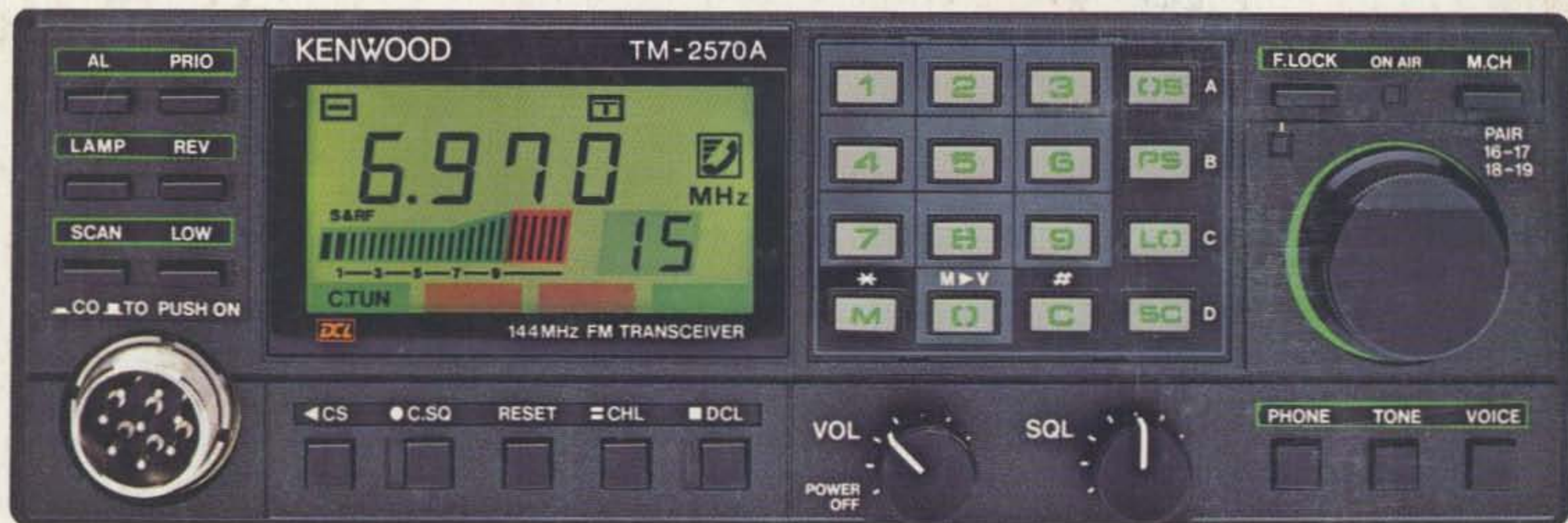

Optional Accessories

- **TU-7** 38-tone CTCSS encoder
- **MU-1** DCL modem unit
- **VS-1** voice synthesizer
- **PG-2K** extra DC cable
- **PG-3A** DC line noise filter
- **MB-10** extra mobile bracket
- **CD-10** call sign display
- **PS-430** DC power supply for TM-2550A/2530A
- **PS-50** DC power supply for TM-2570A
- **MC-60A/MC-80/MC-85** desk mics.
- **MC-48** extra DTMF mic. with UP/DWN switch
- **MC-42S** UP/DWN mic.
- **MC-55** (8-pin) mobile mic. with time-out timer
- **SP-40** compact mobile speaker
- **SP-50** mobile speaker
- **SW-200A/SW-200B** SWR/power meters
- **SW-100A/SW-100B** compact SWR/power meters
- **SWT-1** 2m antenna tuner

Actual size front panel

KENWOOD

TRIO-KENWOOD COMMUNICATIONS
1111 West Walnut Street
Compton, California 90220

Complete service manuals are available for all Trio-Kenwood transceivers and most accessories. Specifications and prices are subject to change without notice or obligation.