

January 1981 \$2.95

73 MAGAZINE

FOR RADIO AMATEURS



The Ups & Downs
of VHF Contesting



2K

Classic

A new

edition of the world's most famous linear amplifier



The 2K Classic represents the culmination of fifteen years experience in developing, manufacturing and improving the 2K series. It remains as always a "workhorse", engineered and built to loaf along at full legal power for days or weeks without rest. A look inside shows why! No expense has been spared to make the 2K a truly "Classic" Amateur amplifier. Heavy duty, top quality components along with its rugged construction assures you of trouble free operation. The 2K Classic offers engineering and features second to none. It will put your signal on the air with greater strength and clarity than you ever dreamed possible. The 2K Classic operates on all amateur bands, 80 through 15 meters (export models include 10 meters).

Features:

- Two rugged Eimac 3-500Z grounded grid triodes
- Pi-L plate circuit with silver plated tank coil
- Resonant cathode pi input circuit
- Maximum legal input on all modes
- Price: \$1195.00

The **1KD-5** ...Another fine member of the famous Henry Radio family of superior amplifiers. And we're still convinced that it's the world's finest linear in its class. The 1KD-5 was designed for the amateur who wants the quality and dependability of the 2KD-5 and 2K-4, who may prefer the smaller size, lighter weight and lower price and who will settle for a little less power. But make no mistake, the 1KD-5 is no slouch. Its 1200 watt PEP input (700 watt PEP nominal output) along with its superb operating characteristics will still punch out clean powerful signals...signals you'll be proud of. Compare its specifications, its features and its fine components and we're sure you will agree that the 1KD-5 is a superb value at only \$695.

The **2KD-5** We have been suggesting that you look inside any amplifier before you buy it. We hope that you will. If you "lift the lid" on a 2KD-5 you will see only the highest quality, heavy duty components and careful workmanship...attributes that promise a long life of continuous operation in any mode at full legal power. The 2KD-5 is a 2000 watt PEP input (1200 watt PEP nominal output) RF linear amplifier, covering the 80, 40, 20, and 15 meter amateur bands. It operates with two Eimac 3-500Z glass envelope triodes and a PI-L plate circuit with a rotary silver plated tank coil. Price \$945.

And don't forget the rest of the Henry family of amateur amplifiers...the Tempo 2002 high power VHF amplifier and the broad line of top quality solid state amplifiers. Henry Radio also offers the 3K-A and 4K-Ultra superb high power H.F. amplifiers and a broad line of commercial FCC type accepted amplifiers for two way FM communications covering the range to 500 MHz.



Announcing!

A brand new "super" linear...the 3K Classic! Designed for the most critical Amateur Radio operator...the individual who wants and appreciates owning the finest. Available in spring 1981.

F.C.C. approval pending



Please note, as of Dec. 1, 1980 we will occupy our new world headquarters building with a new Los Angeles address and phone number.

2050 S. Bundy Dr., Los Angeles, CA 90025	(213) 820-1234
931 N. Euclid, Anaheim, CA 92801	(714) 772-9200
Butler, Missouri 64730	(816) 679-3127

TOLL FREE ORDER NUMBER: (800) 421-6631
For all states except California.
Calif. residents please call collect on our regular numbers.

Henry Radio

Prices subject to change without notice



INEXPENSIVELY SUPERIOR

The DS2000 KSR is the lowest priced RTTY terminal available with these advanced features:

345

- TX/RX operation on Baudot and ASCII RTTY plus Morse Code (Morse RX optional)
- Integrated keyboard and video generator allows editing of transmit text
- Full 24 line by 72 characters per line display
- Bright/dim display of characters differentiates between TX and RX display
- Morse receive option may be added at any time
- Separate CW identification key for RTTY operation
- Status line on top of screen shows terminal operating conditions
- Pretype transmit message into 255 character buffer; edit before transmitting
- 2 programmable "Here Is" messages
- Word-wrap-around prevents word splitting at end of display line
- Word mode allows editing of text to be transmitted
- Quick Brown Fox and RYRY test message keys
- Small size metal cabinet gives effective RFI shielding from transmitters
- Loop compatible RTTY connections and plus or minus CW key connections
- 110 and 300 baud ASCII
- 45,50,57,74,100 baud Baudot
- 1-175 wpm Morse transmit
- 1-175 wpm optional Morse receive
- 120/240 v, 50/60 Hz power
- Internal CW side-tone
- UnShift On Space for Baudot
- Keyboard Operated Switch
- SYNC idle for RTTY
- One year warranty

NEW YEAR'S SALE
DS 2000... \$395
CALL US FOR DETAILS

Write or give us a call. We'll be glad to send you our new RTTY catalog.



HAL COMMUNICATIONS CORP.
 Box 365
 Urbana, Illinois 61801
 217-367-7373

For our European customers, contact: Richter & Co. D3000
 Hannover 1 • I.E.C. Interelco, 6816 Bissone/Lugano • Radio
 Shack Ltd., London NW6 3AY • Erik Torpdahl Telecom, DK 3660
 Stenlose Denmark

DS2000 KSR.....	\$499.00
ESM-914 Video Monitor...	\$169.00
MR2000	
Morse receive option....	\$159.00

INFO

Manuscripts

Contributions in the form of manuscripts with drawings and/or photographs are welcome and will be considered for possible publication. We can assume no responsibility for loss or damage to any material. Please enclose a stamped, self-addressed envelope with each submission. Payment for the use of any unsolicited material will be made upon acceptance. All contributions should be directed to the 73 editorial offices. "How to Write for 73" guidelines are available upon request.

Editorial Offices:

Pine Street
Peterborough NH 03458
Phone: 603-924-3873, 924-3874

Advertising Offices:

Elm Street
Peterborough NH 03458
Phone: 603-924-7138

Circulation Offices:

Elm Street
Peterborough NH 03458
Phone: 603-924-7296

Subscription Rates

In the United States and Possessions:
One Year (12 issues) \$25.00
Two Years (24 issues) \$38.00
Three Years (36 issues) \$53.00

Elsewhere:

Canada—\$27.00/1 year only, U.S. funds. Foreign surface mail—\$35.00/1 year only, U.S. funds. Foreign air mail—\$62.00/1 year only, U.S. funds.

To subscribe, renew or change an address:

Write to 73 Magazine, Subscription Department, PO Box 931, Farmingdale NY 11737. For renewals and changes of address, include the address label from your most recent issue of 73. For gift subscriptions, include your name and address as well as those of gift recipients. Postmaster: Send form #3579 to 73 Magazine, Subscription Services, P.O. Box 931, Farmingdale, NY 11737.

Subscription problem or question:

Write to 73 Magazine, Subscription Department, PO Box 931, Farmingdale NY 11737. Please include an address label.

73 Magazine (ISSN 0098-9010) is published monthly by 73, Inc., 80 Pine Street, Peterborough NH 03458. Second class postage paid at Peterborough NH 03458 and at additional mailing offices. Copyright (c) 1980 by 73, Inc. All rights reserved. No part of this publication may be reprinted or otherwise reproduced without written permission from the publisher. Microfilm Edition—University Microfilm, Ann Arbor MI 48106.



"BRAND NEW"
**CHAMPION MESSAGE
MEMORY KEYS**
Model TE-292
\$125.95

PLUS:

Features:

- State-of-the-Art-CMOS Circuitry
- Choice of Message Storage
 - A. Six 50 character messages
 - B. Twelve 25 character messages
 - C. 27 combinations of message C. programming.
- Records at any speed—plays at any speed.
- Memory operating LED
- Use for daily QSO or contests

- Self-completing dots and dashes
- Both dot and dash memory
- Iambic Keying with any squeeze paddle
- 5-50 w.p.m.
- Speed, volume, tone, tune and weight controls
- Sidetone and speaker
- Low current drain CMOS battery operation—portable
- Rear panel Jack for auxiliary power
- Deluxe quarter-inch jacks for keying and output
- Keys grid block and solid rigs
- WIRED AND TESTED FULLY GUARANTEED—LESS BATTERY

\$89.95

Features: Model TE-284

- State-of-the-Art CMOS Circuitry
- Three choices of Message Storage
 - A. Two (50 character each) message storage
 - B. Four (25 character each) message storage
 - C. One 50 character and two 25 character message storage
- Records at any speed—plays at any speed
- Memory operating LED
- Use for daily QSO or contests

PLUS:

- Self-completing dots and dashes
- Both dot and dash memory
- Iambic Keying with any squeeze paddle
- 5-50 w.p.m.
- Speed, volume, tone, tune and weight controls
- Sidetone and speaker
- Low current drain CMOS battery operation—portable
- Deluxe quarter-inch jacks for keying and output
- Keys grid block and solid rigs
- WIRED AND TESTED FULLY GUARANTEED—LESS BATTERY



MESSAGE MEMORY KEYS

Model # TE201

\$69.95

Features:

- Advanced CMOS message memory
- Two (50 char each) message storage
- Repeat function
- Records at any speed—plays back at any speed
- Longer message capacity
Example: send CQ CQ CQ DX de WB2YJM WB2YJM K—then play second message on contact—de WB2YJM QSL NY NY 579 579 Paul Paul K
- Use for daily QSOs or contests

PLUS:

- State-of-the-art-CMOS keyer
- Self completing dots and dashes
- Both dot and dash memory
- Iambic keying with any squeeze paddle
- 5-50 wpm
- Speed, volume, tone, tune and weight controls
- Sidetone and speaker
- Low current drain CMOS battery operation—portable
- Deluxe quarter-inch jacks for keying and output
- Keys grid block and solid state rigs
- WIRED AND TESTED FULLY GUARANTEED—LESS BATTERY



Model # TE144

\$59.95

Features: Deluxe CMOS Electronic Keyer

- State-of-the-art CMOS circuitry
- Self completing dots and dashes
- Both dot and dash memory
- IAMBIC keying with any squeeze paddle 5-50 wpm
- Speed, weight, tone, volume tune controls & sidetone and speaker
- Semi-automatic "bug" operation & straight keying—rear panel switch
- Low current drain CMOS battery operation—portable
- Deluxe quarter inch jacks for keying and output
- Keys grid block and solid state rigs
- Wired and tested—fully guaranteed—less battery

MODEL TE133—same as TE144 with wgt and tone control internal, less semi-auto keying. **\$49.95**

MODEL TE122—same as TE133 less wgt, tune, solid state keying **\$36.50**

AT YOUR DEALER OR SEND CHECK OR MONEY ORDER.

Plus \$2.00 S/H NY Res add tax

TRAC

ELECTRONICS, INC
1106 RAND BLDG.
BUFFALO NY 14203

76

Emergency Tone Alert System WB5UVC, WB5ASA, WB5PRD	42
WWV-to-80-Meter Converter N7BH	48
Cheap and Simple — your basic 13.8-V, 25-A power supply. . . . WA9VLK	50
Direct Printing FAX — part III: testing and operation. WB8DQT	54
Unplug It, Dummy! — safety for the traveling ham. WB9SKX	58

Don't Be Sunk by Heat Sinks — a painless introduction to heat-transfer physics WA4OSH	86
Tracker— The Ultimate OSCAR Finder IO WD8DRK, K8UR	88
You Still Haven't Built a Logic Probe? IO — try this one. Vergona	96
VHF Contesting — a magnificent obsession. N8RK	100
Sell 'Em with Slides — A/V shows can fire club enthusiasm. N8BPI	104
The Power Waster — adjustable electronic load for power supply testing. K6IQL	108

jan. 81

73 MAGAZINE

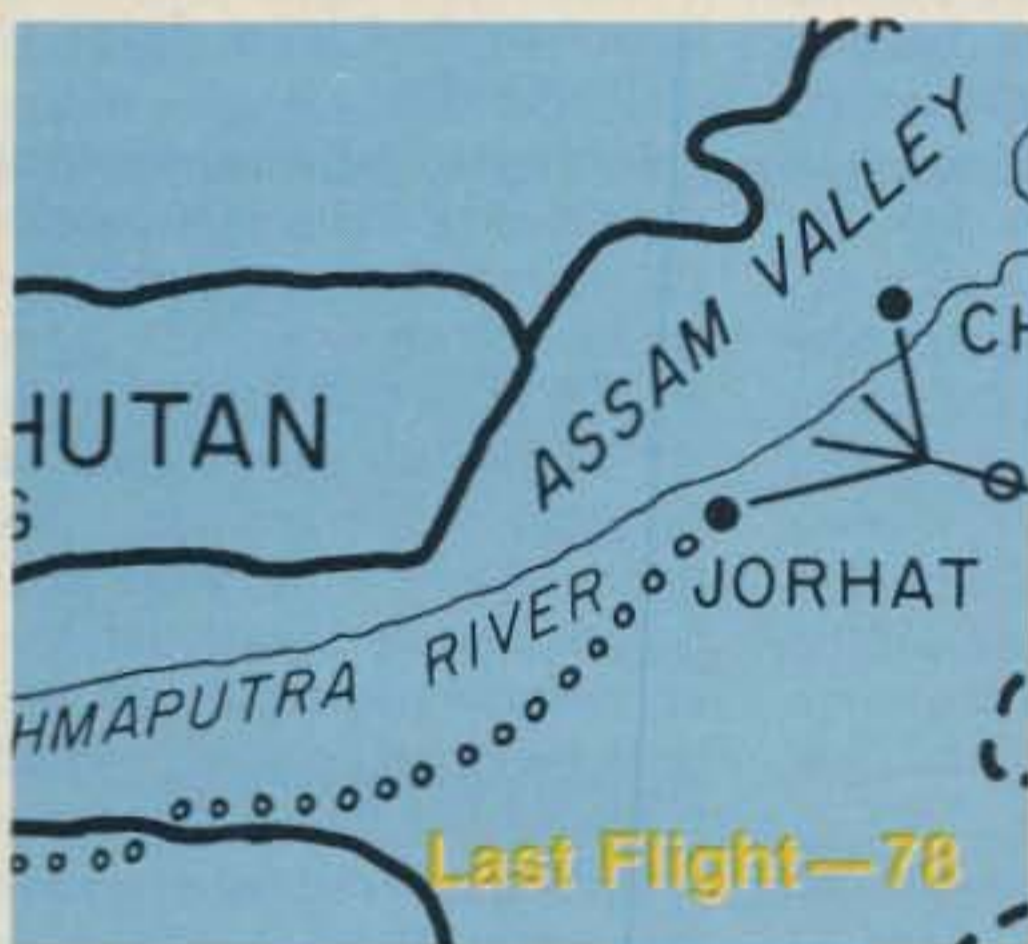

Power Plus for the Omni — improving on Ten-Tec's power supply WA4IQQ	60
Oddball Offsets for the KDK-2015R — make a good rig better. WB6MYF	62
The Strange Predicament of Walter Hann — OE8WHK did the right thing— and suffered the consequences. WA4PYQ	66
Put "the Rep" in Your Repeater — an automatic autopatch dialer. K4ALS	68
Quick and Dirty Line Noise Suppressor WA4PYQ	76
Over the Hump and into History — the last flight of #42-107270. Ritchey	78
R_x and C_x — easy-to-build substitution boxes. WD5CDJ	84

QRZ Sunshine — building solar-powered repeaters. WB3HXY	114
Transmitter Tune-Up for Blind Hams — an audible indicator for power out. WA4LBX	120
Installing Subaudible Tone Encoders — do it right. WA7LMO/N6XB	126
Four-Band Mobile Antenna — looks like a weird hat rack. K5PTC	129
Computers and HF — a discussion of alternatives. W9JD/DA1FE	130
Ned Novice and his Capacitance Meter — you, too, can build one. W4VGZ	132
Daze of Whine and Noises — intoxicating information about alternators K2PMA	146

Never Say Die—6, Looking West—12, Contests—14, Awards—16, RTTY Loop—18, Letters—20, Fun!—22, Leaky Lines—31, OSCAR Orbits—32, New Products—34, Review—36, Ham Help—154, 159, 161, Social Events—160, Corrections—160, Dealer Directory—193, Propagation—193

STAFF

PUBLISHER/EDITOR
Wayne Green W2NSD/1

EXECUTIVE VICE PRESIDENT
Sherry Smythe

ASSISTANT PUBLISHER/EDITOR
Jeff DeTray WB88TH

ASSOCIATE PUBLISHER/DIRECTOR OF PUBLICATIONS
Edward Ferman WA1UFY

MANAGING EDITOR
John Burnett

ASST. MANAGING EDITOR
Susan Philbrick

NEWS EDITOR
Gene Smarte WB6TOV

EDITORIAL ASSISTANTS
Nancy Noyd
Richard Phenix

CONTRIBUTING EDITORS
Chris Brown KA1D
Paul Grupp KB9NV/1

ADMINISTRATIVE ASSISTANTS
Suzy Clyne
Pat Graham

ASSOCIATES
Robert Baker WB2GFE
Jim Cain K1TN
Bill Gosney KE7C
Sanger Green

Dave Ingram K4TWJ
Larry Kahaner WB2NEL
Joe Kasser G3ZCZ
Dr. Marc Leavey WA3AJR
Dave Mann K2AGZ
Bill Pasternak WA6ITF
John Schultz W4FA
Peter Stark K2OAW

MANUFACTURING MANAGER
Noel Self WB1ARP

PRODUCTION MANAGER/PUBLICATIONS
Nancy Salmon

ASST. PRODUCTION MANAGER/PUBLICATIONS
Michael Murphy

ART DIRECTOR
Diana Shonk

PRODUCTION
William Anderson III
Steve Baldwin
Pati Burr
Linda Drew
Robert Drew
Bruce Hedin
Kenneth Jackson
Ross Kenyon
Maryann Metevier
Dion Owens
Patrice Scribner
Susan Symonds
John White

PHOTOGRAPHY
William Heydolph
Terrie Anderson
Bill Suttentfield

TYPESETTING
Barbara Latti
Sara Bedell
Mary Kinzell
Karen Podzycki
Michele DesRochers
Linda Locke
Luan Keddy

CORPORATE CONTROLLER
Charles Garniss, Jr.

EXECUTIVE ASSISTANT
Leatrice O'Neil

ACCOUNTING MANAGER
Knud Keller KV4GG/1

CIRCULATION MANAGER
Debra Boudrieau

CIRCULATION
Doris Day
603-924-7296
Pauline Johnstone

BULK SALES MANAGER
Ginnie Boudrieau

ADVERTISING
603-924-7138

Jim Gray W1XU, Mgr.
Nancy Ciampa, Asst. Mgr.

to doom any effort to failure. Bureaucrats exist by adhering to rules, and their greatest fear is making a decision or proposing some idea which is controversial and could thus reflect poorly on their record.

In this I found that the problems of dealing with China are quite different from dealing with most other countries for, despite the impressions we have been getting from our media, no one person is in charge in China. There are many factions, all jostling for more power, and the country is thus run by committee. This probably goes a long way towards explaining why they seem to be about a hundred years behind us.

Despite all these problems, I am going to start work on the situation and see what I can do to get some interest in the high-

est official circles. I'm available to fly over there and deal directly, should that be beneficial. Sure, I'd love to have a week or two of DXing from China, but I have too much going on these days for that, so perhaps we can work on longer range plans for getting amateur radio introduced. I know that a number of DXers will be glad to help out, should anything start to break loose. Lloyd Colvin (W6KG) and his wife Iris (W6QL) would be on a plane tomorrow if they thought it would help.

The trip to Asia was, again, fantastic and I'm sorry that more of you did not have the time to go along. Those who did had the time of their lives. I did write about it and invite all of you to make the trip...and it was certainly a bargain, with first class hotels everywhere, wonderful meals, and the excite-

ment of a completely different world.

BOMBSHELL IN TAIWAN

In addition to my talk to the China Youth Association scheduled in the Grand Hotel, I was also called upon to speak briefly to several hundred members of the electronics industry on Taiwan at a business breakfast. I made all the papers with my short talk.

Without putting you through the complete text of the talk, I got their attention by saying flatly that Taiwan's electronics products, while impressive, were not by any means state of the art. I pointed out that Taiwan was in the position of having to import technology from Japan and the US and was depending entirely on being able to pro-

Continued on page 152

Well... I Can Dream, Can't I?

by Bandel Linn K4PP

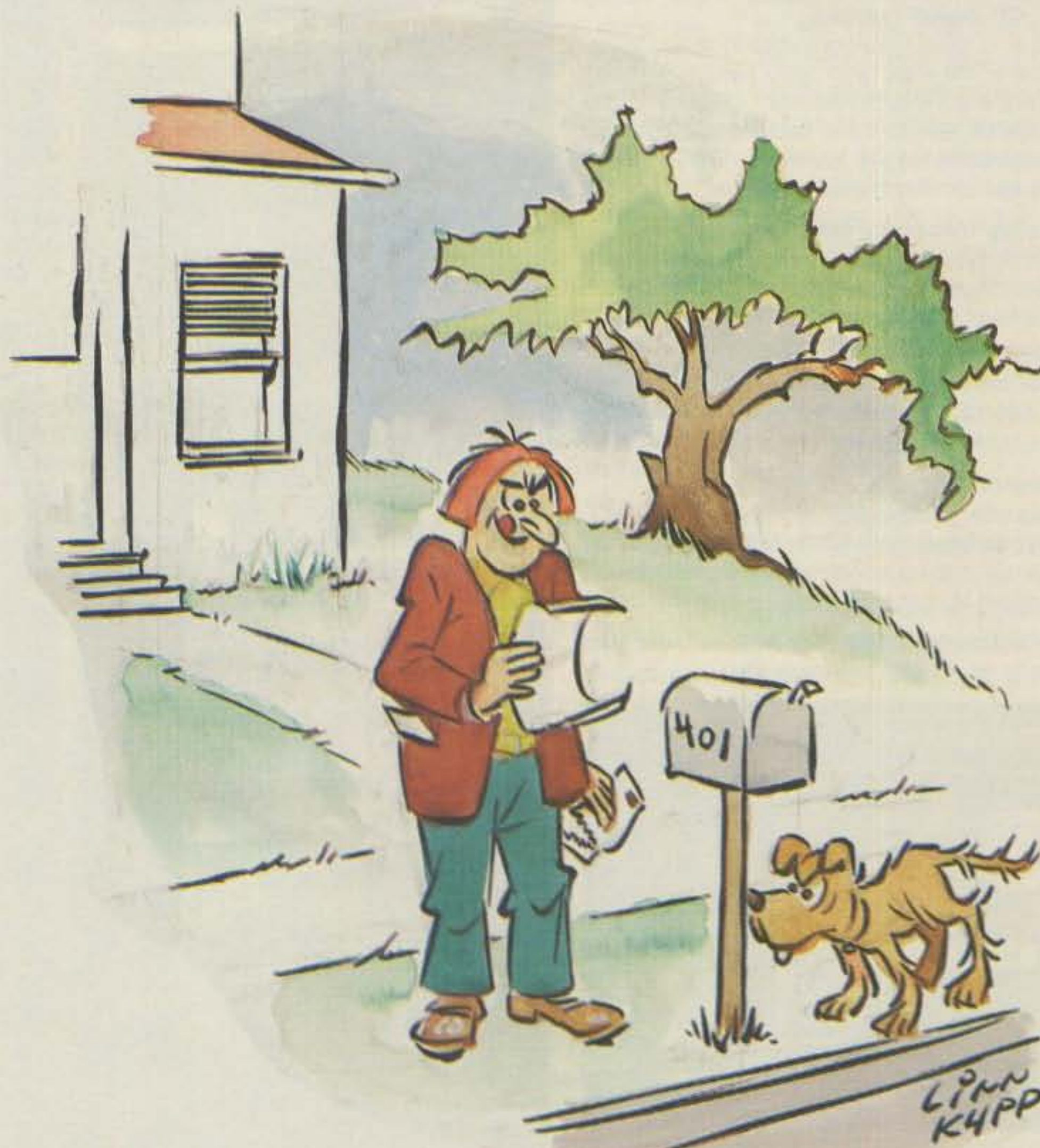

"Congratulations! You have just won the top prize! You and Bo Derek will be flown to the Indian Ocean for an island romance and ham funfest!"

"Simply the best!"

... That's not just a tag line... that is what people are actually saying about ICOM's new family of ham units.

ICOM is the leader in computer digital technology applied to amateur radio... giving better reliability and ease of operation.

Below, you see four of our popular base units: IC-451A, IC-720, IC-551D and IC-251A.

When you buy ICOM, you buy a system that is... Simply the Best!



For the Professional Amateur



The **IC-451A** is the newest ICOM member. Perfect for SCAR, DX and local rag chewing. Covers 430-440 and 440-450 MHz (your choice). SSB/FM/CW.

The **IC-720** astounded the ham community when it came out... with its general coverage receiver, solid state, broad banded, state of the art circuitry. Dual VFO's WARC frequency coverage, very compact.



Optional Power Supply



The **IC-251A** is still the best 2 meter all-mode transceiver on the market.

The **IC-551D** brings 6 meters to life. 80 watts to really punch out. Dual VFO's. SSB/CW (FM optional).



114.8	2000	118.8	2160
110.9	241	123.0	2150
107.2	857	127.3	2200
103.5	1000	131.8	2250
100.0	770	136.5	2300
97.4	1900	141.2	2350
94.8	1800	146.2	2400
91.5	1900	151.4	2450
88.5	857	156.7	2500
85.4	1750	162.2	2550
82.5	1650	167.8	2600
79.7	1600	173.8	2650
77.0	1600	179.8	2700
74.4	1500	186.2	2750
71.9	1000	192.8	2800
67.0	800	200.5	2850

Communications Specialists TE-84

Food for thought.

Our new Universal Tone Encoder lends it's versatility to all tastes. The menu includes all CTCSS, as well as Burst Tones, Touch Tones, and Test Tones. No counter or test equipment required to set frequency-just dial it in. While traveling, use it on your Amateur transceiver to access tone operated systems, or in your service van to check out your customers repeaters; also, as a piece of test equipment to modulate your Service Monitor or signal generator. It can even operate off an internal nine volt battery, and is available for one day delivery, backed by our one year warranty.



- All tones in Group A and Group B are included.
- Output level flat to within 1.5db over entire range selected.
- Separate level adjust pots and output connections for each tone Group.
- Immune to RF
- Powered by 6-30vdc, unregulated at 8 ma.
- Low impedance, low distortion, adjustable sinewave output, 5v peak-to-peak.
- Instant start-up.
- Off position for no tone output.
- Reverse polarity protection built-in.

Group A

67.0 XZ	91.5 ZZ	118.8 2B	156.7 5A
71.9 XA	94.8 ZA	123.0 3Z	162.2 5B
74.4 WA	97.4 ZB	127.3 3A	167.9 6Z
77.0 XB	100.0 1Z	131.8 3B	173.8 6A
79.7 SP	103.5 1A	136.5 4Z	179.9 6B
82.5 YZ	107.2 1B	141.3 4A	186.2 7Z
85.4 YA	110.9 2Z	146.2 4B	192.8 7A
88.5 YB	114.8 2A	151.4 5Z	203.5 M1

- Frequency accuracy, $\pm .1$ Hz maximum - 40°C to + 85°C
- Frequencies to 250 Hz available on special order
- Continuous tone

Group B

TEST-TONES:	TOUCH-TONES:	BURST TONES:
600	697 1209	1600 1850 2150 2400
1000	770 1336	1650 1900 2200 2450
1500	852 1477	1700 1950 2250 2500
2175	941 1633	1750 2000 2300 2550
2805		1800 2100 2350

- Frequency accuracy, ± 1 Hz maximum - 40°C to + 85°C
- Tone length approximately 300 ms. May be lengthened, shortened or eliminated by changing value of resistor

Wired and tested: \$79.95

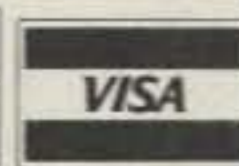

COMMUNICATIONS SPECIALISTS ✓15

426 West Taft Avenue, Orange, California 92667
(800) 854-0547/ California: (714) 998-3021

LOOKING WEST

Bill Pasternak WA6ITF
c/o The Westlink Radio Network
Suite 718
7046 Hollywood Blvd.
Hollywood CA 90028

FIGHT BACK

Have you ever heard of David Horowitz? No, David is not an amateur radio operator. David Horowitz is the host of a weekly syndicated NBC television program called *Fight Back*. David is the author of a new book of the same name, and, in my opinion, it's the best book on consumer awareness I have ever set my eyes on. Basically, it tells you how to avoid getting ripped off and what to do if you are. I won't try to review the book here, but it's more than just another consumer awareness volume. I will tell you the same thing I told David a few weeks ago when I happened to run into him at the NBC studios in Burbank: "That's one heck of a book!" If you ever have been ripped off or if you want to be sure it never happens to you, then read *Fight Back*.

CALIFORNIA VS. THE PAY-TV PIRATES

On October 1st, 1980, California Governor Jerry Brown signed a law into the state statute books which this author feels is one of the most irresponsible pieces of state legislation ever enacted. In fact, by the time you read this, the law may be a thing of the past, this because many people have vowed to fight it on various grounds. The law I speak of is called Section 593e of the California State Penal Code. It makes it a crime for any person "who for profit manufactures, distributes, or sells any device, plan, or part for the knowing purpose of facilitating an unauthorized interception or decoding of subscription television signals." Additionally, it provides for a jail term of up to 90 days and/or a fine of up to \$2500 per count on any conviction. Not a bad law, you say? I quite agree. But not a law for California or any other state to enact.

Here, again, we see the classic example of a state trying to

usurp the jurisdiction of the federal government. Unless the Communications Act has been rewritten without anyone noticing, the role of the FCC in such matters has been clearly defined for years. It is not the prerogative of California or any other state to try to usurp that which is governed by federal jurisdiction. But neither our Governor nor State Assemblyman Mel Levine, who sponsored the bill, seems to have bothered to read the Communications Act or any subsequent FCC interpretation. They never bothered to consult the findings in the Cerritos tower case in which the government stated specifically that it had jurisdiction over radio communication, and, in effect, told California to keep its nose out of the FCC's business. No, our state legislators failed to do their homework. If they had, they would not have permitted themselves to get caught in what may well become a "Catch 22" situation.

No, I am not on the side of the pay-TV pirates. I want this clear from the start. I understand the intricacies of pay-TV, the most important of which being that for subscription television programming to survive, the companies that provide such services must be assured that they will make a profit. If this assurance is destroyed because of widespread piracy of such services, then subscription television will fail, and eventually there will be nothing left to pirate. However, I do not think that the solutions now being addressed are the proper ones. Laws are only as good as the enforcement that goes with them. In the case of the California ordinance, most lawyers with whom I have consulted agree that the federal government, not the state, is the governing body, and that 593e was nothing but a lot of wasted effort.

Further, I have to question the concept of getting federal laws passed to protect subscription television. While the Commission may be good at generating rules and regulations to govern just about every eventuality occurring in the electromagnetic

spectrum, their record on enforcement leaves a bit to be desired. And...what's to keep someone or some group from challenging such laws, the result of which is a court battle that will last years and cost us taxpayers. No, my feeling is that there is only one answer to the problem of pay-TV piracy, and that answer is technology.

The major problem, as I see it, comes from the fact that the majority of subscription television systems are just too easy to pirate. As with anything else, when the systems were developed, the cost factor of the system was one of the prime concerns to those developing it. Therefore, with but one exception, the pay-TV encoding systems of today are so simple to decode that a high-school student with only a bit of knowledge in electronics can overcome them. In fact, if you know how to read and understand a composite TV video waveform, there is no way for you not to figure out how a given subscription television system works. Once you have this knowledge, you are halfway home.

The key to combatting subscription TV piracy then becomes one of developing a pay-TV encoding system so complex as to make piracy uneconomical. In the end, it comes down to simple economics. If it's cheaper to purchase a pirate decoder than to pay the monthly subscription fee, then such decoders will become as fashionable as linear amplifiers for CB. But, should the subscription television services finally get together and, with their collective resources, develop a highly complex encoding/decoding system, one so complex as to make illegal decoders non-cost-effective items, they can ensure the longevity of subscription television in this nation.

Frankly, I suspect that the opposite will happen. I feel that most subscription-TV services are themselves such bureaucracies that they cannot see the forest for the trees. They will probably continue their court battles. They may eventually obtain the federal laws they seek to theoretically curtail the manufacture and distribution of such devices. In the long run, they will be the losers. I need only point to the 10-meter amplifier ban to make my point. The only one who tells us that the amplifier ban is a success is the FCC.

You wouldn't know it by listening to 11 meters and hearing operators extol the virtues of their new "Super Whizbanger 10K" and such. If the subscription-TV people want a quick solution, leave it to the engineers to find it. Keep trying to change the laws, and they will only develop the same black market for decoders that now exists for CB linears.

I doubt if it will ever be possible to curtail the piracy problem completely. There will always be an individual somewhere who will figure out even the most complex of systems and find a way to beat it. Sort of like those who sit for hours trying to break the "top-secret" control codes on remote-base and repeater systems. But, they are a minority and as long as they cannot produce a cost-effective product to mass merchandise, they are no real threat to the survival of pay-TV. A few years ago, I predicted to a friend that this problem would occur. I based my assumption upon my understanding of the current pay-TV systems and human nature. Now, three years later, I find that I am correct.

Here, in California, and elsewhere, the problem with subscription TV piracy is growing, and, as I predicted then, the pay-TV people are grasping for straws in trying to solve it. Yet, the answer is in front of them. It will cut deeply into corporate earnings in the short term, but will give them long-term security. Let's see if these bigwigs of high finance are smart enough to realize this and initiate a technological change. If they're the typical bureaucrats I think them to be, I doubt if they will. In the end, you and I will pay the price, as cases are fought with our tax dollars. Even those of you who do not have subscription television will be the losers if this happens. Maybe we can at least start the ball rolling to forbid the use of our tax dollars for use in such litigation. Frankly, if the pay-TV people want protection, then they should be prepared to foot every penny it costs. If this means that it will cost their subscribers more, then so be it.

By the way, I am one of this nation's pay-TV subscribers and want to see subscription TV survive. I enjoy our HBO service and feel that it's worth the monthly service fee. If I wanted to pirate

Continued on page 149

SUPER RIG



NEW TEN-TEC

OMNI-C 9 Band Transceiver + HERCULES Solid-State KW Linear

TEN-TEC SUPER RIG IS READY. For every band, every band condition. With the latest in solid-state hf technology, the latest in features. To make communications easier, more reliable — super.

OMNI-C

The new model in this famous series. With new coverage and new features to make it better than ever!

All 9 HF Bands. From 160 through 10 meters, including the new 10, 18 and 24.5 MHz bands. Coverage you can live with—for years and years.

3-Mode, 2-Range Offset Tuning. Offset the receiver section or the transmitter section or the entire transceiver! In 2 ranges: ± 500 Hz or ± 4 kHz. For complete flexibility in fine tuning, a DX work, or net operations.

Seven Response Curves. Four for SSB, three for CW. With new switching to select the standard 2.4 kHz filter, optional 1.8 kHz SSB filter, 500 Hz or 250 Hz CW filters, and standard 450 and 150 Hz CW active audio filters. Up to 16 poles of i-f filtering plus audio filtering to handle any situation.

Built-In Notch Filter and Noise Blanker. Notch is variable from 200 Hz to 3.5 kHz with a depth of more than 50 dB. New noise blanker reduces ignition and line noise. Both standard equipment.

“Hang” AGC. New, smoother operation.

Super Specs. Optimized sensitivity—a balance between dynamic range and sensitivity ($2 \mu\text{V}$ on 160 to $0.3 \mu\text{V}$ on 10 meters) Greater dynamic range: better than 90 dB. And a PIN diode switchable 18 dB attenuator. 200 watts input on all bands! 100% duty cycle on all bands for up to 20 minutes.

Super Convenient. Built-In VOX with 3 up-front controls. Built-In PTT control at front and rear jacks. Built-In Zero-Beat switch puts you on exact frequency. Built-In Adjustable Sidetone with variable pitch and level. Adjustable ALC for full control from low power to full output. 2-Speed Break-In, fast or slow speeds to fit operating conditions. Built-In Speaker eliminates desk clutter. Automatic Sideband Selection—reversible.

Super Design. All Solid-State and Broadbanded—from the pioneer, Ten-Tec. Modular plug-in circuit boards. Functional Styling with convenient controls, full shielding, easy-to-use size ($5\frac{3}{4}$ "h x $14\frac{1}{4}$ "w x 14"d).

Super Hercules Companion. Styled to match, plus separate receiving antenna capability, plus transceiver front panel control of linear's bandswitching (one knob does it all).

Full Accessory Line including filters, remote VFO, power supplies, keyers, microphones, speech processors, antenna tuners—all in matching color.

Model 546 OMNI-Series C . . . \$1289

HERCULES

Amateur Radio's first full break-in solid-state kW linear amplifier. With the reliability you'd expect from the pioneer in high-power solid-state technology—TEN-TEC.

All Solid-State. No tubes. Instead, HERCULES uses two 500-watt push-pull solid-state amplifier modules with an output combiner. Super solid.

Broadband Design. No knobs, no tuning. From the pioneer, TEN-TEC. For fast, effortless changing of bands. Super easy.

Automatic Bandswitching when used with OMNI (the OMNI bandswitch also controls HERCULES bandswitching through a motor driven stepping switch). Super convenient.

Full Break-In. HERCULES puts the conversation back into high power CW operation—you can hear between every character you send.

Full Coverage. 160 through 15 meters plus four “AUX” positions for 10-meter conversion by owner and future band additions.

Full Gallon. 1000 watts input on all bands, 600 watts output, typical. Built-in forced-air cooling. Driving power: 50 watts, typical. Adjustable negative ALC voltage. 100% duty cycle for SSB voice modulation; 50% duty cycle for CW/RTTY (keydown time: 5 minutes max.) Continuous carrier operation at reduced output.

Full Protection. Six LED status indicators continuously monitor operating conditions and shut down the amplifier whenever any one exceeds set limits (the exciter automatically bypasses the amplifier under amplifier shut-down for barefoot operation). The six parameters monitored are: 1) overdrive; 2) improper control switch setting; 3) heat sink temp.; 4) SWR; 5) overvoltage/overcurrent; 6) rf output balance. Two meters monitor collector current, voltage, and forward/reverse power. And a highly efficient automatic line voltage correction circuit (patent applied for) eliminates the need for selecting transformer taps, prevents applying too high a voltage to final amplifier devices, becomes operative under low line conditions.

Super Power Supply. Provides approximately 45 VDC @ 24 amperes, operates on 105/125 VAC or 210/250 VAC. Tape wound transformer and choke reduce weight (50 lbs.) and size ($7\frac{1}{2}$ "h x $15\frac{3}{4}$ "w x $13\frac{1}{2}$ "d). Separate enclosure.

Super Styling. Designed to match OMNI, the HERCULES has the same height as OMNI, plus matching bail and matching colors. The front panel is simplicity in itself with two push-button switches (power and mode) plus two knobs (meter and bandswitch), and a “black-out” monitor panel (when unit is off, meters are unobtrusive). Amplifier size is $5\frac{3}{4}$ "h x 16"w x $15\frac{1}{2}$ "d.

Model 444, HERCULES amplifier & power supply . . . \$1575.

Experience SUPER RIG at your TEN-TEC dealer, or write for full details.

TEN-TEC, INC.
SEVIERVILLE, TENNESSEE 37862
EXPORT: 5715 LINCOLN AVE., CHICAGO, ILL. 60646

CONTESTS



Robert Baker WB2GFE
15 Windsor Dr.
Atco NJ 08004

HUNTING LIONS IN THE AIR CONTEST

Starts: 1200 GMT January 10
Ends: 1200 GMT January 11

The contest is sponsored by Lions Clubs International and coordinated by Lions Club Rio de Janeiro Arpoador, Brazil. Participation in the contest is open to all duly licensed radio operators, Lion and non-Lion. There are two modes—phone and CW. Participation in both modes is allowed, but points are counted separately. All amateur stations participating must operate within their licensing regulation. Separate categories will exist for single operator and radio clubs/societies. Multi-operators may participate, but each prefix must be listed on the log.

Use all bands, 80 through 10 meters. Only one QSO with the

same station on each band may be counted. Remember that phone and CW are counted separately!

EXCHANGE:

RS(T) and sequential QSO number. When contacts are made with Lions and Leos, the name of the Lions Club or Leo Club contacted should be clearly identified.

SCORING:

QSOs within the same continent count 1 point, while those between different continents count 3 points. Score 1 extra bonus point for each QSO with a member of a Lions Club or Leo Club and 5 points for a QSO with a member of the Lions Club Rio de Janeiro Arpoador. Contacts between Brazilian stations and members of the Arpoador club will count only 2 extra points.

AWARDS:

Lions Club International will present awards for single operators for first, second, and third place on both modes. The first-place winner in each mode will receive a trophy, the second-place winner will receive a medallion, and the third-place winner will receive a plaque. A trophy will be awarded to the

first-place radio club on each mode. Certificates will be awarded fourth- through tenth-place winners in each mode for single operators. In addition, each log sent by participants, radio clubs, or radio societies will receive a special certificate. The contest committee will also select and award the most active Lions Club participating in the contest.

ENTRIES:

Keep a separate log for each mode. Each participant will note in the logs the callsign and information exchanged. Confirmation of contacts will be made by comparing the logs of the partic-

ipants. Participants should send their logs not later than 30 days after the contest to: Contest Committee—Hunting Lions in the Air, Lions Club of Rio de Janeiro Arpoador, Rua Souza Lima #310, Apt. 802, 22081 Rio de Janeiro RJ Brazil.

2nd ANNUAL INTERNATIONAL 160-METER PHONE CONTEST
Sponsored by 73 Magazine
Starts: 0000 GMT January 17
Ends: 2400 GMT January 18

This is the second annual 160-meter contest sponsored by our magazine. The object is to work as many stations as possi-

Continued on page 155

AMATEUR RADIO NEWS SERVICE (ARNS) 1980 PUBLICATION CONTEST INFORMATION

Mail one copy each of any of three issuances during the period from July, 1979, through July, 1980, to:

Arny Gamson K6PXA, Chairman
ARNS Publication Contest
8034 Gentry Ave.
North Hollywood CA 91605

Papers will be reviewed by a team of three judges. Points will be awarded by each judge independently based upon the criteria discussed below. Final average totals will be adjusted up or down based upon a group reevaluation of all papers. All papers will receive an award and, based upon adjusted point value, will be judged OUTSTANDING, EXCELLENT or HONORABLE MENTION. All papers will also receive a summary critique on their favorable qualities and the judges' constructive suggestions for improvement.

Criteria for judging will include achieving the apparent goals of:

- Purpose of publication
 - Interest to readers
 - Imagination and attractiveness of layout
 - Mast, titles, and layout
 - Humor and cartoons
 - Members' involvement and contribution
 - Ease of readability of product
- The following "housekeeping" items will be considered:
- Date and frequency of issue
 - Name and address of editor and officers of sponsoring organization
 - Utilization of ARNS emblem and ARNS contributions from the *Bulletin* (if member)
 - Minimal effect will result from method of reproduction unless it affects the readability
 - Technical articles and recruiting/training/subscriber solicitation material will be evaluated on an appropriate basis

Decision of the judges will be final. Scores/critiques of individual papers will be issued to individual entrants. Categories earned will be publicized.

There is no entry fee or membership in ARNS required. The contest is international and open to all amateur radio clubs, societies, organizations, groups, etc., issuing periodicals. Include separate recruiting, training, etc., material issued in connection with your paper.

Deadline for submissions two weeks after receipt of this publication.

INFORMATION TO BE INCLUDED WITH PUBLICATION CONTEST APPLICATION

1. Name of publication
2. Frequency of issue
3. First issue date
4. Circulation (No. sent to members/Complimentaries)
5. Club dues or subscription rate
6. Sponsoring group (if any)
7. Club mailing address
8. Editor's name, call, phone number
9. Editor's address
10. Editor's city, state, ZIP
11. Editor: How long this paper? Other papers (list and how long associated)?
12. Method of printing (offset, copier, stencil, spirit)
13. Approximate cost of printing each issue
14. Postage
15. Principal objectives of your paper
16. Items judged which you feel are *not* applicable to your paper
17. Remarks
18. Amateur Radio News Service member?

CALENDAR

Jan 3-5	Zero District QSO Party
Jan 10-11	Hunting Lions in the Air
Jan 17-18	73's International 160-Meter Phone Contest
Jan 17-18	Michigan ARP Club CW Contest
Jan 17-18	ARRL VHF Sweepstakes
Jan 17-19	QRP SSB QSO Party
Jan 18	FRACAP Worldwide Contest
Jan 24-25	Texas QSO Party
Jan 31-Feb 8	ARRL Novice Roundup
Feb 2-3	CWSP International DX Competition
Feb 14-15	QCWA QSO Party—CW
Feb 21-22	ARRL DX Contest—CW
Mar 7-8	1981 SSTV Contest
Mar 7-8	ARRL DX Contest—Phone
Mar 14-15	QCWA QSO Party—Phone
Mar 21-22	Bermuda Contest
Mar 21-22	CARF Phone Commonwealth Contest
Aug 8-9	European DX Contest—CW
Sep 12-13	European DX Contest—Phone
Nov 14-15	European DX Contest—RTTY

WE BACK EVERYTHING
WE SELL WITH OUR
PERSONAL GUARANTEE
PRICES F.O.B.
HOUSTON
PRICES SUBJECT TO
CHANGE WITHOUT
NOTICE
ITEMS SUBJECT TO
PRIOR SALE

MADISON Electronics Supply



ORDER YOUR
KWM 380 NOW!
OLD PRICE & FREE GOODS

KENWOOD PACKAGE



You simply can't buy better reliability, performance and reputation than the 520 series from Kenwood, and the TS520 SE is no exception. This is a just plain good radio at a tremendous savings, when you consider the free CW filter (YK-88) and microphone (MC-50) too.

TS 520 SE 629.95
MC-50 MIC our gift
CW - 520 FILTER
TOTAL 629.95

HARD TO FIND SURPLUS



IC2AT
249.95
CALL FOR QUOTE

BATTERY ELIMINATOR FOR MOBILES REQUIRES MINOR

DRAKE TR7

RADIO MOD \$19.95

synthesized hf
transceiving system

continuous coverage

0-30 MHz

continuous coverage reception no gaps —
no range crystals required

160-10 Meters

Amateur Band transmission, including
capability for MARS, Embassy,

Government, and future band expansions



PASS BAND TUNING
R. I. T.

INDEPENDENT RECEIVE
SELECTIVITY WILL
HANDLE WARC BAND
EXPANSIONS

CALL FOR QUOTE

ETO/ALPHA SOME
LEFT AT OLD PRICES

MEMORY KEYER BREAK- THROUGH!

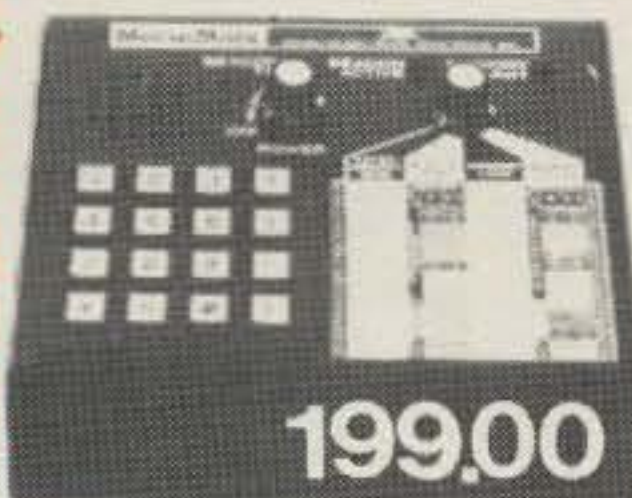

199.00

The remarkable AEA Morsematic memory keyer has 35 fantastic features including two AEA designed microcomputers, up to 2,000 character memory, automatic serial number, beacon mode and automatic morse trainer mode.

NEW! CONTEST
KEYER CK1 - 129.95

AEA
Brings you the
Breakthrough!

BELDEN

RG8/u Dbl. Shield	Part Number	MHz	dbi/ 100 ft.	dbi/ 100 m	
	9888	50	1.2	3.9	<p>8448 24¢/ft.</p>
		100	1.8	5.9	
		200	2.6	8.5	
		300	3.3	10.8	
		400	3.8	12.5	
RG8/u Foam .81VF	8214	50	1.2	3.9	<p>9405 38¢/ft.</p>
		100	1.8	5.9	
		200	2.6	8.5	
		300	3.3	10.8	
		400	3.8	12.5	
RG8/u Regular 66VF	8237	100	2.0	6.5	<p>No. of Cond — 8 AWG (in mm) — 6-22 (7 x 30), 2-18 (16 x 30), (1, 19)</p>
		200	3.0	9.8	
		400	4.7	15.4	
		900	7.8	25.6	
RG8/u Non-contaminating	8267	100	2.0	6.6	
		200	3.0	9.8	
		400	4.7	15.4	
		900	7.8	25.6	

MINI RG-8 19¢ FOOT

LARGE BOOKSTORE - WHAT DO YOU NEED?

ALL BAND COVERAGE!
160 THROUGH 10, INCLUDING WARC
9 BANDS FULLY OPERATING

ASTRO 103

Professional Grade
HF/SSB Transceiver



- 100 WATTS ALL BANDS ALL MODES
- AGC DYNAMIC RANGE GREATER THAN 100 dB
- SELECTIVITY 16 POLE CRYSTAL FILTER 2.7 kHz at - 6dB; 3.78 kHz at - 100 dB

\$1395.00 SUGGESTED LIST
CALL FOR QUOTE

ET CETERA

Cubic-Swan 102BXA	\$999.00
Astro 150 A	779.00
Astro 100MXA	499.00
Mirage B23 1 watt-30 Watt amp	89.95
DSI 5600A w/Ant/Ac	185.00
Cushcraft A3 Tribander	169.00
Bird 43, Slugs	Stock
CDE Ham-4 Rotor	169.00
Ham-X	239.00
FDK Palm 2 Handie with BP/AC	149.00
Cetron, GE 572 B	34.00
GE 6146B	9.95
Fits Kenwood Yaesu	
Kenwood Service Manuals	
Stock	10.00 ea.
Telrex TB5EM	425.00
Belden #14 8000 Stranded	
Antenna Wire	10¢ ft.
Telrex Monobanders	Stock
Adel Nibbling Tool	8.95
Janel QSA5	41.95
Rohn Tower	20% off dealer
25G, 45G Sections	
Alliance HD73 Rotor	109.95
Amphenol Silverplate PL259	1.00
ICOM 255A 2M Synthesized	319.00
ICOM 260A 2M SSB/FM/CW	429.00
Kenwood TS180S/DFC/SSB	Call
ICOM IC2AT/TTP/NICAD	229.00
New-Icom IC720 w/AC/mike	Call
Bearcat 220 - \$299.00	300-399.00
Manual Typewriters	\$35
Guaranteed to Work	
Mallory 205A/1000 PIV	
Epoxy Diode	19¢ ea.
Antique Tubes	Call
2 Guaranteed Service Techs on	
COLLINS KWM-2/KWM-380/S-LINE	CALL!

713-658-0268

CALL FOR QUOTES

1508 MCKINNEY
HOUSTON, TEXAS 77010

AWARDS

Bill Gosney KE7C
c/o Micro-80 Inc.
S-2665 No. Busby Road
Oak Harbor WA 98277

COMPU-WARD

As publicized in over 25 individual amateur radio publications throughout the world, the COMPU-WARDS, sponsored by Micro-80 Incorporated, are available to licensed amateurs and shortwave listeners worldwide. Emphasis of these award programs is focused on the advancement of both the amateur radio and computer hobbies through demonstrated excellence in the art of computerized communications.

Stations applying for these awards may or may not have a computerized station of his/her own; however, *all stations contacted must be computerized*, meaning the contacted station must have his/her transmitter interfaced with a computer, such as the well-known TRS-80, Apple II, Commodore PET, Heathkit, Atari, etc.

To be valid, all contacts must be made on or after January 1, 1980. There are two (2) awards being offered: (1) HF bands—29.7 MHz and below; (2) VHF/UHF—50.0 MHz and above.

All contacts must be made on one or any combination of the following modes (including any modes authorized by the FCC since the release of this announcement)—RTTY, SSTV, CW, and ASCII. Crossmode

communications will not be recognized for these awards.

Single-band and mixed-band endorsements will be given with each band segment (HF, VHF, UHF, etc.). Crossband operation will only be accepted for OSCAR contacts. All OSCAR contacts will be considered only for VHF/UHF accomplishments even though some of the OSCAR satellites have receive frequencies on 10 meters. Contacts via repeaters are acceptable.

To qualify for either COMPU-WARD:

Applicants *with* a computerized station of his/her own must contact a *minimum of 15* other computerized stations on the bands and modes authorized.

Applicants *without* a computerized station of his/her own must contact a *minimum of 25* computerized stations on the bands and modes authorized.

To apply, prepare a list of contacts for each award. In prefix order, list each call worked, mode utilized, frequency or band of operation, and date and time of each contact made. *Do not send QSL cards!* Have your list of contacts and supporting QSL cards verified by two fellow amateurs or a local radio club official. The services of a notary may be sought if applicants prefer.

Forward the verified list with \$4.00 for each award. Send your application to the Oak Harbor address of Micro-80 listed

above. Foreign stations may substitute the awards fee by enclosing 10 IRCs for each award sought.

Last month we reviewed the very challenging Gozo Island Award and completely overlooked the very beautiful DIP-MED Award Diploma. My apologies to MARL for this obvious error.

DIP-MED AWARD

Awarded to any licensed amateur, the DIP-MED Award has no band or mode restrictions; however, single band or mode accomplishments will be recognized if requested at the time application is made.

To qualify, HF applicants must work a minimum of 15 Mediterranean countries including 9H Island of Malta. On VHF, only 5 Mediterranean countries including 9H Malta need to be confirmed.

To apply, prepare a list of claimed contacts indicating callsign, date and time in GMT, the band and mode of operation, and the country contacted. Have this list verified by at least two fellow amateurs or a local radio club official. Forward the application and \$3.00 or 12 IRCs to: MARL, PO Box 575, Valletta, Island of Malta.

Mediterranean countries include: Malta, Spain, Balearic Islands, Ceuta and Melilla, France, Corsica, Morocco, Algeria, Tunisia, Monaco, Italy, Sicily, Sardinia, Greece, Cyprus, Crete, Dodecanese Isles, Gibraltar, Yugoslavia, Albania, Israel, Lebanon, Egypt, Turkey, Syria, and Libya.

GUAM ISLAND AWARD

I am proud to announce the very latest award being offered by the Mariana Amateur Radio Club of Guam Island, known as the Guam Island Award. The requirements of the award are very straightforward. Applicants must work and confirm at least five (5) individual amateurs located on Guam Island.

There are no band or mode restrictions; applicants must have their list of contacts verified by at least two amateurs or a radio club secretary. Be sure to give the usual log book information plus the name of the operator for the contact to count.

Enclose your application and

an award fee of \$1.00 or 5 IRCs to: Mariana ARC of Guam, PO Box 445, Agana, Guam 96910.

ANNUAL 73 MAGAZINE AWARD ENDORSEMENTS

The end of 1980 brings to a close another eventful year of enjoyable operating. Award seekers can now tabulate their totals and make application for their annual endorsements for the 73 DX Country Club Award and the Worked All USA Award. To learn more about both of these very challenging awards and the seventeen other programs which accompany them, turn in your back issues of 73 to my Awards column for the months of September and October. The entire details of the 73 Magazine Awards portfolio are featured there.

WABP AWARD OF BELGIUM

The UBA Awards Manager, ON5TO, has announced the very popular WABP Award Program. This award is available to licensed amateurs and SWL stations. There is no limit as to date; there are no band or mode restrictions.

To qualify for the WABP Award, the applicant must work and confirm contact with each of the nine Belgium provinces on a minimum of two amateur bands.

Once the requirements have been met, have your list of contacts verified by a radio club official. Do not send QSL cards!

Enclose your verified application and five (5) IRCs to: ON5TO, UBA Awards Program, PO Box 634, Brussels, Belgium.

Belgium provinces include: WV—West Flanders; OV—East Flanders; AN—Antwerp; LM—Limburg; LG—Liege; LX—Luxembourg; NR—Namur; HT—Hainaut; BT—Brabant.

While in Belgium, we have learned of another award incentive which should capture the interest of most DX stations, the Onion Award.

THE ONION AWARD OF BELGIUM

Licensed amateurs or SWL stations will find this award a considerable challenge. Only contacts made with the Aalst section of Belgium will count and these contacts must be established after January 1, 1975, to be valid.

Continued on page 158

MICRO-80™ INC.
PRESENTS
COMPU-WARD

73 MAGAZINE
Has Submitted Evidence of Having Worked

- 25 -
Computerized Stations in the World

Via His/Her Own CONVENTIONAL Amateur Radio
Station. By Doing So, This Awardee Has
Demonstrated Excellence in Computerized
Communications, Representing an Elite Group
of Amateurs Who Have Contributed Toward the
Advancement of Their Hobby.

# 000000 October 30, 1980 AWARD NUMBER & DATE	ROY F. SMAT CHAIRMAN OF THE BOARD, MICRO-80 INC.
2 BANDS 2 x CW BAND & MODE OF OPERATION	SIDEL E. GOSNEY, KE7C PRESIDENT, MICRO-80 INC.

ICOM IC2AT OWNERS SCANNER

Also available—scanners for

KENWOOD TR7400A, TR7600 & TR7625, TEMPO (S-1, S-1A, S-2, S5),
KDK 2015R, KDK 2016A, ICOM IC225, MIDLAND 13-510, 13-513,
CLEGG FM-28, YAESU FT227R

• AED continues to expand its line of quality scanners.

• All of AED's scanners are custom designed to install completely inside of their respective rigs.

• Installation is simple. Unlike other competitive products all AED scanners are designed so that it is totally unnecessary to cut any wires inside your rig during installation.

• All P.C.B.s are silk-screened and tin plated for easier and more effective soldering.

• The kit comes complete with all parts and a detailed instruction manual including schematics.

• In the scanner OFF mode the rig operates normally. In the scanner ON mode the scanner locks on an occupied frequency, pauses for a preset time (about 5 sec.) and then resumes scanning (except 225).

• The frequency being scanned is displayed on the digital readout (except 225 IC2AT and Tempo).

• This gives you the ability to eavesdrop all over the band without lifting a finger. When you hear something interesting, you flip the switch to the LOCK mode and the rig is ready to transmit.

FM ADAPTER

CONVERTS EXISTING HF
TRANSCIVERS TO
TRANSMIT 10-M FM!

Also available on SPECIAL

Kit \$34.95

Preassembled \$49.95

SUPER SPECIAL

KIT PRICE: REG. \$39.95

SPECIAL NOW \$34.95

(TEMPO & IC2AT PREASSEMBLED ONLY)

PREASSEMBLED: REG. \$59.95

SPECIAL NOW \$49.95

AED ELECTRONICS

750 LUCERNE RD., SUITE 120 DEPT. A
MONTREAL, QUEBEC, CANADA H3R 2H6
TEL. 514-737-7293

INCLUDE \$1.50 FOR
POSTAGE AND HANDLING PER ITEM



Preampifiers

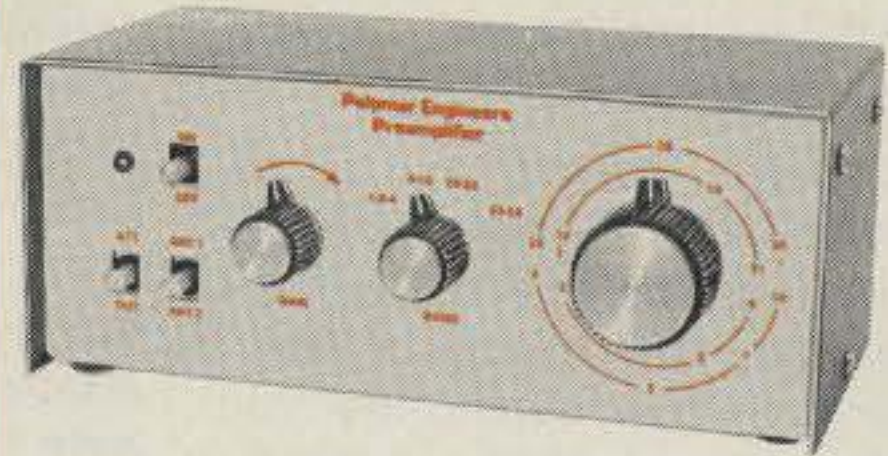
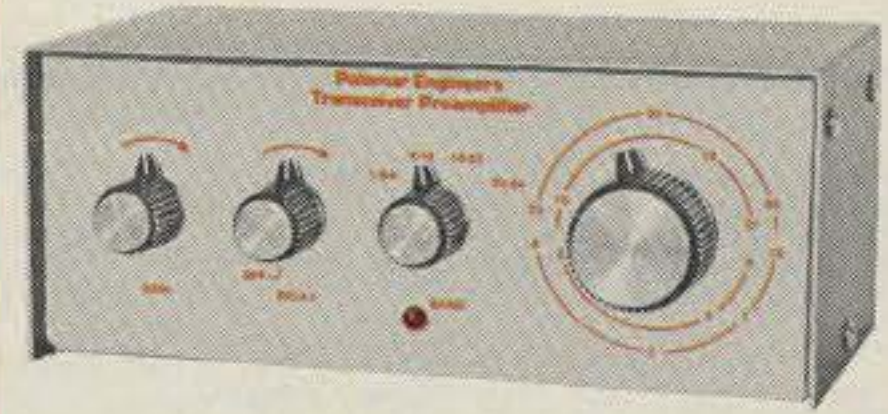

The famous Palomar Engineers preamplifier has been updated and packaged in an attractive new cabinet.

For the SWL there is the P-305 (9-v DC powered) and the P-308 (115-v AC powered) featuring full shortwave coverage, selection of two antennas, 20 db attenuator, 15 db gain control and on-off-bypass switch.

For transceivers, the P-310X features automatic bypass on transmit, adjustable delay for return to receive, and 350 watt transmit capability.

All models have these features:

- Up to 20 db gain.
- Covers 1.8 to 54 MHz in four bands.
- Low noise figure.
- Reduces image and spurious response.
- 8" x 5" x 3". Brushed aluminum control panel. Black vinyl cover.
- SO-239 connectors.
- LED pilot.

Order direct or from your favorite dealer. Model P-305 Receiver Preamplifier for 9-v DC \$77.95. Model P-308 for 115-v AC \$87.95. Transceiver Preamplifier Model P-310X \$107.95. Add \$3 shipping/handling. Calif. residents add sales tax.

Don't wait any longer to pull out weak, rare DX.

Palomar Engineers

Box 455, Escondido, CA. 92025
Phone: [714] 747-3343

TRS-80/RTTY

The Crowning Touch

ROM-116

Amateur RTTY Operating System

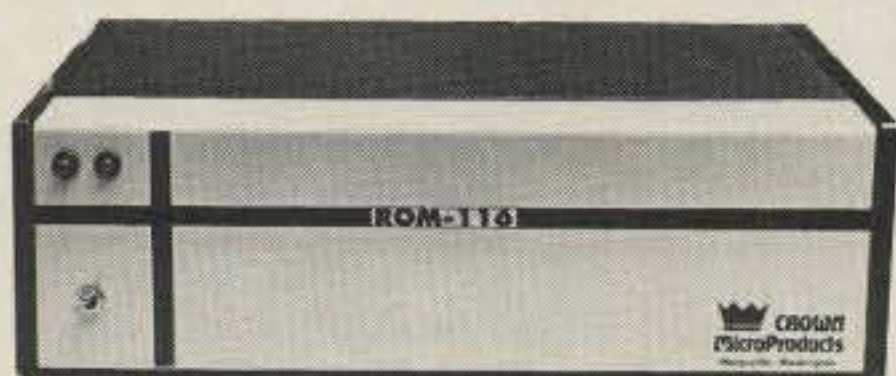

Supports any 8-level serial printer or modem * Baud rate keyboard selectable * Expansion interface not required for operation of serial printer or modem.

• BUFFERS: 7.5K Main text buffer * Pre-typed messages up to 7.5K possible. * 2.5K general purpose buffer *

• AUTOMATIC CW/ID: At the start/end of each transmission * Every 10 minutes * Provision for quick break (no ID).

• TRANSMITTER CONTROL: Transmitter turns on/off automatically via software control * Provisions made for quick break.

• SOFTWARE PROVIDED: 2 RTTY Programs (Cassette/Disk version) * ASCII/BAUDOT Driver routines (permits use of "LLIST" and "LPRINT" commands from basic) * CW send/receive program.

• HARDWARE REQUIREMENTS: TRS-80 with 16K RAM * External terminal unit recommended (Fletcher TU-170, ST-6 etc) * AFSK/FSK unit.

* MODES: RTTY (ASCII or BAUDOT) * CW *

• REAL-TIME CLOCK: 24 hour clock * Automatic updating * Time display includes day, month and year.

• SPLIT-SCREEN VIDEO: 12 lines receive text * 3 lines transmit text or pre-typing a message * 1 line display, real-time clock * Status displayed continuously * Word-wrapping.

• TWO SERIAL PORTS PROVIDED: Port "A" -Interfaces to internal or external terminal unit * RS-232, TTL and 60 ma. * ASCII/BAUDOT *

 **CROWN
MicroProducts**

PRICE **\$300**
with cabinet

P. O. Box 892
Marysville, Washington 98270
206-659-4279

*A Trademark of The Tandy Corp.

RTTY LOOP

Marc I. Leavey, M.D. WA3AJR
4006 Winlee Road
Randallstown MD 21133

Let's start off the New Year with a look back at some things we have mentioned in the past few months.

Several months ago, I reviewed the Jameco JE-610 ASCII keyboard. One of the troubles I noted was that, in spite of advertisements proclaiming the "full 128-character ASCII character set," the keyboard is unable to generate one code, \$1F, as supplied, and another, underline (\$5F), is omitted from the keyboard, although it can be generated with some manipulation. I related that Jameco acknowledged the problem, although no apparent fix has been offered. Well, take a look at the latest ads for the keyboard. No longer is the "full 128-character set" claimed; now the keyboard's "60 keys generate the 126 characters, upper- and lowercase ASCII set." Don't change the hardware, just the software, or something like that! Oh, well.

Also back a few months, we reviewed the iRL FSK-1000 RTTY demodulator. In it, I issued a challenge, albeit half-heartedly, to tell which button on the panel was pushed. Well, in response to the many questions, only the

"170-Hz Shift" button is depressed. All others are in the "out" position. Study the picture if you don't believe me.

Now, quite some time back, extending over the many subsequent months, we have been following the progress of a firm known as Teleprinter Art, Ltd. To my knowledge, no repeat inquiries to the firm have been answered and, as of this writing date, I am forwarding a good deal of the correspondence and details received to the Postal Inspectors. I will try to keep anyone forwarding information to me informed of the progress of any investigation.

About a year ago, we passed along the saga of George Firmin WA4FSK, who wondered what weather transmissions such as 66228 05210 05315 05323 04928 66028 06525 06234 05838 mean. Now along comes a note from Robert Munro in Newport, R.I., who used a book entitled *Worldwide Marine Weather Broadcasts* to decode the above. His translation reads: 66228 = Warm front at surface, weak, and frontal characteristics decreasing. 052 N. latitude, 10 W. longitude, 053 N. longitude, 15 W. latitude, etc. 66028 = Quasi-stationary front at surface, weak, little or no change.

Frontal characteristics diffused. 065 N. latitude, 25 W. longitude, etc.

Thanks to Robert for the help. He wonders if anyone has a computer program to decode this type of information. I would suggest that the data is encrypted in a rather straightforward manner and that anyone reasonably fluent in BASIC should be able to put the book's tables into a program. Ask around your area.

While we're talking about computers (slid into that one, didn't I?), George Gadbois W3FEY passes along his contribution in the form of a UART interface for the RCA VIP computer. This allows George to use his VIP, which is an 1802-based computer, on Baudot and ASCII. His straightforward design is shown in Fig. 1.

George also noted that the Red Rose Repeater Association in Lancaster, Penn., is in the center of a few two-meter RTTY repeaters. The Harrisburg machine is on 147.975/.375 and a "computer link" to Eagleville may be found on 146.235/.835. Keep up the good work, fellas!

Buzz Gorsky K8BG, of Carlisle, Penn., writes in regarding his Model 15. It seems as though a non-overline, automatic CR/LF gizmo has been added, and Buzz wants to turn it off! Of course, with such a device, intentional overlines, such as in many pictures, are impossible. Well, Buzz, there are at least three non-overline schemes I have

seen used in a Model 15, and how you defeat it depends on which one or another you have. The best I can offer, sight unseen, is to look for a lever or hook that the typing basket trips as it passes the sixty-fifth space or so, roughly where the bell would ring. This usually is the actuator and has a lever which can be swung out of the way. Perhaps some of the RTTY nuts in the Red Rose Repeater Association can help you. Write them at PO Box 5029, Lancaster PA 17601.

73 does get around. A letter from John L. Webster 9Y4JW/8P6KX in Trinidad, asks about the software to put the 6800 computer on RTTY. Well, John, over the past few years several separate receiving and transmitting routines have been published in this column. Copies of these are still available at \$1.00 each to cover reproduction and postage. However, these two have formed the nucleus for a bigger and far better program, a full transceive program for RTTY with a 6800. Featuring pre-loadable buffers, variable speeds, and a true FIFO, the program fits in less than 4K of memory. Want more? How about one key RYRY, QUICK BROWN FOX, and ID, and throw in a CW ID to boot. And how much will this wonderful program cost? Why, not a cent more than you already spend, for it shall be published soon right here in 73! So don't let your subscription lapse; watch for this fantastic program.

Kevin McKewen WA3LPK, a new RTTYer here in the Baltimore area, has acquired a HAL ST-5 and AK-1 setup, sans literature. He wonders if data is still available. Sure is, Kevin. HAL maintains a full spectrum of literature on all their products, and I am sure that they would be glad to help out anyone who drops them a line at HAL Communications Corp., PO Box 365, Urbana, Illinois 61801. And don't forget to mention RTTY Loop, OK?

Anyone around Rockland, Massachusetts, want to give a newcomer a hand? George Beaupre KA1CGP is putting a Model 32 on the air and is looking for suitable demodulators. This brother of the ASCII Model

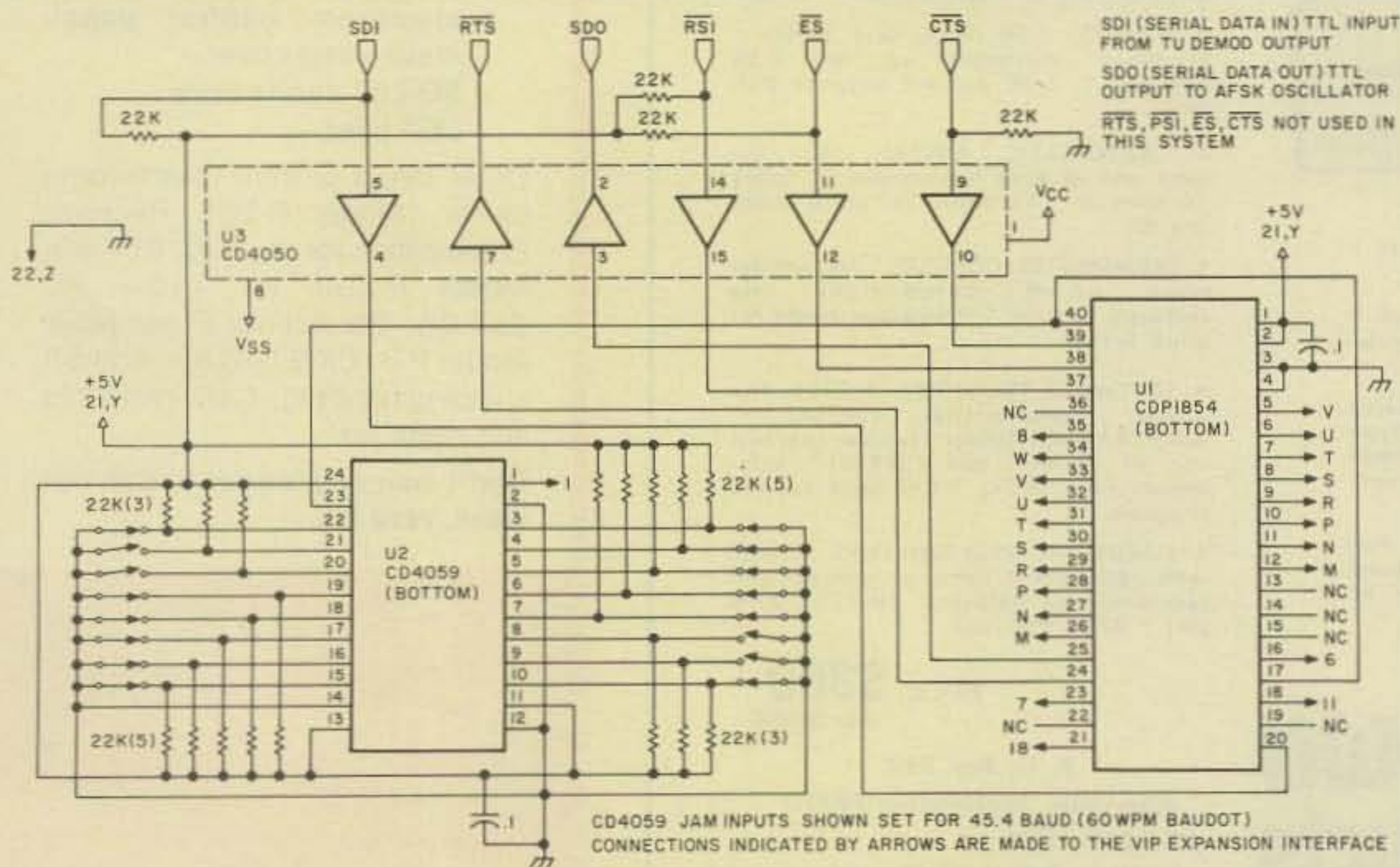

Fig. 1.

Continued on page 31



A touch of Class

There are those who will only be satisfied with the finest.

For these perfectionists HAL Communications is pleased to offer the DS 3100 Automatic Send-Receive ASCII, Baudot and Morse Terminal.

We cordially invite you to request our catalog.



✓ 345

HAL COMMUNICATIONS CORP.
Box 365, Urbana, IL 61801, (217) 367-7373

For our European customers, contact: Richter & Co. D 3000 Hannover 1 • Transradio SA, 6816 Bissone/Lugano • Radio Shack, Ltd., London NW6 3AY • Erik Torpdahl Telecom, DK 3660, Stenlose, Denmark

LETTERS

H 5 H, COMRADE

This letter has been started at least a half-dozen times during the past several months, only to be pushed aside by the press of some other matter and to then be restarted when triggered by something I read or heard.

This time, the "kick" was a comment of yours in 73 calling attention to the fact that the activities of the Russian Woodpecker were markedly reduced during the time WARC was in session. I suspect, for reasons that I'll try to make clear in this letter, that although your observation is quite correct, factors other than WARC may have played a significant role.

Some months back, I found it necessary to visit the Bonn-Cologne area of the Federal Republic of Germany, a locale in which there are a great number of good friends. Some are still quite active, professionally speaking; others are retired or (as am I) semi-retired.

I decided to make an unannounced call upon one of my better friends in Bad Godesberg, Herr S., who had retired from a very senior position in the Federal Ministry of Defense a few years back.

Frau S. met me at the door as casually and as graciously as though I'd never been away and then knocked the pins out from beneath me by stating quietly that my good friend Gunter had passed away only weeks earlier. She invited me in, but I'd had enough for one day.

I went over to the Weinhaus Maternas. Frankly, I've never thought too much of the place. My wife and I used to dine there from time to time until John Le Carre mentioned it in his book, *The Spy Who Came...* After that, the prices and the crowd increased while the...well, enough said!

One thing, though—if anyone were to be found anywhere in town, it would be there. Or back at the American Embassy club in Plittersdorf, and I didn't feel like driving over to the American community right then.

I was shown to an empty table

and, before my eyes were fully adjusted to the light level, someone sat at the table across from me. Actually, I didn't really have to see him—the voice and accent were enough. It was Alex K. He'd been the scientific and technical attache at one of the eastern bloc embassies during most of my period there. I thought that he'd left about the same time as I. We'd met frequently at formal functions but I don't recall ever before having been with him in as private a situation as right then.

I might add that I had often teased him about defecting to our side. He has and had a great sense of humor and took the kidding in stride...I think. At any rate, he seemed to sense my mood and appeared to be really trying to cheer me up.

After a few glasses and some trivial banter about mutual acquaintances, my humor gradually restored itself, but it was clear that Alex didn't realize it. It was about then that he inquired if there was anything that he could do for me, meaning, of course, to further cheer me up. I chose deliberately to misunderstand that. And now we come to the point: I asked him why his friends didn't turn off that "damned over-the-horizon radar" and stop "screwing up" the ham bands.

The man was shocked! He looked at me in total disbelief, accusing me of once again pulling his leg. He refused to accept the statement that the Woodpecker (by the way, he found the name amusing) was really bothering US hams. He mentioned that there were many amateurs in countries much closer to the radar's transmitter site than are the Americans.

Then, as I recall it, he said something about their technology being better than ours and able to cope with simple periodic interference. Finally, he noted that the West German amateurs seemed to have reduced the problem, referring to a technical paper that he'd seen in *CQ DL*, the FRG ham magazine, sometime in the summer of

1978. (Editor's Note: Also see *Ham Radio*, June, 1980.)

Still feigning a by-then completely dispelled ill humor, I said something like, "Dammit, I'm not smart enough, personally, to engineer a blanking circuit to eliminate the pulse noise for each of my rigs! Why don't you do the whole world a favor and just turn the thing off?"

Imagine my surprise when, after a rather lengthy pause, he very quietly said that he supposed something could be done to alleviate the problem. He didn't elaborate on that statement but did go on with something in the same vein. He said that if "that" (sic) doesn't take care of things, whenever the signal is exactly on my frequency, I am to swing my antenna to beam a signal over the pole and to send "H 5 H" in Morse.

I distinctly recall his telling me that the dot frequency should be exactly 10 Hz (about 13 wpm), as it was obvious that he was suggesting synchronization with an unnamed something, such as, for example, the Woodpecker's pulse repetition frequency. He said no more on the matter, turning the conversation towards questions of my family's health and other innocuous subjects. I left Alex and Maternas' shortly thereafter.

The meeting was prior to WARC so one can't say whether it was WARC or that chance encounter that resulted in a lessening of the Woodpecker's activities. It does seem to me that the interference has been somewhat less than in the past, even since the WARC.

I, of course, will neither admit to ever sending a coded "H 5 H" in order to clear a frequency nor will I suggest that others try Alex's proposed solution because I'm not sure whether the FCC would call such a transmission illegal coding or deliberate interference. I thought, however, that it might interest everyone to know the possibilities, not to mention knowing *really* why the Woodpecker is down.

(Name withheld by request)

Many of us have found that synchronized dots sent on the Woodpecker frequency will move it. Somehow I doubt if the FCC would have any objections to such counteraction to this invader of our bands.—Wayne.

20-YEAR KUDOS

Congratulations on 20 years of 73! And what a fabulous issue to commemorate!

You know, I have every issue of 73 here on two shelves, and I consider them to be one of my most valuable possessions.

Best luck in the next 20 years!

Ron Johnson WA5RON
Austin TX

THINK POSITIVE

Happy Anniversary! Keep it up!

E. P. Rolek K9SQG
Dayton OH

A GOOD INVESTMENT

About 20 years ago, I took a chance on a new ham magazine called 73. I invested my life's savings (students were very poor in those days and so were magazine publishers) in one of your life subscriptions. The deal was your life or mine.

I figure that both of us have a good investment in each other. From those early days, the magazine and you have grown and become prosperous; so have I. I now am one of those "electron" engineers. Ham radio had something to do with it. I hope the next 20 years are as good for both of us.

Until I read the anniversary issue editorials, I did not know that you were a member of MENSA. So am I.

Clive Frazier K9FWF/4
Orlando FL

CONSERVING ENERGY

Don't you think it would be appropriate at this time to devote one page of 73 to ideas and concepts of conserving energy? I'm sure amateurs the world over have experimented and come up with systems. I utilize a large heat sink placed on a coal stove and blow air over it with a muffin fan. I get heated air at 90°. I am now working on a pre-heater for the fan air by building a jacket around the stove pipe and pulling the air through it.

Continued on page 158

INTIMIDATED BY MORSE CODE?



**THE NEW AEA
MODEL MT-1
COMPUTERIZED
MORSE TRAINER
MAKES MORSE
CODE EASY AND
FUN TO LEARN.**

KT-1 Computerized Keyer With All Features of Above Trainer is Also Available in Same Package

- Automatic Speed Increase, User May Program: Starting Speed, Ending Speed, Practice Duration; 5 Letter code Groups or Random Space; Common or All Characters.
- Precise Speed Control 1 to 99 WPM (Tailor to Your Exact Requirements).
- 24,000 Character Answer Book Available For 10 Starting Positions.
- Random Mode For Practice (No Answers).

CALL TODAY

ROSS DISTRIBUTING COMPANY

Closed Monday at 2:00 p.m., 78 SOUTH STATE STREET, PRESTON, IDAHO 83263, TELEPHONE: (208) 852-0830

AEA Brings you the Breakthrough!

IMPROVE YOUR LISTENING. !

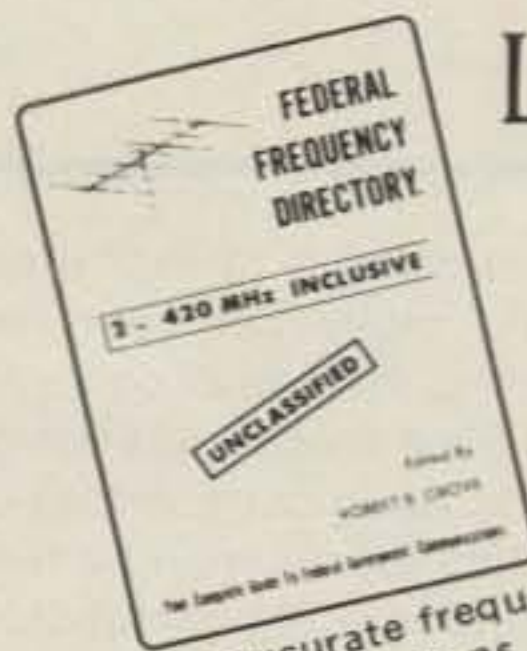

100,000 accurate frequencies, agencies and locations
\$14.95 Plus \$3.00 U.P.S.

SCANNER BEAM

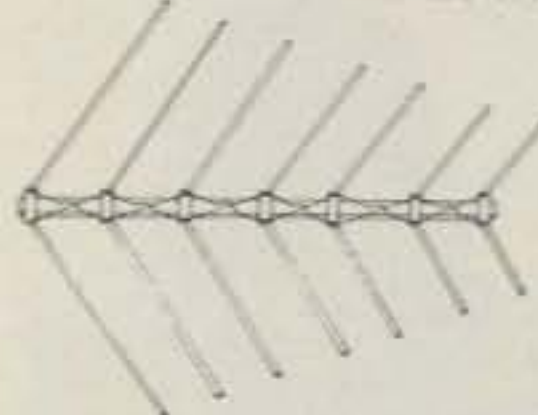

NEW MONITOR ANTENNA
Up to 8dB gain, 108-512 MHz
\$39.95 Plus \$4.00 U.P.S.

Send for FREE Catalog of accessories and publications

Shipping within 48 hours

Payment must accompany order



Identify those strange sounds
Professional listening tips
60 minute cassette
\$5.95 Plus \$1.00 shipping

• DEALER INQUIRY INVITED •

"...SEARCHING FOR THE SOUNDS OF TOMORROW."

GROVE ENTERPRISES INC

✓352

Dept. K

BRASSTOWN, NORTH CAROLINA 28902

X-RATED

OUTPERFORMS
ALL commercially
available tribanders
AND many monoband
systems, too!

KLM's KT-34X

20, 15, & 10M — FOR THE MATURE HAM ONLY

KT-34 UPGRADE KITS AVAILABLE

WRITE FOR COMPLETE DETAILS OR
SEE YOUR LOCAL KLM DEALER

KLM 17025 LAUREL RD., MORGAN HILL, CA 95037, (408) 779-7363

✓40

FUN!



John Edwards WB2IBE
78-56 86th Street
Glendale NY 11385

This month's "Fun!" offering should really set your heads spinning. Instead of concentrating on one specific operating endeavor, as in our previous quizzes, this month we'll be testing you on the entire gamut of amateur radio history, everything from spark to space communications, with lots of other interesting highlights in between. So get those thinking caps on, for this month we learn about ham history.

ELEMENT 1—CROSSWORD PUZZLE (Illustration 1)

Across

- | | |
|--|------------------------------|
| 1 One end of first transatlantic QSO | 28 Irish prefix |
| 2 End of contact | 29 It replaced spark (abbr.) |
| 8 Morse question mark | 32 80-10 meters (abbr.) |
| 9 British tube | 34 Old receiver |
| 11 Disaster Radio Service (abbr.) | 36 Our fate |
| 13 "Shahland" prefix | 38 Caribbean QTH (abbr.) |
| 15 Upstart ham organization of 1950s (abbr.) | 39 Former ham manufacturer |
| 17 Status of 11-meter amateur band | |
| 19 Initials of government man who reopened our bands after WWI | |
| 20 Low frequency (abbr.) | |
| 23 Former deceptive ham outlet | |
| 26 WWII ham substitute (abbr.) | |

Down

- | |
|---------------------------------|
| 1 6-meter predecessor (2 words) |
| 2 Old traffic post (abbr.) |
| 3 What we get on |
| 4 Before SOS |
| 5 Greek prefix |
| 6 New Novice-type call |
| 7 Triode inventor |
| 10 Idle ham |
| 12 November contest (abbr.) |
| 14 Wouff_____ |

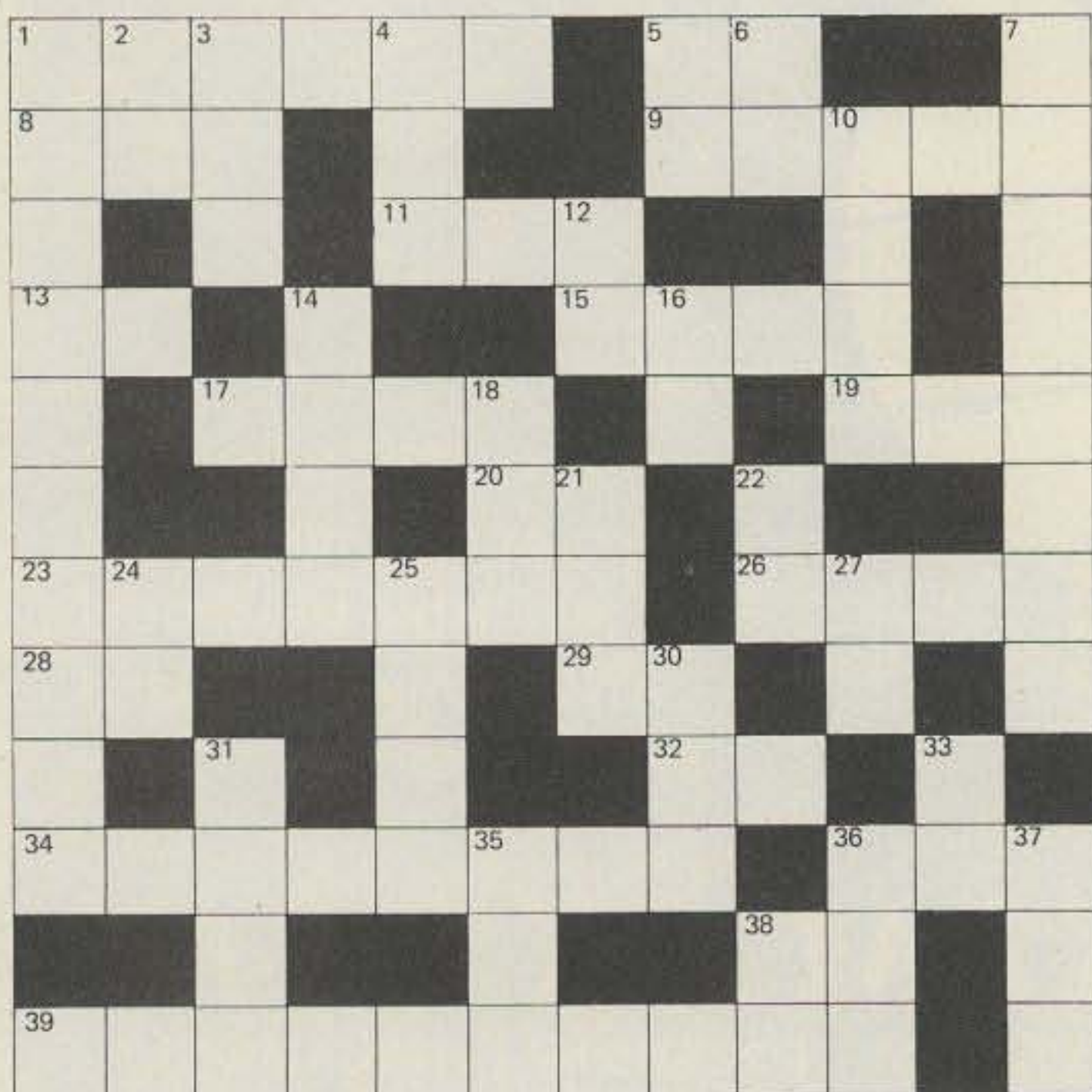

Illustration 1.

- | | |
|----------------------------|---------------------------|
| 16 Audio frequency (abbr.) | 30 QRZ? |
| 18 Element (abbr.) | 31 FCC legal step (abbr.) |
| 21 FCC predecessor (abbr.) | 33 RACES official (abbr.) |
| 22 Long wave (abbr.) | 35 Cycles_____second |
| 24 Old FCC agent (abbr.) | 36 Bad op |
| 25 Equipment | 37 "The Old Man" (abbr.) |
| 27 ARRL appointee (abbr.) | 38 Former Novice prefix |

ELEMENT 2—MATCHING

Match the former ham manufacturers and distributors in Column A with their QTHs in Column B.

- | Column A | Column B |
|--|-----------------------------|
| 1 E. F. Johnson | A Brooklyn NY |
| 2 RCA Electron Tubes | B Roslyn NY |
| 3 Gonset | C Chicago IL |
| 4 Lafayette Radio | D Millington-Watchung NJ |
| 5 Atlas Radio | E Indianapolis IN |
| 6 Hammarlund | F Hicksville NY |
| 7 Hallicrafters | G Council Bluffs IA |
| 8 Regency | H New York NY, Mars Hill NC |
| 9 Uncle Dave's Radio Shack (Fort Orange Radio) | I Oklahoma City OK |
| 10 Amperex | J Waseca MN |
| 11 Greenlee Tool | K Rockford IL |
| 12 Sonar Radio | L New York NY |
| 13 Galaxy | M Boston MA |
| 14 Terminal Radio | N Albany NY |
| 15 LTV-University | O Kansas City MO |
| 16 RME-ElectroVoice | P Harrison NJ |
| 17 Burstein-Applebee | Q San Francisco CA |
| 18 Alltronics-Howard | R Buchanan MI |
| 19 Squires-Sanders | S Jamaica-Syosset NY |
| 20 Sideband Engineers | T Burbank-Anaheim CA |
| | U Oceanside CA |

ELEMENT 3—MULTIPLE CHOICE

1) In 1921, the "Transatlantic Tests" were held to see which amateur could first transmit a signal from America to Europe. What was so unusual about the first ham to accomplish this feat?

- 1) He was a pirate signing 1AAW.
- 2) He sent his signal on 2 meters.
- 3) His signal was frequency modulated.
- 4) He was not an American, but a Canadian.

2) Back in the 1950s, General Electric sponsored an annual award presented to an "amateur who has rendered outstanding public service." The name of this award was:

- 1) The Maxim Award.
- 2) The Baldwin Cup.
- 3) The Edison Award.
- 4) The WB2LWJ Certificate of Merit.

3) Speaking of awards, the Elser-Mathes Trophy, currently on display in Newington, will be awarded to the first amateur who accomplishes:

- 1) A 2-way contact with Mars.
- 2) WAS on a microwave band.
- 3) The first digital phone transmission.
- 4) DXCC on fast-scan television.

4) We all know that Guglielmo Marconi invented radio. But did you know that he had a brother who helped him with many of the invention's trial experiments? What was the first name of this "other" Marconi?

- 1) Luigi
- 2) Alfonso
- 3) Kevin
- 4) Luciano

Continued on page 150

NEW

Now "In the works" at Spec Comm - Complete 10M FM "Split Site" Repeater System!

The 1st
Commercially
Made -

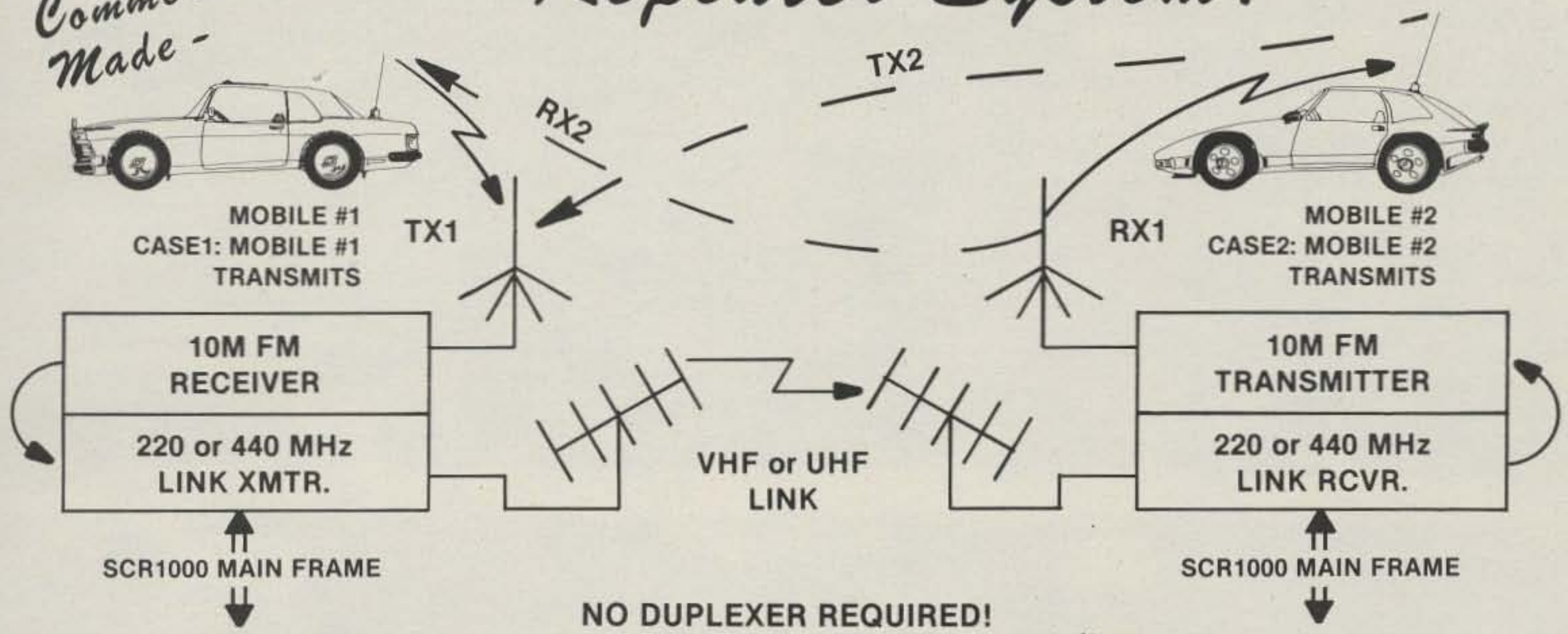

- **JOIN THE FUN ON 10M FM!** This new phase of Amateur Radio is growing every day, and promises to be one of the most exciting new modes of operation in years!
- **10M FM COMBINES ALL OF THE BENEFITS OF VHF FM OPERATION WITH HF "LOW BAND" OPERATION;** i.e., the quiet, noise-free QSOs of 2M FM *except better ground wave range*, with less mobile fading and flutter due to hills and trees, etc. Plus—occasional "Skip" contacts all over the country and around the world... with all of the clarity and "solidness" of cross-town 2M FM contacts!
- **ON 10M FM,** you can use low cost, cutdown CB antennas and accessories. And, low cost 10M FM Transceivers are now available from other manufacturers.
- **ON 10M FM,** you can avoid the crowded conditions on other bands!

THE SPEC COMM 10M FM REPEATER SYSTEM IS COMPOSED OF 2—SCR1000 REPEATER/LINK UNITS. One unit includes the 10M receiver and a 10W 220 or 440 MHz link transmitter. The second unit (which should be operated a mile or more from the first) includes the 30 W 10M transmitter and a 220 or 440 MHz link receiver. Note that this system does *not* require a duplexer—which is impractical on 10M (over 8' high, and super expensive). Each of the 2 units is basically the same as our

tried and proven SCR1000 Repeater which includes all of the necessary Audio and Control circuitry, plus AC Power Supply with instant Battery Switchover, CW IDer, full front panel controls and metering, etc., We can also supply 10M commercial grade vertical antennas, "Hardline" cable, cabinets, etc. Call or write for further details on this new system which is now under development at Spectrum. Estimated price is about the same as 2—SCR1000 VHF Repeaters.

SPECTRUM COMMUNICATIONS

1055 W. Germantown Pk., Dept. S1 • Norristown PA 19401 • (215) 631-1710

TS-830S

"Top-notch"... VBT, notch, IF shift, wide dynamic range

The TS-830S has every conceivable operating feature built-in for 160-10 meters (including the three new bands). It combines a high dynamic range with variable bandwidth tuning (VBT), IF shift, and an IF notch filter, as well as very sharp filters in the 455-kHz second IF. Its optional VFO-230 remote digital VFO provides five memories.

TS-830S FEATURES:

- LSB, USB, and CW on 160-10 meters, including the new 10, 18, and 24-MHz bands. Receives WWV.
- Wide receiver dynamic range. Junction FETs in the balanced mixer, MOSFET RF amplifier at low level, and dual resonator for each band.
- Variable bandwidth tuning (VBT). Varies IF filter pass-band width.
- Notch filter (high-Q active circuit in 455-kHz second IF).
- IF shift (passband tuning).
- Built-in digital display (six digits, fluorescent tubes), analog subdial, and display hold (DH) switch.
- Noise-blanker threshold level control.
- 6146B final with RF negative feedback. Runs 220 W PEP (SSB)/180 W DC (CW) input on all bands.
- Built-in RF speech processor.
- Narrow/wide filter selection on CW.
- SSB monitor circuit to check transmitted audio quality.
- RIT (receiver incremental tuning) and XIT (transmitter incremental tuning).

OPTIONAL ACCESSORIES:

- SP-230 external speaker with selectable audio filters.
- VFO-230 external digital VFO with 20-Hz steps, five memories, digital display.
- AT-230 antenna tuner/SWR and power meter/antenna switch; 160-10 meters, including three new bands.
- YG-455C (500-Hz) and YG-455CN (250-Hz) CW filters for 455-kHz IF.
- YK-88C (500-Hz) and YK-88CN (270-Hz) CW filters for 8.83-MHz IF. (VFOs for TS-830S, TS-130 Series, and TS-120S are compatible with all three series of transceivers.)



SP-230

TS-830S

VFO-230

AT-230

TS-130S/V

"Small wonder"... processor, N/W switch, IF shift, DFC option

The compact, all solid-state HF SSB/CW mobile or fixed station TS-130 Series transceiver covers 3.5 to 29.7 MHz, including the three new bands.

TS-130 SERIES FEATURES:

- 80-10 meters, including the new 10, 18, and 24-MHz bands. Receives WWV.
- TS-130S runs 200 W PEP/160 W DC input on 80-15 meters and 160 W PEP/140 W DC on 12 and 10 meters. TS-130V runs 25 W PEP/20 W DC input on all bands.
- Built-in speech processor.
- Narrow/wide filter selection on both CW (500 Hz or 270 Hz) and SSB (1.8 kHz) with optional filters.

- Automatic selection of side-band mode (LSB on 40 meters and below, and USB on 30 meters and above). SSB REVERSE switch provided.
- Built-in digital display.
- Built-in RF attenuator.
- IF shift (passband tuning).
- Effective noise blanker.

OPTIONAL ACCESSORIES:

- PS-30 base-station power supply.
- YK-88C (500 Hz) and YK-88CN (270 Hz) CW filters.
- YK-88SN (1.8 kHz) narrow SSB filter.
- AT-130 compact antenna tuner (80-10 meters, including three new bands).

- SP-120 external speaker.
- VFO-120 remote VFO.
- MB-100 mobile mounting bracket.
- PS-20 base-station power supply for TS-130V.



Optional DFC-230 Digital Frequency Controller

Frequency control in 20-Hz steps with UP/DOWN microphone (supplied with DFC-230). Four memories and digital display. (Also operates with TS-120 and TS-830S.)



PS-30

SP-120

TS-130S

VFO-120

TS-180S with DFC

High quality...top performance,
with optimum features

The top-of-the-line TS-180S all solid-state HF SSB/CW/FSK transceiver with DFC (Digital Frequency Control) provides maximum performance and efficiency for every amateur.

TS-180S FEATURES:

- All solid-state. 200 W PEP/160 W DC input on 160-15 meters, and 160 W PEP/140 W DC on 10 meters. Adaptable to three new bands.

- Dual SSB filter (optional) to improve selectivity, reduce noise, and improve RF-speech-processor operation.
- Digital Frequency Control (DFC), including four memories with digital up/down paddle-switch tuning in 20-Hz steps. Memories operate in transceiver or split modes. (Also available without DFC.)
- IF shift (passband tuning).

- Built-in digital display with differential function. Shows actual VFO frequency and difference between VFO and "M1" memory (or "hold" without DFC) frequencies.
- Selectable wide and narrow CW bandwidth.

- Tunable noise blanker.
- RF AGC.

- Automatic selection of upper and lower sideband (with SSB NORMAL/REVERSE switch).
- Dual RIT (VFO, memory/fix).

OPTIONAL ACCESSORIES:

- PS-30 base-station power supply.
- SP-180 external speaker with selectable audio filters.
- VFO-180 remote VFO.
- AT-180 antenna tuner/SWR and power meter/antenna switch.
- DF-180 digital frequency control (for TS-180S without DFC).
- YK-88C (500 Hz) and YK-88CN (270 Hz) CW filters.
- YK-88S SSB filter for dual IF filter system.



MC-50



PS-30

SP-180

TS-180S

VFO-180

TS-520SE

"Cents-ability" in a quality 160-10 meter
SSB/CW rig

The TS-520SE is an economical, full-featured 160-10 meter transceiver, found in more ham shacks than any other rig.

TS-520SE FEATURES:

- 160-10 meters... and receives WWV on 15 MHz.
- 200 W PEP (SSB)/160 W DC (CW) input on all bands.

- CW WIDE/NARROW bandwidth switch for use with optional 500-Hz CW filter.
- Speech processor for extra audio punch.
- Effective noise blanker.
- 20-dB RF attenuator.
- RIT (receiver incremental tuning) control.

- Digital display with optional DG-5, showing actual operating frequency while transmitting and receiving.
- Eight-pole crystal filter for excellent selectivity.
- Built-in 25-kHz calibrator, adjustable to WWV.
- VOX and semi-break-in CW with sidetone.
- Built-in speaker.
- Solid-state, with tube driver and final.

- Amplified-type AGC circuit.
- Amplified-type ALC.
- Front-panel carrier level control.

OPTIONAL ACCESSORIES:

- SP-520 external speaker.
- DG-5 digital frequency display and 40-MHz counter.
- VFO-520S remote VFO.
- CW-520 500-Hz CW filter.
- AT-200 antenna tuner/SWR and RF power meter/antenna switch.

DG-5



SP-520

TS-520SE

VFO-520S



TR-7800

"Easy selection"... 15 memories/offset recall, scan, priority, DTMF (Touch-Tone®)

Frequency selection with the TR-7800 2-meter FM mobile transceiver is easier than ever. The rig incorporates new memory developments for repeater shift, priority, and scan, and includes a built-in autopatch Touch-Tone® encoder.

TR-7800 FEATURES:

- 15 multifunction memory channels, selected with a

rotary switch. M1-M13... memorize frequency and offset (± 600 kHz or simplex). M14... memorize transmit and receive frequencies independently for nonstandard offset. M0... priority channel, with simplex, ± 600 kHz, or nonstandard offset.

- Internal backup for all memories, by installing four AA NiCd batteries (not Kenwood-

supplied) in battery holder.

- Priority channel (memory "0") and priority alert.
- Covers 143.900-148.995 MHz, in 5-kHz or 10-kHz steps.
- Built-in autopatch DTMF (Touch-Tone®) encoder.
- Front-panel keyboard for selecting frequency, transmit offset, and autopatch encoder tones, programming memories, and controlling scan.
- Automatic scan of entire band (5-kHz or 10-kHz steps) and memories.
- Manual scan of band and memories, with UP/DOWN microphone (standard).

SP-40

Compact, high-quality mobile speaker

- Matches all HF, VHF, and UHF radios for mobile operation.
- Only 2-11/16 inches wide by 2-1/2 inches high by 2-1/8 inches deep.
- 4-ohm input impedance.
- Handles 3 watts of audio.
- Mounting bracket with ferrite steel plate supplied for mounting virtually anywhere.



- Repeater REVERSE switch.
- Selectable power output. 25 W (HI)/5 W (LOW).
- LED S/Rf bar meter.
- TONE switch to actuate subaudible tone module (not Kenwood-supplied).

OPTIONAL ACCESSORIES:

- KPS-7 fixed-station power supply.

TR-8400

"Go synthesized on 440 MHz FM"... 5 memories, memory/band scan

The TR-8400 synthesized 70-cm UHF FM mobile transceiver covers 440-450 MHz in 25-kHz steps and includes five memories, automatic memory and band scan, UP/DOWN manual scan, and two VFOs.

TR-8400 FEATURES:

- Synthesized coverage of 440-450 MHz in 25-kHz steps.

- Five memories and memory backup terminal on rear panel.
- Two VFOs.
- Offset switch for ± 5 MHz transmit offset and simplex operation. Fifth memory allows any other offset by memorizing receive and transmit frequencies independently.

- Automatic scan of memories and of 440-450 MHz band (in 25-kHz steps). Locks on busy channel and resumes when signal disappears. HOLD or mic PTT button cancels scan.
- Up/down manual band scan in 25-kHz steps with UP/DOWN microphone supplied with TR-8400.
- Only 5-3/4 inches wide, 2 inches high, and 7-5/8 inches deep. Weighs only 3.75 pounds.

- TONE switch to activate sub-tone device (not Kenwood-supplied). DTMF (Touch-Tone®) terminal on rear panel.
- Four-digit frequency display and S/Rf bar meter. Other LEDs indicate BUSY, ON AIR, and REPEATER operation.
- HI/LOW (10 W/1 W) RF-output power switch.

OPTIONAL ACCESSORIES:

- KPS-7 fixed-station power supply.
- SP-40 compact mobile speaker.



TR-9000

"New 2-meter direction"... compact rig with FM/SSB/CW, scan, five memories

The TR-9000 combines the convenience of FM with long distance SSB and CW. It is extremely compact... perfect for mobile operation. Matching accessories are available for optimum fixed-station operation.

TR-9000 FEATURES:

- FM, USB, LSB, and CW.
- Only 6-11/16 inches wide, 2-21/32 inches high, 9-7/32 inches deep.

- Two digital VFOs, with selectable tuning steps of 100 Hz, 5 kHz, and 10 kHz.
- Digital frequency display. Five, four, or three digits, depending on selected tuning step.
- Covers 143.9000-148.9999 MHz.
- Band scan... automatic busy stop and free scan.
- SSB/CW search of selectable 9.9-kHz bandwidth segments.

- Five memories... four for simplex or ± 600 kHz repeater offsets and the fifth for a non-standard offset (memorizes transmit and receive frequency independently).
- UP/DOWN microphone (standard) for manual band scan.
- Noise blanker for SSB and CW.
- RIT (receiver incremental tuning) for SSB and CW.
- RF gain control.
- CW sidetone.
- Selectable RF power outputs... 10 W (HI)/1 W (LO).
- Mobile mounting bracket with quick-release levers.
- LED indicators... ON AIR, BUSY, and VFO.

OPTIONAL ACCESSORIES:

- PS-20 fixed-station power supply.
- SP-120 fixed-station external speaker.
- BO-9 System Base... with power switch, SEND/RECEIVE switch (for CW), memory-backup power supply, and headphone jack.



PS-20

TR-9000

BO-9

SP-120

TR-2400

"Hand-shack"... synthesized, big LCD, scan, 10 memories, DTMF (Touch-Tone®)



CONVENIENT TOP CONTROLS

The TR-2400 has the most convenient operating features desired in a 2-meter FM hand-held transceiver.

TR-2400 FEATURES:

- Large LCD digital readout. Readable in direct sunlight (virtually no current drain) and in the dark (lamp switch). Shows receive and transmit frequencies and memory channel. "Arrow" indicators show "ON AIR," "MR" (memory recall), "BATT" (battery status), and "LAMP" switch on.

- Keyboard selection of 144.000-147.995 MHz in 5-kHz increments. No "5-UP" switch needed.
- UP/DOWN manual scan in 5-kHz steps from 143.900 to 148.495 MHz.
- 10 memories. Retained with battery backup. "M0" memory may be used to shift transmitter to any frequency for nonstandard-split repeaters.
- Built-in autopatch DTMF (Touch-Tone®) encoder, using all 16 keyboard buttons.
- Automatic memory scan.
- Repeater or simplex operation. Transmit frequency shifts ± 600 kHz or to "M0" memory frequency.
- Reverse switch. Transposes receive and transmit frequencies.
- Subtone switch (tone encoder not Kenwood-supplied).
- Two lock switches to prevent accidental frequency change and accidental transmission.

- External PTT microphone and earphone connectors.
- Rubberized antenna with BNC connector, NiCd battery pack, AC charger, PTT and mic plugs, handstrap, and earphone included.
- Extended operating time with LCD and overall low-current circuit design. Only draws about 28 mA squelched receive and 500 mA transmit (at 1.5 W RF output).
- High-impact case and zinc die-cast frame.
- Compact and lightweight. Only 2-13/16 inches wide, 7-9/16 inches high, and 1-7/8 inches deep. Weighs only 1.62 pounds (including antenna, battery, and hand strap).

OPTIONAL ACCESSORIES:

- ST-1 Base Stand (provides 1.5-hour-quick, trickle, and floating charges, 4-pin microphone connector, and SO-239 antenna connector).
- BC-5 DC quick charger.
- LH-1 leather case.
- BH-1 belt hook.
- PB-24 extra NiCd battery pack.
- SMC-24 speaker/microphone.



R-1000

"Hear there and everywhere"...
easy tuning, digital display

The R-1000 is an amazingly easy-to-operate, high-performance, communications receiver, covering 200 kHz to 30 MHz in 30 bands. This PLL synthesized receiver features a digital frequency display and analog dial, plus a quartz digital clock and timer.

R-1000 FEATURES:

- Covers 200 kHz to 30 MHz continuously.

- 30 bands, each 1 MHz wide.
- Five-digit frequency display with 1-kHz resolution and analog dial with precise gear dial mechanism.
- Built-in 12-hour quartz digital clock with timer to turn on radio for scheduled listening or control a recorder through remote terminal.
- Step attenuator to prevent overload.

- Three IF filters for optimum AM, SSB, CW. 12-kHz and 6-kHz (adaptable to 6-kHz and 2.7-kHz) for AM wide and narrow, and 2.7-kHz filter for high-quality SSB (USB and LSB) and CW reception.
- Effective noise blanker.
- Terminal for external tape recorder.
- Tone control.
- Built-in 4-inch speaker.
- Dimmer switch to control intensity of S-meter and other panel lights and digital display.

- Wire antenna terminals for 200 kHz to 2 MHz and 2 MHz to 30 MHz. Coax terminal for 2 MHz to 30 MHz.
- Voltage selector for 100, 120, 220, and 240 VAC. Also adaptable to operate on 13.8 VDC with optional DCK-1 kit.

OPTIONAL ACCESSORIES:

- SP-100 matching external speaker.
- HS-5 and HS-4 headphones.
- DCK-1 modification kit for 12-VDC operation.



SP-100

R-1000



HS-5



HC-10

Digital world clock with two
24-hour displays, quartz time base

The HC-10 digital world clock with dual 24-hour display shows local time and the time in 10 preprogrammed plus two programmable time zones.

HC-10 FEATURES:

- Two 24-hour displays with quartz time base. Right display shows local (or UTC) hour, minute, second, day. Left display shows month, date, world time in various cities,

- memory time (QSO starting time), and time difference (in hours from UTC).
- Preprogrammed time in 10 cities around the world, plus two programmable time zones.
- "TOMORROW" and "YESTERDAY" indicators.
- Memorization of present time. Can be recalled later, for logging purposes.
- High accuracy (± 10 seconds/month).



DM-81

Dip meter
performs many RF
measurements

The DM-81 dip meter is highly accurate and features, in addition to the traditional inductive-coupling technique, capacitive coupling for measuring metal-enclosed coils and toroidal coils.

DM-81 FEATURES:

- Measuring range of 700 kHz-250 MHz in seven bands.
- Built-in storage compartment for all seven coils, capacitive probe, earphone, and ground clip lead.
- All solid-state and built-in battery.
- HC-25U and FT-243 sockets for checking crystals and marker-generator function.
- Amplitude modulation.
- FET for good sensitivity.
- Absorption frequency meter function.
- Earphone for monitoring transmitted signals.
- Capacitance probe for measuring resonant frequencies without removing coil shields, and also for measuring resonant frequencies of toroidal coils.



TL-922-A

Maximum legal power on 160-15 meters

The TL-922A linear amplifier provides maximum legal power on the 160-15 meter Amateur bands.

TL-922A FEATURES:

- 2000 W PEP (SSB)/1000 W DC (CW, RTTY) input power on 160, 80, 40, 20, and 15 meters, with 80 W drive.
- Excellent IMD characteristics.
- Pair of EIMAC 3-500Z high-

performance transmitting tubes.

- Safety protection.
- Blower with automatic turnoff-delay circuit.
- Variable threshold level type ALC.
- Two meters, one indicating plate current, and the other indicating grid current, relative RF output, and high voltage.



SM-220

High-performance oscilloscope for various monitoring functions

The SM-220 Station Monitor provides a variety of waveform-observing capabilities, and an optional pan display.

SM-220 FEATURES:

- Monitors transmitted SSB and CW waveforms from 1.8 to 150 MHz.
- Monitors signal waveforms in receiver's IF stage.
- Functions as high-sensitivity, wide-frequency-range (up to 10 MHz) oscilloscope.
- Tests linearity of linear amplifiers (provides trapezoid pattern).

- Allows observation of RTTY tuning points (cross pattern).
- Built-in two-tone (1000-Hz and 1575-Hz) generator.
- Expandable to pan-display capability for observing the number and amplitude of stations within a switchable ± 20 kHz/ ± 100 kHz bandwidth.

OPTIONAL ACCESSORIES:

- BS-8 pan-display module for TS-180S, TS-830S, and TS-820 Series.
- BS-5 pan-display module for TS-520 Series.



SP-70

TS-600 W/VOX-3

TS-600

All-mode, all solid-state 6-meter transceiver

The TS-600 is a 6-meter, all-mode, all solid-state transceiver with VFO (and crystal-controlled) coverage of the entire band.

TS-600 FEATURES:

- SSB (20 W PEP input), FM and CW (10 W output), and AM (5 W output).
- Operates on 120/220 VAC, 50/60 Hz or 13.8 VDC.
- VFO coverage of 50-54 MHz in four bands, with two-speed dial mechanism. Favorite frequencies may be crystal-controlled.
- Effective noise blanker.
- VOX operation with VOX-3

accessory (standard).

TS-700SP 2-meter, all-mode, all solid-state transceiver is also available... with similar features, plus:

- Digital frequency display, with 100-Hz resolution.
- VFO coverage of 144-148 MHz in four bands.
- Simplex and repeater operation, including all repeater subbands. REVERSE switch.

OPTIONAL ACCESSORIES:

- VFO-700S remote VFO (for TS-700S/SP).
- SP-70 external speaker.

ACCESSORIES

A wide selection of optional accessories is offered for optimum operating flexibility. In addition to the optional items listed with each piece of equipment described in this catalog, the following accessories are also available:



MC-50 dynamic dual-impedance (50 k Ω /500 Ω) desk microphone.

MC-30S (500 Ω) and **MC-35S** (50 k Ω) dynamic noise-canceling hand microphones.

HS-5 deluxe 8 Ω headphone set.

HS-4 8 Ω headphone set.



PC-1 phone patch with hybrid circuit and VU meter for null and audio gain measurements.



MC-45 Touch-Tone[®] (with automatic transmit) microphone.

NOTE: Prices and specifications of all Trio-Kenwood products are subject to change without prior notice or obligation.

Look for the Kenwood banner.



Only the best dealers are Authorized Kenwood Dealers. If your dealer displays a Kenwood Authorized Dealer banner and plaque in his store, you will know he can provide you with the service you demand . . . of the same quality as factory service. Authorized Kenwood Dealers employ factory-trained service technicians, maintain an extensive inventory of spare parts, and have direct access to factory service information. When you deal with an Authorized Kenwood Dealer, you deal with an expert on the entire line of Kenwood Amateur Radio equipment.

ALABAMA

Long's Electronics
2808 7th Avenue South
Birmingham, AL 35233
(205) 252-7589

ALASKA

Reliable Electronics
3306 Cope Street
Anchorage, AK 99503
(907) 279-5100

ARIZONA

Power Communications
1640 W. Camelback Road
Phoenix, AZ 85015
(602) 241-9288

CALIFORNIA

Ham Radio Outlet
999 Howard Avenue
Burlingame, CA 94010
(415) 342-5757

Ham Radio Outlet
6265 Sepulveda Boulevard
Van Nuys, CA 91401
(213) 988-2212

Ham Radio Outlet
2620 West La Palma
Anaheim, CA 92801
(213) 860-2040

Ham Radio Outlet
5375 Kearny Villa Road
San Diego, CA 92123
(714) 560-4900

Henry Radio, Inc.
11240 W. Olympic Blvd.
Los Angeles, CA 90064
(213) 477-6701

Henry Radio, Inc.
931 North Euclid
Anaheim, CA 92801
(213) 430-7997

Webster Radio

2602 East Ashlan
Fresno, CA 93726
(209) 224-5111

COLORADO

CW Electronics
800 Lincoln Street
Denver, CO 80202
(303) 893-5525

FLORIDA

Amateur Electronic Supply
621 Commonwealth
Orlando, FL 32803
(305) 894-3238
Amateur Radio Center
2805 N.E. Second Avenue
Miami, FL 33137
(305) 573-8383

HAWAII

Honolulu Electronics
819 Keeaumoku Street
Honolulu, HI 96814
(808) 949-5564

IDAHO

Ross Distributing
78 South State Street
Preston, ID 83263
(208) 852-0830

ILLINOIS

Erickson Communications
5456 N. Milwaukee Ave.
Chicago, IL 60630
(312) 631-5181
Klaus Radio, Inc.
8400 N. Pioneer Pkwy.
Peoria, IL 61614
(309) 691-4840

INDIANA

Graham Electronics
133 South Pennsylvania
Indianapolis, IN 46240
(317) 635-5453

Hoosier Electronics

P.O. Box 2001
43-B Meadows Shop. Ctr.
Terre Haute, IN 47802
(812) 238-1456

Kryder Electronics

2810 Maplecrest Road
Fort Wayne, IN 46815
(219) 484-4946

IOWA

HI, Incorporated
P.O. Box 864
Council Bluffs, IA 51502
1601 Avenue "D"
Council Bluffs, IA 51501
(712) 323-0142

KANSAS

Associated Radio Comm.
P.O. Box 4327
8012 Conser
Overland Park, KS 66204
(913) 381-5901

MARYLAND

Electronic Int'l Service
11305 Elkin Street
Wheaton, MD 20902
(301) 946-1088
The Comm Center
9624 Ft. Meade Road
Laurel, MD 20810
(301) 792-0600

MASSACHUSETTS

Tufts Electronics
206 Mystic Avenue
Medford, MA 02155
(617) 395-8280

MICHIGAN

Radio Supply & Engineer
85 Selden Avenue
Detroit, MI 48201
(313) 831-3175

MINNESOTA

Electronic Center
127 Third Avenue North
Minneapolis, MN 55401
(612) 371-5240

MISSOURI

Ham Radio Center
8342 Olive Boulevard
St. Louis, MO 63132
(314) 993-6060

Henry Radio Company
211 North Main Street
Butler, MO 64730
(816) 679-3127

Midcom Electronics
8516 Manchester Road
St. Louis, MO 63144
(314) 961-9990

MONTANA

Conley Radio Supply
318 North 16th Street
Billings, MT 59101
(406) 259-9554

NEBRASKA

Communications Center
1840 "O" Street
Lincoln, NB 68508
(402) 466-3733

NEW MEXICO

Electronic Module
601 North Turner
Hobbs, NM 88240
(505) 397-3022

NEW YORK

Adirondack Radio Supply
P.O. Box 88
185-191 West Main Street
Amsterdam, NY 12010
(518) 842-8350

Harrison Radio Corporation

20 Smith Street
Farmingdale,
Long Island, NY 11735
(516) 293-7990

Radio World*

Oneida County Airport
Terminal Building
Oriskany, NY 13424
(315) 337-0203

OHIO

Amateur Electronic Supply
28940 Euclid Avenue
Wickliffe, OH 44092
(216) 585-7388

Srepco Electronics

314 Leo Street
Dayton, Ohio 45404
(513) 224-0871

Universal Amateur Radio, Inc.

1280 Aida Drive
Reynoldsburg, OH 43068
(614) 866-4267

OKLAHOMA

Derrick Electronics
P.O. Box 457
714 West Kenosha
Broken Arrow, OK 74012
(918) 251-9923

Radio, Inc.

1000 South Main
Tulsa, OK 74119
(918) 587-9123

OREGON

Portland Radio Supply
1234 S.W. Stark Street
Portland, OR 97205
(503) 773-5815

PENNSYLVANIA

Hamtronics/Trevoze
4033 Brownsville Road
Trevoze, PA 19047
(215) 357-1400

JRS Distributors

646 West Market Street
York, PA 17404
(717) 854-8624

SOUTH CAROLINA

G.I.S.M.O.

Communications
2305 Cherry Road
Rock Hill, SC 29730
(803) 366-7157

SOUTH DAKOTA

Burghardt Amateur Center

P.O. Box 73
208 East Kemp Avenue
Watertown, SD 57201
(605) 886-7314

TENNESSEE

Amateur Radio Supply of Nashville

615 S. Gallatin Road
Madison, TN 37115
(615) 868-4956

Sere-Rose & Spencer

1465 Wells Station Road
Memphis, TN 38108
(901) 683-9125

TEXAS

Douglas Electronics
1118 South Staples
Corpus Christi, TX 78404
(512) 883-5103

Electronics Center

2929 North Haskell
Dallas, TX 75204
(214) 526-2023

Hardin Electronics

5635 East Rosedale
Fort Worth, TX 76112
(817) 429-9761

Madison Electronics

1508 McKinney Avenue
Houston, TX 77010
(713) 658-0268

Kennedy Associates*

2618 Rigsby Avenue
San Antonio, TX 78222
(512) 333-6110

WASHINGTON

ABC Communications
17550 15th Avenue N.E.
Seattle, WA 98155
(206) 364-8300

Amateur Radio Supply Co.

6213 13th Avenue South
Seattle, WA 98108
(206) 767-3222

WISCONSIN

Amateur Electronic Supply

4828 W. Fond Du Lac Ave.
Milwaukee, WI 53216
(414) 442-4200

As of September 16, 1980, only the above are fully Authorized Trio-Kenwood Communications, Inc. dealers.

 **KENWOOD**
TRIO-KENWOOD COMMUNICATIONS INC.
1111 WEST WALNUT / COMPTON, CA 90220

*Interim dealer.

LEAKY LINES



Dave Mann K2AGZ
3 Daniel Lane
Kinnelon NJ 07405

I've had a hankering for a long time to write about flea markets. And now that the season is over for this year, here in the north, anyway, I thought that I might make some observations. Like most guys who are somewhat quick on the trigger (I'm sometimes known as the quickest mike button in the east), I was going to shoot from the hip, quite convinced that I had a valid point of view. But after some discussions with several friends, I made a 180° turn. I must confess that I had not delved very deeply below the surface, and my ideas had been all wet.

The most important thing about flea markets is that if they weren't included, none of our ham conclaves could begin to draw the huge attendance they do. In fact, many convention symposiums and caucuses are relatively poorly attended, but flea markets are generally so crowded that you invariably have to elbow your way to get through the aisles. Flea markets are unquestionably the most popular attractions of all. Why should this be so?

Because the idea of something for nothing (or relatively nothing) is one of the most powerful motivations in all Creation. That's why there was a huge crowd when they first opened the Oklahoma Territory, why hordes of people flocked to Sutter's Mill and the Klondike when someone struck gold, and why department stores are thronged on Washington's Birthday. The prospect of a big bargain is almost irresistible.

Some flea markets are good, and some are not so good. It all depends upon just how well the individual makes out in his or

her buying and selling. If you are on the prowl for a certain item and you happen to find it at a good price, then you are apt to conclude that it's a good flea market. But if you load a couple of tons of stuff into your pickup truck and lug it three or four hundred miles, then don't succeed in selling any of it, you might well be justified in thinking it's a lousy one. It all depends on your individual frame of reference... like anything else.

Flea markets generally depend upon word of mouth for success. If a given flea market turns out to be fruitful for a large number of people, you can bet that it will be even better attended next year. For there are enormous multitudes who look forward to these things, and they think nothing of traveling hundreds, if not thousands, of miles to attend. They go with bulging pockets, looking for good buys. Sometimes they find them. But frequently, they wind up buying stuff they never anticipated buying, and it is merely deposited on a shelf in the basement for future use and is rarely ever heard of any more.

I suppose that I have scores of HF connectors that I wouldn't be able to use if I lived to be a hundred. And God alone knows how many linear feet of shrink tubing and spaghetti, how much stranded #14 copperweld, how many meters, relays, tube sockets, rf chokes, capacitors, resistors, packets of electronic hardware, rubber grommets, nibblers, wire strippers, phone plugs and jacks, test leads, antenna traps, baluns, and other assorted "junk" I have squirreled away in my cellar! Why, I must have ten cigar boxes full of porcelain egg insulators alone!

Almost all of that stuff was bought at flea markets, and I will probably buy a lot more of it in ensuing years.

Tell me something if you can: What makes an otherwise intelligent guy go into the pot for over a dozen lapel badges? I have so many of the danged things that I can never make up my mind which one to wear. But I'll bet that the very next flea market I attend, if one of those birds is there grinding out call-

sign badges, I'll buy another! I'll see one in a color I don't have or with a couple of flickering LEDs, and there'll go another couple of bucks!

Of course, the worst part is that after you bring this stuff home, you put it in a special place so that you'll be able to lay your hands on it when you have to use it, and then you can't remember where you put it. I'm still looking for a whole box full of zeners that I stashed away for safekeeping about four years ago. I've turned the place upside down and I just can't find them.

Flea markets are viewed by some people as a golden opportunity to unload what can only be described as useless junk. They don't represent it as such, of course; that would be cutting off their nose to spite their face. I wish I had a ten spot in my pocket right this minute for every piece of equipment someone intends to take to a flea market to sell, even though he is quite aware that there is something drastically wrong with it. But this fact will be concealed so that he can "sandbag" some willing sucker. Burned-out transformers, shorted components, kits assembled with wiring errors and cold solder joints, you name it. It's par for the course.

That's why everyone who goes to a flea market ought to remember to bear the old warning *caveat emptor* constantly in mind. Some sponsoring groups have had so many complaints that they have taken to displaying a large sign: "The XYZ Amateur Radio Club makes no warranties in respect to the condition of items bought or sold. All transactions are subject to the discretion of buyers, and the

club is neither directly nor indirectly responsible."

But I have another thought, and I'm not at all sure I'm incorrect about it. The good Lord must have made gullible pigeons for some purpose or another, and if they are dumb enough to allow themselves to be taken, it is probably what they deserve.

The reason this postulate doesn't disturb me is that many years of observance and experience have taught me that chiselers cannot cheat anyone who is not himself looking for an opportunity to chisel. Those who believe in dealing honestly are much harder to cheat than those who wouldn't hesitate to pull something a bit shady themselves. If you tend to doubt this, just take a look at the video tapes brought to light in the Abscam mess. Who fell for the sting operation that was set up by the FBI? You don't suppose for a moment that any scrupulously honest senator or congressman would have allowed himself to be enticed into a meeting in some seedy motel room with an Arab oil sheik, do you?

So, by all means, attend flea markets. Buy and sell to your heart's content. And if it should happen that you get stung, well, there's always another one where you might find the buy of a lifetime. I once bought a Collins 32V-2 and had the strange sensation that I was being watched. I opened the rig up and there in the rf cage I found an electrocuted field mouse... his beady little black eyes were open, staring right into mine!

You never can tell what sort of a bonanza you might run into!

RTTY LOOP

from page 18

33 should go up fairly easily, with just about any modern demodulator. I would check the ads here in 73 for something that appeals to you. Anyone who has a 32 on the air might drop George a note at 32-D Martha Drive, Rockland, Massachusetts 02370.

And now, a bit of a tease. I am currently evaluating one of the "new breed" RTTY units. This

thing will speak Baudot, ASCII, and Morse at any reasonable speed, convert codes, and store data on tape. Its microcomputer brain is user accessible, so new functions can be devised. One of the cutest is sending SSTV signals with no other equipment! Want a hint? It is made by a company here in the Free State, and it is advertised in 73. Watch for the full review, as always with both the good and the bad, in next month's RTTY Loop.

OSCAR ORBITS

Courtesy of AMSAT

The OSCAR satellites are subject to atmospheric drag, of course, and the present period of intense solar activity has accentuated the problem. During this period, our sun has been expelling huge numbers of charged particles, some of which find their way into the Earth's upper atmosphere, increasing the density (and thus the drag) there. It is through this region that the OSCARs must pass. OSCAR 8, in a lower orbit than OSCAR 7, is the more seriously affected of the two.

If the drag factor is not considered when OSCAR calculations are performed, long-range orbital projections will be in error. For example, by the end of 1979, OSCAR 8 was more than 20 minutes ahead of some published schedules. The nature of orbital mechanics is such that extra drag on a satellite causes it to move into a lower orbit, resulting in a shorter orbital period. Thus, the satellite arrives above a given Earthbound location earlier than predicted.

Using data supplied to us by Dr. Thomas A. Clark W3IWI of AMSAT, the equatorial crossing tables shown here were generated with the aid of a TRS-80™ microcomputer. The tables take into account the effects of atmospheric drag and should be in error by a few seconds at most.

The listed data tells you the time and place that OSCAR 7 and OSCAR 8 cross the equator in an ascending orbit for the first time each day. To calculate successive OSCAR 7 orbits, make a list of the first orbit number and the next twelve orbits for that day. List the time of the first orbit. Each successive orbit is 115 minutes later (two hours less five minutes). The chart gives the longitude of the day's first ascending (northbound) equatorial crossing. Add 29° for each succeeding orbit. When OSCAR is ascending on the other side of the world from you, it will descend over you. To find the

equatorial descending longitude, subtract 166° from the ascending longitude. To find the time OSCAR 7 passes the North Pole, add 29 minutes to the time it passes the equator. You should be able to hear OSCAR 7 when it is within 45 degrees of you. The easiest way to determine if OSCAR is above the horizon (and thus within range) at your location is to take a globe and draw a circle with a radius of 2450 miles (4000 kilometers) from your QTH. If OSCAR passes above that circle, you should be able to hear it. If it passes right overhead, you should hear it for about 24 minutes total. OSCAR 7 will pass an imaginary line drawn from San Francisco to Norfolk about 12 minutes after passing the equator. Add about a minute for each 200 miles that you live north of this line. If OSCAR passes 15° east or west of you, add another minute; at 30°, three minutes; at 45°, ten minutes. Mode A: 145.85-95 MHz uplink, 29.4-29.5 MHz downlink, beacon at 29.502 MHz. Mode B: 432.125-175 MHz uplink, 145.975-925 MHz downlink, beacon at 145.972 MHz.

At press time, OSCAR 7 was scheduled to be in Mode A on odd numbered days of the year and in Mode B on even numbered days. Monday is QRP day on OSCAR 7, while Wednesdays are set aside for experiments and are not available for use.

OSCAR 8 calculations are similar to those for OSCAR 7, with some important exceptions. Instead of making 13 orbits each day, OSCAR 8 makes 14 orbits during each 24-hour period. The orbital period of OSCAR 8 is therefore somewhat shorter: 103 minutes.

To calculate successive OSCAR 8 orbits, make a list of the first orbit number (from the OSCAR 8 chart) and the next thirteen orbits for that day. List the time of the first orbit. Each successive orbit is then 103 minutes later. The chart gives the longitude of the day's first ascending equatorial crossing. Add 26° for each succeeding orbit. To find the time OSCAR 8 passes the North Pole, add 26 minutes to the time it crosses the equator. OSCAR 8 will cross the imaginary San Francisco-to-Norfolk line about 11 minutes after crossing the equator. Mode A: 145.85-95 MHz uplink, 29.4-29.50 MHz downlink, beacon at 29.40 MHz. Mode J: 145.90-146.00 MHz uplink, 435.20-435.10 MHz downlink, beacon on 435.090 MHz.

OSCAR 8 is in Mode A on Mondays and Thursdays, Mode J on Saturdays and Sundays, and both modes simultaneously on Tuesdays and Fridays. As with OSCAR 7, Wednesdays are reserved for experiments.

OSCAR 7 ORBITAL INFORMATION FOR JANUARY

ORBIT #	DATE	TIME (GMT)	EQ. CROSSING (DEGREES WEST)
28042	1	0131:05	98.7
28054	2	0030:23	83.5
28067	3	0124:37	97.1
28079	4	0023:55	82.0
28092	5	0110:09	95.6
28104	6	0017:27	88.4
28117	7	0111:41	94.0
28129	8	0010:59	78.8
28142	9	0105:14	92.4
28154	10	0004:31	77.3
28167	11	0050:46	90.9
28180	12	0153:00	104.4
28192	13	0052:18	89.3
28205	14	0146:32	102.9
28217	15	0045:50	87.7
28230	16	0140:04	101.3
28242	17	0039:22	86.2
28255	18	0133:36	99.8
28267	19	0032:54	84.6
28280	20	0127:09	98.2
28292	21	0026:26	83.0
28305	22	0120:41	96.6
28317	23	0019:58	81.5
28330	24	0114:13	95.1
28342	25	0013:30	79.9
28355	26	0107:45	93.5
28367	27	0007:03	78.3
28380	28	0101:17	91.9
28392	29	0000:35	76.8
28405	30	0054:49	90.4
28418	31	0149:03	103.9

OSCAR 8 ORBITAL INFORMATION FOR JANUARY

ORBIT #	DATE	TIME (GMT)	EQ. CROSSING (DEGREES WEST)
14402	1	0057:44	71.6
14416	2	0102:29	72.8
14430	3	0107:13	74.0
14444	4	0111:58	75.3
14458	5	0116:43	76.5
14472	6	0121:27	77.7
14486	7	0126:12	78.9
14500	8	0130:56	80.1
14514	9	0135:40	81.3
14528	10	0140:25	82.5
14541	11	0001:57	57.9
14555	12	0006:42	59.2
14569	13	0011:26	60.4
14583	14	0016:10	61.6
14597	15	0020:54	62.8
14611	16	0025:38	64.0
14625	17	0030:23	65.2
14639	18	0035:07	66.4
14653	19	0039:51	67.6
14667	20	0044:35	68.9
14681	21	0049:19	70.1
14695	22	0054:03	71.3
14709	23	0058:46	72.5
14723	24	0103:30	73.7
14737	25	0108:14	74.9
14751	26	0112:58	76.1
14765	27	0117:42	77.3
14779	28	0122:25	78.5
14793	29	0127:09	79.8
14807	30	0131:53	81.0
14821	31	0136:36	82.2

OSCAR 7 ORBITAL INFORMATION FOR FEBRUARY

ORBIT #	DATE	TIME (GMT)	EQ. CROSSING (DEGREES WEST)
28430	1	0048:21	88.8
28443	2	0142:35	102.4
28455	3	0041:53	87.2
28468	4	0136:07	100.8
28480	5	0035:25	85.7
28493	6	0129:39	99.3
28505	7	0028:57	84.1
28518	8	0123:11	97.7
28530	9	0022:29	82.5
28543	10	0116:43	96.1
28555	11	0016:01	81.0
28568	12	0110:15	94.6
28580	13	0009:32	79.4
28593	14	0103:47	93.0
28605	15	0003:04	77.8
28618	16	0057:19	91.4
28631	17	0151:33	105.0
28643	18	0050:50	89.9
28656	19	0145:05	103.4
28668	20	0044:22	88.3
28681	21	0138:37	101.9
28693	22	0037:54	86.7
28706	23	0132:08	100.3
28718	24	0031:26	85.2
28731	25	0125:40	98.8
28743	26	0024:58	83.6
28756	27	0119:12	97.2
28768	28	0018:30	82.0

OSCAR 8 ORBITAL INFORMATION FOR FEBRUARY

ORBIT #	DATE	TIME (GMT)	EQ. CROSSING (DEGREES WEST)
14835	1	0141:20	83.4
14848	2	0002:52	58.0
14862	3	0007:35	60.0
14876	4	0012:19	61.2
14890	5	0017:02	62.4
14904	6	0021:45	63.6
14918	7	0026:29	64.8
14932	8	0031:12	66.1
14946	9	0035:55	67.3
14960	10	0040:39	68.5
14974	11	0045:22	69.7
14988	12	0050:05	70.9
15002	13	0054:48	72.1
15016	14	0059:31	73.3
15030	15	0104:14	74.5
15044	16	0108:57	75.7
15058	17	0113:40	76.9
15072	18	0118:23	78.1
15086	19	0123:06	79.3
15100	20	0127:49	80.6
15114	21	0132:32	81.8
15128	22	0137:15	83.0
15142	23	0141:57	84.2
15155	24	0003:29	59.6
15169	25	0008:11	60.8
15183	26	0012:54	62.0
15197	27	0017:36	63.2
15211	28	0022:19	64.4

MODEL II



11% DISCOUNT
Off List

64K 1 DRIVE \$3440.00

No Taxes on Out of State Shipments

Immediate Shipment On Most Items

\$ DISCOUNT \$ TRS-80® DEALER A301

COMPUTER SPECIALISTS

26-3001 4K Color.....	\$360.00
26-1145 RS-232 Board.....	84.00
26-1140 "O" K Interface.....	249.00
26-1160 Mini Disk.....	419.00
26-1171 Telephone Modem.....	169.00
Fast 100 CPS Centronics 730 Printer.....	659.00
Text Quality Centronics 737 Printer.....	819.00
CAT Modem.....	149.00

1-800-841-0860 Toll Free Order Entry
MICRO MANAGEMENT SYSTEMS, INC. ✓ 313

DOWNTOWN PLAZA SHOPPING CENTER
115 C SECOND AVE. S.W.
CAIRO, GEORGIA 31728
GA. PHONE NO. (912) 377-7120

FREE
COMPUTER
CATALOG
UPON
REQUEST



26-1062 4K I.....	\$630.00
26-1062 16K III.....	888.00
26-1063 32K III	
2-Drives, RS232.....	2225.00

Largest Inventory in S.E. U.S.A.

A KLM K

Handie
MORE POWER TO YOU!



✓ 40

KLM's NEW MA-35BL Power Amplifier
35W out, Preamp, Nicad Charger!

A KLM K

KLM, P. O. Box 816, Morgan Hill, CA 95037

Chart of UNITED STATES AMATEUR RADIO PRIVILEGES

by class of license, emission type, and frequency from 160 thru 2 meters, including provision for the new 30, 17, and 12 meter bands. This 22 x 28 in, twelve-color chart is the first of its kind to be both informative and decorative.

Be certain about WHO gets to do WHAT, and WHERE! Enhance your shack! Regular price \$3.00. Includes postage and handling.

Larry Dennison—KB6KG
5002 Marion Avenue
Torrance, California 90505

Radio World

CENTRAL NEW YORK'S MOST COMPLETE HAM DEALER







ROBOT 800 ICOM IC-720 KENWOOD TS830S DRAKE TR7-DR7 YAESU FT707

Featuring Kenwood, Yaesu, Icom, Drake, Ten-Tec, Swan, Dentron, Alpha, Robot, MFJ, Tempo, Astron, KLM, Hy Gain, Mosley, Larsen, Cushcraft, Hustler, Mini Products, Bird, Mirage, Vibroplex, Bencher, Info-Tech, Universal Towers, Callbook, ARRL, Astatic, Shure. *We service everything we sell!*

Write or call for quote. **You Won't Be Disappointed.** ✓ 397

We are just a few minutes off the NYS Thruway (I-90) Exit 32

OUT OF STATE CALL TOLL FREE **800-448-9338**

ONEIDA COUNTY AIRPORT TERMINAL BUILDING
ORISKANY, NEW YORK 13424
N.Y. Res. Call (315) 337-0203 or 736-0470

Warren - K2IXN
Bob - WA2MSH

✓ 365

name _____

address _____

city _____

state _____ zip _____

MIDCOM

DEAL WITH #1!

CARLOAD INVENTORIES • ROCK BOTTOM PRICES

24-HOUR SERVICE

AEV	ALPHA	CUSHCRAFT	DENTRON	KLM	MOR GAIN	PALOMAR ENG.	UNIVERSAL
AVANTI	BEARCAT	COLLINS	HY GAIN	KENWOOD	MIRAGE	REGENCY	UNARCO-ROHN
ASTRON	BIRD	CDE	HUSTLER	MICROLOG	MFJ	SWAN	VIBROPLEX
ALLIANCE	BENCHER	DRAKE	ICOM	MINI-PRODUCTS	NYE	TEN TEC	

CALL TOLL FREE 1-800-325-3609 IN MISSOURI 314-961-9990

MID-COM ELECTRONICS • 8516 MANCHESTER ROAD • BRENTWOOD, MO 63144

✓ 52

NEW PRODUCTS

HEATH CONTINUING EDUCATION OFFERS NEW ADVANCED ELECTRONICS PROGRAMS

Heath Continuing Education, a division of Heath Company, has introduced a series of three new learn-at-home electronics programs. Each program covers an advanced electronic subject.

All three programs use programmed self-instruction textbooks that present the subject matter in easy, "bite-sized" segments. They come complete with electronic parts for optional hands-on experiments.

Operational Amplifiers, EE-101, covers the fundamentals of this commonly-used integrated circuit family, including the popular Norton and BiFET designs. The Active Filters program, EE-102, covers the design, operation, and uses of active filters. It describes low-pass, high-pass, bandpass, and state-variable filters, as well as others. The Phase-Locked Loops program, EE-104, discusses the uses, designs, and operation of PLLs. Phase-locked loops are widely used in television receivers, FM receivers, CB and 2-meter transceivers, industrial telemetry circuits, and motor controls.

For further information, con-

tact *Heath Continuing Education, Dept. 350-160, Benton Harbor MI 49022. Reader Service number 483.*

BENJAMIN MICHAEL INDUSTRIES' MODEL 173A STATION CLOCK

Benjamin Michael Industries has announced the introduction of the Model 173A station clock. The 173A provides the proper 24-hour military time format used by serious communications operators when logging transmissions or verifying contacts and reports. The unit allows the operator to directly read GMT and avoid the confusion created by various local time zones.

The 173A features quartz-crystal accuracy and greater than one year operation from a single penlight battery. Battery operation eliminates the need to reset the clock after power line failures and makes the unit ideal for mobile, field, and emergency power operations.

Time setting is accomplished by the use of two push-buttons and a hold switch which stops the clock operation and resets the internal seconds counter to zero for precise setting to WWV or other time standards. The



Benjamin Michael Industries' Model 173A station clock.

unit is housed in an attractive aircraft instrument style case.

For further information, contact *Benjamin Michael Industries, PO Box 173, Prospect Hts. IL 60070. Reader Service number 480.*

KANTRONICS' VARIFILTER™

You can vary the frequency and the bandwidth of the Varifilter™, a new addition to Kantronics' line of products. The Varifilter can be set to maximize one signal (peaking) or to minimize an interfering signal (notching), and it works with CW (Morse), single-sideband, and AM signals. The Varifilter circuitry is designed to provide optimum results without ringing, oscillating, or instability.

The bandwidth is variable

from less than 30 Hz to over 1000 Hz. The frequency range runs from less than 150 Hz to over 3000. Once it has been set, the bandwidth will remain constant regardless of changes in the frequency range setting. This feature has not been readily available in variable filters until now.

The Varifilter has its own internal power supply which is switchable from 115 V ac to 230 V ac. It is able to run from 12 to 18 V dc as well. Each unit has a tuning eye that lets the operator see when he has filtered the signal he wants to.

For further information, contact *Kantronics, Inc., 1202 E. 23rd Street, Lawrence KS 66044.*

NEW IC DISPENSERS

OK Machine and Tool Corpor-



Heath's Phase-Locked Loops program.

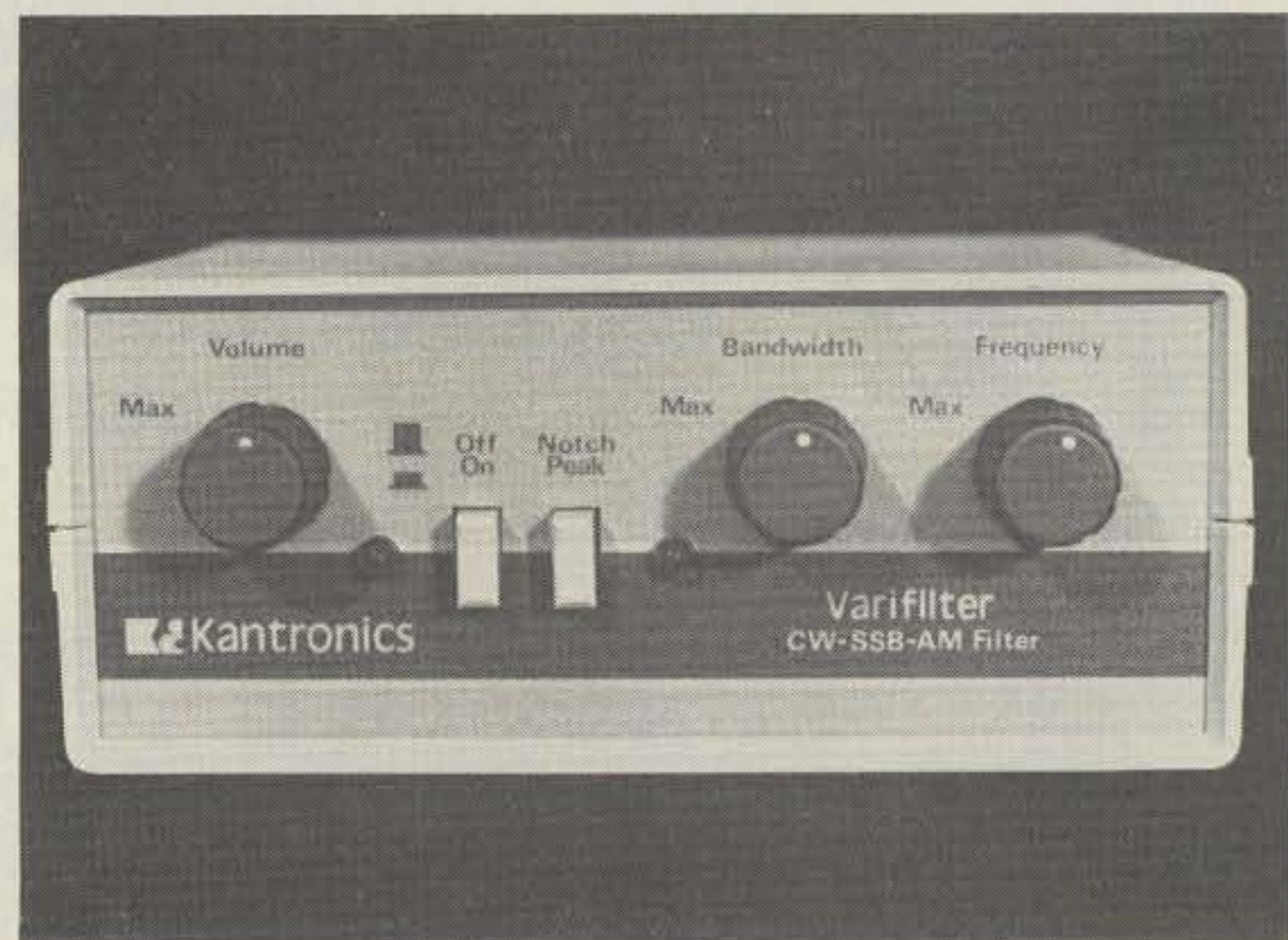

Kantronics' Varifilter™.

headsets

New Headsets With Selectable Microphone Impedance

When traffic is heavy and the session is long, you need the comfort and efficiency of a Telex headset. The new ProCom 300 and ProCom 200 provide hands-free operation and the exact mike-to-mouth distance for consistent and reliable VOX operation.

ProCom 300

The ultimate in comfort, the ProCom 300 is an ultra-light, single-sided, aviation style headset with a powerful, electret noise-cancelling microphone. This dual impedance microphone has a 200 to 3500 Hz frequency response specifically tailored to the human voice. The earphone has a low impedance, dynamic element with a sensitive tailored frequency response of 300 to 3000 Hz.

ProCom 200

This dual muff headset has a powerful, dual-impedance, electret microphone with a typical frequency response of 200 to 3500 Hz. The dynamic, low impedance headphone has a very sensitive 200 to 12000 Hz frequency response.

Footswitch (FS-1) and handswitch (HS-1) accessories or the built-in VOX select switch provide total professional flexibility. Write for complete details today.

TELEX hy-gain

TELEX COMMUNICATIONS, INC.

3600 Astor Ave. So., Minneapolis, MN 55420 U.S.A.
Europe: 22, rue de la Légion d'Honneur, 93200 St. Denis, France

Tower shown is
The NEW Hy-Gain
HG-52SS
Self Supporting
Crank-Up Tower

ation has introduced its new MDD series of DIP IC dispensers for MOS and CMOS as well as standard devices. The dispensers offer flexibility and convenience to such a unique degree that they are patented. Each channel easily accepts any standard IC shipping tube and can accommodate any standard IC from 2 to 64 pins on .300, .400, or .600 centers.

Adjustable guides position each IC individually for easy extraction, and simple gravity feed ensures reliable deposit of next IC into extraction position after previous IC is removed. Ruggedly made of unique conductive carbon-filled thermoplastic with steel supports, the MDD design ensures effective static dissipation (a grounding lug is included) as well as long and reliable performance. Available in 1-, 5-, and 10-channel versions, the dispensers will greatly facilitate any IC handling or PCB assembly process.

For further information, contact *OK Machine and Tool Corporation*, 3455 Conner Street, Bronx NY 10475; (212)-994-6600. Reader Service number 482.

WRAASE SC-422 SSTV SCAN CONVERTER

The SC-422 is a complete slow-to-fast and fast-to-slow scan converter. It has two full-size SSTV picture memories which can be used either independently to store two different pictures or together for improved picture definition of 256 pixels per line. Received pictures can also be stored in the two memories.

On transmission, a cursor is automatically inserted into the screen, indicating the portion of the SSTV picture being transmitted. The SC-422 allows you to display the fast scan content of the memory, for easy adjustment of the camera. SSTV picture transmission is not interrupted during adjustment of the camera and controls. A built-in SSTV output filter ensures a distortion-free sine wave output.

In the receive mode, a grey scale is inserted at the top of the picture to aid in the adjustment of brightness and contrast controls. An automatic "hold" circuit keeps the most recently received picture in memory when the SSTV input signal stops.

Continued on page 156

REVIEW

S-F MOD KITS

S-F Radio Amateur Services of Culver City, California, distributes a series of modification kits for the very popular Kenwood TS-820, and makes some pretty impressive improvement claims for them. Both the receiver and transmitter sections are addressed.

The four kits are a front end improvement, a balanced mixer improvement, a "high-power" (QRO) kit, and an rf compressor-to-clipper conversion.

Actually, the compressor-to-clipper modification is not W6TOG's work. It is produced by Magicom of Bellevue, Washington, and is included here with the others because all are related and all are available through S-F.

These kits are not inexpensive, ranging in price from \$27.50 to \$37.50. The total tab for all four is well over \$100. Are they worth it? Can the average ham install them? Without reducing the value of the transceiver? Maybe...read on.

The Front-End Modification

The advertising brochure claims rather remarkable improvements in sensitivity, noise figure, and immunity to rf overload. The kit, consisting of two diodes and two transistors, retails for \$34.50. The installation instructions are something less than Heathkit® quality, but with a bit of study, they are both adequate and accurate. A disclaimer in large print warns against installation by persons unfamiliar with solid-state circuitry. True, this is probably not a good first project for the beginner, but with ordinary skill and care, installation is not difficult. After all, how hard can it be to remove and install two transistors and two diodes?

Before installation, however, let's do a simple test. With the antenna input terminated to a 50-Ohm load, increase the af gain and check the noise level at the speaker. It is *loud*! With headphones, you probably won't get beyond 12 o'clock without discomfort. All of this racket is internal noise. Make a mental note of the level.

Probably the most difficult part of the installation is finding the transistors to be removed from the foil side of the rf board. The full-size photo in the TS-820 service manual was invaluable. Such a photo would be a useful addition to the installation instructions for the benefit of those who don't have the service manual. Once you find the right pads, removal and reinstallation takes only a few minutes.

The receiver realignment requires no external instruments and goes quickly once you find the right slugs to turn. Again, a photo or sketch with the instructions would be most helpful. Perhaps I'm being too fussy, but I really believe that a few photos or other pictorials might have cut installation time in half.

Does it work? Connect your 50-Ohm load to the antenna terminal, crank up the af gain, and listen to the internal noise again. Listen carefully, because there's not much noise left to hear. As for sensitivity, an improvement from 0.25 microvolts to 0.09 microvolts is claimed. I don't have the instrumentation to measure it, but there is an improvement. The original TS-820 used to run neck and neck with my SB-303 on weak-signal performance. Now, especially on 10 meters, the TS-820 hears signals that just aren't there on the SB-303.

The Balanced Mixer Mods

I was so pleased with the results of the front-end improvements that I decided to go ahead with the balanced mixer mods. This kit retails for \$27.50 and consists of two more transistors and several resistors. A substantial improvement in immunity from rf overload is claimed to result. This is particularly important to me, since I live within 500 feet of another ham who runs full legal power, and I've become accustomed to the distinctive sound of my S-meter needle pounding the pin on top of the scale. We simply can't operate simultaneously on the same band.

For practical purposes, installation is just about the same

as the front-end kit. The actual parts replacement takes less time than locating the parts to be removed, and, once again, a picture would be most helpful. If I had to do the job again, I surely would install both kits at once, since the rf board would have to be removed only once, and ditto the receiver realignment.

This time when you listen for internal noise, listen very, very carefully. In my installation, there is virtually none. It was so quiet I was almost afraid the radio wasn't working. On the air, weak signals just seem to pop out of an almost silent background. More recently, this advantage has been lost to a noisy power line, but certainly not through any fault of the balanced mixer mods.

I wish the rf-overload problem had gone the same route as the internal noise, but not quite so. However, the situation is very much improved. I now can hear a relatively weak signal 10-15 kHz from the local ham's transmit frequency, and this is at least as much as I expected. We still can't operate the same band at the same time, but that's because I still do the same number on his receiver that he used to do on mine.

The QRO Kit

This kit retails for \$37.50, and consists of two 6293 tubes and several small components. The 6293 is a ruggedized version of the 6146 and is a direct pin-for-pin replacement. This modification consists of two separate operations. One involves raising the screen voltage, and the other changes the ALC time constant for better action.

The first part of the modification couldn't be easier. Move a wire, install two resistors, and replace the finals. A note of caution here—neutralize the new finals quickly! I turned on the radio to warm up and went to look for a non-metallic tool to make the adjustment. The new finals were so far out of neutralization that I returned just in time to see the fuse blow from all the plate current being drawn from self-oscillation. This may be an isolated case, but be careful anyway. The finals went downhill with the fuse and I thought I might have an expensive problem, but the folks at S-F solved that one by replacing the tubes at no charge. They are good people to do business with.

The ALC modifications in-

volve finding and replacing a resistor, a diode, and a capacitor on the rf board. These components are located in a less dense section of the board than the front end and balanced mixer. Thus, the job is relatively easier, even without pictures. This is another task that could easily be worked in with the front-end and balanced mixer mods, so that only one removal of the rf board would be required.

As it came from the factory, my TS-820 delivered 100 Watts output on 160 and 80 meters, 100 Watts on 40 through 15 meters, and less than 80 Watts on 10 meters. With the QRO mod, output was increased at least 25 Watts on all bands and nearly 35 Watts on 10 meters. Still more power is available by using 220 volts ac rather than 110. This brought output to 170 Watts on 160 and 80 meters, 150 Watts on 40 through 15, and an honest 140 Watts on 10 meters. Simply changing to 220 volts ac probably would have made a noticeable improvement even without the QRO kit. Also noticeable is the much faster ALC recovery.

The Magicom

This unit is a preassembled circuit board about two inches square, which sells for \$27.50. It converts the stock rf compressor to an rf clipper. While I have no reason to believe there is any connection, there is a striking similarity to the Magnum Six available a few years ago.

The Magicom board installs on the i-f board in a relatively open area near the crystal filter(s). If you have additional crystal filters installed, or have plans to do so, you may wish to consider relocating either the filters or the Magicom. Installation consists of removing two capacitors and connecting four leads from the Magicom.

The instructions warn that careful workmanship and sufficient study of the work are required. This is good advice. Parts density on the i-f board is high, and great care certainly is required. In this case, an exploded view of the foil side of the board is provided with the instructions and is worth its weight in gold. When the appropriate pads are found, installation is a snap.

Once installed, the Magicom lives up to its claims, but first a few words about my goals and expectations with respect to speech processing. I am not an

audio purist. I am a DXer. It's not nearly as important to me that the DX station enjoys the sound of my voice as it is that he can understand my call letters through a pileup. I'm perfectly willing to sacrifice tonal fidelity for penetrating intelligibility.

As it turns out, I sacrificed nothing with the Magicom. The same audiophiles who complained that my audio sounded "harsh" and "overprocessed" now report that it sounds much better. At the same time, the DXers who reported "weak" or "muffled" audio now find it to be far more penetrating.

So, is the whole thing worth it? If all your time on the air is spent rag chewing with solid-copy stations, it certainly is not. The stock TS-820 (and many other radios) will do the job very nicely without the extra expense and work. Strictly in terms of dollars per component, the price is steep. If you could identify all the components, you surely could buy them for a lot less. But remember, you're buying more than components. You're paying for many hours of someone's research and experimentation. For me, it's worth every penny.

Can the average ham install it? I think so. My technical skills are well on the low side of average. To provide a reference point, there's a local joke about the W4LVM School of (backward) Diode Installation. On the other hand, if you have difficulty recognizing a diode, maybe you should forget about it.

One distinct advantage is the absence of external signs of modification. There are no holes, nothing outboard, nothing to detract from resale value. In fact, the whole operation is easily reversible should you wish to do so. I don't ever plan to reverse it. In fact, if S-F should offer additional mods, I'll probably be one of the first in line.

For further information, contact *S-F Amateur Radio Services*, 4384 Keystone Ave., Culver City CA 90230. Reader Service number 477.

Wayne Mueller W4LVM
Roswell GA

AED SCANNERS

You have undoubtedly heard of Murphy's Law. OK, but have you heard of Orozco's postulate? I thought not! Well, simply stated, it says that the degree of dissatisfaction with one's own

hy-gain[®]

NEW VHF and UHF Mobiles

Hy-Gain's new HyCom series of UHF and VHF mobile antennas have been tested in actual use by amateurs across the U.S. for nearly two years with excellent results. The antennas have weathered the salt spray of the coast, the freezing rain and snow of the northlands, and the blazing sun of the desert southwest. HyCom's materials and workmanship have taken the worst that Mother Nature could dish out, and they still perform as if they were installed yesterday. If you want the finest mobile antenna that you can buy - with proven reliability - try a Hy-Gain HyCom.

HC-144-TLM (for 2-meters)

A 5/8 wave, trunk lip mobile antenna with less than 1.5:1 SWR across the 144-148 MHz band. Maximum power capability is a full 200 watts. Hy-Gain's exclusive screw-in antenna connector eliminates all installation soldering. Includes 18 ft. (5.5m) coax and connector.

HC-144-MAG (for 2-meters)

The same antenna as above except with a powerful 90 lb. (40.8kg) direct pull magnet mount with a neoprene gasket to protect your vehicle's finish.

HC-440-TLM (for 440-450 MHz)

This is a, trunk lip mount antenna featuring two 5/8 wave collinear radiators coupled with a moisture resistant phasing coil. SWR is less than 1.5:1 and maximum power capability is 200 watts. Antenna comes with Hy-Gain's exclusive screw-in antenna connector that eliminates all installation soldering and 18 ft. (5.5m) of coax and connector.

HC-440-MAG (for 440-450 MHz)

The same antenna as above except with a powerful 90 lb. (40.8kg) direct pull magnet mount with neoprene gasket to protect your vehicle's finish.

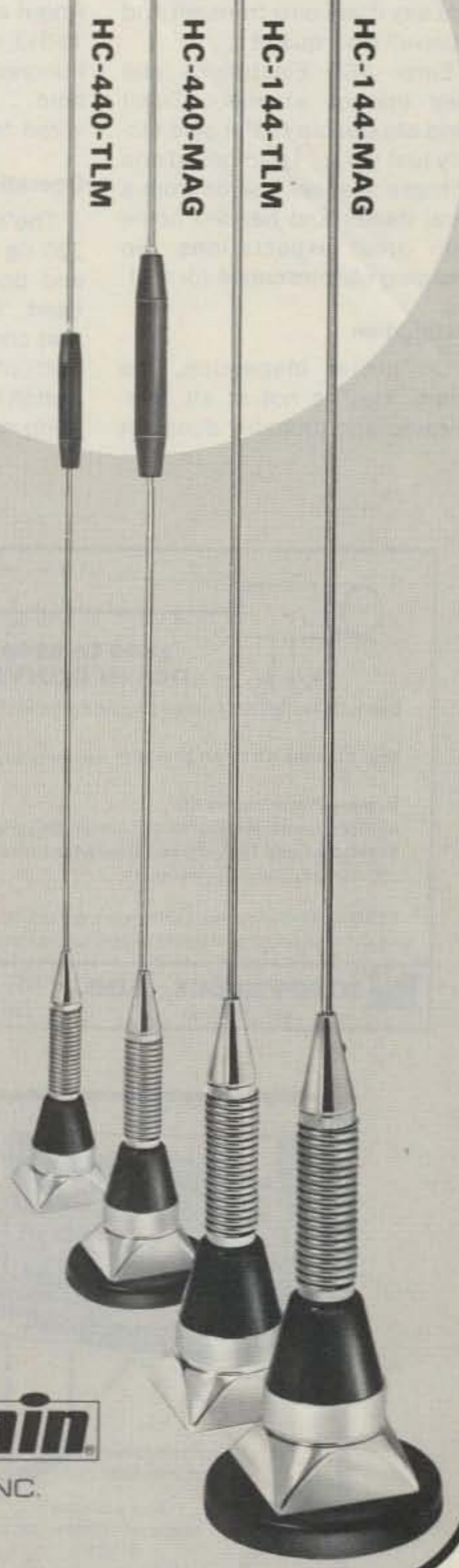

TELEX *hy-gain*

TELEX COMMUNICATIONS, INC.

9500 Aldrich Ave. So., Minneapolis, MN 55420 U.S.A.
Europe: 22, rue de la Légion d'Honneur, 93200 St. Denis, France

rig is directly proportional to the number of visits to the local candy store. As we watch the microprocessor come of age, we realize that if a particular rig exists, then it is obsolete! Only what is on the drawing boards is state of the art. If your transceiver doesn't have two vfos, six memories, three scanning modes, and the ability to poach your morning eggs, then it just isn't up to date!

Sad, but true. You drive home, looking at your once-current mobile rig, noticing its plain face and lack of dials and lights... how could this happen so fast! You say it will only transmit and receive? How quaint...

Enter AED Electronics and their line of scanners. Don't send old Dobbin to the glue factory just yet... I purchased one of these scanner boards from a local dealer and headed home with great expectations. No creeping obsolescence for me!

Installation

On closer inspection, the board itself is not at all complicated and probably does not

warrant the extra expenditure to purchase it fully assembled. Beyond that, all installation and operation instructions are both complete and easy to read. The circuit board is tailored to fit in your particular radio with no modification whatsoever. A few wiring connections to the rotary frequency-control switch and to the PLL section were all that were required. I had only to decide for myself where to put the two toggle switches that control the scanning functions. There was even a provision for older transceivers that had only the two-position power switch. About an hour later, my Midland 13-513 was ready for the time-honored smoke test. Lo and behold... no cold solders or miswired leads!

Operation

The scanner for the Midland 220 rig is very easy to operate and does its job very well indeed. There are two switches that control the operation of the microprocessor chip. The first switch either leaves the rig operating normally or puts it in the

scan mode. The second one allows it to scan the MHz section selected or will stop it on the current frequency to transmit or receive. That's all there is to it. While scanning the section of the band selected, it will stop for about eight seconds on any frequency that will break the squelch, giving you time to lock it there if you wish. If you don't, it will continue its scan *ad infinitum*. On my unit, the return time to a particular frequency, barring any interruption, is about 16 seconds more than sufficient to catch the action. As warned in the instructions, you must set the frequency to zero-zero (i.e., 224.00) to have it scan normally. Yes, I tried it with a random frequency in the window, and yes, it scans... but quite erratically. So much for experimentation!

Conclusions

I feel that this unit is a particularly valuable addition to the Midland 13-513, due to the fact that fully-synthesized 220 rigs are hard to find. This scanner increases the capabilities of an already very capable radio. Frequency scanning is well suited to the 220 band because of the long periods of silence encountered when monitoring just one frequency. It lets you monitor practically the whole band and participate when and where you wish. I am finding frequencies that I never knew existed. Have you ever heard someone say, "Let's QSY to the other one," and wonder where they went? Never again. Now, let's see... how can I squeeze another vfo into this case?

For More Information

These units are available for a wide range of 2-meter and 220

transceivers, and the price range starts at \$39.95. Scan rates, frequency coverage, and switch functions and configurations will vary from model to model. More information can be obtained from AED Electronics, 750 Lucerne Rd., Suite 120, Montreal, Quebec, Canada H3R 2H6. Reader Service number 476.

Dave Orozco WB6SMD
Coronado CA

AEA CK-1 MORSE MEMORY KEYS

For some time now, Advanced Electronic Applications, Inc., has been producing some unique and rather exciting products for the radio amateur. Whether the device be an autodialer, an antenna, or an electronic keyer, AEA's products have been injected with a healthy dose of careful research and solid engineering. The company's latest offering, the CK-1 Morse Memory Keyer, is certainly no exception. In a case just barely larger than a typical calculator, we are given a keyer with almost every feature that the dedicated or even not-so-dedicated CW operator could ask for. While it is perfectly possible to put the CK-1 on the air without ever opening the instruction book, you'll want to read and even reread the manual a few times in order to be able to take full advantage of the keyer's capabilities. Once you've figured everything out, you'll never want to part with it!

The first thing you notice about the CK-1 is its apparent simplicity. On top, there is a standard twelve-tone touchpad; it gives a reassuring tactile response to each entry, and an audio confirmation as well, through the tiny but adequate speaker which also is mounted on top. The only other control topside is the combination on-off switch/volume control. Be careful! When you turn the unit off, you erase everything you have programmed into the keyer's memories. Fortunately, AEA assures us that the keyer is designed to be left on continuously.

On the left side of the case is the only other switch on the keyer; this selects either the memory-send or the memory-load mode. On the opposite side of the keyer is a non-shorting, power-input jack.

AEA specifies the unit as requiring 12 V dc \pm 3 volts, which is quite reasonable in light of the fact that everything but the side-



**1800 to 2500 MHZ
DOWN CONVERTER**

Down Converter Kit Printed Circuit Board with all parts for assembly \$38.50

Yagi Antenna Kit 22 db gain with weatherproof Shielded enclosure \$40.00

Tunable Power Supply Kit \$24.95

Antenna Cookbook Tested and proven designs \$ 9.95

Assembled and Tested Down Converter with 50' RG59 cable with 75 to 300 ohm adapter ready to install \$175.00

TERMS: We will accept COD orders for \$25.00 and over. All orders sent First Class on UPS. Prepaid orders we pay shipping.

Microverter, Inc. ✓ 395 P.O. BOX 1267
617-329-7493 DEDHAM, MA 02026

... at last ...
your shack organized!

A beautiful piece of furniture — your XYL will love it!

\$16450 S-F RADIO DESK
Deluxe - Ready to Assemble

Designed with angled rear shelf for your viewing comfort and ease of operation.

FINISHES: Walnut or Teak Stain.

Floor Space: 39" Wide by 30" Deep

Additional Information on Request.

Checks, Money Orders, BankAmericard and Master Charge Accepted.

F.O.B. Culver City. (In Calif. Add 6% Sales Tax.)

— DEALER INQUIRIES INVITED —

S-f Amateur Radio Services

4384 KEystone AVENUE • CULVER CITY, CALIF. 90230 — PHONE (213) 837-4870



Radio equipment not included

Also Available
Floor Space: 51" Wide by 30" Deep
\$192.50

desk & hand microphones

These mics are a luxury that you deserve



AMB 77

AMM 46

Serious amateurs deserve the very best equipment they can afford and one person's luxury may be another's necessity. These mics are a little like that. If you deserve a microphone with extra high output, a frequency response carefully tailored to the voice range, and made of high quality materials, then here are three new desk mics and three new hand mics from which to choose. The desk mics are heavy die cast metal with an attractive black, textured finish and a lock lever on the push-to-talk bar for VOX operation. The hand mics are high impact resistant Cylolac[®] with extra long, high quality, neoprene coil cords. Most models are dual impedance.

	DESK MICROPHONES			HAND MICROPHONES		
	AMB 75	AMB 76	AMB 77	AMM 45	AMM 46	AMM 47
ELEMENT TYPE	DYNAMIC	DYNAMIC	DYNAMIC (AMPLIFIED)	DYNAMIC	DYNAMIC	DYNAMIC (AMPLIFIED)
POLAR PATTERN	OMNI	CARDIOID	CARDIOID	OMNI	NOISE CANC.	OMNI
IMPEDANCE (HIGH Z)	50K ohms	50K ohms	4000 ohms	50K ohms	50K ohms	
IMPEDANCE (LOW Z)	200 ohms	200 ohms		470 ohms	470 ohms	200 ohms
OUTPUT LEVEL (HIGH Z)	-55 dB	-58 dB	ADJUSTABLE TO 20 dB	-54 dB	-54 dB	
OUTPUT LEVEL (LOW Z)	-75 dB	-80 dB		-75 dB	-75 dB	-45 dB
FREQUENCY RESPONSE	200-8000 Hz	100-13000 Hz	150-5000 Hz	200-4000 Hz	200-4000 Hz	200-5000 Hz
CABLE	5 cond. 1 shield	5 cond. 1 shield	5 cond. 1 shield	6 cond. 2 shield	6 cond. 2 shield	5 cond. 1 shield
POWER SOURCE			BATTERY PROVIDED			EXTERNAL DC

OUTPUT LEVEL MEASURED (0 dB = 1 Volt Per Microbar)

TELEX *hy-gain*

TELEX COMMUNICATIONS, INC.

9600 Aldrich Ave. So., Minneapolis, MN 55420 U.S.A.
Europe: 22, rue de la Légion-d'Honneur, 93200 St. Denis, France.

Continued on page 157

WILSON SYSTEMS, INC. MULTIBAND ANTENNAS

WV-1A **\$59⁹⁵** FACTORY DIRECT 4 BAND TRAP VERTICAL (10 - 40 METERS)

No bandswitching necessary with this vertical. An excellent low cost DX antenna with an electrical quarter wavelength on each band and low angle radiation. Advanced design provides low SWR and exceptionally flat response across the full width of each band.

Featured is the Wilson large diameter High-Q traps which will maintain resonant points with varying temperatures and humidity.

Easily assembled, the WV-1A is supplied with a hot dipped galvanized base mount bracket to attach to vent pipe or to a mast driven in the ground.

NOTE: Radials are required for peak operation. (See GR-1 below)

SPECIFICATIONS

- 19' total height
- Self supporting—no guys required
- Weight — 14 lbs.
- Input impedance: 50 Ω
- Powerhandling capability: Legal Limit
- Two High-Q traps with large diameter coils
- Low angle radiation
- Omnidirectional performance
- Taper swaged aluminum tubing
- Automatic bandswitching
- Mast bracket furnished
- SWR: 1.1:1 or less on all bands

GR-1 **\$12⁹⁵**

The GR-1 is the complete ground radial kit for the WV-1A. It consists of 150' of 7/14 stranded aluminum wire and heavy duty egg insulators, instructions. The GR-1 will increase the efficiency of the WV-1A by providing the correct counterpoise.

33-6 MK **\$59⁹⁵**

Now you can have the capabilities of 40-meter operation on the SYSTEM 36 and SYSTEM 33. Using the same type high quality traps, the 40-meter addition will offer 150 KHZ of bandwidth at less than 2:1 SWR. The new 33-6 MK will fit your present SY36, SY33, or SY3 and use the same single feed line. The 33-6 MK adds approximately 15' to the driven element of your tri-bander, increasing the tuning radius by 5 to 6 feet. This addition will offer an effective rotatable dipole at the same height of your beam.

SY-40A **\$337⁹⁵**

- ★ 3 MONOBANDERS on 1 Boom
- 4 elements on 20 mtrs FULL SIZE
- 4 elements on 15 mtrs
- 5 elements on 10 mtrs

The System 40A is the answer to the DXer who does not have space to stack monobanders yet wants the advantages they offer. Through the use of a switchable matching unit, only one feed line is required and complete coverage of both the phone and cw bands are available with only one setting.

SPECIFICATIONS

Max. Pwr. Input..... Legal Limit	Matching Method..... Split Beta	Surface Area..... 12.1 sq.ft.
VSWR @ Res..... 1.2:1	F/B Ratio..... 25 db	Wind Loading @ 80 mph..... 309 lbs.
Impedance..... 50 ohm	Boom..... 2" x 26'	Assem. Weight..... 75 lbs.
Feed Method..... Balun Supplied	Longest Element..... 36'	Shipping Weight..... 84 lbs.
Gain..... 10 on 15, 20; 12 on 10	Turning Radius..... 22'6"	

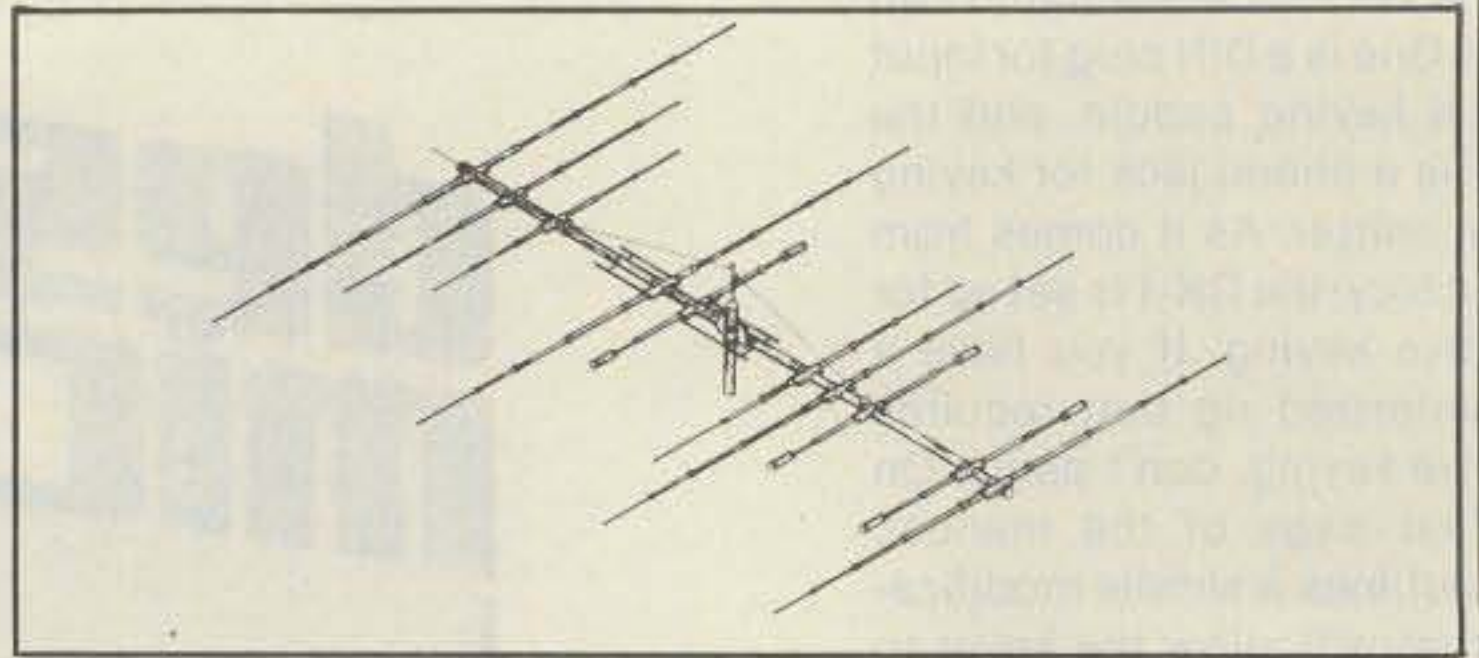

SY-36 **\$199⁹⁵**

A trap loaded antenna that performs like a mono-bander! That's the characteristic of this six element three band beam. Through the use of wide spacing and interlacing of elements, the following is possible: three active elements on 20, three active elements on 15, and four active elements on 10 meters. No need to run separate coax feed lines for each band, as the bandswitching is automatically made via the High-Q Wilson traps. Designed to handle the maximum legal power, the traps are capped at each end to provide a weather-proof seal against rain and dust. The special High-Q traps are the strongest available in the industry today.

SPECIFICATIONS

Band MHz..... 14-21-28	Boom (O.D. x Length)..... 2" x 24'2 1/2"	Wind Loading @ 80 mph..... 215 lbs.
Maximum Power Input..... Legal Limit	Number of Elements..... 6	Maximum Wind Survival..... 100 mph
Gain (dBd)..... 9 dB	Longest Element..... 29'6 1/2"	Feed Method..... Coaxial Balun (Supplied)
VSWR @ Resonance..... 1.3:1	Turning Radius..... 18'6"	Assembled Weight (approx)..... 53 lbs.
Impedance..... 50 ohm	Maximum Mast Diameter..... 2"	Shipping Weight (approx.)..... 62 lbs.
F/B Ratio..... 20 dB or better	Surface Area..... 8.6 sq. ft.	

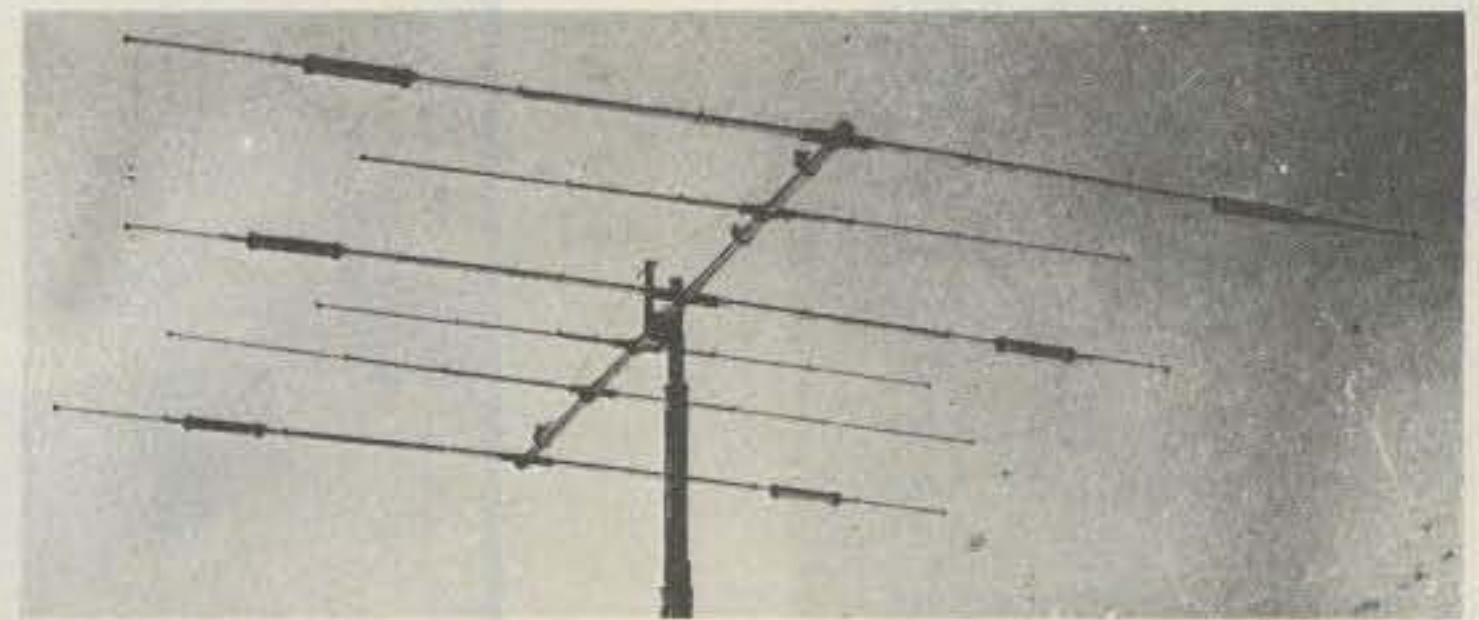

SY-33 **\$149⁹⁵**

Capable of handling the Legal Limit, the SYSTEM 33 is the finest compact tribander available to the amateur. Designed and produced by one of the world's largest antenna manufacturers, the traditional quality of workmanship and materials excels with the SYSTEM 33. New boom-to-element mount consists of two 1/8" thick formed aluminum plates that will provide more clamping and holding strength to prevent element misalignment. Superior clamping power is obtained with the use of a rugged 1/4" thick aluminum plate for boom to mast mounting. The use of large diameter High-Q Traps in the SYSTEM 33 makes it a high performance tri-bander and at a very economical price. A complete step-by-step illustrated instruction manual guides you to easy assembly and the lightweight antenna makes installation of the SYSTEM 33 quick and simple.

SPECIFICATIONS

Band MHz..... 14-21-28	Boom (O.D. x Length)..... 2" x 14'4"	Wind Loading @ 80 mph..... 114 lbs.
Maximum Power Input..... Legal Limit	Number of Elements..... 3	Assembled Weight (approx)..... 37 lbs.
Gain (dBd)..... 8 dB	Longest Element..... 27'4"	Shipping Weight (approx)..... 42 lbs.
VSWR at Resonance..... 1.3:1	Turning Radius..... 15'9"	Direct 52 ohm feed..... No Balun Required
Impedance..... 50 ohm	Maximum Mast Diameter..... 2" O.D.	Maximum Wind Survival..... 100 mph
F/B Ratio..... Up to 20 db	Surface Area..... 5.7 sq. ft.	

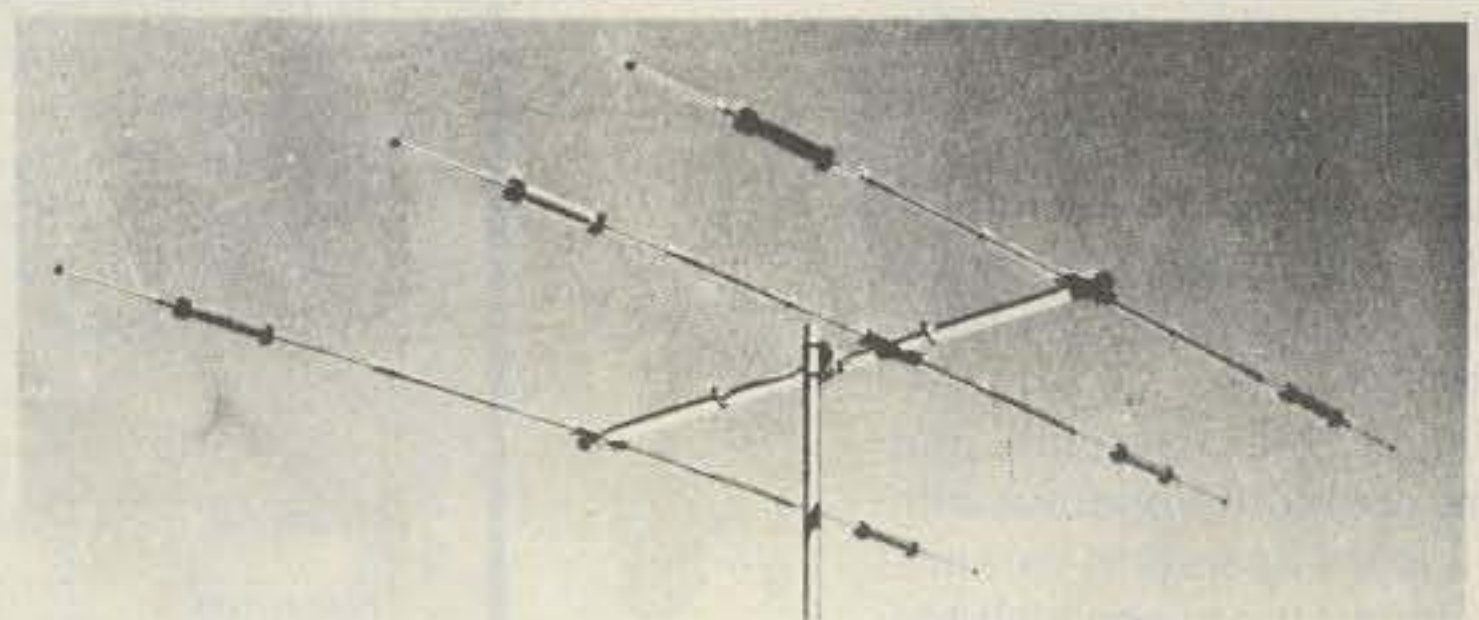

ORDER
FACTORY DIRECT
1-800-634-6898

Prices Effective 1-1-81 to 1-31-81

W S I WILSON
SYSTEMS, INC.

4286 S. Polaris Ave., Las Vegas, Nevada 89103

Prices and specifications subject to change without notice.

WILSON SYSTEMS TOWERS

61 FT. TOWERS

"NEW"

45 FT. TOWERS

ECONOMICAL TOWER KIT FOR 45' & 61' TOWERS

MT-61

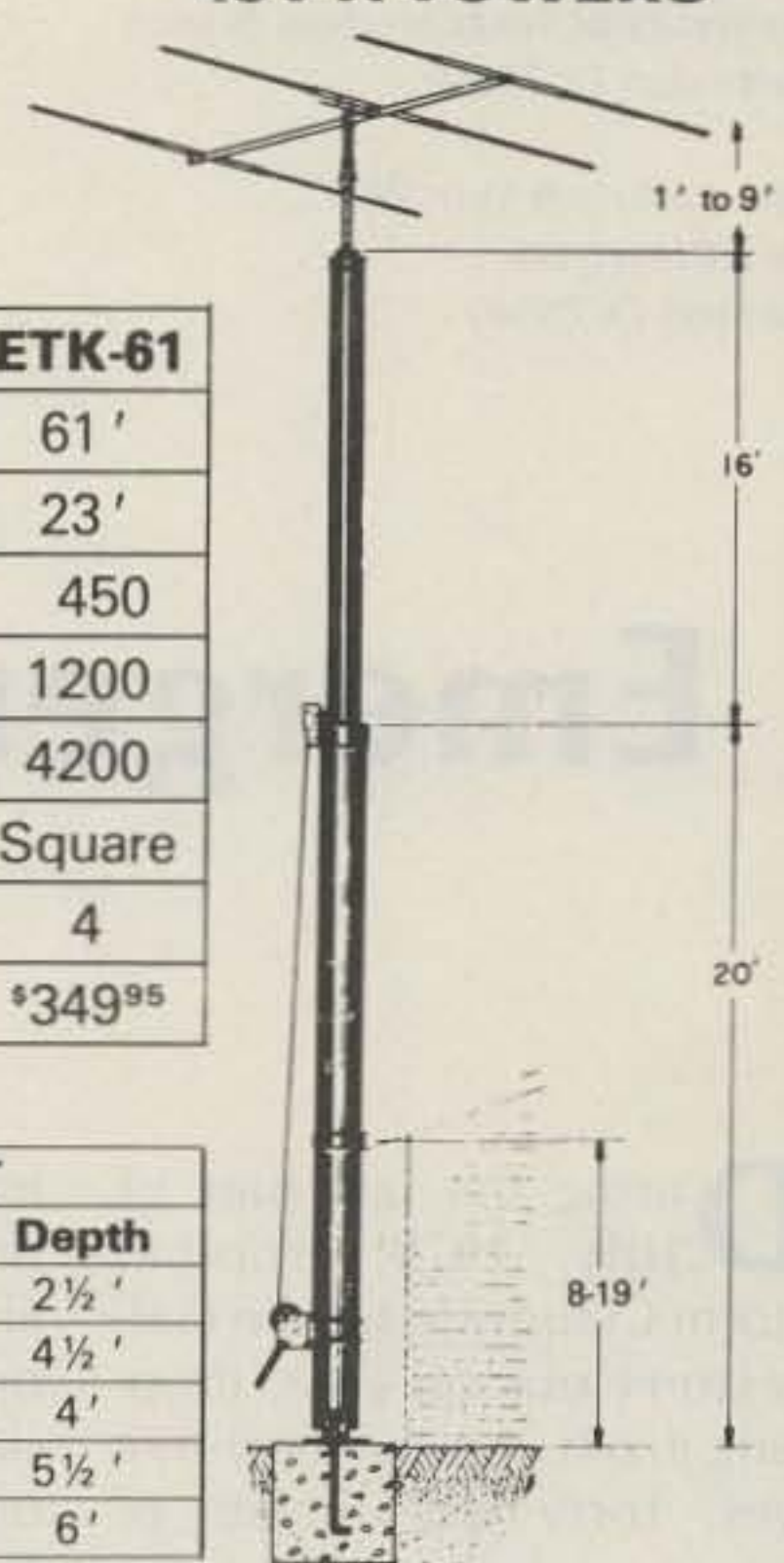
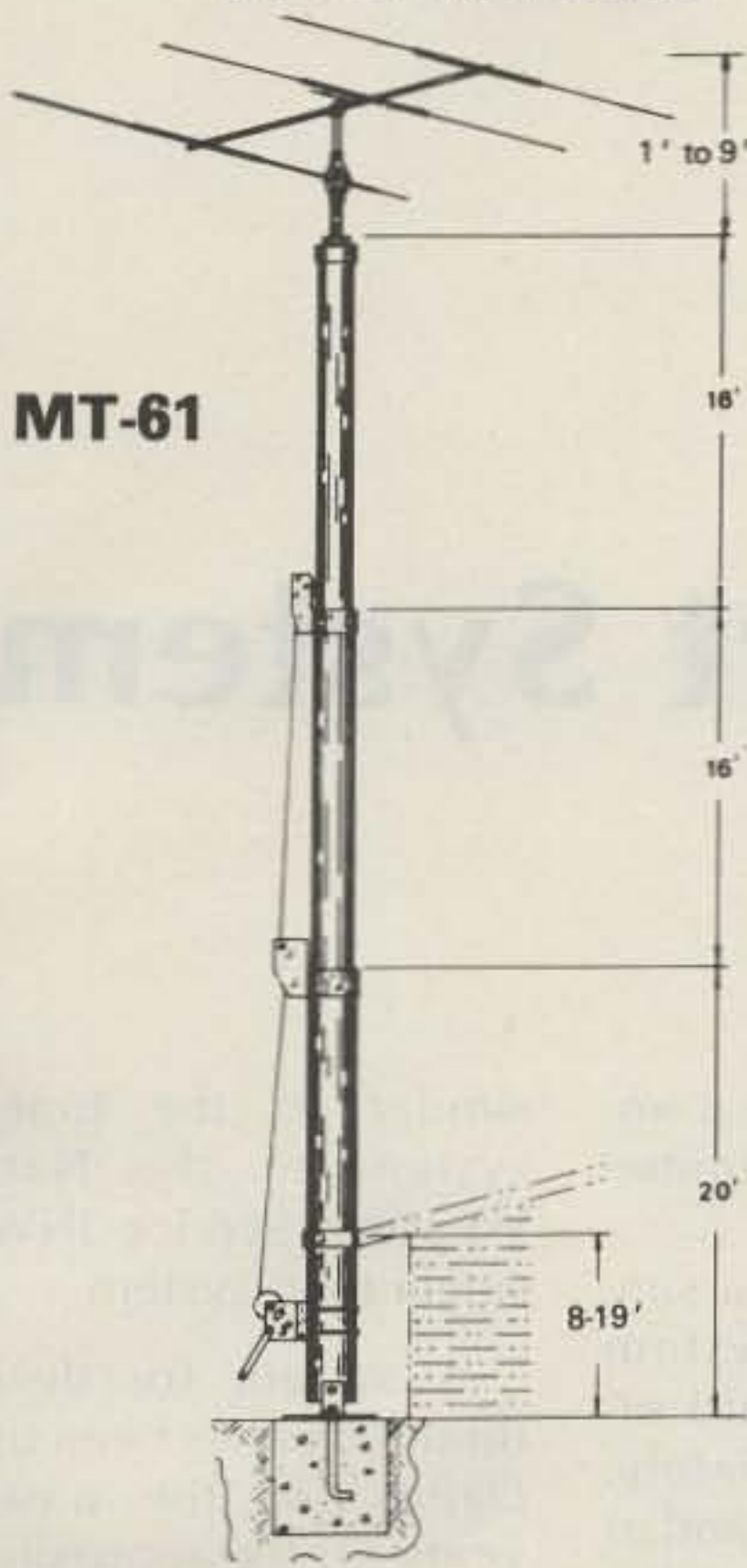

MODEL	TT-45	ETK-45	MT-61	ETK-61
Max. Height . .	45'	45'	61'	61'
Min. Height . .	22'	22'	23'	23'
Weight (lbs.) . .	250	250	450	450
Winch (lbs.) . .	1200	1200	1200	1200
Cable (lbs.) . . .	4200	4200	4200	4200
Tubing	Round	Square	Round	Square
Sections	3	3	4	4
Price	\$399 ⁹⁵	\$249 ⁹⁵	\$614 ⁹⁵	\$349 ⁹⁵

Wind Loading		
Tower	Height	Sq. Ft.*
ETK-45	37	15
	45	10
TT-45B	37	18
	45	12
ETK-61	53	15
	61	10
MT-61B	53	18
	61	12
ST-77B	69	16
	77	10

BASE CHART		
Tower	Width	Depth
45'	12" x 12"	2½'
FB/RB	30" x 30"	4½'
61'	18" x 18"	4'
FB/RB	36" x 36"	5½'
77 + RB	42" x 42"	6'

* Square Footage Based on 50 MPH Wind.

The ETK towers offer the ham a chance to have a 45 or 61 ft. tower at a very economical price. The tower is shipped to you in kit form. You do the final assembly and painting. You do not have to do any welding, just bolting together the parts. We supply you with the cold galvanizing compound to put the protective coating on the tower. This is not just paint, but the full galvanizing coating that will give your tower years of service.

Using square tubing, the assembly is fast and easy. It can still be mounted against the house for a non-guyed installation. Or you may use the fixed base for away from the house and completely free-standing installation.

TT-45, MT-61, ST-77

Wilson Systems uses a high strength carbon steel tube manufactured especially for Wilson Systems. It is 25% stronger than conventional pipe or tubing. The tubing size used is: 2" & 3½"-.095; 4½" & 6"-.125; 8"-.134. All tubing is hot dip galvanized. Top section is 2" O.D. for proper rotor and antenna mounting.

The TT-45B and MT-61B come complete with house bracket and hinged base plate for against-house mounting. For totally free-standing installation, use either of the tilt-over bases shown below.

The ST-77B cannot be mounted against the house and must be used with the rotating tilt-over base RB-77B shown below.

WILSON ELECTRIC WINCH

Now you can raise and lower your Wilson Tower electrically. The electric winch will replace the hand operated winch. Available for use on the TT-45, MT-61 and ST-77 towers.

EW-45 (TT-45) **\$249⁹⁵**
EW-61 (MT-61)
EW-77 (ST-77)

Remote Switch. **\$24⁹⁵**

TILT-OVER BASES FOR TOWERS

FIXED BASE

The FB Series was designed to provide an economical method of moving the tower away from the house. It will support the tower in a completely free-standing vertical position, while also having the capabilities of tilting the tower over to provide an easy access to the antenna. The rotor mounts at the top of the tower in the conventional manner, and will not rotate the complete tower.

- FB-45 ... 112 lbs. ... **\$189⁹⁵**
- ETB-45 ... 112 lbs. ... **\$164⁹⁵**
- FB-61 ... 169 lbs. ... **\$269⁹⁵**
- ETB-61 ... 169 lbs. ... **\$244⁹⁵**

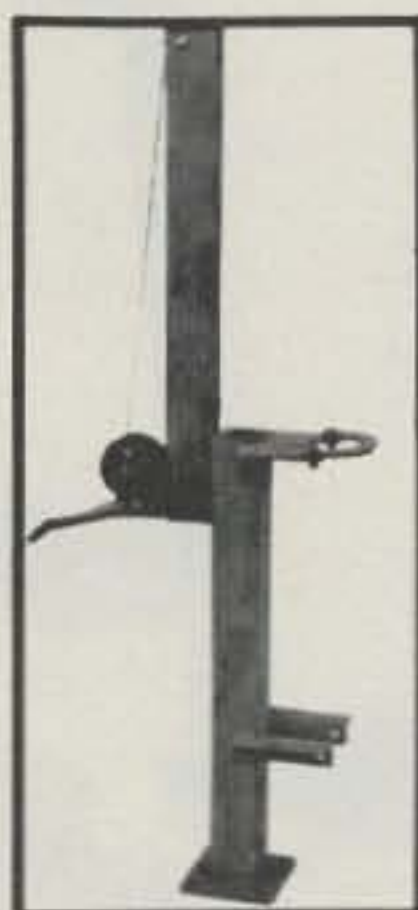

ROTATING BASE

The RB Series was designed for the amateur who wants the added convenience of being able to work on the rotor from the ground position. This series of bases will give that ease plus rotate the complete tower and antenna system by the use of a heavy duty thrust bearing at the base of the tower mounting position, while still being able to tilt the tower over when desiring to make changes on the antenna system.

- RB-45B ... 144 lbs. ... **\$259⁹⁵**
- RB-61B ... 229 lbs. ... **\$344⁹⁵**
- RB-77B ... 300 lbs. ... **\$514⁹⁵**

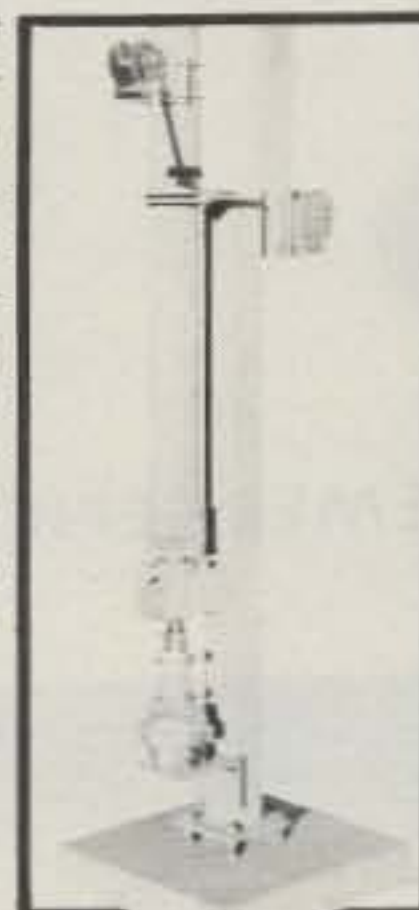

Tilting the tower over is a one-man task with the Wilson bases. (Shown above is the RB-61B. Rotor is not included.)

ORDER
FACTORY DIRECT
1-800-634-6898

Prices Effective 1-1-81 thru 1-31-81

W S I WILSON SYSTEMS, INC.

4286 S. Polaris Ave., Las Vegas, Nevada 89103

Randy Light WB5UCV
E. van der Smisssen WB5ASA
PO Box 149
University of Texas Medical Branch
Galveston TX 77550

Jerry Karlovich WB5PRD
1617 Bittercreek
Garland TX 75040

Emergency Tone Alert System

During the last part of July, 1979, tropical storm Claudette hit the Galveston-Houston area, dropping from ten to forty-five (yes, forty-five) inches of rain in various parts of the region in a very short time. Although the area was well blanketed with repeaters carrying emergency information, the rapid rise of water at night caught many hams unaware; some did not know of the emergency until water started coming

into their homes. At that time, there was no way of alerting the radio amateurs once they went to bed, since most of them turned off their two-meter rigs so that the routine chatter on the frequency would not keep them awake.

Claudette made it extremely clear that a method was needed to quickly and efficiently alert area amateurs that an emergency situation existed. Two additional emergencies in

rapid sequence made it imperative that we act immediately.

Our need was for a simple, economical system that could be put into effect almost immediately. Discussion on the air and at the August meeting of the Tidelands Amateur Radio Society (TARS) and the University of Texas Medical Branch (Galveston)-Emergency Communications Group (UTMB-ECG) developed criteria for a device

similar to the tone-alert system of the National Weather Service (NWS), a single-tone system.

A system for decoding dual tones has been used in Dallas for the past two years. Of the approximately 400 Radio Amateur Civil Emergency Service (RACES) members in Dallas, one hundred have the tone alert available. The usual response to any use of the emergency tone alert is at least 50% of the hams equipped to receive it. The local authorities are very impressed with the ability of the hams to respond to emergencies. The Dallas system is the "A-Tone Decoder" using the DTMF A tone. The tone alert is initiated by Civil Defense. Initially, the alert is on the 146.28/.88-MHz repeater, but it may go to other repeaters if the area of emergency is wider than can be covered by one repeater. The choice of the A tone for this metropolitan area was based upon the high possibility for abuse of other tones. The A tone generally is not available on the pads commonly used by hams. So far, Dallas has had no false alerts, even though some non-hams have gotten access to two-meter equipment and some hams have tried to jam the



Photo A. Completed tone alert.

transmissions.

Tarrant County (Fort Worth), near Dallas, is interested in implementing a similar system in the near future.

The decision of TARS and UTMB-ECG was to develop a tone-alert device based upon the success of Dallas, the ideas expressed by WA3ENK,¹ the WB5PRD design, and utilizing at least a four-second signal of the dual tones of the DTMF figure 9 (which most amateurs have available in a touch-tone™ or comparable pad) as the triggering signal. Use of a relay to silence the audio circuit to an external speaker until activated by the tone was considered the simplest alert device. The four-to-five-second duration of the tone in our tone alert causes a relay to close which then turns on an external speaker or alarm bell.

Twenty copies of the original WB5PRD board were ordered, and within three days the interest was so great that an additional 50 boards were ordered.

The original WB5PRD schematic was modified (but still using the original board) to fit our needs and to use the DTMF 9 tones. Local sources of parts in quantity were inadequate, so parts were ordered to provide 50 tone-alert kits. Parts were ordered from companies advertising in the several amateur radio journals. Upon checking the parts when they arrived, we found one company had shipped 30% of the parts in an inoperable condition, so these had to be replaced. By careful selection of sources, we were able to get the total cost (parts and board) down to \$12.50 for each kit. (The prototype using parts bought in small quantities was built for about \$18.00.) While awaiting receipt of parts, a construction and testing manual was written.



Photo B. Assembled PC board.

Word of what we were doing spread rapidly and inquiries came from other clubs and groups. Discussions concerning this system became quite active among several RACES and CD nets in Houston, Alvin, Clear Lake, and East Texas areas. Several groups asked if the device could be adapted to their special needs.

The concept of TARS and UTMB-ECG calls for the Emergency Operating Centers (EOCs) or a duly-authorized operator to initiate the 9 tone whenever the need arises to activate the net for emergencies. We also use the tone alert to call up our weekly repeater (147.75/.15 MHz) and simplex (145.53 MHz) nets.

As others have discovered, in the absence of phone-patch capability, hams must rely on tone alert.² It soon became apparent that two levels of alert would be needed: a low-level alert for personal emergencies such as car trouble, and a high-level alert for general emergen-

cies such as hurricanes, floods, or explosions. A single-tone capability for low-level alerts can be added without additional circuitry, using a toggle switch to ground one decoder output. With the switch in the low position, the tone alert can be activated by a DTMF 7, 8, or 9. We recommend the use of the figure 7 for low-level alerts and reservation of the figure 9 for high-level alerts.

Generally, the amateurs leave the tone alert on low level when they are around the shack and switch to high level when they go to bed. Thus, their alert device would awaken them only for high-level general emergencies.

Several other groups are planning to use the 9 for their alerts. Thus, a number of hams are now using the tone alert with scanners monitoring these several repeaters. The scanners are being modified so that they will scan silently even if there is routine activity on the frequency, but if the 9 signal is given, the scanner

will lock onto that frequency and activate the audio.

The Texas DX Society is considering using the tone alert on their repeater to alert members when rare DX is heard on the HF bands. They anticipate using a set of tones other than the 9 so that their signal will not activate scanners that are monitoring the repeaters for emergencies.

Another modification of the tone alert will be for use with weather radios to decode the 1050-Hz tone of the National Weather Service alerts and activate weather receivers not previously provided with tone alert. Since the NWS alert is only a single tone, such use will require only one decoder of the tone alert. The tone alert used for NWS cannot be used at the same time for the DTMF emergency tones.

Why were the 9 and 7 tones chosen? We thought that since 911 is used on the telephone to dial emergencies to fire and police, use of a 9 would be easy to remember as the alert sig-

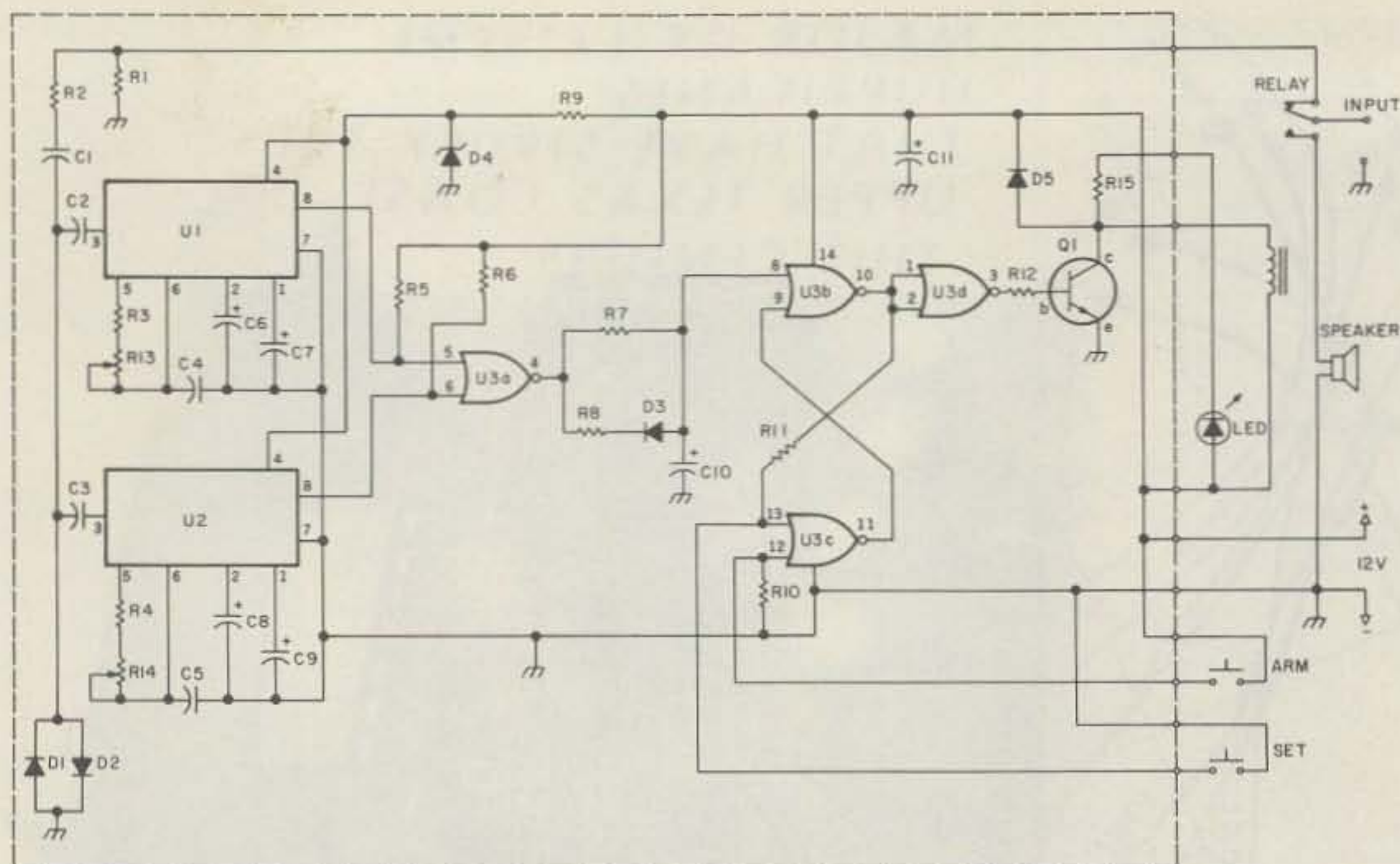

Fig. 1. Schematic diagram. (See Parts List.)

nal. The low-level alert is a good-neighbor service for individual or personal emergencies; therefore, it was considered appropriate to use the 7 or 73 for this alert tone.

Whether a large area such as the Galveston-Houston area is involved in emergencies or smaller local areas only, there is a way to alert only one or the other. If a general alert is involved, then the alerting operator goes from repeater to repeater giving the alert and announcing the emergency. If only a local area is involved, then only the repeater covering that area is alerted.

Because of the seriousness of emergencies that can occur in this region of the Gulf Coast and the potential for abuse, it was early decided to establish the following Galveston County general guidelines for use of the tone alert.

High-Level Alert

1. The tone alert will be activated only by duly-authorized operators acting on behalf of emergencies declared by Civil Defense or other official agencies, or on behalf of the repeater organization.

2. Alert will be sounded:
a) in the event of a civil emergency;
b) for a regularly scheduled test or drill;
c) to call attention to bulletins of general interest during an emergency.

3. Initially, the alert will be sounded on the repeater (147.75/.15 MHz) covering the area affected by the emergency and on 145.53 MHz simplex.

4. Alert will be sounded by transmitting the digit 9 for 15 seconds. The station transmitting the tone will:

- identify;
- transmit tone for 15 seconds;
- call CQ or QST;
- state the nature of the emergency or that a test or drill is in progress;
- give instructions concerning action to be taken and/or frequencies to be monitored.

5. Individual testing and tune-up of the tone-alert circuit will be done on a simplex frequency other than 145.53 MHz and will not be done on repeaters. Use low power if possible when testing or tuning circuit.

6. High-level tone alert will not be used for routine personal emergencies such as flat tire, out of gas, etc.

Low-Level Alert

1. This alert may be sounded by any amateur having a personal or individual emergency for which he needs help. (It is recommended that a direct call on the repeater or simplex frequency be tried first before using the tone alert.)

2. Low-level alerts will be sounded only on the local area simplex or repeater frequency. Low-level alerts are not to be used for general alerts covering more than one repeater.

3. Alert will be sounded by transmitting the digit 7 for 15 seconds. The station transmitting the tone will:

- identify;
- transmit the 7 tone for 15 seconds;
- call CQ or QST;
- state the nature of the emergency and request the necessary assistance.

This plan has been operational since August, 1979, is gaining adherents, and the idea is spreading. Based upon our experience, we would recommend this or a

similar system to other amateurs participating in emergency activities.

Circuit Description

The schematic is shown in Fig. 1. The components listed in the Parts List are standard items which are readily available. Advantages and disadvantages of the 567 PLL tone decoder have been discussed previously in the amateur literature.^{3,4}

The circuit is powered from a 12-volt dc source. Zener diode D4 provides 6.2 volts dc for U1 and U2.

When the circuit is armed by bringing pin 12 of U3c to logic one briefly, audio is routed through the normally-closed contact of the relay to loading resistor R1 and to the input of the decoder circuits through R2. Germanium diodes D1 and D2 conduct at 300 mV to protect the circuit from audio overload. C2 and C3 pass the audio tones but block dc from entering U1 and U2 along with the audio signal.

U1 and U2 decode the high and low tones, respectively. R3, R13, and C4 set the center frequency of U1; R4, R14, and C5 set the center frequency of U2 (bandwidth is about 5% of the center frequency).

When a decoder locks on an incoming tone, pin 8 goes to logic zero. When both U1 and U2 are locked, pin 4 of NOR gate U3a goes to logic one. C10 then charges through R7 to provide a delay before pin 8 of U3b reaches logic one. U3d inverts the output of U3b. The sequence is now complete, the relay and LED are activated by Q1, and audio is now routed to the speaker until the circuit is again armed.

A total delay of three to four seconds is introduced between initial reception of the tone and activation of the relay to prevent false activation of the circuit.

D3 and R8 provide a discharge path for C10 when no tone is present. This prevents a buildup of charge over a period of time from intermittent false signals which might cause activation of the circuit. D5 protects Q1 from the transient voltage present when the relay is deactivated.

Momentarily closing the normally-open ARM (RESET) switch will deactivate the relay (open the audio circuit to the speaker) and will arm the decoders so that they can respond to an incoming tone signal.

Momentarily closing the normally-open SET switch will activate the relay so that audio goes to the speaker. This mode will continue until the ARM (RESET) switch is activated. (A momentary DPDT toggle switch with center off can be used in place of two separate momentary switches.)

Assembly

The circuit was assembled on a WB5PRD circuit board. (Drilled printed circuit boards are available from WB5PRD for an SASE and \$4.00.) The foil side of the board is shown in Fig. 2, which is suitable for use in reproducing the board. An assembled PC board and a completed tone alert are shown in the photographs.

Parts layout is shown in Fig. 3. Assembly can be facilitated if one starts with those components at the center of the board and works outward toward the edge. Diodes, capacitors, trim pots, and quarter-Watt resistors are mounted vertically. The two one-Watt resistors are mounted horizontally. If proper care is taken as to which end of the vertically-mounted resistors is upmost, then that point of the resistor can be used as a test-point contact for testing other parts of the circuit. (See Table 1.)

The usual precautions

should be observed when handling the 4001 CMOS integrated circuit. For temperature stability, C4 and C5 must be high-quality mylar™ or metallized film capacitors.

The switches and LED are installed on the front panel or speaker enclosure. The LED should be near the SET switch; the LED lights when the tone-alert unit is in the SET activation. The relay is installed off the circuit board with epoxy glue or silicone rubber. A multi-pole relay may be substituted if other devices, in addition to the speaker, are to be controlled. (Remember that when other devices such as bells or buzzers are on the relay, they will be activated when the SET switch is activated.)

The twelve-volt dc supply is connected between points marked + and - (ground). One side of the relay coil and the LED anode are connected to point K&L and the other side of the relay coil goes to K. The cathode of the LED goes to L. The ARM (RESET) switch is connected to the points marked A. The SET switch is connected to the two points marked S. Audio is connected between INPUT and ground. Points E, B, and C indicate the emitter, base, and collector of Q1.

Tune-Up

The tone alert may be adjusted for the DTMF tone 9 using either of two procedures—either a frequency counter or a voltmeter may be used. With the frequency counter method, the counter is connected to U1 at pin 5 (for a square wave) or pin 6 (for a triangle wave), and R13 is adjusted until the counter shows 1477 Hz. Take care not to load the circuit with the test equipment. Next, connect the counter to pin 5 or 6 of U2 and adjust R14 until the counter shows 852 Hz.

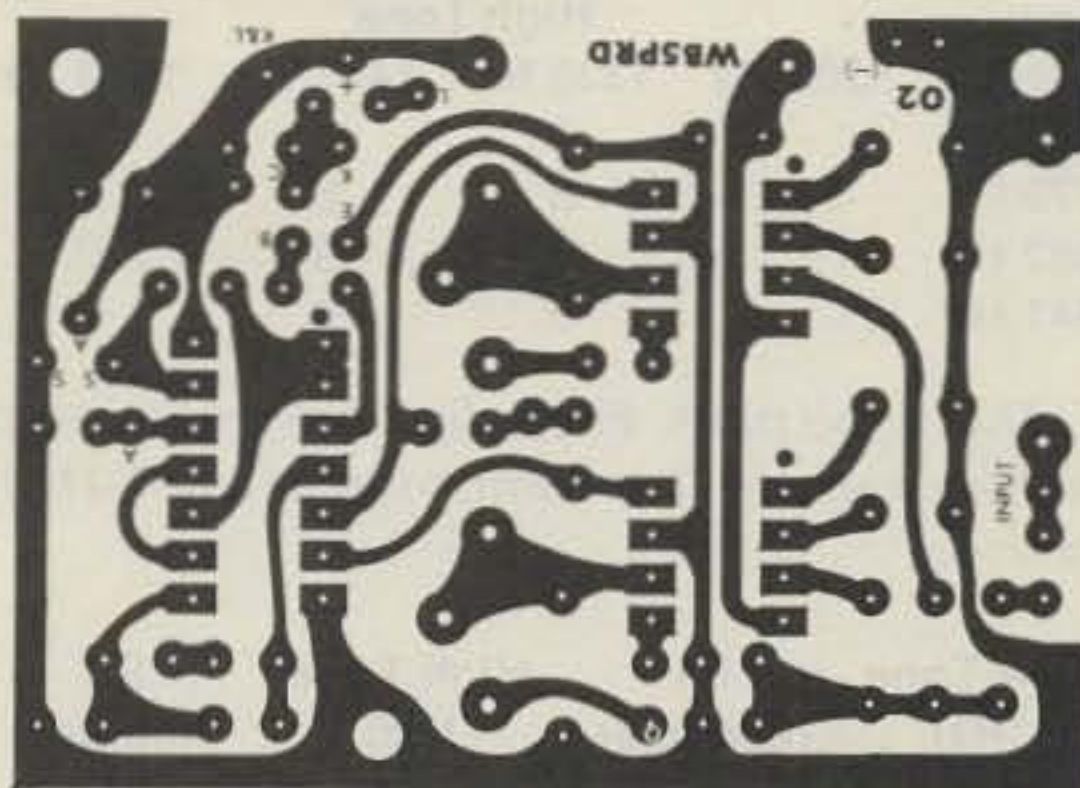

Fig. 2. PC board, foil side. This is suitable for reproducing the board for those who would like to do so.

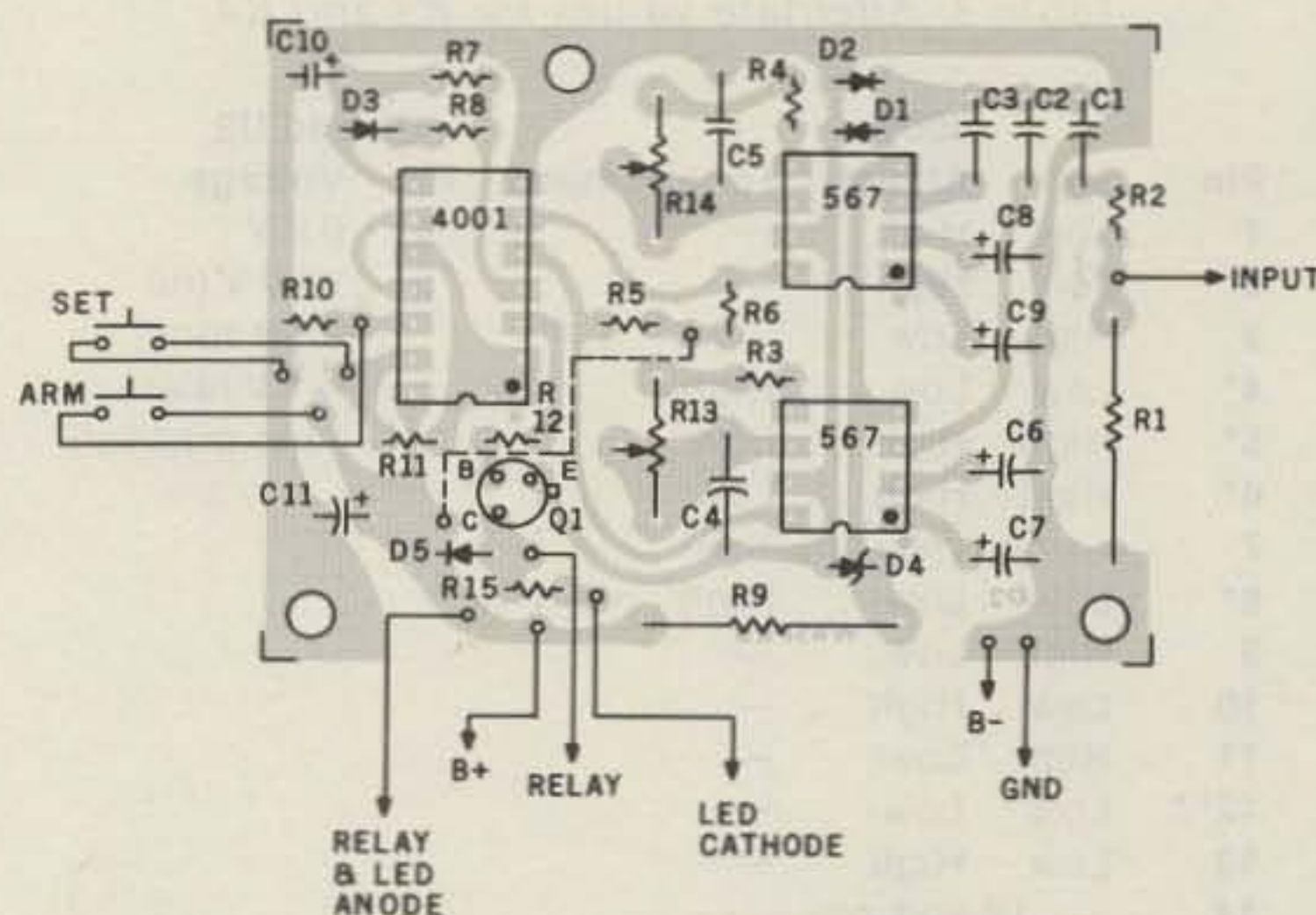

Fig. 3. Parts layout.

Alternatively, a voltmeter or logic probe may be used. Start with R13 and R14 fully counterclockwise. Apply an alert tone with the probe on pin 8 of U1 or pin 5 of U3 and slowly turn R13 clockwise. Note the position of R13 when the voltage drops and continue turning R13 clockwise until the voltage goes back up; note this point. Turn R13 counterclockwise to a point midway between the two voltage change settings. Do the same with the probe on pin 8 of U2 or pin 6 of U3 while adjusting R14.

Operation

Apply 12 volts dc to the unit. Momentarily close the SET switch; the relay should activate. Provide an audio input from the two-meter rig. The circuit will not function properly with a high noise signal or with too little audio drive. Turn the

audio gain up to ensure proper drive level. The loading resistor is rated at one Watt. ARM the circuit and have another operator transmit an alert tone on a simplex frequency for fifteen seconds. The unit should activate in less than ten seconds.

Circuit Alternatives

The circuit can be tuned for tones other than the digit 9. The standard tone pairs are listed in Table 2.

Component	Connection
R3	Pin 5, U1
R4	Pin 5, U2
R5	Pin 5, U3a
R6	Pin 6, U3a
R7	Pin 8, U3b
R8	Pin 4, U3a
R11	Pin 2, U3d
R12	Pin 3, U3d

Table 1. The end of the component connected to the listed test point is placed in the up position.

Low Tone	High Tone			
	1209 Hz	1336 Hz	1477 Hz	1633 Hz
697 Hz	1	2	3	A
770 Hz	4	5	6	B
852 Hz	7	8	9	C
941 Hz	*	0	#	D

Table 2. DTMF tone pairs. Each digit or sign is composed of two tones. For example, 1 is composed of a 697-Hz tone and a 1209-Hz tone.

Low Tone (Hz)	R4 (kilohms)	High Tone (Hz)	R3 (kilohms)
697	11.0	1209	5.6
770	10.0	1336	5.6
852	8.2	1477	5.6
941	8.2	1633	3.9

Table 3. Alternate values for R3 and R4.

Pin	4001			U1 and U2	
	Set	Armed	Tone Present	Pin	Voltage
1	Low	High	—	4	6.2 V
2	Low	High	—	5	12.0 V (no alert tone)
3	High	Low	—		0.1 V (alert tone present)
4*	Low	Low	High		
5*	High	High	Low		
6*	High	High	Low		
7	-----Ground pin-----				
8*	Low	Low	High		
9	High	Low	—		
10	Low	High	—		
11	High	Low	—		
12**	Low	Low	—		
13	Low	High	—		
14	-----12 volt pin-----				

*These remain at the same state during SET and ARMED periods and change only during the presence of the alert tone. Do not replace the chip yet if any of these pins do not agree.

**This pin should go high while pressing the ARMED button.

Table 4. Logic and voltage chart.

The corresponding alternative values for R3 and R4 are shown in Table 3.

Most of the delay between the introduction of an alert tone and relay activation is introduced by R7 and C10. These may be adjusted to provide a longer or shorter delay.

If one wishes to have both a low level of alert and a high level of alert, this can be done by adding an SPST toggle switch so that pin 5 of U3a (or pin 8 of U1) can be grounded. With pin 5 or pin 8 grounded, only a single tone (852 Hz) will activate the unit. With the switch in the closed (grounded) position, the tone alert can be activated by the digit 7 for a low-level or personal emergency, and

in the switch-open position, it will take both tones of the digit 9 to activate the unit.

Weather Watch (Alert) Modifications

Only minor changes are required on this circuit to decode the NWS 1050-Hz alert tone for weather radios that do not have this feature. U1, R3, R5, R13, C4, C6, and C7 are omitted. A jumper is placed between the foils originally intended for pins 7 and 8 of U1. R14 is adjusted for 1050 Hz at pin 5 or 6 of U2. Activation methods and time will remain the same.

Troubleshooting

Step One: Most problems with performance can be traced to bad solder joints,

Parts List

Resistors
R1—10 Ohms, 1 Watt
R2—1.5k Ohms, ¼ Watt
R3—5.6k Ohms, ¼ Watt
R4—8.2k Ohms, ¼ Watt
R5, 6, 11—27k Ohms, ¼ Watt
R7—560k Ohms, ¼ Watt
R8—1k Ohms, ¼ Watt
R9—220 Ohms, 1 Watt
R10—10k Ohms, ¼ Watt
R12—22k Ohms, ¼ Watt
R13, 14—5 kilohms, vertical trim pots
R15—1k Ohms, ¼ Watt

Capacitors
C1, 2, 3—0.1 µF ceramic disc, 25 V
C4, 5—0.1 µF mylar™, 16 V
C6, 8—1.0 µF electrolytic, 6 V
C7, 9—10.0 µF electrolytic, 6 V
C10—3.3 µF electrolytic, 16 V
C11—100 µF electrolytic, 16 V

Semiconductors
D1, 2—1N34A germanium (or equivalent)
D3—1N914 silicon (or equivalent)
D4—6.2 volt, 400 mW zener
D5—1N4001 (or equivalent)
Q1—2N2222 NPN transistor
U1, U2—567 dual inline, tone decoder
U3—4001 CMOS logic block

Keep CMOS wrapped in foil until ready to install.
LED—jumbo LED of choice

solder bridges, incorrect parts placement, or failure to observe polarity of diodes or capacitors. All construction steps should be retraced with this firmly in mind.

Step Two: Confirm that adequate noise-free audio is actually present at the input and that the relay will work out of the circuit. Close the SET switch to activate the relay.

Step Three: Use a VTVM or FET-VOM (at least a megohm resistance) and check the voltages listed in Table 4.

Step Four: Using a piece of hookup wire, connect one end to ground and carefully touch the other end to both pins 5 and 6 of U3 with the circuit ARMED. The relay should activate in about four seconds. If it takes as long as thirty seconds to activate the relay, check R7, R8, C10, and D3. If this fails, replace U3.

Step Five: Check U1 and

U2 for proper tuning.

Step Six: Ground pin 8 of U1 and send a DTMF digit 7 signal over the audio input. If this activates the relay in 4-6 seconds, then U2 is tuned and functioning. If the relay does not activate, then replace U2 and try again.

Step Seven: Ground pin 8 of U2 and send a DTMF digit 3 signal over the audio input. If this activates the relay in 4-6 seconds, then U1 is tuned and functioning. If the relay does not activate, then replace U1 and try again. ■

References

- Rodney A. Kreuter WA3ENK, "Two Meter Tone Alert," *73 Magazine*, January, 1979.
- Stan Horzempa WA1LOU, "FM/RPT—Tone Alert Standards," *QST*, December, 1979.
- J. H. Everhart WA3UXH, "Toward A More Perfect Touch-tone Decoder," *73 Magazine*, November, 1976.
- Rick Swenton WA1LWV, "Tone Decoder Improvements," *73 Magazine*, February, 1979.

MORE KEYER FEATURES FOR LESS COST

AEA Invites You to Compare the AEA Keyer Features
to Other Popular Keyers on the Market.

MM-1

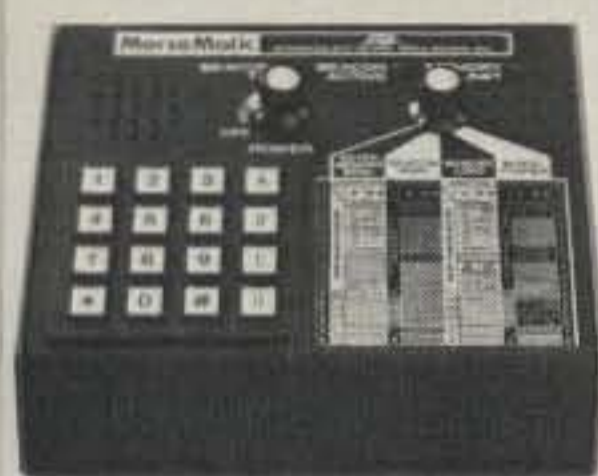

MorseMatic™

KT-1



Keyer Trainer

MT-1



Morse Trainer

CK-1



Contest Keyer

MK-1



Morse Keyer

IMPORTANT KEYER AND/OR TRAINER FEATURES	AEA	AEA	AEA	AEA	AEA	COMPETITOR			
	MM-1	KT-1	MT-1	CK-1	MK-1	A	B	C	D
Speed Range (WPM)	2-99	1-99	1-99	1-99	2-99	8-50	5-50+	?	8-50
Memory Capacity (Total Characters)	500			500		400	100/400	400	
Message Partitioning	Soft			Soft		Hard	Hard	Hard	
Automatic Contest Serial Number	Yes			Yes		No	No	No	
Selectable Dot and Dash Memory	Yes	Yes		Yes	Yes	No	No	No	No
Independent Dot & Dash (Full) Weighting	Yes	Yes	Yes	Yes	Yes	No	No	No	No
Calibrated Speed, 1 WPM Resolution	Yes	Yes	Yes	Yes	Yes	No	No	Yes	No
Calibrated Beacon Mode	Yes			No		No	No	No	
Repeat Message Mode	Yes			No		Yes	Yes	Yes	
Front Panel Variable Monitor Frequency	Yes	Yes	Yes	Yes	Yes	Yes	No	Yes	Yes
Message Resume After Paddle Interrupt	Yes			Yes		No	No	Yes	
Semi-Automatic (Bug) Mode	Yes	Yes		Yes	Yes	No	No	No	No
Real-Time Memory Loading Mode	Yes			Yes		Yes	Yes	No	
Automatic Word Space Memory Load	Yes			Yes		No	No	Yes	
Instant Start From Memory	Yes			Yes		No	No	Yes	
Message Editing	Yes			Yes		No	No	No	
Automatic Stepped Variable Speed	No	No	No	Yes	No	No	No	No	No
2 Presettable Speeds, Instant Recall	No	No	No	Yes	No	No	No	No	No
Automatic Trainer Speed Increase	Yes	Yes	Yes						No
Five Letter or Random Word Length	Yes	Yes	Yes						No
Test Mode With Answers	Yes	Yes	Yes						No
Random Practice Mode	Yes	Yes	Yes						Yes
Standard Letters, Numbers, Punctuation	Yes	Yes	Yes						Yes
All Morse Characters	Yes	Yes	Yes						No
Advertised Price	\$199.95	\$129.95	\$99.95	\$129.95	\$79.95	\$139.95	\$ 99.50/ \$229.00 \$139.50	\$129.95	\$129.95

OPTIONS:

- MT-1P** (portable version of MT-1) with batteries, charger, earphone **\$139.95**
- ME-1** 2000 character plug-in memory expansion for MM-1 **\$ 59.95**
- AC-1** 600 Ma. 12 Volt wall adaptor for MM-1 with ME-1 **\$ 14.95**
- AC-2** 350 Ma. 12 Volt wall adaptor for all AEA keyer and trainer products except MM-1 w/ ME-1 **\$ 9.95**
- DC-1** Cigarette lighter cord for all AEA keyers and trainers except MT-1P **\$ 5.95**
- MT-1K** Factory conversion of MT-1 to KT-1 **\$ 40.00**

All our keyers (except the MT-1) will operate with any popular single lever or lambic squeeze paddle and will key any type of modern amateur transmitter with no external circuitry required. AEA keyers are as easy to operate as a four function calculator. The internal AEA computers are all pre-programmed for the features shown above. Each AEA product is fully RF protected and receives a complete elevated temperature burn-in and test before it is shipped from the factory.

Ask a friend how he likes his AEA keyer compared to anything else he has ever tried, then **JUDGE FOR YOURSELF**. See the AEA keyer and trainer family at your favorite dealer.

Advanced Electronic Applications, Inc., P.O. Box 2160, Lynnwood, WA 98036. Call 206/775-7373

AEA Brings you the Breakthrough!

PRICES AND SPECIFICATIONS SUBJECT TO CHANGE WITHOUT NOTICE OR OBLIGATION.

WWV-to-80-Meter Converter

This simple and inexpensive frequency converter will place the WWV 10-MHz signal anywhere within the 80-meter band. Credit for the basic design goes to PM Electronics, a local firm that is now defunct.

Referring to the schematic in Fig. 1, L1-C2 are tuned to the WWV 10-MHz signal. This signal is coupled to the base of Q1 by L2. Oscillator Q2 operates at any selected crystal frequency between 6 and 6.5 MHz, and is coupled to the emitter of Q1 by C7. Q1 mixes the two frequencies. The L3-C5-C6 combination is tuned to the 3.5-to-4-MHz difference fre-

quency which appears at the collector of Q1. Impedance matching to the 50-Ohm receiver antenna is provided by the C5-C6 capacitive divider.

Crystal frequency is determined by subtracting the desired 80-meter frequency from the WWV 10-MHz frequency. The 3750-to-3800-kHz range (6250-to-6200-kHz crystal) might be a good choice for minimum signal interference. The crystal may be obtained from Jan Crystals, 2400 Crystal Drive, Ft. Myers FL 33906. Specify type FT-243 holder and desired crystal frequency. This crystal will be .005% tolerance. Jan's

1980 catalog (#23) lists this crystal at \$2.00 each with a 30-cent per crystal handling and first class mail charge. The FT-243 socket, part SSO-1, also may be obtained for an additional 30 cents.

The circuit board can be quickly and easily made by first positioning and securing the copper face of a 1-3/4" x 3-3/8" board under the circuit pattern in Fig. 2. Next, mark through the pattern at each hole location and then drill a #60 hole at each mark. The inductor pin and crystal socket holes may require pattern adjustment and larger holes. Also, check the lead spacing of your capacitors. The layout is for 1/4-inch spacing but

room is available for the 3/8-inch variety.

Finally, carefully connect the related holes with 1/8-inch strips of art or masking tape. Place masking tape over the component side of the board to prevent acid from entering the holes. Thoroughly clean the copper surface after etching. Using this method, I easily etched and assembled a checkout board in one afternoon.

The inductors are wound on a 1/4-inch diameter slug-tuned coil form as shown in Photo A. These may be found in most junked TV sets and radios. As viewed from the base, coils L1 and L2 are wound counterclock-

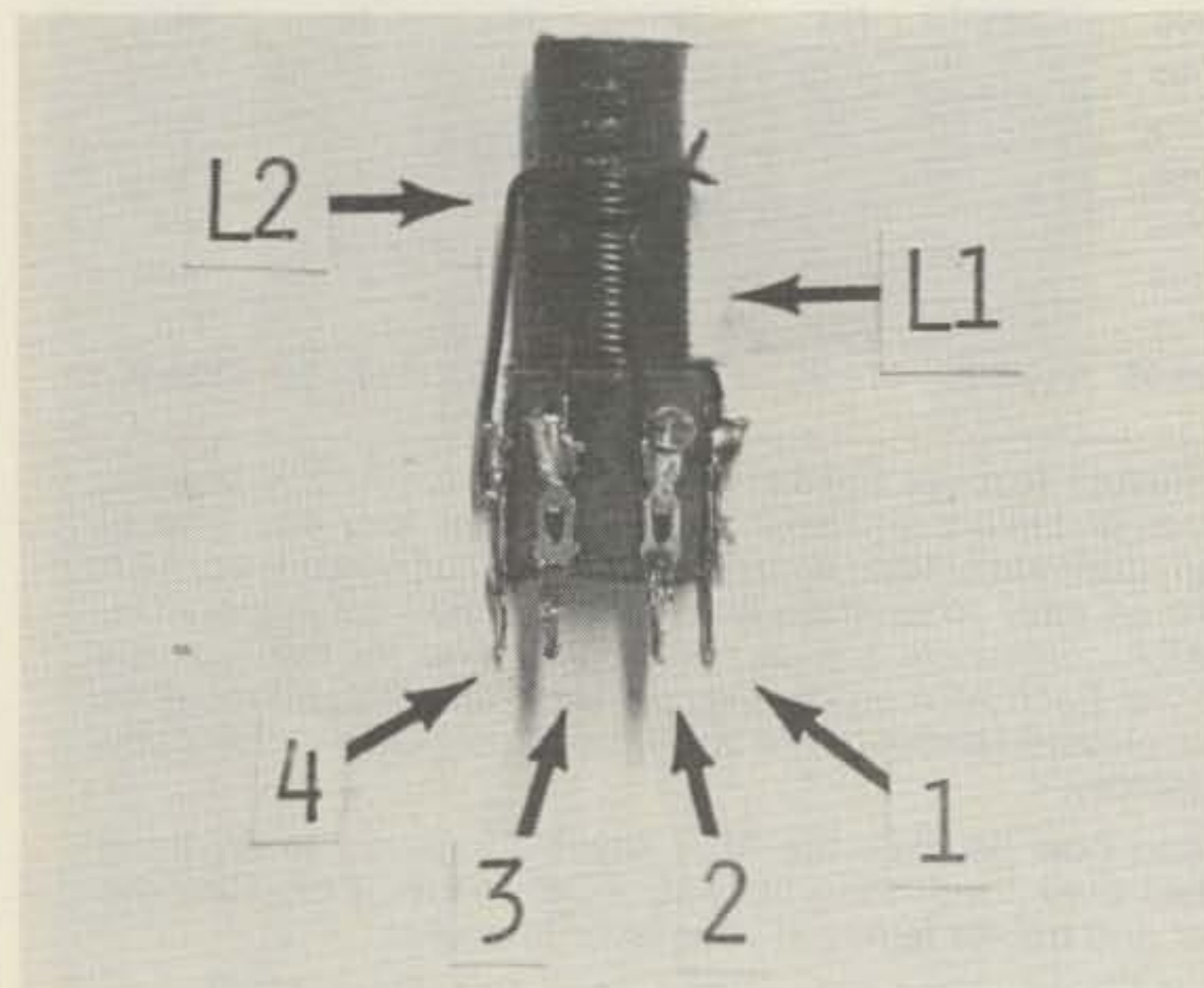

Photo A. Close-up of the L1-L2 inductor. L1 is 12 ccw turns and L2 is 4 ccw turns of #24 enameled wire. L3 is 35 cw turns of #32 enameled wire. All inductors are wound on a 1/4-inch slug-tuned coil form.

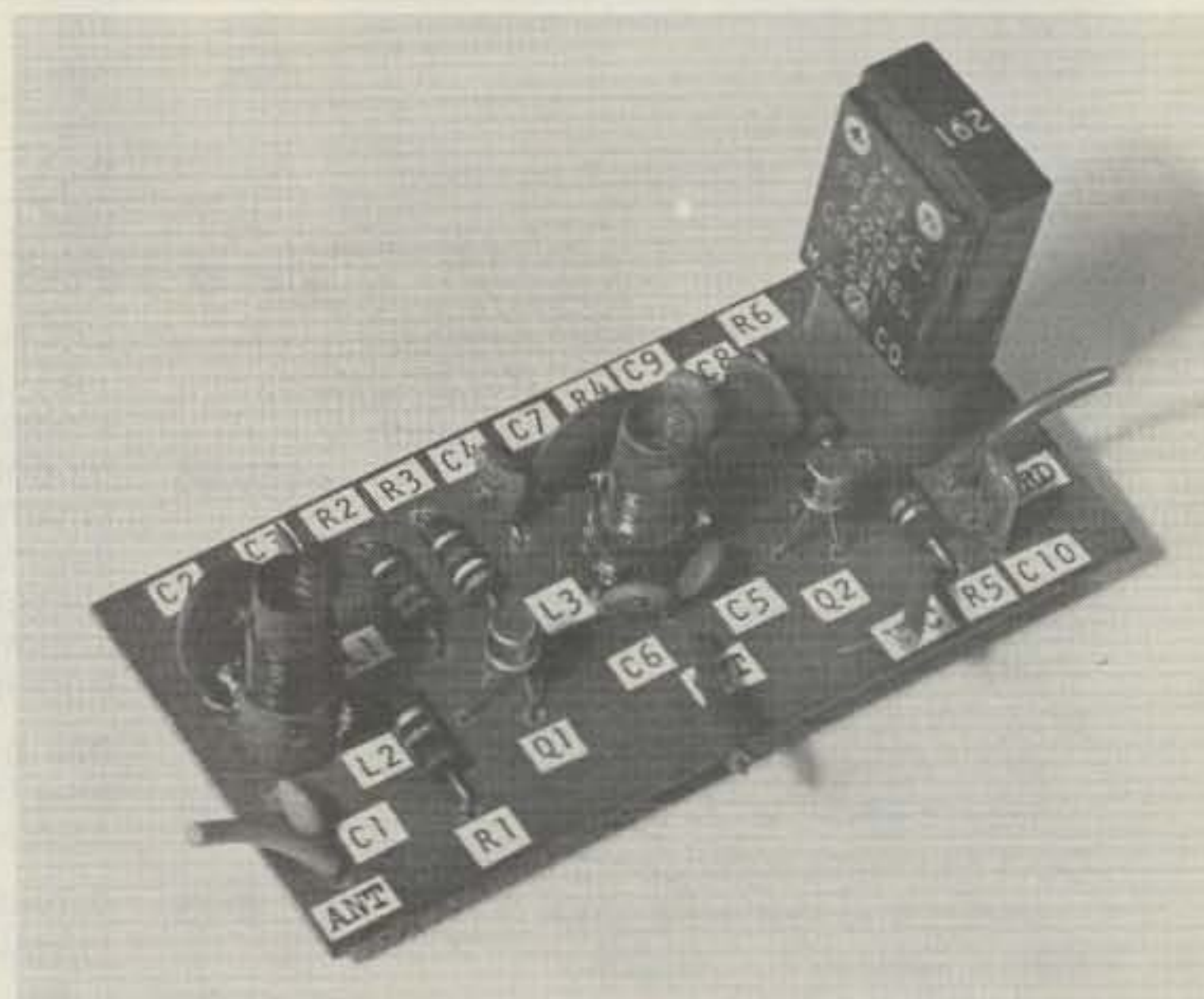

Photo B. Top view of the completed WWV-to-80-meter frequency converter.

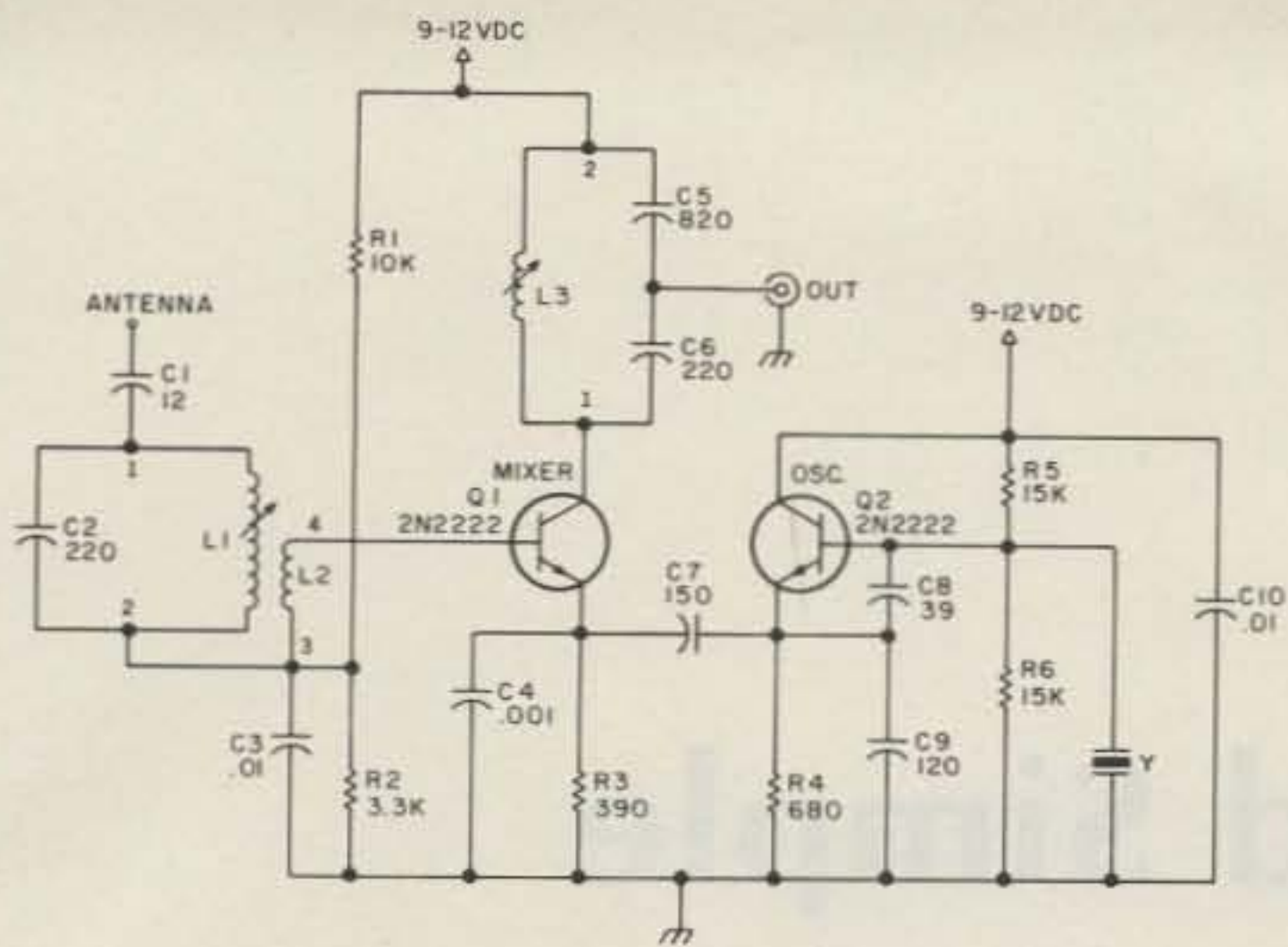

Fig. 1. Schematic diagram of the WWV converter. Resistors are 1/4 or 1/2 Watt. Capacitors C3 and C10 are Mylar™, with all others being disc ceramic.

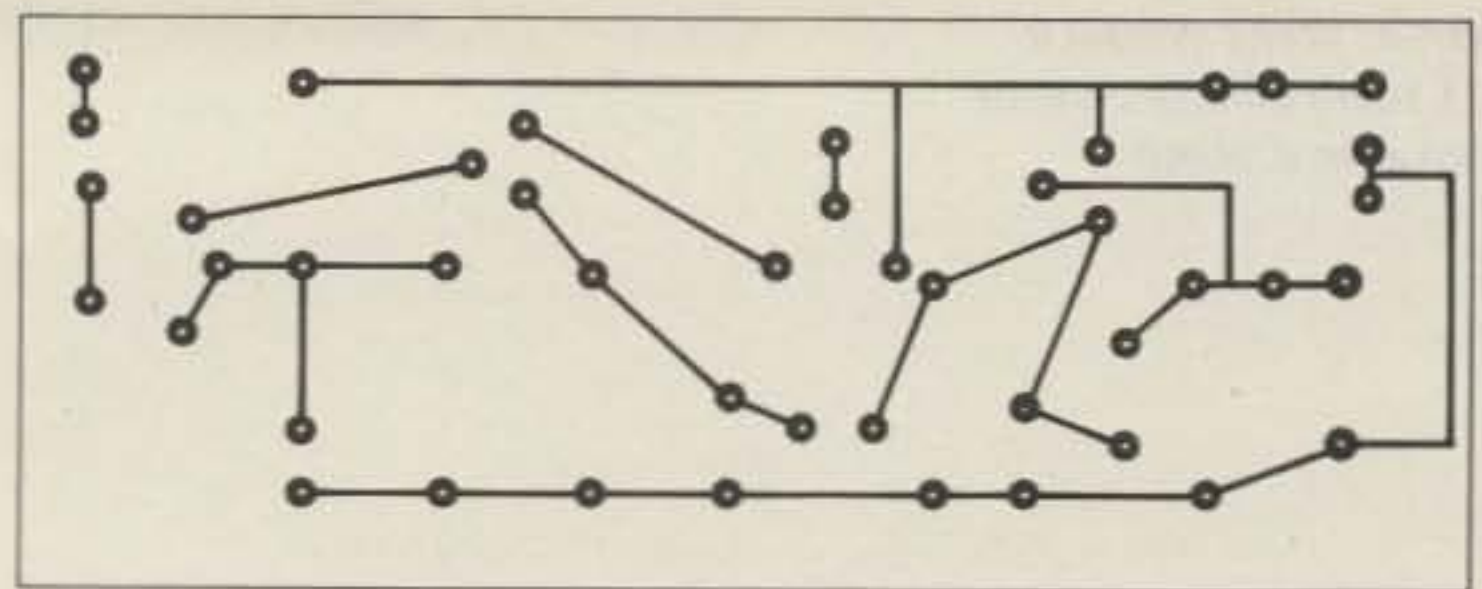

Fig. 2. Foil side of the circuit board.

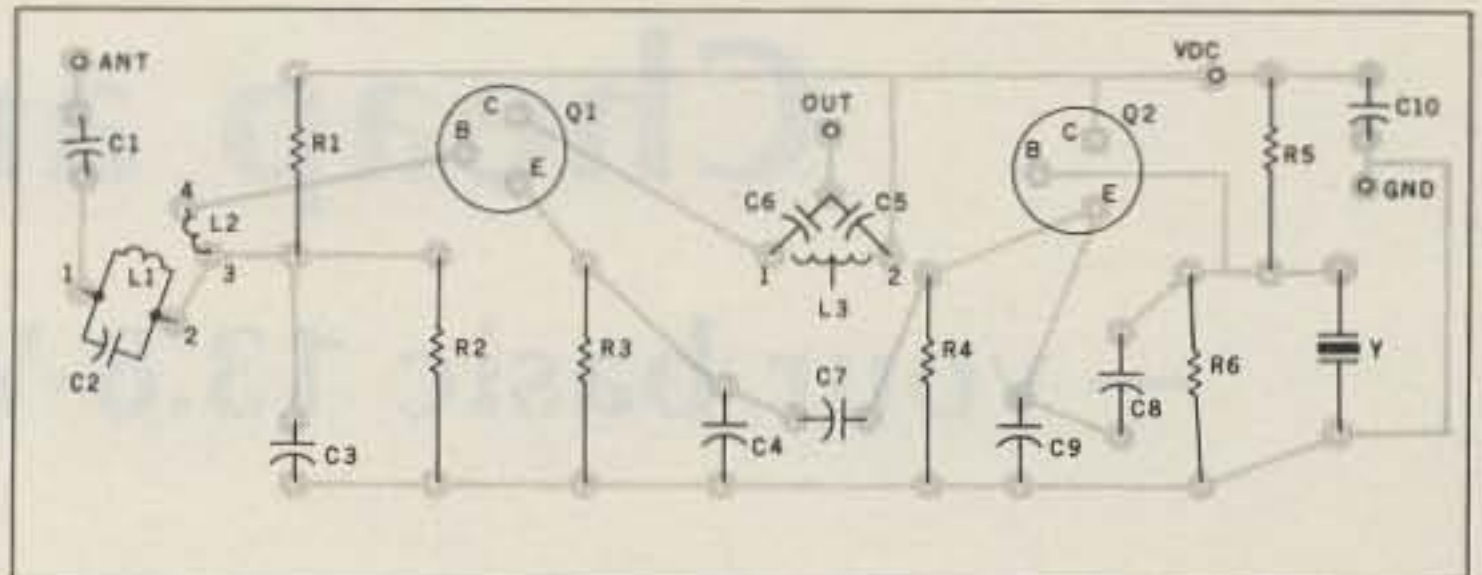

Fig. 3. Parts placement guide (foil side shown).

wise with #24 enameled wire, and L3 is wound clockwise with #32 enameled wire. All three inductors are wound with no space between turns. L2 begins at the end of L1 with no space between the end of L1 and the start of L2. Secure the coil ends with thread or

tape and apply two or three coats of varnish to hold the coil in place.

Capacitors C2, C5, and C6 are soldered directly to the inductor pins. I tried several sets of transistors, both NPN and PNP types, and they all worked. Just reverse the voltage polarity

for PNP types. To align, connect a short antenna and set L1 and L3 for maximum S-meter reading with a nonmetallic tool. Use shielded cable for hookup to the receiver.

My thanks to Chuck Allyn, who so kindly provided the photographs for this article. If you have a question or need parts help, an SASE will bring a prompt reply. ■

HAM-KEY™

RADIO TELEGRAPH SENDING DEVICES

New Lower Prices



Model **HK-3M** ~~\$19.95~~
Now \$15.95

- * Deluxe straight key
- * Anti-tip bracket. Can't tip
- * Heavy base. No need to attach to desk

Add \$2.00 Shipping & Handling.

- * Navy type knob
- * Smooth action

Model AT-B anti-tip bracket only, to convert any HK-3 to HK-3M. \$1.50 Postpaid

CC-3P shielded cable & plug for HK-3M \$1.50

Add \$.50 Shipping & Handling.

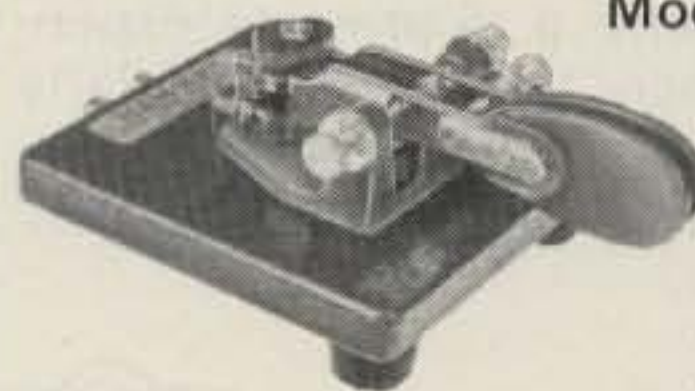

Model **HK-1** ~~\$29.95~~ **Now \$24.95**

Add \$2.00 Shipping & Handling.

- * Dual lever squeeze paddle
- * For use with all electronic keys
- * Heavy base with non-slip rubber feet
- * Paddles reversible for wide or close finger spacing

Model HK-2, same as HK-1 but less base for incorporation in your own keyer. \$16.95

Add \$1.00 Shipping & Handling

CC-1P shielded cable & plug for HK-1 \$2.00

Add \$.50 Shipping & Handling.

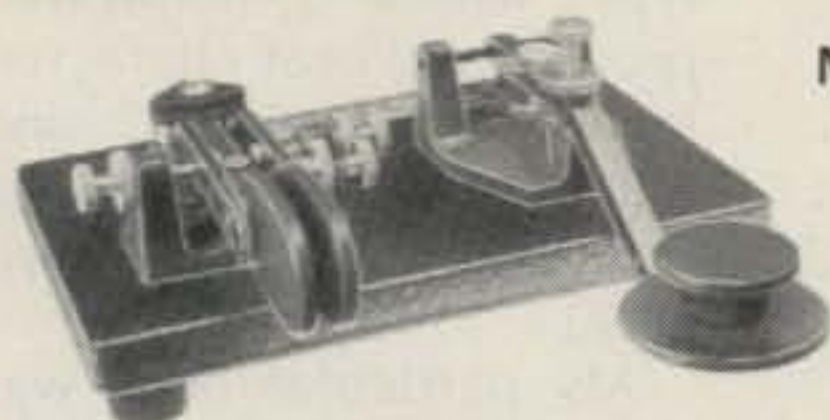

Model **HK-4** ~~\$44.95~~
Now \$37.95

- * Combination HK-1 & HK-3 on same base
- * Straight key may be used conventionally or as a switch to trigger a memory.

Add \$2.00 Shipping & Handling.

CC-1/3P Shielded cable with plugs for HK-4 \$3.50

Add \$1.00 Shipping & Handling



Model **HK-5A** Electronic Keyer
~~\$69.95~~ **Now \$54.95**

Add \$2.00 Shipping & Handling.

- * Iambic circuit for squeeze keying
- * Self completing dots & dashes
- * Dot & dash memory
- * Built-in sidetone
- * Battery operated with provisions for external power
- * Uses Curtis 8044 keyer chip
- * Grid block or direct keying
- * Speed, volume, tone & weight controls on front panel
- * Use with HK-1 or HK-4

IF NOT IN STOCK AT YOUR DEALER, ORDER DIRECT FROM



P.O. Box 28271

The HAM-KEY Co. 30 St. Louis, MO 63132
Phone TOLL-FREE 1-800-325-3651



Cheap and Simple

— your basic 13.8-V, 25-A power supply

The 13.8-volt ham radio transceiver has really come of age. Many of these units are great for mobile operation, but when it comes to fixed-station use, the transceivers can really come up short—primarily because of the comparatively high current values they draw on peaks.

The two-meter FM and police-scanner industries have given us a variety of 13.8-volt, low-current power supplies which in

many cases can be bought more cheaply than built. However, the seemingly rarified 13.8-volt, fifteen-Amp (or higher) power supply is not that easy to come by, which really limits the possibilities with transceivers drawing anywhere from sixteen to twenty Amperes.

Scanning the catalogs became a depressing experience for me, particularly when supporting one wife, three cats, and twelve hob-

bies on a pilot's salary. There are a number of excellent commercial power supplies available, but you can expect to pay an absolute minimum of \$100 for low-current versions and as much as \$300 for a power supply beefy enough to keep my Vibroplex Presentation dancing its way through the kilos and megas. Besides all that, my idea of a power supply is something that sits in a darkened corner, is not

seen, and is purely an accessory to my equipment. \$100? \$200? \$300? For a lousy power supply?

Occasionally, a magazine article has slipped through on the subject of 13.8-volt, high-current power supplies. Unfortunately, in many cases the authors have escaped the world of simplicity and featured components and techniques that are available easily only through NASA. Hence, I drew up a priorities list so that I could readily view my criteria for such a power supply: 1) cheap, 2) simple, 3) cheap, and above all, 4) cheap. I am one of those chicken-wire and chewing-gum types whose home-brewed projects are best characterized as "functional" and are best unseen. (At least with power supplies, anyway.)

My particular need was to supply power to an Atlas 210X. While my home station is basically a salvage yard for old boat anchors, six years or so ago I pressed the Atlas into mobile service. In fact, mobile operation is all my Atlas has ever seen. Until recently it has

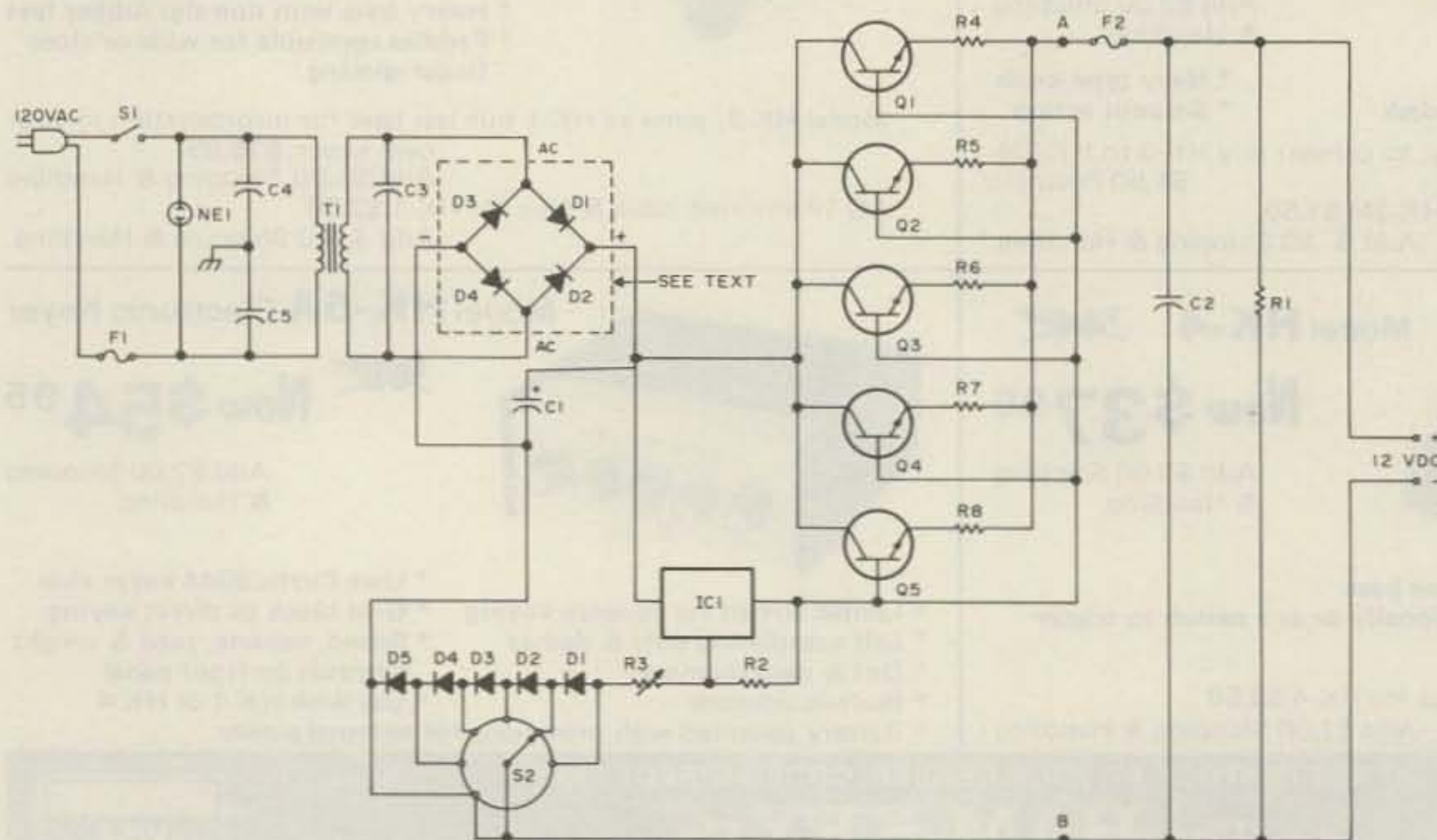

Fig. 1. Power supply schematic diagram.

never known the joy of taking a spike from the ac mains. Besides, with a dc supply, I could haul the 210X into the motel room, run coax out to the bumper mount, and dit-dah my eyeballs out.

Why not carry around a car battery and trickle charger, you ask? Too messy and cumbersome. Another option was to buy the factory-built console/power supply, but I heard rumors (only rumors) that the console/power supply left a little to be desired in the regulation department.

The Circuit

The power-supply circuit uses 2N3055 transistors. You can tailor your current capability by the number of pass transistors you use. I wanted a 25-Amp supply, so I used five 2N3055s. You can figure roughly one transistor for every 5 Amps you'll be drawing. In a 10-Amp supply, only two transistors would be used, and so on.

The 2N3055 is an NPN power device built into a TO-3 case. The 3055 is one of the more easily come by transistors and is very cheap (meeting criteria 1, 3, and 4). Because of the power these little devils are going to be dissipating, heat sinks should be employed. I used a heat sink with approximately 27 square inches of surface area with four half-inch fins, which cools nicely. Extreme heat can quickly mess up the transistor junction (not to mention a nice paint job). Before securing the transistors to the heat sink, apply some silicone thermal compound between the 3055s and the surface of the heat sink to provide a good positive heat transfer.

I have always used the rule of thumb that if you can't touch it, you can blow it. If you don't care to go heat-sink shopping, use

a cooling fan. If you use a fan in addition to the heat sink, be sure the air circulates in line with the fins. Blowing air perpendicularly to the fins sets up standing waves—the aerodynamic kind—and turbulence and the cooling effect is minimal.

Transistor-mounting hardware is nice, but I didn't feel that it was necessary. I attached the transistors directly to the heat sink and then mounted the whole heat-sink assembly on a sheet of Plexiglas™ attached to four standoffs. Since the transistor case is common to the collector, I tapped a screw into one of the heat-sink fins and this became my common collector tiepoint. It is important to keep all lead lengths constant. After drilling matching holes for the base and emitter pins in the heat sink, heavy-gauge wire was soldered (carefully) to each emitter pin through a 0.25-Ohm resistor, and then a second piece of wire was attached to each base pin. I then had only to connect the rest of the circuit to either the heat sink or one of the two bus wires.

You may or may not have difficulty locating a suitable transformer capable of taking 120 V ac and squeezing it down to 17 to 24 V ac. I was lucky enough to locate an old, beat-up, ex-battery-charger transformer at a hamfest which gave me 120/17 V ac. I think you will find old battery chargers to be a good source for the transformer you will need. Remember, the transformer must be capable of carrying the current you are going to draw from your power supply. I paid \$3.00 for my transformer and felt robbed; I have seen them for a dollar. Yes, you do take a risk, but remember, even if the transformer is no good, it is an excellent source of #14 AWG antenna wire (or larger)!

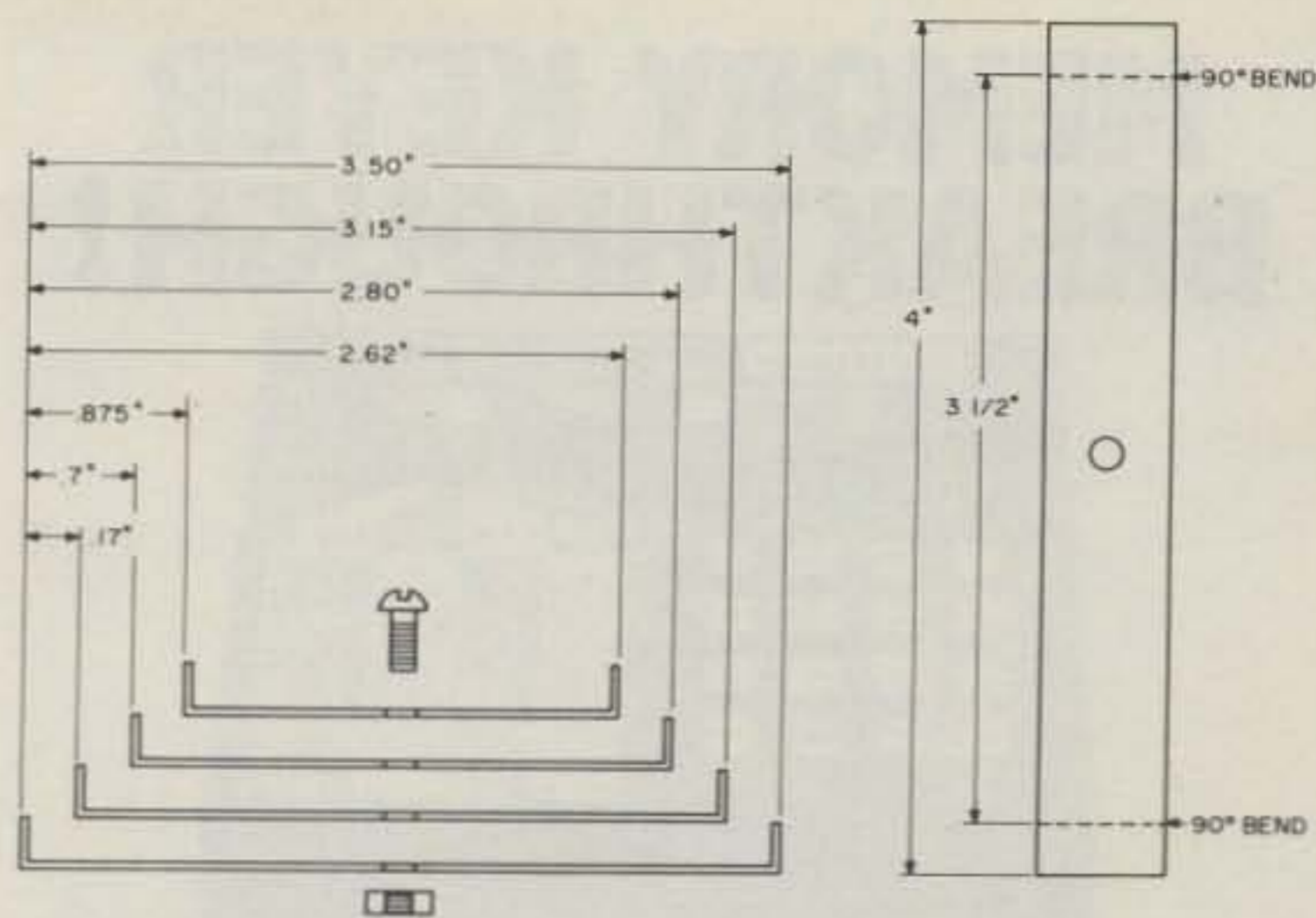

ALL DIMENSIONS IN INCHES

Fig. 2. Heat sink construction details.

In the rectifier circuit there are two avenues to follow. You can buy four diodes and make your bridge or you can do as I did and use one of the nifty one-inch-square epoxy bridge rectifiers. The little one-inch jobs are convenient because you don't have to mess around figuring which end is the anode and which is the cathode. Ordinarily, the epoxied bridges are simply marked AC, AC, +, and -. Can you beat that?

As always, no matter what you do for rectification, be sure your rectifier is rated for the current you will be needing. Most of the little square bridges are rated between 20 and 35

Amps. I am using a Semtech-Alpac 7905 only because I happened to have one on hand. Motorola, International Rectifier, VARO, and EDI make excellent equivalents.

Voltage regulation depends on adequate filtering and an IC known as a 7812. After much experimentation, I found that my voltage regulation (as well as hum attenuation) improved as I increased the value of filter capacitor C2. Starting out with 2000 uF, I worked my way upward to 13,000 uF. Though I now have a 37,000-uF filter capacitor in the circuit, 13,000 uF seemed to be enough. The amount of filtering achieved by going from

Parts List

- C1—13,000-uF, 25-V electrolytic capacitor
- C2—10-uF, 25-V electrolytic capacitor
- C3—0.22-uF, 100-V tubular capacitor
- C4, C5—0.01-uF, 500 V ceramic capacitor
- D1-D4—25-A diodes or epoxy bridge rectifier (see text)
- D1-D5—1N4004 diodes
- F1—Fuse, 5 Amp
- F2—Fuse, 30 Amp
- Q1, Q2, Q3, Q4, Q5—2N3055 transistors
- R1—120-Ohm 4-W resistor
- R2—3000-Ohm, 1/2-W resistor
- R3—500-Ohm, 1-W potentiometer
- R4, R5, R6, R7, R8—0.25-Ohm, 1-W resistor
- IC1—7812 voltage regulator
- S1—SPST switch
- S2—6-position wafer switch
- T1—120/17-24-V ac power transformer (see text)
- Miscellaneous: NE1 neon bulb, binding posts, line cord, 0-25-V dc voltmeter, 0-30-A ammeter, heat sinks, chassis, blower, fuseholders, and bulb socket.

MEMORY KEYSER BREAKTHROUGH!

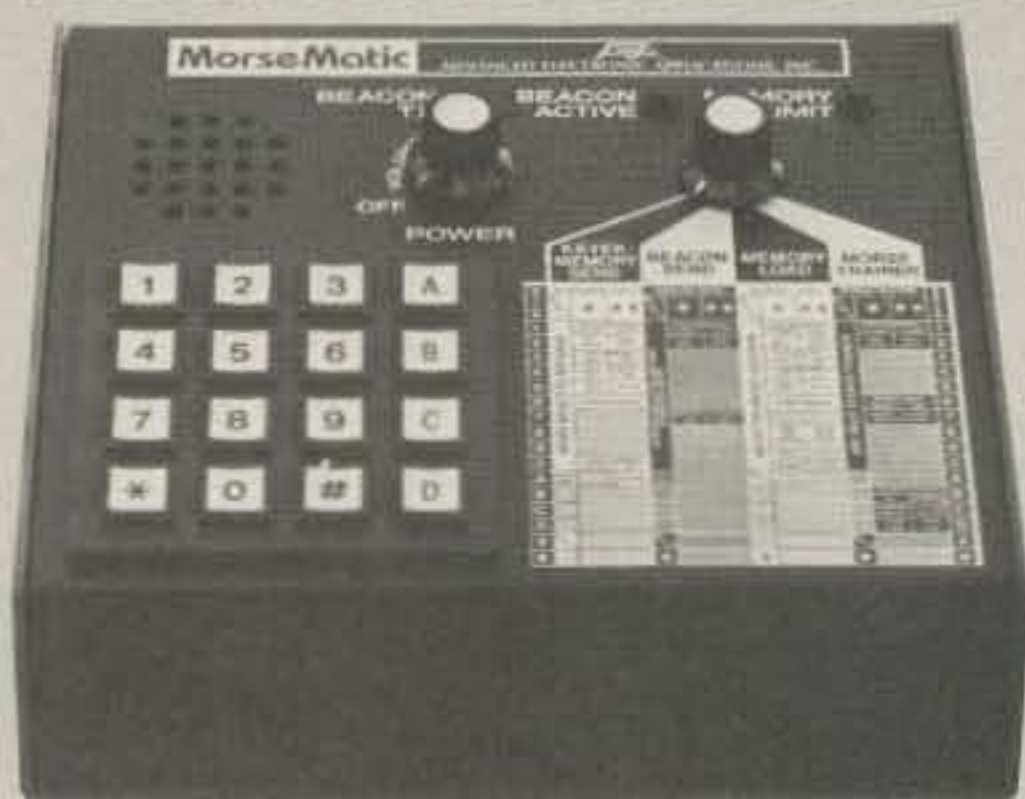

The remarkable AEA Morsematic memory keyer has 35 fantastic features including two AEA designed microcomputers, up to 2,000 character memory, automatic serial number, beacon mode, and automatic morse trainer mode.

CALL TODAY (406) 259-9554

Conley Radio Supply

318 N. 16th St., Billings, Montana 59101

AEA Brings you the Breakthrough!

13,000 to 37,000 μF is very, very slight and detectable only with a scope. Obviously one can't ignore the thought that if 13,000 μF is good, a higher value would be better, but let me caution you enthusiastic high-capacity freaks against installing 150,000- μF capacitors without limiting inrush current. I haven't experimented beyond 37,000 μF .

The 7812 voltage regulator is an IC device capable of maintaining excellent regulation as long as the input voltage falls between 14.6 and 19 volts nominally. A number of companies are producing the 7812 and it generally has some sort of prefix or suffix, but the digits remain the same.

In this circuit, the 7812 is above ground through a 200- to 500-Ohm resistor. I don't put an exact value on this because it is not that critical. Going from receive to full-output transmit on

my Atlas (300 mA to peaks of 16 Amperes), the voltage drop on the power supply is 0.4 V, which ain't bad. Since I normally don't run my equipment at full bore, the drop from receive to transmit is quite small.

As was the case with the pass transistors, I mounted the 7812 on a heat sink affixed to a small piece of Plexiglas on standoffs (to simplify its isolation from the chassis). The heat sink (see Fig. 2) is made of four strips of one-inch-wide aluminum cut at varying lengths and bent up a half-inch at each end. I then placed each one "inside" a larger one until, voilà, La Heat Sink a la Cheap. To keep the strips aligned, a hole was drilled which also served to attach the 7812.

While it isn't necessary, you can build in a selectable voltage feature by connecting any number of 1N4004 diodes on a wafer-

type switch. This switch goes between pin 3 of the 7812 and ground. (If this seems like a lot of hooey to you, you may disregard the above and connect pin 3 of the 7812 to ground through R3. You will see a voltage change of approximately 0.7 V with each position on the switch. With my supply, I have the capability of as much as 15 V or so, and the switch permits me to "switch down to" the proper voltage I desire (13.8 V dc).

The value of bleeder resistor R1 across the output is not critical either, but have something there for your protection.

By varying the resistance of R3, your output voltage will vary considerably. I believe a potentiometer instead of a fixed-value resistor is a better route so that more flexibility is available for future voltage needs which now might not be considered. As in my case, if you are receiving 16.8 V from your transformer, 250 Ohms is sufficient to yield the 13.8 V dc you want.

Should you be supplying your rectifier with 16 to 18 volts and not be getting a stable 13 volts or so, check to be sure that you are not losing (dropping) all of your voltage in your rectifier diodes or epoxy bridge. Some of the epoxy bridge rectifiers are poor in the area of voltage consistency. Try a different one, even of the same manufacturer. Another place to watch for voltage losses is in your wiring. The more current you draw, the higher your voltage drops may become in your transformer, rectifier, filter capacitor, or wiring. Wire which is too small may cause substantial voltage drops. I would suggest using #14 AWG wire at least.

H-u-m-m-m-m

My first test of the power supply was disastrous. Not

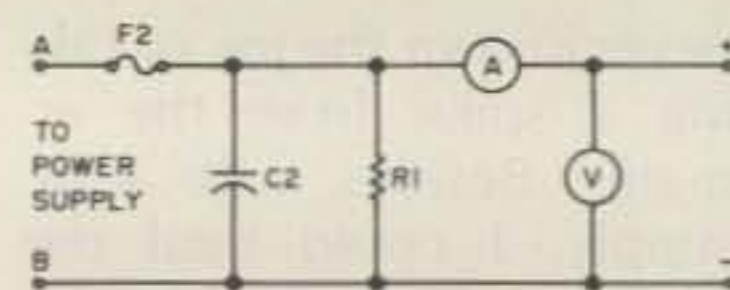

Fig. 3. Power supply metering arrangement.

only was the regulation terrible, but the audio was 80% hum, 20% ham. Two things lead to the elimination of hum: First (and already covered), I placed my voltage regulator above ground on the Plexiglas support; second, I connected all of my chassis ground connections to one point.

As with my other homebrew endeavors, I first mounted the power supply on an open chassis. Breadboarding can save you much agony when it comes time to actually fitting the darned thing in a permanent box. Scouting around at the Dayton Hamvention, I was able to come up with a perfect cabinet (which formerly was a microvolt meter) for \$1.00. When shopping for an enclosure, don't overlook old, non-working test equipment, etc.

Metering can be added easily as shown in Fig. 3. (When will the price of meters ever come down?)

The cost is going to vary depending on the state of your junk box and what kind of hamfest bargains you can locate. I spent more than I really wanted to, and that was slightly over ten dollars. You can't beat the pages of 73 Magazine for bargains on the components used here; it was from there that I purchased all of my purchased parts.

As you build this, take your time. Do a good job. Dress all of your leads. Use red wires for + and black wires for -. Take time to consider the aesthetics of this project. Then tuck it away in a dark corner and ignore it, because it's only a stupid power supply. ■

ATR-6800 gets '10 dB' boost



The proven RFI proof system for RTTY/CW is now available with applications program modules. Multiply your computer power to make amateur radio a real blast. Our first plug-in module adds 10 ham oriented programs such as: SSTV Transmit, Auto-CQ/Response, Mailbox, Log Keeper, and RTTY Speed-Seeker with more modules, including BASIC to follow soon.

All utility programs permanently stored in ROM ready to execute from the keyboard. Application module number one: \$189. Interface connector mounts on rear of the ATR-6800 free with first module. ATR-6800 with 9" monitor: \$1995, with companion printer: \$2445. There's never a dull moment here at Microlog Corp., 4 Professional Drive, Suite 119, Gaithersburg, MD 20760. Telephone: (301) 948-5307.



51

MICROLOG

Innovators in Digital Communications

Direct Printing FAX

— part III: testing and operation

In this third and last part of this article, I will cover preparation, testing, and operation of the facsimile recorder.

Initial alignment will require a frequency counter, a VOM, a logic probe, and a source of video—either a live signal from the receiver, a recorded signal, or the test generator of chapter 7 in the *Weather Satellite Handbook*. In the following sequence of tests, we will gradually add ICs to the board as each stage is tested. In all cases the unit should be powered down prior to inserting new integrated circuits. Damage to specific chips can result if you attempt to insert them with the board powered up. Preset the controls as follows:

POWER—OFF
WHITE SET—minimum (max. CCW)
VOC ADJ—midrange
DRUM—OFF
RESET/STANDBY/PRINT—STANDBY

The following checks are associated with the particular chips added to the board as we move along. If problems are encountered at any step, you should check the board wiring around the specific chips, measure the supply volt-

ages on the chips themselves, and try a replacement IC if it seems necessary.

1) Power up and measure the unregulated power supply voltages. You should get about 24-28 V from the LV supply and anything from 250-350 is acceptable on the HV bus. +5 and +12 volts should be obtained at the appropriate main board buses and the POWER lamp should be on.

2) Insert U3 and connect the frequency counter to pin 5 of this IC. Power up and adjust the VCO ADJ control for a reading of 2400 Hz.

3) Insert U4. The logic probe should indicate a high on the collector of Q6.

4) Insert U5 and U6. Connect the probe to pin 6 of U5 and use a test lead to momentarily ground the IC side of R21. The logic probe should indicate a relatively long pulse. Move the probe to pin 6 of U6 and again short the IC side of R21 to ground—a much shorter pulse should be indicated.

5) Insert U7. Press the PHASE switch and the PHASE ERROR lamp should come on and stay on. Use the test lead to ground the IC side of R21, and the PHASE ERROR

lamp should go out.

6) Insert U8 and connect the logic probe to pin 8 of U8. With the PHASE ERROR lamp off, the probe should indicate a steady high as the IC side of R21 is grounded with the test lead. Use another clip lead to ground the transistor side of R19. Press the PHASE switch and the PHASE ERROR lamp should come on and stay on even if you ground R21. The probe should indicate a short low each time R21 is grounded. Remove the clip lead from R19—the PHASE ERROR lamp should go out the next time you ground R21 and the probe should indicate a steady logic high from that point on.

7) Insert U9, U10, U11, and U12. The following frequencies should be noted as the counter is moved to the indicated ICs:

U9 (pin 8)—2400 Hz
U10 (pin 12)—240 Hz
U11 (pin 8)—60 Hz
U12 (pin 8)—60 Hz

8) Connect the VOM across the 115-V windings of T202 and set the instrument for ac volts (120-V min.). Turn the drum switch on and advance the DRUM LEVEL control for a reading of 110-115-V ac. The drum should now be rotating

away from you as you look at it from the carriage side. Momentarily pressing the MANUAL PHASE switch should cause the drum to slow slightly. It should stop if you keep the switch depressed.

9) With the drum revolving, connect the logic probe to pin 6 of U6 and a steady string of short, high pulses should be noted. If they are not present or are erratic, alter the position of the reed switch until you get a steady pulse indication. Depress and hold the PHASE switch and note the PHASE ERROR lamp. It should be on but should blink off very briefly once for each drum revolution. Release the PHASE switch and the PHASE ERROR lamp should go off at once. Turn off the DRUM switch.

10) Temporarily disconnect the TRAVERSE cable. Set the VOM to dc volts (350 min.) and connect the positive lead to the stylus probe. A reading of 240 V ($\pm 10\%$) should be obtained when the RESET/STANDBY/PRINT is cycled to PRINT. No voltage should be noted with the switch in the RESET or STANDBY position. Return the switch to STANDBY.

11) Connect the TRAVERSE cable and cycle the RESET/STANDBY/PRINT switch to PRINT. The carriage should begin to move away from the traverse motor. If the switch is cycled to RESET, the drive nut should begin to move back toward the traverse motor. Leave the switch in the STANDBY position and unplug the TRAVERSE cable.

12) Connect a source of video to the VIDEO INPUT jack. Unless otherwise noted, all of the following adjustments will be made during the phasing interval preceding picture transmission. This interval is a steady 2400-Hz tone, interrupted by the short phasing pulses. Insert U1 and U2.

13) Temporarily connect a speaker from the negative side of C7 to ground. Advance the WHITE SET control and you should hear an undistorted reproduction of the video signal. As the video level is increased, cycle the RESET/STANDBY/PRINT switch to PRINT and monitor the stylus voltage. (Each time you check the stylus voltage, the switch should be in the PRINT position. Keep it in STANDBY between these measurements to avoid the possibility of a shock hazard.)

14) As the WHITE SET control is advanced, the stylus voltage should gradually decrease and the meter indication should bounce up very slightly with each phasing pulse. Continue to advance the WHITE SET control and you should reach a point—between 25 and 35 volts—where the voltage will drop no lower. Retard the WHITE SET control to the point where you first reach this low-voltage threshold. If you watch the voltage during actual data transmission, it will fluctuate between the low and high voltage limits.

15) Observe the VCO LOCK lamp—it should light whenever video is applied to the input and should remain lighted throughout a frame transmission.

16) Connect the logic probe to the collector of Q6 and adjust R14 for a steady stream of logic highs during the phasing interval.

17) Turn the drum on and press the PHASE switch at the completion of the start tone. The PHASE ERROR lamp will come on and you may be able to hear a slight difference in the sound of the drum motor, indicating that it has slowed slightly. The lamp should go off sometime within about 15 seconds, depending upon the initial phase error.

At this point, all the major systems have been checked out. The last remaining step is to prepare the wire stylus and condition it. Cut one of the wires from a wire brush (one intended for use in an electric drill) and straighten it with a pair of needle-nosed pliers. The wire need not be completely straight, as some remaining curvature will assist in holding it in the stylus holder. Insert the wire into the protruding stylus tubing and trim the end so that it extends about 1/16" out of the end of the tube. Wrap a piece of fine emery paper around the drum and secure it with transparent tape. Rotate the stylus assembly such that the wire contacts the emery paper, and observe the orientation of the wire. If it is tilted slightly, it should be tilted in the direction of drum movement—that is, it should point toward the back of the drum. If it points toward the front of the drum, remove the wire and reinsert it so that it is tilted in the proper direction. Turn the drum and allow the stylus to run in contact with the rotating emery paper for a period of 30 seconds or so. The end of

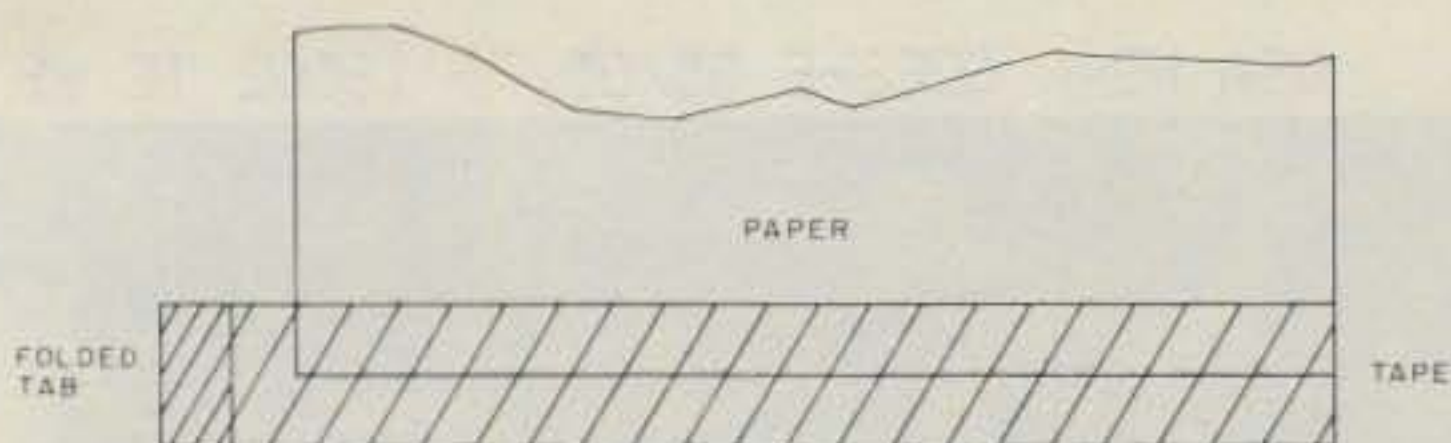

Fig. 1. Paper preparation and manipulation. The tape is placed along one edge of the paper as shown. The opposite edge is then inserted under the aluminum foil strip on the drum and the drum is rotated to wrap the paper around the drum. The edge of the paper with the tape will then completely overlap the foil strip and the tape can be smoothed down to secure the paper to the drum. Removal of the paper is accomplished by lifting the small tab at the end of the tape strip and carefully peeling the tape away from the paper surface. A strip of tape can be reused several times if handled carefully.

the wire will be quite rough initially, but you should be able to hear a considerable difference in sound as it smoothes out under the abrasive action of the paper. Remove the emery paper and prepare for the moment you have been waiting for—your first picture!

Operation

Three different papers have been used to date, all of which work quite well, although there are some advantages to one over the others. The preferred paper is that manufactured by Xerox® for their Telecopier™ office facsimile machines. Contact the nearest Xerox office and request reorder number 3R830. The paper is 8.5" × 11" and comes in packages of 150 and 500 sheets. The cost is lower in 500-sheet lots, and you can save still more by ordering two boxes of 500 sheets at one time.

A paper equal to the Xerox is Timefax NDK, manufactured by Fitchburg Coated Paper Products of Scranton PA. The main difficulty is getting Fitchburg to supply the paper in small lots. They have yet to prove the least bit cooperative, and the Xerox paper is much easier to obtain. If you can get the Timefax NDK, it will do an excellent job.

3M, Inc., of Minneapolis

MN makes a similar paper for its line of office fax machines, and the price is in line with that of Xerox. While it will do a good job, I have found the 3M paper to be somewhat smokey in operation and it doesn't seem to yield as nice a gray scale as the Xerox paper despite the claims of the sales reps. It is quite possible that it functions best at a slightly lower maximum printing voltage, so I wouldn't say to avoid it if it is the easiest paper for you to obtain. You might try substituting a 100-V zener for D5 to bring the printing voltage down to 220-V maximum if you plan to use the 3M paper.

All of the papers come in the standard 8.5" × 11" size and must be cut down to 7" × 7" for use on the recorder. A small office paper cutter set up with wooden stops is the fastest way to cut the paper to size. With a good cutter, you can slice up to 10 sheets at a time.

Loading the Paper. The printing side of the paper is the smooth white surface—the back looks slightly mottled and is a little rougher in texture. Lay the piece of paper—printing side up—on a table and strip off a piece of transparent tape (the high-quality translucent variety is best) about 7.5" long. Fold over one end to make a little tab so that you can strip

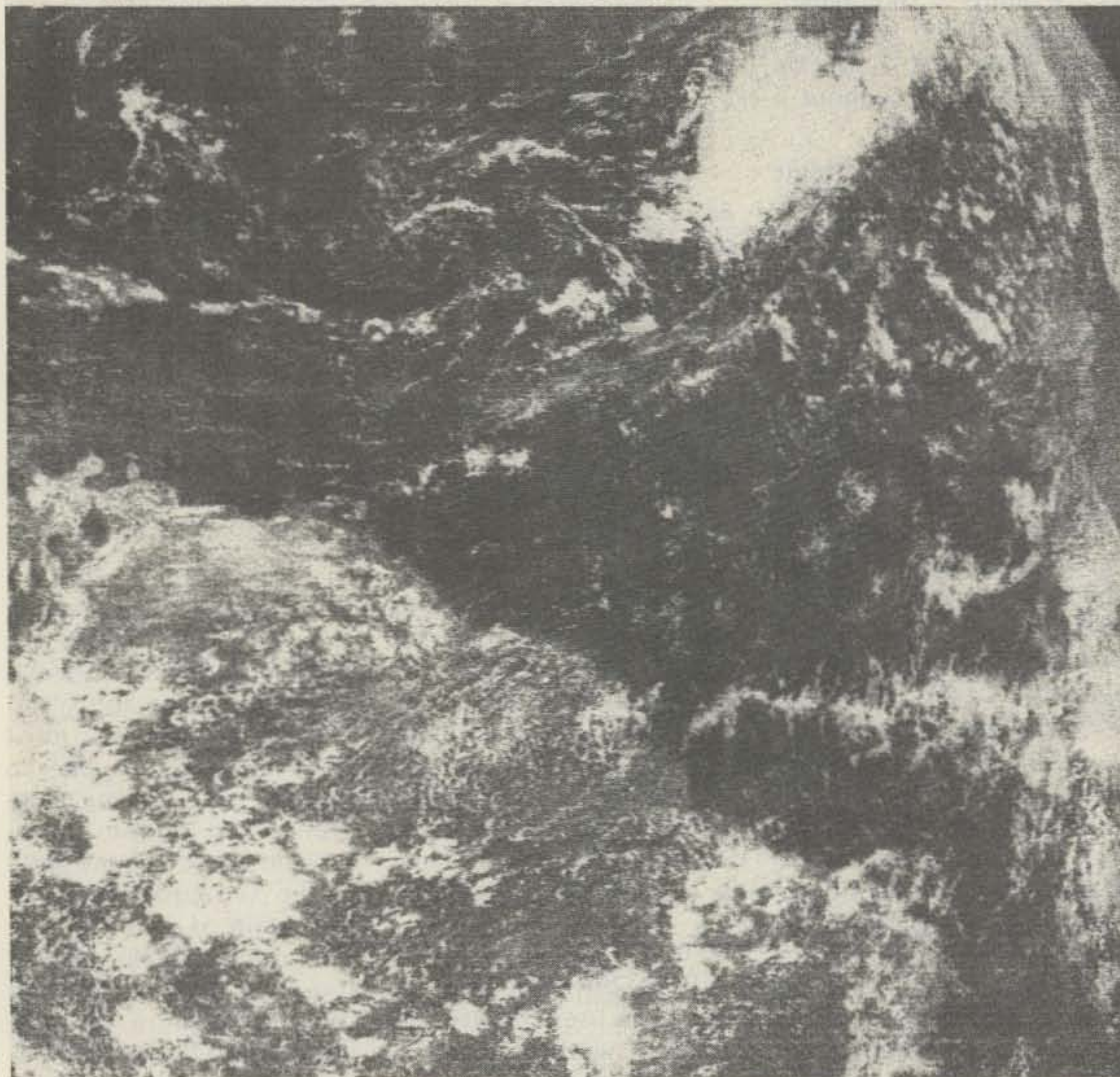

Fig. 2. An example, from a GOES E Tropical East quad, of the excellent resolution obtained with the FX-2E direct-printing recorder. These fine cloud details could be resolved with a photographic system, but extreme care in focusing the light gun would be required. The direct-printing option, because a wire stylus is used, always yields optimum resolution without the need to worry about focusing the system.

the tape off later. Lay the tape over one edge of the paper as indicated in Fig. 1.

Cycle the RESET/STANDBY/PRINT switch to RESET until the drive nut reaches the right end of the drive rod. Slide the edge of the paper opposite the tape under the folded strip of foil and, holding the paper against the drum with your fingers, rotate the drum away from you, wrapping the paper around the drum. When you get all the way around, the paper should overlap the foil strip and you can smooth down the tape to secure the paper to the drum.

Position the carriage so that the stylus rests just inside the right margin of the

paper. Remove the stylus from the paper and cycle the switch to PRINT. The drive nut will move back toward the carriage. Guide the brad over the base of the carriage and cycle the switch to STANDBY when the drive nut starts to move the carriage. Rotate the stylus assembly to place the stylus back on the paper and you are ready to go.

Printing. When the GOES carrier comes on, turn on the drum. At the completion of the start tone, press the PHASE switch. Some time within about 15 seconds of this action the PHASE ERROR lamp should go off, indicating the drum is in phase with the incoming signal. Twen-

ty seconds after the end of the start tone, cycle the RESET/STANDBY/PRINT switch to PRINT. When the frame starts, you should be able to see the effect on the drum as the stylus moves along. When the stop tone arrives, cycle to STANDBY, stop the drum, remove the stylus, and take off your picture by carefully stripping off the strip of tape. If you put the tape carefully aside, you can use it for quite a few prints.

Optimizing. If this is your first print, it is not likely to be perfect—it probably will be too light. To optimize the WHITE SET control, start the printing during the phasing interval and carefully watch the paper as

you back off the WHITE SET control. The optimum setting is where you can just see the slightest darkening of the surface at the printing stylus.

The reset procedure can be shortened somewhat by locating the proper start position for the carriage and running the drive nut up against the carriage as noted. Slide the carriage away from the nut and use india ink to mark the glass where the brad contacts it. In the future when you reset the drive nut, simply run it back to the mark you have made and then you can move the carriage up against it, knowing that the stylus is properly located.

Operation with TIROS/NOAA or METEOR Imagery

A triggered oscilloscope is used to phase the incoming picture when the FX-2E is used to display pictures from polar-orbiting spacecraft. Connect the TRIGGER jack to the scope trigger input and the VIDEO OUT jack to the scope vertical input. What you will get is a video waveform display triggered by the fax drum. With a little experience, you will be able to recognize the position of the line sync pulses on the scope display. Set the recorder up as described and when the signal is solidly out of the noise and with the drum running, simply press the MANUAL PHASE switch in short bursts until the line sync pulse is aligned with the left edge of the scope display. At this point, the RESET/STANDBY/PRINT switch can be cycled to PRINT until the carriage reaches its limit of travel.

Alternatively, if you have built the CRT monitor of chapter 4 of the *Weather Satellite Handbook*, you can use it for phasing display. Connect the video input to the monitor in parallel with that of the fax and

lift the diode connected to point B in Figure 4.6 of the *Handbook*. Connect the TRIGGER output to this point, and the monitor display will now trigger from the fax drum. In practice, it is easiest to install an EXTERNAL TRIGGER jack to the back of the monitor, connected to the TRIGGER output of the FX-2E. An SPST toggle switch (INTERNAL/EXTERNAL TRIGGER) can then be added so that you have switch-selection of either internal or external triggering. The internal position is used for normal monitor operation or when the fax drum is not running (saving wear and tear on the horizontal deflection transistors), while the external position is used to manually display and phase the fax. To use the monitor in this fashion, you should reset the fax carriage and load paper as instructed. Start the drum, and switch the monitor to EXTERNAL TRIGGER. When the signal is out of the noise, you can start the monitor sweep and operate the MANUAL PHASE switch of the FX-2E to move the line sync pulse (either visible or IR) to the left edge of the viewing area. At that point, you can start the fax printing.

Operation as a Photographic Facsimile Recorder

The only electronic changes for photofax operation include the following:

- 1) Delete R9, R10, D5, D6, Q2, and R11.
- 2) Replace R8 with a 100-Ohm pot, which will serve as a BLACK SET control.
- 3) Add a 15-mA meter in the switched 300-V line.
- 4) Connect an R1130B glow modulator tube from the collector of Q1 to the 350-V bus, with the 15-mA meter in series. Rewire S201A so that the lamp is energized (connected to the 350-V line) with the

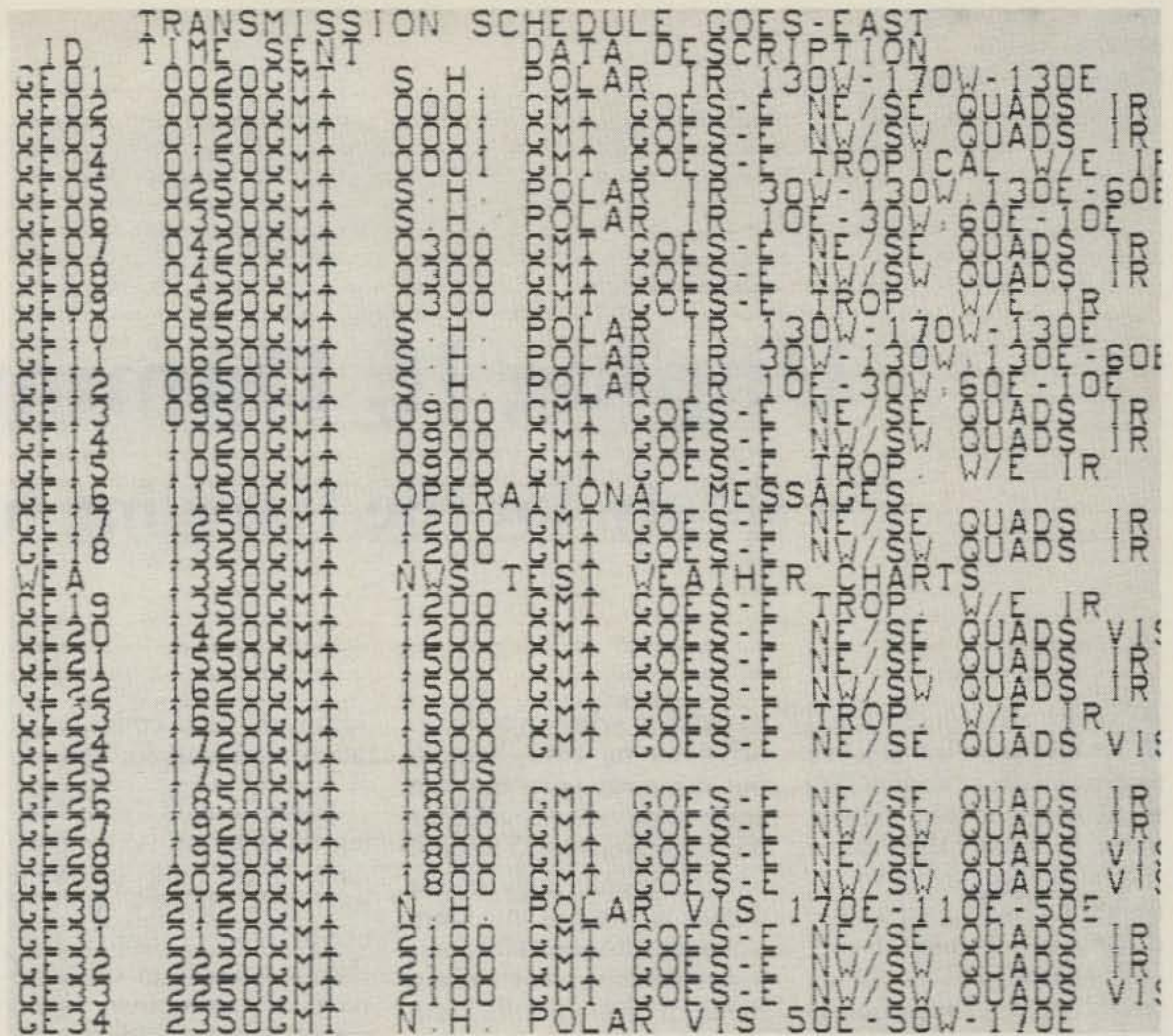

Fig. 3. Direct-printing readout of a GOES E operational message, showing the excellent printing clarity which is obtained.

switch in the PRINT position.

5) Reverse the diodes (D1-D4) in the detector, delete R7, and replace it with a 2200-Ohm resistor connected between the base of Q1 and the +12-V bus.

Refer to either the first edition of the *Weather Satellite Handbook* or the September and October, 1975, issues of 73 for construction of the light gun and its mounting to the carriage. The phase-sensor reed switch will have to be reoriented so that it closes just as the edge of the photographic paper passes the light gun lens.

With no video input, adjust R8 (BLACK SET) for a meter reading of 15 mA with S201 in the PRINT position. Full video drive (white level) should then be applied and the WHITE SET control adjusted for a read-

ing of about 1 mA. Resin-coated enlarging papers are recommended for printing, with Kodak Kodabrome RC being preferred (normal contrast grade). Black and white level adjustment should be altered in practice to produce good prints when the paper is processed for 2 minutes in Kodak Dektol developer. Any commercial fixer may be used, and you should consult your local photographic supplier for trays, chemicals, safelights, etc. The aluminum foil strips and ground connections will not be required on the drum and can be omitted. When used in the photofax mode, the recorder must be operated in a darkroom with suitable safelight illumination to protect unexposed paper. The paper can be cut to the required 7" x 7" in the darkroom.

Although the recorder

will produce superb photographic prints, I have not operated it in the photographic mode since first setting up the direct-printing version (see Figs. 2 and 3). The fax system is certainly somewhat more complicated a project than a CRT monitor, primarily due to the mechanical aspects of the project. Once finished, however, it should give you years of trouble-free service. The prototype of the photographic facsimile version has been in operation for over two years without a single problem, and there is no reason to assume that the direct-printing version will not have the same reliability. The FX-2E system is virtually ideal in that it provides for easy operation, low operating costs, immediate availability of good-sized prints, superb resolution, and photographic image quality. ■

Unplug It, Dummy!

— safety for the traveling ham

For those recreational vehicles which have provisions for connecting to 110-volt outside power, there is always the risk of the owner forgetting to unplug the power cord before driving off. Human frailty and Murphy's Law being what they are, this is bound to happen sooner or later.

For us, the reckoning came one time when we had our camper van parked in our driveway while we were packing for a trip. We had the cord plugged into our house power for pre-cooling the refrigerator. Getting off later than we had hoped, we took off in a hurry. When we got to our first stop, we were horrified to find the socket from our extension cord sitting in the van power receptacle. The cord had pulled right out of

its socket when we drove off, meaning it was lying in our driveway with the live ends exposed. Mindful of the neighborhood children who frequently play in our driveway, we put in a frantic long-distance call to our local police, informing them of the situation and asking them to do something about the hazard. Fortunately, no further harm came of it.

To preclude any repetition of this fiasco, I installed a cord alarm in our van. It is arranged so that a door bell rings if the ignition is turned on while the cord is plugged in. You can install such an alarm in your RV for an expenditure of about \$15 for parts—less than the cost of a power cord that might be ruined by a drive-off. It does the

same job as a commercial alarm that sells for \$50.

You will need the following three items: (1) An ordinary door bell, installed near the driver's seat. I chose a door bell rather than a buzzer in order to have a distinctive alarm sound that would not be confused with the seat-belt warning buzzer. (2) A bell transformer of the type designed to mount in a knock-out hole in a junction box. Be sure to get a 10-volt transformer rather than a 16-volt type, which is for chimes. (3) A 12-volt dc relay (Radio Shack #275-208 or equivalent).

Attach the bell transformer to an unused knock-out hole in the power control center or the junction box for the outside power receptacle. (Confinement of the 110-volt wiring to the inside of such a box makes for a very safe installation.) Connect the primary wires to the 110-volt power at the point where it enters the vehicle, with no circuit breakers or other switching devices intervening so that the alarm will not fail to operate because of a breaker or switch being turned off. (Protection against short circuits in the transformer is given by the circuit breaker feeding the

outlet into which the cord is plugged.)

Make a bracket for the relay socket out of sheet metal or aluminum angle and mount the relay in a convenient location. Wire up the system as shown in Fig. 1, soldering all connections to the relay socket. The transformer is connected to the bell in series with a pair of normally-open contacts on the relay. One end of the relay coil is connected to chassis ground, and the other end is connected to a circuit that is energized when the ignition is turned on. Pick a circuit that is energized only in the "ignition" position of the switch, and not the "accessory" position. For our Econoline van, a convenient connection point was the wire feeding power to the seat-belt warning system.

With these connections, turning on the ignition operates the relay and completes the circuit from the transformer to the bell so that it will ring if the transformer is powered by the cord being plugged in.

What if you remember to unplug the cord but forget to stow it? This alarm is foolproof but it is not claimed to be *damn-foolproof!* ■

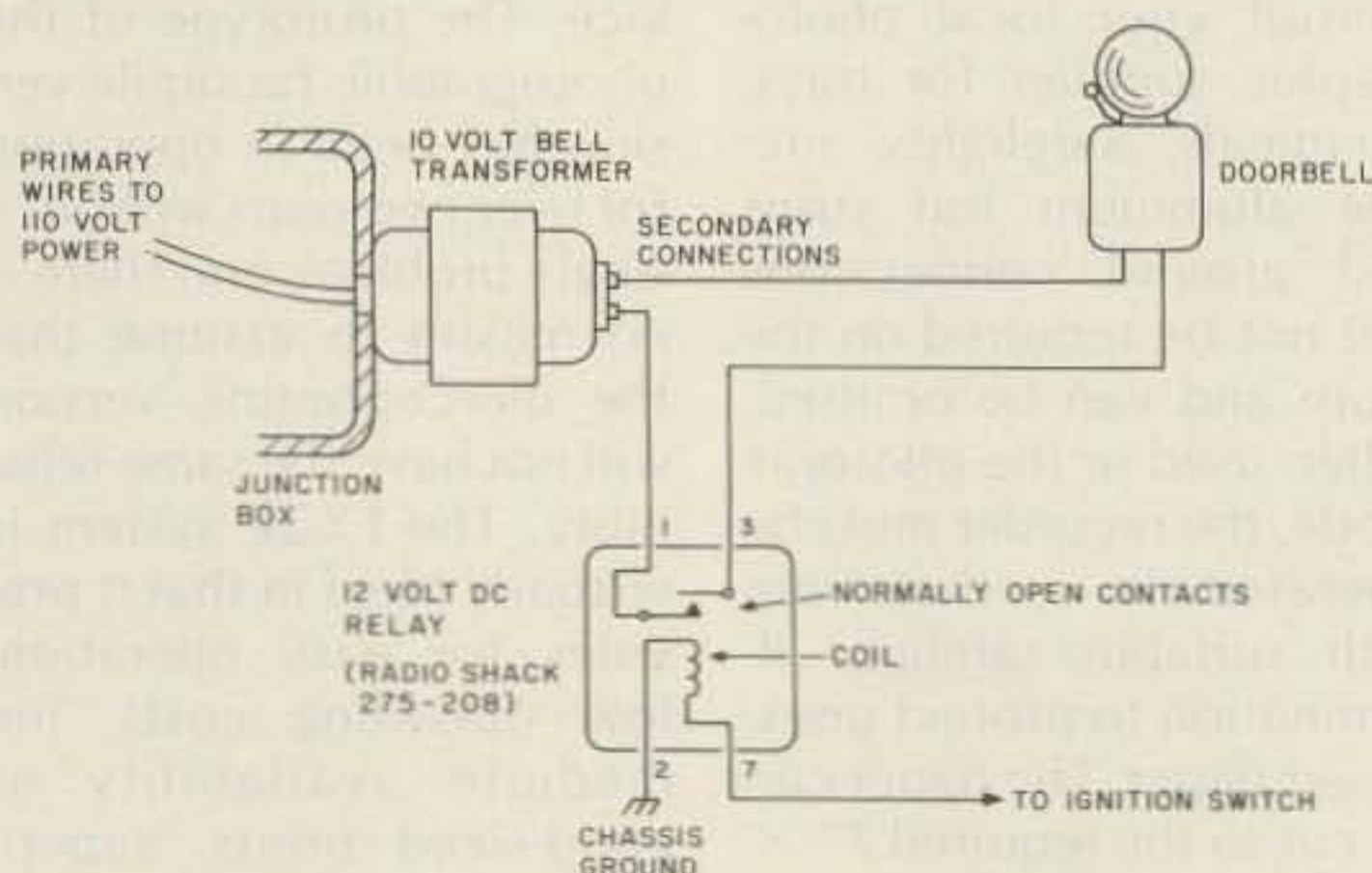

Fig. 1. Wiring diagram of the cord alarm.

FORMULA FOR 2 METER FM ENJOYMENT

4
x RELIABILITY

=



CLEGG FM-88

LIMITED TIME SPECIAL

\$279.00

143-149 MHz

.25 uv sensitivity

mobile mount & microphone included

25 Watts (variable)

Provisions for non-standard splits
(CAP, MARS, etc.)

Optional AC power supply available

Holiday Special

THAT'S CORRECT!!!

We are convinced that the FM-88 is four times more reliable than the other 2 meter rigs being offered. To prove it to you, we are supplying the FM-88 with *four times* more warranty than supplied with other models—One full year instead of the normally expected 90 days.

While there are radios on the market that offer lots of "gadgets"—our past experience

Phone 1 (800) 233-0250 today to order your FM-88 or to request a detailed brochure describing this fantastic transceiver & related accessories.

has been that simplicity of operation & elimination of unnecessary "Bells & Whistles" actually removes the causes of many failures being experienced with such transceivers.

If you are shopping for a new 2 meter transceiver, don't you owe it to yourself to go with a radio that has proven itself with thousands of hours of reliable, "On the Air" operation?



Clegg

✓13

Communications Corp.
1911 Old Homestead Lane
Greenfield Industrial Park East
Lancaster, PA 17601
(717) 299-7221

Power Plus for the Omni

— improving on Ten-Tec's power supply

The Ten-Tec Omni (#252-MO) power supply is a fine unit, but there are some improvements that can be made. I am sure competition dictates just how much a manufacturer can put into a piece of equipment, but there is no reason ham operators cannot make a few usable modifications themselves. The modifications I made were relatively simple, and I now have a better and more useful power supply.

My first modification was to install a chassis-mounted ac receptacle to

be powered whenever the power switch is turned on. This provides a switched source for a cooling fan. By doing this, my cooling fan is on any time that my power supply is on and I cannot forget to turn it on (see Fig. 1).

My next undertaking was to install an overvoltage protection (crowbar) circuit. This is a must to protect expensive gear from being zapped should a pass transistor become shorted and allow excessive high voltage to reach places it should not! The crowbar circuit described in the

August issue of 73 Magazine (page 90) by K9MLD was used. (See Fig. 2). All of the components were mounted on a three-lug terminal strip with the exception of the 25-Amp SCR, which was mounted on a bracket of its own. Space is no problem. I used a 2N685 SCR which must be isolated from ground, as the stud is the positive terminal. Fuse installation is very simple. With a fuse holder mounted on the back cover of the power supply near the top edge, the red wire from the pass transistor can be cut near the center and connected to the fuse holder without disconnecting either end of the wire.

the power supply. Should you have a variable power source available, the trim-pot can be adjusted to gate the SCR at 15 V and marked at that position. After installation in the power supply, the trimpot can be turned to test for proper operation, and when testing is completed, returned to the marked (15-V) position. During checkout, the current limiter (not the fuse) was shutting down the power supply inadvertently. This apparently was being caused by rf getting on the gate of the SCR, causing the SCR to conduct. The installation of the two .01 caps corrected this problem (see Fig. 2).

With this circuit connected to the 13.8 positive voltage line, should the SCR be gated by an overvoltage signal, the SCR will short the 13.8 positive voltage line to ground and blow the fuse, thereby positively disconnecting the output of

There was no reason to have two 12-volt power supplies in my shack (one for my Omni and the other for other equipment such as the 2m rig), so I set out to eliminate the home-brew job and use the Ten-Tec #252MO for everything.

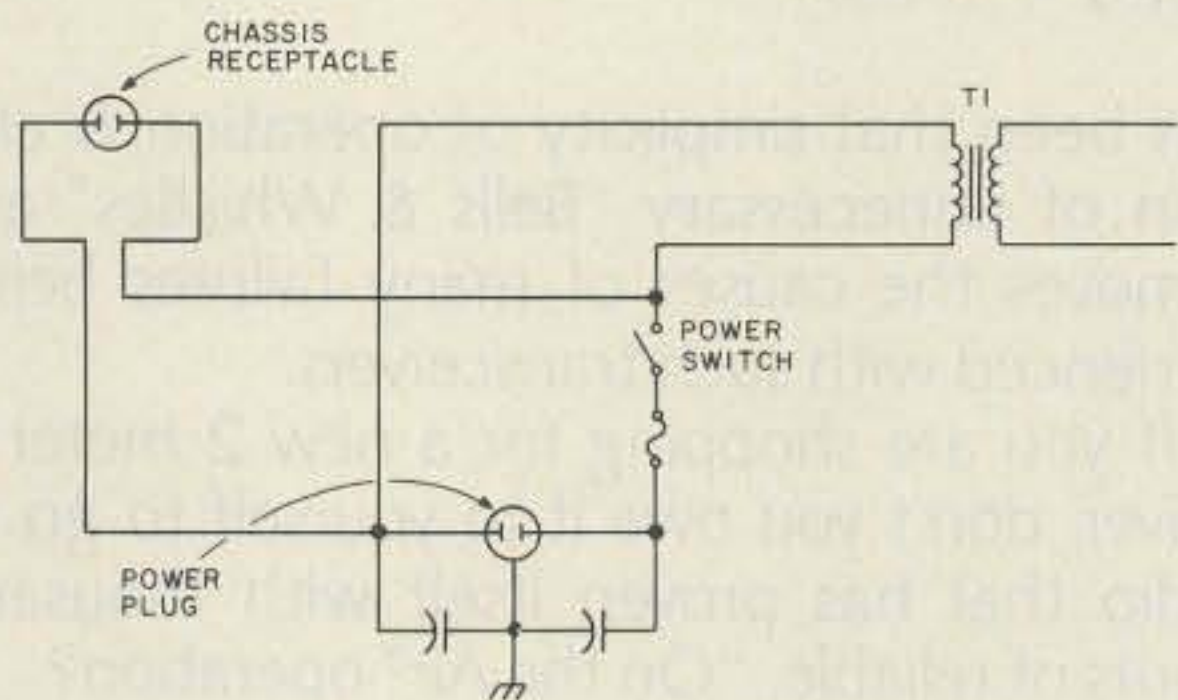

Fig. 1.

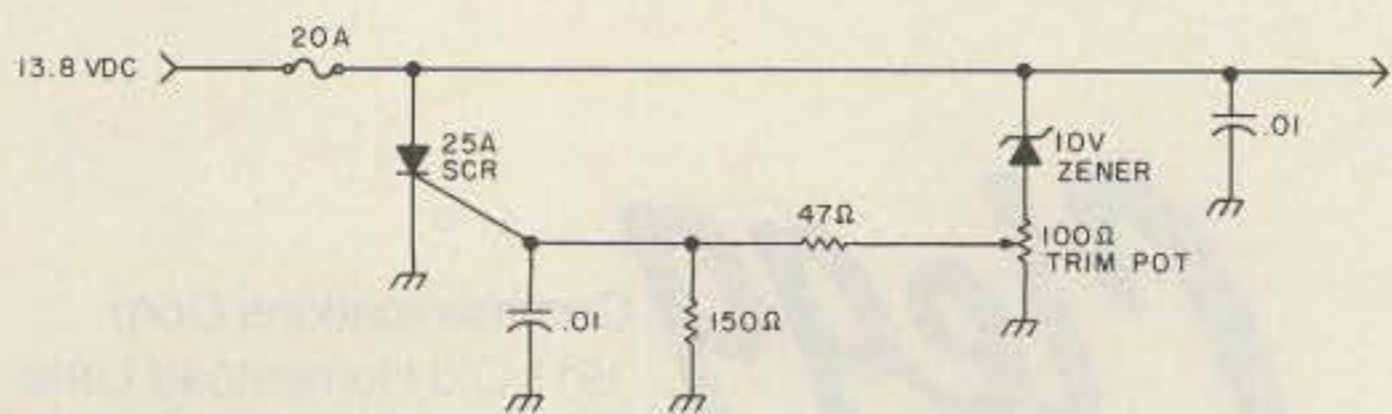

Fig. 2.

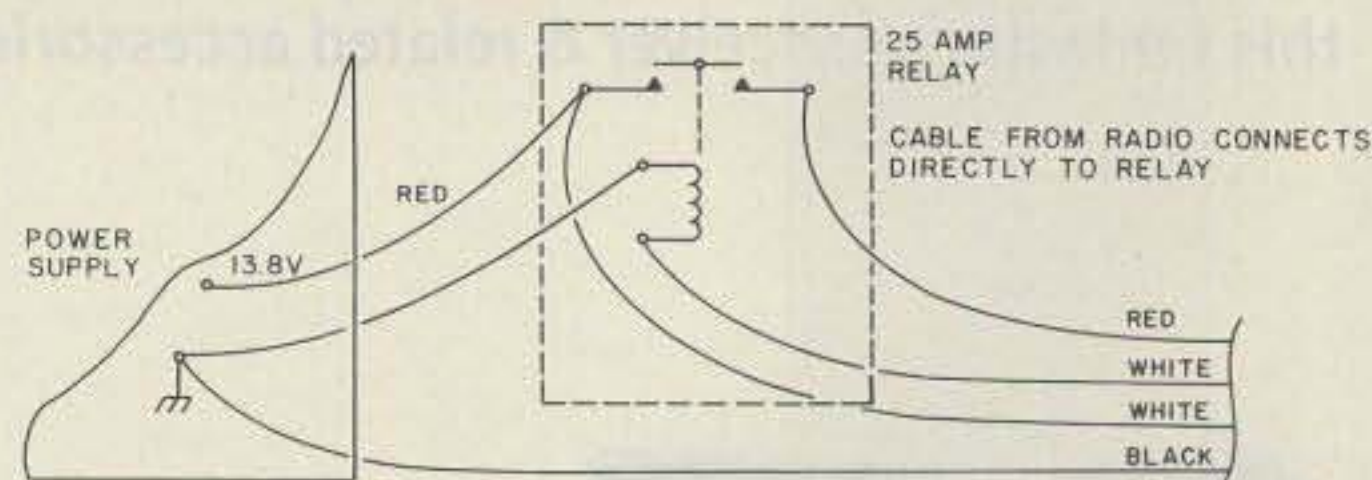

Fig. 3.

The manufacturer designed it to be turned on by the power switch on the Omni in series with the on/off switch on the front of the power supply. The power supply could not be turned on and used without the Omni being turned on as well. A simple rearrangement of the 115-V ac wiring in the power supply bypassed the switch on the radio and allowed the power supply to be turned on by the switch on the power supply only (see Fig. 1).

To control the 13.8 V dc to the Omni, a 25-Amp Potter & Brumfield #PR5DY relay was installed, as suggested in the owner's manual. The relay coil is controlled by the switch on the Omni through the two center wires of the cable between the power supply and the radio. Now my Ten-Tec power supply can be turned on without turning the Omni on (see Fig. 3).

Note: To facilitate mounting the relay, the two auxiliary phono jacks and their associated wiring were removed and discarded, and two banana plug type jacks were installed in the front panel, with wiring capable of handling the total output of the power supply. This makes 13.8 V dc readily available for anything in the shack with current limiting and overvoltage protection.

So, Ten-Tec owners, if you are of the mind to do a little improving of your equipment, the details are left to your discretion, imagination, and ingenuity. I might add that the #252M and #252MO are identical electrically, so these modifications apply to both. The peace of mind that comes from having the overvoltage protection is reward enough, not to mention the good feeling of knowing that I did it myself! 73. ■

Reach Out!

just like adding a 10-watt amp to your 2-meter hand-held...

- True $\frac{5}{8}$ wave gain antenna
- Dramatically boosts reception as well as transmit range
- Individually tuned matching network
- Base spring/tuned coil protects radio as well as antenna from accidents
- Extends to 47", telescopes to only 8"
- BNC connector fits most current hand-held and portable radios
- Better than 1.5:1 VSWR across the entire 144-148 MHz band
- Only \$24.95 from your dealer or postpaid from VoCom

(Illinois residents please include 6% sales tax)

Ask about our 25, 50 and 100 watt amplifiers for hand-helds

VoCom ⁹⁰

PRODUCTS CORPORATION

65 E. Palatine Rd., Suite 111
Prospect Heights, IL 60070

(312) 459-3680

Dealer Inquiries Invited



ASSOCIATED RADIO

8012 CONSER BOX 4327
OVERLAND PARK, KANSAS 66204

913-381-5900

BUY—SELL—TRADE

All Brands New & Reconditioned



We Want to DEAL—Call Us—We'll Do It Your Way.
WE'RE #1



NOTE: SEND \$1.00 FOR OUR CURRENT CATALOG OF NEW AND RECONDITIONED EQUIPMENT.

★ ALSO WE PERIODICALLY PUBLISH A LIST OF UNSERVICED EQUIPMENT AT GREAT SAVINGS.
A BONANZA FOR THE EXPERIENCED OPERATOR.

TO OBTAIN THE NEXT UNSERVICED BARGAIN LIST SEND A SELF ADDRESSED STAMPED ENVELOPE.

Oddball Offsets for the KDK-2015R

— make a good rig better

Did you ever wish you could program any offset into the 2015R? If so, read on. Here is a cheap (\$0-\$5, depending on your junk box) modification which will do just that, without drilling any holes or installing any extra switches. The KDK has all you need and

even has the correct labels on one of the switches. The offset frequency can be programmed into the memory in the normal manner, and the KDK will display transmit and receive frequencies when the PTT switch is operated. It does not interfere with the nor-

mal function of the memory scanner, either.

All of the tools that are needed to do the job are a small soldering iron, a Phillips screwdriver, dikes, and perhaps a pair of tweezers or hemostats. The only materials needed are an SPDT reed relay with a 10-V coil, two diodes, some hookup wire, and solder.

Study the diagram (Fig. 1) so that you will understand the hookup and proceed as follows:

1. Remove the four

screws from the case and remove both halves.

2. Turn the rig on its back with the antenna connection facing you.

3. Locate SW8 (Fig. 2) and lift the yellow wire from tab "A". Insulate the end with spaghetti.

4. Solder a diode between the tab marked "A" and the tab marked "SIM"; observe polarity.

5. Solder a piece of hookup wire to the tab marked "A". The length of the hookup wire will depend on the make of switch you use and where you locate it. This is all of the work to be done on SW8.

6. Locate SW6 (Fig. 3) and lift the violet wire from the tab marked "COM".

7. Solder a piece of hookup wire to the violet wire and cover the splice with spaghetti.

8. Solder a piece of hookup wire to the tab marked "4". This is a tight place; be careful not to melt any wires.

9. Select the place to install the reed relay. I put mine on the rear side of the CONT-2010 board on the

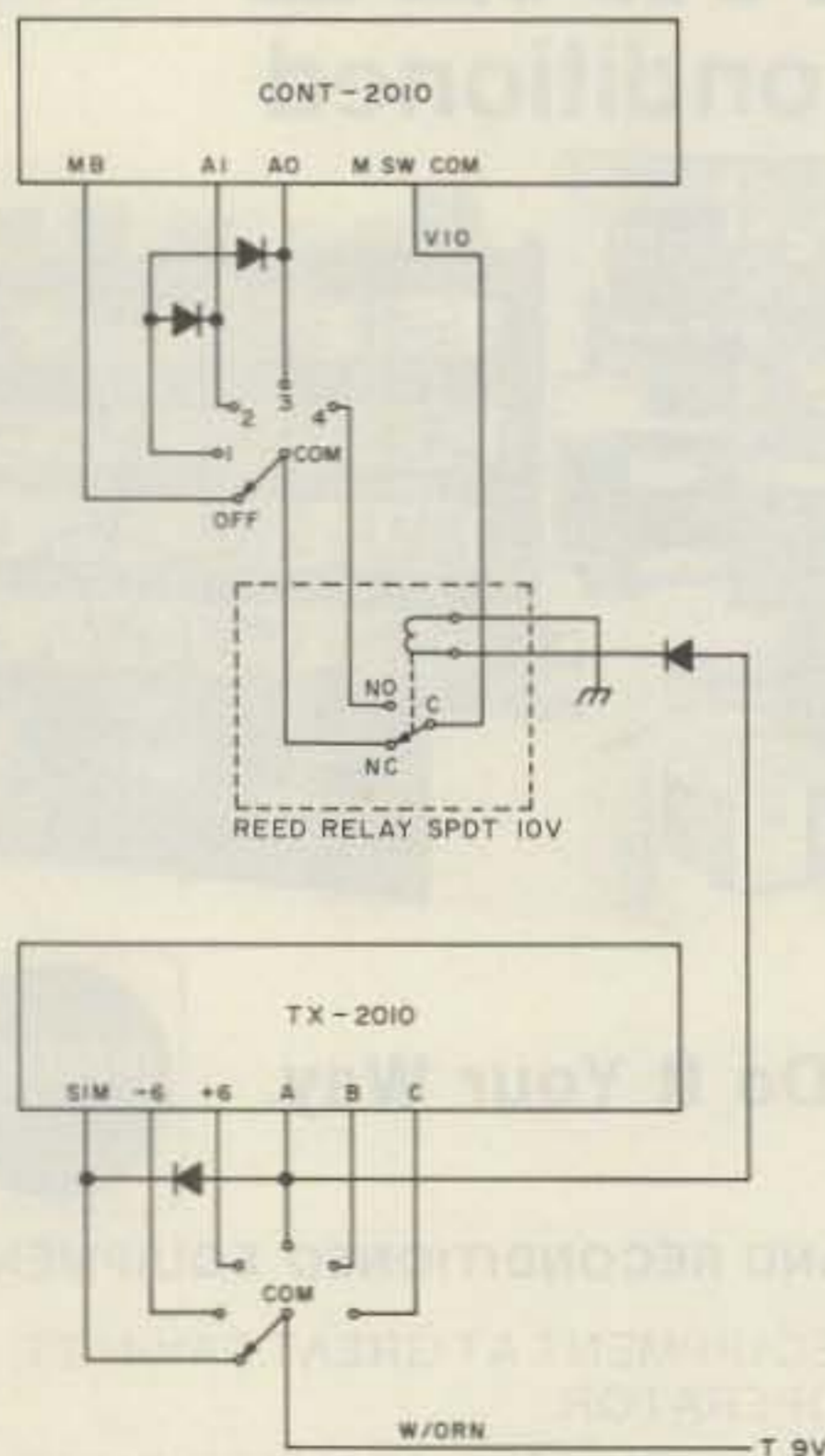

Fig. 1.

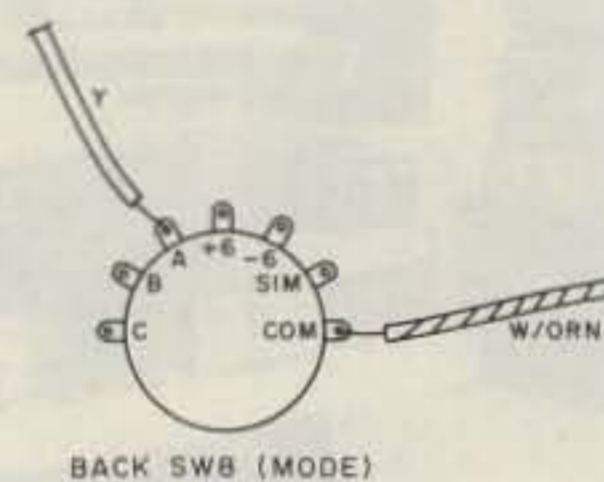

Fig. 2.

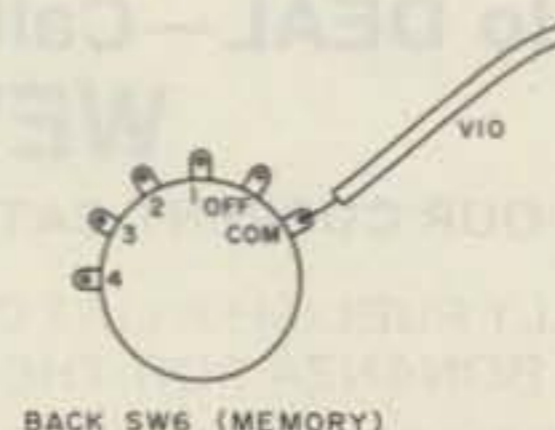

Fig. 3.

left-hand end in front of L6 and L7 on the PLL-2010 board, with the connections pointing up. It can be fixed in place with Silastic™.

10. Place a solder lug under the front-left corner screw on the PLL-2010 board.

11. Solder a piece of hookup wire to the solder lug.

12. Solder the other end of this wire to one side of the relay coil.

13. Solder a diode to the other end of the relay coil. Observe polarity.

14. Solder a wire from SW8, tab "A" (step 5) to this diode.

15. Solder the extension of the violet wire (step 7) to the common terminal of the relay.

16. Solder a piece of hookup wire to SW6, tab "COM" (step 6) and solder the other end to the NC contact of the relay.

17. Solder the wire from

SW6, tab 4 (step 8) to the NO contact of the relay. This completes the modification. Be sure that none of the connections will touch the case. Check your wiring and install the case halves.

To operate, program the transmit frequency into the number 4 memory in the normal manner. Set the receive frequency on the vfo. Place the mode switch in the "A" position. Place the memory switch in the OFF position.

Now for the moment of truth. Press the mike button and, presto, the transmit frequency programmed into the number 4 memory is displayed. Release the button and the receive frequency in the vfo is displayed.

This modification works well, costs about the same as one offset crystal, takes about an hour of your time, and is fairly easy to do. Have fun! ■

Orbit



ORBIT is the Official Journal for the Radio Amateur Satellite Corporation (AMSAT), P.O. Box 27, Washington, DC 20047. Please write for application.

For a **FREE SAMPLE COPY** please send \$1 to cover First Class Postage and handling to: Orbit, 221 Long Swamp Road, Wolcott, CT 06716.

TIMETRAC

By Comus

the microcomputer-controlled
appointment clock

NEW
First Time Offer

— NOT A KIT —

Limited Offer by

HAL-TRONIX

only \$49.95

plus \$2.00



Shipping & handling charge

FEATURES:

- Sleek modern styling to complement any home or office decor.
- Tells the time.
- Tells the date and year.
- Up-timer to 60 minutes, 59 seconds with pause.
- Alarm to ring at the same time everyday.
- Daily appointment sets appointments for the next 23 hours, 59 minutes.
- Future appointments up to one year.
- Dimmer switch for display.
- Memory will hold up to 30 appointments.
- Lithium power cell to retain memory during power outage.
- Appointments entered out of chronological order will be stored in chronological order.
- Colon flashes once each second.
- A.M./P.M. indicator.
- Plugs into any wall outlet.
- Easy to read vacuum fluorescent display.
- Extremely accurate quartz crystal clock.

EFFICIENT. REMARKABLE.

TimeTrac sold and distributed by HAL-TRONIX. Dealers welcome.

Send 15¢ stamp or S.A.S.E. for information and flyer on other HAL-TRONIX products. To order by phone: 1-313-285-1782.



"HAL" HAROLD C. NOWLAND
W8ZXH

HAL-TRONIX

P.O. Box 1101
Southgate, MI 48195

SHIPPING
INFORMATION:

ORDERS OVER \$20.00 WILL BE SHIPPED POSTPAID EXCEPT ON ITEMS WHERE ADDITIONAL CHARGES ARE REQUESTED. ON ORDERS LESS THAN \$20.00 PLEASE INCLUDE ADDITIONAL \$1.50 FOR HANDLING AND MAILING CHARGES.

The Strange Predicament of Walter Hann

—OE8WHK did the right thing—
and suffered the consequences



Walter Hann OE8WHK, prosecuted after rendering life-saving communications assistance.

Robert B. Grove WA4PYQ
Grove Enterprises, Inc.
Rt. 1, Box 156
Brasstown NC 28902

It was a foggy Monday, August 13, 1979, when Walter Hann OE8WHK switched on his Bearcat 101 scanner. Immediately, the scanner locked onto a local police channel and Hann learned of a frantic rescue attempt being conducted in the picturesque Austrian Alps a few miles from his home.

But the communications

was by no means routine. A local ham radio operator, OE8PPK, was unwittingly causing interference on a nearby amateur frequency, preventing the police from making radio contact with the rescue helicopter hovering nearby, desperately searching for the injured victim.

Walter Hann grabbed the microphone of his two-meter Icom IC-215 and immediately called OE8PPK to urge him to QRT so that the rescue mission could proceed. The other ham dutifully complied, thanking Hann over the air for alerting him.

This initial episode was the very essence of amateur radio at its best: A ham radio operator, aware of a life-saving attempt being threatened by a communications problem, takes immediate action to solve the interference problem. Unfortunately, the story did not end there, for in Austria it is illegal to possess a radio capable of monitoring police calls.

The interfering transmissions of OE8PPK had been

tape-recorded by the police for follow-up, and now they heard Walter Hann's name and callsign being announced by the involuntary intruder.

Because Hann is an employee of the Austrian government, identification came quickly. Officials rapidly made the 20-km journey from Klagenfurt to St. Veit/Glan, Hann's QTH, and there confronted his wife.

Although Hann was no longer at home, the PTT officials demanded access to the ham shack where they siezed the Bearcat and made note of all other equipment owned by Hann.

The next day Hann was summoned to Klagenfurt for a three-hour interrogation. His inquisitors wanted to know where he got the equipment, how it cleared customs, who else had such equipment, and other details about his monitoring hobby.

Since Hann is employed by the government, he was dealt with harshly. He was forced to forfeit the Bearcat receiver and pay a steep



A small segment of Walter Hann's listening post.

DOUBLE YOUR PLEASURE

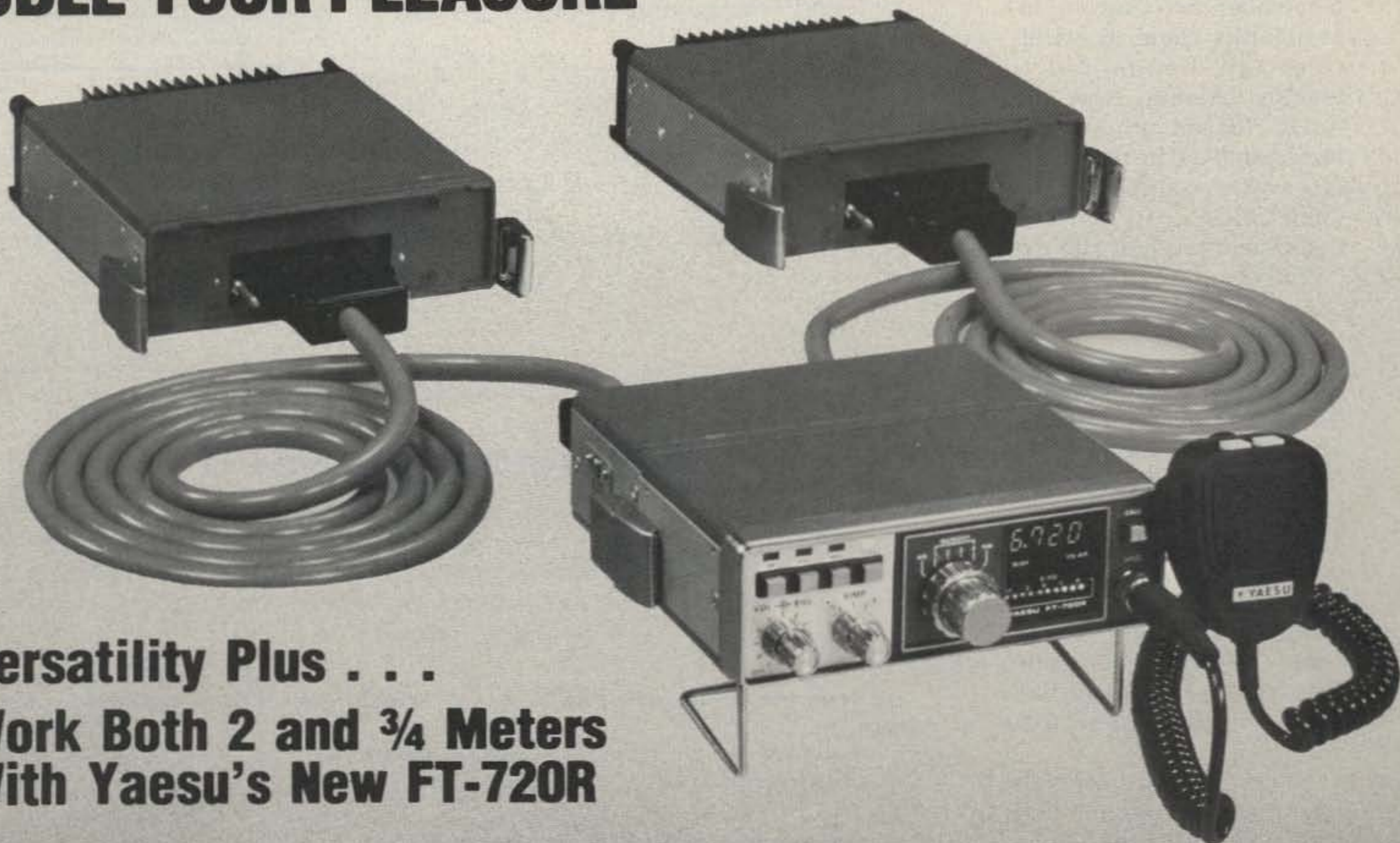

Versatility Plus . . . Work Both 2 and 3/4 Meters With Yaesu's New FT-720R

The FT-720R series is a compact VHF/UHF mobile transceiver that harnesses the incredible power of the microprocessor to bring you top-operating flexibility. Start with the FT-720R Control Head, then add either the 10 watt FT-720RU 440 MHz or 25 watt FT-720RVH 2 meter RF Deck. You can clamp the Control and RF Deck together or use an optional remote cable to hide the RF Deck. The best news is still to come! By using the optional S-72 Switching Box and two remote cables, you can use a single Control Head for operation with both the 440 MHz and 2 meter decks, giving you a high-performance two band FM station for your car or home. Compare the features below, then ask your dealer for a demonstration of the fabulous FT-720R series. . . another winner from the performance leader . . . Yaesu.

- Four simplex/repeater memory channels, plus receive-only memory channel.
- Scanning controls on microphone with search for busy or clear channel.
- Optional 32 tone CTCSS module for accessing private repeaters.
- Colorful, easy-to-read LED power output/S meter.
- Built-in 1800 Hz tone generator.
- Priority channel with search-back feature.
- Pause feature that holds, then restarts scan, on busy or clear channels.
- Digital display of last four digits of operating frequency.
- Single Control Head may be used for operation on both 440 MHz and 2 meters via optional switching box and remote cables.
- Extremely compact size, light weight.

FT-720RVH	Specifications	FT-720RU
144.00-147.99 MHz	Frequency Coverage	440.00-449.975 MHz
10 kHz	Synthesizer Steps	25 kHz
25 watts	Power Output	10 watts
.32 uV for 20 dB quieting	Sensitivity	0.5 uV for 20 dB quieting
±6 kHz (-6dB)	Selectivity	±12 kHz (-6dB)
±12 kHz (-60 dB)		±24 kHz (-60 dB)

YAESU
The radio.



480

Prices And Specifications Subject To Change Without Notice Or Obligation

YAESU ELECTRONICS CORP., 6851 Waltham Way, Paramount, CA 90723 ● (213) 633-4007
YAESU ELECTRONICS Eastern Service Ctr., 9812 Princeton-Glendale Rd., Cincinnati, OH 45246

fine. But that wasn't all. In November, two Customs investigators came to his office and conducted a lengthy hearing. How did the BC-101 get into Austria? How much did he pay? Who else owns similar equipment? How was his ham equipment brought into the country?

Hann owned a Drake R-4B, an SPR-4, and an FS-4 synthesizer, a Barlow-Wadley SCR-30, a HAL RVD-1002 RTTY demodulator, a Collins 51J3 receiver, and many other pieces of gear. The officious officials pointed out that unless Hann could produce legal proof of customs clearance, they would conclude that all the equipment had been smuggled into Austria.

Since Customs officials could not determine that Hann had used the equipment in the commission of an illegal act, he was not imprisoned. But he has been assessed heavy fees for additional duties, fined for the act of listening to a private communication, and is now awaiting additional disciplinary action because of his government position with the Austrian Finance Administration (Customs). This action will probably be both verbal and punitive, and Hann expects his salary to be cut.

Investigators then intruded into Hann's private papers, looking for evidence of illegal activities, confiscating a letter from an American colleague who offered to send him a Bearcat 250 scanner.

In the United States, any citizen is permitted by law (Section 605, 1934 Communications Act) to monitor for his own personal interest any radio communication of any nature, just as long as he does not disclose the contents to another person or use the information

Post- und Telegraphendirektion für Kärnten in Klagenfurt als
Fernmeldebehörde I. Instanz
 9020 Klagenfurt, Sterneckstraße 19

Zustellung zu eigenen Händen

(Behörde)

GZ. 2 4 9 1 5 - 3 / 7 9 Klagenfurt, am 29. August 1979

An Herrn Walter HANN, Finanzbeamter,
 Neubaugasse 23
 9300 St. Veit a.d. Glan

Beschuldigten-Ladungsbescheid

Es wird Ihnen zur Last gelegt, in der Zeit von 2. Juni 1979 bis 13. August 1979 in St. Veit an der Glan eine Funkempfangsanlage, welche zum Empfang von nicht für die Allgemeinheit bestimmten Aussendungen geeignet ist, ohne fernmeldebehördliche Bewilligung verwahrt, errichtet und betrieben

und dadurch ~~eine~~ Verwaltungsübertretung ^{gem.} nach § 26 des Fernmeldegesetzes, BGBl. Nr. 170/1949, begangen zu haben.

Gemäß § 40 Abs. 2 und § 41 des Verwaltungsstrafgesetzes werden Sie aufgefordert, unter Mitnahme dieses Ladungsbescheides und

zur Vernehmung — mündlichen Verhandlung —
 am Mittwoch, den 12.9. 1979, 9 00 Uhr
 bei diesem Amte, II. Stock, Zimmer Nr. 132

~~beim Amtstag in~~ persönlich zu erscheinen oder einen mit der Sachlage vertrauten und schriftlich bevollmächtigten eigenberechtigten Vertreter zu entsenden. Die Vollmacht ist stempelpflichtig.

Gleichzeitig werden Sie aufgefordert, die Ihrer Verteidigung dienlichen Beweismittel mitzubringen oder diesem Amte so zeitlich anzuzeigen, daß sie zur Vernehmung herbeigeschafft werden können.

Im Falle ungerechtfertigten Ausbleibens wird gemäß § 41 Abs. 3 des Verwaltungsstrafgesetzes das Strafverfahren ohne Ihre Anhörung durchgeführt werden. ~~haben Sie gemäß § 19 Abs. 3 des Allgemeinen Verwaltungsverfahrensgesetzes Ihre zwangsweise Vorführung zu gewärtigen.~~

Gegen diesen Bescheid ist zufolge § 19 Abs. 4 des Allgemeinen Verwaltungsverfahrensgesetzes kein Rechtsmittel zulässig.

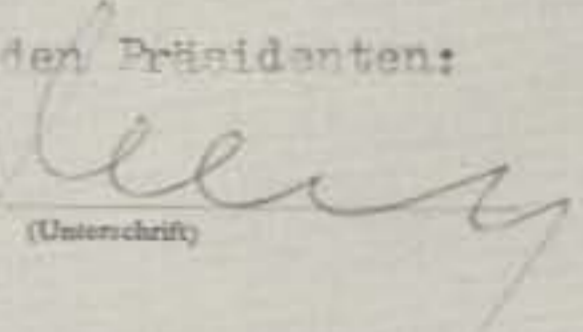
den Präsidenten:

 (Unterschrift)



Formular 30 zu § 41 VStG. (Beschuldigten-Ladungsbescheid für Behörden, die zugleich Vollstreckungsbehörden sind.)
 VwV. 1-2011. BMZL 79.349-4/68. — Österreichische Staatsdruckerei, L.0010859

Official summons served by the Austrian PTT.

for his own personal gain. But an unsettling spectre has appeared on the horizon. A number of new interpretations, prospective amendments, and even an entire rewrite of the Communications Act threaten to undermine the American privilege of listening in. The catalyst for these ac-

tions has been the common-carrier television industry, disturbed because of the prospect of home TV viewers picking up satellite programs direct without having to pay subscriber fees. Law enforcement agencies are also concerned about the use of scanners to evade apprehension. Several bills are

now on the floor of Congress intended to limit our constitutional right to listen. Will it be the conscientious amateur community who will protest the implementation of these restrictions on our rights? Only you can answer that question. ■

GOOD DELIVERY!



on

* KENWOOD

* YAESU

* ICOM

* TEN-TEC

* TEMPO

* DRAKE

* DENTRON

* COLLINS

* INFO-TECH

* SWAN

OUR PRICE IS RIGHT!

CALL TOLL-FREE

1-800-325-3636

HAM RADIO CENTER³²
8340-42 Olive Blvd. • P.O. Box 28271 • St. Louis, MO 63132



Put "the Rep" in Your Repeater

— an automatic autopatch dialer

O.C. Stafford K4ALS
3702 Holts Chapel Rd.
Greensboro NC 27401

The circuit described in this article makes use of the repertory dialer chip, the MK5170, made by Mostek. The chip is a 3870 micro-computer that has been programmed to act as a repertory dialer. The pin connections diagram is shown in Fig. 1. The unit can be programmed with only approved phone numbers for later dialing.

Continuing changes and interpretations of FCC rules indicate that autopatch facilities attached to amateur repeater stations must be monitored to prevent the abuse of the autopatch.

Because of these requirements and other restrictions, numbers of clubs have discontinued the use of their autopatch facilities or else now have a very limited operation. Some clubs have disintegrated over the issue of autopatches. One solution, however, is to use a control operator to monitor the calls.

One of the big problems facing owners of repeaters equipped with autopatch is the ability to control the numbers being dialed. Another problem is that some people make calls which are not really legal or are not in the best interests of ham radio. Now you can control what gets dialed, with the Rep.

The chip can be addressed by a touchtone™ pad in a minimum-hardware configuration. It will store up to 100 phone numbers which can be loaded and retrieved with a two-digit access code. The circuit diagram for the 100-number system is shown in Fig. 2. If a system with 24 numbers or fewer is needed, the memory circuit of Fig. 3 can be used.

I have tried to include enough hardware and logic on the board to make the circuit easier to interface with systems other than the Buffington phone patch and control system which has been described in past issues of *73 Magazine*.² That system will be used to show how the unit can be interfaced.

PIN CONNECTIONS

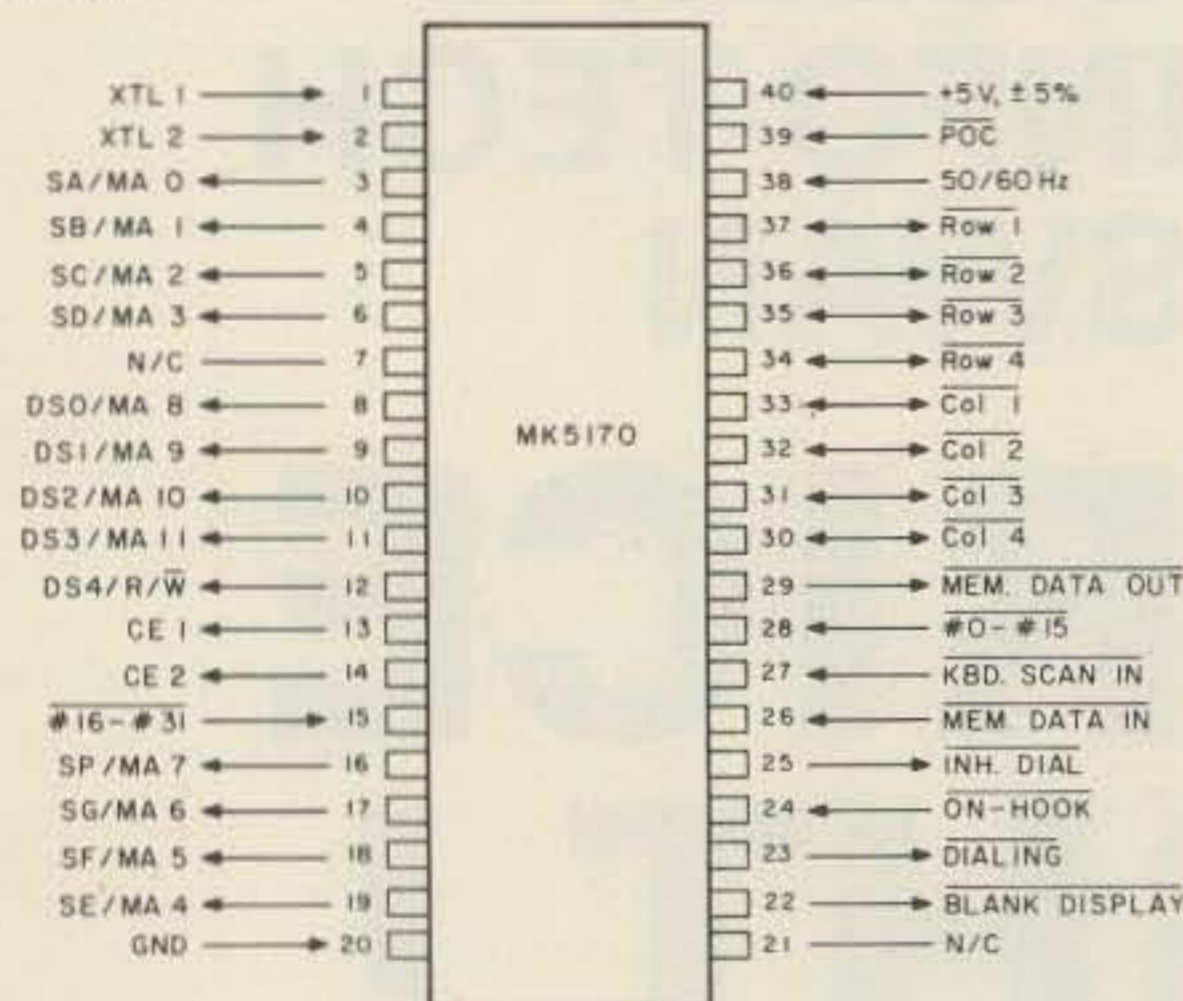

BLOCK DIAGRAM

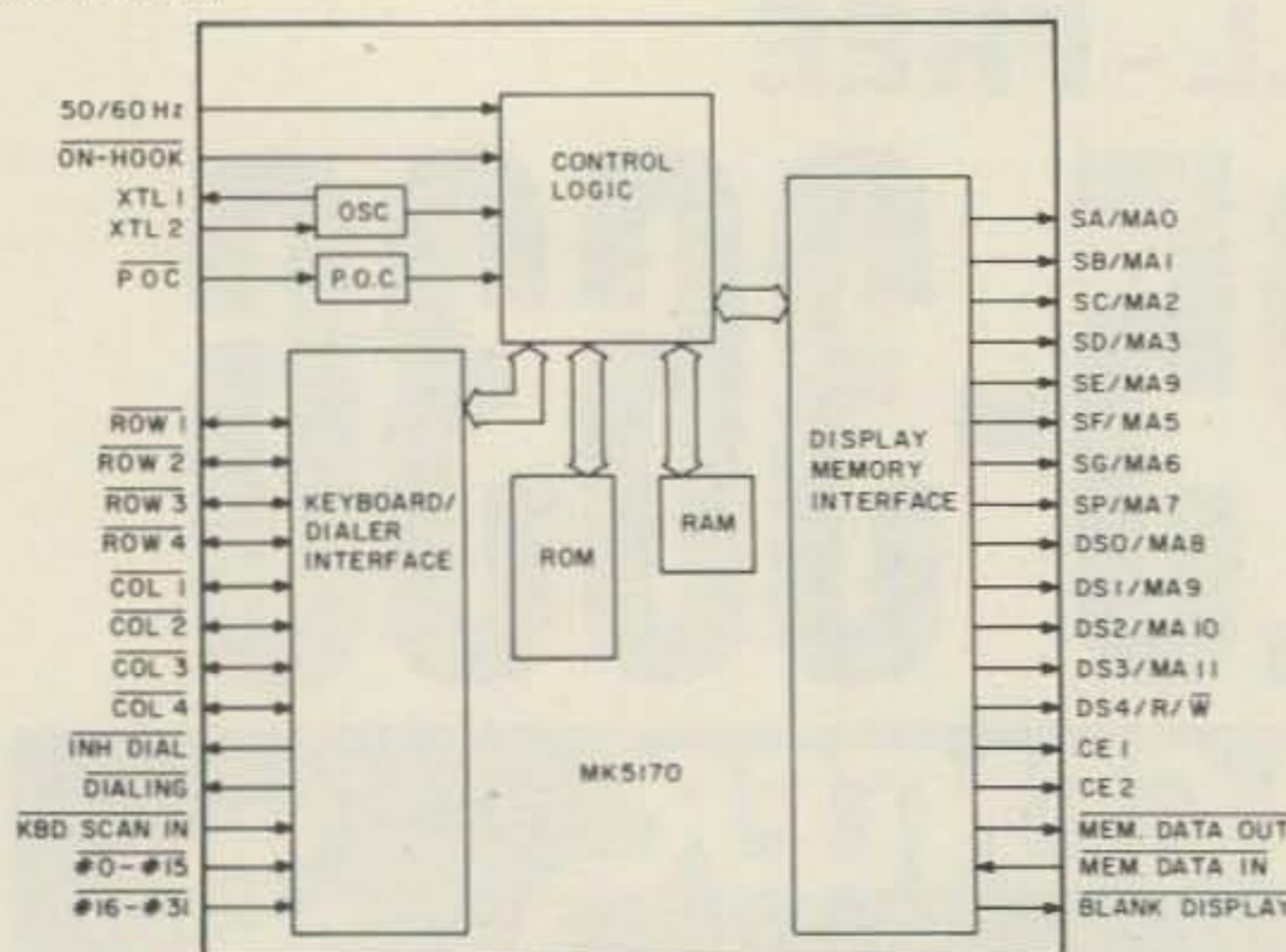

Fig. 1. Pin connections and block diagram.

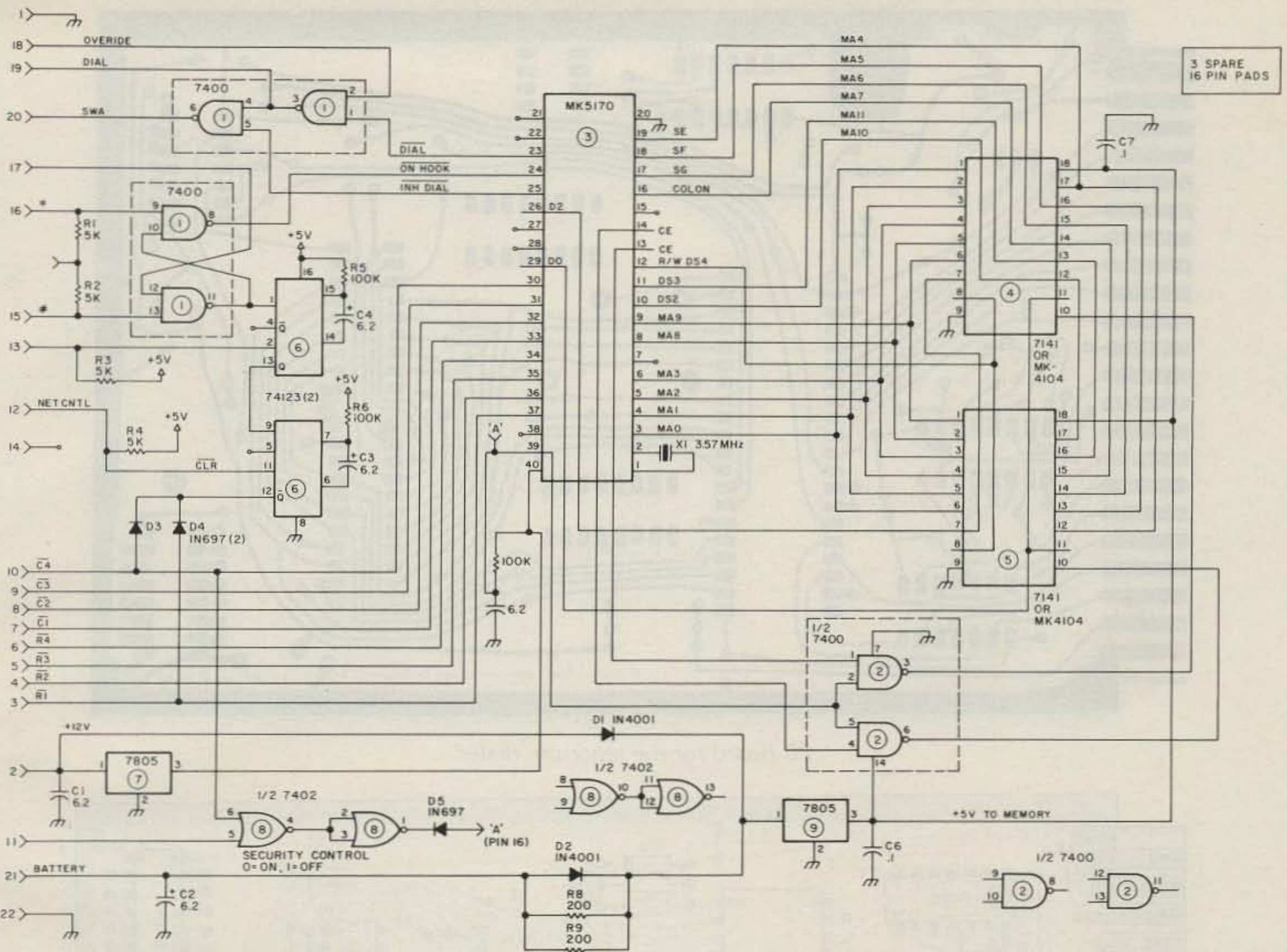

Fig. 2. Circuit diagram for the 100-number system.

There are three control pins which define the mode of operation: Pin 23 indicates that a dialing cycle is in progress by going low, pin 24 (if low) indicates that the phone is on hook, and pin 25 goes low during data entry and is used to inhibit the dialer circuit.

Fig. 4 shows how the unit is connected to the auto-patch and control system described by Buffington. The unit operates in the Dial mode when accessed by a user and in the Enter mode when accessed by a control station. Fig. 5 shows the actual hardware hook-up. Fig. 6 shows the switch circuit that is used to route data between the decoder, the dialer, and the Rep.

To access the Rep, the user must use the following sequence:

MEMORY CONNECTIONS TO MK5170

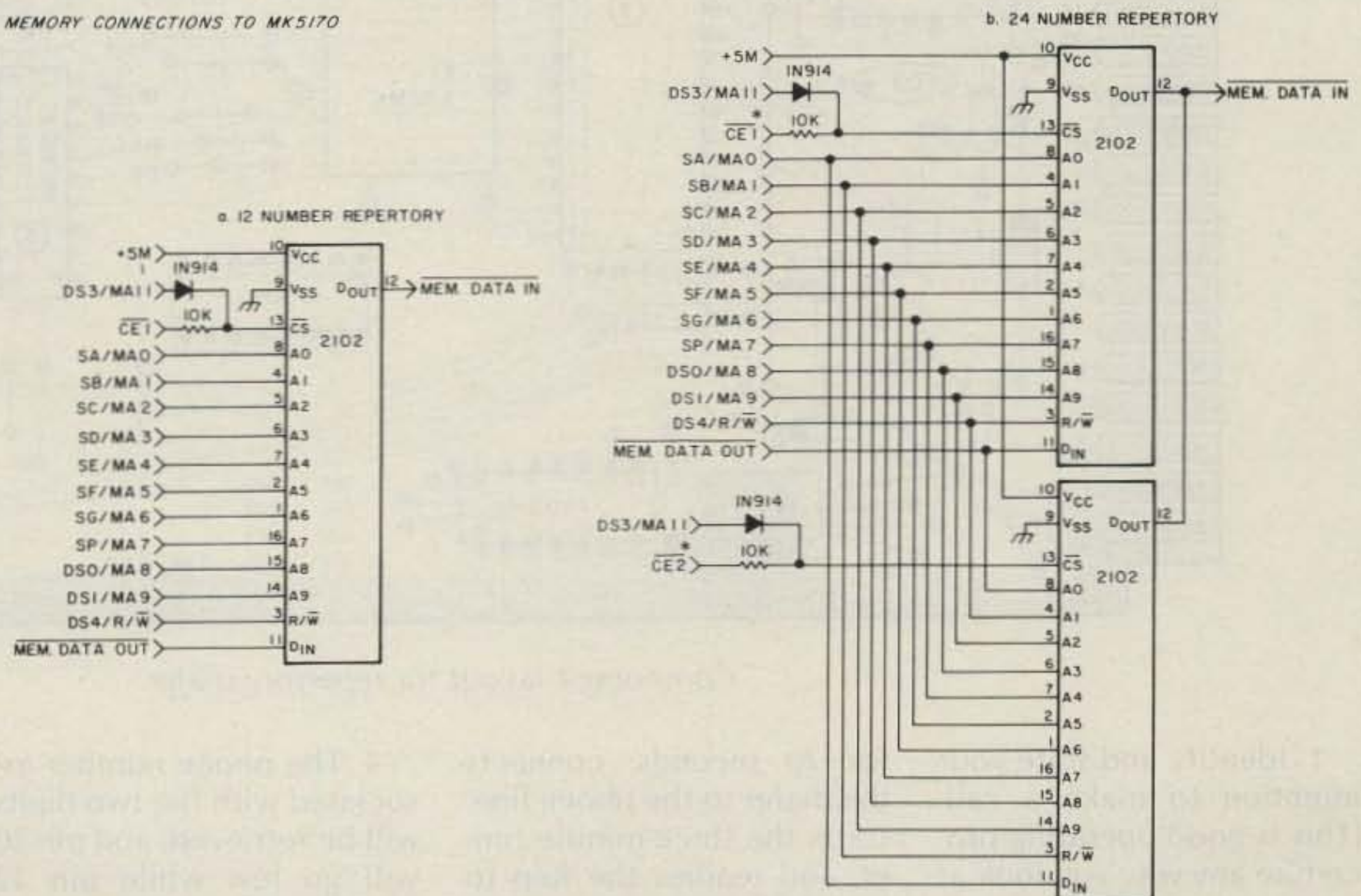
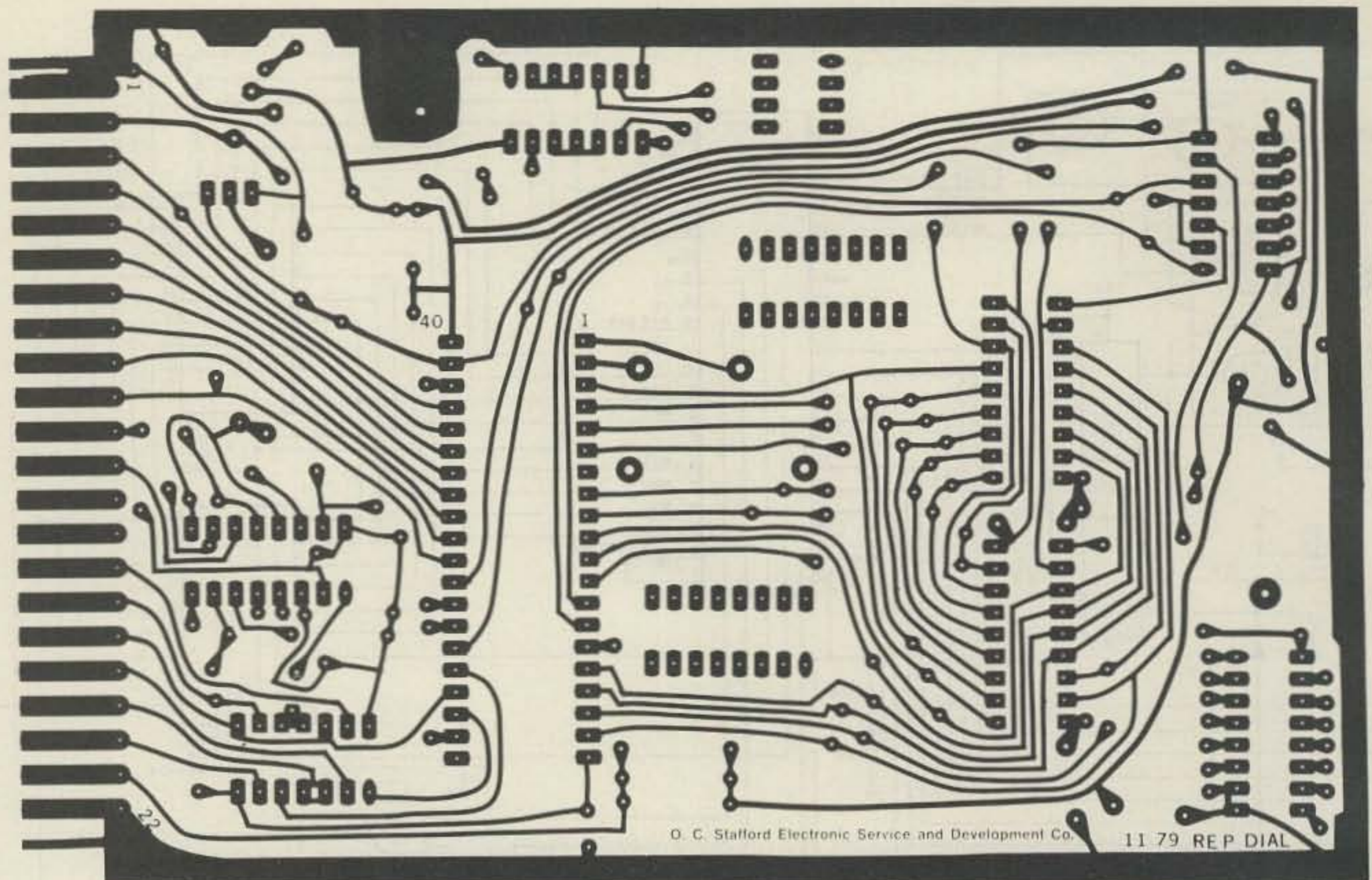
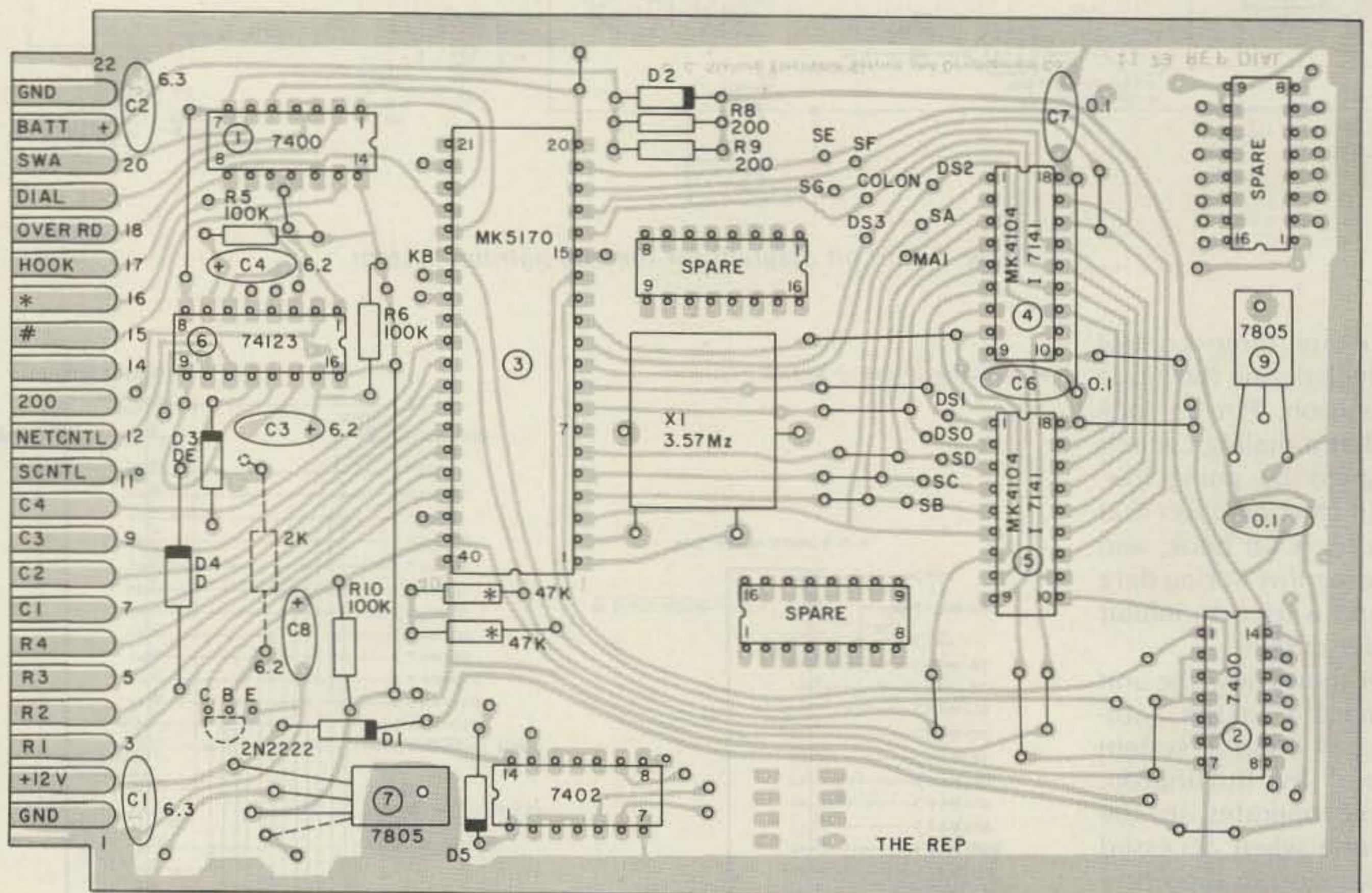

Fig. 3. Memory circuit for a 24-number (or fewer) system. It can be built on header chip and attached to the 18-pin socket.



PC board for the repertory dialer.



Component layout for repertory dialer.

1. Identify and state your intention to make a call. (This is good operating procedure any way you look at it.)

2. Enter *. This causes the demux circuit to lock out

for 20 seconds, connects the dialer to the phone line, starts the three-minute timer, and readies the Rep to look for two numeric digits.

3. Wait for the dial tone, then enter the two digits.

4. The phone number associated with the two digits will be retrieved, and pin 20 will go low while pin 12 goes high, causing the decoder circuit to disconnect and the dialer to be con-

nected to the Rep. The number is then transmitted to the dialer from the Rep. It takes 980 milliseconds for a seven-digit number to be transferred to the dialer with a 3.57-MHz clock.

5. Once the call is completed, send # to knock the patch down and reset the Rep.

The system has some built-in security. A 4x4 touchtone pad is used to access the unit for loading. The pad is shown in Fig. 7. The security function will not allow the user to get into the Enter mode when the phone is off hook. The Enter is sent when the security lock is on; the Rep simply resets. The lock and unlock sequence code should be known only to the control station, and is controlled by the demux/sequence circuit.

The demux and sequence boards are needed if the phone numbers are to be loaded from a remote location, as shown in Fig. 5.

The control station uses the sequence circuit to unlock the system for pro-

gramming. Programming is accomplished using the following sequence:

1. The control station generates a # to make sure the phone is on hook.

2. Send a sequence code to latch pin 12 low and pin 11 high in order to lock out the security function.

3. Press the Enter button.

4. Key in two numeric digits for the address code of the phone number.

5. Press the Clear key to clear the area where the number will be loaded.

6. Key in the phone number.

7. Press the Store key.

8. If more numbers are to be loaded, go to step 5, or unlatch pins 12 and 11.

Provision for battery back-up is provided on the board. A 9-volt nicad should be used with this circuit. When the main power fails, the chip enable lines go high. This

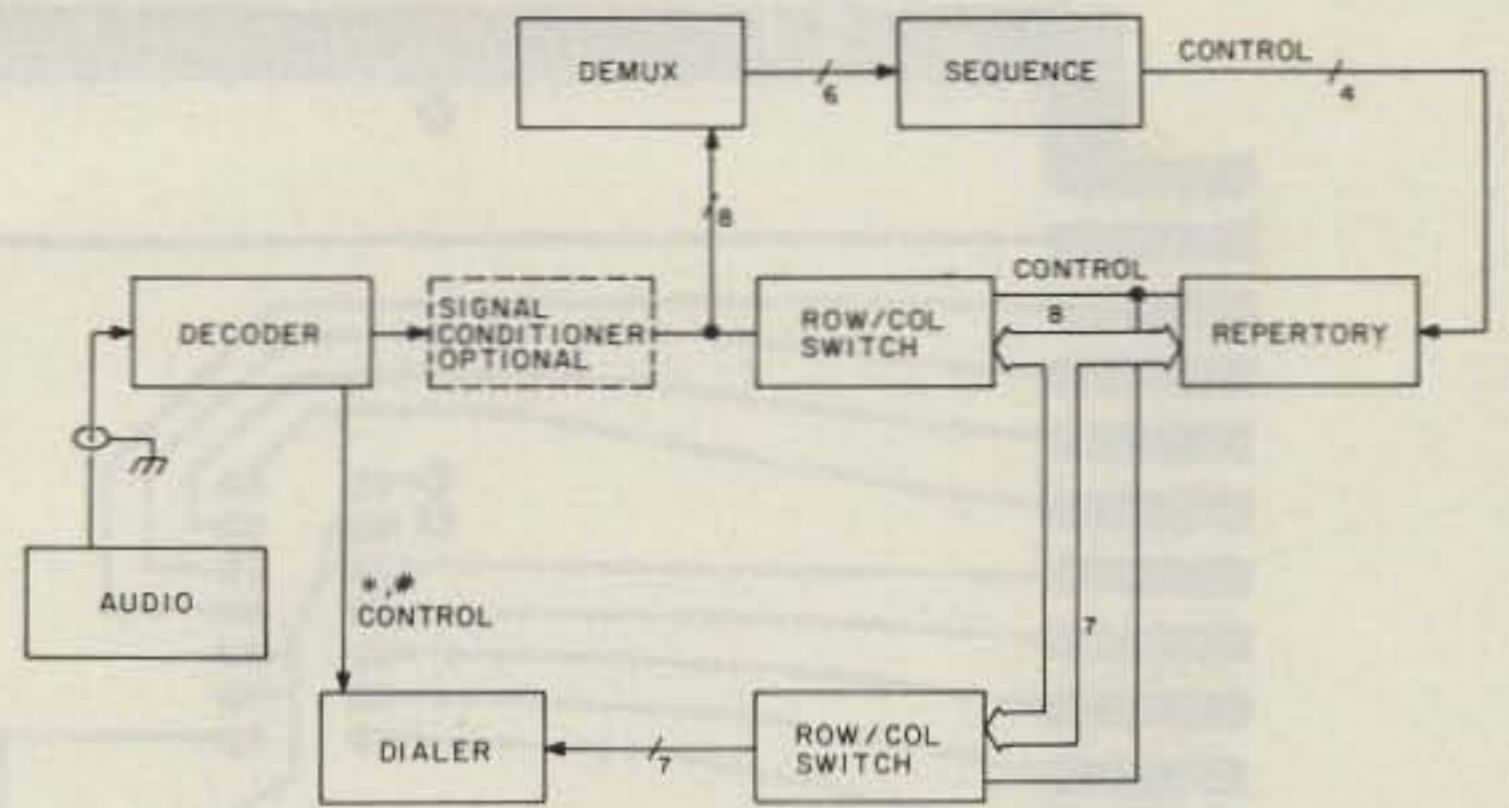

Fig. 4. Repertory connection to phone patch.

causes a drop in current to the chip. The trickle charge circuit will not allow the nicads to overcharge.

The override circuit is used to defeat the Rep and connect the decoder to the dialer for manual dialing. The control station, through a sequencer, makes pins 18 and 12 go low. The patch is brought up with *, and after the dial tone is heard, the dialing can start.

System security is achieved by locking out any column 4 signal by grounding pin 11 using a sequence circuit. If a column 4 signal is received, the Rep goes off hook and the next two digits simply cause the circuit to get a number, but not dial it, since the patch is not on and the unit is in the dial mode, so no damage can be done.

Most repeater groups

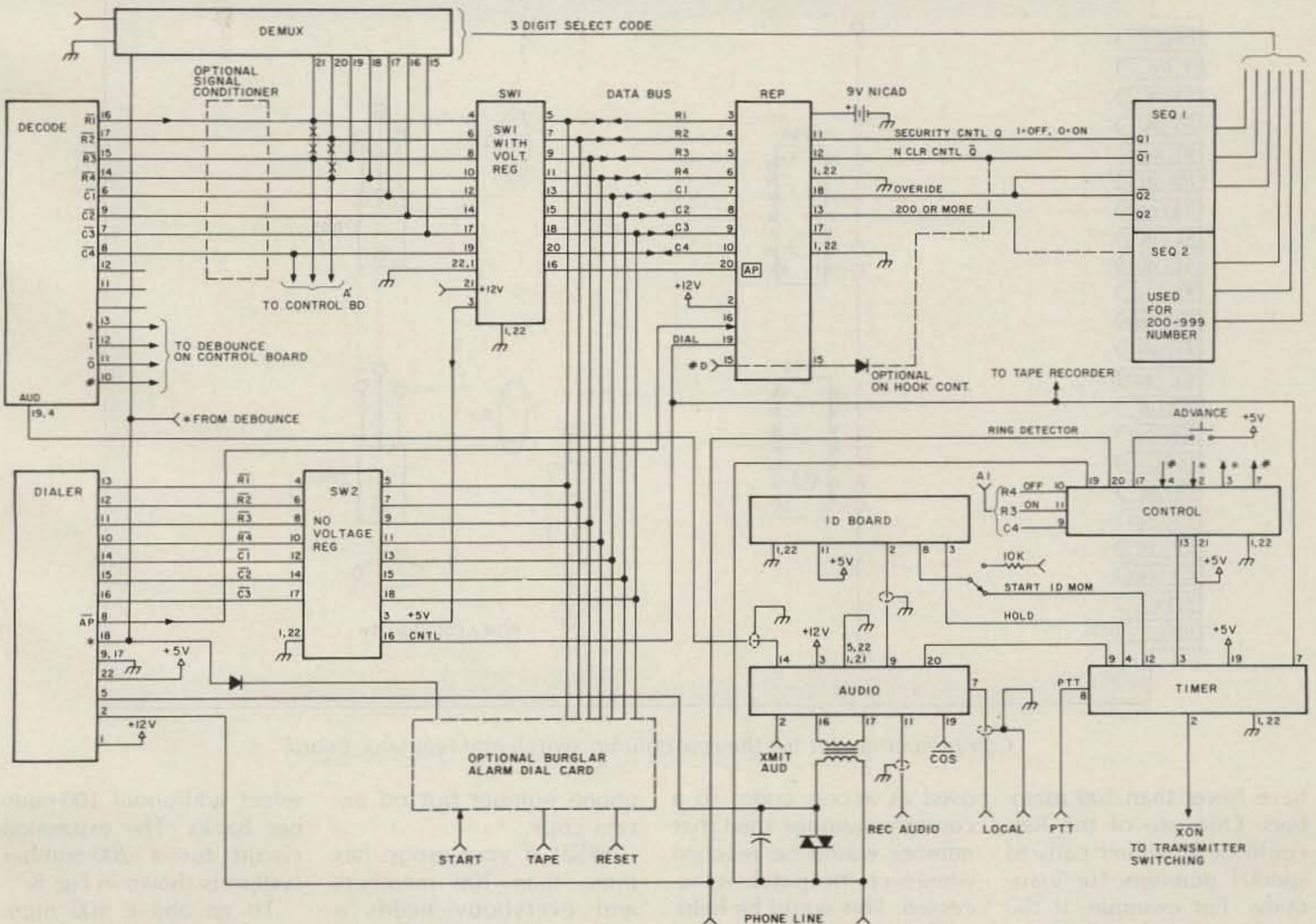
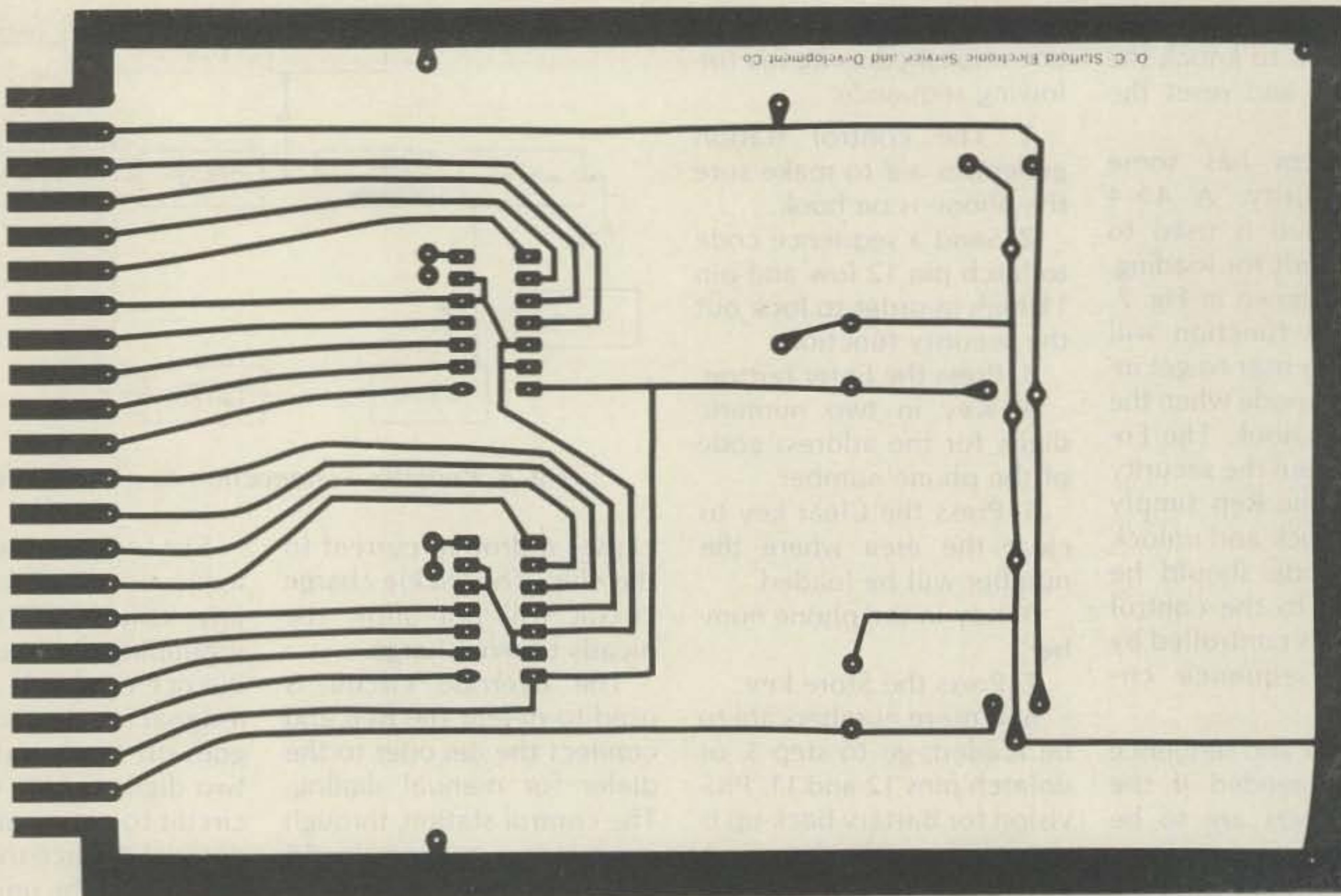
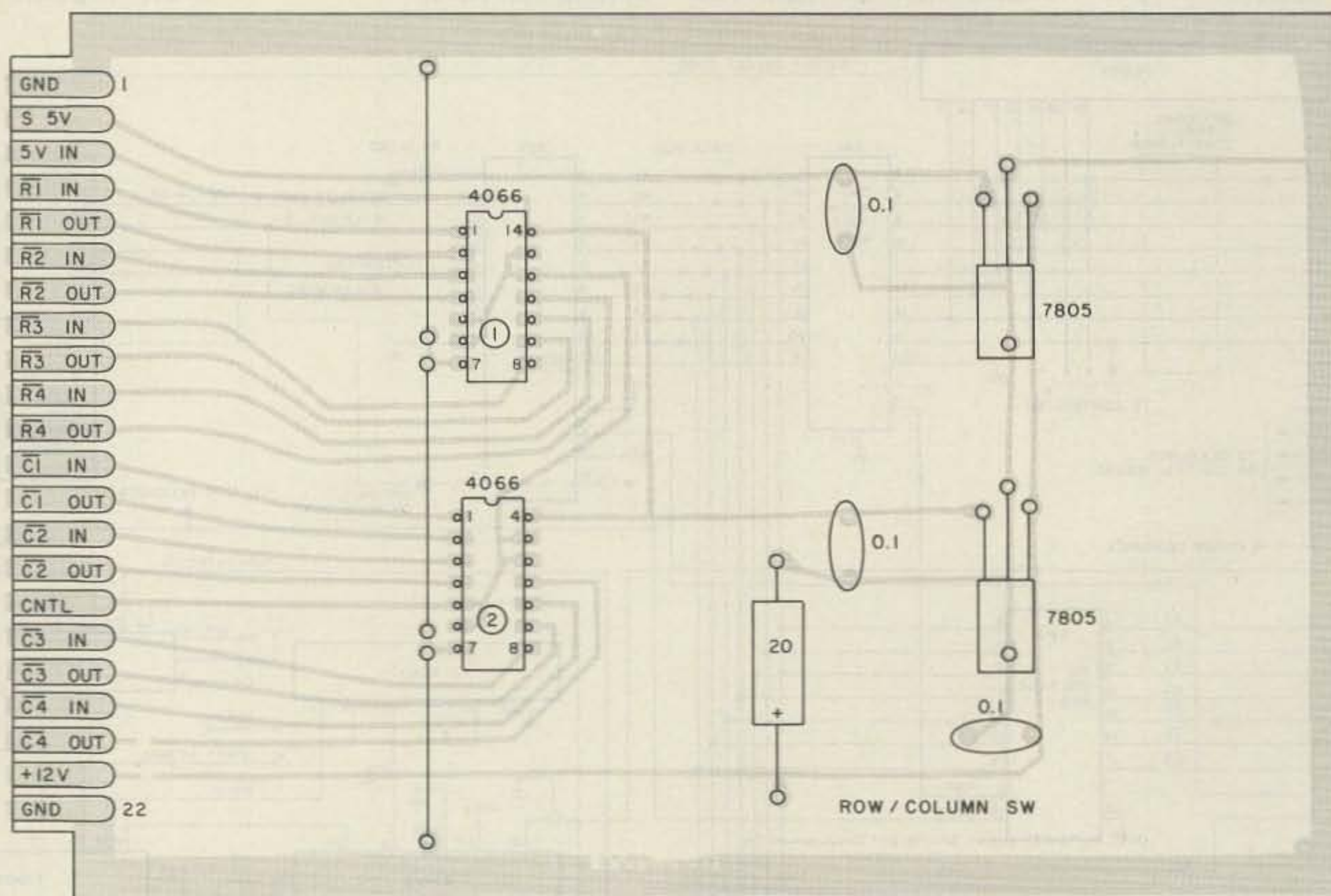

Fig. 5. Basic repeater control system with repertory dialer.



PC board for the row/column switch and regulator.



Component layout for the row/column switch and regulator board.

have fewer than 100 members. One use of the Rep could be to direct calls to special numbers for assistance. For example: If the first two digits of all the exchanges in your area are

used as access codes to a common number, then that number would be reached whenever the patch is accessed. This could be helpful if a visitor tries to access the patch with a regular

phone number but no access code.

What if your group has more than 100 members and everybody needs a number? No problem. The system can be expanded to

select additional 100-number banks. The expansion circuit for a 200-number system is shown in Fig. 8.

To go above 100 numbers requires adding a bank-select digit. The delay gen-

Parts List

Row/Column Switch Board

- Quad switches, 4066 2
- Voltage regulator, 7805 1
- Capacitor, 0.1-uF, tantalum 1
- Card edge connector, 22-pin 1
- 14-pin IC socket 2
- Printed circuit board: drilled \$7.50, undrilled \$5.80.

Rep Board

- Capacitor, 6.2-uF, tantalum 5
- Capacitor, 0.1-uF, tantalum 2
- Resistor, 100k, 1/4 W 3
- Resistor, 5.1k, 1/4 W 4
- Resistor, 200k, 1/4 W 2
- Voltage regulator, 7805 2
- Diode, 1N4001 2
- Diode, 1N697 3
- Crystal, 3.57 MHz 1
- Dialer, MK5170 1
- Dual one-shot, 74123 1
- Quad NAND gate, 7400 2
- Quad NOR gate, 7402 2
- RAM memory, MK4104 2
- 16-pin IC socket 1
- 14-pin IC socket 3
- 18-pin IC socket 2
- 40-pin IC socket 1
- Card edge connector, 22-pin 1

The above items make up the parts kit, for \$100.00. Printed circuit board: \$12.50 drilled, \$9.50 undrilled. Parts and boards are available from O.C. Stafford Electronic S and D Co., 427 South Benbow Road, Greensboro NC 27401, phone: (919)-274-9917.

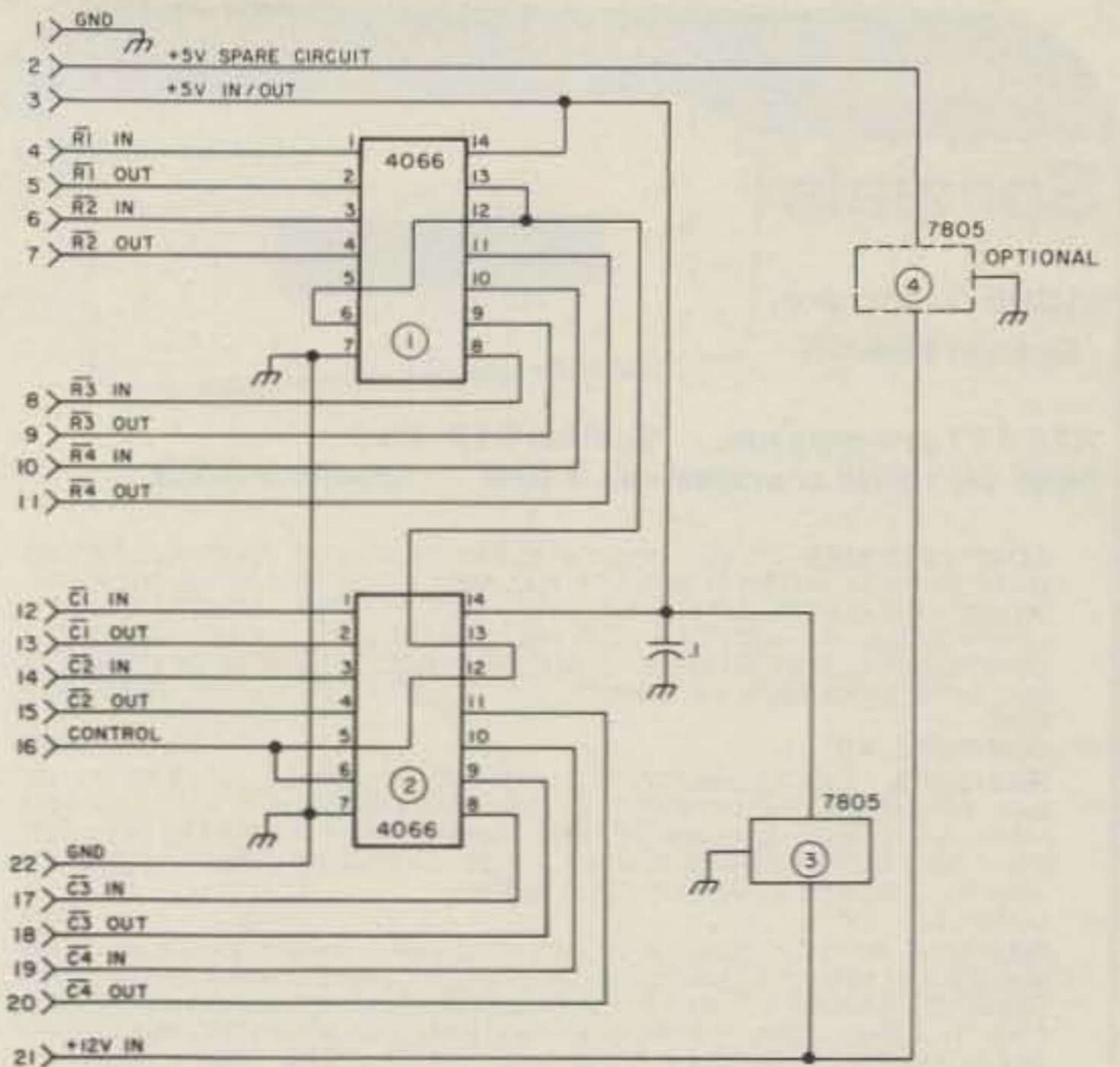

Fig. 6. Row/column switch and regulator board.

erated by the first section of IC6 is increased to 5 seconds. During this five-second interval, the bank-select digit is keyed right after the * and before the five seconds have elapsed.

The input to the row/column lines on the Rep board is not effective during this

time because the MK5170 is held in a reset condition and the bank-select switch is on, allowing the digit to be decoded and clock one of the flip-flops. When the call is completed, the bank

BASIC SYSTEM KEYBOARD CONFIGURATION

1	ABC	DEF	ENTER	ROW 1
2			DIAL	
3	GHI	JKL	MNO	ROW 2
4			STORE	
5	PRS	TUV	WXY	ROW 3
6			INF.	
7			PAUSE	
8	*	OPER.	#	ROW 4
9			CLEAR	
0	C	C	C	
1	O	O	O	
2	L	L	L	
3	I	2	3	
4				

Fig. 7. Touchtone pad.

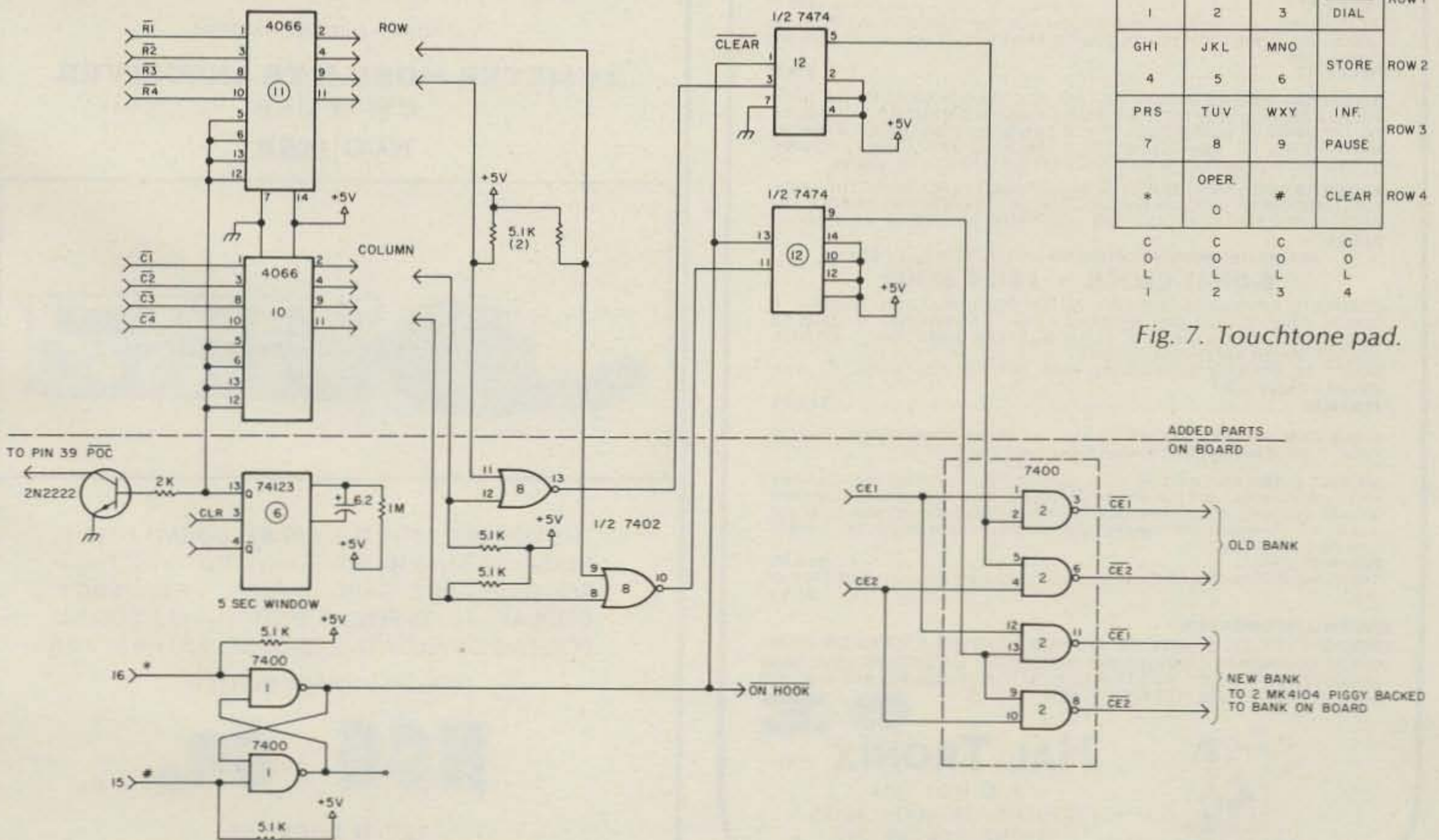
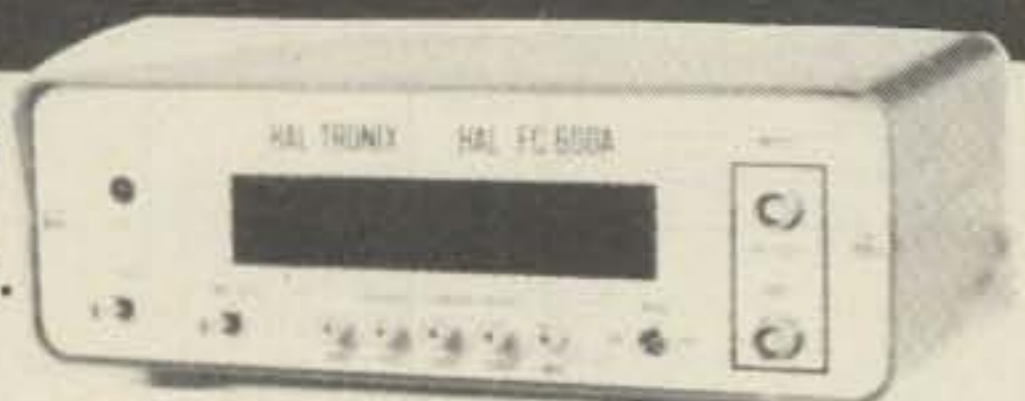

Fig. 8. Expansion circuit for a 200-number system.

January

Specials



11C05 1 GHz, pre.
Special \$59.95

ATF 417 pre-amp net Special \$19.95
MRF 901 UHF transistors, 1 GHz Special \$ 3.95

COMPLETE KITS: CONSISTING OF EVERY ESSENTIAL PART NEEDED TO MAKE YOUR COUNTER COMPLETE. **HAL-600A** 7-DIGIT COUNTER WITH FREQUENCY RANGE OF ZERO TO 600 MHz. FEATURES TWO INPUTS: ONE FOR LOW FREQUENCY AND ONE FOR HIGH FREQUENCY. AUTOMATIC ZERO SUPPRESSION. TIME BASE IS 1.0 SEC OR .1 SEC GATE WITH OPTIONAL 10 SEC GATE AVAILABLE. ACCURACY $\pm .001\%$. UTILIZES 10-MHz CRYSTAL 5 PPM.

COMPLETE KIT.....\$129

HAL-300A 7-DIGIT COUNTER WITH FREQUENCY RANGE OF ZERO TO 300 MHz. FEATURES TWO INPUTS: ONE FOR LOW FREQUENCY AND ONE FOR HIGH FREQUENCY. AUTOMATIC ZERO SUPPRESSION. TIME BASE IS 1.0 SEC OR .1 SEC GATE WITH OPTIONAL 10 SEC GATE AVAILABLE. ACCURACY $\pm .001\%$. UTILIZES 10-MHz CRYSTAL 5 PPM.

COMPLETE KIT.....\$109

HAL-50A 8-DIGIT COUNTER WITH FREQUENCY RANGE OF ZERO TO 50 MHz OR BETTER. AUTOMATIC DECIMAL POINT, ZERO SUPPRESSION UPON DEMAND. FEATURES TWO INPUTS: ONE FOR LOW FREQUENCY INPUT, AND ONE ON PANEL FOR USE WITH ANY INTERNALLY MOUNTED HALTRONIX PRE-SCALER FOR WHICH PROVISIONS HAVE ALREADY BEEN MADE. 1.0 SEC AND .1 SEC TIME GATES. ACCURACY $\pm .001\%$. UTILIZES 10-MHz CRYSTAL 5 PPM.

COMPLETE KIT.....\$109

PRE-SCALER KITS

HAL 300 PRE.....\$14.95

(Pre-drilled G10 board and all components)

HAL 300 A/PRE.....\$24.95

(Same as above with preamp)

HAL 600 PRE.....\$29.95

(Pre-drilled G10 board and all components)

HAL 600 A/PRE.....\$39.95

(Same as above but with preamp)

TOUCH TONE DECODER KIT

HIGHLY STABLE DECODER KIT. COMES WITH 2 SIDED, PLATED THRU AND SOLDER FLOWED G-10 PC BOARD, 7-567's, 2-7402, AND ALL ELECTRONIC COMPONENTS. BOARD MEASURES 3 1/2" x 5 1/2" INCHES. HAS 12 LINES OUT. ONLY \$39.95

DELUXE 12-BUTTON TOUCHTONE ENCODER KIT utilizing the new ICM 7206 chip. Provides both VISUAL AND AUDIO indications! Comes with its own two-tone anodized aluminum cabinet. Measures only 2 3/4" x 3 3/4". Complete with Touch-Tone pad, board, crystal, chip and all necessary components to finish the kit.

PRICED AT.....\$29.95

For those who wish to mount the encoder in a hand-held unit, the PC board measures only 9/16" x 1 3/4". This partial kit with PC board, crystal, chip and components.

PRICED AT.....\$14.95

ACCUKEYER—MEMORY OPTION KIT THIS ACCUKEYER MEMORY KIT PROVIDES A SIMPLE, LOW COST METHOD OF ADDING MEMORY CAPABILITY TO THE WB4VVF ACCUKEYER. WHILE DESIGNED FOR DIRECT ATTACHMENT TO THE ABOVE ACCUKEYER, IT CAN ALSO BE ATTACHED TO ANY STANDARD ACCUKEYER BOARD WITH LITTLE DIFFICULTY. \$16.95

ACCUKEYER (KIT) THIS ACCUKEYER IS A REVISED VERSION OF THE VERY POPULAR WB4VVF ACCUKEYER ORIGINALLY DESCRIBED BY JAMES GARRETT, IN QST MAGAZINE AND THE 1975 RADIO AMATEURS HANDBOOK. \$16.95

ACCUKEYER—MEMORY OPTION KIT—TOGETHER ONLY \$32.00

6-DIGIT CLOCK • 12/24 HOUR

COMPLETE KIT CONSISTING OF 2 PC G10 PRE-DRILLED PC BOARDS, 1 CLOCK CHIP, 6 FND 359 READOUTS, 13 TRANSISTORS, 3 CAPS, 9 RESISTORS, 5 DIODES, 3 PUSH-BUTTON SWITCHES, POWER TRANSFORMER AND INSTRUCTIONS.

DON'T BE FOOLED BY PARTIAL KITS WHERE YOU HAVE TO BUY EVERYTHING EXTRA.

PRICED AT.....\$12.95

CLOCK CASE Available and will fit any one of the above clocks. Regular Price... \$6.50 But Only \$4.50 when bought with clock

SIX-DIGIT ALARM CLOCK KIT for home, camper, RV, or field-day use. Operates on 12-volt AC or DC, and has its own 60-Hz time base on the board. Complete with all electronic components and two-piece, pre-drilled PC boards. Board size 4" x 3". Complete with speaker and switches. If operated on DC, there is nothing more to buy.*

PRICED AT.....\$16.95

Twelve-volt AC line cord for those who wish to operate the clock from 110-volt AC. \$2.95

SHIPPING INFORMATION

ORDERS OVER \$20.00 WILL BE SHIPPED POSTPAID EXCEPT ON ITEMS WHERE ADDITIONAL CHARGES ARE REQUESTED. ON ORDERS LESS THAN \$20.00 PLEASE INCLUDE ADDITIONAL \$1.50 FOR HANDLING AND MAILING CHARGES. SEND SASE FOR FREE FLYER.



"HAL" HAROLD C. NOWLAND
WBZXH

HAL-TRONIX ✓31

P. O. BOX 1101
SOUTHGATE, MICH. 48195
PHONE (313) 285-1782

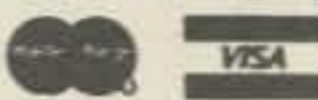

flip-flops are reset through diode D6.

In loading a number, the control station pulses pin 13 to get the 5-second window for the bank select. The procedure for loading a number is then used to complete the process.

The spare IC pads on the circuit card can be used to add the 200-number system. The extra memory chips are piggybacked onto the existing chips with chip enables connected to the appropriate bank-select pins. I suggest you use wire-wrap techniques to build the addition, if you need it. Using this type of logic, the circuit can be expanded to handle 999 numbers! If you need that many, you will have to buffer the address lines and add a memory board.

The original control system used R1, R2, and C4 to control the transmitter. This function should be changed

to a sequence circuit. The R1/C4 combination could cause the Rep to go into the Enter data mode.

R3 and R4 can be used in place of R1 and R2 and the operation of the Rep will not be affected.

It is hoped that the ideas presented in this circuit will help to alleviate some of the problems associated with autopatiches. At the least, it can reduce the hazard of dialing while driving.

I will appreciate any and all comments on this circuit. If you have any questions about how the circuit operates and would like answers, send me a letter along with a self-addressed, stamped envelope. ■

References

1. Mostek Repertory Dialer Data Sheet.
2. 73 Magazine for April, 1977, June, 1977, March, 1978, May, 1978, and May, 1979.

ATTENTION MOBILE HAMS

Vehicles—Aircraft—Marine

15 METER MOBILE TRANSCEIVER CW & USB NCG 15SB



THE QRP RIG WITH THE **BIG RIG SOUND** ACTIVE NOISE BLANKER—RF GAIN—CW SWITCH—SQUELCH—MIC GAIN—DIGITAL FREQUENCY DISPLAY—HI/LO POWER SWITCH—13.8 VDC 5A POSITIVE OR NEGATIVE GROUND. 9.5" x 8.5" x 2.5"

DEALER INQUIRY INVITED.

NCG Co. ✓318

1275 N. GROVE ST.
ANAHEIM, CALIF. 92806 (714) 630-4541

This is a partial listing of over 500 items available from 500 authorized Jim-pak Distributors:

TTL			
7400	2/.85	7490	.85
7402	2/.85	7493	.85
7404	2/.85	74100	2.25
7406	2/1.19	74109	2/1.19
7407	2/1.19	74121	.69
7408	2/.89	74123	.99
7410	2/.85	74150	1.95
7414	.99	74154	1.95
7417	2/1.10	74157	.99
7420	2/.85	74161	1.19
7447	1.19	74164	1.59
7474	.69	74174	1.59
7475	.79	74175	1.49
7476	.69	74192	1.19
7485	1.19	74193	1.19
7486	2/1.19	74367	.99
7489	2.99	74393	1.95



GRAB BAGS

GB100	Cer. Caps. (100)	2.95	GB123	Heat Sinks (30)	3.95
GB101	Mylar Caps. (60)	4.95	GB127	Transistors (100)	3.95
GB102	Electrolytics (60)	4.95	GB137	Chokes (50)	3.95
GB103	Tantalums (40)	4.95	GB139	Term. Strips (40)	3.95
GB108	TTL IC's (50)	4.95	GB140	Spcr/Stndff (150)	2.95
GB110	Asst. LEDs (100)	5.95	GB141	Washers (200)	2.95
GB113	Trimmers (30)	4.95	GB145	Lugs (100)	2.95
GB116	1/4w Resist. (200)	2.95	GB154	1&2w Resist. (100)	2.95
GB117	1/2w Resist. (200)	2.95	GB162	7-Seg. Dsplys. (50)	5.95
GB120	Slide Switch (25)	3.95	GB173	3/8" Pots. (100)	5.95

LS Schottky			
74LS00	.55	74LS109	.79
74LS02	.55	74LS123	1.95
74LS04	.69	74LS138	1.49
74LS08	.55	74LS139	1.49
74LS10	.55	74LS154	2.49
74LS14	1.09	74LS157	1.49
74LS30	.55	74LS161	1.79
74LS32	.69	74LS174	1.79
74LS38	.69	74LS175	1.79
74LS42	1.49	74LS192	1.89
74LS47	1.49	74LS193	1.89
74LS48	1.79	74LS221	1.95
74LS73	.79	74LS244	2.49
74LS74	.79	74LS245	3.49
74LS75	.99	74LS367	1.29
74LS85	1.95	74LS374	2.49
74LS90	1.09	81LS97	2.49

POTENTIOMETERS

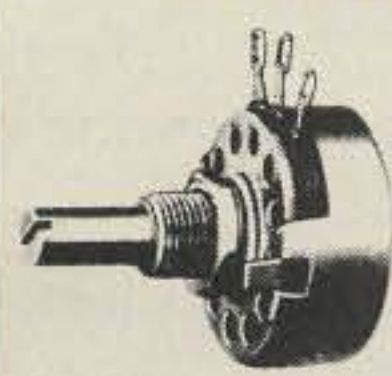

2 Watt @ 70°C
7/8" Slotted Shaft
Linear Taper

1K 5K 10K
25K 50K 100K
1 Meg

CMU .. \$2.95



3/4 Watt @ 70°C
15 Turn Pot.
Linear Taper

100Ω 500Ω 1K
5K 10K 50K
100K 500K 1Meg

830P .. \$1.79

REGULATED POWER SUPPLY KIT

Uses LM309K. Heat Sink provided. PC board construction. Provides a solid 1 amp @ 5 volts. Can supply up to ±5V, ±9V and ±12V with JE205 Adapter. Includes components, hardware and instructions. 3 1/2" x 5" x 2" H



JE200 \$14.95

SOCKETS

Low Profile		Wire Wrap	
8 pin LP	2/59	14 pin WW tin	.75
14 pin LP	2/69	14 pin WW gold	1.09
16 pin LP	2/79	16 pin WW tin	.79
18 pin LP	2/89	16 pin WW gold	1.19
20 pin LP	2/99	24 pin WW gold	1.69
22 pin LP	2/1.09	40 pin WW gold	2.75
24 pin LP	.79	14 p. plug/cover	1.29
28 pin LP	.82	16 p. plug/cover	1.39
36 pin LP	.99	24 p. plug/cover	1.95
40 pin LP	1.19	Also, The Molex Line	

DESK TOP ENCLOSURES



DTE-8 (Pictured)	\$31.95
DTE-11 (Pictured)	34.95
DTE-14	36.95
DTE-HK (Case for JE600)	47.95
DTE-AK (Case for JE610) (Pictured)	52.95

DIODES & TRANSISTORS

1N751	2/59	2N2219A	2/1.19
1N757	2/59	2N2222A	2/89
1N1188	2.69	2N2907A	2/89
1N3600	5/99	2N3055	.99
1N4001	4/59	2N3772	2.25
1N4004	4/69	2N3904	2/69
1N4007	4/79	2N3906	2/69
1N4148	10/99	2N4401	2/79
1N4733	2/69	2N4403	2/79
1N4734	2/69	2N5129	2/69
1N4735	2/69	2N5139	2/69
1N4742	2/69	2N5210	2/79
1N4744	2/69	2N5951	2/1.29

CMOS			
4000	.69	4030	.79
4001	.69	4040	1.95
4002	.69	4044	1.39
4006	1.95	4046	2.49
4009	.89	4047	2.75
4010	.85	4049	.89
4011	.69	4050	.89
4013	.85	4051	1.95
4016	.85	4066	1.19
4017	1.49	4069	.79
4018	1.49	4070	.79
4020	2.19	4071	.79
4023	.49	4081	.69
4024	1.29	4093	1.19
4027	.89	4511	1.95

CAPACITORS

Dipped Tantalum		ELECTROLYTIC	
.1mfd @ 35V	2/89	1mfd @ 50V	3/69
.47mfd @ 35V	2/89	4.7mfd @ 50V	2/59
1mfd @ 35V	2/89	10mfd @ 50V	2/69
2.2mfd @ 25V	2/1.09	22mfd @ 50V	2/79
3.3mfd @ 25V	2/1.19	47mfd @ 50V	2/89
4.7mfd @ 25V	2/1.39	100mfd @ 50V	.59
10mfd @ 25V	1.19	220mfd @ 50V	.69
33mfd @ 25V	3.95	1000mfd @ 25V	1.19
		2200mfd @ 16V	1.39
100V MYLAR			
.001-.01mfd	4/79	50V CERAMIC	
.022mfd	4/89	10pf-.022mfd	4/59
.047mfd	4/99	.047mfd	4/69
.1mfd	4/1.19	.1mfd	4/79
.22mfd	4/1.29		

CONNECTORS

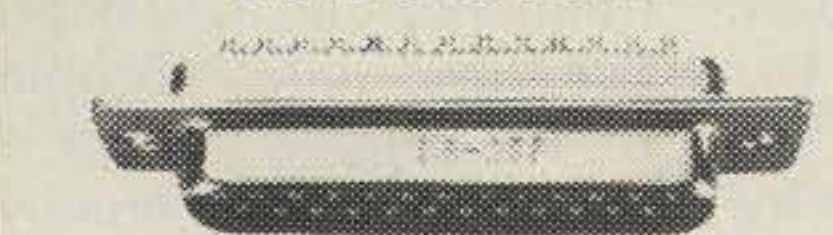

DB25P	D-Subminiature Plug	3.95
DB25S	D-Subminiature Socket	4.95
DB51226	Cover for DB25P/S	2.25
22/44SE	P.C. Edge	2.95
UG88/U	BNC Plug	2.19
UG89/U	BNC Jack	3.95
UG175/U	UHF Adapter	.59
SO239	UHF Panel Recp.	1.49
PL258	UHF Adapter	1.95
PL259	UHF Plug	1.95
UG260/U	BNC Plug	2.39
UG1094/U	BNC Bulkhead Recp.	1.49

JOYSTICKS



JS-100K	100K Linear Taper Pots	\$5.49
JVC-40	40K (2) Video Controller	5.95

MICROPROCESSORS

Z80A	CPU (4MHz)	14.95
MC6800	8 Bit MPU	14.95
8080A	CPU	7.95
8212	8 Bit I/O Port	3.95
8216	Bi-Directional Bus Driver	4.49
2513/2140	Character Generator	12.95
8T97	Tri-State Hex Buffer	2.25
AY-5-1013	30K Baud UART	6.95
AY-5-2376	88-Key Keyboard Encoder	13.95
2114-3	4K Static RAM (300ns)	9.49
MK4116	16K Dynamic RAM (250ns)	9.95
2708	8K EPROM	10.95
2716	16K EPROM (+5V)	19.95

LINEAR			
LM301N	.59	LM7805T	1.75
LM305H	1.39	LM7812T	1.75
LM307N	.75	LM7815T	1.75
LM308N	1.19	LM380N	1.49
LM309K	2.25	LM384N	2.49
LM310N	2.69	LM555N	.69
LM311N	1.49	LM556N	1.49
LM317T	2.29	LM565N	1.95
LM318N	2.95	LM566N	1.95
LM319N	2.95	LM567N	1.79
LM320K-5	2.25	LM723N	.79
LM7905T	1.75	LM741N	.65
LM7912T	1.75	LM1310N	2.95
LM7915T	1.75	LM1458N	.99
LM323K	5.95	LM1488N	1.59
LM324N	1.29	LM1489N	1.59
LM337T	2.29	LM1800N	4.49
LM339N	1.29	76477N	3.95

TOOLS



PCB-3	P.C. Board Vise	\$12.49
WS-150	5" Wire Strip./Cut. (12-24AWG)	3.99
SG-30	10" 110-120V 30W Solder Iron	7.50
SG-TIP	Replacement Tip for SG-30 S. Iron	1.25

12VDC AUTOMOTIVE/ INSTRUMENT CLOCK MODULE

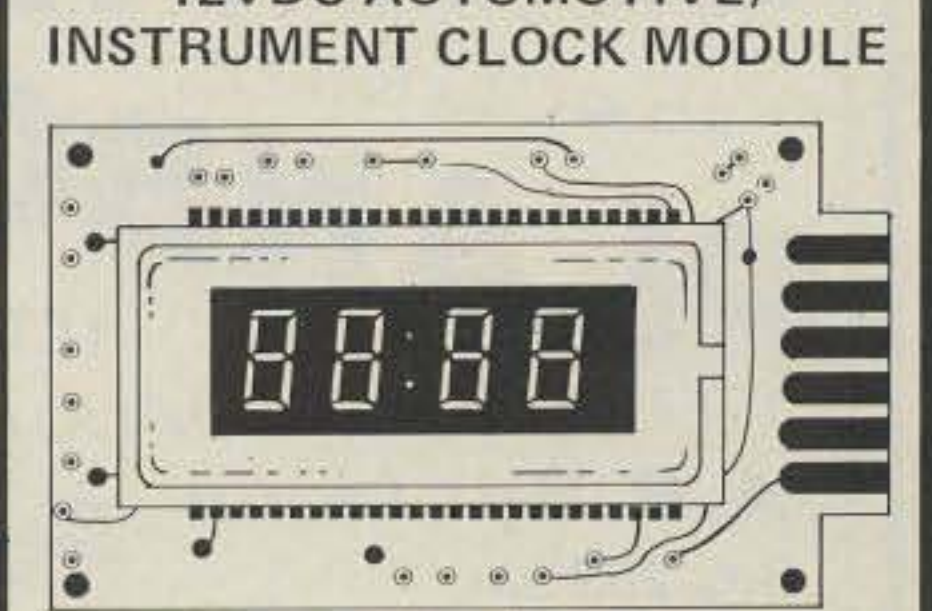

300 GREEN DISPLAY

MA1003 \$19.95

WALL TRANSFORMERS

AC250	250mA 12VAC (117V/60Hz)	\$3.95
DV9200	200mA 9VAC (117V/60Hz)	3.95

Quick and Dirty Line Noise Suppressor

Robert B. Grove WA4PYQ
Rt. 1, Box 156
Brasstown NC 28902

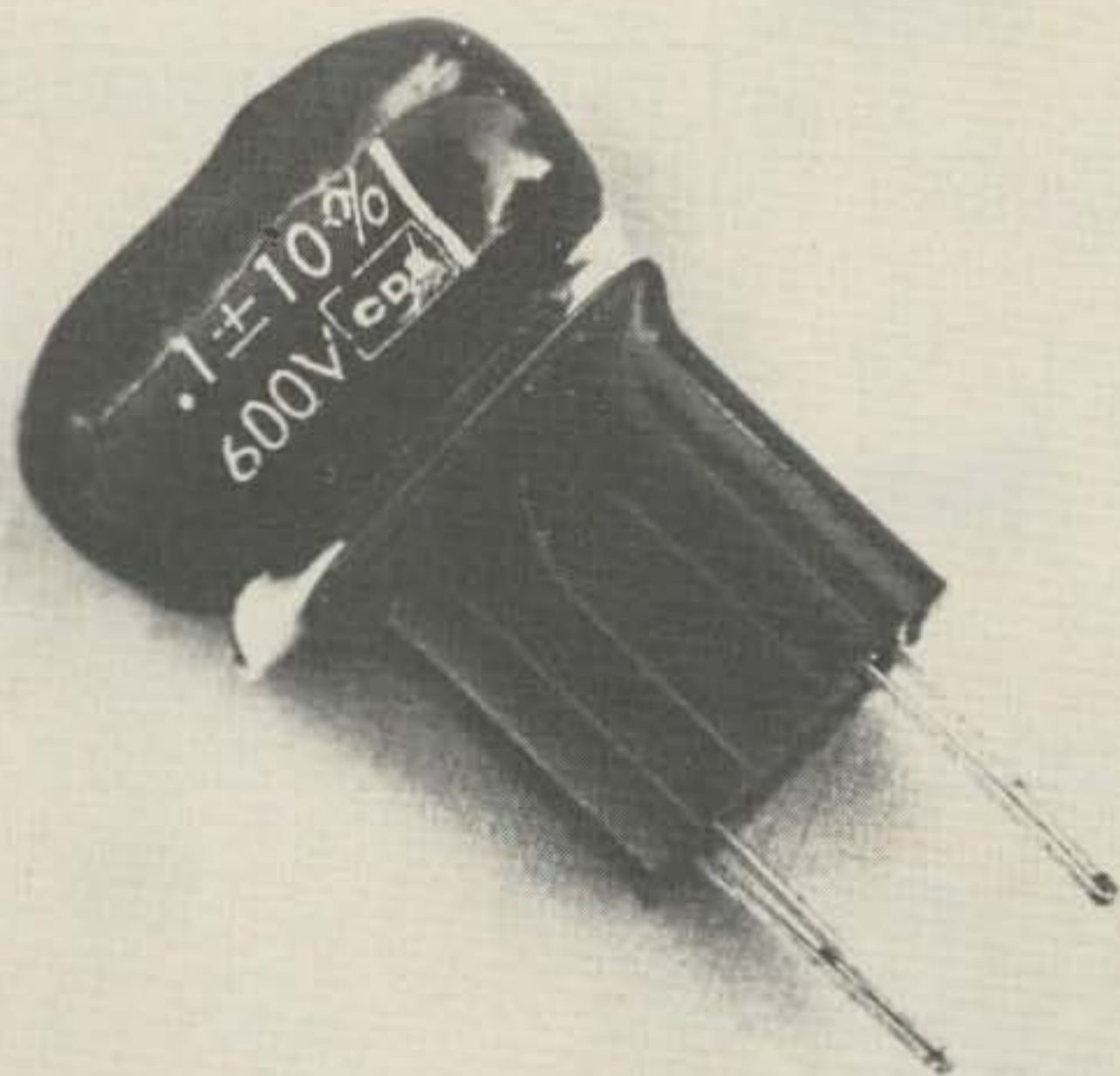

Photo A.

One of the most irritating sources of electrical noise, characterized by sharp clicks heard through the speaker of a receiver, is contact noise. The make/break cycles of appliances, aquarium heaters, flashing Christmas tree lights, and other noisy electrical contacts can wreak havoc with radio reception.

Fortunately, there are several options which may be elected to minimize these ear-splitting distractions. Perhaps the simplest is the installation of a 0.1-uF capacitor across the contacts themselves.

Since it is often difficult to find direct access to the offending contacts, an alternate solution is found by bypassing the plug with the capacitor. Probably the simplest way to do this is by rigging a plug-in interfer-

ence filter as shown in the photo.

For standard 120 lines, select a mylar™ capacitor with a 600-volt rating. Insulate the exposed capacitor leads and connect them directly to the terminal screws of any convenient plug. Insert the plug-in filter into the same outlet as used to power the offending contact device.

The bypass capacitor acts as a smoothing filter for the sharp voltage-spike transients generated by the sparking contact. While it is true that the capacitor might actually resonate an unusually long line cord to enhance the noise at some frequency, in actual practice this is extremely unlikely to happen within the passband of most receiving installations. ■

LINEAR

2 to 400 MHz

PLANBOOK

15 to 1000 WATT

13 Different Models, 96 pgs

A.P. Systems

\$11.95

Box 263 sm.

Newport, RI 02840 (401) 846-5627

362

ALL BAND TRAP ANTENNAS!



PRETUNED - COMPLETELY ASSEMBLED - ONLY ONE NEAT SMALL ANTENNA FOR UP TO 6 BANDS! EXCELLENT FOR CONGESTED HOUSING AREAS - APARTMENTS - LIGHT - STRONG - ALMOST INVISIBLE!

COMPLETE AS SHOWN with 90 ft. RG58U-52 slim feedline, and PL259 connector, insulators, 30 ft. 300 lb. test dacron end supports, center connector with built in lightning arrester and static discharge - molded, sealed, weatherproof, resonant traps "X6" - you just switch to band desired for excellent worldwide operation - transmitting and receiving! WT. LESS THAN 5 LBS.

FOR ALL MAKES & MODELS OF AMATEUR TRANSCEIVERS - TRANSMITTERS - GUARANTEED FOR 2000 WATTS 558 1000 WATTS CW INPUT FOR NOVICE AND ALL CLASS AMATEURS!

160-80-40-20-15-10 bands 4 trap --- 169 ft. with 90 ft. RG58U - connector - Model 1060BU ...	\$99.95
90-40-20-15-10 bands 4 trap --- 91 ft. with 90 ft. RG58U coax - connector - Model 1080BU ...	\$95.95
40-20-15-10 bands 4 trap --- 45 ft. with 90 ft. RG58U coax - connector - Model 1040BU ...	\$92.95
20-15-10 bands 4 trap --- 23 ft. with 90 ft. RG58U coax - connector - Model 1002BU ...	\$89.95

SEND FULL PRICE FOR POST PAID INSURED DEL. IN USA. (Canada is \$5.00 extra for postage - clerical - customs - etc.) or order using VISA Bank Americard - MASTER CHARGE - AMER. EXPRESS. Give number and ex. date. Ph 1-308-236-5333 9AM - 6PM week days. We ship in 2-3 days. ALL PRICES WILL INCREASE - SAVE - ORDER NOW! All antennas guaranteed for 1 year. 10 day money back trial if returned in new condition! Made in USA - FREE INFO. AVAILABLE ONLY FROM:

WESTERN ELECTRONICS ✓ 80 Dept. A7-1 Kearney, Nebraska, 68847

ALL BAND TRAP ANTENNAS!

SAVE \$ SAVE \$ SAVE

CALL TOLL FREE

1-800-228-4097

We Offer The Lowest Prices
In The Country

HAM RADIOS

ALLIANCE
AVANTI
BEARCAT
B & W
BENCHER
CDE
CUSHCRAFT
DENTRON
DRAKE
ENCOMM
ETO
HUSTLER

HY-GAIN
ICOM
KENWOOD
LARSEN
MIRAGE
MOSLEY
SHURE
TELEX
TEMPO
TRAC
YAESU

COMPUTERS

APPLE
ATARI
BASE 2
CENTRONICS
COMMODORE
DC HAYES
MAXELL
MOUNTAIN HDWR
NEC
PAPER TIGER
PET
VERBATIM

IN STOCK NOW!

VIDEO DISC PLAYERS

Call for Discount Prices

Communications Center



1840 'O' St., Lincoln, Ne., 68508
In Ne. Call (402) 476-7331



Over the Hump and into History

— the last flight of #42-107270

November 30, 1943: In a C-87 airplane (number 42-107270) somewhere over the Himalaya Mountains of Asia, radio operator Kenneth Spencer, a 19-year-old corporal from Rockville Center, Long Island, anxiously twisted the dials of his HF command sets, trying to raise one of the ground stations he knew should be down below.

In the cockpit, Lt. Robert Crozier of Waco, Texas, the pilot, and Flight Officer Harold McCallum of Quincy, Massachusetts, the copilot, sat straining their eyes in an attempt to see anything other than the black storm clouds at 24,000 feet.

Aft of the radio shack, Sergeant William Perram of Tulsa, Oklahoma, kept a sharp eye on his dwindling fuel supplies, while the fifth man in the plane, PFC John Huffman of Straughn, Indiana, wondered what was happening.

Though listed on the manifest as assistant engineer, Huffman didn't belong in the plane. Three days earlier, he'd made his first flight east over the Hump from Jorhat Airbase in the Assam Valley of northeast India, to Kun-

ming, an American base 550 miles away in China. At Kunming, he'd been grounded because of a head cold and was dead-heading home. He was on the manifest in order to draw special flight pay. Huffman had no access to the inter-crew phone system and relied on shouted explanations of what was happening.

What was happening was that they couldn't find their way back to Jorhat.

Earlier in the day, the C-87 (which was a modification of the B-24 bomber known as the *Liberator*, built by consolidated Aircraft Corporation of San Diego and identical to the B-24 except for the removal of machine guns, turrets, bomb-handling equipment, and related controls, and the addition of a floor in the cargo compartment and a row of windows on either side of the fuselage), had made a quiet flight from Jorhat to Kunming carrying a load of 55-gallon drums of fuel destined to be used by bombers and fighters striking at the Japanese further east and south in China and Burma. They had dropped the fuel at Kunming and

been given a partial load of garden produce to go to Yunannyi, about 45 minutes west of Kunming and almost directly on the western flight plan. They had left Yunannyi at about 6 pm, anticipating a routine flight back to Jorhat.

But no flight over the Hump was ever truly routine. By the end of the war, more than 400 planes and 850 men were lost flying the 50-mile-wide corridor, which became known as Aluminum Valley because of the wrecked planes littering the mountain slopes. In clear weather, pilots navigated from one collection of wreckage to the next. In November and December, 1943, there were 38 and 28 major accidents, respectively, over the Hump. Between June and December 1943, 168 men were killed making the trip. Some were shot down by marauding Japanese Zeroes up out of Burma, while others were killed when their planes flew into a mountain during the unpredictable storms which sometimes had winds measured at 200 mph. Despite weather as severe as any in the world, the planes flew 24 hours a day, stopping only to change crews,

load and refuel, and receive required maintenance.

In September, 1943, Colonel Thomas Hardin was given command of Hump operations; one of his first orders was that "Effective immediately, there will be no weather over the Hump." In the face of extreme icing conditions, high winds, zero visibility, and attacks by Japanese planes, the crews and their aircraft kept flying.

Although the C-87 had a range of about 3000 miles and a ceiling of about 30,000 feet with its four Pratt & Whitney 1200 horsepower engines, it was often hampered by maintenance problems. Parts came from the US via the longest supply route in military history. Temperature ranges from 100 plus degrees at sea level in the Assam Valley to below zero at altitude, coupled with high humidity on the ground, caused rapid rusting and breakdown. The communications equipment was as susceptible to trouble as any other part of the aircraft, and the HF gear was often affected by severe electrical storms over the Hump, caused when warm air from the Bay of Bengal met cold air sweep-

When it comes to
**AMATEUR
RADIO QSL's...**



it's the
ONLY BOOK!
US or DX Listings

1981
callbooks
NOW READY!

Here they are! The latest editions. World-famous Radio Amateur Callbooks, the most respected and complete listing of radio amateurs. Lists calls, license classes, address information. Loaded with special features such as call changes, prefixes of the world, standard time charts, worldwide QSL bureaus, and more. The U.S. Edition features over 400,000 listings, with over 100,000 changes from last year. The Foreign Edition has over 300,000 listings, over 90,000 changes. Place your order for the new 1981 Radio Amateur Callbooks, available now.

	Each	Shipping	Total
<input type="checkbox"/> US Callbook	\$17.95	\$2.55	\$20.50
<input type="checkbox"/> Foreign Callbook	\$16.95	\$2.55	\$19.50

Order both books at the same time for \$37.45 including shipping.

Order from your dealer or directly from the publisher. All direct orders add \$2.55 for shipping. Illinois residents add 5% sales tax.



SPECIAL LIMITED OFFER!
Amateur Radio
Emblem Patch
only \$2.50 postpaid

Pegasus on blue field, red lettering. 3" wide x 3" high. Great on jackets and caps. Sorry, no call letters.

ORDER TODAY!

RADIO AMATEUR
callbook INC.

Dept. B
925 Sherwood Drive
Lake Bluff, IL 60044, USA

HI-Q BALUN

- For dipoles, yagis, inverted vees & doublets
- Replaces center insulator
- Puts power in antenna
- Broadbanded 3-40 MHz
- Small, lightweight and weatherproof
- 1:1 Impedance ratio
- For full legal power and more
- Helps eliminate TVI
- With SO 239 connector

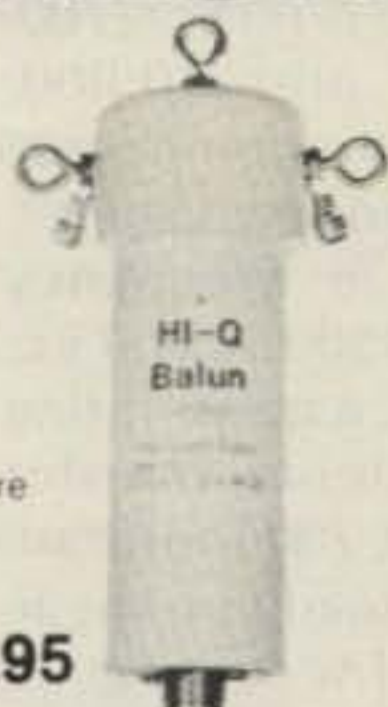

\$10.95

HI-Q ANTENNA CENTER INSULATOR



Small, rugged, lightweight, weatherproof.
Replaces center insulator.
Handles full legal power and more.

\$5.95 With SO 239 connector

HI-Q ANTENNA END INSULATORS



Rugged, lightweight, injection molded of top quality material, with high dielectric qualities and excellent weatherability. End insulators are constructed in a spiral unending fashion to permit winding of loading coils or partial winding for tuned traps.

May be used for

- Guy wire strain insulators
- End or center insulators for antennas
- Construction of antenna loading coils or multiband traps

\$4.95

Patent No. 4,091,350

DIPOLES

MODEL	BANDS	LENGTH	PRICE WITH HI-Q BALUN	WITH HI-Q CENTER INSULATOR
Dipoles				
D-80	80,75	130	\$28.95	\$24.95
D-40	40,15	66	25.95	21.95
D-20	20	33	24.95	20.95
D-15	15	22	23.95	19.95
D-10	10	16	22.95	18.95
Shortened dipoles				
SD-80	80,75	90	31.95	27.95
SD-40	40	45	28.95	24.95
Parallel dipoles				
PD-8010	80,40,20,10,15	130	39.95	35.95
PD-4010	40,20,10,15	66	33.95	29.95
PD-8040	80,40,15	130	35.95	31.95
PD-4020	40,20,15	66	29.95	25.95
Dipole shorteners - only, same as included in SD models				
S-80	80,75			\$11.95 pr
S-40	40			\$10.95 pr

All antennas are complete with a HI-Q Balun or HI-Q Antenna Center insulator, No. 14 antenna wire, ceramic insulators, 100 nylon antenna support rope (SD models only 50) rated for full legal power. Antennas may be used as an inverted V and may also be used by MARS or SWLs.

Antenna accessories—available with antenna orders
Nylon guy rope 450# test 100 feet \$3.49
Ceramic (Dogbone Type) antenna insulators .70 pr
SO-239 coax connectors .55

All prices are postpaid USA 48
Available at your favorite dealer or order direct from

Van Gorden Engineering
Dealer Inquiries Invited

BOX 21305, S. EUCLID, OHIO 44121

✓ 373

CALL TOLL FREE

For the best deal on

- AEA • Alliance • Ameco • Apple • ASP
- Avanti • Belden • Bencher • Bird • CDE
- CES • Communications Specialists
- Collins • Cushcraft • Daiwa • DenTron
- Drake • Hustler • Hy-Gain • Icom • IRL • KLM
- Kenwood • Larsen • Macrotronics • MFJ
- Midland • Mini-Products • Mirage • Mosley
- NPC • Newtronics • Nye • Panasonic
- Palomar Engineers • Regency • Robot
- Shure • Standard • Swan • Tempo
- Ten-Tec • Transcom • Yaesu

NEW YEAR SPECIALS!

ICOM IC-255A \$329

TEMPO S-1 \$239

with touchtone \$269

MIRAGE B-108 10-80 W
2-meter amplifier with
built-in pre-amp \$159

KENWOOD TR-7800,
TR-9000 and TR-2400
all now in stock... call
today for our GREAT
Erickson prices!

APPLE: Disk Based Sys-
tem; Apple II or Apple II
Plus with 48k RAM in-
stalled, Disk II with
controller, RF Modu-
lator. Includes NEW
DOS 3.3 only \$1799

Apple prices include prepaid shipping
within continental U.S.A.

CALL TOLL FREE
(outside Illinois only)

(800) 621-5802

HOURS: 9:30-5:30 Mon., Tues., Wed. & Fri.

9:30-9:00 Thursday

9:00-3:00 Saturday

**ERICKSON
COMMUNICATIONS**
Chicago, IL 60630
5456 North Milwaukee Ave.
(312) 631-5181 (within Illinois)

ing down across the steppes of north central Asia.

The plane was equipped with up-to-date specialized navigational gear, but some of it was useless because no Hump base had the counterpart equipment.

The C-87 had the same radio gear as its parent B-24, except that the C-87 had fewer interphone crew stations due to elimination of the bombardier and gunner stations on the plane. If the interphone was operating correctly, all crew stations could hear the radio compass signal, the liaison and command radios, and other crewmen.

The command radio equipment in 1943 was high-frequency type (in 1944 upgraded to UHF) and, according to the B-24 manual, was used for plane-to-plane communications, though in practice it was used for all normal traffic, air-to-air or air-to-ground, because all crew members could either receive or transmit via the command set. The command gear included two transmitters mounted on racks on the deck over the wing, along with three receivers. A modulator unit, an antenna-switching relay, a transmitter-control box, a receiver-control unit, a dynamotor, a terminal strip, and two receiver dynamotors completed the rig. The command radio, like most other equipment on the plane, operated on 24 V dc.

The two transmitters had frequency ranges between 5300-7000 kilocycles (kc) and 7000-9100 kc. The three receivers covered frequencies of 190-550 kc, 3000-6000 kc, and 6000-9100 kc.

The liaison equipment was of medium power. Its transmitter had seven removable tuning units supplied with it. The tuners could be inserted by the operator to change frequencies in flight. The tuners handled 200-500 kc, 1500-

3000 kc, 3000-4500 kc, 4500-6200 kc, 6200-7700 kc, 7700-10,000 kc, and 10,000-12,500 kc. An antenna-tuning unit, a frequency meter, a receiver in frequency range from 1500-18,000 kc, a dynamotor, a transmitting key, an antenna-transfer switch, and a 200-foot trailing antenna made up the liaison unit. (According to the B-24 manual, the liaison radio could be controlled by the radio operator, pilot, or copilot. Harold McCallum, copilot of #42-107270, says the C-87 liaison gear could be controlled only by the radio operator and was not normally used because of this limitation.)

The radio compass was a 15-tube superheterodyne receiver using 24-28 V dc for operation of the relays. The radio circuits ran on 110 volts ac at 400 cycles; the 110 juice was supplied by inverters under the flight deck, which also supplied power for autosyn instruments and the interior lighting. The loop was electrically driven and could be controlled from either of two remote boxes.

Marker beacon equipment operated on ultra-high-frequency signals at 75 megacycles (mc) and could receive signals from instrument landing systems (ILS), fan stations, cone-of-silence stations, and any other station equipped with horizontally-polarized 75-mc wave systems. According to McCallum, there were no ILS systems in the China-Burma-India (CBI) Theatre, although Chabua had a cone-of-silence system. Planes entering the range received either A or N signals in Morse code, depending on their relation to the range. On the correct approach, no signal was received.

There were six antennas on the B-24/C-87. The command antenna was a single wire from the top of the fuselage above the wing to

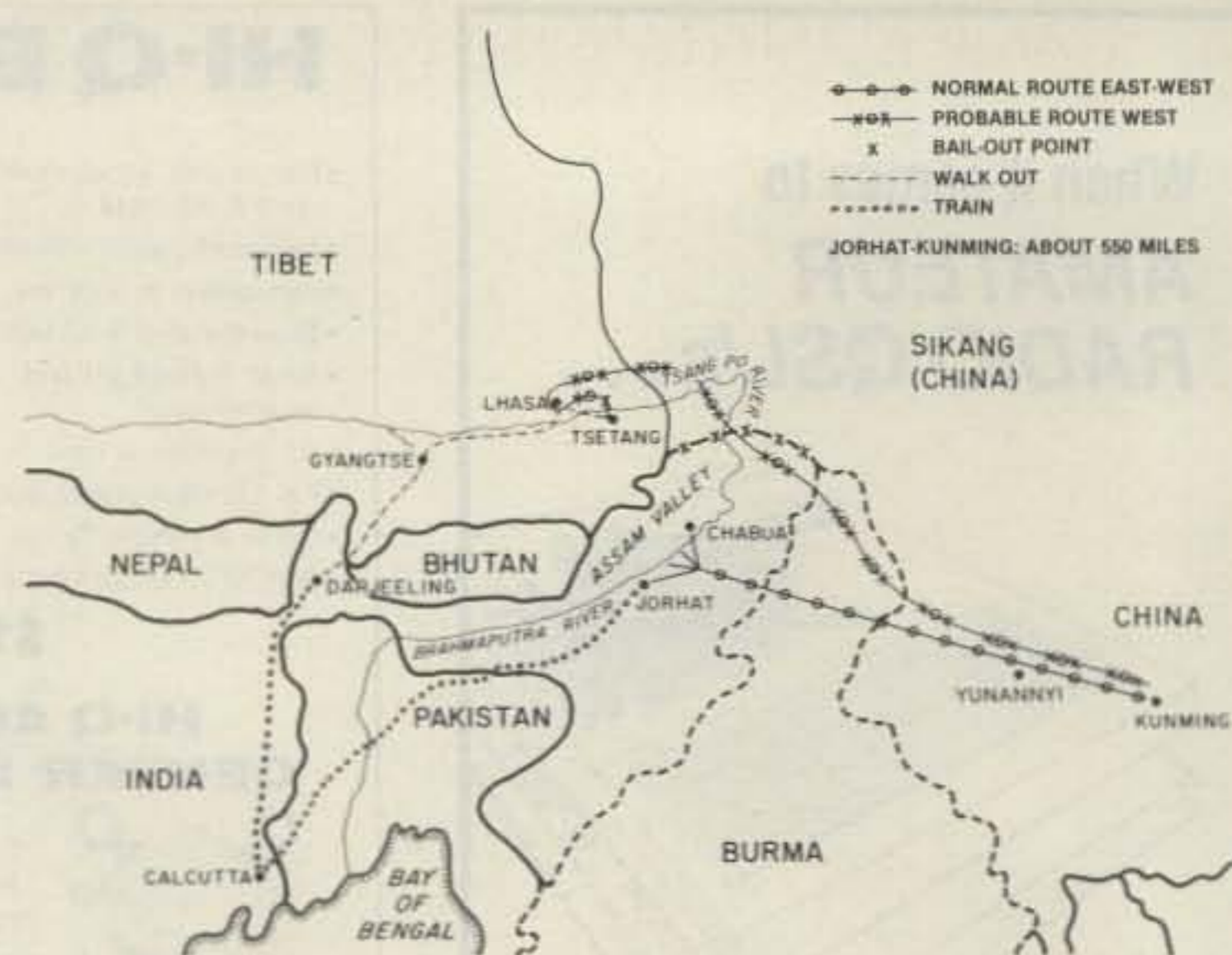

Fig. 1. Map of the area.

the top of the left vertical stabilizer (the B-24/C-87 had a twin-tail unit), while the liaison fixed-antenna wire ran to the right vertical stabilizer. The radio compass had two antennas: a vertical whip and a loop, both mounted topside over the wing. The marker beacon antenna was under the plane between the landing gear, and the liaison trailing antenna was a single wire wound on an electrically-operated reel located in the forward compartment under the flight deck and controlled by the radio operator.

According to official briefing information given to crews flying out of the Assam Valley in 1943 and 1944, there were at least four ground stations in operation. Tezpur, Jorhat, Chabua, and Ridge Station were all located along the Brahmaputra River within about 200 miles. Tezpur, Jorhat, and Chabua offered ground-to-air transmission facilities on 4220 and 5588 kc (A-3 emission) or 4595 and 8200 kc (A-1 emission). A-1 was continuous wave (CW). A-2 was tone, A-3 was voice. Receiving was done on 4495 and 5588 kc (A-3) or on 4595 and 8200 kc (A-1). Ridge Station transmitted and received on 5588 kc (A-3).

Chabua and Jorhat had

homing beacons of 1000-Watt power-emitting tone signals. The Jorhat tower used 1200 kc, Chabua 1070 kc. Tezpur homed the planes on 295 kc with a 1200-Watt source, while Ridge Station brought the birds in on 390 kc from 50 Watts. All bases with direction-finding equipment in the theatre operated receiving-only on 2000-8000 kc, with all three types of emission.

Since the homing facilities and the DF equipment were operated on request only, at least part of the reason for the plight of the Crozier-McCallum C-87 could have been a result of the inability of the crew to call for operation of the equipment.

Even though the plane was equipped with then-modern gear, Spencer, the radio operator, was unable to get accurate bearings. The radio equipment may not be entirely to blame, however. It is known that in 1942 one or more Japanese stations located in Burma succeeded in giving false bearings to several planes flying the Hump. Some planes and crews were lost before the deception was discovered and steps taken to counteract the problem. Weeks later, McCallum and other members of the C-87 were told that the bearings

What does it really cost to get on RTTY?



No Economy models, no extras. Includes printer output and "zoom".

... its all there. The Microlog "Split Screen Package" will get you on silent RTTY and CW with any rig, any mode; and with features you will find most desirable. \$1099 for complete AKB-1 keyboard and AVR-2 decoder using your TV (\$1199 with 9" monitor shown). Compare on quality, features and price; we're sure you'll stay with MICROLOG. 4 Professional Drive, Suite 119, Gaithersburg, Maryland 20760, 301-948-5307.

MICROLOG CORPORATION

✓51

Innovators in Digital Communication



Organize your shack with a **CLUTTERFREE MODULAR CONSOLE \$179.95**

- Large, 42" H x 57" W x 29"D
- Strong groove-construction
- Mar-resistant wood grain finish
- Options, drawers & face plate
- For ham or home computer
- Visa and Master Charge

CLUTTERFREE MODULAR CONSOLES

P.O. Box 5103 Tacoma, WA 98405
(206) 759-1611 ✓89

THE 10 METER FM HANDBOOK
BY K9EID

The TEN METER FM HANDBOOK

\$4.95
plus 75¢ postage
(Illinois add 50¢ sales tax)

Describing the fascinating happening on 10, FM!

NEW! TEN METER TRANSCEIVER
FM - 10



Kit includes a two color, silk screened, aluminum chassis, the deluxe CYBERNET (Hy Gain) CB board, True FM discriminator kit, crystal, jacks, pots, hardware and a thorough instruction manual.

COMPLETE KIT • \$55.00

include \$2.00 for postage and handling.
Ill. residents add 5% sales tax.

MELCO ✓385 P.O. Box 26
Marissa, Ill. 62257

The One-Stop Parts House for 10 FM!

SLEP MAIL-ORDER SPECIALS

DRAKE

TR-7/DR-7 DIGITAL TRANSCEIVER	\$1,385.00
PS-7 POWER SUPPLY DELUXE TR-7/DR-7	269.00
PS-7S POWER SUPPLY STANDARD TR-7/DR-7	179.00
SP-7S SPEECH PROCESSOR TR-7/DR-7	148.00
SL-300, SL-500, SL-1800, SL-4000, SL-6000, TR-7 OR R-7 (EACH)	49.00
FA-7 FAN TR-7, PS-7, DL-1000	29.00
RV-7 REMOTE VFO TR-7	175.00
MS-7 SPEAKER	39.00
7077 DESK MIKE W/PLUG TR-7	46.00
AUX-7 RANGE PROGRAM BOARD TR-7	42.00
NB-7 NOISE BLANKER TR-7	82.00
MN-7 ANTENNA TUNER 250W, 160-10M	159.00
MN-2700 ANTENNA TUNER 1KW, 160-10M	269.00
CS-7 REMOTE CONTROLLED ANT SWITCH	158.00
WH-7 WATTMETER 2KW 1.8-30 MHZ	89.00
B-1000 BALUN 4:1, MN-7, MN-2700	29.00
DL-300 DRY DUMMY LOAD 300W	26.95
DL-1000 DRY DUMMY LOAD 1KW	53.00
L-7 AMPLIFIER WITH PIS AND TUBES	1,175.00
TV-3300LP LOW PASS FILTER 1KW	26.00
R-7/DR-7 RECEIVER, DIGITAL, 0-30 MHZ	1,295.00
R-7/DR-7 CABLE INTERFACE KIT	29.50

ICOM

251A TRANSCEIVER, 2M, AC & 12V MULTIMODE, 10W	625.00
551 TRANSCEIVER, 6M AC & 12V MULTIMODE, 10W	390.00
551D TRANSCEIVER, 6M 12V, 20W W/ EX107, 106	585.00
720 HF TRANSCEIVER, 9 BAND PLUS GEN COVERAGE RECEIVE, AND PS-15 PIS	1,168.00
255A TRANSCEIVER 2M FM, 25W, 5YN, 12V	345.00
260A TRANSCEIVER FM/SSB, 10W, 12V	429.00
PS-20 PIS 20 AMP 551D	180.00
EX106 FM OPTION 551, 551D	115.00
EX107 VOX OPTION 551	49.00
EX108 PBT OPTION 551	96.00
IC-2A H.T. WITH NICADS, CHARGER, ANT	210.00
IC-2AT H.T. WITH T.T. NICADS, CHARGER, ANT	235.00
BC-30 DROP-IN CHARGER IC-2A, 2AT	69.00
BP-2 NICAD PK 425MA/7.2V, 2A, 2AT	34.50
BP-3 NICAD PK 250MA 2A, 2AT	27.50
BP-4 ALKALINE CASE 2A, 2AT	9.50
BP-5 NICAD PK 425MA AT 10.8V, 2A, 2AT	47.50
DC-1, DC OP PACK, 2A, 2AT	17.50
HM-8 MIKE WITH TONE EN-DR, 251A, 255, 260A, 8 PIN PLUG	39.50
HM-9 SPEAKER MIKE IC-2A/2AT	28.50
HM-10 SCANNING MIKE IC-255A, 260A	39.50

TEN-TEC

515 ARGONAUT, 5W, SSB/CW TRANSCEIVER	\$ 379.00
210 POWER SUPPLY ARGONAUT	32.00
546 OMNI C, DIGITAL, 9 BAND, TRANSCEIVER	1,045.00
255 POWER SUPPLY OMNI C	149.00
580 DELTA, DIGITAL, 9 BAND, TRANSCEIVER	745.00
280 POWER SUPPLY DELTA	135.00
570 CENTURY 21, 70W CW TRANSCEIVER	310.00
444 HERCULES, 1KW LINEAR AMPLIFIER W/PS	1,395.00
208A NOTCH/CW FILTER 515	37.00
234 SPEECH PROCESSOR	112.00
214 ELECTRET MIKE FOR 234	34.50
215PC MIKE W/PLUG, COILED CORD	32.00
217 500HZ FILTER 546	49.00
218 1.8 KHZ FILTER 546	49.00
219 250 HZ FILTER 546	45.00
243 REMOTE VFO 546	159.00
247 ANTENNA TUNER	63.00
248 NOISE BLANKER 546	44.00
274 DIGITAL MOD KIT FOR 570	85.00
276 CRYSTAL CALIBRATOR 570	26.00
277 ANTENNA TUNER/SWR BRIDGE	80.00
282 250 HZ FILTER 580	45.00
283 REMOTE VFO 580	159.00
285 500 HZ FILTER 580	42.00
289 NOISE BLANKER 580	37.00
645 ULTRAMATIC KEYS, ALL MODELS	80.00
670 KEYS, CENTURY 21	32.00

TEMPO

S-1T WITH T.T. NICADS CHARGER 2M	258.00
S-5T WITH T.T. NICADS, CHARGER 1/5W 2M	359.00
S-2T WITH T.T. NICADS, CHARGER 220 MHZ	359.00
TS-CC LEATHER CASE, ALL MODELS	16.00
TS-HA HELICAL ANTENNA S-1, S-5, S-2	9.00

ORDER BY MAIL OR PHONE BILL SLEP 704-524-7519. WE PAY SHIPPING TO 50 STATES, APO, FP--MASTER CHARGE, VISA OR CHECKS ACCEPTED, SAVE MONEY BY ORDERING TODAY AT THESE LOW DISCOUNT PRICES.



Electronic Distributors

Slep Electronics Company

P. O. BOX 100, HWY 441, DEPT. 73
OTTO, NORTH CAROLINA 28763

✓367

they received that night might also have been of Japanese origin, though it has never been proven.

In 1944, McCallum wrote an account of the flight that night:

"[After leaving Yunanyi] we flew for some time on the same heading, over an overcast and just flying ETAs (estimated time of arrival). We then changed our heading and were still climbing, finally topping it at 24,000 feet.

"When we had estimated that we were within range of our station [Jorhat], we started concentrating on our radio compasses, which began to reciprocate and were not coming in. Next came our try at the radio range, which was throwing As and Ns at us.

"We went on flying over the overcast and trying to see [ground] lights when we hit a break in the clouds.

"Just to be on the safe side, we decided to have a QDM [bearing] shot. . . . Spencer told them to shoot a bearing and gave them a long call. They came back and told us to fly 278 degrees. This was done via Chabua and Jorhat. We decided this couldn't be right, and Spencer relayed the [Crozier's] question if it was 'reciprocal' or 'to fly.' The answer came back 'to fly.' We flew this for a while trying to get contact and see if there were any lights below. Fifteen minutes went by and another bearing was shot.

"... they gave us the same heading, 'to fly.' We told them they must be wrong. . . the total flying time on this heading was 40 minutes. Another bearing was shot and this time it was 'to fly' 268. And then another which was the same."

What nobody realized was that the plane had been blown off-course by winds later estimated to be from the south at about 100 mph.

By the time they were given the 268 heading, they were probably many miles north of their supposed course.

Suddenly Crozier turned to McCallum. "Mac, does that look like a mountain out there?" "It sure is, and I've got one over here!" Crozier twisted the plane into a sharp bank and one of the mountain peaks flashed by, barely feet away.

Thirty-seven years later, McCallum still remembered: "If we'd had our landing gear down, we'd have left tracks in the snow."

Because of the storm, they were still flying at about 24,000 feet—far higher than normal on the route over the Hump in good weather—and those mountains had loomed higher than the plane. For the first time they realized they were really lost, and McCallum quietly tightened his parachute harness as much as possible without leaving the cockpit.

Spencer called the ground station again; the distant operator asked to have the plane's landing lights turned on. "You're over Chabua, we've sighted you, watch for a green flare," Spencer was told. (McCallum thinks the message was a harmonic with another airfield in the area; harmonics were "quite common at night with HF equipment.") Everybody who could get to a window tried to spot the flare, but instead they saw flickering lights through a break in the cloud cover.

Crozier took the plane down and circled the lights, looking for the Chabua field. It wasn't Chabua below, nor Jorhat, nor any of the other bases in the area—the men couldn't recognize anything except that they were over some city of fair size. They took the plane back to about 20,000 feet and flew for a few minutes while Crozier and Mc-

Callum talked over the situation. Fuel was becoming critically low: Planes flying the Hump were given only enough fuel to make their destination and return, with about 45 minutes extra flight time.

They were already long overdue at Jorhat, and even as they talked, Number Two engine sputtered and died. Perram was sent back to make a fuel transfer from one of the other tanks, but before he could begin, another engine coughed, smoothed out, coughed again, and quit. Crozier, as commander of the aircraft, made the decision: They would have to bail out.

Parachute jumps were especially dangerous over the Hump route even in daylight, and night jumps were even more so. In daylight, a jumper had some chance of choosing his landing spot. At night he might land in a tree or be impaled on a clump of bamboo, land in a river and drown, or simply plummet straight to the ground beneath an unopened 'chute—parachutes were just as prone to the weather problems as other equipment. Still, there was little choice for the five men. It was jump and have an even chance at survival on the ground, or stay with the plane to almost certain death.

McCallum trimmed the plane level while Crozier took the rest of the crew to the cargo compartment and prepared to jump, but not before Spencer sent out a distress call and screwed down the sending key. When McCallum left the cockpit for the last time, the altimeter read 17,500 feet, all engines were dead, and the plane was dropping rapidly—a C-87 wasn't known for its gliding ability.

In the rear, McCallum found all four men still trying to get the door off—it had opened about two feet and jammed. McCallum

and Crozier wrestled it further open until it fell away from the plane. Crozier, Spencer, and probably Perram exited first (Huffman says Perram and McCallum were still aboard when he left; McCallum says the order was Crozier, Spencer, Perram, Huffman, and McCallum).

McCallum started to the door, realized Huffman didn't have his harness straps properly hooked, and went back to help. They got the harness on, though it wasn't tight enough and there was little time to adjust it. Just as Huffman snapped the final hook, the plane lurched as if going into a spin. McCallum knew that once the plane began spinning, centrifugal force might pin them inside all the way to the ground. He hustled Huffman out the door and followed immediately.

McCallum and Huffman both agree that the scene was one of urgency without panic. They also agree that the time from cockpit to bail-out was about one minute.

McCallum hit the airstream and pulled his ripcord, expecting a long ride to the ground, since the crew still thought they were somewhere over India, or perhaps Burma.

He felt the shock of the 'chute opening, and seconds later hit the ground and was knocked unconscious for an indeterminate period of time. When he came to, his watch had stopped at 10:45 p.m. It was dark, but there was enough light to see that he was sitting on the edge of a precipice.

When the sun came up the next morning, McCallum found himself on the side of a mountain, which the crew later decided was more than 16,500 feet high.

As McCallum took stock of his situation and

checked his equipment, he took the Form 58, the sheet signed by the parachute packer, from the 'chute bag—it was common for surviving jumpers to personally thank the rigger. He didn't have to wait long to do that—it was his own name at the bottom. As Assistant Parachute Officer at Jorhat, McCallum packed one 'chute a month as practice. This month, the 'chute he'd packed had been the one he jumped with.

Within an hour or two, McCallum, Crozier, and Spencer had located each other by shouting. Crozier and Spencer were together 1000 or 1500 feet lower than McCallum and perhaps a quarter of a mile away.

Huffman and Perram couldn't be seen. Huffman had landed in a hole and was dangling by his harness; he could hear the other three, but couldn't yell loudly enough to attract their attention. Despite a badly injured left arm—possibly a broken collarbone—he later managed to pull himself out of the hole, but by then, McCallum, Crozier, and Spencer were gone.

Perram had landed on the far side of the peak; during the next few days, he suffered frostbitten feet, but eventually recovered with no damage.

By the fourth day, both Huffman and Perram had been brought to Tsetang. Both men had been found by Tibetans who already knew of the presence of the other three men in Tsetang.

McCallum, who had been studying Hindustani in his free time, was able to talk to one man in the village—everyone else spoke a strange language he'd never heard before. The three Americans were unpleasantly surprised and shocked to learn they had landed in Tibet, several hundred miles to the northeast of

Jorhat. There were no American bases—in fact, no Americans at all—in Tibet. The nearest American base was to the south in India, on the other side of the Himalayas.

By the evening of December 2, 1943, Crozier, McCallum, and Spencer were resting in a nearby village called Tsetang which they had found by following a mule caravan.

For two weeks the men waited in Tsetang while the village elders sent messengers back and forth to Lhasa, the capital city, for instructions on how to deal with the Americans. Tibet was a country isolated not only by physical features, but also by national policy. Almost certainly, no more than five Americans had ever visited the country, though both the British and the Chinese maintained small trade missions in Lhasa, both of which aided the flyers in their subsequent journey through Tibet.

Finally word arrived that they were to go to Lhasa, a three-day trip by horse or mule.

At Lhasa they were stoned by an angry crowd of Tibetans. The Americans couldn't understand why; up to this point, all the Tibetans had been friendly. It wasn't until they arrived at Deyki Lingka, home of Mr. and Mrs. George Sherriff of the British Trade Mission, that George Sherriff explained the problem: When the plane had circled the lights of the strange city weeks earlier, they had been over Lhasa, the Holy City of Tibetan Buddhism and the home of the Dalai Lama, the supreme God to the Tibetans. It was a mortal sin, according to the Tibetans, for anyone to place himself physically above the Dalai Lama, whose home was the Potala, a palace of 1000 rooms looming high above Lhasa. The

Americans, unknowingly, had been guilty of a religious transgression.

Because of this sin, fanatical monks were agitating the Tibetan populace in Lhasa, and the Tibetan government insisted it could not be responsible for the safety of the Americans in Lhasa. After only three days in Lhasa (spent inside Deyki Lingka for safety), they were escorted to the edge of Lhasa by a crowd of Chinese officials and Mr. and Mrs. Sherriff, as well as other members of the British Mission.

On their first day in Lhasa, Reggie Fox AC4YN, an expatriate Englishman who later married a Tibetan woman, sent a radio message to China informing authorities that all five men were safe. (McCallum has the telegram received by his mother after the plane was lost, reporting him missing, and another a few weeks later after Fox's message was received.)

Fox's station, AC4YN, was a powerful one, and Fox was able to work as far as Indiana, USA, with the equipment, which probably was powered by a small hydroelectric plant on a river about eight miles from Lhasa. (In the mid-'30s, a Tibetan named Rangang, an engineer educated in England, seems to have almost single-handedly built the power plant, which may have been under contract from General Electric Corporation. Another source says the unit was diesel, but since fuel would have had to be carried in over the mountains by mule, the hydro unit seems more reasonable. There were no autos or trucks, or, in fact, wheeled vehicles of any kind, in Lhasa—except for two circa 1920 autos which no longer ran.)

On the edge of Lhasa, the Americans said good-bye to their newly-met British friends and to the Chinese,

and guided by two Tibetan soldiers and a Tibetan cook who spoke some Hindustani, set out for India. On the journey, McCallum served as the group's interpreter, through the cook.

Fifty-two days after bailing out of the plane, the five men were back in Jorhat, by way of Darjeeling and Calcutta. Theirs is believed to have been the second-longest walk-out of any downed crew in World War II—the longest was 93 days.

In 1980, four of the crewmen were still living. Crozier lives in Texas; Spencer went back to Long Island. Huffman is retired and lives in the state of Washington. McCallum, who makes his living as a corporate chief pilot, lives in Pennsylvania. William Perram was killed on his first flight after returning from Tibet.

George Sherriff died at his home in Ascreavie, Scotland, in 1967. His wife, Betty, died in 1979. Reggie Fox, still in Tibet in 1948, has dropped from sight.

As for the airplane, #42-107270, she had crashed not far from Tsetang. While the men waited in Tsetang for instructions from Lhasa, they were taken out to the wreckage. The aircraft came down at the edge of the Tsangpo River, which becomes the Brahmaputra in India and flows through Jorhat.

As the men watched, hordes of Tibetans savaged the hulk of the plane for usable metal. One man tried to carry away part of the radio gear but found it too heavy to manage. He seized an axe, hacked the unit in half, and proudly carted away the pieces.

Like many another wreck further south in India or Burma, the skeleton of #42-107270 may still rest along a river bank in a distant country which few Americans have ever seen. ■

R_x and C_x

— easy-to-build substitution boxes

I finally got tired of trying to read the ohmmeter, hold the test leads in place, and turn the potentiometer to find a resistance value that would keep my experimental circuit from going up in smoke.

What I needed was a re-

sistor substitution box. Well, I got out some paper and a pencil and went to work. The circuit shown in Fig. 1 is the result.

By using 28 resistors and switches in the 1-2-3-3 arrangement, I now have at my fingertips—in one-Ohm

steps—resistance values of 1 to 9,999,999 Ohms.

Construction of this unit is simple. The resistors are mounted across the switches' terminals. By opening a switch, that resistor is connected in circuit.

The switches are ar-

ranged in rows of seven across and four down (See Fig. 1). Then the resistor/switch combinations are connected in series. I used slide switches in my unit (I happened to have them on hand).

The rectangular openings were cut out with a nibbling tool and the switches were mounted to the box panel with pop rivets.

With the use of 1% resistors, there is a possible error of $\pm 100k$ (that's with all resistors in circuit for a total of 9,999,999 Ohms).

With this circuit, there is a possible monetary advantage over conventional resistance substitution boxes which usually require sixty-three resistors and seven ten-position switches to cover the same range.

A Capacitor Substitution Box

A ham shack without a capacitor substitution box?

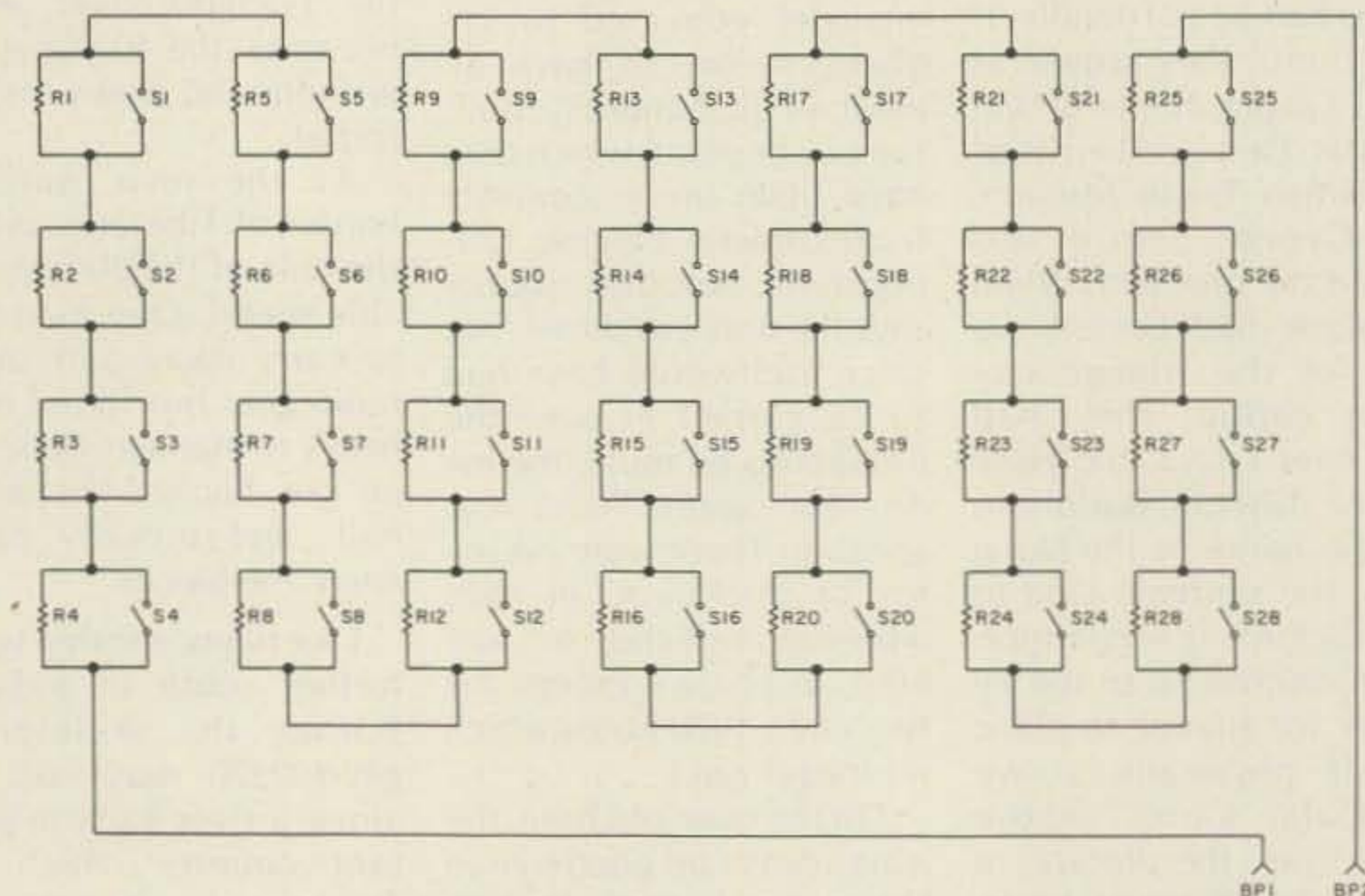

Fig. 1. Schematic for resistor substitution box.

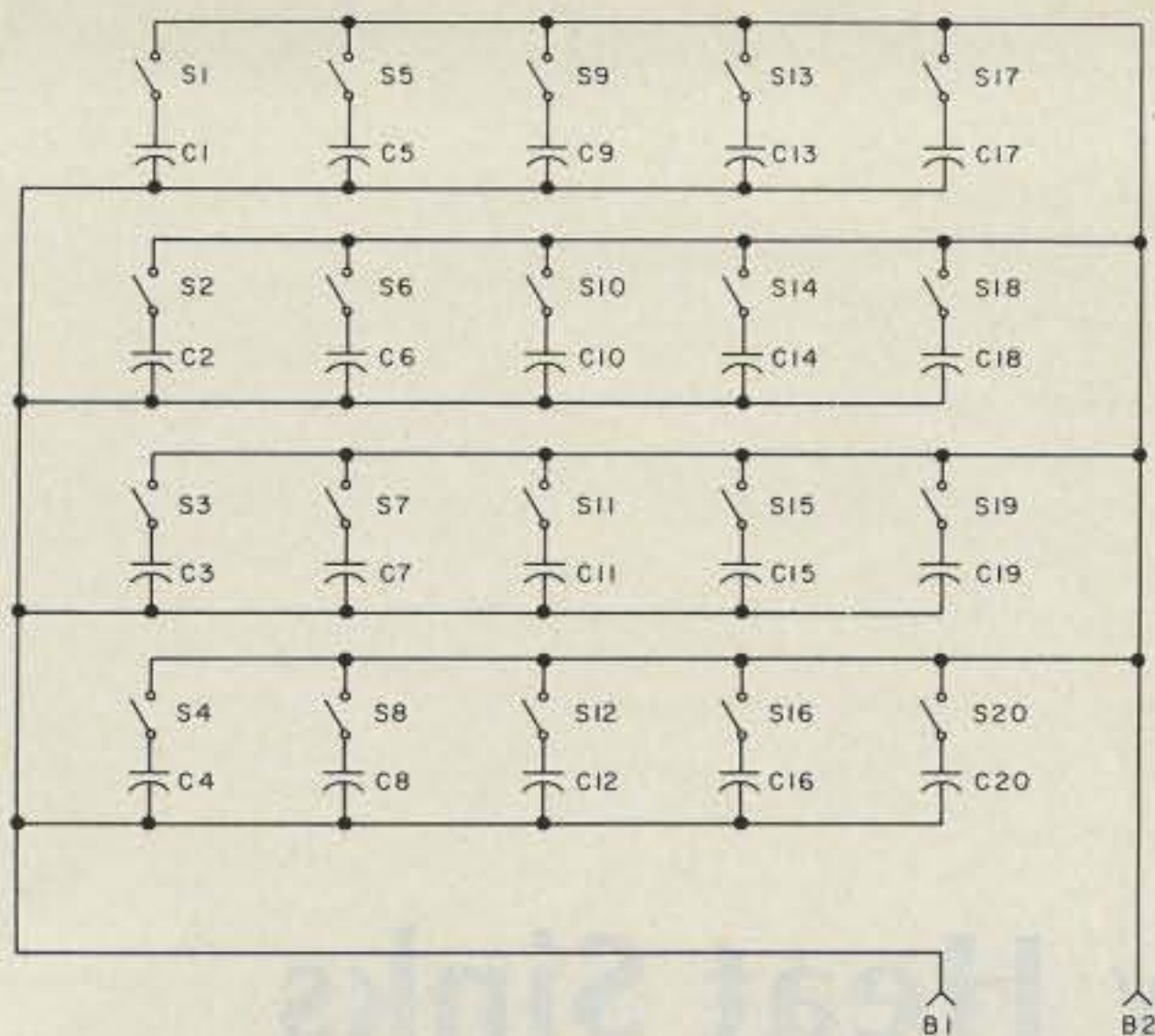

Fig. 2. Schematic for capacitor substitution box.

I don't believe it. Well, I've been wrong before, so, if yours happens to be without one, build this one.

This capacitor substitution box has a range of from 10 pF to within 10 pF of 1 uF, in 10-pF steps. That amounts to 99,999 possible values. This is done with

only twenty capacitors and switches. Construction of this unit is simple and straightforward. The capacitors are connected between a common line (B1) and one terminal on each switch. The other terminals on the switches are wired to B2. The switches are arranged in rows of four down

Resistor Substitution Box	
Parts List	
R1	1 Ohm
R2	2 Ohm
R3-R4	3 Ohm
R5	10 Ohm
R6	20 Ohm
R7-R8	30 Ohm
R9	100 Ohm
R10	200 Ohm
R11-R12	300 Ohm
R13	1k Ohm
R14	2k Ohm
R15-R16	3k Ohm
R17	10k Ohm
R18	20k Ohm
R19-R20	30k Ohm
R21	100k Ohm
R22	200k Ohm
R23-R24	300k Ohm
R25	1 Megohm
R26	2 megohm
R27-R28	3 megohm
S1 through S28	—SPST slide or toggle switches
B1, B2	—5-way binding posts
Misc.	—wire, cabinet, rub-on letters and numbers

Capacitor Substitution Box	
Parts List	
C1	10 pF
C2	20 pF
C3	30 pF
C4	30 pF
C5	100 pF
C6	200 pF
C7	300 pF
C8	300 pF
C9	0.001 uF
C10	0.002 uF
C11	0.003 uF
C12	0.003 uF
C13	0.01 uF
C14	0.02 uF
C15	0.03 uF
C16	0.03 uF
C17	0.1 uF
C18	0.2 uF
C19	0.3 uF
C20	0.3 uF
S1 through S20	—SPST switches (slide or toggle type)
B1, B2	—5-way binding posts
Misc.	—wire, cabinet, rub-on letters and numbers

and five across (Fig. 2). I used mica (5%) and polystyrene (2%) capacitors in my unit.

Of course, the tighter the tolerance on the capacitors, the more accurate the unit. ■

RAPID MOBILE CHARGER

The DEB-TED Rapid Mobile Charger is a constant voltage charger that will charge your batteries off a 12 Volt source in 4-6 hours. You may use the charger at all times, this includes transmit and receive periods. It is equipped with a cigarette lighter plug on the input side and the appropriate charging plug on the output side. Models available now for the Kenwood TR2400, Yaesu 207R, Tempo S1, S2, S5 and the Wilson Mark II and IV. Other models available also please call or write for info..... \$34.95.



COMING SOON THE NEW AC VERSION

VEHICLE INTRUSION ALARM

An easy to assemble and install kit that offers options not normally found in other alarm systems. Hidden switch mounts under the dash. Kit has provisions for sensors and remote control switch. Programmable time delays for exit, entry and alarm periods. Basic hook-up utilizes dome light circuit activating when doors are opened. The alarm will drive a siren or pulse horn at a 1HZ rate. Not prone to false alarm do to reliable CMOS circuitry. No external switch required! Complete kit with easy to follow instructions and diagrams..... \$12.95
Wired and Tested..... \$19.95

"SEE THE WORKS" CLOCK

OUR EASIEST CLOCK TO ASSEMBLE!

6 Digits 12 or 24 Hour Format
Clock rests between two pieces of clear plexiglas A GREAT CONVERSATION PIECE!
Kit is complete including top

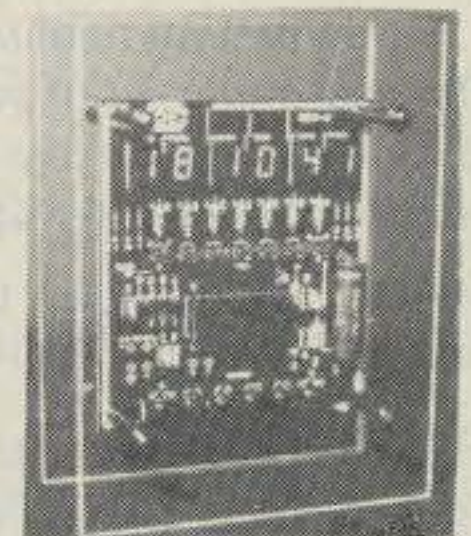

quality PC board, all components pre-cut and drilled plexiglas and all hardware. \$29.95
Wired and Tested..... \$39.95

SPECIAL



SPECIAL

MODEL 5314 CLOCK KIT 12 or 24 hour format 6 large "5 Digits. Kit is complete with all parts, pc board and custom designed cabinet. (specify white or black)..... \$29.95



DEBCO ELECTRONICS
P.O. BOX 9169
CINCINNATI, OHIO 45209

- Add 5% Shipping for U.S. & Canada
- All foreign orders add 10%
- COD orders add \$1.25
- Master Charge and Visa Welcome
- Orders under \$20.00 add \$1.00 handling
- Ohio residents add 4½% Tax

CALL OR WRITE FOR CATALOG

330

Phone: (513) 731-7220

Don't Be Sunk by Heat Sinks

— a painless introduction to heat-transfer physics

Konrad Roeder WA4OSH
8401 Spain Rd. NE, #9-A
Albuquerque NM 87111

Application

Find the right heat sink for an LM309K voltage regulator IC. The maximum input voltage is 10 volts, the output voltage is to be held at a constant 5 volts, and the maximum current to be drawn from the supply is 1 Amp.

Step 1: Write down the formula:

$$R\theta_{SA}(\max) = (T_J - T_A) / P_D - R\theta_{JC} - R\theta_{CS}$$

Step 2: Calculate P_D :

$$P_D = (V_{in} - V_{out}) \times I(\max)$$

$$P_D = (10\text{ V} - 5\text{ V}) \times 1\text{ A} = 5\text{ Watts}$$

Step 3: Find $T_J(\max)$ and derate by 50°C . The data sheet gives us a figure of 125°C for the absolute maximum operating junction temperature; derating that figure by 50°C gives us 75°C for $T_J(\max)$.

Step 4: Find $T_A(\max)$. The maximum ambient temperature is 25°C , 5°C above room temperature of 20°C .

Step 5: Find $R\theta_{JC}$. Keep in mind that the LM309K is an IC, not a transistor. The data sheet reveals a figure of 3.0°C/W for $R\theta_{JC}$. For transistors, Table 1 is fairly accurate, but for ICs, watch out!

Step 6: Find $R\theta_{CS}$. Since the case is ground on the LM309K used as a fixed 5-volt regulator, we will not need an insulating washer. To improve the heat transfer between the device and the heat sink, we will use some heat-sink compound. From Table 2 we obtain a value of 0.1°C/W for $R\theta_{CS}$.

Step 7: Plug the values into the formula:

$$R\theta_{SA}(\max) = (75^\circ\text{C} - 25^\circ\text{C}) / 5\text{ W} - 3.0^\circ\text{C/W} - 0.1^\circ\text{C/W} = 6.9^\circ\text{C/W}$$

Step 8: Pick a suitable heat sink. Choose the next lower value for a TO-3 type case. The RCA-SK KH3423 looks suitable with a $R\theta_{SA}$ value of 5°C/W .

For years I have been resorting to B.F.I. (Brute Force and Ignorance) when designing transistor projects. Mainly, this meant using the biggest heat sink I could afford or watching my project go up in smoke. After the loss of a few precious power transistors, I set out to find out all about proper heat sinking. The principle behind picking the right heat sink is rather simple.

In this article, we will explore heat-transfer physics, interfaces, and practical

heat-sink choices. First, let's look at how heat sinks work.

Theory

Heat-transfer physics is a scary-sounding phrase for something that some hams don't think they know about, although they know of something similar: basic electricity. Fig. 1 shows the analogy between thermal resistance and ohmic resistance.

In electrical circuits, whenever there is a difference of voltage between

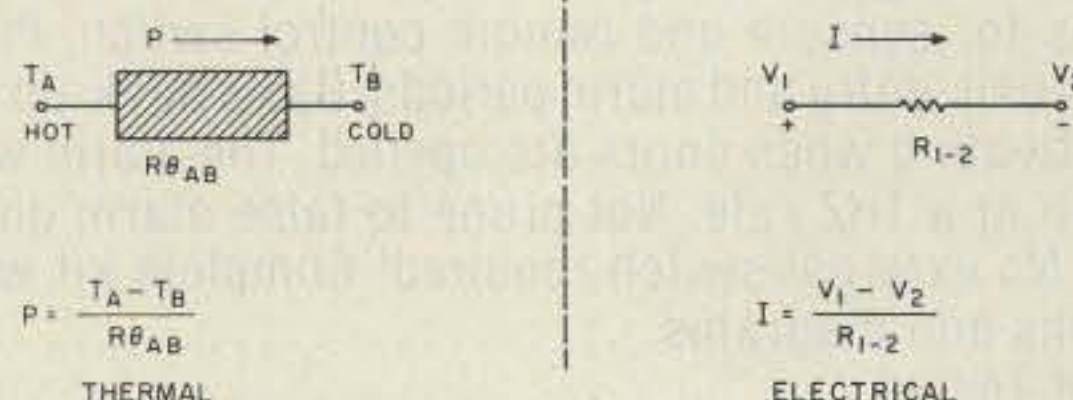

Fig. 1. The electrical analog of heat transfer.

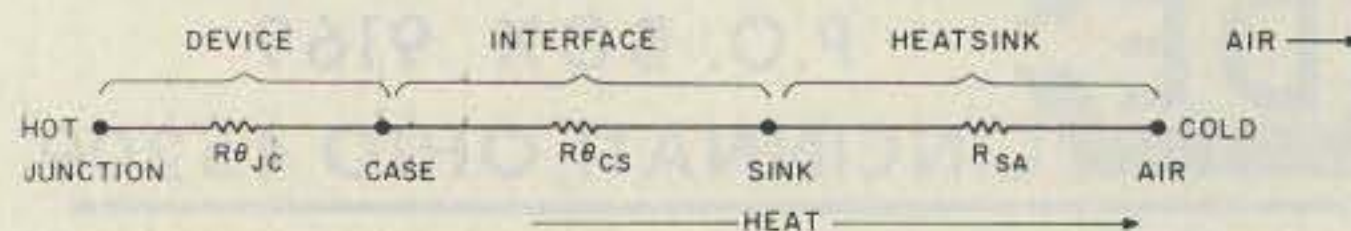

Fig. 2. The electrical analog of heat transfer from the junction of the semiconductor to ambient air ($R\theta_{JA} = R\theta_{JC} + R\theta_{CS} + R\theta_{SA}$).

two points, or nodes, current is said to flow from the more positive node to the more negative node. The amount of current that flows is inversely proportional to the resistance between the two nodes.

Similarly, in thermal circuits, whenever there is a difference of temperature between two bodies (T_A and T_B) or between two portions of one body, heat (P) is said to flow in a direction from higher to lower temperature. This heat flow is expressed in Watts. The amount of heat which flows when a given change in temperature is applied will be found to vary with what is called the thermal resistance of the material ($R\theta$). The lower the thermal resistance of the material, the greater the heat it transfers. Thermal resistance can be expressed in terms of degrees centigrade per Watt ($^{\circ}\text{C}/\text{W}$).

Applying the Theory to Heat Sinks

In semiconductors, heat is produced at the junction of the differently-doped silicon materials. To escape the semiconductor, heat travels from the junction through the case, the interface, and the heat sink into the ambient air. The heat sink dissipates the heat into the surrounding air by means of radiation and convection. The whole system can be represented by the electrical equivalent circuit shown in Fig. 2.

The total thermal resistance from junction to air is the sum of individual thermal resistances: junction to case ($R\theta_{JC}$), case to sink ($R\theta_{CS}$), and sink to air ($R\theta_{SA}$). Applying the analogy found previously, we can say that $P_D(\text{max}) = [T_J(\text{max}) - T_A(\text{max})] / R\theta_{JA}(\text{max})$, where P_D is the maximum power dissipated by the device in Watts, T_J is the maximum junction temperature in $^{\circ}\text{C}$,

T_A is the maximum ambient temperature in $^{\circ}\text{C}$, and $R\theta_{JA}$ is the maximum thermal resistance from junction to ambient air in $^{\circ}\text{C}/\text{W}$. With a little algebra, we can combine the two formulas found above and get a very useful equation for finding the correct heat sink. In this equation, $R\theta_{SA}(\text{max}) = [(T_J - T_A) / P_D] - R\theta_{JC} - R\theta_{CS}$.

Although manufacturers list maximum junction temperatures of 150°C - 200°C , it is a good design practice to operate the device at a much lower temperature. To ensure plenty of leeway and extend the useful life of the device, use a maximum junction temperature of 50°C less than the manufacturer's listed maximum junction temperature.

There are several ways of obtaining the maximum power dissipated by the device. A simple way of calculating the power dissipated is: $P_D(\text{max}) = P_{\text{input}} \times (1 - \text{eff})$.

Another way of calculating the power dissipated is: $P_D(\text{max}) = I(\text{max}) \times E(\text{max})$.

In some cases, the actual power dissipated may be less than these values, but keep in mind this is a worst-case figure.

The thermal resistance from the junction to case ($R\theta_{JC}$) depends mostly on the type of case that the device is packaged in. Although it is best to obtain the value from the data sheet for the transistor or semiconductor device, Table 1 shows some typical values if the data sheet is unavailable.

The thermal resistance from case to sink ($R\theta_{CS}$) depends on a handful of factors: the type of washer used (if any), the tightness of the transistor or semiconductor device against the heat sink, and whether or not silicone thermal paste or heat-sink compound is used. Some approximate values are shown in Table 2.

It should be fairly obvi-

Case	$R\theta_{JC}$	Washer	Paste	No Paste
TO-3	1.5	none	0.1	0.2
TO-5	30.0	beryllia	0.2	0.4
TO-18	150.0	alumina	0.3	0.5
TO-36	0.7	mica	0.4	0.8
TO-39	35.0			
TO-66	7.0			
TO-92	125.0			
TO-220	4.0			

Table 1. Typical values for $R\theta_{JC}$ for common case styles.

ous why thermal joint compound is important. These zinc oxide and silicone oil mixtures reduce the high thermal resistance of the air gap between the case and the heat sink. But be sure to use it sparingly; the paste has a large thermal resistance and it is important to keep the layer as thin as possible.

A list of commonly available heat sinks and their thermal resistances ($R\theta_{SA}$) is shown in Table 3. The thermal resistance of heat sinks can be improved or lowered by improving the heat-sink-to-air interface. When the ambient air moves, it more readily accepts heat; thus, some benefits can be gained from a fan blowing across the fins of the heat sink. Also, a change in color can decrease the thermal resistance of a heat sink. A

Table 2. Approximate values for $R\theta_{CS}$.

thin coat of flat black paint (such as barbecue black) sprayed over a shiny aluminum heat sink lowers the thermal resistance by about 25%. For a real application, see box.

Conclusion

Although calculations in finding the right heat sink can be much more complicated, this article was written to simplify heat transfer physics as much as possible for the amateur or radio experimenter. Hopefully, the reader will be able to pick the right heat sink for the right job with the guidelines presented here. ■

For More Information:

International Electronic Research Corp.
135 West Magnolia Blvd.
Burbank CA 91502

Thermalloy, Inc.
PO Box 340839
Dallas TX 75234

Wakefield Engineering
60 Audubon Road
Wakefield MA 01880

Brand	Stock	$R\theta_{SA}$	Fits these cases
Calectro	J4-866	23*	TO-220
	J4-878	11	TO-3
	J4-880	2.25	(2) TO-3, TO-36, TO-66, and TO-220
Radio Shack	276-1361	2.25*	(2) TO-3, TO-36, TO-66, and TO-220
	276-1363	20*	TO-220
	276-1364	13*	TO-3
RCA-SK	KH3413	80	TO-1, TO-18, TO-72, TO-104, and TO-92
	KH3415	52	TO-5 and TO-39
	KH3417	20	TO-220
	KH3421	15	TO-66
	KH3423	5	TO-3
	Thermalloy	6011	60
6087		25	40 pin DIP ICs
6038		10	TO-220
6017		8	TO-66
6013		8	TO-3
6157		0.9	Circuit board or external mounting
Wakefield Engineering	502	1.3	TO-36
	641	3.5	TO-3

*The $R\theta_{SA}$ values for these heat sinks were found experimentally by the author.

Table 3. Typical values for $R\theta_{SA}$.

Tracker— The Ultimate OSCAR Finder

After a few weeks of "sensory overload" playing games with our new 16K Level II TRS-80 systems, both Dennis and I realized that there was a huge untapped potential inside that rather innocent-looking case. What better way to tap it than to harness the power of the computer to make our hobby a lot more fun by allowing us to operate more and calculate less?

Having both cut our teeth on KIM-1™ systems, and having built them up to the degree of having BASIC programs running on them,

we decided that translating some of those programs over to the TRS-80 would be a good way to familiarize ourselves with its capabilities.

The first of the translations undertaken was the program we wrote to track the OSCAR satellites. Considering that both of us are AMSAT members and OSCAR enthusiasts, it seemed like the logical thing to do. Besides, anything that we could use around the shack was bound to be more fun than another game.

Satellite Tracker is Born
 "Tracker" is the fruit of

that labor. This program will allow you to use your Level II TRS-80 to track OSCAR 7 and 8 (or any satellite in a polar orbit). Using only the Reference Orbit information published monthly in 73 Magazine, QST, or ARRL bulletins, Tracker will compute the orbits for the day, the time and longitude of each pass (its EQX), and azimuth and elevation data for your steerable beam arrays.

In addition, some slick

features have been added that weren't in the original KIM-1 program. For instance, you may now enter a second station's latitude and longitude and Tracker will compute a "Mutual Visibility Window" indicating when the stations will have simultaneous access on any given pass (great for those DX orbits). Line printer routines for hard copy have also been added and will support non-Radio Shack printers as well as the parallel-port Cen-

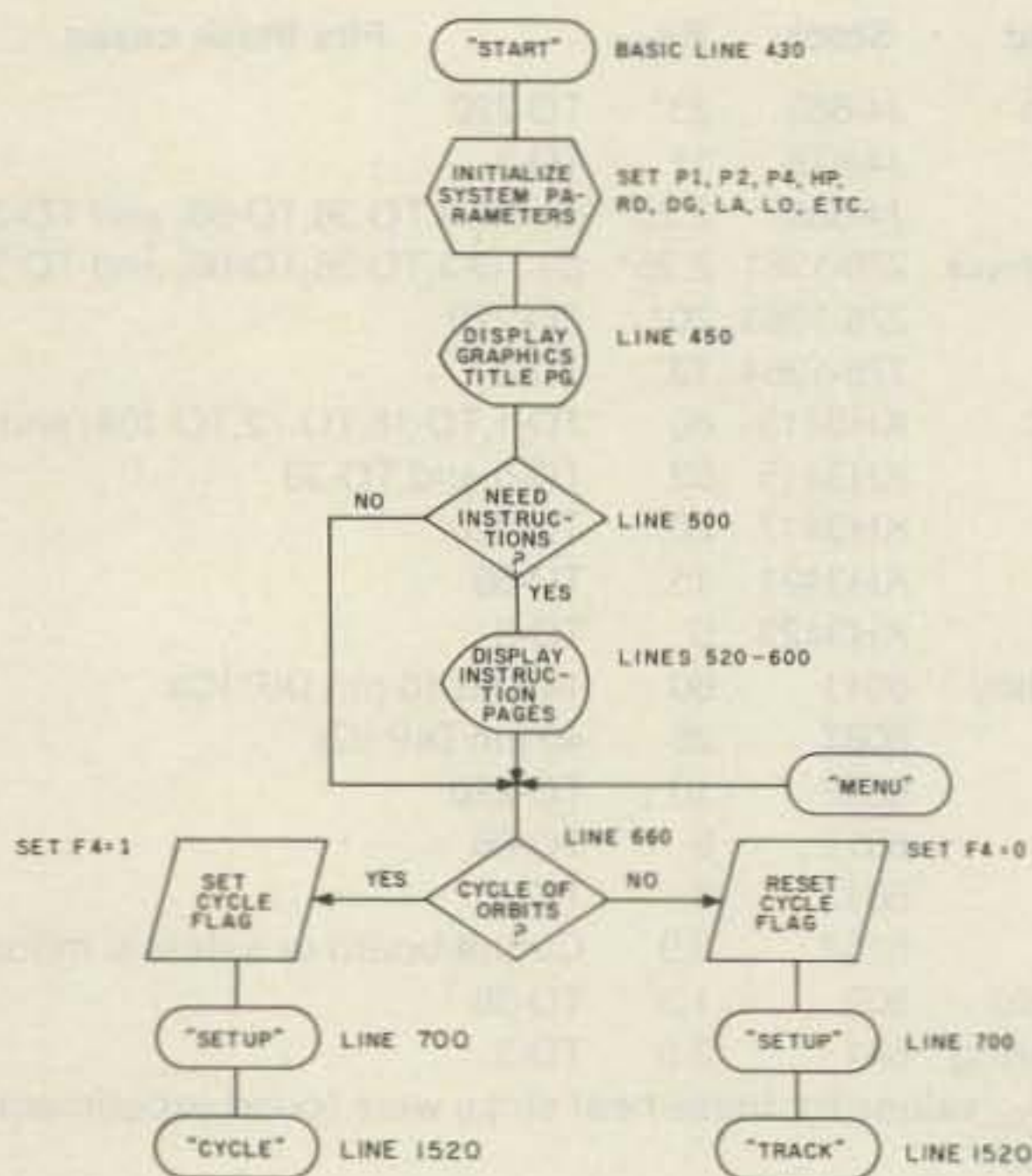

Flowchart 1. Main selection logic.

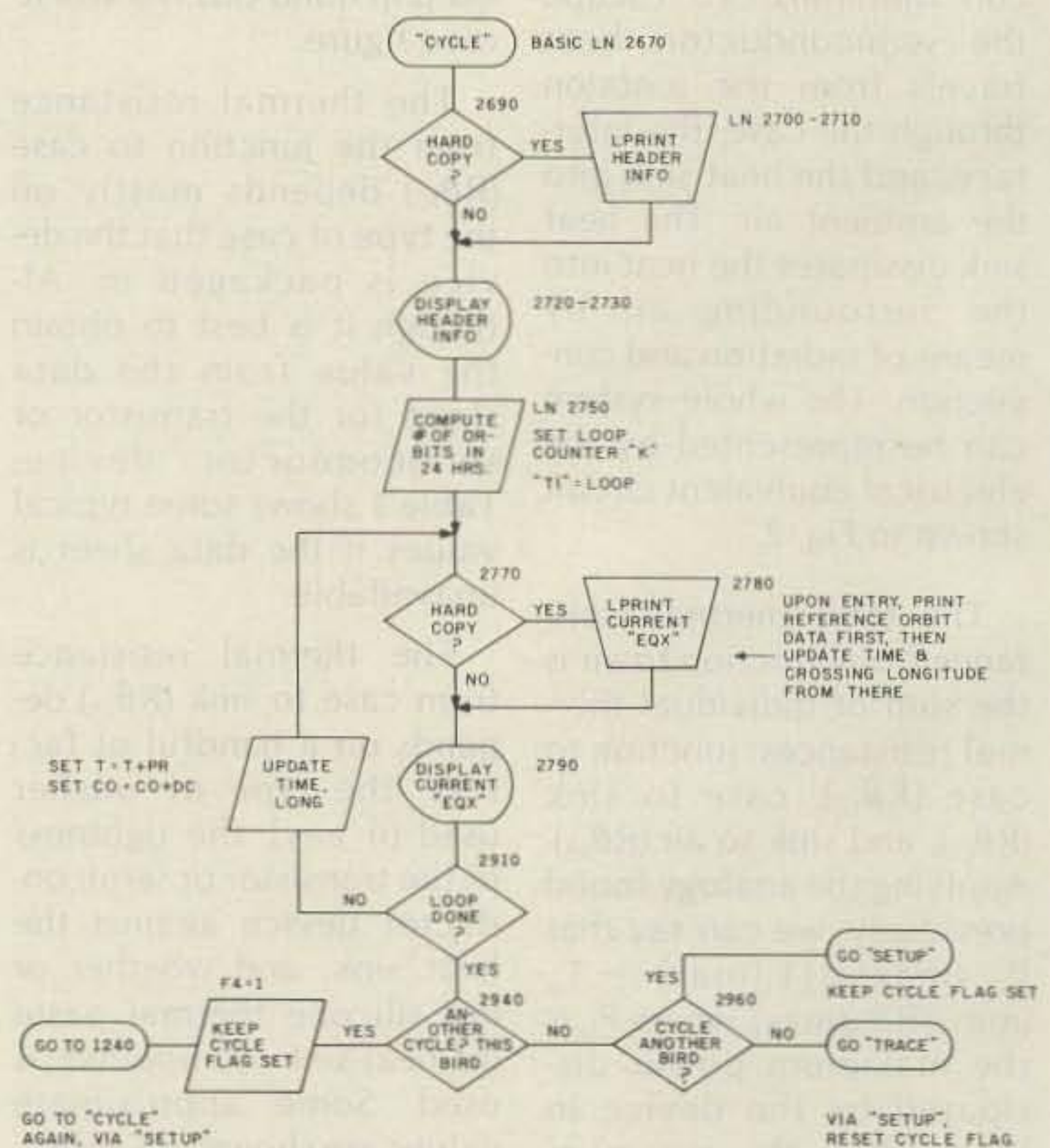

Flowchart 2. Orbit Cycle logic.

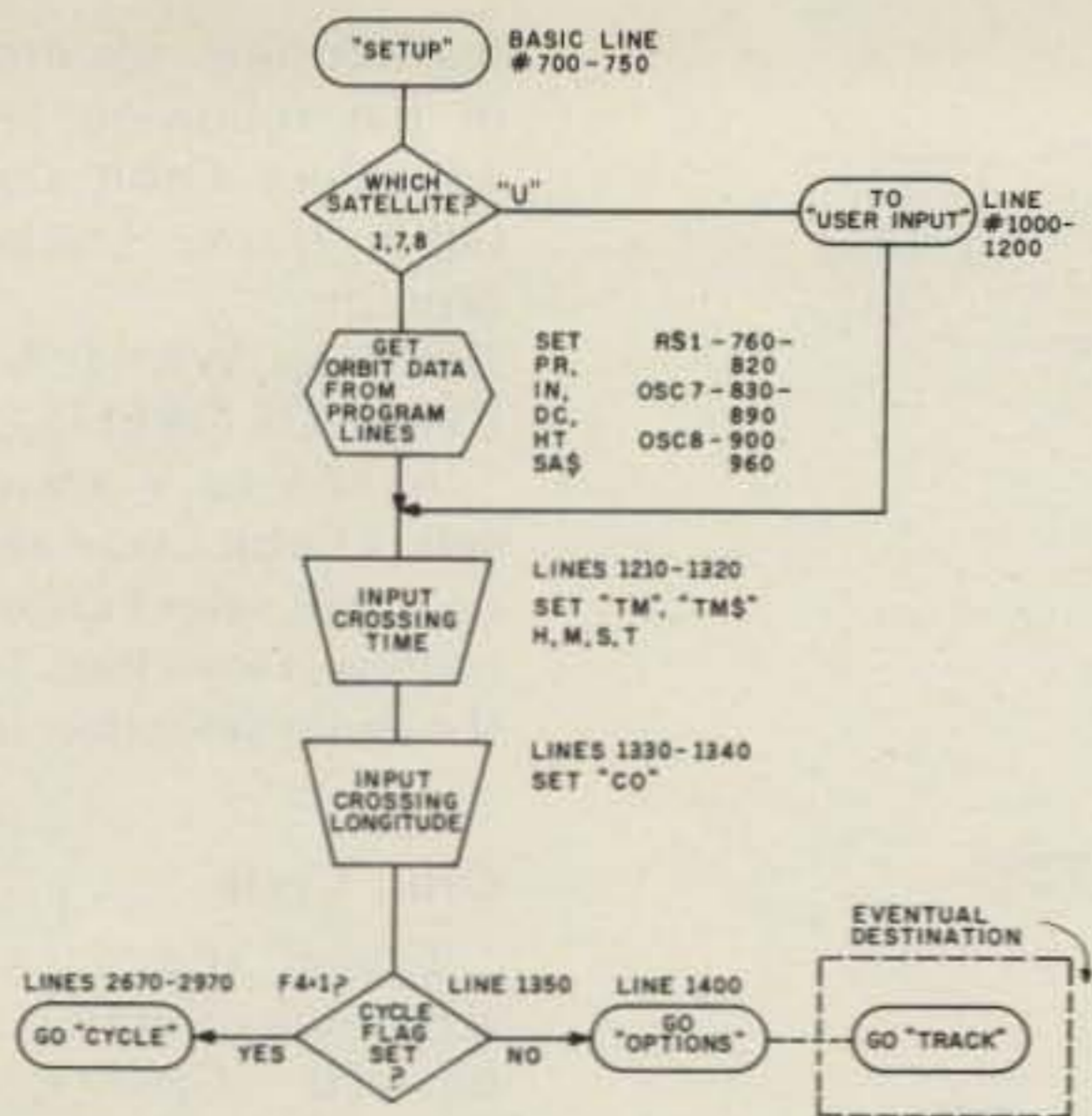

Flowchart 3. Setup logic.

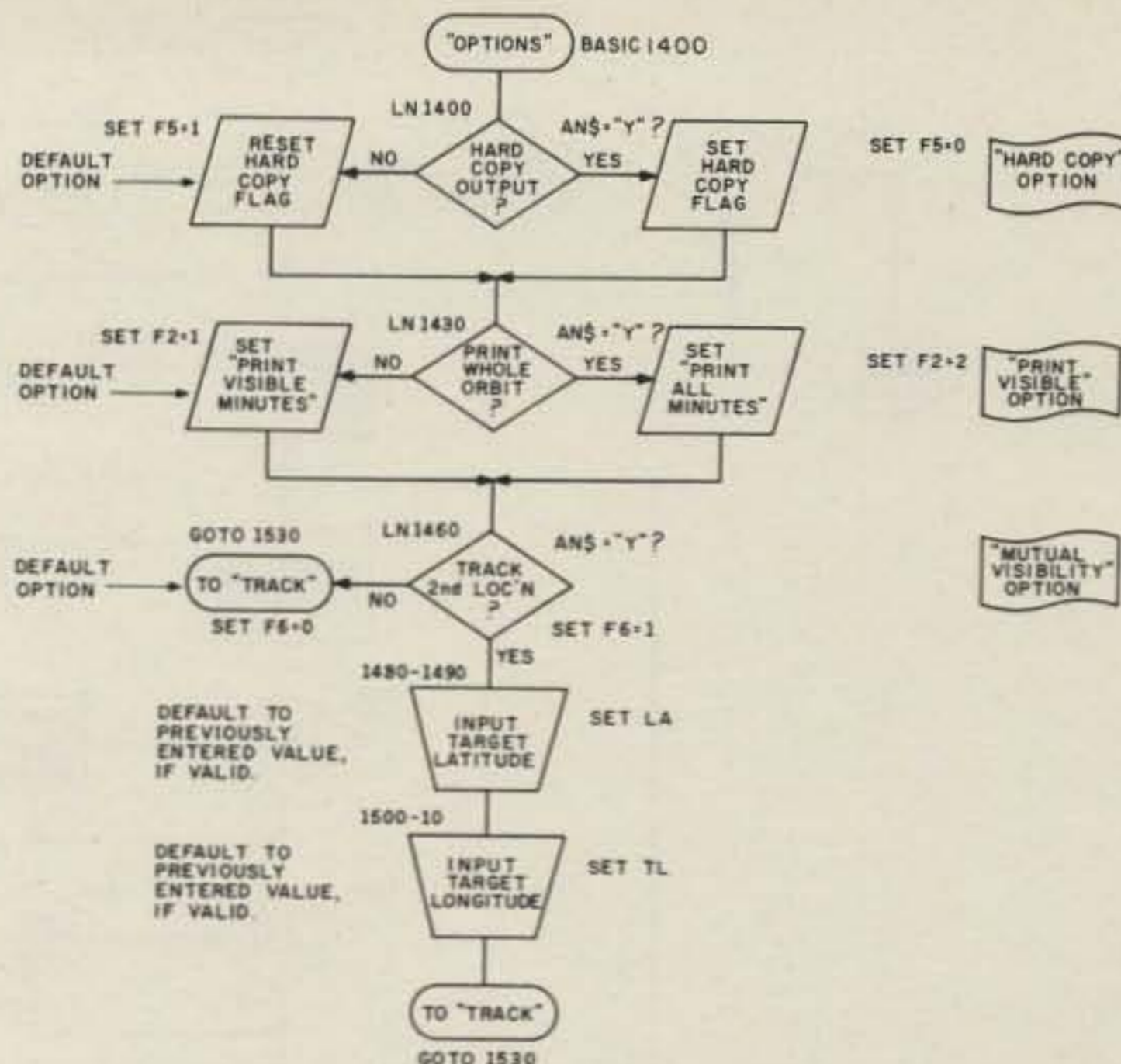

Flowchart 5. Options logic.

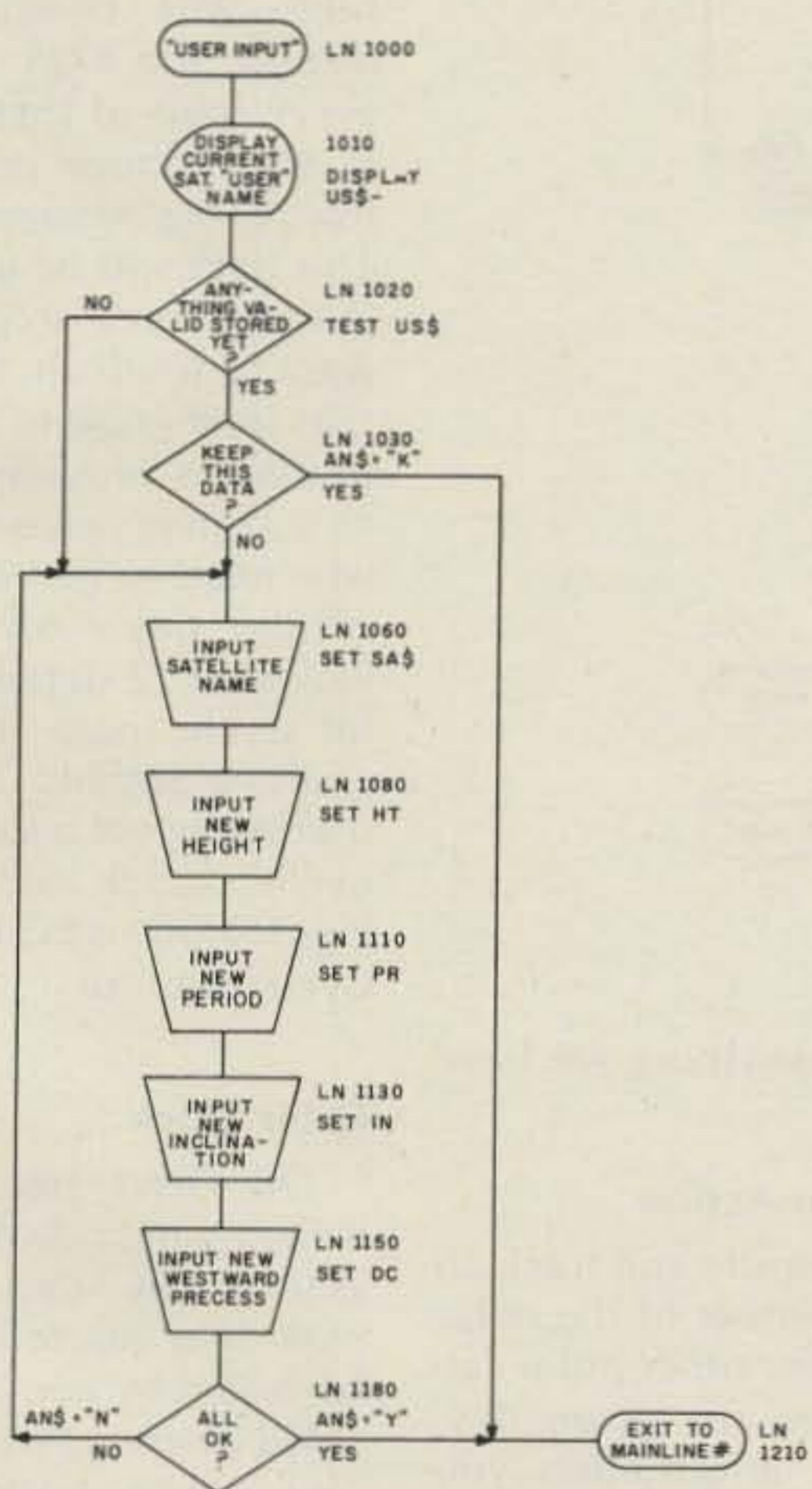

Flowchart 4. User Input Routine logic.

```

DO YOU WANT A DAY'S CYCLE OF ORBITS (Y/N)?      Y

FOR WHICH SATELLITE?
ENTER 1 FOR RS-1; 7 FOR OSCAR 7; 8 FOR OSCAR 8
ENTER 'U' TO ACCESS USER INPUT ROUTINE?      R

ORBITAL DATA FOR OSCAR 8 NOW AVAILABLE

FOR OSCAR 8, ENTER REFERENCE ORBIT'S:
TIME OF NORTHBOUND EQUATOR CROSSING 'EQX' (HHMM,SS)? 0035.15
LONGITUDE AT 'EQX' (DECIMAL DEGREES)?              64.5

*** SET OUTPUT OPTIONS ***
PRINT DATA ON LINE PRINTER (Y/N) 'ENTER'=NO ? Y
----- HARD COPY REQUEST CONFIRMED
PRINTER OFF-LINE..CANCEL HARD COPY (Y/N)?        N

HIT 'ENTER' WHEN PRINTER READY?
  
```

Fig. 1(a). Typical Orbit Cycle request for OSCAR 8, requesting printout.

DAY'S ORBITS FOR OSCAR 8		
REF#	TIME (UTC)	LONGITUDE AT 'EQX'
REF	00:35.15	64.5
1	02:18.28	90.3
2	04:01.41	116.1
3	05:44.54	141.9
4	07:28.07	167.7
5	09:11.21	193.5
6	10:54.34	219.3
7	12:37.47	245.2
8	14:21.0	271.0
9	16:04.13	296.8
10	17:47.27	322.6
11	19:30.40	348.4
12	21:13.53	14.2
13	22:57.06	40.0
14	00:40.19	65.8

Fig. 1(b). Printout resulting from request shown in Fig. 1(a).

tronics types. Automatic "sequential tracking" will allow you to track any number of orbits in a row from only one EQX or you may enter the specific orbits you wish to be tracked from the keyboard. Tracker has been extensively tested and should be completely crash-proof (but Murphy always can pay a surprise visit).

What You Need to Make It Work for You

Tracker will run on any Level II TRS-80 system, either cassette- or disk-based, having at least 16K of RAM. Hard copy is available for those of you who have a line printer, but you don't need one to run the program. Because of the length of the program (12K, more or less) and the use of

Level II's built-in trig functions, Level I systems or Level II systems with less than 16K are not suitable.

For you die-hards who insist on typing in everything, the program listing is reproduced here for your convenience, but the rest of you take heart. If you feel that 12K of Level II BASIC is a bit long to type in and debug (and we agree whole-

heartedly), cassette tapes are available.

Using Tracker with OSCAR

Using Tracker may look complicated at first glance, but it really isn't. Rather than enter into a detailed description of the program's execution right off, I'll just cover the major sections and how they function. Flowcharts will be

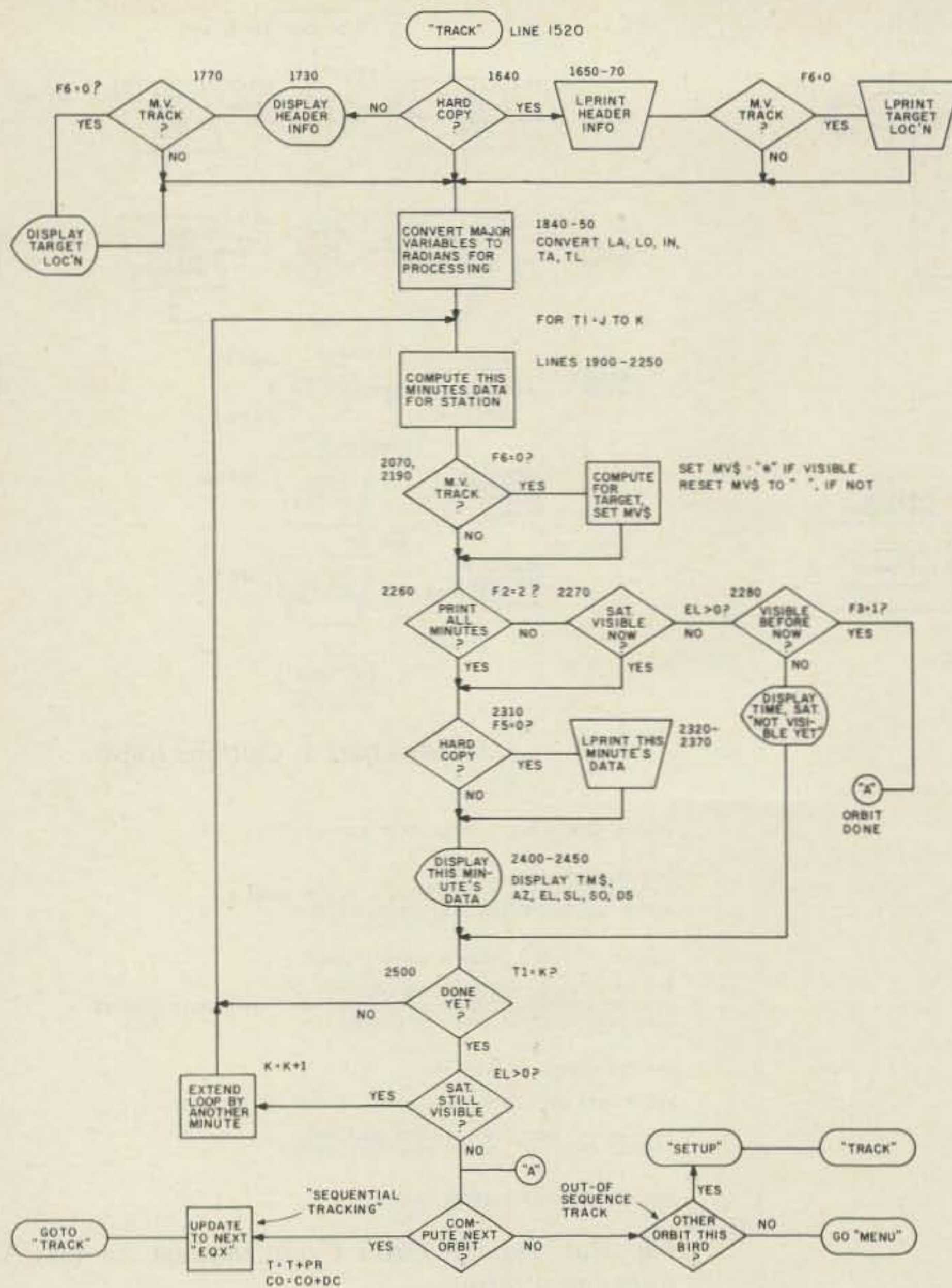

Flowchart 6. Orbit Track logic.

```

COMPUTE ANOTHER CYCLE FOR OSCAR 8 (Y/N) 'ENTER'=NO ? N
COMPUTE A CYCLE FOR A DIFFERENT SATELLITE (Y/N) 'ENTER'=NO ? N

WHICH SATELLITE TO TRACK?
ENTER 1 FOR RS-1; 7 FOR OSCAR 7; 8 FOR OSCAR 8
ENTER 'U' TO ACCESS USER INPUT ROUTINE? 8

ORBITAL DATA FOR OSCAR 8 NOW AVAILABLE
TO TRACK OSCAR 8 ENTER:
TIME OF NORTHBOUND EQUATOR CROSSING 'EQX' (HHMM.SS)? 0035.15
LONGITUDE AT 'EQX' (DECIMAL DEGREES)? 64.5

LATITUDE OF YOUR STATION (DECIMAL DEGREES)? 42.375
LONGITUDE OF YOUR STATION (DECIMAL DEGREES)? 83.75

*** SET OUTPUT OPTIONS ***
PRINT DATA ON LINE PRINTER (Y/N) 'ENTER'=NO ? N
----- 'NO HARD COPY' CONFIRMED
DO YOU WISH TO SEE THE WHOLE ORBIT (Y/N) 'ENTER'=NO ? N
----- 'PRINT VISIBLE MINUTES ONLY' CONFIRMED
TRACK FOR MUTUAL VISIBILITY (Y/N) 'ENTER'=NO ? N
----- 'NO M.V.TRACK'

```

Fig. 2. Typical Orbit Track run, tracking OSCAR 8 reference orbit from Fig. 1. Options requested are: NO HARD COPY, PRINT VISIBLE ONLY, NO M.V. TRACK.

used to assist you in understanding the logic of the program. A reference chart has been provided, listing the functions by line numbers for those of you who might want to modify it (although I really can't

think of anything we have left out).

Tracker in Action

To compute and track all orbits of either of the polar OSCARs (or other polar satellites) for any given day, the only information you will need is the time and longitude (EQX) of the reference orbit for that day. This data is available in most of the monthly amateur publications and also is available from AMSAT Orbit Calendars and in daily bulletin transmissions over W1AW.

To make things easier, the main logic has been divided into two sections: Orbit Cycle Compute and Orbit Track. The functions and differences of these

two routines are described in the following sections. To select Orbit Cycle or Orbit Track, Tracker will prompt:

DO YOU WANT A DAY'S CYCLE OF ORBITS (Y/N)?

A YES or Y answer will select Orbit Cycle and a NO or N will select Orbit Track routine. Flowchart 1 details the main selection logic.

Orbit Cycle

Given the EQX of a reference orbit (the first orbit after GMT midnight, generally), Orbit Cycle—which is *not* a moon bike—will compute and display the EQX data for every orbit of that satellite in the 24-hour period following the reference orbit. This data will be used later in Orbit Track, so you might want to jot down the orbits that look good to you. This routine is provided mostly as a convenience for those who need to generate a list of the day's orbit times. Flowchart 2 details the Orbit Cycle logic, and Flowchart 3 details the logic used to select a satellite for cycle or track, called Setup. Fig. 1 shows a typical Orbit Cycle printout.

Orbit Track

The Orbit Track routine is the main body of the program. Orbit Track will take EQX data entered from the keyboard by you (and probably computed by Orbit Cycle) along with orbital parameters for the satellite of interest and the location of your station and will compute and display, on a minute-by-minute basis, the visibility of the satellite. It also will produce azimuth and elevation headings from your station location, the latitude and longitude of the sub-satellite point (the point on the Earth's surface directly under the satellite), and the direct distance from you to the satellite, in kilometers.

Phew... Wanna try doing all that on your little four-banger and still get ready

for that 6:20 pm pass while the XYL is screaming "DINNER'S READY" and the kids

want to know when you can fix that broken bike? You get the picture!

Tracker will accept your own orbital parameters to facilitate tracking other polar orbiting satellites, like the NOAA weather birds. This is accomplished by the "User Input Routine" (see

SATELLITE TRACKING DATA FOR OSCAR 8
FOR LAT: 42.375 LONG: 83.75
ORBIT BEGINS 00:35.15 (UTC), AT LONG: 64.5

TIME(UTC)	AZ	EL	S-LAT	S-LONG	DIST.(KM)
00:40.15	148.7	0.7	17.2	68.8	3441.5
00:41.15	147.3	4.5	20.6	69.8	3054.9
00:42.15	145.4	8.8	24.0	70.7	2672.7
00:43.15	142.8	14.0	27.4	71.7	2299.0
00:44.15	139.0	20.4	30.9	72.7	1940.3
00:45.15	132.9	28.5	34.3	73.8	1608.9
00:46.15	122.1	38.8	37.7	75.0	1327.0
00:47.15	100.4	50.1	41.1	76.3	1133.6
00:48.15	62.6	54.6	44.5	77.6	1078.3
00:49.15	29.2	46.8	47.9	79.1	1181.0
00:50.15	11.8	35.4	51.2	80.8	1407.1
00:51.15	2.9	25.7	54.6	82.7	1707.6
00:52.15	357.7	18.2	57.9	84.9	2049.3
00:53.15	354.4	12.3	61.2	87.5	2413.7
00:54.15	352.2	7.4	64.4	90.6	2790.8
00:55.15	350.6	3.2	67.6	94.5	3174.8

Fig. 3. Printout that would result from options requested in Fig. 2, had hard copy been selected.

SATELLITE TRACKING DATA FOR OSCAR 8
FOR LAT: 42.375 LONG: 83.75
ORBIT BEGINS 00:35.15 (UTC), AT LONG: 64.5

TIME(UTC)	AZ	EL	S-LAT	S-LONG	DIST.(KM)
00:36.15	152.1	-11.4	3.4	65.4	4990.0
00:37.15	151.4	-8.7	6.9	66.2	4605.3
00:38.15	150.7	-5.8	10.3	67.1	4218.3
00:39.15	149.8	-2.7	13.7	67.9	3829.9
00:40.15	148.7	0.7	17.2	68.8	3441.5
00:41.15	147.3	4.5	20.6	69.8	3054.9
00:42.15	145.4	8.8	24.0	70.7	2672.7
00:43.15	142.8	14.0	27.4	71.7	2299.0
00:44.15	139.0	20.4	30.9	72.7	1940.3
00:45.15	132.9	28.5	34.3	73.8	1608.9
00:46.15	122.1	38.8	37.7	75.0	1327.0
00:47.15	100.4	50.1	41.1	76.3	1133.6
00:48.15	62.6	54.6	44.5	77.6	1078.3
00:49.15	29.2	46.8	47.9	79.1	1181.0
00:50.15	11.8	35.4	51.2	80.8	1407.1
00:51.15	2.9	25.7	54.6	82.7	1707.6
00:52.15	357.7	18.2	57.9	84.9	2049.3
00:53.15	354.4	12.3	61.2	87.5	2413.7
00:54.15	352.2	7.4	64.4	90.6	2790.8
00:55.15	350.6	3.2	67.6	94.5	3174.8
00:56.15	349.4	-0.4	70.6	99.5	3562.3
00:57.15	348.5	-3.7	73.5	106.1	3951.1
00:58.15	347.8	-6.7	76.1	115.2	4339.4
00:59.15	347.3	-9.5	78.3	127.8	4726.0
01:00.15	346.8	-12.2	79.7	144.8	5110.1
01:01.15	346.5	-14.7	80.1	164.0	5490.9
01:02.15	346.3	-17.2	79.3	184.2	5867.5
01:03.15	346.1	-19.5	77.5	199.5	6239.6
01:04.15	345.9	-21.8	75.1	210.6	6606.5
01:05.15	345.8	-24.1	72.4	218.6	6967.8
01:06.15	345.8	-26.3	69.4	224.5	7322.9
01:07.15	345.7	-28.4	66.3	229.0	7671.6
01:08.15	345.7	-30.5	63.1	232.6	8013.3
01:09.15	345.8	-32.6	59.9	235.5	8347.7
01:10.15	345.8	-34.7	56.6	237.9	8674.5
01:11.15	345.9	-36.7	53.3	240.0	8993.2
01:12.15	346.0	-38.8	49.9	241.8	9303.6
01:13.15	346.2	-40.8	46.6	243.4	9605.3
01:14.15	346.3	-42.8	43.2	244.8	9898.0
01:15.15	346.5	-44.8	39.8	246.1	10181.4
01:16.15	346.7	-46.7	36.4	247.4	10455.2
01:17.15	346.9	-48.7	33.0	248.5	10719.3
01:18.15	347.1	-50.6	29.5	249.6	10973.1
01:19.15	347.4	-52.6	26.1	250.6	11216.7
01:20.15	347.7	-54.5	22.7	251.6	11449.6
01:21.15	348.0	-56.4	19.3	252.5	11671.8
01:22.15	348.4	-58.4	15.8	253.4	11882.8
01:23.15	348.8	-60.3	12.4	254.3	12082.7
01:24.15	349.2	-62.2	9.0	255.2	12271.1
01:25.15	349.7	-64.1	5.5	256.0	12447.9
01:26.15	350.3	-66.0	2.1	256.9	12612.9

Fig. 4. Printout for same input as Fig. 2, but selecting PRINT ALL MINUTES.

SATELLITE TRACKING DATA FOR OSCAR 8
FOR LAT: 42.375 LONG: 83.75
ORBIT BEGINS 00:35.15 (UTC), AT LONG: 64.5
* = WINDOW OPEN TO LAT: 45.25 LONG: 110.375

TIME(UTC)	AZ	EL	S-LAT	S-LONG	DIST.(KM)
00:40.15	148.7	0.7	17.2	68.8	3441.5
00:41.15	147.3	4.5	20.6	69.8	3054.9
00:42.15	145.4	8.8	24.0	70.7	2672.7
00:43.15	142.8	14.0	27.4	71.7	2299.0
00:44.15	139.0	20.4	30.9	72.7	1940.3
00:45.15	132.9	28.5	34.3	73.8	1608.9
00:46.15*	122.1	38.8	37.7	75.0	1327.0
00:47.15*	100.4	50.1	41.1	76.3	1133.6
00:48.15*	62.6	54.6	44.5	77.6	1078.3
00:49.15*	29.2	46.8	47.9	79.1	1181.0
00:50.15*	11.8	35.4	51.2	80.8	1407.1
00:51.15*	2.9	25.7	54.6	82.7	1707.6
00:52.15*	357.7	18.2	57.9	84.9	2049.3
00:53.15*	354.4	12.3	61.2	87.5	2413.7
00:54.15*	352.2	7.4	64.4	90.6	2790.8
00:55.15*	350.6	3.2	67.6	94.5	3174.8

Fig. 5. Printout for same input as Fig. 2, but tracking for a second station located at Lat 42.25, Long 110.375. Asterisks next to TIME(UTC) mean cross-communication is possible during those minutes.

DO YOU WANT A DAY'S CYCLE OF ORBITS (Y/N)? Y
FOR WHICH SATELLITE?
ENTER 1 FOR RS-1; 7 FOR OSCAR 7; 8 FOR OSCAR 8
ENTER 'U' TO ACCESS USER INPUT ROUTINE? 7

ORBITAL DATA FOR OSCAR 7 NOW AVAILABLE

FOR OSCAR 7, ENTER REFERENCE ORBIT'S:
TIME OF NORTHBOUND EQUATOR CROSSING 'EQX' (HHMM.SS)? 2424.10

** INPUT ERROR **
FOR OSCAR 7, ENTER REFERENCE ORBIT'S:
TIME OF NORTHBOUND EQUATOR CROSSING 'EQX' (HHMM.SS)? 0024.65

** INPUT ERROR **
FOR OSCAR 7, ENTER REFERENCE ORBIT'S:
TIME OF NORTHBOUND EQUATOR CROSSING 'EQX' (HHMM.SS)? 0024.10
LONGITUDE AT 'EQX' (DECIMAL DEGREES)? 400

** INPUT ERROR **
LONGITUDE AT 'EQX' (DECIMAL DEGREES)? -24

** INPUT ERROR **
LONGITUDE AT 'EQX' (DECIMAL DEGREES)? 80

*** SET OUTPUT OPTIONS ***

PRINT DATA ON LINE PRINTER (Y/N) 'ENTER'=NO ? Y
----- HARD COPY REQUEST CONFIRMED
PRINTER OFF-LINE..CANCEL HARD COPY (Y/N)? N
HIT 'ENTER' WHEN PRINTER READY?

Fig. 6(a). Input run for Cycle showing error messages that alert user to incorrect entries.

LATITUDE OF YOUR STATION (DECIMAL DEGREES)? 400.25

** INPUT ERROR **
LATITUDE MUST BE BETWEEN -90 & 90 DEGREES

LATITUDE OF YOUR STATION (DECIMAL DEGREES)? 40.025

LONGITUDE OF YOUR STATION (DECIMAL DEGREES)? 830.75

** INPUT ERROR **
LONGITUDE MUST BE BETWEEN 0 & 360 DEGREES

LONGITUDE OF YOUR STATION (DECIMAL DEGREES)? 83.075

*** SET OUTPUT OPTIONS ***

PRINT DATA ON LINE PRINTER (Y/N) 'ENTER'=NO ? Y
----- HARD COPY REQUEST CONFIRMED
DO YOU WISH TO SEE THE WHOLE ORBIT (Y/N) 'ENTER'=NO ? N
----- 'PRINT VISIBLE MINUTES ONLY' CONFIRMED
TRACK FOR MUTUAL VISIBILITY (Y/N) 'ENTER'=NO ? N
----- 'NO M.V.TRACK'
PRINTER OFF-LINE..CANCEL HARD COPY (Y/N)? NO
HIT 'ENTER' WHEN PRINTER READY?

Fig. 6(b). Input run showing error messages for incorrect entry of station coordinates. Actual latitude cannot exceed 89.99 degrees, plus or minus, without causing program error. Longitude is required to be positive.

DO YOU WANT A DAY'S CYCLE OF ORBITS (Y/N)? N
WHICH SATELLITE TO TRACK?
ENTER 1 FOR RS-1; 7 FOR OSCAR 7; 8 FOR OSCAR 8
ENTER 'U' TO ACCESS USER INPUT ROUTINE? U

USER INPUT ROUTINE

DATA NOW ON FILE FOR: ** NO CURRENT ENTRY **
PLEASE ENTER THE FOLLOWING:
NAME OF THIS SATELLITE? SAMPLE1
HEIGHT OF SATELLITE (IN KM)? 20
THAT'S PRETTY LOW...BETTER DUCK!!
HEIGHT OF SATELLITE (IN KM)? 1400
PERIOD OF SATELLITE (IN DECIMAL MINUTES)? 20
INCLINATION OF ORBIT (IN DECIMAL DEGREES)? 99.9
WESTWARD PROGRESS OF ORBIT (IN DECIMAL DEGREES)? 370.25
THAT'S VERY LARGE...ARE YOU SURE??
WESTWARD PROGRESS OF ORBIT (IN DECIMAL DEGREES)? 37.025
IS THIS DATA ALL CORRECT? N

PLEASE ENTER THE FOLLOWING:
NAME OF THIS SATELLITE? SAMPLE1
HEIGHT OF SATELLITE (IN KM)? 1400
PERIOD OF SATELLITE (IN DECIMAL MINUTES)? 200.5
INCLINATION OF ORBIT (IN DECIMAL DEGREES)? 99.9
WESTWARD PROGRESS OF ORBIT (IN DECIMAL DEGREES)? 37.025
IS THIS DATA ALL CORRECT? Y

ORBITAL DATA FOR SAMPLE1 NOW AVAILABLE

TO TRACK SAMPLE1 ENTER:
TIME OF NORTHBOUND EQUATOR CROSSING 'EQX' (HHMM.SS)? 0010.0
LONGITUDE AT 'EQX' (DECIMAL DEGREES)? 80

Fig. 7. "User Input Routine" entries showing error inquiries and corrections double-check at end of run. Program then continues to Track or Cycle as selected.

Program listing.

```

100 REM *****
110 REM *****
120 REM ***** SATELLITE TRACKING PROGRAM *****
130 REM *****
140 REM ***** COPYRIGHT (C) 1979 BY: *****
150 REM ***** GNOME COMPUTERWORKS, FOR: *****
160 REM ***** DENNIS MITCHELL, KBR.....AND *****
170 REM ***** BRUCE NAZARIAN, WDBDRK.....AUTHORS *****
180 REM *****
190 REM ***** THIS PROGRAM WILL COMPUTE ORBITS AND *****
200 REM ***** ANTENNA AZ-EL CO-ORDINATES FOR THE *****
210 REM ***** USER'S LOCATION. DATA FOR OSCAR 7, *****
220 REM ***** OSCAR 8 AND RS-1 IS PRE-PROGRAMMED. *****
230 REM ***** DATA FOR OTHER SATELLITES MAY BE *****
240 REM ***** ENTERED BY THE USER FOR COMPUTING *****
250 REM ***** ORBITS FOR FUTURE LAUNCHED SPACECRAFT. *****
260 REM *****
270 REM ***** OPERATION IS EASY-- THIS PROGRAM IS *****
280 REM ***** VERY USER-ORIENTED AND WILL TALK YOU *****
290 REM ***** THROUGH MOST EVERY STEP NECESSARY FOR *****
300 REM ***** SUCCESSFUL COMPUTING.. *****
310 REM *****
320 REM ***** FOR FURTHER INFORMATION OR CLARIFICATION *****
330 REM ***** CONTACT: *****
340 REM ***** BRUCE NAZARIAN, WDBDRK *****
350 REM ***** GNOME COMPUTERWORKS *****
360 REM ***** P.O. BOX 8063 *****
370 REM ***** ANN ARBOR, MICH 48107 *****
380 REM ***** (313) 995-2398 *****
390 REM ***** 16K FREE MEMORY = 2124 <VERSION 4.1> *****
400 REM *****
410 REM *****
420 REM *****
430 REM ***** PRINT TITLE PAGE (WITH ANIMATION) *****
440 REM *****
450 CLS
452 SS="OPENCLOSE"
455 FOR I=0TO100:PRINT@RND(1916/2),"";NEXT
460 FOR I=1TO2:
  PRINT@400," ";FOR I=1TO200:NEXT I:
  PRINT@400," SATELLITE ";FOR I=1TO200:NEXT I:
  NEXT I
470 FOR I=1TO2:
  PRINT@550," ";FOR I=1TO200:NEXT I:
  PRINT@550," TRACKER ";FOR I=1TO200:NEXT I:
  NEXT I
480 PRINT@960,"AN OSCAR USER'S AID";:
  PRINT@992,"(C) 1979 GNOME COMPUTERWORKS";
490 J=846:
  FOR I=0TO13:C=J-(62*I)+1:PRINT@C,SS;:
  FOR I=0TO100:NEXT I:PRINT@C," ";NEXT I
492 REM J=846:FOR I=0TO12:C=J-(62*I)+1:PRINT@C,SS;:FOR I=0TO100:NEXT I:
  PRINT@C," ";NEXT I
500 FOR I=0TO100:NEXT I:CLS:PRINT@512,"";
510 INPUT"DO YOU NEED INSTRUCTIONS (Y/N)";ANS
515 IF LEFT$(ANS,1)<>"Y"THEN600
520 REM PRINT OUT INSTRUCTIONS
530 CLS:PRINT"
  THIS PROGRAM WILL ASSIST YOU IN TRACKING THE PATHS OF
  SATELLITES IN CIRCULAR OR NEAR-CIRCULAR ORBITS. OSCAR 7 & 8
  ARE EXAMPLES OF THIS TYPE OF SATELLITE, AND ARE THE PRIMARY
  FOCUS OF THIS PROGRAM.";
540 PRINT" HOWEVER, ANY SATELLITE IN A SUITABLE
  ORBIT WHOSE PARAMETERS ARE KNOWN MAY BE TRACKED BY INSERTING
  THOSE PARAMETERS INTO THE PROGRAM THROUGH THE 'USER INPUT'
  ROUTINE"
550 PRINT"
  TO ACTIVATE THIS 'USER INPUT' ROUTINE, TYPE 'U' IN
  RESPONSE TO THE SATELLITE MENU:

  'ENTER 1 FOR RS-1; 7 FOR OSCAR 7; 8 FOR OSCAR 8;
  ENTER 'U' FOR ACCESS TO USER INPUT ROUTINE.'"
560 PRINT@960,"(HIT 'ENTER' TO CONTINUE)";:INPUT AN$
570 CLS:PRINT"
  THE 'USER INPUT' ROUTINE WILL NOW PROMPT YOU FOR THE
  NAME OF YOUR SATELLITE, AND THE VARIOUS ORBIT PARAMETERS.
  WHEN ALL NECESSARY PARAMETERS HAVE BEEN INPUT, THE COMPUTER WILL THEN PROMPT
  FOR A REFERENCE ORBIT."
580 PRINT"
  THE PROGRAM WILL THEN OFFER THE STANDARD OPTIONS, AND
  WILL CYCLE THROUGH ITS FUNCTIONS.

  'TRACKER' WILL TALK YOU THROUGH ALL OF THE STEPS YOU
  NEED TO EXECUTE FOR ANY GIVEN TRACKING OR ORBIT COMPUTING."
590 PRINT@960,"";:INPUT"(HIT 'ENTER' WHEN READY TO BEGIN)";ANS
600 REM
610 REM BEGIN PROGRAM RUN HERE
620 CLEAR400
630 CLS:PI=3.14159265:P2=2*PI:PY=180:IS="#####.@";CR$=CHR$(13):
  US$="NO CURRENT ENTRY ***:RD=PI/PY:DG=PY/PI:HP=PI/2:
  PD$=STRING$(18,"");P9=.999999:N9=-.999999:P1=.000001:
  RA$=STRING$(18,"-")+>"
640 LA=-180:LO=-1:REM FORCE ERROR MESSAGE IF NO INPUT
650 CLS:PRINT@512,"";
660 INPUT"DO YOU WANT A DAY'S CYCLE OF ORBITS (Y/N)";ANS
670 IF LEFT$(ANS,1)="Y",F4=1:GOTO700
680 IF LEFT$(ANS,1)="N",F4=8 ELSE GOTO 660
690 REM
700 IF F4=1 PRINT"FOR WHICH SATELLITE?" ELSE
  CLS:PRINT"WHICH SATELLITE TO TRACK?"
710 PRINT"ENTER 1 FOR RS-1; 7 FOR OSCAR 7; 8 FOR OSCAR 8";CR$;:
  INPUT"ENTER 'U' TO ACCESS USER INPUT ROUTINE";ANS
720 IF AN$="1"THEN 760
730 IF AN$="7"THEN 830
740 IF AN$="8"THEN 900
750 IF AN$="U"THEN 980ELSE 700
760 REM ***** RS-1 DATA *****
770 PR=128.389433
780 DC=30.227
790 HT=1706
800 IN=82.5556
810 SAS="RS-1"
820 GOTO 1210
830 REM ***** OSCAR 7 DATA *****
840 PR=114.944836
850 DC=28.737620
860 HT=1460
870 IN=101.59660
880 SAS="OSCAR 7"
890 GOTO 1210
900 REM ***** OSCAR 8 DATA *****
910 PR=183.22726
920 DC=25.887932
930 HT=906
940 IN=99.9
950 SAS="OSCAR 8"
960 GOTO 1210
970 REM
980 REM ENTER HERE IF NOT USING AO-7, AO-8, RS-1
990 REM
1000 CLS:PRINTTAB(20)PD$;CR$;TAB(20)"USER INPUT ROUTINE";CR$;TAB(20)PD$;CR$;
1010 PRINT:PRINT"DATA NOW ON FILE FOR: ";US$
1020 IF LEFT$(US$,1)="" THEN PRINT"PLEASE ENTER THE FOLLOWING:";GOTO 1060
1030 INPUT"TYPE 'K' TO KEEP, 'N' TO ENTER NEW DATA";ANS
1040 IF AN$=""THEN 1030
1050 IF LEFT$(ANS,1)="K" THEN 1210
1060 INPUT"NAME OF THIS SATELLITE";US$
1070 IF US$=""THEN 1060
1080 INPUT"HEIGHT OF SATELLITE (IN KM)";HT
1090 IF HT<=0 THEN PRINT:GOTO 1080
1100 IF HT<200PRINT"THAT'S PRETTY LOW...BETTER DUCK!";GOTO 1080
1110 INPUT"PERIOD OF SATELLITE (IN DECIMAL MINUTES)";PR
1120 IF PR<=0 THEN PRINT:GOTO 1110
1130 INPUT"INCLINATION OF ORBIT (IN DECIMAL DEGREES)";IN
1140 IF IN<=0 THEN PRINT:GOTO 1130
1150 INPUT"WESTWARD PROGRESS OF ORBIT (IN DECIMAL DEGREES)";DC
1160 IF DC<=0 THEN PRINT:GOTO 1150
1170 IPDC>=360PRINT"THAT'S VERY LARGE..ARE YOU SURE?";GOTO 1150
1180 AN$=""INPUT"IS THIS DATA ALL CORRECT";ANS
1190 IF LEFT$(ANS,1)<>"Y" THEN US$=""PRINTCR$:GOTO 1020
1200 SAS=US$:CLS
1210 REM
  RESUME MAINLINE HERE
1220 TA=-91:TL=-1:REM SET TARGET ERROR VALUES
1230 PRINTCR$;"ORBITAL DATA FOR ";SAS;" NOW AVAILABLE";CR$
1240 IF F4=1 PRINT"FOR ";SAS;" ENTER REFERENCE ORBIT'S:" ELSE
  PRINT "TO TRACK ";SAS;" ENTER:"
1250 TM=-1:INPUT
  "TIME OF NORTHBOUND EQUATOR CROSSING 'EQX' (HHMM.SS)";TM
1260 IF TM>=2400 OR TM<0 THEN GOSUB3250:GOTO 1240
1270 IF TM-INT(TM)>=.60 THEN GOSUB3250:GOTO 1240
1280 H=FIX(TM/100): REM H=HOURS
1290 M=FIX(TM-H*100): REM M=MINUTES
1300 S=TM-FIX(TM): REM S=SECONDS
1310 T=H*60+M+(S/.6): REM CONVERT FROM HHMM.SS TO DECIMAL
1320 ST=T:REM SAVE START TIME FOR LATER USE
1330 CO=-1:INPUT"LONGITUDE AT 'EQX' (DECIMAL DEGREES)";CO
1340 IF CO>=360 OR CO<0 THEN GOSUB3250:GOTO 1330
1350 ON F4 GOTO 1400
1355 L4=-91
1360 PRINTCR$;"LATITUDE OF YOUR STATION (DECIMAL DEGREES)";:
  IF LA>=90 THEN PRINT"
  <HIT 'ENTER' TO RETAIN VALUE: ";LA;" >";
1365 INPUT L4:IF L4=-91 AND LA>=90 THEN L4=LA:GOTO 1375
1370 IF L4>=90 OR L4<=-90 GOSUB3250:PRINT
  "<LATITUDE MUST BE BETWEEN -90 & 90 DEGREES>";GOTO 1360
1375 LA=L4:L4=-1
1380 PRINTCR$;"LONGITUDE OF YOUR STATION (DECIMAL DEGREES)";:
  IF LO>=1 PRINT"
  <HIT 'ENTER' TO RETAIN VALUE: ";LO;" >";
1385 INPUT L4:IF L4=-1 AND LO>=1 THEN L4=LO:GOTO 1395
1390 IF L4>=360 OR L4<0 GOSUB3250:PRINT
  "<LONGITUDE MUST BE BETWEEN 0 & 360 DEGREES>";GOTO 1380
1395 LO=L4
1400 PRINT CR$;"*** SET OUTPUT OPTIONS ***";CR$:
  AN$=""INPUT"PRINT DATA ON LINE PRINTER (Y/N)
  <'ENTER'=NO> ";ANS:
  IF LEFT$(ANS,1)="Y" THEN F5=0 ELSE F5=1
1410 IF F5=0 PRINTCR$;"HARD COPY REQUEST CONFIRMED" ELSE PRINT
  RA$;"NO HARD COPY" CONFIRMED"
1420 ON F4 GOTO 1530
1430 AN$=""INPUT"DO YOU WISH TO SEE THE WHOLE ORBIT (Y/N)
  <'ENTER'=NO> ";ANS:
1440 IF LEFT$(ANS,1)="Y" THEN F2=2 ELSE F2=1
1450 IF F2=1 PRINTCR$;"PRINT VISIBLE MINUTES ONLY" CONFIRMED" ELSEPRINTCR$:
  "PRINT ALL MINUTES" CONFIRMED"
1460 AN$=""INPUT"TRACK FOR MUTUAL VISIBILITY (Y/N)
  <'ENTER'=NO> ";ANS:
1470 IF LEFT$(ANS,1)<>"Y",F6=1:PRINTCR$;"NO M.V.TRACK":
  GOTO 1530 ELSE F6=0

```

Flowchart 4). Once entered, these user orbit parameters will be retained during the program run until you change them. Fig. 2 shows a typical input run.

After you have selected your bird, Orbit Track will prompt for entry of the EQX data and for selection of the various options described below. (See Flowchart 5 for Options logic). After setting your option choices, the orbit track commences.

Orbit Tracking Options

In Orbit Track there are several options that may be set or reset for each orbit computed. Flowchart 6 shows Orbit Track logic. These include listing the computed data on the line printer (hard copy), suppressing the display of data for minutes when the satellite is not visible from your station location (PRINT VISIBLE MINUTES ONLY), and tracking the orbit for

simultaneous access from a second station location (M.V.TRACK). Each of these options has a default mode, which the computer will select if you respond with just an ENTER after the prompt for that option. All of the options may be set or reset before each orbit tracking operation, so you won't be stuck with a selection you don't want.

In the PRINT VISIBLE MINUTES ONLY mode, Tracker will print a single

line indicating the current time and (satellite name) NOT VISIBLE until the satellite comes into the range of your station location. It then will output all data normally. When it has computed that the satellite has dropped below your horizon, it will end the tracking routine for that orbit and ask if you wish to track the next orbit of the same satellite. This is the "Sequential Tracking" feature. Fig. 3 shows the abbreviated

```

1480 T4=-91:PRINT"TARGET LOCATION LATITUDE (DEC. DEGREES)":
IF TA>=91 PRINT
<HIT 'ENTER' TO KEEP VALUE:";TA;" >";
1485 INPUT T4:IF T4=-91 AND TA>=98 THEN T4=TA:GOTO 1500
1490 IF T4>=98 OR T4<=-98 THEN 1488ELSE TA=T4
1500 T4=-1:PRINT"TARGET LOCATION LONGITUDE (DEC. DEGREES)":
IF TL>=1 PRINT
<HIT 'ENTER' TO KEEP VALUE:";TL;" >";
1505 INPUT T4:IF T4=-1 AND TL>=1 THEN T4=TL:GOTO 7520
1510 IF T4>=360 OR T4<0 THEN 1500 ELSE TL=T4
1520 REM
INPUT CONTINUES HERE

1530 FORJ=0TO500:NEXT:CLS
1540 J=1:IF LA>=0 THEN K=FIX(PR/2) ELSE K=FIX(PR):
REM SET LOOP POINTERS
1550 ON P5 GOTO 1610
1560 ANS="":IF PEEK(14312)<128 THEN1600ELSEINPUT"PRINTER OFF-LINE..CANCEL
HARD COPY (Y/N)":ANS
1570 IF LEFT$(ANS,1)="Y",P5=1:GOTO1600
1580 IF LEFT$(ANS,1)="N",P5=0:GOTO1600
1590 GOTO1560
1600 IF P5=0,INPUT"HIT 'ENTER' WHEN PRINTER READY":ANS
1610 L2=LA:O2=LO:I2=IN:L3=TA:O3=TL
1620 ON P4 GOTO 2670:REM PRINT DAY'S ORBITS
1630 GOSUB3020
1640 ON P5 GOTO 1700
1650 LPRINTTAB(10)"SATELLITE TRACKING DATA FOR ";SAS
1660 LPRINTTAB(10)"FOR LAT:";LA;"LONG:";LO
1670 LPRINTTAB(10)"ORBIT BEGINS ";TMS;" (UTC), AT LONG:";
LPRINTUSING"###.#";CO
1680 IF P6=0,LPRINTTAB(10)"* = WINDOW OPEN TO LAT:";TA;" LONG:";TL
1690 LPRINT" ";LPRINT"TIME(UTC)";TAB(16)"AZ";TAB(26)"EL";TAB(35) "S-LAT";
TAB(44)"S-LONG";TAB(54)"DIST.(KM)";CRS
1700 REM
PRINT THE HEADER

1710 REM
1720 CLS
1730 PRINTTAB(10)"SATELLITE TRACKING DATA FOR ";SAS
1740 PRINTTAB(10)"FOR LAT:";LA;"LONG:";LO
1745 PRINT" LONG:";LO
1750 PRINTTAB(10)"ORBIT BEGINS ";TMS;" (UTC), LONG:";
1760 LPRINTUSING"###.#";CO
1770 ON P5 GOTO 1790
1780 PRINTTAB(10)"* = WINDOW OPEN TO LAT:";TA;" LONG:";TL
1790 PRINTTAB(10)"<USE 'CLEAR' KEY TO ABORT LISTING>";
GOSUB3240:REM PRINT HEADER LINE
1800 IF P2=1 THEN PRINT "THIS WILL TAKE A SECOND...HANG ON";CHR$(29);
1810 REM
1820 REM CONVERT TO RADIANS
1830 'IFLA>=90THEN LA=89.99ELSE LA=LA:IF LA>=-90 THEN LA=-89.99ELSE LA=LA
1840 LA=LA*PI/180:LO=LO*PI/180:IN=IN*PI/180
1850 TA=TA*PI/180:TL=TL*PI/180
1860 R=6378.1*(1-(.00335*(SIN(LA))^2)):REM
1870 F=R*HT:F3=0:LC=0
1880 T=T+(J-1)
1890 : FOR TI=J TO K
1900 REM SOLVE FOR SAT. LATITUDE
1910 X=SIN(P2*TI/PR)*SIN(IN):REM
1920 IF X>=1 THEN X=P9
1930 IF X<=-1 THEN X=N9
1940 IF X=0 THEN X=P1
1950 SL=ATN(X/SQR(-X*X+1)):REM ARCSIN (X)
1960 REM SOLVE FOR SAT. LONGITUDE
1970 Y=COS(P2*TI/PR)/COS(SL):REM
1980 IF Y>=1 THEN Y=P9
1990 IF Y<=-1 THEN Y=N9
2000 SO=-ATN(Y/SQR(-Y*Y+1))+HP:REM ARCCOS (Y)
2010 SO=SO+(TI/4)*RD+(CO*RD):REM
2020 IF SO>P2 THEN SO=SO-P2
2030 REM - SOLVE FOR ANGLE BETWEEN SAT,CNTR OF EARTH,OBSERVER;
2040 Z=(SIN(LA)*SIN(SL))+COS(LA)*COS(SL)*COS(SO-LO):REM
2050 IF Z>=1,Z=P9 ELSE IF Z<=-1,Z=N9
2060 OO=-ATN(Z/SQR(-Z*Z+1))+HP:REM ARCCOS (Z)
2070 ON P6 GOTO2110:REM MUTUAL VIS FLAG =0 FOR CALC, 1 FOR NO.
2080 IT=(SIN(TA)*SIN(SL))+COS(TA)*COS(SL)*COS(SO-TL):REM
2090 IF IT>=1,IT=P9 ELSE IF IT<=-1,IT=N9
2100 OT=-ATN(IT/SQR(-IT*IT+1))+HP:REM ARCCOS (IT)
2110 REM SOLVE FOR AZIMUTH TO SATELLITE
2120 W=(SIN(SL)-SIN(LA)*COS(OO))/(SIN(OO)*COS(LA)):REM
2130 IF W>=1,W=P9 ELSE IF W<=-1,W=N9
2140 AZ=-ATN(W/SQR(-W*W+1))+HP:REM ARCCOS (W)
2150 XX=SIN(SO-LO):IF XX>=0 THEN AZ=P2-AZ
2160 REM SOLVE FOR ELEVATION TO SATELLITE
2170 EL=ATN((COS(OO)-(R/F))/SIN(OO)):REM
2180 IF EL>0 THEN P3=1
2190 ON P6 GOTO 2220
2200 ET=ATN((COS(OT)-(R/F))/SIN(OT)):REM
2210 IF P3=1 AND ET>0 THEN MV$="**" ELSE MV$="*"
2220 REM SOLVE FOR DISTANCE TO SATELLITE
2230 DS=SQR((F*F)+(R*R)-2*F*(R*COS(OO))):REM
2240 T=T+1:GOSUB3020
2250 IF INKEYS=CHR$(31) PRINT CRS;"**" ORBIT TRACK ABORTED ****;CRS:LA=L2:LO=O2:
IN=I2:TA=L3:TL=O3:GOTO1240:REM RESTORE VALUES
2260 ON F2 GOTO 2270,2310
2270 IF EL<0 AND P3=0 THEN PRINTTMS;TAB(14)SAS;" NOT WITHIN RANGE";
CHR$(29);:GOTO 2500
2280 IF EL<0 AND P3=1 THEN IF LA>=0 THEN 2530
2290 IF EL<0 AND P3=1 AND LA<0 THEN P3=0:GOTO 2260
2300 REM
2310 ON F5 GOTO 2380
2320 LPRINTTMS;MV$:
2330 LPRINTTAB(12)USINGIS;AZ*DG;
2340 LPRINTTAB(22)USINGIS;EL*DG;
2350 LPRINTTAB(33)USINGIS;SL*DG;
2360 LPRINTTAB(43)USINGIS;SO*DG;
2370 LPRINTTAB(54)USINGIS;DS
2380 REM
2390 REM
2400 PRINT TMS;MV$:
2410 PRINTTAB(12)USING IS;AZ*DG;
2420 PRINTTAB(22)USING IS;EL*DG;
2430 PRINTTAB(33)USING IS;SL*DG;
2440 PRINTTAB(43)USING IS;SO*DG;
2450 PRINTTAB(54)USING IS;DS
2460 IF P5=0 THEN 2500
2470 LC=LC+1:IF LC>=12 THEN LC=0: GOSUB 3240
2480 REM
2490 REM
2500 : NEXT TI
2510 IPEL>=0,J=TI:K=TI+1:PORTI=JTOK:GOTO1910
2520 IF EL<0 AND F3=0,PRINT CRS;SAS;" NOT VISIBLE THIS ORBIT"
:IF P5=0 LPRINT SAS;" NOT VISIBLE THIS ORBIT"
2530 LA=L2:LO=O2:IN=I2:TA=L3:TL=O3
2540 PRINT"COMPUTE NEXT ORBIT OF ";SAS;
2550 ANS="":INPUT ANS:IF LEFT$(ANS,1) <> "Y" THEN 2630
2560 REM
2570 REM ADD PR TO TIME FOR NEXT ORBIT TIME
2580 REM
2590 T=INT((ST+PR)*100)/100:IF T>=1440,T=T-1440
2600 CO=CO+DC:ST=T
2610 IF CO>360 THEN CO=CO-360
2620 GOTO 1400
2630 ANS="":PRINT"ANOTHER ORBIT FOR ";SAS;:INPUTANS
2640 IF LEFT$(ANS,1)="Y" THEN CLS:GOTO 1230
2650 GOTO 650:REM RESTART MAINLINE, SAVE LA,LO
2660 REM
2670 REM ROUTINE TO PRINT DAY'S ORBITS
2680 REM
2690 CLS:ON P5 GOTO 2720
2700 LPRINTTAB(10)"DAY'S ORBITS FOR ";SAS;CRS
2710 LPRINT"REP+";TAB(14)"TIME (UTC)";TAB(30)
"LONGITUDE AT 'EQX'";CRS
2720 PRINTTAB(10)"DAY'S ORBITS FOR ";SAS
2730 PRINT"REP+";TAB(14);"TIME(UTC)";
2740 PRINT TAB(30);"LONGITUDE AT EQX"
2750 K=INT(1440/PR+.5)
2760 GOSUB 3020
2770 ON P5 GOTO 2790
2780 LPRINT"REP";TAB(14);TMS;TAB(35);CO
2790 PRINT"REP";TAB(14);TMS;TAB(35);CO
2800 FOR TI=1 TO K
2810 T=INT((T+PR)*100)/100
2820 IF T>=1440 THEN T=T-1440
2830 REM 8150 CORRECTS FOR 24HR WRAP-AROUND (24HRS=1440 MINS)
2840 GOSUB 3020
2850 CO=CO+DC
2860 IF CO>360 THEN CO=CO-360
2870 ON F5 GOTO 2890
2880 LPRINTTI;TAB(14);TMS;TAB(35);:LPRINTUSING"###.#";CO
2890 PRINT TI;TAB(14);TMS;TAB(35);:LPRINTUSING"###.#";CO;
2900 IF TI<K THEN PRINT
2910 NEXT TI
2920 PRINT#244,"HIT";:PRINT#372,"ENTER";:PRINT#500,"WHEN";:
PRINT#628,"READY";:INPUT ANS
2930 CLS
2940 PRINT"COMPUTE ANOTHER CYCLE FOR ";SAS;" (Y/N)
<'ENTER'=NO) ";:INPUTANS
2950 IF LEFT$(ANS,1)="Y"THEN 1240
2960 ANS="":INPUT
"COMPUTE A CYCLE FOR A DIFFERENT SATELLITE (Y/N)
<'ENTER'=NO) ";ANS
2970 IF LEFT$(ANS,1)="Y"THEN 700 ELSE P4=0:GOTO700
2980 REM
2990 REM
3000 REM SUBROUTINE TO CONVERT TIME TO STRINGS
3010 REM
3020 H=INT(T/60)
3030 M=INT(T-H*60)
3040 S=T-INT(T)
3050 S=INT(S*100+.5)/100 * .6
3060 S=INT(S*100)/100
3070 IF S>=.60 THEN M=M+1:S=0
3080 IF M>=60 THEN H=H+1:M=0
3090 IF H>=24 THEN H=0
3100 HS=STR$(H)
3110 MS=STR$(M)
3120 SS=STR$(S):IF LEN(SS)<4,SS=SS+"0"
3130 IF H=0 THEN HS="00"
3140 IF M<10 THEN MS="0"+RIGHT$(MS,1)
3150 IF H>=10 THEN MS=RIGHT$(MS,2)
3160 IF M=0 THEN MS="00"
3170 IF M<10 THEN MS="0"+RIGHT$(MS,1)
3180 IF M>=10 THEN MS=RIGHT$(MS,2)
3190 SS=MID$(SS,3,2)
3200 TMS=HS+":"+MS+":"+SS
3210 RETURN
3240 PRINT:PRINT"TIME(UTC)";TAB(16)"AZ";TAB(26)"EL";TAB(35)"S-LAT";
TAB(44)"S-LONG";TAB(54)"DIST.(KM)";RETURN
3250 PRINTCRS;"** INPUT ERROR **":RETURN

```

nature of PRINT VISIBLE, contrasted against Fig. 4 showing the same orbit printed with the PRINT ALL MINUTES option.

Selecting the PRINT ALL MINUTES option will force Tracker to print data for the entire duration of the orbit selected without regard to the visibility of the satellite. With either option, if the program cannot find any time during the orbit when the satellite is within range, it will indicate that the

satellite is NOT VISIBLE THIS ORBIT.

The HARD COPY option is pretty self-explanatory, but a word or two about its operation will help. The TRS-80's Line Printer routine will lock out your BASIC program if you issue an LPRINT command without a printer hooked up. To prevent this from happening and to support some of the after-market printer adapters (like the TRS-232 that I used here with my

Anderson-Jacobson 841 Se-lectronic to type this article), Tracker samples the Printer Port for a READY signal. If it senses that the printer is off-line or that there isn't one there (the two conditions look identical to the computer), it will prompt:
 PRINTER OFF-LINE ..
 CANCEL HARD COPY (Y/N)?—

Answering YES will reset the HARD COPY flag and cancel all further attempts

to LPRINT. Answering NO will keep the HARD COPY flag set and will attempt to LPRINT the data requested. If you have a Centronics-type printer that uses the Expansion Interface printer port, this message will remind you to turn it on and get it ready. If you have the TRS-232 or a similar adapter that uses BASIC's Printer Device Control Block as a link to its machine language driver, this little option is not

Table 1. Symbol table for Satellite Tracker.

ANS	General-purpose input string. Contains keyboard input in response to prompts.
AZ	Antenna azimuth calculated each minute, in radians.
CO	Crossing longitude . . . from EQX input.
DC	Westward precess of orbit . . . used to update CO for "Sequential Tracking" function.
DG	Conversion constant (radians * DG = Degrees).
DS	Distance to satellite, calculated each minute, in km.
EL	Antenna elevation calculated each minute, in radians.
ET	Elevation seen from "Target." Used with "M. V. Track."
F2	PRINT LENGTH FLAG = 1 means PRINT VISIBLE MINUTES. = 2 means PRINT ALL MINUTES.
F3	VISIBLE FLAG = 1 means bird visible once this orbit. = 0 means bird not visible this orbit.
F4	CYCLE FLAG = 1 means ORBIT CYCLE only. = 0 means TRACK.
F5	HARD COPY FLAG = 1 means NO HARD COPY. = 0 means HARD COPY REQUESTED.
F6	M. V. TRACK FLAG = 1 means NO M. V. TRACKING. = 0 means TRACK.
H,HS	Used in time conversion routine. Time is computed in decimal, then converted to strings for printing. H = Hours. M = Minutes. S = Seconds, TMS = Composite.
M,MS	
S,SS,	
TMS,T,	
ST	
HT	Height of satellite's orbit, in km.
IN	Inclination of satellite's orbit.
PR	Period of orbit.
LA	Your station latitude in decimal degrees.
LO	Your station longitude in decimal degrees.
SL	Latitude of sub-satellite point.
SO	Longitude of sub-satellite point.
TA	Target station latitude for "M. V. Tracking."
TL	Target station longitude for "M. V. Tracking."
OO	Angle, Theta, between satellite, center of the Earth, and you. Used to determine position of bird.
RD	Conversion constant (degrees * RD = radians).
SAS	Name of satellite being tracked.
USS	Name of "User" satellite that has been input.
W,X,Y,	Are either intermediate calculations to derive one of the above, or are system variables which do not change value.
Z,ZT,P,	
HP,P2	

mal sequence and offer you the options selection for that orbit. A NO answer will bring the prompt:

ANOTHER ORBIT FOR (satellite name)?

A YES answer will retain the satellite selected but will allow you to input another EQX and track it. Use this when you wish to skip certain orbits that are of no interest to you (like when it is 5:00 am and the satellite is passing over southern Borneo, or some other exotic port-of-call). A NO answer returns you to the main menu. To fully appreciate the versatility of the options, note that Figs. 3, 4, and 5 are tracks of the same orbit, but printed with different options.

Some Niceties

During development of this program it became apparent that some tricky timing problems can occur for stations located close to the equator. These stations may experience a "wrap-over" of a visible pass from the southern to northern hemisphere, or vice versa. To eliminate this, Tracker monitors the status of any Orbit Track listing and if the satellite is still visible as it crosses the equator, Tracker will extend its computations across the equator until it loses visibility for that pass.

Slippery-Finger-Proof, Too

Tracker also monitors the values for all user entries from the keyboard and will print error messages as appropriate. You will not be allowed to make mistakes by entering a value that is too large or too small for the desired function, and you may even find Tracker questioning your input to the User routine if the parameters don't make sense. Believe me, after playing with some programs where there is no provision for error correcting, sometimes making the en-

necessary. If you don't have a printer, this little warning may save you some grief. Remember, if you do force the issue, and don't have a printer or other adapter, BASIC will lock you out of the program for good (or at least until you RESET).

Two Tracks for the Price of One

The MUTUAL VISIBILITY TRACK option is a feature that was not in the original KIM program. If you answer YES to this option, you will be prompted to input the latitude and longitude of a "Target" location. You can use this option for things like tracking a pass to see if that G3 station can hear OSCAR 8

when you can, or even to see if your buddy in North Dakota can access the same orbits as you. You will find it convenient and easy to use, and it will make working satellite DX a lot less chancy and a lot more fun. To indicate that this option is operational, the header printout will now include:

* = WINDOW OPEN TO (LAT), (LONG)

The program printout will be modified to print an asterisk (*) next to the time column for each minute when both stations have access to that satellite. See Fig. 5 for a sample printout. Tracker will retain the location of your target station and will allow you to up-

date it or keep it the same each time you select the M.V. TRACK option. This makes it a snap to track more than one orbit for the same target.

Additional Features

Another slick feature of Tracker is sequential tracking. To eliminate repetitive data entry (and the inevitable sore fingertips), the Orbit Track routine is programmed to compute the EQX for the next orbit in normal sequence. After tracking any orbit, the computer will prompt: COMPUTE NEXT ORBIT OF (satellite name)?

A YES answer will tell Tracker to update the EQX data to the next orbit in nor-

tire output useless, using Tracker is a pleasure. Fig. 6 shows typical input error messages, and Fig. 7 shows User Input Routine error messages.

Input/Output Conventions

It should be understood that in OSCAR tracking, longitude is expressed as West only, from 0 to 360 degrees. Latitude is expressed as either +1 to +90 or -1 to -90 for North or South, respectively. Tracker printouts follow these conventions. All longitudes displayed are West. To find the correct East longitude for numbers exceeding 180 degrees, subtract 360 from the indicated West longitude. All latitudes are displayed as *positive* numbers for North and *negative* numbers for South. Your input to Tracker should follow this convention too, or you may get some very strange results.

Tracker will compute orbits for stations in either hemisphere as long as the above standards are followed in inputting station and target locations, etc. Tracks computed for southern hemisphere stations may take a while before they show output since Tracker uses a complex iterative method to compute the data for each minute of the orbit and cannot fast-forward these calculations. Since it begins each orbit calculation at the northbound equator crossing, it must compute between 40-50 minutes worth of data before it "wraps over" into the southern hemisphere. Be patient. It's still faster than a hand calculator. Just remember that the EQX data should be entered for a northbound equator crossing regardless of the hemisphere in which your station is located.

So How Does It Work?

For you programmers out there, Table 1 is a symbol table of the variables used and their significance to the program. Each of the flowcharts shows the BASIC line numbers of the program sections on that chart and where the jumps go. In addition, operations that change variables will have those variable names shown next to them, indicating changes. You should be able to use these aids to follow the program just about anywhere in its execution. If all else fails, use the TRON function of Level II BASIC to show you the line numbers as you are executing Tracker.

Some Final Notes

Dennis and I hope that you enjoy using Tracker on your TRS-80 system. The program is written in Microsoft's Level II BASIC and can be translated into

other BASICs that have the trig functions with only minor syntax changes. Versions are available for the PET (yes, it will run on the 8K version) and APPLE (16K with APPLESOFT). And the updated KIM-1 version will also be available. As interest arises, we will translate Tracker into versions suitable for other micros as well.

As indicated before, cassettes for the TRS-80 (and for the PET as well) are available from GNOME Computerworks, at the address listed under our names. The price is \$10.00, postpaid, and includes a user's guide that should answer any questions this article may have left unanswered. (We have other ham software goodies available, too. Please inquire.) For now, 73 from us both, and see you on OSCAR. ■

Dear Subscriber:

73 Magazine does not keep its subscription records on the premises; therefore, calling the Peterborough office doesn't solve your subscription problem.

To quickly solve your problem, please send your most recent address label and a description of the problem to:

73 Magazine
Subscription Department
PO Box 931
Farmingdale, NY 11737

Please allow the subscription department at least two weeks for an answer or a solution to your problem.

Thank you and enjoy your subscription.

Sincerely,

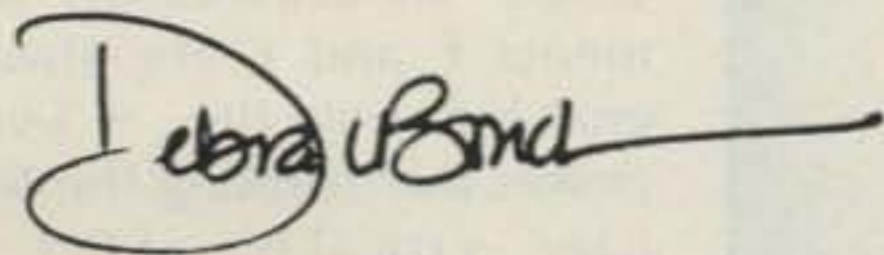

Debra L. Boudrieau
Circulation Manager



Let us know 8 weeks in advance so that you won't miss a single issue of 73 Magazine.

Attach old label where indicated and print new address in space provided. Also include your mailing label whenever you write concerning your subscription. It helps us to serve you promptly. Write to:

73 Magazine Subscription Dept.
P.O. Box 931, Farmingdale NY 11737

- | | |
|---|---|
| <input type="checkbox"/> Address change only | <input type="checkbox"/> 1 year \$25.00 |
| <input type="checkbox"/> Extend subscription | <input type="checkbox"/> Payment enclosed |
| <input type="checkbox"/> Enter new subscription | <input type="checkbox"/> Bill me later |

If you have no label handy, print OLD address here.

Name _____ Call _____

Address _____

City _____ State _____ Zip _____

print NEW address here:

Name _____ Call _____

Address _____

City _____ State _____ Zip _____

You Still Haven't Built a Logic Probe?

— try this one

Many people who get involved in home computer systems or any other form of digital electronics at one time or another run into hardware problems. If you want to fix them yourself, you need some way to look at what's going on inside the logic.

Usually, if you want to see logic levels, you might use a simple logic probe or a high-impedance FET (Field-Effect Transistor) volt

ohmmeter (VOM). If you want to see a timing relationship, you need a triggered sweep oscilloscope to see the actual timing relationship of two different pulses or signals.

Not every home computerist can afford to buy a good scope just to look at a logic signal once in awhile, so here is a unique logic probe which can see timing relationships as well as perform the usual functions of

a logic probe. It's inexpensive, with provisions for both positive and negative sync input. It can almost replace an oscilloscope in many digital applications. If you don't have an oscilloscope and can't afford one, then this logic probe is a useful substitute.

At work and at home I use my Synchronized Logic Probe to identify most logic problems easier and faster than with a scope. Many

times it's too much trouble to pull out the scope, so I use this probe instead. My probe also has features missing in an oscilloscope. Did you ever try to see an 18-ns pulse on a scope when it only happens about once every 5 or 10 seconds? With a scope, such a pulse is invisible, but using a probe which stretches the pulse enables it to be seen.

This logic probe will display a P for approximately 0.75 seconds every time a pulse occurs. It also displays standard logic levels like L for a low (false), H for a high (true), and an F for a float (open). Not only that, you can synchronize it to one signal and see if another signal happens at the leading or trailing edge of the sync input. One of the nicest points about this logic probe is that you can build it for about seven dollars.

How does this work? See the schematic, Fig. 1, and the timing diagram, Fig. 2. Under all conditions, segments E and F are always enabled via the +5-volt power bus forming the left-hand vertical bar of P, L, H, or F. The first condition discussed will be the static or no-signal condition.

At this time, the probe tip

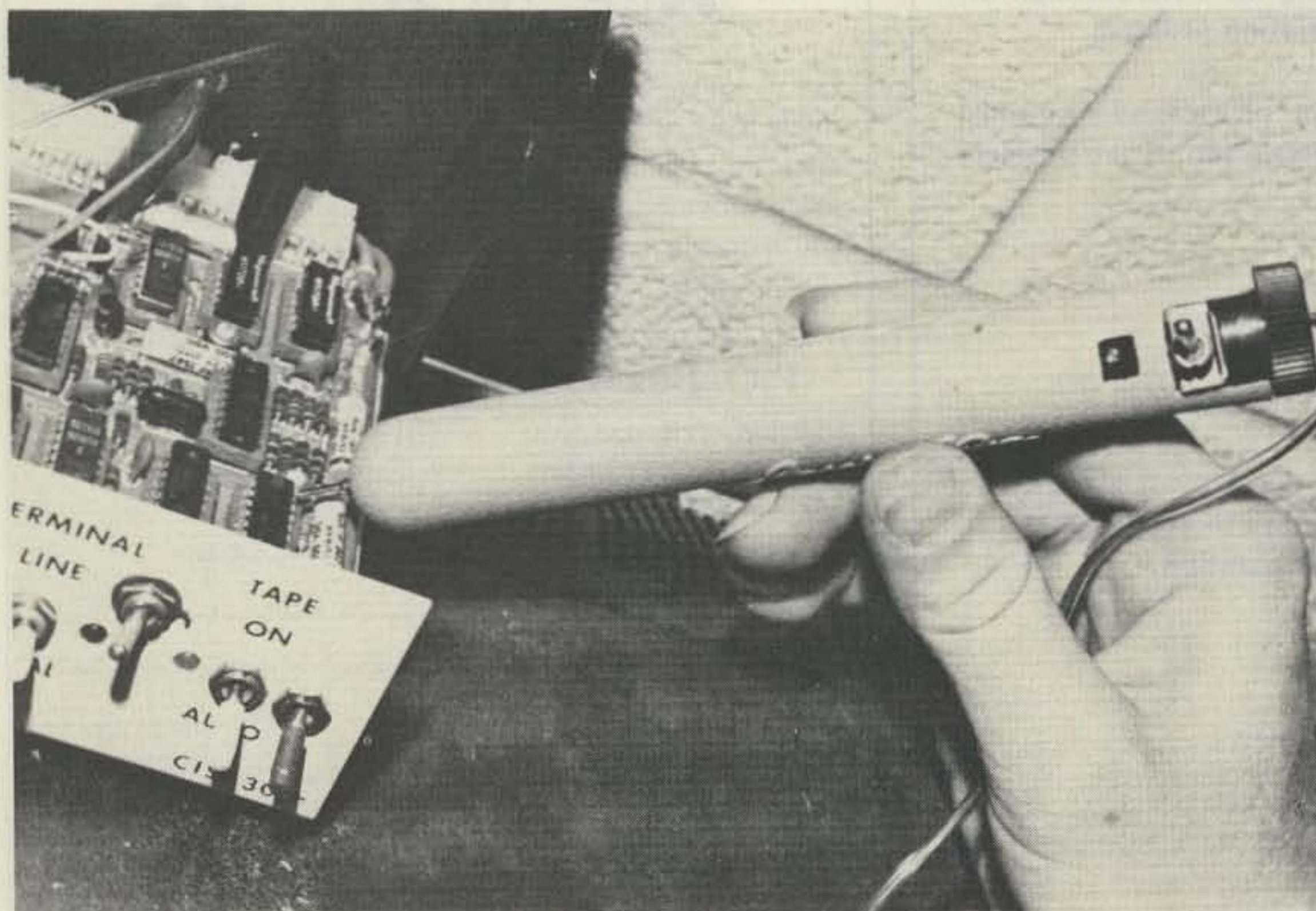

The completed Synchronized Logic Probe in action. Custom case is a cigar tube.

is connected to neither a ground nor a true value. Pin 1 of IC1A is floating (true in TTL) and pin 2 is connected to a true (Vcc) through S1 and J1 (Sync input), giving a false output of IC1A. Pin 13 of IC1D is at ground potential through R6, and pin 12 of IC1D is also true through S1 and J1, so the output of pin 11 is true. The false output of IC1A is applied to both inputs of IC1B, making its output true.

This true is applied to one input, pin 9, of IC1C. The other input, pin 10, also is true from the output of IC1D, so now IC1C has an output which is false. This false is applied to input pin 12 of IC2D. The other input is tied to the \bar{Q} output of the one-shot, IC4, which is statically true. The output of IC2D is logic true, which causes segment A of the display to be lit. To complete an F, we need to light segment G and make sure segments B, C, and D are off.

Pin 9 of IC2C is true from the output of IC1D and pin 10 of IC2C is true from the one-shot, making its output false and thus keeping segment B off. Pin 3 of inverter IC3B is true from IC1, making its output false, which, when applied to IC2B, makes its output true.

This output is inverted again through IC3C and makes segment C false, thus keeping its segment off. Pin 1 of IC2A is false from IC1A, making its output true and lighting segment G; this output is also inverted by IC3D, keeping segment D off. Thus, segments A, E, F, and G are lit while B, C, and D are off, giving a display of F (float).

Now that we have seen the float condition and the basic operation, I am going to explain the logic true or high condition. When a logic true is present at the probe tip, it is applied to pin 1 of IC1A, making its output false. This false output is

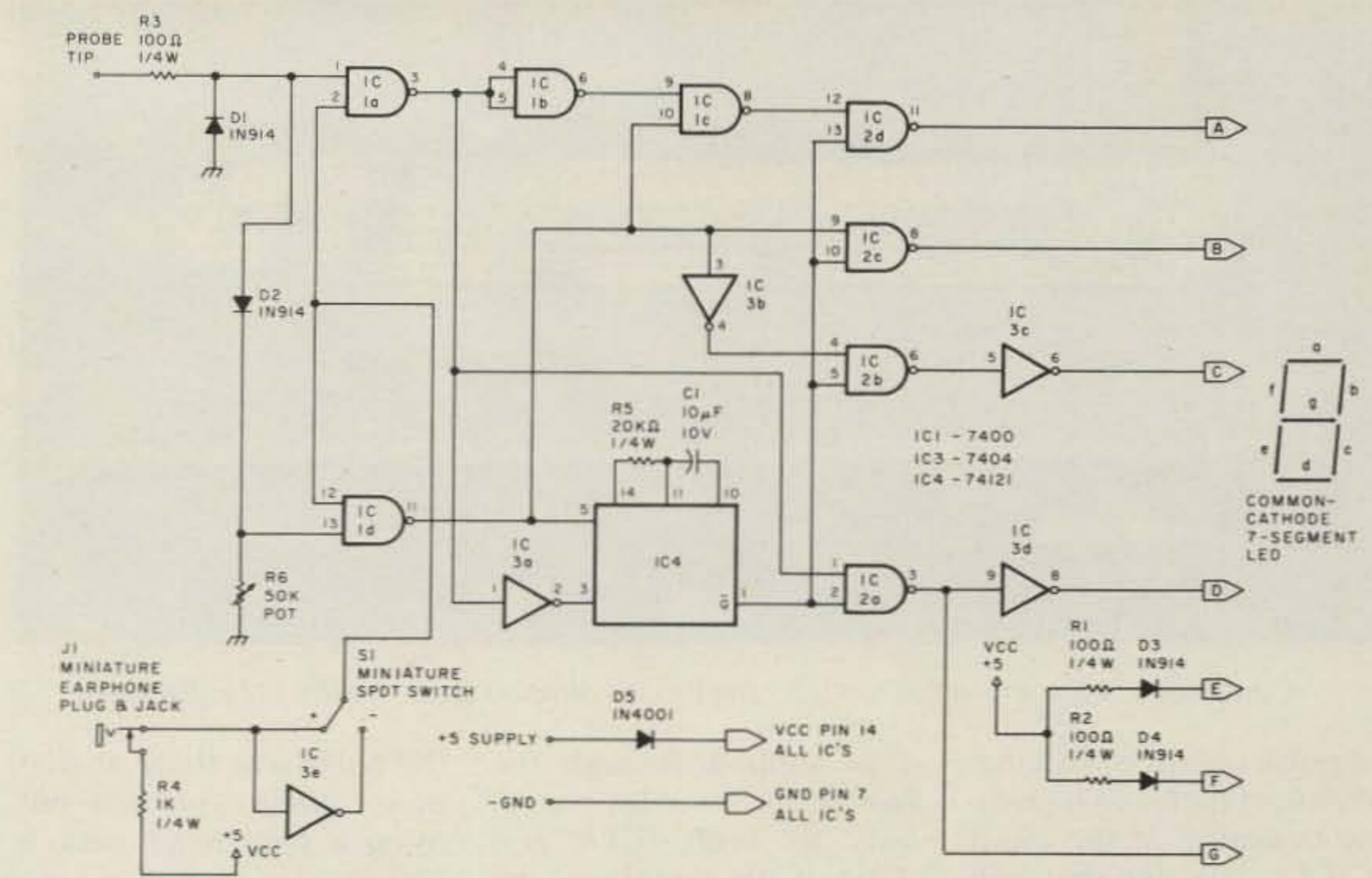

Fig. 1. Schematic diagram of the Synchronized Logic Probe.

applied to both inputs of IC1B, making its output true, which is then applied to pin 9 of IC1C.

The probe tip input is also applied to pin 13 of IC1D, making its output false and this being the other input to IC1C, thus makes its output true. This true which is applied to one input of IC2D along with a true on the other input from the \bar{Q} output of the one-shot makes the output of IC2D false, which turns segment A off. Pin 9 of IC2C is false from IC1D, making its output true and lighting segment B. Pin 4 of IC2B is true from the inverted output of IC1D, making the output of IC2B false, which is inverted by IC3E, lighting segment C. Pin 1 of IC2A is false from the output of IC1A making the output of IC2A true, which is used to light segment G and is also inverted by IC3D which keeps segment D off. Now we have segments B, C, and G lit, while segments A and D are off. Remember that segments E and F are always on and thus the display of H for a static true.

As for the low condition, all segment outputs are opposite except for segment

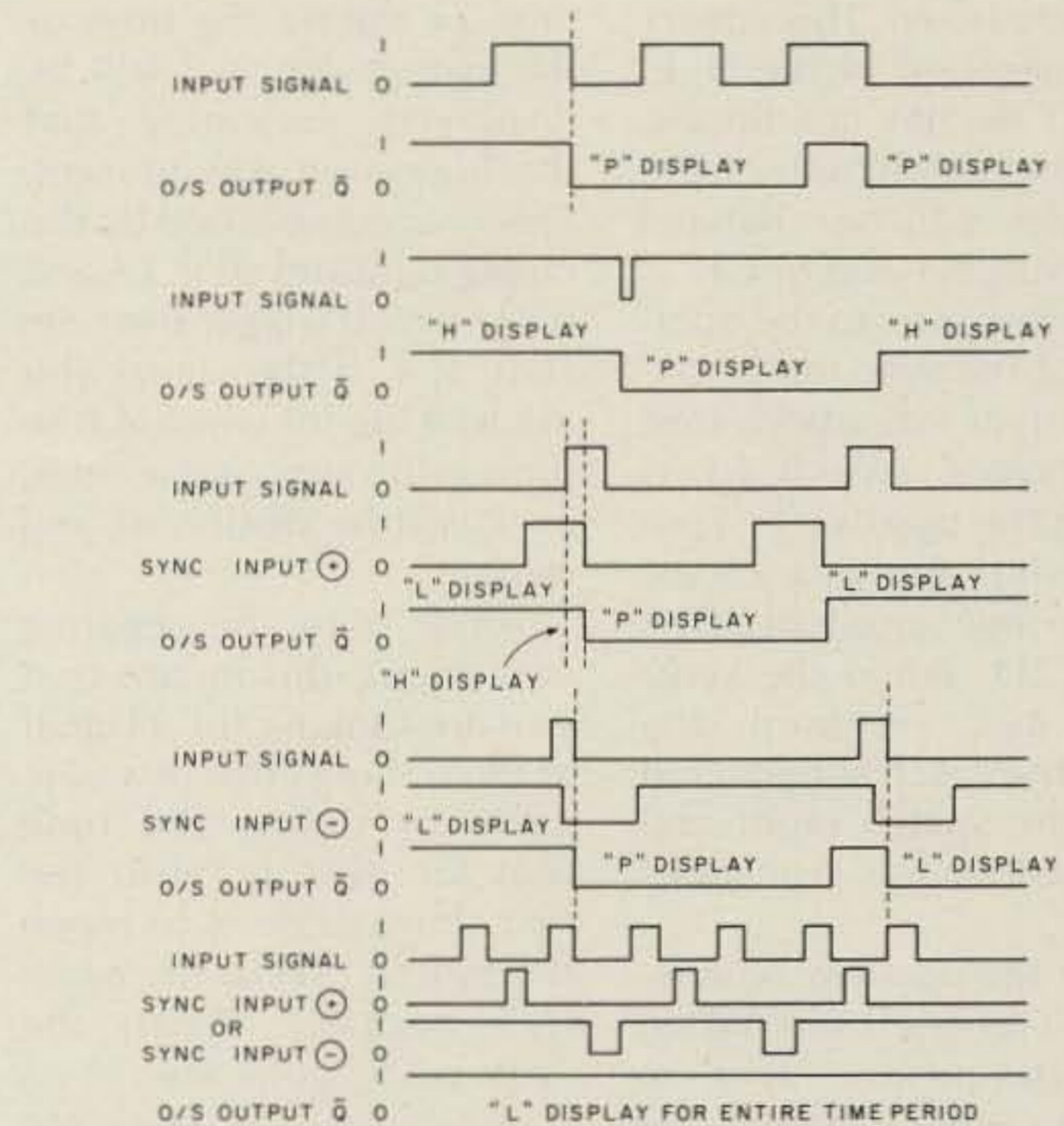
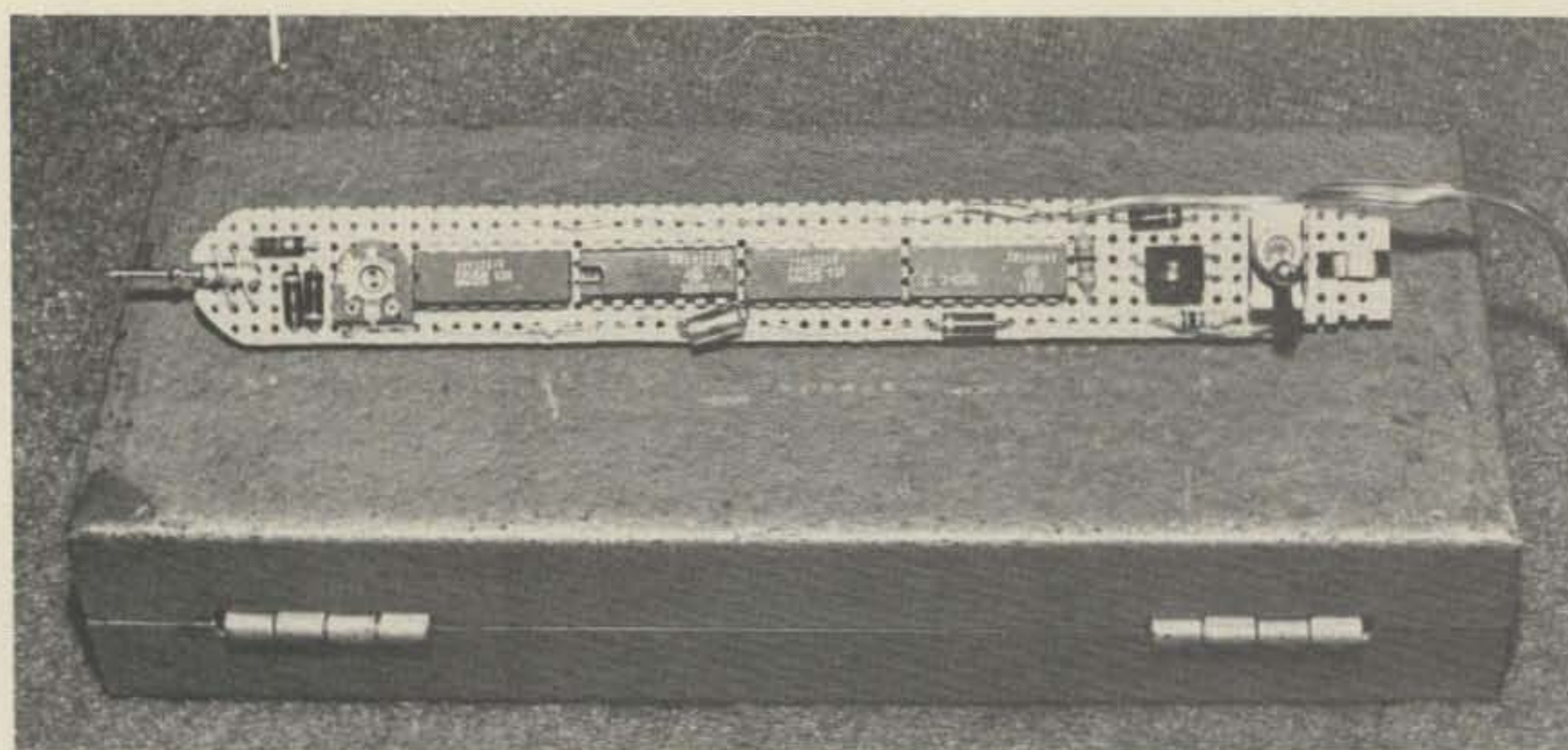

Fig. 2. Timing diagram for logic probe.

A, which remains off. Pin 1 of IC1A goes false, making its output true. This is inverted by IC1B, so a false is applied to pin 9 of IC1C along with a true from the output of IC1D. This makes the output of IC1C true. This is then applied to pin 12 of IC2D, along with a true from the \bar{Q} output of IC4, which makes the IC2D output false. This keeps segment A off.

A note about the low

condition: When you first apply the probe tip to a logic false signal, the changing state of IC1A through IC3A triggers the one-shot, making the \bar{Q} output false. This, in turn, enables segments A, B, and G regardless of the other inputs and also disables segments C and D, thus displaying a P for approximately .75 seconds before going to an L display. This can be viewed as a self-checking way to see if



Components are mounted on 0.1" perfboard shaped to fit inside cigar tube.

the pulse circuit is working. Whenever there is a high-to-low transition at the input of IC1A, the one-shot will be triggered and a P will be displayed until a constant state is reached. This covers the generation of the H, L, P, and F display conditions. Note that the length of the P display can be changed by varying R5 and/or C1.

This brings us to the operation of the sync input. Under normal conditions (not using sync), switch S1 is kept in the positive (+) position, thus applying a logic true to one input of IC1A and IC1D. When the sync-pulse input is used, the logic true is disconnected from the switch input and replaced by the sync-input signal.

First the positive sync input will be discussed. When using the positive sync input, this means that we are looking for a signal at the probe tip which is either occurring at the leading edge (low-to-high transition) of the sync pulse or during the true state of the sync pulse. When the sync pulse is true,

it is applied through the switch and enables the inputs to both IC1A and IC1D. If the signal you are looking for at the probe tip becomes true at the same time or during the time of the sync pulse, a P will be displayed, indicating that the logic true was present. This is accomplished by the changing states of IC1A and IC1D which trigger the one-shot, IC4. If the signal you are looking for was not true during the sync pulse time, an L will be displayed and remain.

When using the negative sync input, this means that you are looking for a signal at the trailing edge of a sync pulse or during the time that the sync is false. The first thing to do is to move the switch (S1) to the negative position. When the sync pulse goes low at its trailing edge, it is applied to pin 11 of IC3E, making its output true and thus enabling IC1A and IC1D. If the input signal goes true during that time, the pulse circuit is triggered and a P is displayed, indicating that

the pulse was there at that time. When you are not using a sync input, switch S1 must be kept in a positive position or the normal probe functions will not work correctly. Also, when the sync input is used and the probe tip is floating, a P will display if the sync input is active.

Construction

Fig. 3 and the photos show the complete circuit of the Synchronized Logic Probe, but there are a few things that might prove to be helpful. The prototype of this probe was built using 0.1" perfboard which was cut and shaped to fit inside a cigar tube prior to mounting any of the components. Wire buses were used for the +5-volt and ground connections for the chips and other components. As shown in Fig. 3, you should mount the display, switch, and sync jack on the end of the board first, and make any necessary cutouts on the tube housing and board. Make sure that switch S1 is easily accessible and sticks up through an opening in the tube.

There is only one adjustment on the probe—the 50k variable resistor used to establish the F state. When you get the probe assembled, connect it to your power supply and note that there is a legible display (L,

H, or F). You should adjust the potentiometer until an F is displayed with no connection to the probe tip. Once this is obtained, you will notice that there is a range of adjustment before the display changes from an F to an L or H. This adjusts the sensitivity of the probe tip to a logic high or low.

Upon completion, touch the probe tip to the +5-volt side and then to the ground side of the power supply that you are using. The probe should display an H when touched to the +5 volts. A P should be displayed for approximately .75 seconds when first touched to ground, before going to an L display. If a P is not displayed when the probe tip is first touched to ground, the pulse circuit is not functioning correctly. As long as the other displays are correct, then the problem should be in the one-shot (IC4). Check the external capacitor and resistor connections to the chip. If the other displays do not work correctly, then you will have to troubleshoot the entire circuit.

A neat trick for troubleshooting can be used if you have a display with a decimal point: Connect a piece of wire approximately 10 inches long through a 100-Ohm resistor to the decimal point and use it for a simple probe. If you touch the wire to a logic high, the decimal point will light, and if it is a low the decimal point will stay off. The 100-Ohm resistor in series with the wire is to prevent burning up the decimal point.

I used this basic logic probe when troubleshooting the more sophisticated, Synchronized Logic Probe. This, along with the circuit operation and schematics provided, should give you everything you need to build and troubleshoot the Synchronized Logic Probe. Good luck! ■

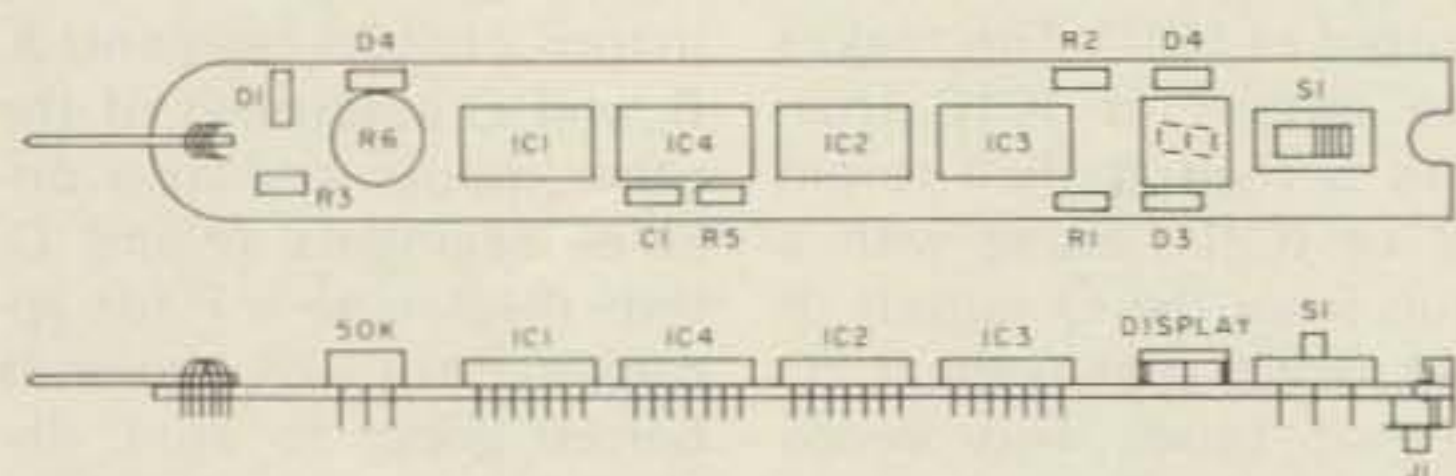
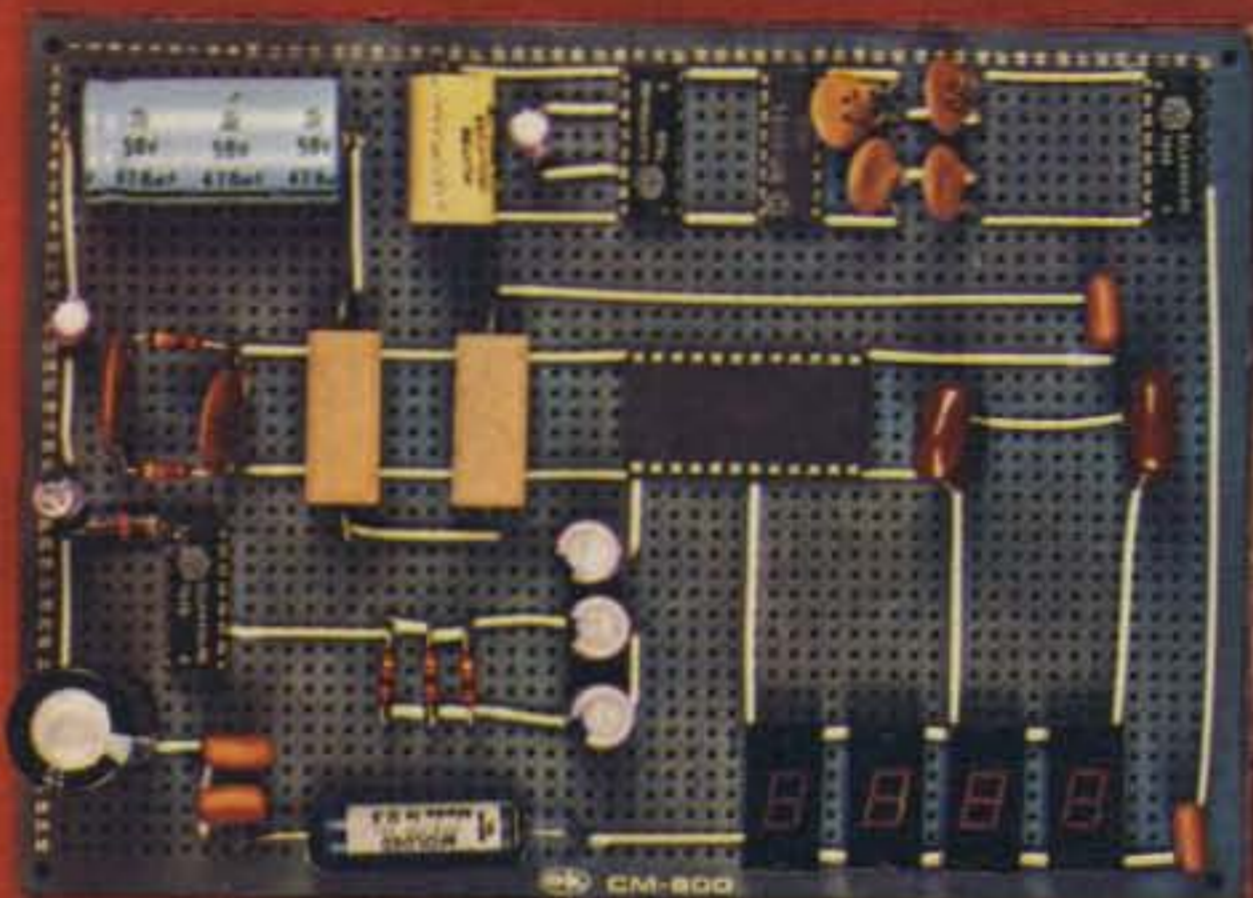

Fig. 3. Synchronized Logic Probe component mounting.



CM-600 Circuit Mount



CM-600 \$6.95*
RW-50 \$2.98*

NEW CM-600 SOLDERLESS PROTOTYPE BOARD

CM-600 is a unique system for solderless construction of circuit prototypes, useful to both engineers and hobbyists. The CM-600 is a neoprene board 4½" (114mm) x 6" (152mm) with 2280 holes on .100" (2.54mm) centers. Standard components including DIP's are mounted by simply inserting leads into the holes in the long life neoprene material. Interconnections are easily made using 20 or 22 AWG (0,8 or 0,65mm) wire jumpers. Positive contact is assured by the elasticity of the hole, which compresses the leads together. To remove components or leads, simply pull out. This facilitates easy circuit changes making it ideal for breadboarding experimental circuits. CM-600 also features numbered rows and columns for easy reference.

Accessory Kit RW-50 contains 50 pcs of AWG 20(0,8mm) insulated jumper wires of assorted lengths from ½" (13mm) to 4" (100mm). Both ends are stripped and bent 90° for easy insertion. In stock directly from

OK Machine & Tool Corporation ✓54
3455 Conner St., Bronx, N.Y. 10475 U.S.A.
Tel. (212) 994-6600 Telex 125091

* Minimum billings \$25.00, add shipping charge \$2.00
New York State residents add applicable tax



VHF Contesting

— a magnificent obsession

There are several things this article won't say. For starters, I will not tell you that VHF contesting is easy. Nor will I guarantee any kind of success if you try it on your own. Instead,

I will tell you about all the fun you are missing if you don't already participate in VHF contests; even if you are not interested in trying out this madness, you should be happy to hear

that life does exist above two meters.

Cornfields

Until a few months ago, I thought that VHF contests were intended for hams living in the East or in the West. After all, that is where mountains are, and the densely populated areas, too. Those hams living in the flat Midwest were just plain out of luck since most VHF contacts are made using a line-of-sight path.

A 45-minute drive through the rolling countryside of southwestern Ohio to the station of W8DJY was what it took to convince me that VHF con-

testing not only exists in the Midwest, but also it is doing quite well. W8DJY is located on one of the taller "peaks" near Middletown, Ohio. It sits about 200 feet above most of the surrounding terrain, at an elevation of 850 feet.

What W8DJY lacks in height is partly made up for by a jungle of aluminum. An antenna "plantation" is probably the best way to describe it. There is no stately white mansion in the middle; instead, you will find a one-story shack devoted to VHF contesting. Rather than trotting off to a mountain for a couple of weekends each year, the



Having antennas that clear the trees is important, but the W8DJY contesters rely on a knowledge of VHF propagation to supplement their line-of-sight capability.



A mix of home-brew and commercial equipment is used to give W8DJY a big signal on 220 MHz.



W8DJY spares his family from the squeaks and squawks of ham radio operating by having a separate shack. Inside, there are operating consoles for each of the VHF bands. The 6-foot dish was constructed for less than \$100 and will be used on 1296 MHz.

W8DJY ops spend their time perfecting this fixed station—one that they can use year 'round.

The inside of the shack looks a lot like what you and I might have. There is a smattering of Drake and Collins HF gear and the usual collection of QSL cards. A closer look at the cards tipped me off, however, that this station, despite its appearance, is not like yours or mine. There is a card from Japan on the wall.

"So what, I've worked a million of those guys on ten meters," you say.

Yeah, but how many have you worked on six meters?

Most of the HF gear is used with receive and transmit converters on the UHF and VHF bands. W8DJY's owner, Brownie, prefers tube-type rigs because they are less susceptible to intermod, something that becomes important when you have four separate kilowatt signals generated within a few feet of each other. Brownie patiently explains that you need every Watt up to the legal limit on 6, 2, and, if possible, on 220 and 432 MHz. Unfortunately, you can't just pick up a

kilowatt amplifier for 432 at the local Radio Shack; it's time to break out the schematics and a soldering iron.

Back at the antenna farm, I noticed that it has been designed to squeeze the most from each of those precious UHF Watts generated inside. Hard-line is considered a necessity rather than a luxury. Strangely enough, the W8DJY gang does not try to get the antennas as high as possible. Instead, they compromise between line loss, increased height, and propagation demands. The six-meter array, for example, is a pair of 11-element beams spaced 18 feet apart, only 36 feet off the ground. This, I am told, is part of the 54-MHz secret.

Secret on Six

One might think that W8DJY and other mid-western stations have three strikes against them before a contest even starts. They don't have mountains to use, the states are larger than in the East (meaning fewer section multipliers), and the centers of population are widely scattered. However, they need not drop out of the game yet. By emphasizing operation on six meters, they can



These hams are part of New England's smallest telephone company, "Mountain Bell." It exists for only one weekend each year. The large tower in the background is part of a fire lookout, not W1FC's contest effort.

make use of tropospheric scatter, a special kind of VHF propagation where the range goes far beyond line of sight. A strong signal with the antennas at the correct height for a scatter "take-off angle" allows W8DJY to work a lot of different stations on six meters and, more importantly, get section multipliers from four different directions.

By now you are probably asking yourself: "Is W8DJY a winner?" The answer is a relative one. The ops were elated to place in the top ten scores for the September, 1979, VHF QSO party. This came only three years after W8DJY started to take VHF contesting seriously. Each contest means improvements in scores and techniques. Always building and scheming, the W8DJY success is based on a nucleus of about half a dozen individuals.

W1FC—The Big Gun Station

While the men of W8DJY set their sights on a record division score, the members of the Barnstormer Amateur Radio Club aim at breaking the existing world's record, one that they set only a year before. "Big gun" is an understatement when it comes to de-

scribing the Barnstormer operation under the call of W1FC. Each June, the ops attack Pack Monadnock, southern New Hampshire's tallest drive-up mountain. Numbering more than 40 strong, they convert the normally tranquil Miller State Park into a beehive of activity.

Families planning a quiet picnic on those two sunny weekend days in June came in for a surprise. Everywhere one looked there were towers being planted and tangles of wire and tubing that resembled antennas; everything was being done with an urgency rarely found on mountaintops.

Off to the side, Fred Collins, one of the main forces behind W1FC, stood calmly watching the erection of six independent stations each with its own antennas, rigs, and shelter. The stations were tied together not only by a desire to win, but also with a common electrical system and dial telephone network installed just for this weekend.

Cherry Pickers and Microwaves

Fred explained that the Barnstormers had been active in VHF contesting since the mid-1950s. Their more than 20 years of experience



Microwave operation from Pack Monadnock means excellent range and great views of the New Hampshire countryside for the W1FC crew.



Up, up, and away. The cherry picker is pressed into service so that the microwave signals can clear the trees easily in all directions.

had been molded into a comprehensive organization dedicated to winning the June VHF QSO Party. Each band was under the direction of a manager who oversaw the installation and then the operation. Other experts handled the liaison with park officials, telephone and power companies, and the very essential food tent.

The 1980 June contest was the Barnstormers' first effort involving a cherry picker snorkel truck. Arrays for 2 meters, 220, and 432 went up in minutes on 20- and 30-foot towers guyed to nearby rocks with packing twine. The cherry picker, borrowed from a

Boston area firm for the weekend, was just one example of how the W1FC gang makes the most of available resources.

By 1978, the W1FC contesters had developed excellent stations and operating techniques for the frequencies below 2 gigahertz. In 1979, a year of hard work paid off when they were able to operate on 2.3, 3.4, 5.7, and 10 GHz. One setup remained on Pack Monadnock while others were sent traveling to nearby states so that five sections could be worked on each of the new bands. The efforts paid off. The score was a record one that outdistanced the nearest competitor by more

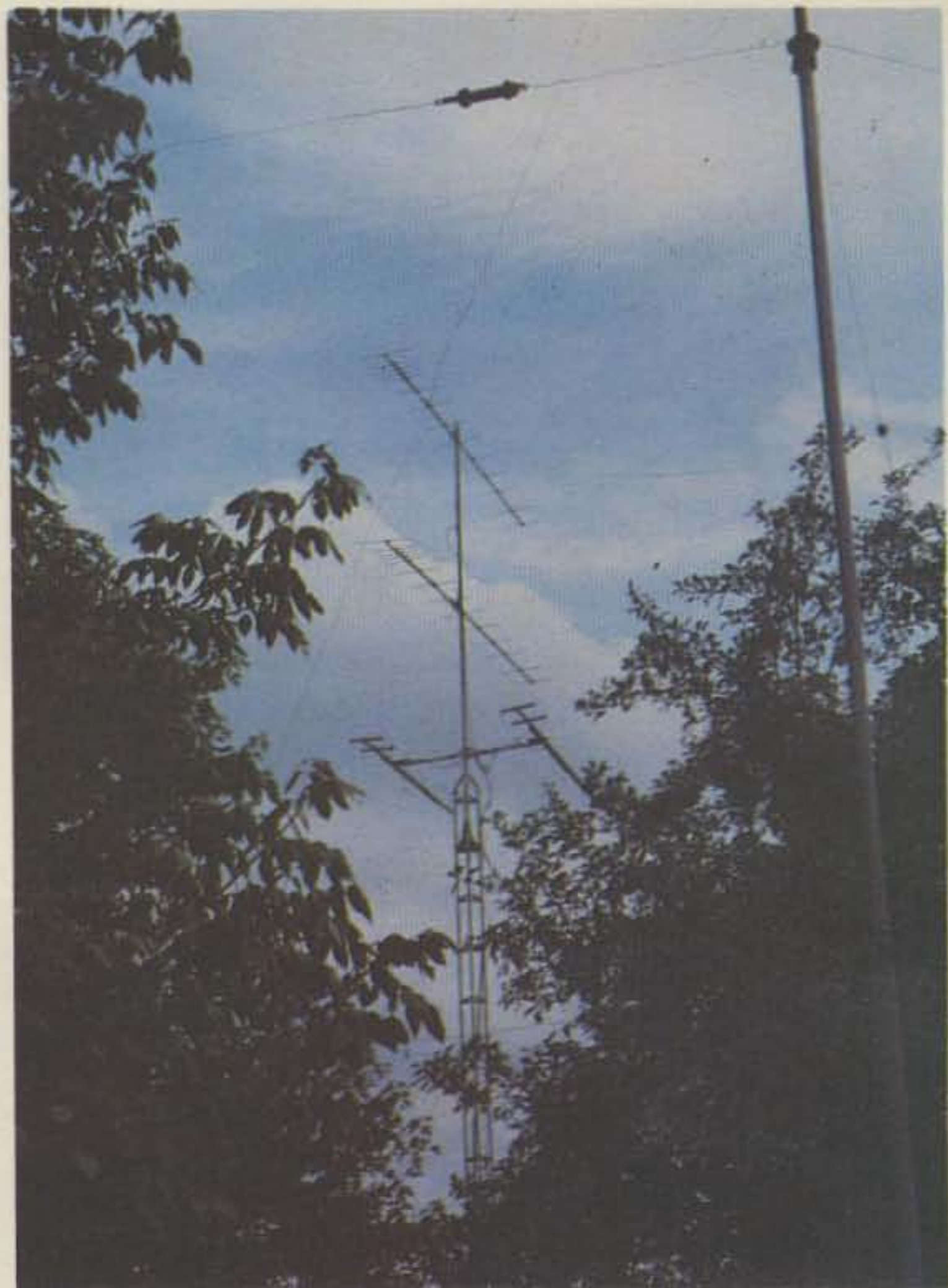

Visitors to Miller State Park shook their heads in disbelief as they saw erected arrays like this one for two meters.

than 20,000 points.

A rules change made the 1980 contest even more challenging. This year they needed five complete microwave stations, each capable of operating on four bands. The collection of gear required was probably the largest amount of amateur microwave equipment ever assembled in this country. Once again, the resources and skills of the Barnstormers prevailed.

At the last-minute strategy session, there was talk of setting another record—one that nobody could break. The friendly euphoria of setting up was gone. The mood grew serious. "Keep your stations transmitting all the time, always turning the antennas!" The operators on the populated six- and two-meter bands were expected to keep the rate up. Suddenly, the pep talk was over and it was

time to begin.

The spirit of W1FC was expressed by one operator who gazed proudly at a remote 1296 rig which he had helped to build. He said that last year they made 19 contacts on 1296 and that this year the goal was 25. I noticed that he had a six-pack in hand as he headed for the shack (which was someone's van the rest of the year). It would be a long night of calling, hoping, and thinking about what could be done for 1981.

Conclusion

On the low bands, cynics abound. They claim amateur radio is dead. It is said that we are guilty of being appliance operators, that the gentlemen's camaraderie is long gone, and even that the fun has left ham radio. Visit or talk to a VHF contester; he or she will tell you a far different story. ■

NEW! 5-Band Trap Dipole (80 thru 10Meters)



Pre-assembled:
Model 370-11

Power rated 2kW PEP, approx. 110-ft span

Complete with • wire • traps • end insulators • 50 ft RG-8/U, PL-259 connector • heavy duty cast aluminum and steatite center connector.

At your B&W dealer. 4-Band (40 thru 10M), 55 ft model 370-13 also available, pre-assembled only.



Made in Bristol, Pennsylvania, by

Barker & Williamson Inc.

10 Canal Street □ Bristol, PA 19007

Handie
MORE POWER TO YOU!



KLM's NEW MA-35BL Power Amplifier
35W out, Preamp, Nicad Charger!

KLM, P. O. Box 816, Morgan Hill, CA 95037

Microcraft's New Morse-A-Word

Eight character moving display.
Built-in code practice oscillator.
Excellent for learning Morse Code.
Complete — no CRT or expensive extras needed.
Decodes audio CW signals from your receiver's speaker and displays letters, numbers, punctuation and special Morse characters as the code is received.



MORSE-A-WORD Kit with 4 character readout MAWK-4 \$149.95
MORSE-A-WORD Kit with 8 character readout MAWK-8 \$169.95
MORSE-A-WORD wired & tested with 8 character readout ... MAWF \$249.95

Send check or money order. Use your VISA or Master Charge. Add \$3.50 shipping and handling for continental U.S. Wisconsin residents add 4% State Sales Tax.

Microcraft Corporation Telephone: (414) 241-8144
P. O. Box 513G, Thiensville, Wisconsin 53092

For your TRS-80 send & receive CW/RTTY



FEATURES

- Auto Send & Receive RTTY & CW
- Connects to TRS-80 User Port & Key / head phone jacks
- 10 message memories 255 char. ea.
- Uses builtin PLL or external TU
- Includes hardware, cassette & manual
- Morse tutorial-10 lessons-corrects mistakes simplest, fastest way to learn the code
- Morse practice-random 5 letter words
- Auto numbering contest keyer
- Interactive graphics custom PIX
- Autotransmitter control PTT
- Requires Level II Basic & 16K RAM
- M80 Software, PC Board, Manual \$149
- CM80 As above in Cabinet \$279
- TM80 As above plus demodulator & AFSK \$499
- M800 Adds advanced RTTY to M80 / CM80 / TM80 \$99

TRS-80 Model III

Interface Available Call for information

MACROTRONICS, inc.®

1125 N. Golden State Blvd. / Suite G
Turlock, CA 95380 (S)
(209) 667-2888 / 634-8888

Write or call for complete catalog

We are experiencing telephone difficulties, please keep trying.

TRS-80 is a recognized trademark of Tandy Corporation.

NEW! M8000 DISK BASED RTTY for the TRS-80

★ DISK BASED "MAILBOX" - Any station on frequency can:

- Leave a message in a mailbox (on disk)
- Playback any message from disk
- Echo a message
- Play the system instructions
- List current calls in mailbox
- And much much more!

★ Customized with your Name & Callsign
(S100 with M800 Trade-in) **ONLY \$150**

Write or call for ordering information. Requires M80 CM80 or TM80 plus 32K TRS80 Disk System.

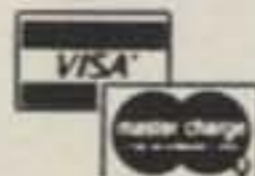

California residents add 6% tax

Sell 'Em with Slides

— A/V shows can fire club enthusiasm

Matt Beha N8BPI
3752 Lane Court
St. Joseph MI 49085



"Let's put on our thinking caps and produce one hamfest that will really draw a crowd."

When I was named chairman of the Blossomland Amateur Radio Association's 1980 hamfest, I had some new ideas. To make sure they would be accepted, to thwart the potential wet-blanket-thrower every group seems to have, and to light a fire of enthusiasm under our club, I decided to promote our hamfest with a big kickoff.

For background, let me explain that the hamfest the

year before had been held in an unheated county fair exhibition hall on a cold October Sunday. More than a few of us went home with the sniffles. That, plus the fact that I wanted to produce a little more than a flea market, prompted me to look for a new and better site for our 1980 function.

The logical site, in my estimation, was Lake Michigan College's new Community Center near Benton

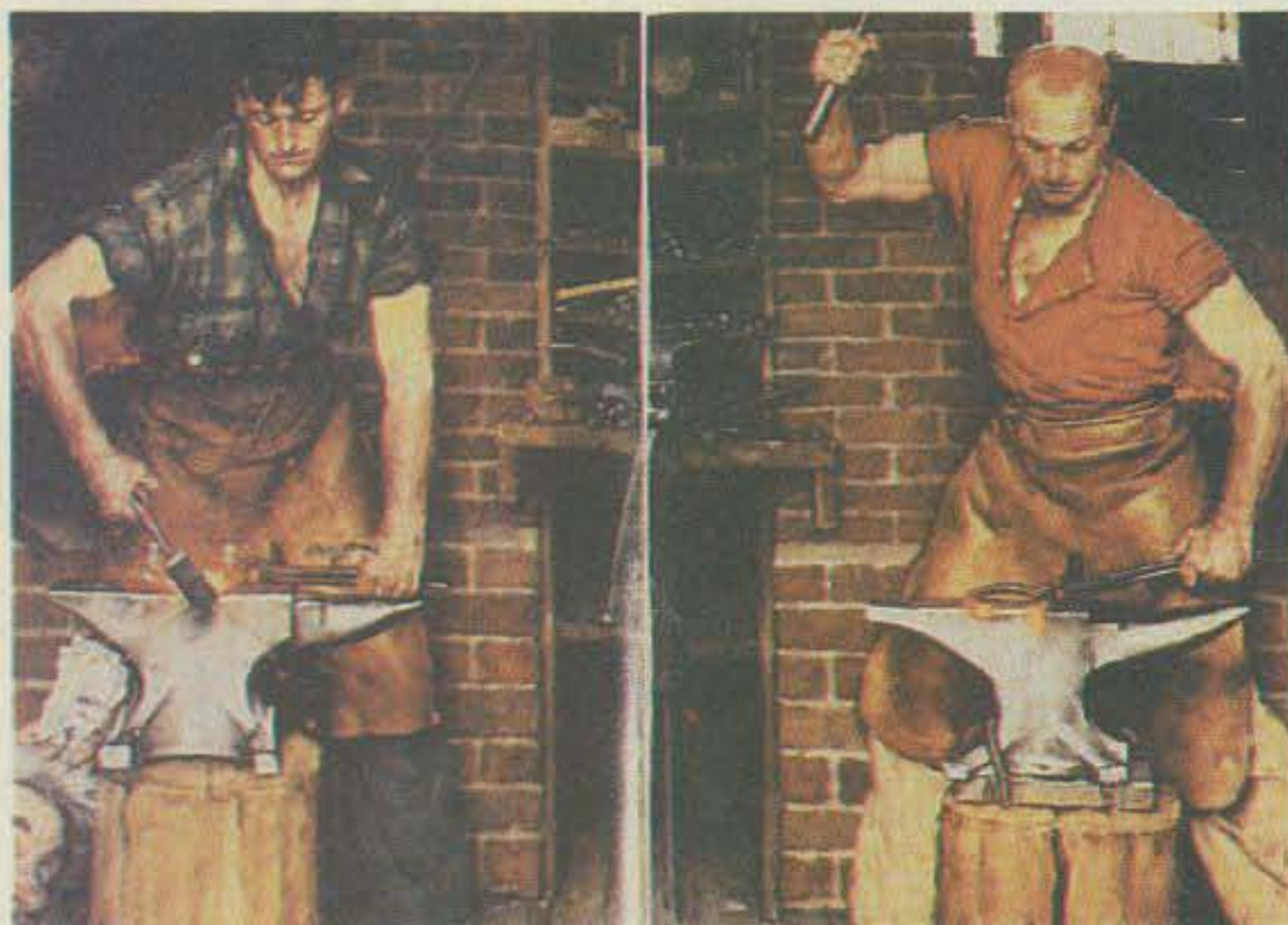

"How about a brass-pounder's contest?"

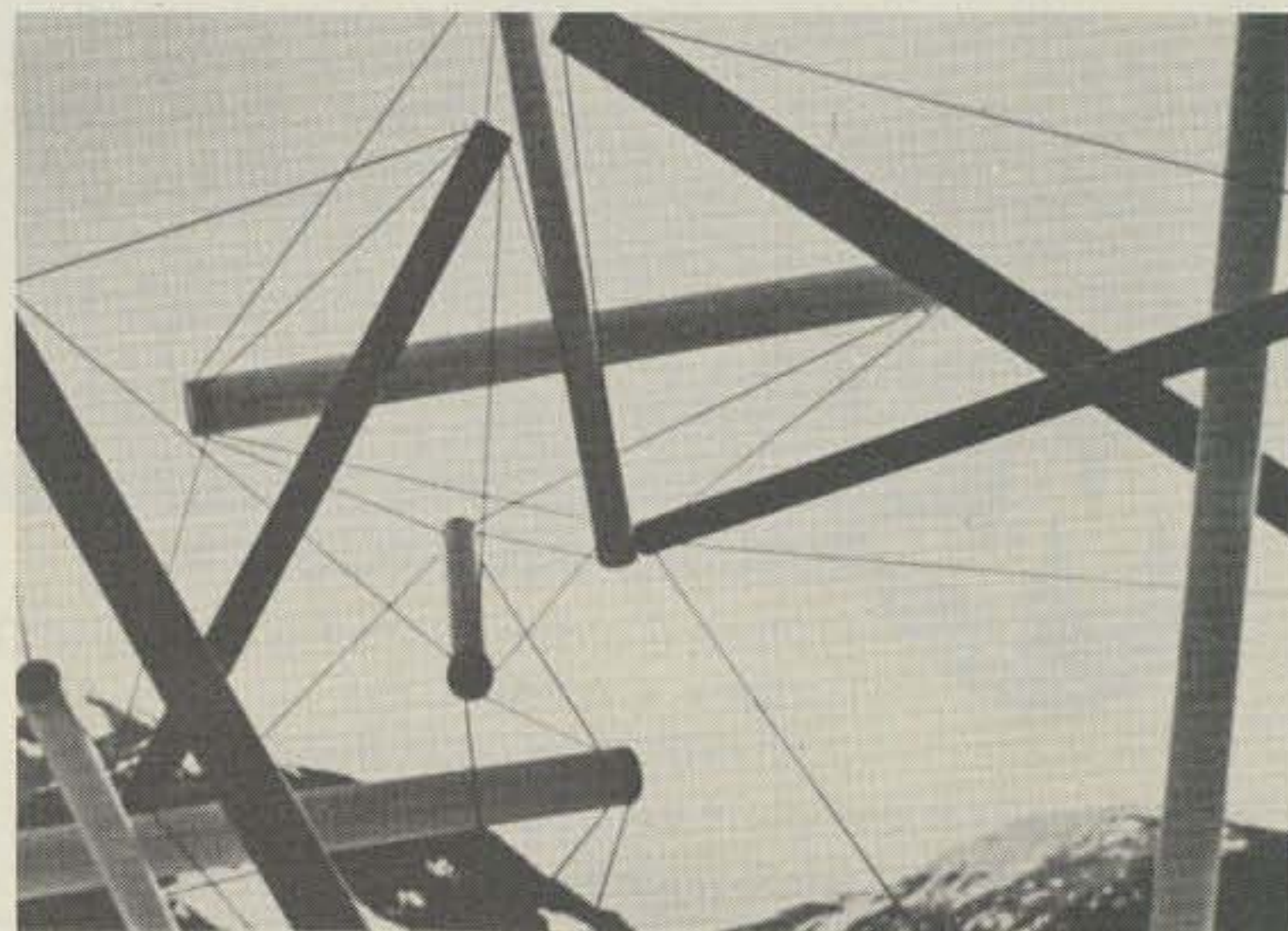

"Let's let the club experts give a lecture on antenna design."



"It's conveniently located to Chicago, South Bend, and Kalamazoo..."

"The place we should hold our 1980 Blossomland ARA Hamfest is the beautiful new Lake Michigan College Community Center."

Harbor, Michigan. Not only did it offer us the chance to double our floor space, have heat or air conditioning as needed, and have separate areas for tech sessions, movies, and flea market, but also its location just one mile off exit 30 of I-94 was more convenient than last year's.

ham gear; a catering service to provide food; and our choice of one, two, or three beautifully carpeted lecture rooms in addition to the flea market area. They even had 2,500 paved parking spaces.

I checked with the College. Would the Community Center be available for Sunday, October 5, the traditional day for the Blossomland Fest? A sigh of relief—Linda Castle, the director of the Center, said the date was still available. Next crucial question: How much would it cost? Just as I had suspected—about double what we had spent the previous year. That would require a little selling job to the club members.

So far, so good. Now to prepare a presentation for the next club meeting to forestall any negative ideas... and to generate enthusiasm for our 1980 hamfest.

First, I gathered a nucleus of club members I knew would support me, and we arranged for a tour of the Community Center to make sure it would meet our needs. On February 18, Jon WA0TAQ, Matt WA3LOP, Craig WB8VKA, Al W8LRM, and I were given a tour by Mrs. Castle. Fantastic! The center had: more than twice the space of our previous site; plenty of electrical outlets; handy access for our dealers and distributors to unload and load large quantities of

I decided an A/V (audio/video) show with lively music and a script supported by slides would sell the idea to the club. First I wrote the script, beginning with the negative aspects of our previous site, moving on to possible plans for a bigger hamfest with technical sessions, and then presenting the Lake Michigan College facility as the perfect setting for our 1980 "Blossomland Blast," as I decided to call it.

Once I had written and rewritten the script, I jotted down some notes on possible slides to illustrate my points. Armed with script and a list of pictures, I took off down Washington Avenue to the Lincoln Township Library. I made a bee-line to the photography section and selected a dozen or so books of photographic art pictures. I set up camp at a table and flipped



"That's the plan for the 1980 Blossomland Blast—the biggest and best hamfest yet in southwestern Michigan!"

through each book, page by page. When I spotted a picture I thought would illustrate a point (sometimes humorous, sometimes not), I would put that book aside. Within two hours I had the pictures I wanted and checked the books out.

er rent. First, I did a survey of hamfest ads for amateur magazines: I discovered that our 1979 ticket prices had been way below average. If we raised prices just to the average and maintained attendance, we would be able to cover our expenses. And with a little added promotion, we would be able to show enough profit to keep our repeater rig going for another year, which was the original intent of the hamfest.

I was spared the task of shooting the slides myself. We're privileged to have a professional photographer in our club, whose studio shoots the ham gear pictures for the Heathkit® catalog. Jim KA8GIX volunteered to make the slides for me and did a super job.

I made up some charts, a rough sketch of the Community Center's floor plan, and a map showing access. Another club member, Floyd K8ZLO, arranged to have some beautiful graph-

Naturally, not all the slides I needed were to be found in books. I wanted supporting proof that our club could afford the high-

ics done, and those also became slides.

When I got the slides, I put them in the projector and started a tape. The music I had selected for background music was Billy Joel's "Root Beer Rag," a very lively instrumental that I knew would generate enthusiasm. Then I ran through the slides and script, timing them to the music, changing slide sequence here and there, until I had the time down pat.

I practiced a number of times before the meeting to make sure I knew when to hit the slide changes (wishing I had the bucks to have

it pulse-controlled). On meeting night, our club president, Larry W5VUF, arranged for me to have the last spot on the business agenda so that I could talk to potential volunteers for hamfest duty while we broke for refreshments.

My spot came, the lights went out, and I launched into a short, snappy six-minute presentation with the script I had memorized, the music, and the slides.

When the lights came on, there was a fair round of applause. Co-chairman Jon WAØTAQ and I passed out a prepared sheet to each member. On it I had written

up a sample program for our planned hamfest—an ARRL movie (if I could get it), a slide-show tour of the Heathkit factory (if I could shoot it), an XYL program, lectures, and demonstrations by experts from our club or the area. At the bottom of the sheet I had typed out a list of requests—typing help, volunteers to take posters and flyers to other fests, volunteers to make signs, give ideas, etc. I put my name and address at the bottom of the sheet.

The enthusiasm was great. If there had been any wet blankets waiting to be tossed because of the high

rent (or who knows what), they weren't in evidence when the membership voted to expend the necessary funds to hold our October 5 Blossomland Blast at Lake Michigan College. It was unanimous.

I enjoyed the slide show so much that I've since done another on our club's first transmitter hunt, using the folksong "The Fox" for background music. I'm going to do another on our Field Day activities for another club meeting. Slide shows are fun to do, and they can add a new dimension to your club's meetings. ■

Slide	Narration
Churchill holding up two fingers in Victory sign	In the past, the Blossomland Amateur Radio Association has held two hamfests each year.
Modern art skeleton	They were pretty bare-bones affairs—basically flea markets where everybody came . . .
Modern art junk pile	to look at everybody else's used gear, kick the tires, and then go home.
Crowd of 1910 kids	This year let's really draw a crowd to our Blossomland Hamfest . . .
Kid with weird hat	let's put on our thinking caps and produce one hamfest that will . . .
Large crowd with motorcycle cops	really draw a crowd.
Girl watching puppet show	Let's really put on a show . . .
Man with huge 5¢ sign	and give ticket buyers their money's worth!
Squiggly art work	We could give demonstrations on slow-scan TV.
Old-timer at typewriter	Or show people how RTTY works.
Two blacksmiths	How about a brass-pounder's contest?
Boat and flooded sign	Hutch WB8WLS could give a presentation on emergency operations . . .
1920's rig	Neil WD8MAW, would you like to head a program on contest operations?
Rube Goldberg contraption	We could have a slide and sound tour of the Heathkit factory.
Modern art spider web	Let's let the club experts give a lecture on antenna design.
1910 school kids	We'll send our ticket buyers home a little wiser than they came, with a program like this.
"Etc." cartoon	Those are just a few ideas. With the talent we have in this club, there's even more that we can do.
Packed football stadium	A hamfest like this will draw a crowd, so we'll need a place to put them.
Nutty tractor driver	The place I'm thinking of has plenty of free, paved parking—2,500 spaces, in fact!
Men with electronic gizmo	It's a place that will attract a lot of dealers and distributors to display their wares.
Kid with hamburger stuffed in mouth	The place I have in mind even has a food catering service . . .
Crazy sheriff	and its own security force.
Map with distances	It's conveniently located to Chicago, South Bend, and Kalamazoo.
Lake Michigan College Community Center	The place we should hold our 1980 Blossomland ARA Hamfest is the beautiful new Lake Michigan College Community Center.
Floor plan	14,400 square feet of space, more than double what we have had in the past—with separate areas for movies and lectures. All the space we need to put on a first-class hamfest!
Baby crying	Now you're asking, "How much is this going to cost?"
Less-than-\$650 slide	Including tables, chairs, setup and security, less than \$650. But you're asking, "Where will we get the money?" Take a look at this . . .
Chart—1979 hamfests	a survey of 1979 hamfests shows that our ticket prices were well below average.
Chart—1979 sales, projected sales	Last year we brought in \$1,266.00 in ticket and flea market sales. If we have the same attendance in 1980 and raise our prices to the average (and that's only the 1979 average), we'll bring in \$1,817, more than enough to meet the increased expenses. Of course, if we put on a great fest and promote it, we could double attendance.
Chart—promotion	How can we promote our hamfest? First, with a mailing to last year's ticket buyers; second, a mailing especially for clubs; third, ham magazine ads, press releases, and photos to area newspapers; next, television and radio talk shows. What about a QSO party to promote our fest? Later I'll be giving you flyers to send out with your QSL cards. We'll have flyers to give dealers who will be attending. Finally, you'll receive mike-side fact sheets you can use to promote our hamfest when you make a contact.
Club's Bumblebee with Blossomland Blast logo	That's the plan for the 1980 Blossomland Blast—the biggest and best hamfest yet in southwestern Michigan! See you on Sunday, October 5.
KA8GIX slide	I'd like to give special thanks to Jim KA8GIX for the photography . . .
K8ZLO	and to Floyd K8ZLO who provided the graphics.

Signalcrafters Presents The Most Advanced Automatic Computing Power Meters In Amateur Radio!



MODELS 31 and 32*

Our portable Models 31 and 32 feature the same state-of-the-art technology that is incorporated in their Big Brother, the Model 30. Never again will you have to bother with SWR "calibrate" controls and switches! Signalcrafters' custom integrated circuit makes power and SWR measurement a "hands-off" operation by automatically computing SWR. The result is unparalleled accuracy and ease of operation.

FEATURES:

- **CUSTOM IC**—Computes SWR from the level sensed on the transmission line independent of the power level. This analog computer operates over a range of only one watt to the full scale of the meter with unequaled accuracy.
- **RUGGED TAUT-BAND METERS**—Provide accuracy and readability that must be seen to be appreciated.
- **HEAVY DUTY CABINETS**—Handsome heavy duty metal cabinets complement virtually every transceiver on the market today.
- **TWO MODES—PEAK OR AVERAGE**—The amateur may choose between either peak or average power readings.
- **POWER REQUIREMENTS**—Due to the advanced low current design, battery life is truly outstanding, making this meter a natural for portable or field day operation. Uses standard 9 volt battery or 120V AC with optional AC adaptor.
- **ATTRACTIVE AFFORDABLE PRICING**
 *Model 31A (0 to 200w)
 31B (0 to 20w)
 only \$149.00
 Model 32A (0 to 200w, 0 to 2000w)
 32B (0 to 20w,
 0 to 200w)
 ✓66 only \$169.00

SIGNALCRAFTERS, INC.
 5460 BUENA VISTA DRIVE
 SHAWNEE MISSION, KANSAS 66205
 913/262-6565; TELEX 42-4171

All Signalcrafters products are designed, engineered, and produced in the U.S.A. Prices include shipping to all U.S.A. VISA and Master Charge accepted. Kansas Residents please add 3% percent.

WHY PAY

FULL PRICE FOR
AN 80-10 METER
VERTICAL

- ... if you can use only 1/3 of it on 10?
- ... or only 1/2 of it on 20?
- ... or only 3/4 of it on 40?

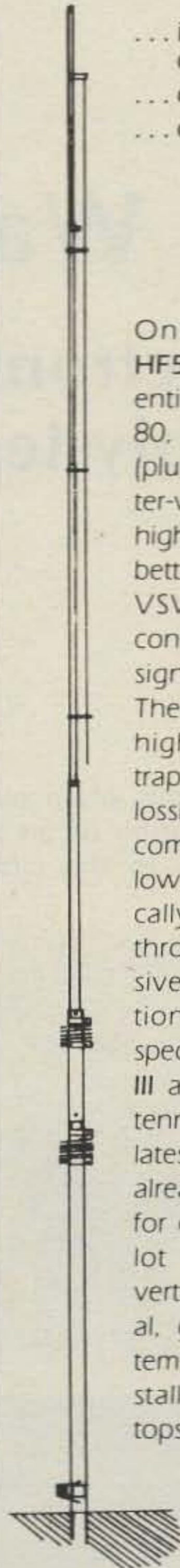

Only Butternut's new HF5V-III lets you use the entire 26-foot radiator on 80, 40, 20 and 10 meters (plus a full unloaded quarter-wavelength on 15) for higher radiation resistance, better efficiency and greater VSWR bandwidth than conventional multi-trap designs of comparable size. The HF5V-III uses only two high-Q L-C circuits (not traps!) and one practically lossless linear decoupler for completely automatic and low VSWR resonance (typically below 1.5:1) on 80 through 10 meters, inclusive. For further information, including complete specifications on the HF5V-III and other Butternut antenna products, ask for our latest free catalog. If you've already "gone vertical," ask for one anyway. There's a lot of information about vertical antennas in general, ground and radial systems, plus helpful tips on installing verticals on rooftops, on mobile homes, etc.



**BUTTERNUT
ELECTRONICS
CO.** ✓391

P.O. Box #1411
 San Marcos, Texas 78666
 Phone: (512) 396-4111

Copy RTTY, ASCII
and Morse
from the palm
of your hand.

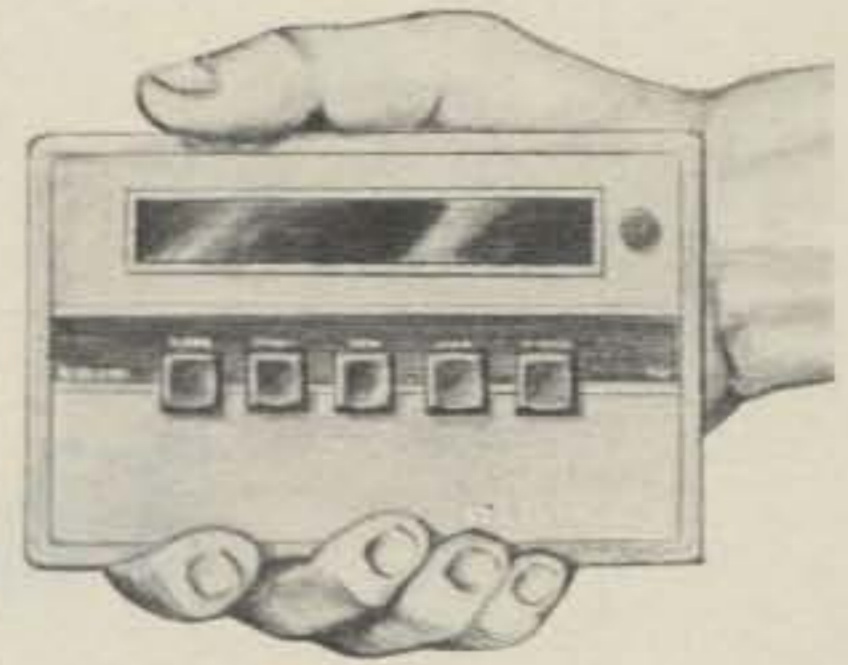

Have you waited to get into code reading until you found out what this latest fad was about? You can stop waiting, because it's no longer a fad.

Amateurs everywhere are tossing the gigantic clanking monsters of yesteryear that once performed the job of reading radioteletype. They are trading them in for state-of-the-art code-reading devices that are incredibly small, noiseless if desired and infinitely more versatile than their antique predecessors.

Kantronics, the leader in code-reading development, has just introduced the latest and most-advanced breakthrough in the copying of Morse code, radioteletype and ASCII computer language.

The **Kantronics Mini-Reader** reads all three types of code, displays code speed, keeps a 24-hour clock, acts as a radioteletype demodulator and reads all of its decoded information out on a traveling display of 10 easy-to-read characters. It is so compact that it fits in a hand-held, calculator-size enclosure.

At \$314.95, the **Mini-Reader** outperforms anything within another \$400 of its price range.

Call or visit your Authorized Kantronics Dealer now to find out what the latest in technology has done to code-reading.

Kantronics

(913) 842-7745
 1202 E. 23rd Street
 Lawrence, Kansas 66044

The Power Waster

— adjustable electronic load
for power supply testing

John Roos K6IQL
953 Valley High
Thousand Oaks CA 91360

Testing of bench power supplies, batteries, voltage regulators, or current limiters often requires application of an adjustable load to the circuit. After

years of connecting hazy combinations of resistors together to test various power supplies, I determined that a really high-power adjustable electronic load would be a welcome addition to my test equipment. In short order the Power Waster was created, and during some three years it has proven most useful.

The load described in this article will handle the majority of amateur radio and microprocessor power supply tests. In addition, it has a number of other uses, such as constant-current battery charging.

Current drawn by the load is adjustable from 0 to 10 Amperes. Input voltages up to 30 volts are permitted at full current; that's 300 Watts dissipation! Heat sinking of the pass transistors is sufficient to permit 300-Watt operation for about ten minutes, at which point a thermal protection switch shuts the current off.

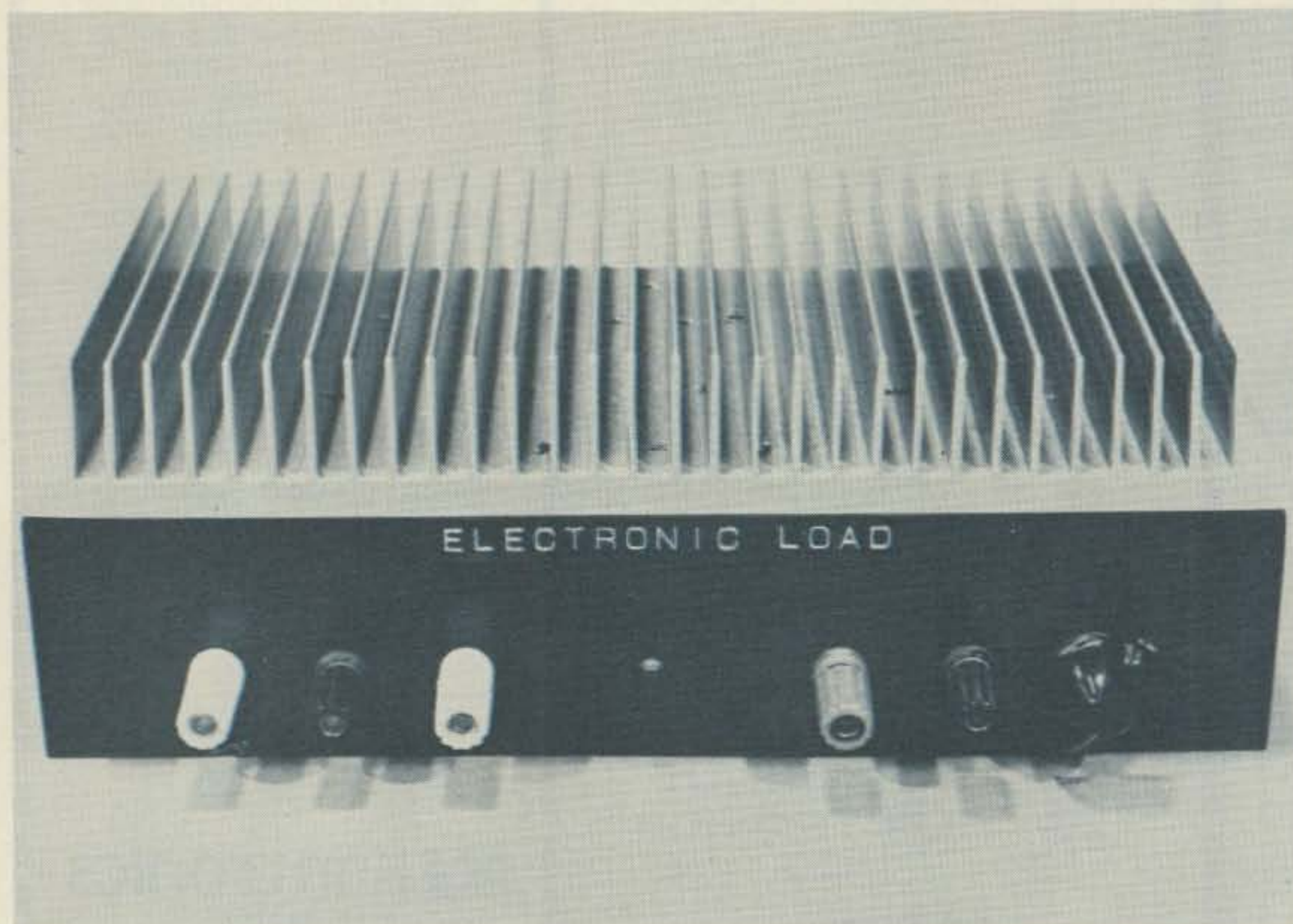

Photo A. The Power Waster. This electronic load is adjustable from 0 to 10 A and can dissipate up to 300 Watts. The unit is built upon a piece of heat-sink extrusion and has both reverse polarity and thermal overload protection.

At 100 Watts dissipation the heat sink is adequate for indefinite operation. By directing a small blower at the heat sink, I have run the load at 300 Watts for hours without difficulty.

Since I desired essentially self-contained operation, I included a small supply in the unit to bias the load transistors. Current is controlled by means of a front panel pot, and reverse polarity protection is included. A front-panel LED indicates operation of thermal shutdown circuitry. I took advantage of extra heat sink area to add two 8-Ohm, 50-Watt resistors. These are used for testing audio amplifiers or to increase the dissipation capability of the Power Waster circuit.

Circuit Operation

The simplified schematics in Fig. 1 are useful in understanding how the circuit operates. Commercial load boxes use current sensing and feedback to set the load current. My approach is simpler and uses the constant-current collector load-line characteristic of all bipolar transistors.

Fig. 1 shows the basic idea. The base of Q1 is biased at several volts from voltage source V1. The collector supply (V2) is greater than V1 by at least 1 volt. The voltage at the emitter of Q1 is one diode drop (0.7 V) below the base voltage, and the circuit is essentially an emitter follower. Emitter current is set by dividing the emitter voltage by R1. As R1 is decreased, the emitter current increases.

The collector current for any transistor is simply alpha (the common-base current gain) times the emitter current. As alpha is essentially equal to 1 for any modern transistor, we see that setting the emitter current also sets the collector current. And this is the point; the collector current

is determined only by the emitter current. Collector voltage has almost no effect on the collector current, provided the transistor is kept from saturation or breakdown. Saturation occurs if the collector voltage becomes less than the base voltage. Breakdown will occur if any excessive voltage is applied.

The constant-current collector load line is a useful property. If the voltage across R1 is small compared to the collector supply, a lot of power can be controlled and will be quite independent of the collector supply voltage. If a relatively low base-bias voltage is used, most of the power will be dissipated in the transistor and relatively little in R1.

As useful as this circuit is, there are some disadvantages. The main problem is that R1 must be a variable resistor capable of handling the entire load current. In a practical circuit, this becomes a 0.2-Ohm pot rated for 10 Amperes, which is an

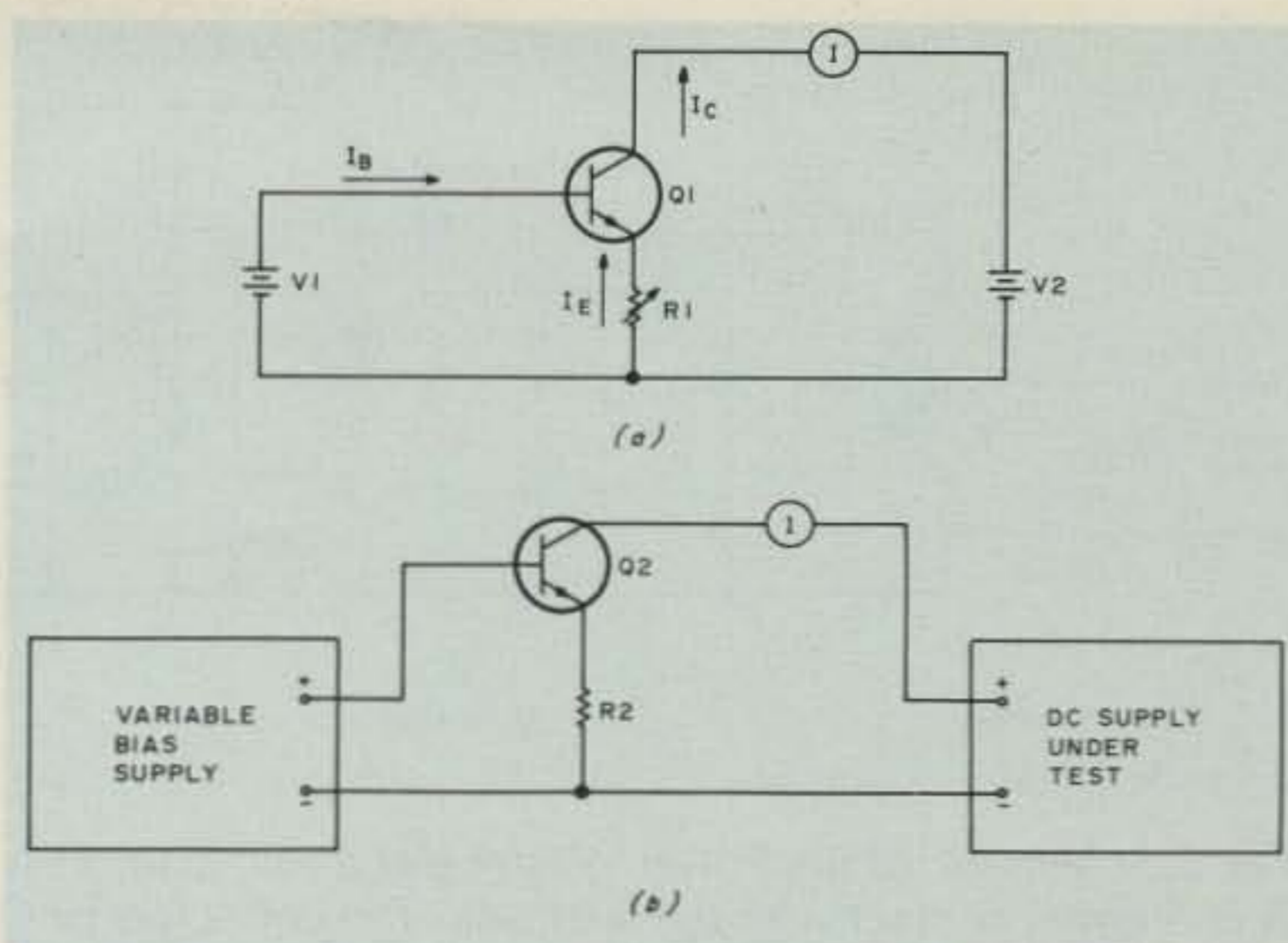

Fig. 1. Constant-current bias circuits. (a) A transistor with fixed base voltage. Collector current is set by emitter resistor. (b) Basic circuit of the electronic load. Emitter resistor is fixed, and both emitter and collector current are controlled with base-bias supply voltage.

expensive item.

By arranging the circuit as indicated in Fig. 1(b), things become a bit easier. Resistor R2 is a fixed high-power resistor. The base supply is made variable. Since the circuit is essentially an emitter follower, the emitter voltage follows the base voltage. Increasing the base bias increases the

emitter voltage and the emitter current through R2. This increases the collector current to the desired value.

Within limitations, the collector current is set solely by the base-bias voltage and the value of R2. These limitations are: The collector supply must be at least one volt more than the max-

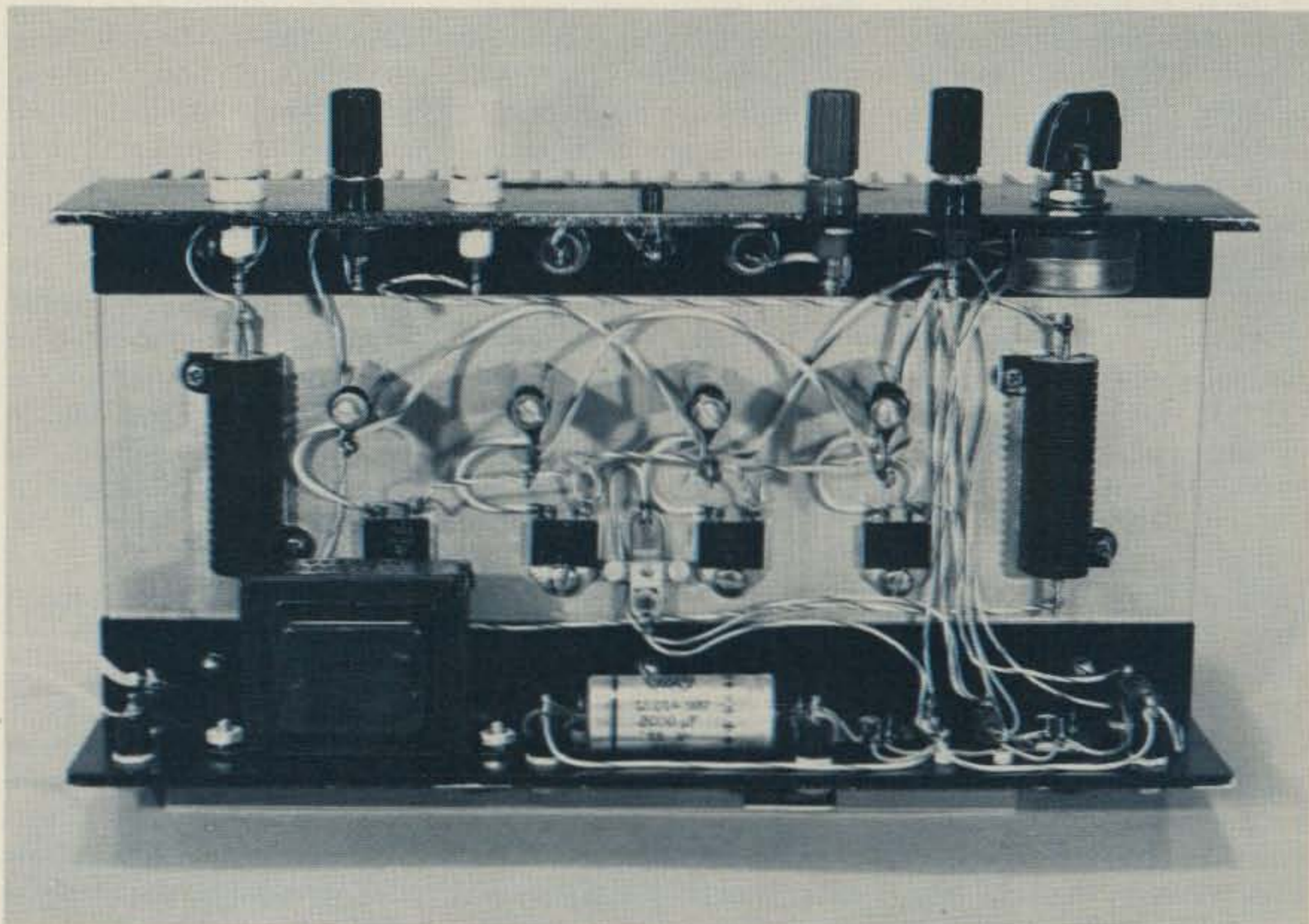

Photo B. Interior view of the Power Waster. Four TIP 35C load transistors are mounted to the heat sink. The thermal switch is located between the two center transistors. A U-shaped chassis is formed from the heat sink and two pieces of aluminum angle stock.

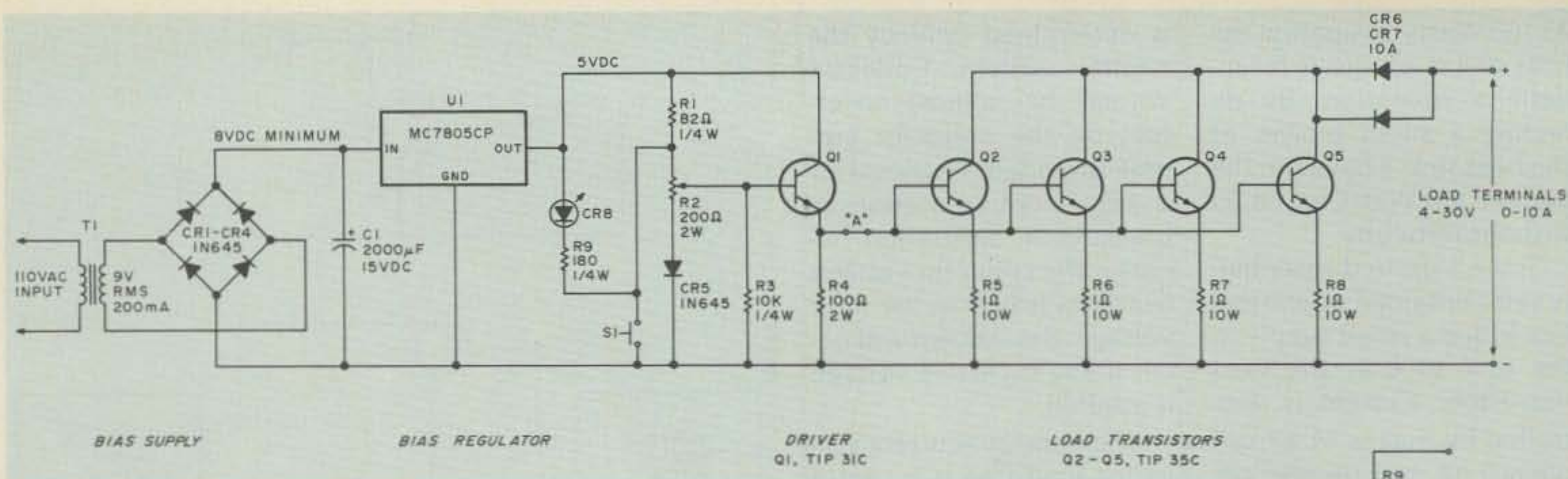

Fig. 2. Schematic of the Power Waster electronic load. S1 is a 75° C NO thermal switch. S1 is in thermal contact with the heat sink. The collectors of Q2-Q5 are connected directly to the sink. LED CR8 indicates thermal shutdown. Jumper at point A is opened in test.

imum base-bias voltage, and must be less than the transistor breakdown voltage for the current drawn.

In addition, it is assumed that the base-bias supply is capable of supplying increasing current to the transistor base as the collector current increases. The base current will be the transistor collector current divided by beta, the common emitter current gain. Beta will vary from 10-50 for practical power transistors.

To convert these ideas into the final design, I had only to add a base-bias supply, circuit overload, reverse polarity protection, and to increase the number of load transistors to handle the required power. The result is shown in the schematic diagram.

Power is dissipated in the pass element (consisting of Q2, Q3, Q4, and Q5 connected in parallel). Four TIP 35C transistors are used in order to safely handle the 10-Ampere maximum load current. Each pass transistor has a 1-Ohm resistor in the emitter which corresponds to R2 of Fig. 1. In addition to setting the collector current for a given base voltage, these resistors also equalize the load distribution between the four pass transistors and help to keep the load current constant as the transistor temperature increases.

Variable base-bias voltage for the load transistors is obtained from emitter follower Q1 which operates from a 5-volt regulated supply. This circuit consists of transformer T1, the bridge rectifier (CR1-CR4), C1, and an MC7805CP three-terminal regulator chip (U1).

The base of emitter follower Q1 is connected to a variable voltage divider consisting of R1, the pot (R2), and diode CR5. R1 and CR5 limit the driver base voltage range to approximately 0.8 to 4 volts. An additional 0.8-volt offset in the base-emitter junction of Q1 results in a driver output voltage range of 0 to 3.2 volts. Restricting the drive voltage to 3.2 V sets the maximum current the load will draw to 10 A. CR5 was included to compensate for the change in the base-to-emitter threshold voltage of Q1 as the temperature changes. In use, this simple bias supply has proven completely adequate. There is very little drift in load current as the temperature increases.

Some additional features are worthy of mention. Diodes CR6 and CR7 provide reverse polarity protection. A thermal switch (S1) shorts the base-bias supply and turns the current off if the heat-sink temperature becomes excessive. An over-tempera-

ture shutdown is indicated by illumination of the LED (CR8).

R4 provides a return path to the transistor emitters for collector-to-base leakage current. This assures that they will actually turn off when the base-bias voltage is removed. R3 is there for safety in case the wiper of R2 opens. This is the usual method of failure for pots. Inclusion of R3 assures a path from base to emitter for the collector-to-base leakage current of Q1. In its absence, failure of R2 could cause the load to pull more than 10 A and damage something. With R3 included, the circuit just shuts off.

A series-connected pair of 8-Ohm, 50-Watt resistors is also mounted on the heat sink of the electronic load. These are provided to increase the dissipation capability of the unit and, in addition, are handy for testing audio amplifiers.

Power Rating

While the nominal input capability of the Power Waster is 10 A at up to 30 V, it may be operated at higher voltages if the proper conditions for safe operation are understood. In this section, I will explain how the nominal power rating is derived.

All high-power transistors have a "safe area" of operation, in which no damage

will occur. Fig. 3 is a safe-area curve for a single TIP 35C. This is a plot of maximum-permitted collector current as a function of collector voltage. Operation at any point in the region below and to the left of the curve will not damage the transistor. Combinations of voltage and current above and to the right of the curve will certainly destroy the transistor.

It is interesting that the power dissipation capability is not constant. At a Vce of 5 V, a current of 25 A is permitted. That's 125 Watts. But if the voltage is increased to 50 volts, only 1 Ampere is allowed, providing a dissipation capability of only 50 Watts! The successful designer of high-power transistor circuits stares long and hard at the safe area curves before picking a final configuration!

When I designed the Power Waster, I tried to be conservative so that it could really take abuse without failure. Thus, four TIP 35C transistors were used. In Fig. 4, the composite safe-area curve for the four devices in parallel is shown. This is Curve B. Curve A indicates the "rated" operating envelope for the Power Waster. Only at the 10 A and 30 V point does the "rating" curve approach the safe-area curve.

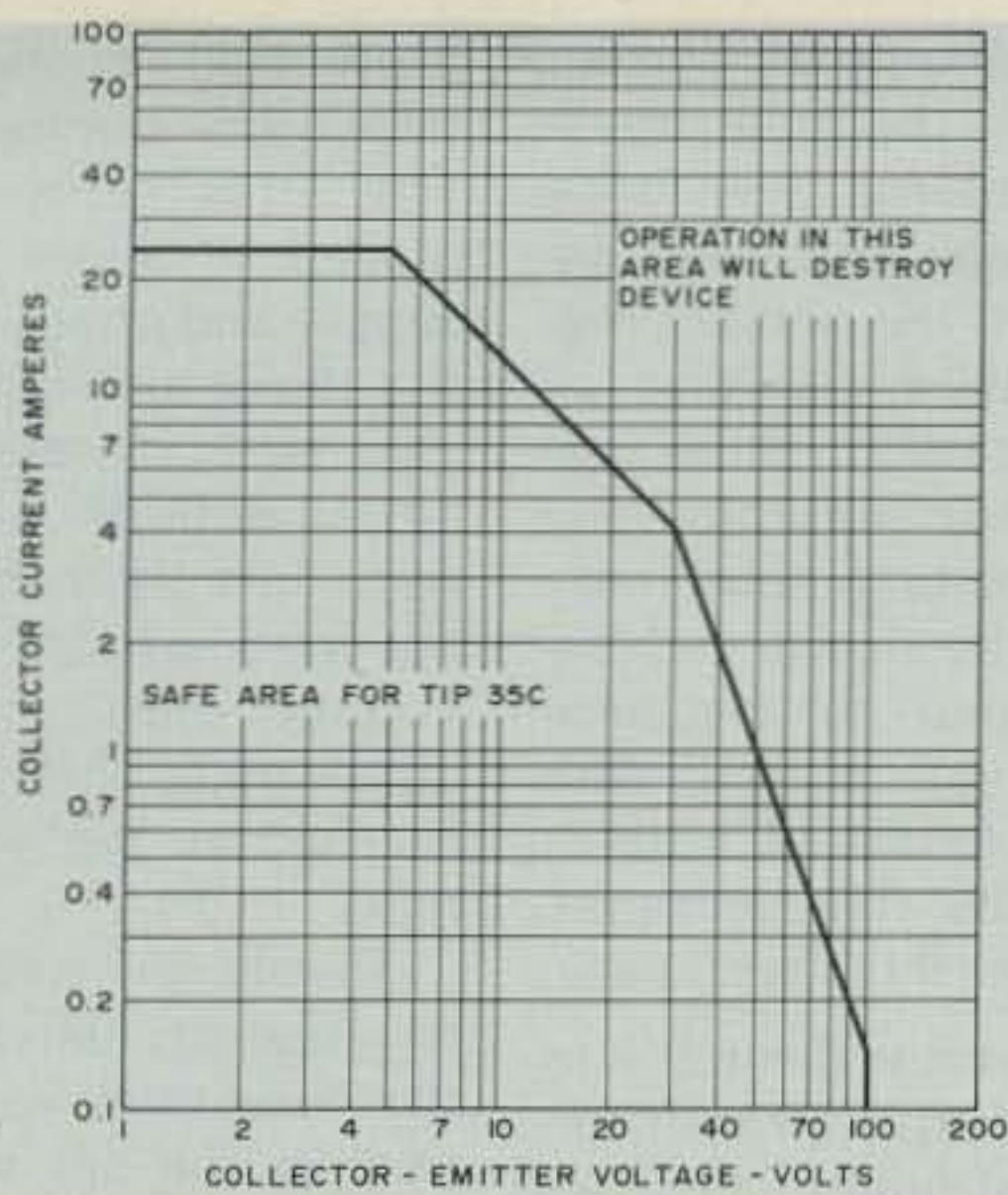

Fig. 3. Safe-area curve for TIP 35C. Safe operation is limited to the area below and to the left of the curve. Operation beyond the safe area will destroy the transistor.

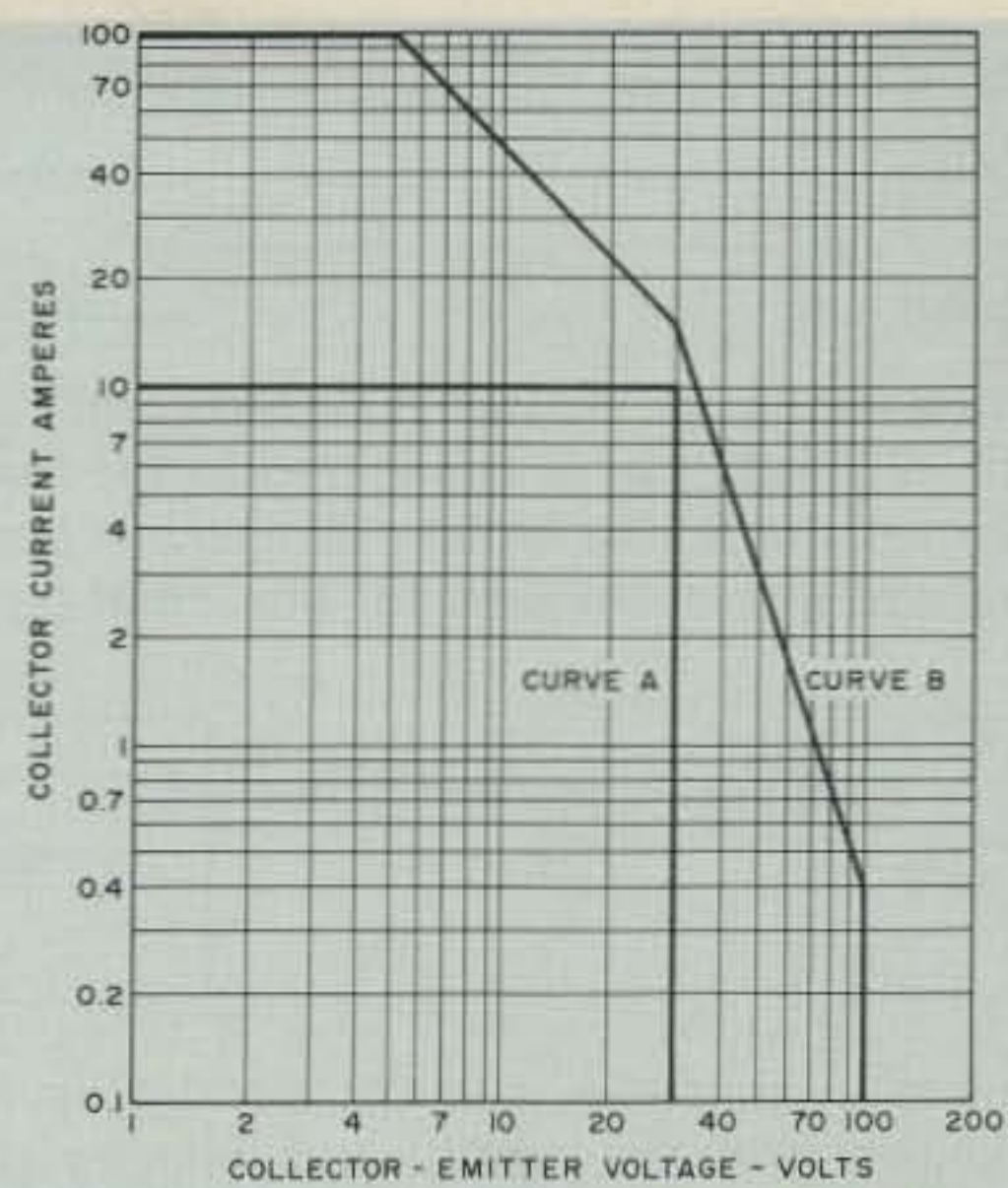

Fig. 4. Operating areas for the electronic load: Curve A indicates the rated operating area for the load. Curve B shows the composite safe area of the four TIP 35C transistors used as the load element. The rated operating area (Curve A) is well inside of the safe area.

At all other combinations of current and voltage, the power dissipation is comfortably inside of curve B.

This conservative design assures that the unit will never fail as long as the 10 A and 30 V maximums are observed.

Construction

Construction of the electronic load can take almost any form because of the non-critical nature of the circuit. In most cases, the shape of the heat sink will determine the final configuration. In order to dissipate 300 Watts, a sink having a thermal resistance of $0.1^{\circ}\text{C per Watt}$ is required. This is a truly massive piece of metal. I elected to depend upon thermal inertia to permit short tests of up to ten minutes duration and to let the thermal cutout act if things got too hot. Continuous operation is obtained by directing a small blower at the heat sink.

I used a $5'' \times 11''$ piece of heat-sink extrusion having 32 one-inch-high fins as a chassis. To this I fastened a pair of $0.75'' \times 2''$ pieces of angle to form a U-shaped chassis with the fins on top. All parts are mounted on the underside of the extrusion, and the front and rear panels are formed by the

pieces of angle. Vertical fins are more efficient, of course, but since a cooling fan is required to obtain the full power rating, this arrangement is quite convenient.

Parts located on the front panel include the three binding posts for the 8-Ohm resistors (R9 and R10). These are at the left end of the panel. Next is the LED over-temperature indicator. Adjacent to the LED are the input terminals for the electronic load. The load current adjustment pot, R2, is on the extreme right end of the panel.

Mounted directly to the underside of the heat sink are the two 8-Ohm resistors, the four emitter resistors for the load transistors, and transistors Q2 through Q5. The thermal switch (S1) is located in the center of the sink. Two reverse-polarity protection diodes (CR6 and CR7) are also mounted directly onto the heat sink near the center of the front panel. All parts are mounted to the sink by threaded holes tapped directly into the extrusion. The cathode ends of CR6 and CR7 are connected to the sink via threaded mounting holes. In the same way, the collectors of Q2-Q5 are screwed directly to the sink. Thus,

the connection from the polarity protection diodes to the transistor collectors is via the heat sink itself. Fastening the transistors to the sink without insulating wafers puts the entire chassis at the potential of the positive supply input.

Normally, I would have insulated the transistor collectors from the sink but there is a good reason for not doing so. The thermal impedance of the transistor junction to case is $1^{\circ}\text{C per Watt}$. Most insulating wafers have a thermal resistance of at least $0.5^{\circ}\text{C per Watt}$. If a wafer were used, the resistances are summed to yield a thermal resistance of $1.5^{\circ}\text{C per Watt}$. The junction temperature would rise by fifty percent! Instead, I elected to have the positive supply input on the sink and to exercise caution in using the unit. The low voltages involved certainly pose no shock hazard.

On the rear panel are located: the power transformer, bridge rectifier, filter capacitor, 5-volt regulator, and the driver transistor (Q1). The transformer is located at the left end of the rear panel. The filter capacitor is in the

center of the panel as is the bridge rectifier, which is hidden by the capacitor in the photograph. Adjacent to the filter capacitor is the 5-V regulator and the driver circuit components. U1 and Q1 are both fastened to the rear panel for cooling. All small parts such as resistors, capacitors, and diodes are mounted with push-in Teflon terminals. Threaded standoffs are used for the larger components.

Not everyone who wishes to build this circuit will be able to find a heat sink similar to the one I used. One approach is to use four smaller sinks and to mount a load transistor on each. A suitable configuration would use four Wakefield Engineering type NC-423 heat sinks. Individually, these units have a thermal resistance of $0.8^{\circ}\text{C per Watt}$ so the resistance of the combination would be $0.2^{\circ}\text{C per Watt}$. Such an arrangement would permit inputs of about 150 Watts without forced-air cooling.

Testing

A few simple tests prior to using the load will prevent damage to it, or to the circuit being tested. First, break the circuit between

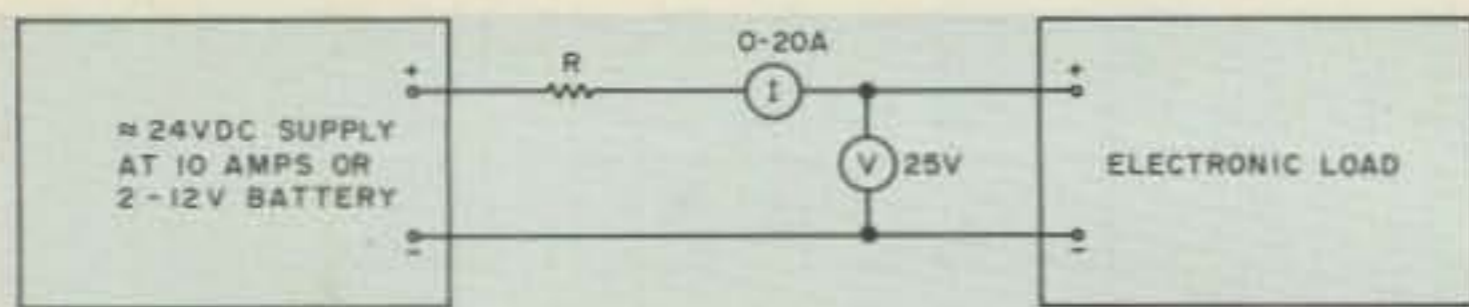

Fig. 5. Testing the Power Waster. A high-current supply such as a pair of 12-V batteries is connected to the load via current-limiting resistor R. The resistor should be chosen to limit the current to a few Amperes for the initial tests.

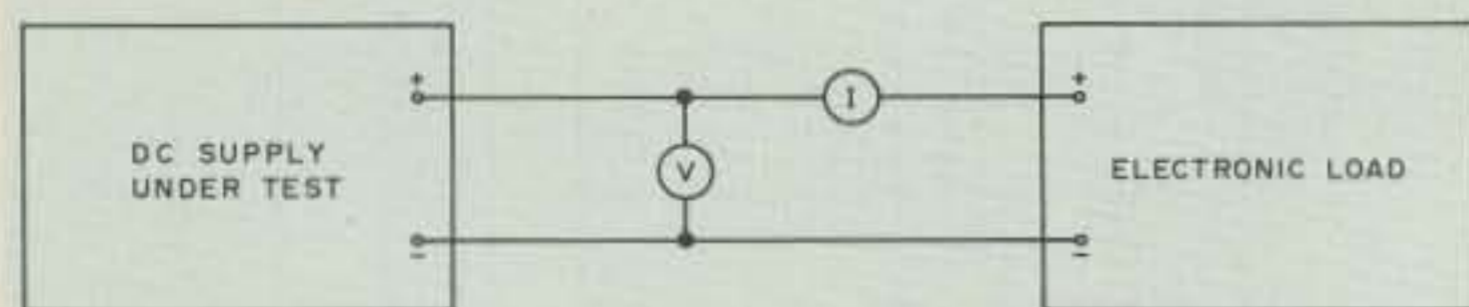

Fig. 6. Using the load to evaluate a power supply. Increasing current is drawn from the supply, and the regulator performance is measured. The load also may be used to ensure proper current-limiter operation.

the driver transistor (Q1) and the load transistors (Q2 through Q5), at point A in Fig. 2. Apply 110 V ac to the power transformer and verify that the voltage is variable from about 0 to 3.5 V as R2 is rotated. Zero volts should occur at the extreme counterclockwise position of R2. This is the zero current setting.

Reconnect the circuit at point A. Then arrange a high-current test setup similar to Fig. 5. Resistor R is chosen to limit the current to 3 or 4 A under short-circuit conditions. Two automobile headlamps in series may be used for this resistor. Set the current control pot (R2) at minimum (CCW position) and turn on the supply and the bias supply in the Power Waster.

Increase the current setting until 2 A is drawn by the load. Measure the voltage drop across R5 through R8 and assure yourself that the voltages are about equal. About 0.5 V should appear across each resistor for a 2-A load. If no voltage appears, then the associated transistor is not drawing any current.

Next, advance the current control. The load current should increase smoothly until the voltage at the load input terminals drops well below 5 V. At

this point the load transistors will saturate and the current will be set by resistor R.

The next step is to test the current-limiting feature to verify that the load current is limited to about 10 A. Reduce R in value so that for the supply voltage present under load, about 15 A may be drawn. Again increase the load current from zero with R2. The load should current limit at 9 to 11 A if the same parts values were used.

If all of the above tests were successful, the electronic load is ready for use.

Applications

My purpose in building the electronic load was to enable rapid test of power-supply circuits. The 10-A and 30-V input capability will suffice for almost the entire range of solid-state supplies found in amateur equipment. After I built the load, a number of other applications surfaced. Some of these are worthy of mention.

The performance of a voltage regulator is easily plotted by using the load, connected as indicated by Fig. 6. The regulator is connected to the load via an ammeter. A voltmeter is connected across the output of the supply. By in-

creasing the load current and noting the meter reading, the internal resistance of the regulator may be found, and the percent regulation as a function of load determined. If the supply has a current limiter, the current-limiting point may be found by slowly increasing the load current until the voltage drops. The smooth control of current afforded by the electronic load makes these tests easy.

At times it is desirable to know if a surplus transformer of questionable ancestry can meet a given requirement. Of particular concern is the "overhead" voltage requirement. This is the input voltage required to maintain a regulator in operation (at full load) subtracted from the output voltage.

Typical three-terminal regulators require a 3-volt overhead to function properly. If all circuit parameters are known, it is easy to determine if a certain transformer, rectifier, and filter capacitor will work. If junk-box parts are used, the calculation is often difficult or impossible. It takes only a few minutes to connect up the unregulated supply parts and apply the expected load current using the Power Waster. The unregulated voltage and ripple may be measured, and the suitability of the components determined.

Battery charging is another application. All batteries must be charged from a current source so the charging current is held constant as the battery terminal voltage increases. To use the load as a battery charger, simply connect it in series with a source having a voltage at least 4 V greater than the full-charge voltage of the battery. Then place the combination in series with the battery and dial up the desired charging current.

One final application is

protection of high-power transistors during tune-up. The electronic load is placed in series with the supply and programmed for the maximum current that you feel is safe for the amplifier under test. At currents less than the setting, the load saturates and the voltage drop across it is quite small. This is especially true at the lower currents.

Should the amplifier try to draw excessive current, the maximum will be limited to the set value. Response is very rapid. Current limiting occurs in about a microsecond and in the case, is much faster than a normal power-supply current limiter. So effective is this method of protection that I have built it into several solid-state transmitters.

Conclusion

Electronic loads are common in professional labs where power supplies are developed. Many are built from scratch, but also they are sold by commercial test equipment manufacturers. Such devices permit evaluation of supplies prior to connecting them to their intended (and often very expensive) loads.

In writing this article, I have attempted to describe the application and operation of a little-known but very useful piece of test equipment. While my Power Waster is certainly austere as compared with the professional units, it will definitely do the job. The basic design could be modified to include meters and an internal cooling fan. If this were done, the complete unit could be packaged in a well-ventilated box where the heat sinks would be better protected from accidental contact.

I welcome comments or questions from anyone wishing to either duplicate or modify the circuit. ■

144 REPEATERS 220

Now with courtesy
beep and beacon
capability.

New and Improved
Receiver
and Transmitter

OPTIONS
Duplexers
Basic auto patch
Matching cabinet
.0005% High
stability crystals

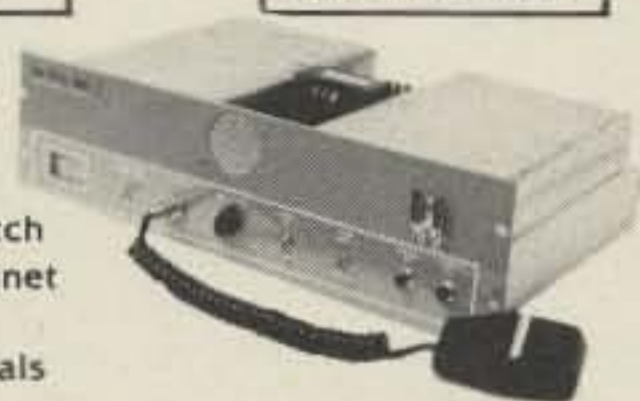

Hi Pro Mk I

144 or 220 MHz \$849.95



COR Identifier: All on one band, programmable, fully adjustable, time out (.5-7 min.), hang time (0-1 min.), identifier (1-10 min.), tone, speed, volume, L.E.D. outputs, low current drain, CMOS logic, plugs for easy installation and removal plus much more.

\$99.95

Basic Repeater \$649.95

2M 130-175 MHz/Basic Repeater for 2 meters with all the features of the Hi Pro Mk I less the power supply and front panel controls and accessories.

PA residents please add 6% tax.

Maggiore Electronic Laboratory

46 845 WESTTOWN RD.
WEST CHESTER, PA. 19380
PHONE 215 436-6051



Organize your shack with a CLUTTERFREE MODULAR CONSOLE \$179.95

- Large, 42" H x 57" W x 29"D
- Strong groove-construction
- Mar-resistant wood grain finish
- Options, drawers & face plate
- For ham or home computer
- Visa and Master Charge

CLUTTERFREE MODULAR CONSOLES

P.O. Box 5103 Tacoma, WA 98405
(206) 759-1611 89

MICROWAVE DOWNCONVERTER

Home Study Course

IDEAL FOR ANTENNA
EXPERIMENTS

COURSE INCLUDES:

- ASSEMBLED & TESTED DOWNCONVERTER (NOT A KIT)
- HOME STUDY MATERIAL, WITH MANY ANTENNA IDEAS
- BIBLIOGRAPHY OF SOURCE MATERIAL

\$79.95

MINN. RESIDENTS ADD 4% TAX

HMR

ASSOCIATES 392

PO BOX 11031

MPLS. MN. 55411

MODEL TR70A

ATV RECEIVING CONVERTER, 420-450 MHz



- TUNABLE—vernier tuned, 420 to 450 MHz
- HIGH PERFORMANCE—low noise RF preamp., mosfet mixer, mosfet IF amp. [Ch2 or 3 out]
- SELF-CONTAINED—including power supply
- 1 YEAR WARRANTY
- PRICE: \$ 88.00 [includes shipping. Add \$ 1.15 for COD shipment]

To order, or receive detailed information,
write us or call us at 1-812-336-4775

**APTRON
LABORATORIES** 8
PO BOX 323, BLOOMINGTON, INDIANA, 47402

SUNDAY, JANUARY 25, 1981 8 A.M.

Over the hills and through the snow
we, to the WHEATON HAMFEST go
... bargains and prizes and goodies, all sizes,
they always put out a great show!

WHEATON COMMUNITY RADIO AMATEURS

EXPANDED

94 .01/.61

\$2 Tickets

s.a.s.e. to WCRA

\$3 at Door

ARLINGTON PARK EXPO CENTER
ARLINGTON HEIGHTS, ILLINOIS

SPONSORED BY WCRA
BOX QSL WHEATON, IL
60187

GENERAL WB9PWM 312/629-3296
COMMERCIAL WB9TTE 312/766-1684

INFO

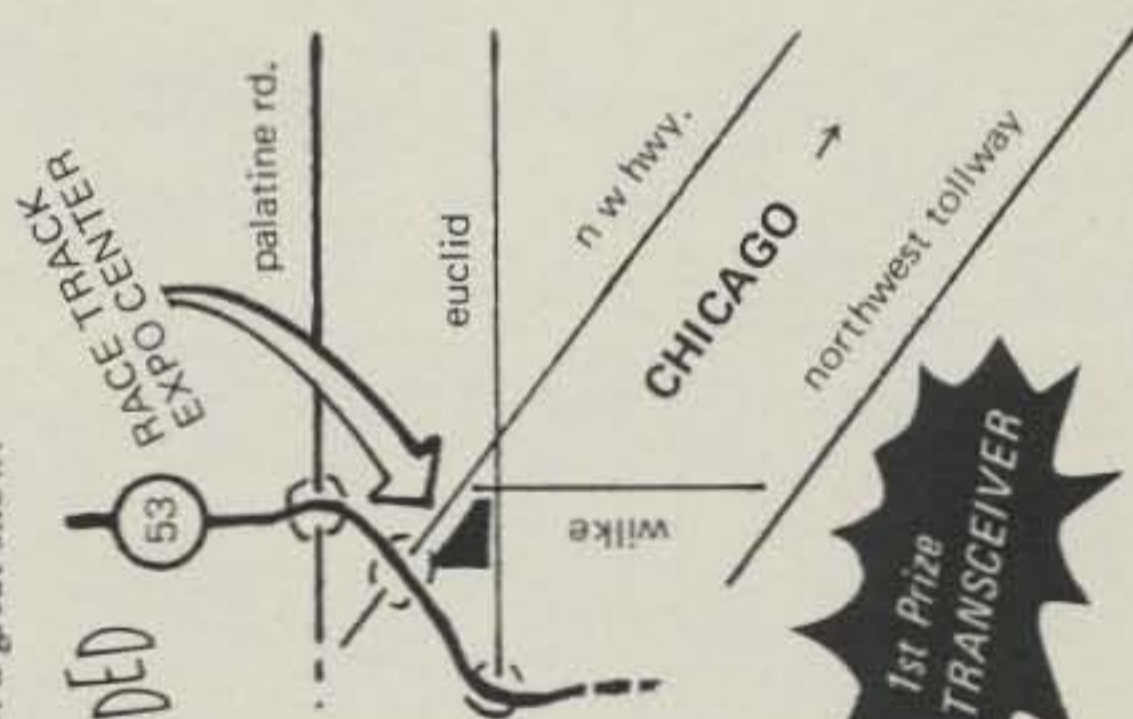

1st Prize
NEW TRANSCEIVER



QRZ Sunshine

— building solar-powered repeaters



Photo A. AARC repeater. Photovoltaic array is visible on the left side of the shack at the base of the tower.

A totally solar-powered repeater recently went on the air in Maryland. On March 15, 1980, the Anne Arundel Radio Club (AARC) switched from 110 V ac to sunshine to power a new 220-MHz repeater recently installed at the AARC site in Davidsonville, Maryland, near Annapolis. This unique microprocessor-controlled repeater will itself be the topic of a forthcoming article, as soon as its builders get around to writing it up.

The Site

The repeater is located at an abandoned Nike missile site which was provided to AARC by the local Davidsonville Family Recreation Center. A ready-made clubhouse and a 10m-high structure (former radar pedestal) at one of the highest points in the area offer an ideal location for this active and public-service-oriented amateur radio club. A 3m × 3m repeater shack was built atop the pedestal and a 40m antenna tower was added. At the present time, the club operates both a 2-meter repeater (147.105/147.705) and the 220-MHz

repeater (223.88/222.28) and is planning to install a 430-MHz ATV repeater in the near future.

The repeaters offer reliable and convenient communications within the Washington, Baltimore, Annapolis, and central Chesapeake Bay area. Many of the club members are avid boaters, and during the boating season maintain a weekend weather net which also provides real-time information to the National Weather Service about the rapidly changing weather conditions on the Bay.

Photovoltaics

Photovoltaic (PV) panels, which convert sunlight into electricity, were provided by the Department of Energy in response to a request from the AARC in December, 1979. The panels were shipped to the club on loan from the Jet Propulsion Lab in Pasadena, California, in late February, 1980. (Who says government can't react quickly?) The PVs were part of a DoE research-and-development program to improve PV technology and reduce production costs.

The PV array consists of 14 individual panels, made by Sensor Technology Corp., each about .3m x .6m x .03m, attached to a 1.3m x 2.3m frame made of pressure-treated lumber. The frame is fastened directly to the south side of the repeater shack at a 53° angle (from the horizontal) which will optimize electric generation during the winter. Each panel is rated about 18 V at 0.55 A, and with the panels connected in parallel, the array was expected to produce about 18 V at 8 A (at noon on a sunny day).

Output voltage for this particular panel is somewhat temperature-sensitive, but at a constant temperature, it is fairly independent of current draw up to the rated current, whereafter it falls very rapidly to a maximum short-circuit value of 0.62 A per panel. A check of our 14-panel array showed a maximum short-circuit current of 8.7 A. Even on a very cloudy day, the array produces about 0.5 A, which is more than adequate to provide the repeater's standby current draw of around 300 mA.

The 14-panel array is expected to produce almost 400 Watt-hours during an average December day, while in June it should be almost twice that amount. The array converts only about 6 percent of the sunlight falling on it into electric energy (actually the individual cells are about 10-percent efficient, but there is considerable open area between each cell in the panel). This should be sufficient power to run the repeater without auxiliary power, year-round, hopefully for the next 10 years, the panel service-life design goal.

Power Conditioning and Storage

Since the repeater requires 12 V dc around-the-



Photo B. Photovoltaic array. Frank Troutman WB3CLF helped install the array on the side of the shack.

clock, and the array produces 18 to 25+ V dc for only part of the 24-hour cycle, some sort of power-conditioning and energy-storage system is needed. A simple system was designed to provide high reliability and efficiency at a low cost. It consists of a 16 V (13-cell, 20-Ah) primary nicad battery storage module, charged directly by the PV array through an overcharge protector. A 12-volt (60-Ah) secondary-storage auto battery is diode-isolated from, and trickle-charged by, the nicad battery.

A clock attached to the transmitter measured an average daily transmit time of about two hours. At a transmit current of 3 A, the average daily transmit power is 6 Ah, and at the .3 A standby level, another 7 Ah is consumed. Thus, the total average daily power consumption is around 13 Ah at 12 V dc (156 Wh/day). While the array output of 400 Wh would appear to be more than sufficient to power the repeater, there

are major energy losses built into the system which must be taken into account.

Batteries are less than 100-percent efficient, and the trickle-charge circuit dissipates an appreciable amount of energy. If we assume an average battery efficiency of 80 percent and a trickle-charge rate of 700 mA, we end up with only about 170 Wh being delivered to the repeater, which just slightly exceeds its anticipated demand of 156 Wh/day. It must be remembered that this was calculated for the worst part of the year (December), and in any event, the fully-charged 12-V battery should have enough capacity to run the repeater for at least four consecutive cloudy days.

During the design and testing of the power-conditioning and storage equipment, it was found that current and comprehensive technical information on lead-acid and nicad batteries was very difficult to obtain. Building a battery-charging circuit may

appear at first to be a simple task. But to build one that does not damage the battery, seriously degrade its performance, or doom it to an early death is not really as straightforward as one might expect.

An excellent handbook has just become available on this topic entitled *Handbook for Battery Storage in Photovoltaic Power Systems*, February, 1980. The 120-page handbook was prepared for the Department of Energy by Bechtel National, Inc., and contains a wealth of engineering data on most types of rechargeable batteries. It includes a section on advanced batteries now under development primarily for electric vehicle applications. The handbook is well-referenced and includes an extensive listing of battery manufacturers, suppliers, and developers. A limited number of copies are available at \$9.95 (including handling and postage) from: Moonraker East, Publications Department, Box 117, Riva MD 21140.

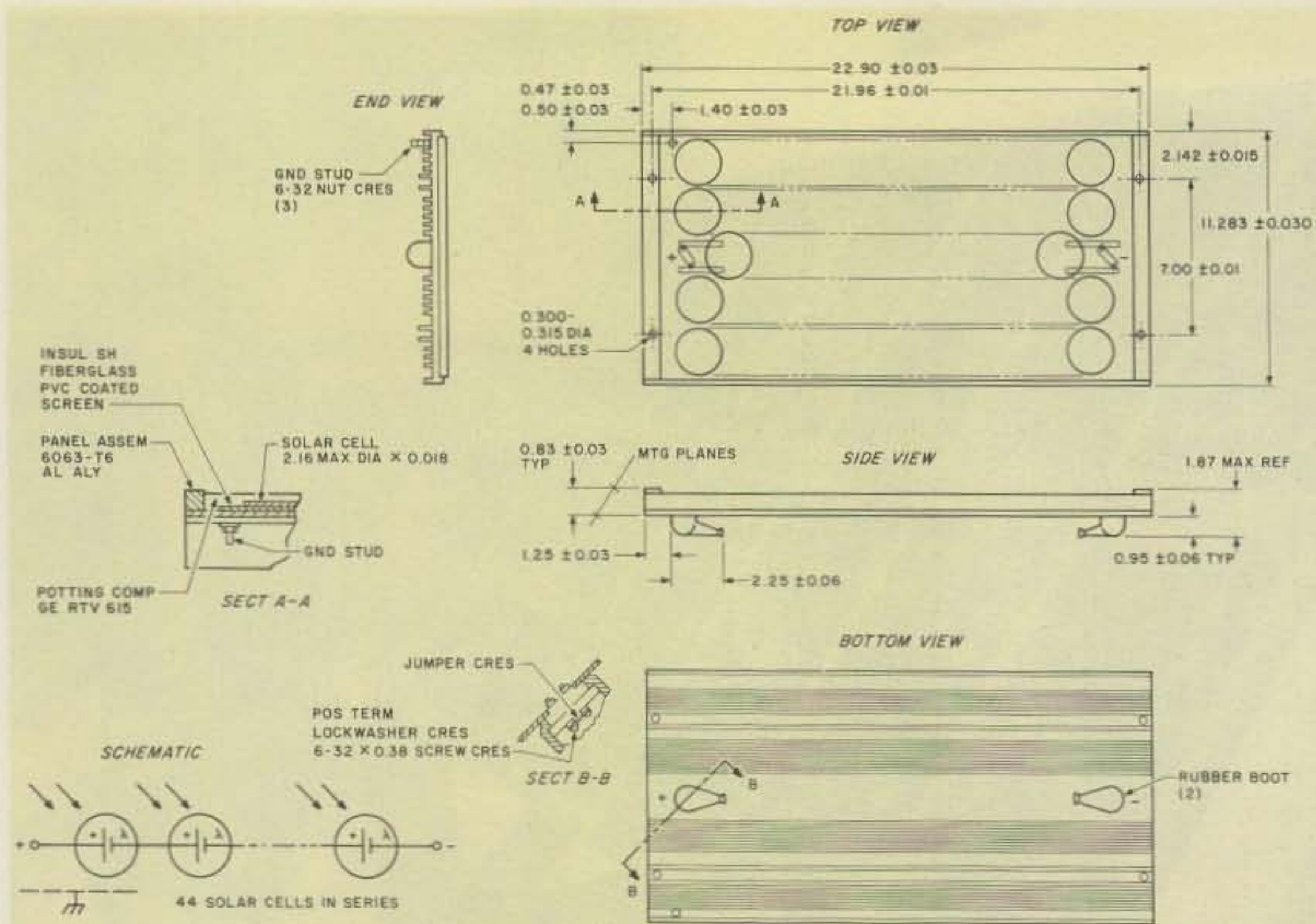

Fig. 1. Diagrams of PV module.

Design Considerations

A simple constant-voltage charging circuit was considered, which would have eliminated the need for the 16-V nicad battery by connecting the PV array directly to the 12-V auto battery through a regulator. While the overall efficiency might have been slightly better, the design was rejected for several reasons:

1) The lead-acid auto battery would discharge continuously at night due to the power demands of the repeater, with the terminal voltage falling to about 11.5 V by dawn. The PV array would then start to charge the battery with currents rapidly increasing to almost 9 Amps and, as the battery attained full charge, its terminal voltage would climb to about 15 V. This wide swing in supply voltage was not considered conducive to stable repeater operation, or to extended battery life.

2) Nicad batteries are much better suited for repeated charge/discharge

cycling and are far more resistant to damage from overcharging.

3) The two-battery circuit provides an almost constant supply voltage to the repeater by continuously trickle-charging the lead-acid battery around the clock, not just when the sun is out.

4) The two-battery circuit design appears to be much more fail-safe in that a regulator failure would not cook the lead-acid battery, as it could in the simple circuit. Component failure in the two-battery circuit likely would result in a decrease in repeater performance noticeable over a period of days, allowing time to correct the problem rather than resulting in a sudden complete repeater failure.

This last consideration is an important factor in the operation of our repeaters, since routine inspection of the system is limited by the requirement that someone must climb the 10m structure, and thus periods of unattended operation of a month or more are expected. But this is all just theory

and we should know much more about the reliability of our solar-powered repeater in a year or so.

PVs: Current Technology and Future Potential

The principle of the photovoltaic effect was discovered by Edmond Becquerel back in 1893, but useful energy conversion devices have been available only for the last 25 years. An early PV application was in photographic exposure meters. The first breakthrough in PV cell manufacture for electric power generation was made by researchers working at Bell Laboratories in 1954. Subsequently, high-reliability single-crystal silicon PVs were used as an energy source for U.S. and Russian space vehicles throughout the 1960s. A few terrestrial PV devices were marketed on a trial basis as early as 1959 using silicon cells rejected by the space program as not meeting NASA's high-reliability requirements, but the first PVs designed specifically for terrestrial use were not produced until 1973. Thus,

we are dealing with a very new product only recently available in the marketplace, and it is probable that PV applications will grow rapidly in the coming years, especially if anticipated tenfold PV cost reductions can be achieved.

Photovoltaic cells have much in common with transistors and utilize semiconductor technology to convert light into electricity. They consist of a junction of semiconducting material formed by one of three methods: (1) adding impurities (dopants) to one side of a pure material (homojunction); (2) joining two dissimilar semiconductor materials (heterojunction); (3) joining a semiconductor to a metal (Schottky junction).

The combination of materials creates a potential difference across the junction, with the materials on each side of the barrier having different electrical characteristics. One side has excess negative charges and is called n-material, while the other side has excess positive charges and is called p-material. Absorption of light in the semiconductor energizes the negative and positive charges and creates an electrical current when the absorbed energy is greater than the material's energy bandgap.

Fundamental restrictions of quantum physics limit the portion of the sun's spectrum which can be utilized by solar cells and the efficiencies which are achievable. Thus, each different cell design has a unique performance characteristic across the spectrum of sunlight from ultraviolet to infrared. Light with energy below the material's bandgap is insufficient to generate a current; light with energy above the bandgap produces energy equal to the bandgap, with excess energy resulting in heat which must be dis-

sipated. The direct-current electricity that is produced is collected by a contact grid imprinted on the surface of the cell.

The capability to control the energy bandgap and the electrical characteristics of the materials on each side of the barrier is fundamental to the science and art of photovoltaic cell design. Particularly for terrestrial photovoltaics, the technical problem is to construct and control these sophisticated material characteristics in a mass-production process.

Manufacturing of the cell, or a module (panel) of cells, is complete when anti-reflection coatings and protective encapsulants are applied. Single-layer anti-reflection coatings can reduce average reflective losses from 40 percent to as little as 10 percent, and double-layer coatings can further reduce reflective losses to about three percent. Glass, plastic, or silicone encapsulants seal the panel of cells against environmental elements and are a key factor in determining the useful life of the cells. The output of a terrestrial solar cell in peak Watts (Wp) depends on the daily insolation in each location.

On a clear day, the sun's energy reaches the Earth at a rate of about one kilowatt per square meter. This is equivalent to the energy contained in a gallon of gasoline for every 10 minutes the sun shines on an area the size of a tennis court. Even with the low efficiency of today's solar cells (say, 10%), 60 square meters of cells with adequate storage under optimum conditions can provide the needs of an average single-family residence (6 kWp, 700 kWh per month). Unfortunately, such an installation would be far too expensive for an average homeowner. For

example, at a PV module price of \$10/Wp, the cost would amount to \$60,000 just for the PVs, and the installation, energy storage, and power conditioning equipment would be extra.

That is precisely why the Department of Energy is spending over a billion dollars on a 10-year program to develop the technology and production techniques needed to reduce the cost of PVs to \$.50-\$1.00/Wp by 1986. By then, utility electric rates will be considerably higher and PVs should be able to compete on a sound economic basis. But what are DoE's chances of pulling this off, you might ask? Of course, no one really knows, but DoE is fairly confident that the price goal can be achieved. So much is happening in the PV field (advances in competing cell materials such as silicon, cadmium sulfide, gallium arsenide, encapsulation improvements, better and lower-cost manufacturing techniques being developed) that it is just too early to attempt to select the best technology/manufacturing mix. The next few years may bring several major breakthroughs in PV material technology providing lower-cost cells and in developing cells with much higher efficiencies.

One particularly promising avenue of PV research involves the use of lenses or reflectors to concentrate the light striking the PVs. Concentrations equivalent to many thousands of suns have been tried with very encouraging results. A recent breakthrough was achieved with one type which is called a thermophotovoltaic cell, which reached an efficiency of 26 percent. This particular device utilizes concentrating mirrors to focus the light on a spectral converter which absorbs the

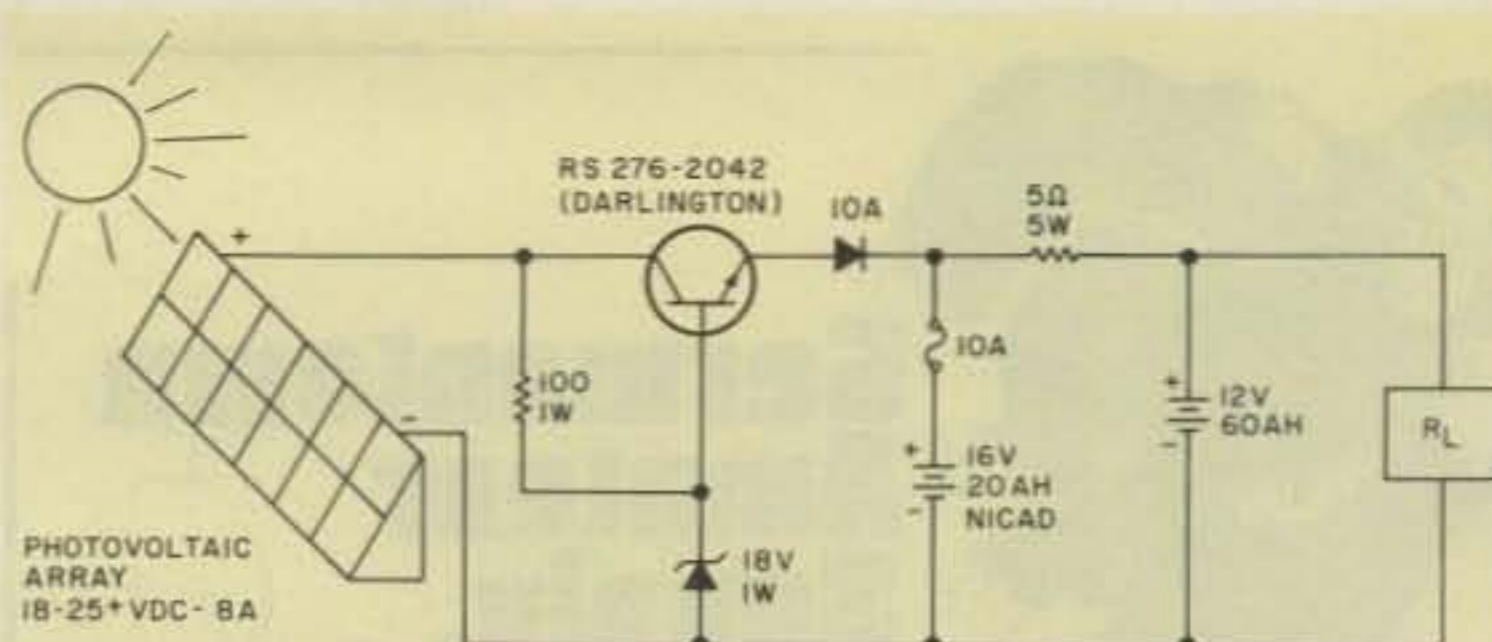

Fig. 2. Power conditioning and storage circuit.

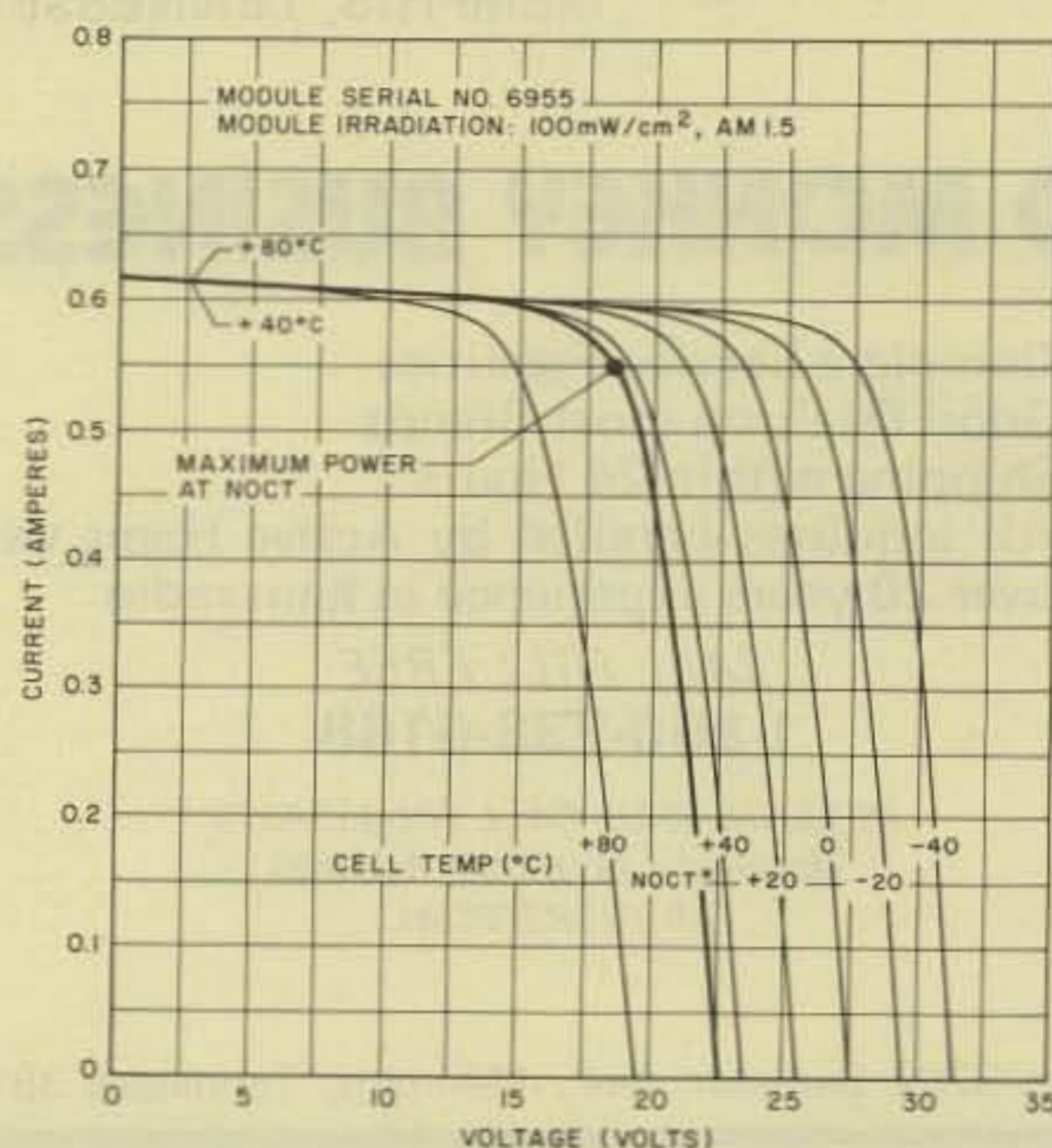

Fig. 3. Specifications of photovoltaic array.

full spectrum of sunlight, then reradiates the energy at specific wavelengths which match the optimum operating bandgap of the cell. Ultimately, 30- to 50-percent efficiencies are expected.

Much of the R-&D effort on concentrating PVs has been privately supported, and it is still too early to tell just how much of a competitor they will be to flat-plate non-concentrating options. But the overall trend is plain; the immense potential of PVs is no longer just theoretical, and the question now appears to be one more appropriately stated in terms of how long will it take PVs to capture a significant market share.

Photovoltaics and Repeaters

The use of PVs to power amateur repeaters provides us with new opportunities

to locate our repeaters at sites which offer better coverage, but which otherwise may not be usable because of a lack of electricity. PVs with battery storage also provide a much greater degree of communications reliability during local emergencies accompanied by commercial power outages (as is often the case). Although many repeater clubs are equipped with auxiliary generators, it is often not easy to find a member who is willing (or able) to hurry over to the repeater site in the middle of a flood or blizzard, start up the generator, and keep it running during an extended power outage.

At the present time, high cost is one of the major problems hindering use of PVs by amateurs. Eventually, prices will come down, but it will take a number of



Germantown Amateur Supply, Inc.

MEMPHIS, TENNESSEE



NO MONKEY BUSINESS!

- (A) Complete Service Facilities
- (B) Good Deals on most Brands
- (C) Shipping within 24 Hours
- (D) All inquiries handled by Active Hams with over 20 years experience in ham radio

CALL TOLL FREE
1-800-238-6168

IN TENNESSEE, CALL 901-452-4276
MONDAY - SATURDAY 8:30-5:30
FOR YOUR SPECIAL.

Write: 3202 Summer Ave., Memphis, Tennessee 38112

STOP RF SPILLOVER!

You may be losing up to half the available output from your vertical gain antenna because of RF spillover. The amazing AEA Isopole with unique decoupling design, virtually eliminates RF spillover and can help you multiply your power in all directions on the horizon relative to an ideal half-wave dipole, or end-fed non-decoupled "gain" antennas.

Henry Radio

New Toll Free Order Number:
(800) 421-6631

2050 S. Bundy Dr., Los Angeles CA 90025
213/477-6701

931 N. Euclid, Anaheim, CA 92801
714/772-9200

AEA Brings you the Breakthrough!



years, and in the meantime our repeaters will remain dependent on external power. This is a situation where a little creative groundwork could be of great service to amateur radio. Here's how: The Congress is very anxious to accelerate the commercialization of PVs and for the past few years has appropriated millions of dollars over and above agency requests with the intent of stimulating PV manufacture and use. But it is not always easy for the administration to effectively utilize all of the funds; hence, most deserving PV projects have been welcomed with open arms.

Amateur radio spokesmen could approach the newly-created Federal Emergency Management Administration with a proposal to solar-power a number of repeaters

throughout the country, to strengthen the nation's emergency preparedness. The Federal Emergency Management Administration, in cooperation with the Department of Energy, might provide the PVs at no cost to repeater clubs as part of the PV accelerated commercialization program. The whole program could be coordinated at the user end by the ARRL.

The federal cost of a program to solar-power 1000 repeaters based on today's PV prices and a collector system similar to ours would be less than \$5 million. This is a pretty small part of a billion-dollar PV program budget, and not only that, the real benefit the nation would gain from such a program would far outweigh its very modest cost. So how about it, ARRL, is anybody there in Newington listening? ■

★ YOU ASKED FOR IT ★

A COMPLETE REPEATER STARRING THE MARK 3C SUPERCONTROLLER

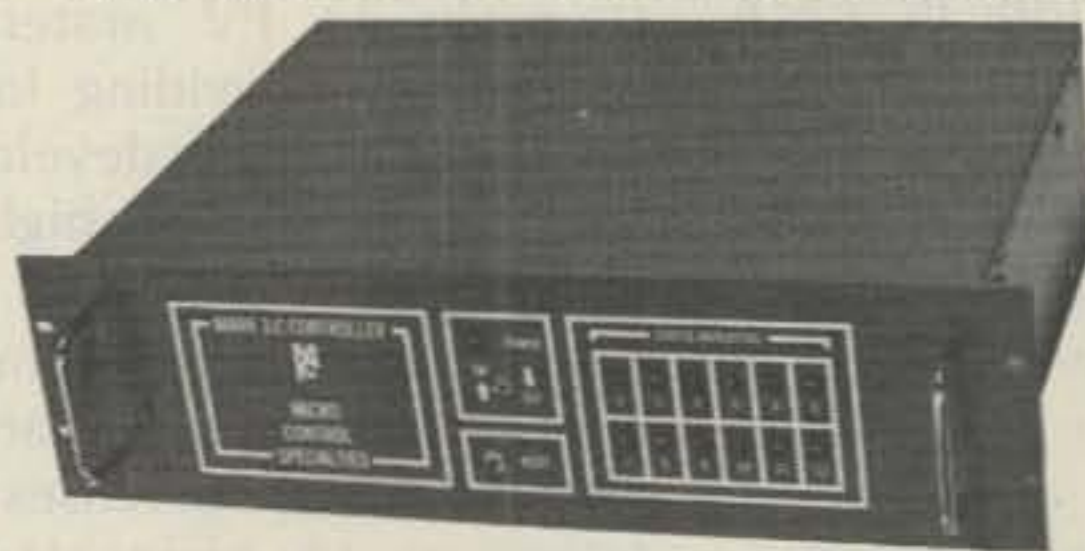

ALL the unique features which make Mark 3C the acclaimed leader in repeater control —

- Autopatch
- Reverse patch
- Autodial
- 40 Functions
- 13 Morse messages
- Custom tail messages
- Digital tone decoding
- Microprocessor control

MARK 3-C CONTROLLER \$995.

AND NOW, even the repeater is built in —

- Receiver sens. 0.25 UV
- Super crisp audio
- Transmitter output 2W

PLUS options —

- Power amplifiers (pick your level)
- Sub-audible tone
- Control receivers

MARK 3CR REPEATER
144-220 \$1595.

Call or write for specifications

MICRO CONTROL SPECIALITIES (617) 372-3442
23 Elm Park, Groveland, Ma. 01834

✓49

FREE!
RADIO AMATEURS
WORLD ATLAS
 with purchase of famous
CALLBOOK
MAP LIBRARY!

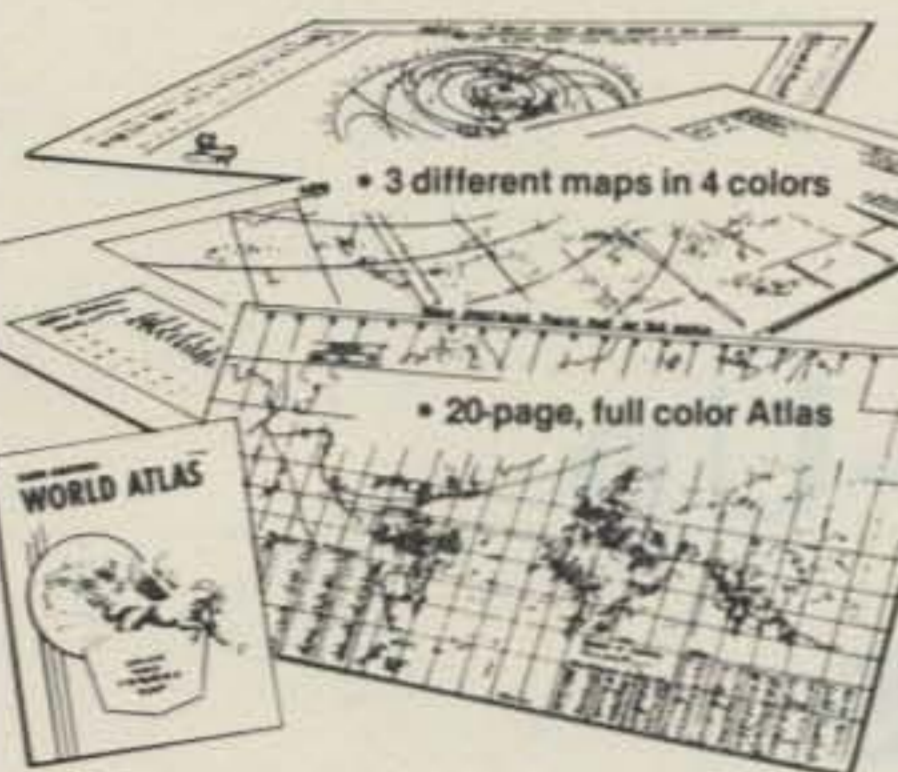

Here's an offer you can't refuse! You receive three, information-packed, Amateur Callbook maps, folded, plus the World Atlas for only \$4.50 plus \$1.50 shipping and handling. If purchased separately, total value of map/atlas offer would be \$7.50 plus shipping. You save \$3.00 and get these invaluable radio amateur aids!

- 1. Prefix Map of the World, folded.**
 World-wide prefixes. Shows 40-zone map on one side, 90-zone map on the other. Size 40" x 28"
- 2. Map of North America, folded.**
 Includes Central America and Caribbean to the Equator. Shows call areas, zone boundaries, prefixes, etc. Size 30" x 25"
- 3. Great Circle Chart of World, folded**
 Centered on 40°N, 100°W. Shows cities, latitude, longitude, great circle bearings and more! Size 30" x 25"

Plus special FREE bonus!
 The Callbook's own **Radio Amateur World Atlas**, **FREE** with the purchase of the 3 maps. Contains eleven full color maps of the world, looking at things from the radio amateurs point of view.

Callbook Map Library	\$4.50
Shipping	1.50
Total	\$6.00



Special Offer!
Amateur Radio
Emblem Patch
only \$2.50 prepaid

Pegasus on blue field, red lettering. 3" wide x 3" high. Great on jackets and caps. Sorry, no call letters.

ORDER TODAY!

Order from your favorite electronics dealer or direct from the publisher. All direct orders add \$1.50 for shipping. Illinois residents add 5% Sales Tax.

RADIO AMATEUR
callbook INC. ✓61
 Dept. BN
 925 Sherwood Drive
 Lake Bluff, ILL 60044

Handie
MORE POWER TO YOU!



✓40

KLM's NEW MA-35BL
Power Amplifier
 35W out, Preamp, Nicad Charger!

KLM, P. O. Box 816, Morgan Hill, CA 95037

Goodies from GALACTIC

Specialty Programs for
TRS-80 Model I - II - III

EDAS 4.0 (Editor/Assembler)

This is the highly acclaimed "USER ORIENTED" Assembler for the TRS-80 Model II by GALACTIC. Loaded with features such as assemble to memory, block move, link to debugger, default file naming, reverse video editing, warm start entry and much more. Now the programmer can write, assemble, test, and debug his code without ever leaving EDAS.

EDAS 4.0 with complete manual (120 pages)
 Model II Version Was \$229.00
NOW ONLY \$179.00

MASS/MAIL SYSTEM

This is the NAME and ADDRESS system for subscription control or large mailing lists. It will handle up to 10,500 records, with a worst access time of less than 15 seconds and usual access of less than one second. All adds, deletes, and edits are instant for the operator and are then completed later in a "batch monitor". Extensive documentation and ongoing support. Requires TRS-80 Model II and 2 disk drives minimum. Contact GALACTIC direct for detailed specifications and prices for your exact needs.

Model II Version Contact GALACTIC for Price

STOCK MARKET MONITOR

This day to day market monitor is designed for the active trader. The system will track the performance of an issue against the market as well as against itself. The package comes with complete documentation and explanations of the formulas that are used by the program. The system is available for the Model I and the Model III TRS-80.

Model I and III cassette version \$89.00
 Model I and III disk version \$99.00

INVENTORY MASTER

Tired of being a slave to an out-of-control inventory? Let GALACTIC'S INVENTORY MASTER put you in control of your inventory. INVENTORY MASTER operates on a TRS-80 Model I and Model III 48K disk system (Minimum of 2 drives with capabilities of up to 4 drives). Drive spanning capabilities allow you to track 2700 inventory items with a 4 drive system (5100 items for the Model III). Unique machine language sort allows for instantaneous item insertion (approx. 15 seconds with 2700 items in system). Item access can be immediate using system-supplied control numbers. Modeled after a proven main-frame system costing tens of thousands of dollars. Complete add/edit/delete capabilities supported. Placement of orders can be machine-generated as well as user-generated, with editing capabilities. Full report-generator included. Exquisitely documented.

Model I Version \$159.00
 Model III Version \$259.00

MODEL II HOST I/O SYSTEM

From the original author of the TRS-80 HOST and TERM systems in the RADIO SHACK "COMMUNICATIONS PACKAGE". This system allows the full control of the HOST facility by your BASIC program. Set the number of nulls to be sent after a C/R, set a command line to be executed if carrier is lost, turn HOST on and off, switch to channel A or B as desired, enable and disable the ability for the remote terminal to "BREAK" BASIC, identify whether a character came from the HOST'S keyboard or from the REMOTE'S and more. No knowledge of assembler needed. All options may be accessed from BASIC or ASSEMBLER. Complete with detailed documentation. Don't isolate your Model II, Let outside terminals access it's computing power.

Model II with TRSDOS 1.2 \$179.00
 Model II with TRSDOS 2.0 \$199.00

MAIL/FILE SYSTEM

This is the name, address, phone number data base manager that has set the standard by which other systems are compared. This system contains advanced editing and output capabilities. The TRS-80 Model I system will handle up to 600 records per file, while the Model III version will handle up to 1150 records and the Model II will handle 2500 records per file. All versions are file compatible and maintain constant sort indexes on both NAME and ZIP CODE. International PHONE numbers and ZIP CODES are supported. Thousands of code combinations are available. The Model II version also has a "word processor" type input editor and fast assembler sorting. Complete documentation is included with each version of MAIL/FILE.

Model I Version \$ 99.00
 Model III Version \$149.00
 Model II Version \$199.00

ULTRA TREK

This is an all new concept for this type of game, and compares to the others like chess compares to checkers. ULTRA-TREK is a complex, logical game, intended for the serious contestant. It is doubtful that you will ever master this game, but you will certainly enjoy trying! This program requires a TRS-80 Level II, 16K or more. The program is written totally in BASIC and uses 15.5K of RAM.

Model I & Model III Version
 (cassette only) \$14.95
 ✓390

galactic software ltd.

A Division of GS & WS, Inc.
 11520 N. Port Washington Rd.
 Mequon, Wisconsin 53092
 (414) 241-8030

Money Orders & COD's Shipped Within 24 Hours. Checks allow 2 weeks.

Transmitter Tune-Up for Blind Hams

— an audible indicator for power out

James D. Burney WA4LBX
42 E. Lakeside Drive
Florence AL 35630

Blind hams have used a variety of devices to tune their transmitters, with the conversion of visual indications to audio tones be-

ing the most common approach. A blind friend, W5KUY, recently asked me to build a coupler to insert in his coax to sample the rf

voltage. This voltage would be used to drive a voltage-to-frequency converter. After looking at his converter with its three transistors and two transformers, I decided to build a more up-to-date version to go with the new coupler.

The audible tuning aid described in this article operates on the assumption that maximum power trans-

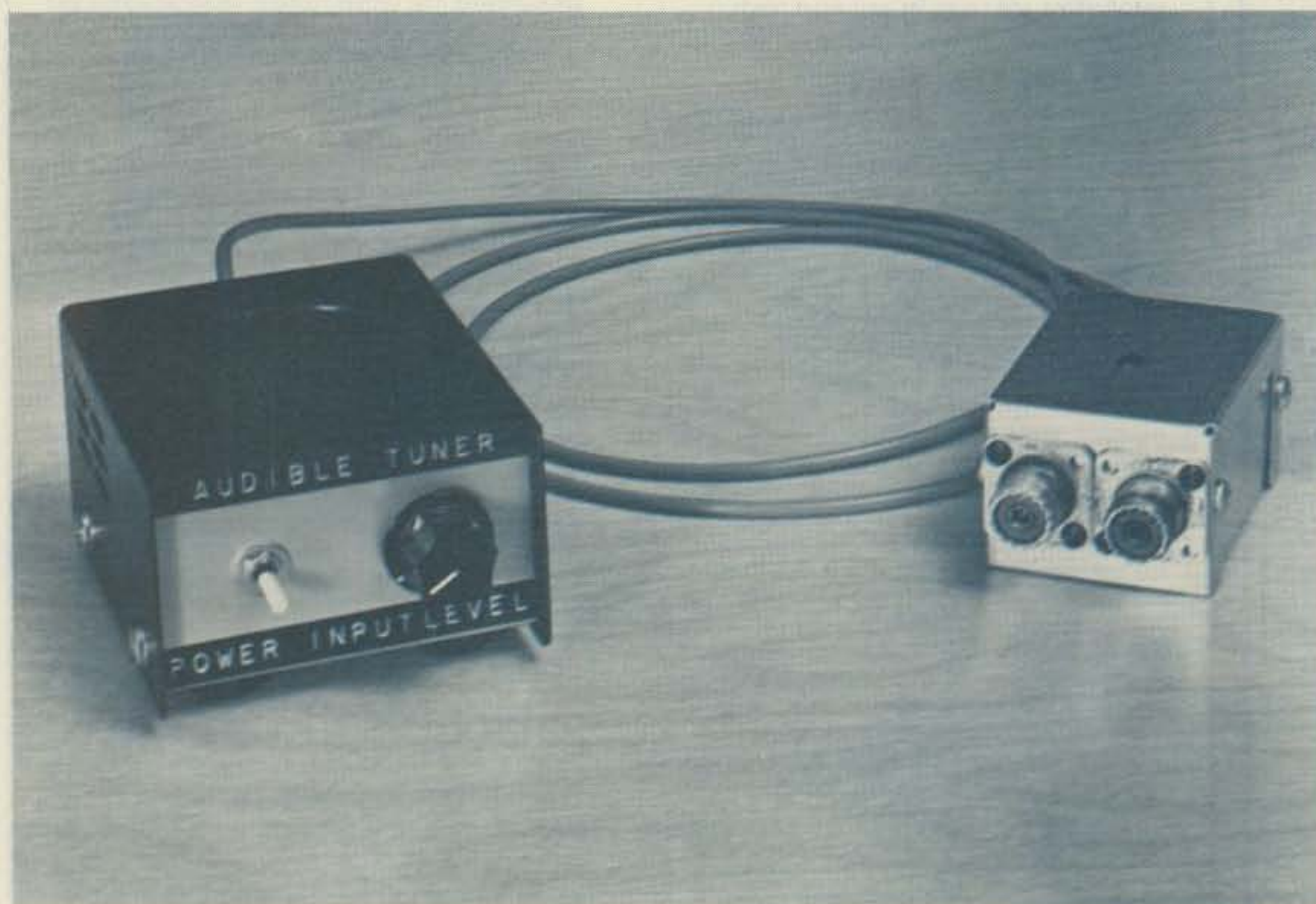

Photo A. Complete audible tuning aid.

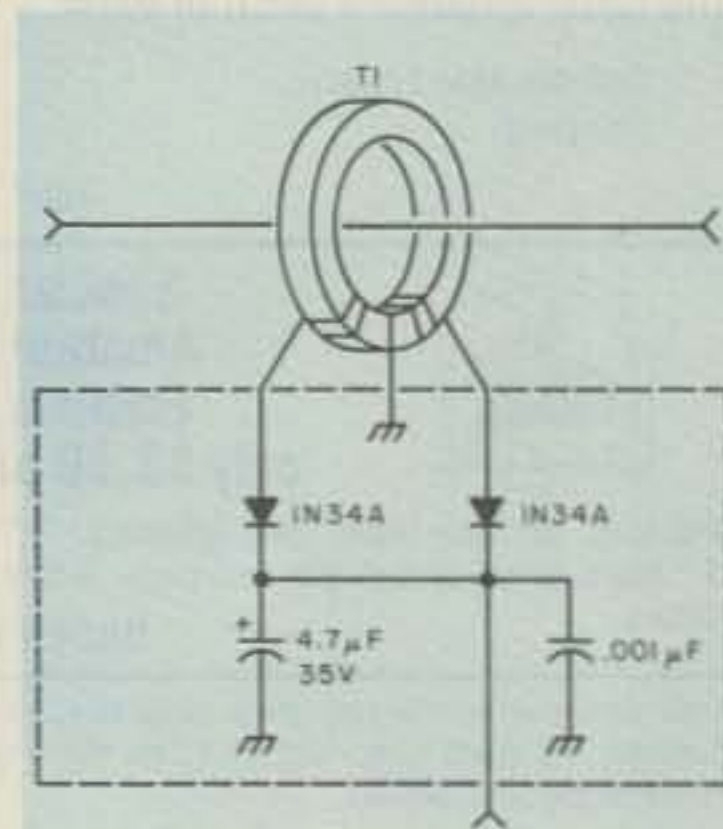

Fig. 1. Rf coupler. T1=60 bifilar turns #30 enameled wire, center-tapped, on an Amidon T-68-2 toroidal core (see text).

fer from the transmitter to the antenna will occur when the transmitter is properly tuned. Rf power is sampled by inserting a coupler similar to the ones found in wattmeters into the feedline following the transmitter or linear amplifier, if one is used. The coupler is connected by a length of shielded microphone cable to a voltage-to-frequency converter constructed around a 555 timer IC.

The circuit for the rf coupler is shown in Fig. 1. It is built in a 2-3/4" x 2-1/8" x 1-5/8" minibox. Two SO-239s are mounted next to each other in the small end of the box (Photo B). A two-inch length of center conductor and inner insulation from a piece of RG-8/U is prepared by removing a half inch of insulation from each end and bending the bare wire at right angles on each end, so that it fits into the center contacts of the SO-239s.

The rf transformer is wound on an Amidon T-68-2 core. To make the transformer, take two lengths of #30 enameled wire, each five feet long, and twist them together with about five turns per inch. Wind 60 turns of this twisted pair on the core. You will find that 30 turns will fill the core when the turns are evenly spaced. When these turns are on, continue winding the remaining 30 turns over the first layer until all 60 turns are in place. Trim the ends to about three inches and untwist them back to the core.

Scrape the insulation off of all four ends to within an inch of the core and locate the start and finish ends of each wire with an ohmmeter. Twist the start end of one wire and the finish end of the other together to form a center tap. Slip the braid over the wire from the RG-8/U that you previously prepared; it should be

a snug fit. You now have an rf transformer with the center wire constituting the primary and the secondary consisting of 120 turns, center-tapped.

Mount a three-lug terminal strip in the center of the large side of the box and an RCA phono jack and ground lug set in the end opposite the SO-239s. Solder the center wire of the transformer to the center terminals of the SO-239s. The center tap of the secondary is soldered to the center ground lug of the terminal strip, and the ends of the secondary are wrapped around the two insulated lugs.

A 1N34A diode is connected from each end of the secondary to the center terminal of the RCA jack, with the cathode band of each diode positioned toward the RCA jack. A 4.7-uF 35-volt electrolytic or tantalum capacitor and a .001 disc capacitor are also connected from the center of the jack to its ground lug, and all joints are soldered. This completes the coupler, and the other half of the minibox can be attached.

The voltage-to-frequency

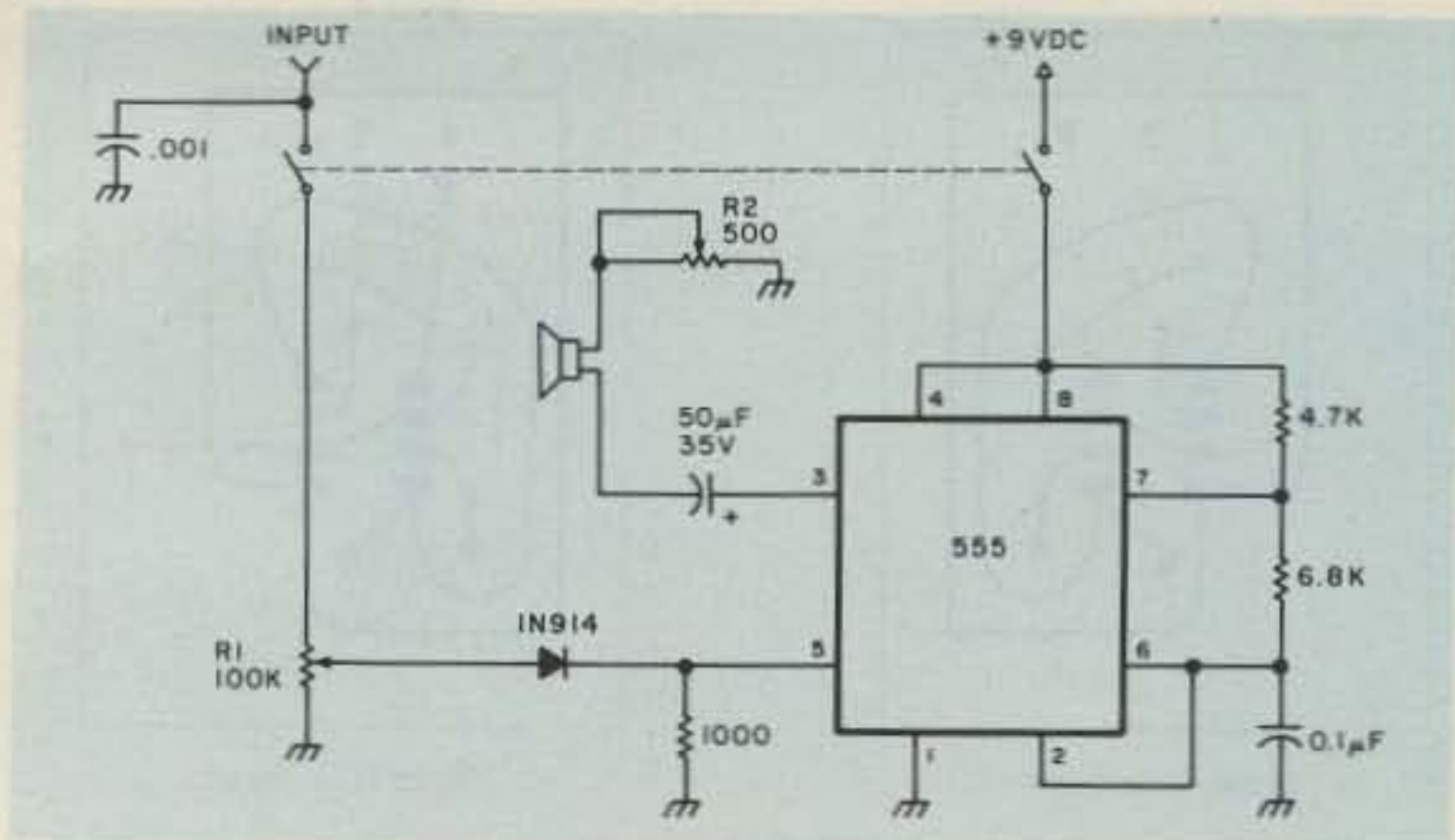

Fig. 2. Voltage-to-frequency converter schematic.

converter is housed in a utility box measuring 3-1/4" x 2-3/16" x 4". Fig. 2 shows the circuit of the converter. Voltages between 1.7 and 9 volts applied to pin 5 of the 555 timer IC cause the oscillation frequency to vary. With the values given, the frequency of oscillation will be about 10 kHz with less than 1.7 volts applied to pin 5. As the voltage is increased above 1.7 volts, the frequency of oscillation will decrease in a linear fashion until the voltage reaches 9 volts, at which point oscillation will stop.

Potentiometer R1 controls the voltage reaching pin 5. When R1 is adjusted to place maximum resis-

tance between the wiper and ground, approximately 20 Watts of output power from the transmitter will begin to lower the audio tone from the converter, and 100 Watts will lower it to about 1 kHz. If higher power is used, adjustment of R1 will set the tone to a usable frequency.

All parts for the converter are mounted on a printed circuit board with the exception of R1, R2, the power switch, and the speaker. An etching pattern for the circuit board is shown in Fig. 3. Although I used a panel-mounted potentiometer for R2 (the volume control), a printed circuit type can be used with only a

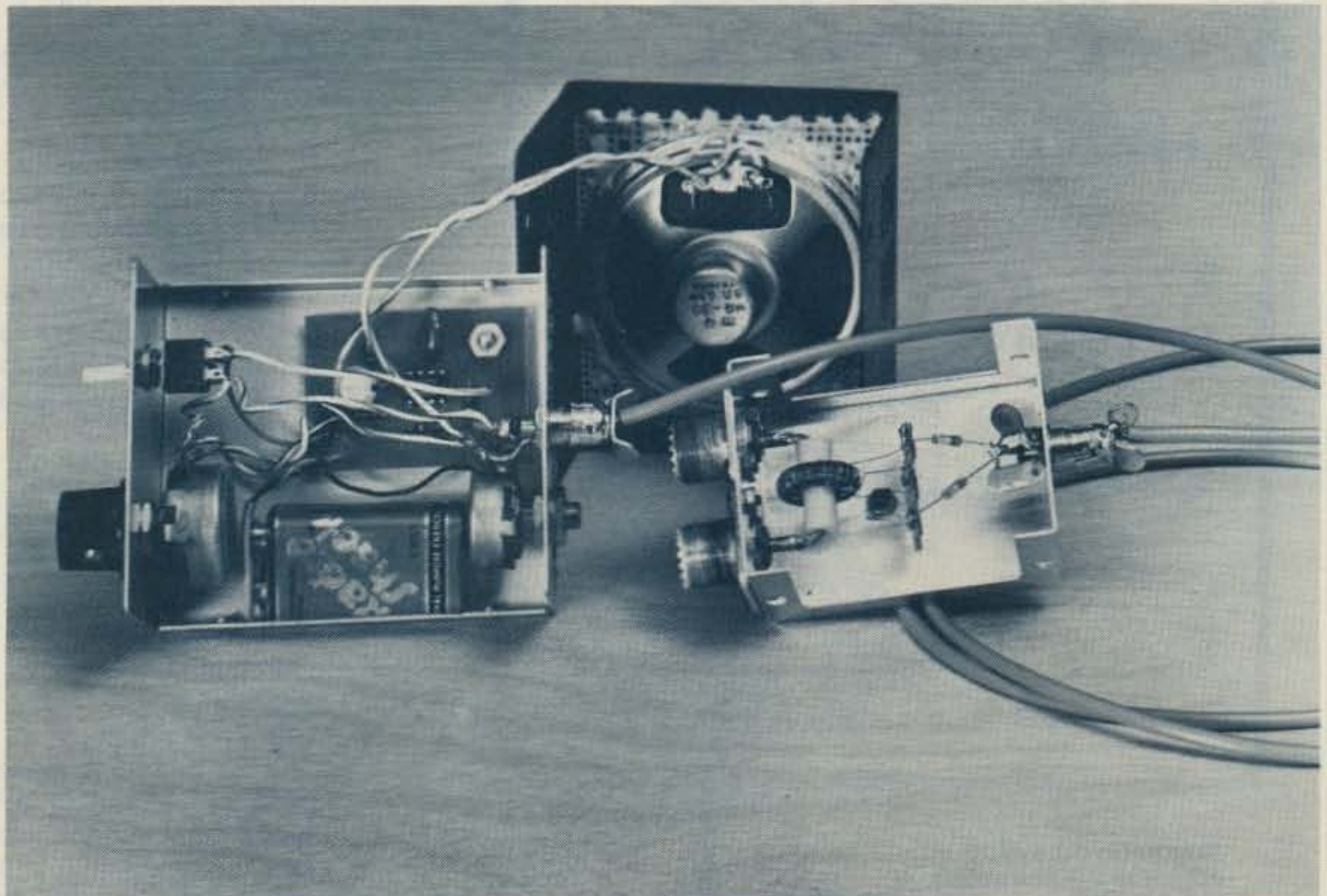

Photo B. Assembly details. Voltage-to-frequency converter is on left, rf coupler is on right.

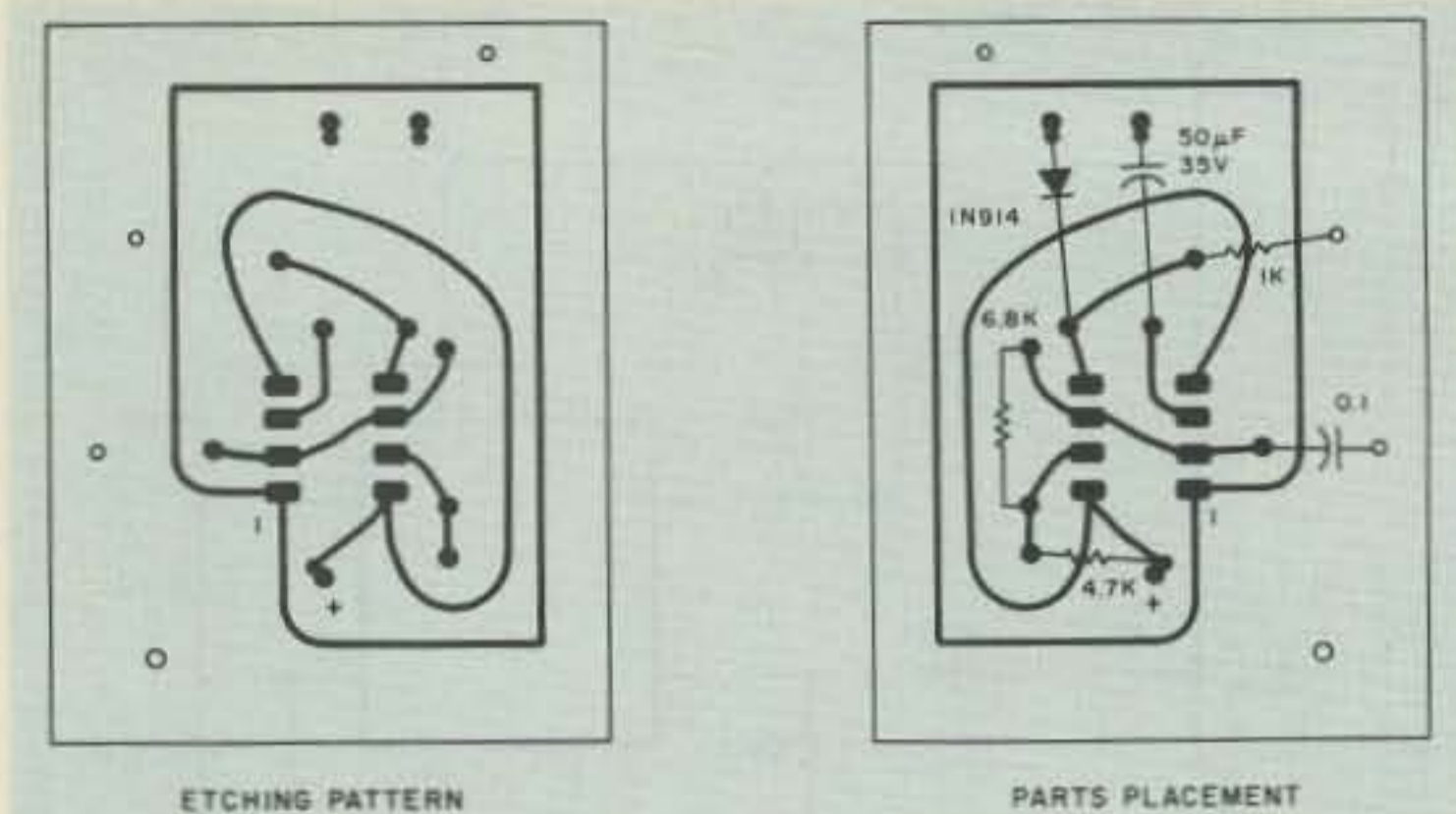

Fig. 3. PCB layout and parts placement.

minor modification to the circuit board. Input voltage from the coupler is through an RCA phono jack on the rear wall of the enclosure along with R2.

The DPDT switch shown is necessary to remove voltage from pin 5 of the IC when the converter is not in use. I failed to remove the input voltage while breadboarding the circuit, and the IC got very hot in a hurry. The resistors are all 1/4 Watt. C1 is mylar™ and

C2 is either electrolytic or tantalum.

Since I did not want any bolt heads showing on the outside of the cover, I mounted the speaker by fastening it with hot-melt glue. I cut a 2" diameter hole in the cabinet top with a wing cutter in my electric drill. Next, I glued a piece of perforated aluminum to the inside of the cabinet, painted it, and then glued the speaker to the underside of the cabinet top.

I mounted the circuit board by removing the screw from the left rear foot of the cabinet and drilling out the hole to clear a 6-32 bolt. I then reattached the foot with a 1-inch-long 6-32 bolt and nut. I ran another nut about halfway down the bolt, put the circuit board on the bolt, and tightened a third nut on top of the board. Be sure to scrape the paint away from around the inside of all mounting holes to ensure good electrical contact. The battery is fastened down by making a loop of masking tape with the sticky side out and pressing it between the battery and the bottom of the cabinet.

As with any construction project today, finding the parts is a major part of the job. Most of the parts are available at Radio Shack, and I have added a parts list with Radio Shack part numbers where available to aid in locating the parts.

Operation of the audible tuning aid is very simple. Just insert the coupler in the antenna feedline and connect it to the converter with a shielded cable to prevent rf pickup. The coupler

is non-directional, so either SO-239 may be connected to the transmitter input.

When the power switch is turned on, a high-pitched tone will be heard from the speaker. Adjust R2 for minimum usable volume to preserve battery life. Apply transmitter power and tune the transmitter for the lowest tone pitch from the tuning aid. For power levels up to 100 Watts or so, R1 should be set to minimum resistance between the input and pin 5 of the IC. If the tone stops during the tuning procedure, advance R1 until a high-pitched tone is reestablished. When further tuning of the transmitter results in no further lowering of the tone frequency, the transmitter is tuned for maximum output and is ready for use.

I hope this tuning aid will help amateurs with visual limitations to enjoy their hobby more. Other uses of the voltage-to-frequency converter can be made (such as audible voltmeters and other test instruments) with changes in the input circuitry. I would be interested in hearing of such uses which others find for the converter. ■

Dade Radio Club presents

**1981
ARRL
FLORIDA STATE
CONVENTION**
& 21st ANNUAL
TROPICAL HAMBOREE

Fabulous Flagler Dog Track
MIAMI, FLORIDA

**FEBRUARY
7-8
1981**

REGISTRATION:
\$3.00 Advance
\$4.00 Door

• **FREE PARKING**
Including Overnight
Parking for
Self-Contained
RV Units

(ADVANCE RV SPACE
RESERVATION IS RECOMMENDED)



For further information write:
DADE RADIO CLUB, INC.
P.O. Box 350045, Riverside Station
Miami, FL 33135

Component	Radio Shack Part Number
50-uF, 35-volt capacitor	272-1027
0.1-uF dipped mylar™ capacitor	272-1069
0.001-uF disc ceramic capacitor	272-126
4.7-uF 35-volt capacitor	272-1012
100k-Ohm potentiometer	271-092
1000-Ohm, 1/4-Watt resistor	271-023
4700-Ohm, 1/4-Watt resistor	271-030
6800-Ohm, 1/4-Watt resistor	271-032
1N34A diodes	276-1123
1N914 diode	276-1122
555 IC	276-1723
DPDT switch	275-614
Battery clip	270-325
2-1/2" speaker	40-247
SO-239	278-201
RCA phono jacks	274-346
Minibox	270-235
Utility box	270-251

The T-68-2 toroid core is available from Amidon Associates, 12033 Otsego Street, North Hollywood CA 91607. Radio Shack does not stock a 500-Ohm panel-mount potentiometer. If the circuit board is modified for a PC-mount pot, part number 271-226 may be obtained from Radio Shack.

Have you ever wondered why the best ham bargains are advertised in 73?

You'll find a wider selection of ham bargains . . . and lower prices in 73, because 73's readers buy far more than readers of other ham magazines.



Wayne Green

THE LEADING EDGE

That shouldn't come as a surprise to you . . . For twenty years we've been publishing more construction projects and articles than any other ham magazine, so it is natural for the active hams to read 73 . . . and buy from the ads.

The readers of 73 catch the leading edge, through sideband in the early 60's, then solid state in the mid-60's, FM and repeaters in the early 70's . . . SSTV, ATV, RTTY and all other special modes have received more coverage in 73 than all other ham magazines combined.

NEXT YEAR WE'LL BE PUSHING . . .

In the next year or so, we'll be pushing for amateur experimentation and pioneering with new modes of communications, via computer, automatic identification, satellite, wideband techniques, synchronous detectors, time slicing. Never before was a point in time so exciting to contemplate, and with 73 you can keep up with the new ideas and changes.

We'll also be pushing for increased pressure on the FCC for better and more responsive rules, for a return to a national growth and for amateur radio development in as many of the emerging nations as possible.

ALL OF THIS IS MADE POSSIBLE BY YOU

All of this is made possible by you reading 73 and getting your friends and club members to subscribe to 73. I admit that we're not really pushing the radio relay of messages, since that is more geared to the 1920's than the 1980's and is more likely than other activities to cause troubles with foreign governments nervous about potential lost telephone revenues. We're looking toward the 1990's, with over one million hams in our country using state of the art communications techniques to keep in touch with hams worldwide.

YEAR 2000?

What will amateur radio be like in the year 2000? We can't really even imagine, except that we know it will be different from 1980 . . . probably as different as amateur radio is today from what it was in 1960, when FM and repeaters were all but unknown, and AM was still going strong on our phone bands. A frequency synthesizer required over a hundred tubes and radioteletype circuits were larger than the printers. You can be sure that 73 will be in the vanguard of the developments to come . . . reporting on them and giving you the information so you can participate.



Bill me for one year of 73 at \$25.00 New Subscription Renewal

Name _____

Address _____

City _____ State _____ Zip _____

Canadian \$27.00/1 year only, US funds Foreign \$35.00/1 year only, US funds

Please allow 4-6 weeks for delivery.

73 Magazine • PO Box 931 • Farmingdale NY 11737

311B6

NEW MFJ-102 24/12 Hour Digital Clock/ID Timer



MFJ-102
\$32⁹⁵ (+\$4)

The latest in time keeping convenience. Now you can switch to either 24 hour GMT time or 12 hour format! Double usefulness—great for your operating position and great for other family members to use. Switch to "seconds" readout. For the times when you need the utmost accuracy. Switch to ID timer. Alerts every 9 minutes after you tap the button (also functions as a snooze alarm). Switch to "observed" timing. Just start clock from zero and note end time of event; counts up to 24 hours and repeats. (requires resetting clock time after use). Switch to regular alarm. For skeds reminder or wake-up use (has alarm-on indicator).

Synchronize with WWV. Now you can adjust the MFJ clock to WWV accuracy. Fast/Slow set buttons for easy setting of time and alarm. Big, bright, blue digits are 0.6" for easy-on-the-eyes, across-the-room viewing. Lock function prevents missetting. Solid-state circuitry for long life. Operates on 110VAC, 60 Hz (50 Hz with simple modification). UL approved. Handsome styling with rugged black plastic case with brushed aluminum top and front. Front has sloping surface for easy viewing. Cabinet measures 6x2x3". Put this new improved MFJ digital clock to work in your shack.

Five NEW MFJ Deluxe Multi-Outlet AC Power Strips



Here's the most convenient, most protected way to power-up radio and computer gear. MFJ-1104: Varistor protects against voltage spikes (worth the investment alone to guard your transceiver, computer, or SWL radios). Individual double-pi RFI filters for each of 3 pairs of outlets to completely isolate radios, computers, and computer peripherals from interference. 8 sockets, 4 pairs, all 3-prong; the fourth pair is unisolated and unswitched. Pop-Out fuse for easy changing (15A, 125VAC), heavy duty 3-wire 6' power cord. Lighted switch shows circuits are "on."

Deluxe heavy-gauge .063 aluminum case, finished in black, has easy mounting slots. Measures 18"Lx2 3/4"Wx1 7/8"H. MFJ-1103, similar but 12 sockets (2 unswitched), one RFI filter for all. MFJ-1102, similar to 1103 but no RFI filter. MFJ-1101: 6 sockets, all 3-prong type. Fuse protected, 15A, 125VAC. On-off switch. Lighted "On" indicator. 3-wire 6' power cord. Steel case, finished in gray hammer-tone, has mounting slots, measures 13 1/8"L x 2 3/8"Wx1 1/2"H. MFJ-1100, similar to 1101 but 5 sockets, less switch, light, and is 8 5/8"L.

NEW MFJ Compact 3 KW Antenna Tuner Has Roller Inductor



Meet "Versa Tuner V". It has all the features you asked for, including the new smaller size to match new smaller rigs — only 10 3/4"Wx4 1/2"Hx14 7/8"D. Matches coax, balanced lines, random wires 1.8-30 MHz.

3 KW PEP — the power rating you won't outgrow. (250 pf-6KV caps). Roller inductor with a 3-digit turns counter plus a spinner knob for precise inductance control to get that SWR down to minimum every time. Built-in 300 watt, 50 ohm dummy load. Built-in 4:1 ferrite balun. Built-in lighted 2% meter reads SWR plus forward and reflected power in 2 ranges (200 & 2000 w). 6-position antenna switch (2 coax lines, through tuner or direct, random/balanced line or dummy load). SO-239 coax conn., ceramic feed-throughs, binding post ground. Deluxe aluminum low-profile cabinet with sub chassis for RFI protection, black finish, black panel with raised letters; tilt bail; requires 12 VDC for meter light.

MFJ-989
\$279⁹⁵ (+\$10)

MFJ NEW PRODUCTS

exciting new ideas from the world's leading manufacturer of amateur radio accessories

NEW MFJ VHF SWR/Wattmeter/Field Strength Meters



MFJ-812 \$29⁹⁵ (+\$4) MFJ-810 \$24⁹⁵ (+\$4)

New low cost VHF operating aids. MFJ-812: Reads SWR from 14-170 MHz to keep you informed about antenna/feedlines. SO-239 coax conn. Reads forward & reflected power at 2 Meters (144-148 MHz) 2 scales (30 & 300W). Reads field strength levels from 1-170 MHz. Binding posts provided for antenna. Easy push-button switch operation. MFJ-810, similar less field strength function.

NEW MFJ DXer's Communications Filter



MFJ-732
\$69⁹⁵ (+\$4)

MFJ-732 Puts more presence in SSB/AM/FM voice communications, brings more signals out of the "mud." Easy to use, just push up to 4 buttons. 10-pole (5-stage) circuit with Chebyshev superfast roll-off (up to 58 dB/octave). First button: On/Off-Bypass, response 300-3000 Hz; second: 500 Hz lower cutoff; third: 2200 Hz upper cutoff; fourth: 1500 Hz upper cutoff. Built-in speaker, 2 watt amplifier, LED, 9-18 VDC or 110VAC with optional AC adapter (\$7.95+\$2), 5x6x1 5/8".

TO ORDER PRODUCTS, CALL TOLL FREE



800-647-1800

VISA

For tech. info., order or repair status, or calls outside continental U.S. and inside Miss., call 601-323-5869.

- All MFJ products unconditionally guaranteed for one year (except as noted)
- Products ordered from MFJ are returnable within 30 days for full refund (less shipping)
- Add shipping & handling charges in amounts shown in parentheses

Write for FREE catalog, over 60 products

**MFJ ENTERPRISES
INCORPORATED**

Box 494; Mississippi State, MS 39762

MFJ 941C Versa Tuner II



MFJ-941C
\$84⁹⁵ (+\$4)

Fastest selling MFJ tuner . . . because it has the most wanted features at the best price.

SWR + dual range wattmeter (300 & 30 watts full scale, forward and reflected power). *Sensitive meter* measures SWR down to 5 watts output.

More flexible antenna switch selects 2 coax lines, direct or through tuner, random wire/balanced line, or tuner bypass for dummy load.

12 position efficient airwound inductor for lower losses, more watts out.

Built-in 4:1 balun for balanced lines. 1000v capacitor spacing.

Matches everything from 160-10 meters: dipoles, inverted vees, random wires, verticals, mobile whips, beams, balanced and coax lines.

Easy to use, anywhere. Measures 8x2x6", has SO-239 connectors, 5-way binding posts, finished in eggshell white with walnut-grained sides.

MFJ-945, \$74.95, like model 941C but less ant. switch. Optional mobile bracket for either model is \$3.

MFJ 484 "Grandmaster" Memory Keyer



MFJ-484
\$139⁹⁵ (+\$4)

Up to twelve 25 character messages plus 100, 75, 50 or 25 ch. messages (4096 bits). **Repeat any message continuously or with pauses** of up to 2 min. LEDs show use.

Record, playback, or change messages instantly at touch of a button. Memories are resettable with button or touch of the paddle.

Built-in memory saver — 9 V battery takes over when power is lost.

Iambic operation with squeeze key. Dot-dash insertion. Optional BENCHER paddle \$42.95 + \$4.

Dot-Dash memories, self-completing, jam-proof spacing, instant start.

Panel controls: Speed (8-50wpm)/Record; Weight/Memories Combined; Tone/Tune; Delay (0-2 min.)/Repeat; rotary Vol/On-Off; Memory Select; Message Buttons select desired 25 ch. messages; Memory Reset button.

Ultra reliable solid state keying: grid block, cathode, solid state transmitters (-300 V, 10 mA max; +300 V, 100 mA max). Operates 12-15 VDC or 110 VAC with optional adapter, \$7.95 + \$2. Size 8x2x6". **MFJ-482, \$99.95**, four 25 or 50+two 25 ch. messages; **MFJ-481, \$89.95**, two 50 ch. messages. Get the best seller keyers—MFJ "Grandmasters."

MFJ 410 "Professor Morse" Code Generator/Keyer



NEW
 LOW
 PRICE
 Save
\$20

MFJ-410 Now Only **\$129⁹⁵** (+\$4)

Use it to learn, use it to operate. It sends *unlimited random code* in random groups for practice; *never repeats* sequences. And when you're on the air, it's a *full feature keyer*.

Vary speed from 5-50 wpm; meter readout.

Vary spacing; give fast sound to low speed.

Alpha or alphanumeric with punctuation.

Built-in speaker and phone jack; tone and vol. Ideal for classroom or private use.

Full feature keyer includes vol., speed, tone and weight controls, tune switch, dot-dash memories, keys grid block, cathode, solid-state rigs. Optional BENCHER paddle \$42.95 + \$4. Operates on 9-18 VDC, two 9 V batteries or 110 VAC with optional adapter \$7.95 + \$2. Size 7x2x6". Get "Professor Morse" — you'll never outgrow it.

MFJ Dual Tunable SSB/CW Filter "Signal Enhancer"



MFJ-752B **\$84⁹⁵** (+\$4)

Dual filters give unmatched performance.

The primary filter lets you *peak, notch, low pass or high pass* with extra steep skirts.

Auxiliary filter; 70 dB notch, 40 Hz peak.

Both filters tune from 300 to 3000 Hz with variable *bandwidth from 40 Hz to nearly flat*.

Constant output as bandwidth is varied; linear frequency control.

Switchable noise limiter for impulse noise.

Simulated stereo sound for CW lets ears and mind reject QRM.

Inputs for 2 rigs, switch selectable. Plugs into phone jack. Two watts for speaker. OFF bypasses filter. 9-18 VDC, 300 mA or 110 VAC with optional adapter \$7.95 + \$2. 10x2 x6". **MFJ 751, \$59.95**, similar, primary filter only, less high pass & noise limiter.

MFJ BEST SELLERS

favorite products from the world's leading manufacturer of amateur radio accessories

GMT Clock/ID Timer



MFJ-101
\$29⁹⁵ (+\$4)

24 hour, solid-state, blue 0.6" digits, ID timer sounds every 9 min (also a snooze alarm), regular alarm for skeds or to awaken, power-out/alarm-on indicators, ready to use on 110VAC, 50-60Hz, 6x2x3".

KW Dummy Load With Oil



MFJ-250
\$29⁹⁵ (+\$4)

Rated at 1 kW CW or 2 kW PEP for 10 min., half that for 20 min., cont. at 200 W CW, 400 W PEP, non-inductive 50 ohm resistor, quality transformer oil (no PCB), VSWR under 1.2:1 to 30 MHz, 1.5:1, 30-300 MHz, 2:1, 300-400 MHz. Coax conn., vent cap., 7 1/2" h x 6 5/8" diam.

300 Watt Antenna Tuner



MFJ-949B
\$129⁹⁵ (+\$4)

Does it all! Built-in dummy load, SWR, forward and reflected power meter, antenna switch, balun, matches everything from 1.8-30 MHz (coax, random wires, balanced lines), coax conn., binding post, 10x3x7".

TO ORDER PRODUCTS, CALL TOLL FREE



800-647-1800

VISA

For tech. info., order or repair status, or calls outside continental U.S. and inside Miss., call 601-323-5869.

- All MFJ products unconditionally guaranteed for one year (except as noted)
- Products ordered from MFJ are returnable within 30 days for full refund (less shipping)
- Add shipping & handling charges in amounts shown in parentheses

Write for FREE catalog, over 60 products

MFJ ENTERPRISES
 INCORPORATED ✓47

Box 494; Mississippi State, MS 39762

Installing Subaudible Tone Encoders

— do it right

Today's communication channels are becoming more crowded every day, and with the increasing amount of intermod and other interference, amateur repeater systems are incorporating tone-access sys-

tems to help solve these problems. Probably the most common use of tone-control signaling in FM two-way radio is the continuous-tone-controlled squelch system (CTCSS). This consists of a low-level subaudi-

ble tone, typically below 250 Hz, being modulated on the radio frequency carrier of an FM transmitter.

One of the most difficult aspects of connecting CTCSS equipment to a ra-

dio is locating the proper injection point for the subaudible encoder. Depending on the encoder used and the type of radio in which the encoder is installed, this procedure can be relatively easy or it can produce many hours of frustration. This article will describe some of the problems of installing a subaudible encoder and will guide you to the successful installation of these units.

Proper connection of a subaudible encoder is very important. If the correct connection point is not found, the result can cause serious system problems. These problems include an excessive buzz on the carrier; loss of microphone audio, loss of transmit power, and intermittent or unreliable operation.

The key to locating the proper tone-injection point involves looking at two areas. First, how universal is the encoder? Is it capable of driving a low impedance load? Second, does the transmitter have a phase modulator or an FM modulator? Are you using a synthesized transceiver? These are just a few of the questions which are important to the proper installation of

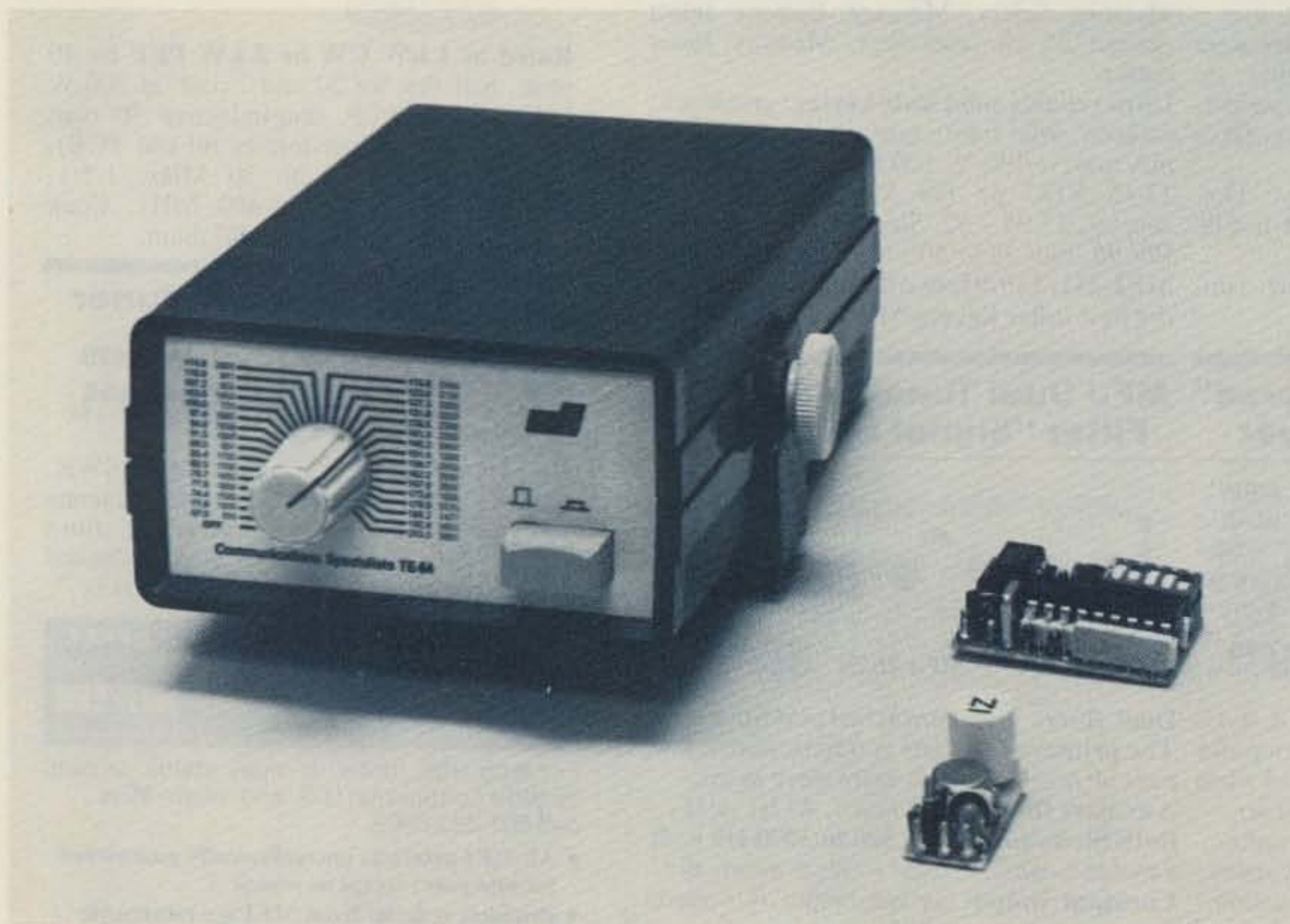

Photo A. This is an example of the types of subaudible encoders available with low-impedance outputs. Moving clockwise from the top is the TE-64 universal encoder, capable of encoding all 32 CTCSS tones via a front-panel switch. Next is the model SS-32 programmable encoder which can be programmed without the use of a frequency counter. Third is the model ME-3 microminiature encoder which uses field-replaceable, plug-in frequency-determining elements. All units are manufactured by Communications Specialists in Orange, California.

the encoder.

Fig. 1 shows a block diagram of a typical phase-modulated transmitter. Most transmitters using individual crystals for each transmit frequency are of the phase-modulated type. The output of the subaudible encoder is typically connected in or just prior to the modulator stage in the transmitter. If the transmitter has a subaudible tone connection point, this point should be used. Do not confuse this connection with another common point often referred to as *tone input*. This is normally used for touchtone™ pads or audible encoders, and is not satisfactory for subaudible connections. This is primarily because this point is usually located in the microphone amplifier section of the transmitter (more on this later).

A radio manufacturer's connecting point is often to the center of the deviation control (sometimes called the IDC control), to the input of the final audio driver, or directly to the varactor modulator diodes. Should the transmitter not have provisions for tone injection, one or all of these connection points should be tested, and the one that provides the best results with minimum distortion and a minimum amount of voice intermoding should be used. This connection point varies with each different model radio, and you must determine which provides the best results.

In some cases, amateur transceivers are not designed to interface readily with tone-coded squelch systems, and injection of the subaudible tone sometimes can be very difficult. In these cases, when using a phase modulator, a varactor assembly can be used. The varactor changes ac voltage into changing capacitance which truly FM modulates the transmitter.

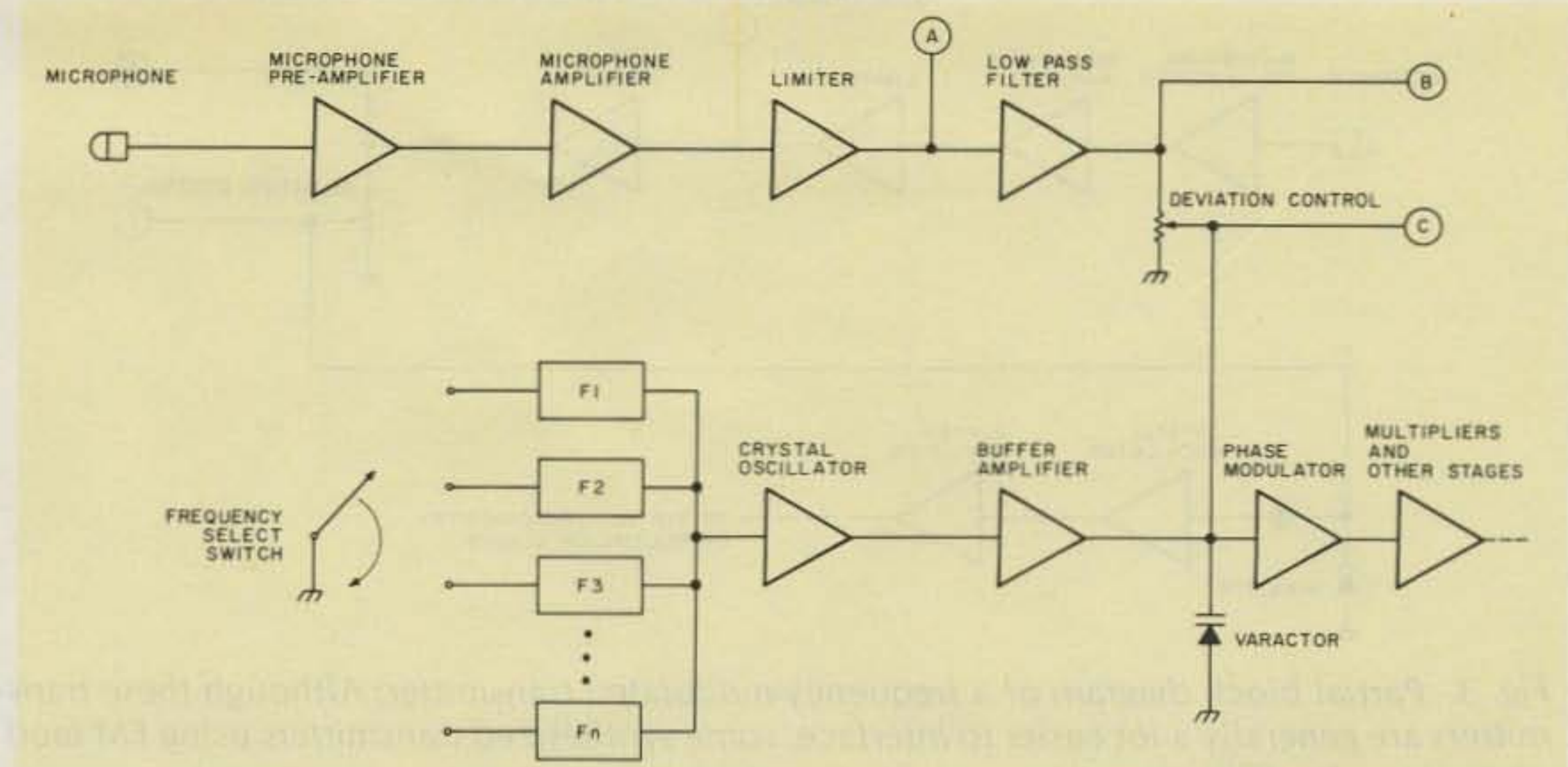

Fig. 1. Partial block diagram of a phase-modulated transmitter. The points labeled A, B, and C are typical connection points for the subaudible encoder. These points are located after the audio-shaping circuitry which would cause tone distortion.

No intermoding or distortion of the voice will be noted with this method, as compared to some injection points in the phase modulators.

Fig. 2 shows a typical varactor assembly, where the collector-base junction of a low-frequency NPN silicon transistor is used as the varactor diode. Various values of coupling capacitors are shown for different frequency ranges of the transmitter; a higher value of capacitance will increase the deviation level. However, if the capacitance is too high, it may be difficult to set the transmitter on frequency. It should be noted that when the varactor assembly is connected to the oscillator circuit, the oscillator frequency will probably shift slightly and require retuning. This method is used quite often in tube-type transmitters and in a few solid-state units, as well. This method also can be used if other connection points prove unsuccessful.

Another common type of transmitter that is now extremely popular is the synthesized transceiver (Fig. 3). This type of radio often uses a frequency modulator whereby a varactor, as described before, is used to vary the frequency of the

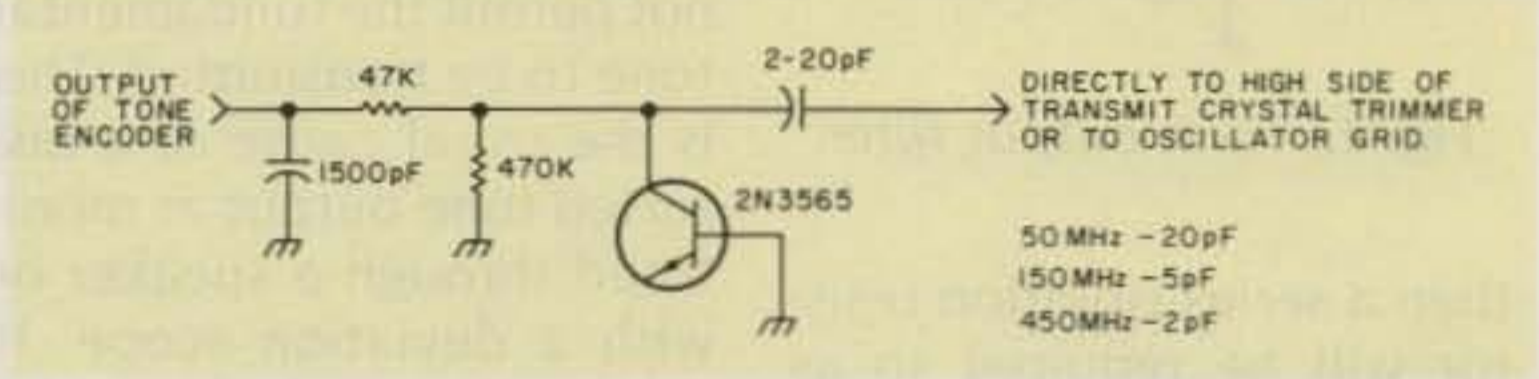

Fig. 2. Schematic of a typical varactor assembly. The collector-base junction of an NPN transistor is used as the varactor. The output of the assembly is connected to the high side of the transmit crystal trimmer. In a tube-type transmitter, the output is often connected to the grid of the oscillator tube. The value of the coupling capacitor changes, depending on the frequency range used. The values shown are approximate and may require adjustment to obtain the proper deviation level.

crystal oscillator. In some transceivers, the varactor is used to change the frequency of a voltage-controlled oscillator (vco). This type of modulator interfaces quite well with subaudible encoders.

The frequency-modulated transmitter is very similar to the phase-modulated transmitter up to the low-pass filter section. The FM modulator is identified quite easily, as the audio is fed into the varactor, which is often part of the crystal oscillator. The tone-injection point for a frequency-modulated transmitter is found in a similar manner as with the phase-modulated transmitter.

When connecting power to the encoder, be sure to use switched power that is active only during transmit. This voltage can be taken

right from the transmitter circuit board or a push-to-talk relay coil. Switched power should be used for two reasons. First, the encoder will draw current only during transmit since it is not used during receive operation. Second, the crystal oscillator, which is frequency modulated during transmit, is often the same oscillator which is used during receive operation. If the encoder is not disabled during receive, a buzz will probably be heard through the speaker as the encoder continues to modulate the receiver oscillator.

If you have an encoder that has a low-impedance output, insufficient level output should never be a problem. However, if the tone connection point is a high-impedance load such as a 100k deviation control,

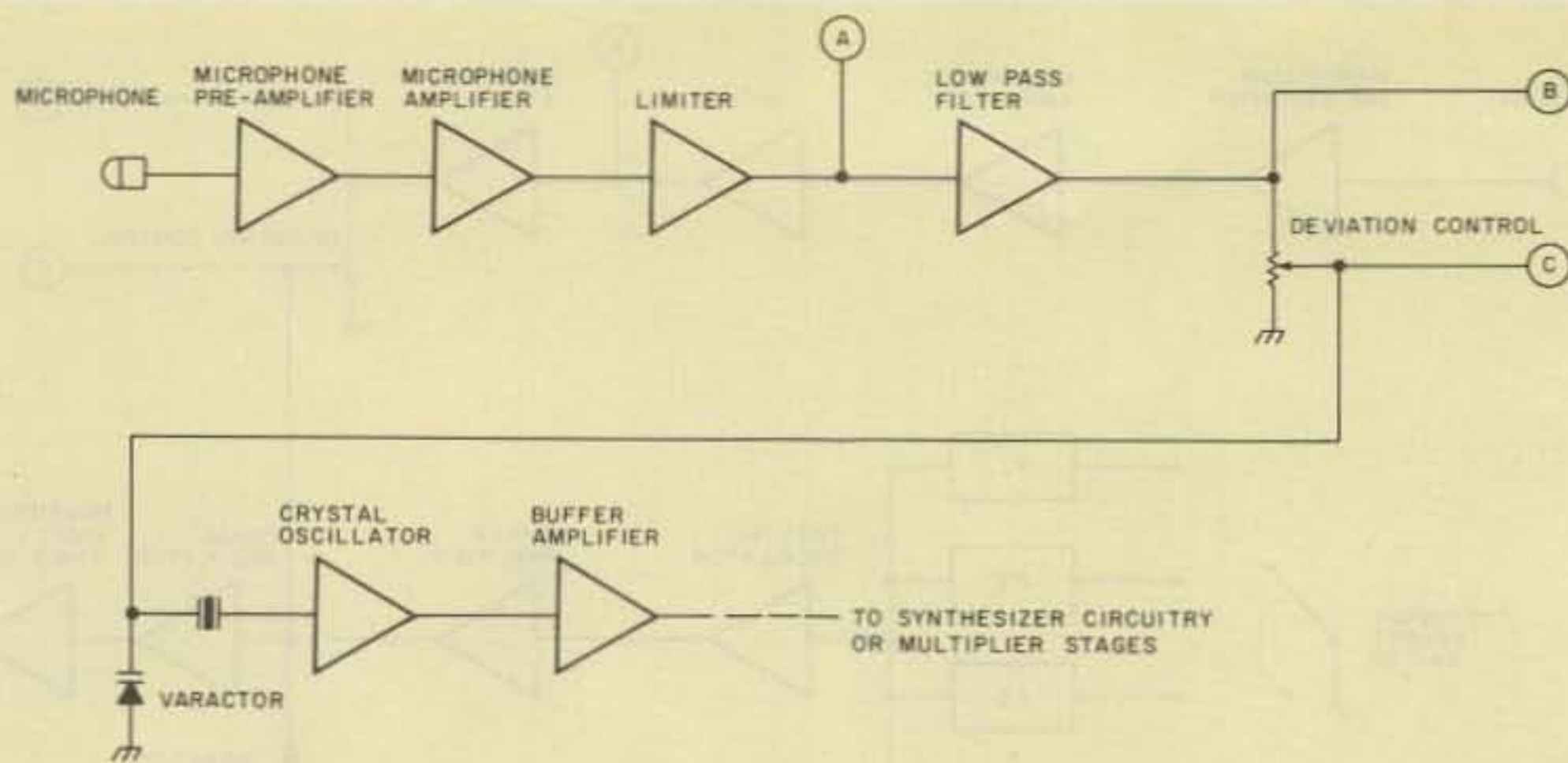

Fig. 3. Partial block diagram of a frequency-modulated transmitter. Although these transmitters are generally a lot easier to interface, some synthesized transmitters using FM modulators can be difficult.

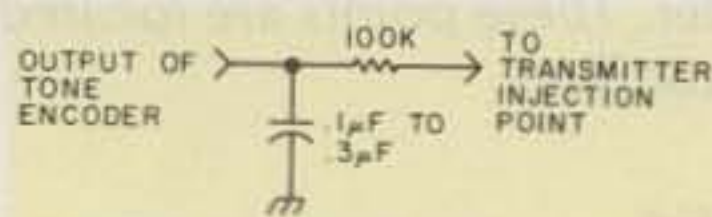

Fig. 4. Tone output filter.

then a series isolation resistor will be required so as not to load down the normal voice modulation. This resistor value must be determined experimentally, but a 100k resistor would be a good starting point. This value could change from 10k to 1 megohm, depending on the radio used. It is best to use an encoder with a low-impedance output (less than 10k). This is more easily adaptable to various types of transmitters, since the encoder often is required to drive into a low-impedance load. If the tone deviation cannot be set up to the proper level, it is possible that the encoder is not supplying a sufficient output level. This would be the case when using an encoder with a high-impedance output to drive a low-impedance load. If this happens, another connecting point must be located which is at a higher impedance level.

Do not connect the encoder tone to the microphone input or the microphone preamplifier as this invariably causes excessive tone distortion due to the frequency response of the transmitter's speech amplifier. The speech amplifier

has a typical response of 300 Hz to 3000 Hz and does not permit the fundamental tone to be transmitted. This is the usual cause of a distorted tone output as monitored through a speaker or with a deviation scope. If the purity of the encoder output is in question, look at the output of the encoder with an oscilloscope.

If tone distortion continues to be a problem, then a capacitor can be placed on the tone output to provide additional filtering when required (see Fig. 4). This is not noticeable in phase modulators, since the frequency response can be quite poor at the low end of the audio range. If a deviation scope is used, the scope trace will not be a pure sine wave and will sound like a buzz. The additional filtering will cure the problem. If a deviation scope is not available, then another receiver on the transmitter's frequency can be used. Using this method, an oscilloscope can be connected to the discriminator output in the receiver, and a clean sine wave should appear when transmitting.

Another area which should be given special attention is rf interference. This is most common when installing encoders into hand-held portable transceivers. Although the encoders tested were not sus-

ceptible to being affected by rf, care should be taken when installing the units near the transmitter circuitry. In most cases of rf interference causing loss of audio or loud buzzing oscillations, it has been found that the rf is coupled into the connecting leads of the encoder and then fed back into the transmitter itself. This causes the bias conditions and other tuned circuits to become unstable, producing oscillations and distortion. But, under these conditions, it should be noted that the encoder is still working properly. The solution to this is to keep all leads as short as possible and install one or more bypass capacitors on the radio's circuit board where the encoder leads are connected. Also, relocating the encoder or rerouting the connecting leads through another part of the radio should correct the interference caused by the stray rf.

One final problem which is common when connecting tone-coded squelch equipment is setting the encoder to the proper deviation level. Unless you have access to a communications monitor with a deviation scope (not a deviation meter!), setting the proper level can be very difficult. If the proper injection point is not found, you could be encoding a highly-distorted

tone which would have to be set at a very high level in order to open the associated decoder. If you are encoding a clean sine wave, then follow this procedure for setting the level:

1) Turn the level adjustment all the way down so that you have zero output and move to a repeater requiring tone access.

2) Next, turn the level up just a little bit and key your transmitter.

3) Did your transmitter key up the repeater? If not, repeat step 2 and continue to increase the level until the repeater keys up reliably.

4) Now increase the level just a little bit more, and you are finished. This little extra level will help you in marginal signal areas, and will operate the decoder more reliably.

5) Button up the radio, and you are on your way.

If you happen to have access to a deviation scope, then the proper deviation level of the subaudible tone should be set from 0.5 kHz to 1.0 kHz peak-to-peak. This is the standard range for this setting. However, it is best to keep the deviation as low as is practical within this range as long as reliable operating is maintained.

It should be clear that installing a subaudible encoder to a transmitter is not an easy job. There are many variables to contend with and each one of them can cause a multitude of problems. But, with practice and experience and, of course, a little patience, excellent system operation can be attained.

I would like to thank the various manufacturers of tone equipment for providing the test equipment and information required for this article. I would also like to thank them for the use of their new line of encoder products which were used for testing and evaluation. ■

Four-Band Mobile Antenna

— looks like a weird hat rack

Do you ever find yourself cruising down the highway working forty meters and wishing you could switch to twenty, fifteen, or ten without having to stop to change resonators? You can! I experimented with this contraption in 1960 and have been using it ever since. There is even a commercial version that came out a couple of years ago.

Any set of three resonators may be used but I prefer the 40-20-10 combination since you also get a 15-meter fallout from it. When I first started using it with an old Galaxy V, I installed a remotely-operated

super-tuner gizmo in the trunk, but later found that with patient stinger adjustments on the three resonators, the tuner was not really needed. I am presently using an Atlas 210 for mobile, and the broadbanded rigs are supersensitive to swr over 1.5:1. I have worked many foreign countries with this rig with good signal reports.

The strap that holds the resonators must be of sufficient strength to prevent the angles of the forward and aft resonators from changing. Changing this angle affects the resonant frequency. The strap I hap-

pened to start out with was about one inch wide and 3 1/4 inches long. A hole large enough to accommodate the threaded extension on the mast is drilled in the center. (I happened to have had all Hustler equipment so that is what I have used since.) The other holes on each end are large enough to hold non-corrosive bolts that will screw into the bottoms of the other resonators. The strap is bent as shown with each end dropped at forty-five degrees. The assembly is attached to the mast and held in place by the center resonator, and the time-consuming tuning is started.

Begin with the lowest frequency resonator, adjusting to the lowest swr, then proceed to the next higher and then the last. The resonators interact, and this procedure must be repeated several times until the swr no longer can be improved. I have 1.1 at 7.260 and 1.35 at 7.225 and 7.295. On twenty meters, the swr is less than 1.35 across the band and even better on ten. The swr does peak up to 1.5 on fifteen meters. I use the ten-meter resonator to hold the

strap to the mast with the twenty-meter resonator in front and the forty-meter aft. This streamlines the assembly in the direction of travel and reduces wind resistance. Also, with the larger resonator aft, it tends to stabilize the assembly at normal highway speeds.

I have found that the majority of the noise associated with mobile reception can be eliminated by using the copper braid out of RG-8 coax as grounding straps and grounding the car hood and trunk lid to the frame of the car. In addition, the exhaust should be grounded in at least two places, one in front of the muffler and one aft. Be sure to scrape the rust off to bare metal when attaching the grounding straps. The braid can be cut to the desired length, the ends shaped to hold a bolt, and then heavily soldered to make a good connection.

Several of my ham friends around the country have built this antenna system over the years and have enjoyed it. I would be pleased to hear from anyone who tries it and of any ideas for improvement. ■

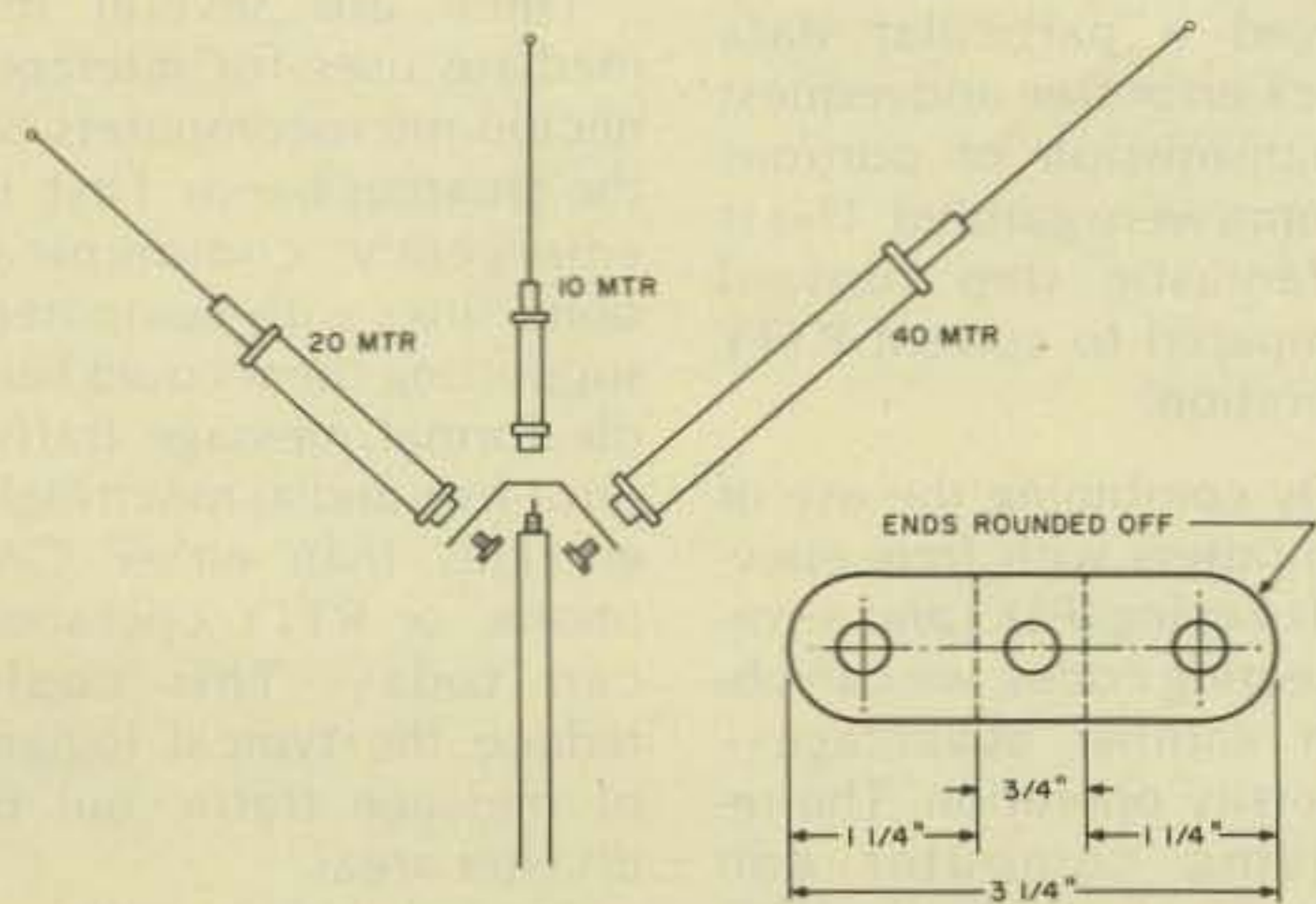

Fig. 1. Four-band mobile antenna construction details.

Computers and HF

— a discussion of alternatives

Microcomputers are becoming increasingly popular, and they can be used to give us faster and more reliable communications on the amateur bands. But what is the best way to use them? If the FCC offered us a choice of several emission types and transmission speeds for computer communications today, which should we choose? It would be good for us to start now to consider the character of the ham bands we have to communicate over and the nature and potential of the computer links that we want to set up so that later we can go to the FCC with proposals and justifications for what we want.

This article will present my thoughts on how an optimum scheme for computer-to-computer communications on the HF amateur bands should be designed.

For purposes of this discussion, whether or not these techniques are authorized under the current FCC rules is immaterial; we can work on the rules after we decide what we want.

Advantages

Why, in the first place, do we need a special emission type for use in computer-to-computer communications? Current practice for those with microcomputers running in their ham shacks is to program the computer to emulate a TTY machine. This allows communications with other amateurs using TTY machines, but we can do much better.

Computers will allow us to communicate at much higher speeds than TTY machines. This will reduce the time required for transmission of large data files and also allow retransmission of

data that was garbled by fading or QRM without incurring unacceptable overall transmission times in the process.

Computers will allow us to implement error-detecting and error-correcting codes in the transmission of our data. This means that the receiving computer will be able to determine whether or not it has received a particular data block error-free and request retransmission of portions if some were garbled. This is a fantastic step forward compared to current RTTY operation.

By combining the use of computers with frequency-shift keying (FSK) and error-detecting codes, we can obtain another advantage—diversity operation. The receiving computer can detect independently both the mark and space signals,

Since these two signals are separated in frequency, the overall system gains immunity to fading of one channel with respect to the other ("selective fading") and also to narrowband QRM such as CW signals which might be obliterating one of the two tone frequencies at any given time.

Uses

There are several immediate uses for interconnected microcomputers on the amateur bands. First, in emergency communications, links with computers supporting them could handle formal message traffic error-free and at much higher rates than either CW, phone, or RTTY operation can today. This could reduce the typical logjam of message traffic out of disaster areas.

Second, the transfer of image data (TV pictures or

computer graphics) from one amateur to another could be done much better using microcomputers and digital techniques than by the current slow-scan TV system. This is because the images could be digitized and sent over the link using error-detection coding. By retransmitting portions of the image that were received garbled, display of a perfect image could be ensured.

Third, people will want to exchange computer programs. This will require a high-speed communications link between computers, with a means to detect and retransmit garbled data, since programs can tolerate no errors.

Now let's discuss an inter-computer communications scheme that is intended to be optimum for amateur use on the HF bands.

Emission

One of the most important characteristics of the HF amateur bands is the typical presence of fading and interference. For operation under these conditions, a frequency-shift keying approach is best. Since it is desirable to keep the signal bandwidth as narrow as possible, use of the present standard FSK shifts of 170 and 425 Hz is recommended. Use of 170-Hz shift would minimize one's bandwidth, at the expense of reduced advantage from diversity operation (the wider the mark-space frequency separation, the better the diversity receiver will work).

On the other hand, on a band that is not too crowded, 425-Hz shift can be used and the system will be a loser to being immune to narrowband interference. A shift of 850 Hz would offer even more diversity advantage and also allow a faster signaling speed, but I

am not recommending it due to the greater bandwidth required.)

Speeds

Once the frequency shifts are chosen, the maximum signaling speed is set also. This occurs because the significant sidebands produced around each tone frequency must be separated enough to allow reliable detection at the receiver. Analysis shows that we should be able to use a pulse width as short as 7.84 milliseconds (ms) with 170-Hz shift and still allow adequate separation between the mark and space sidebands. With 425 Hz, a minimum pulse width of 3.14 ms should be usable. Both these schemes would require good quality detection filters at the receiver. And in both cases, the system could be slowed down from this maximum rate when band conditions are bad so that added interference immunity could be gained from the longer pulse times.

If we assume use of an asynchronous 8-bit ASCII code, the 7.84-ms pulse width yields a speed of 12 characters per second (cps) and the 3.14-ms width yields 30 cps. Overall emitted bandwidth of the 170-Hz shifted signal at 12 cps would be about 340 Hz, and that of the 425-Hz shifted signal at 30 cps would be about 850 Hz.

Coding

While the Baudot code presently in use for RTTY is most efficient for sending text messages (it requires only a 5-bit code), the 8-bit ASCII code set (with its capability to send special characters and represent full 8-bit computer words) is superior when transmission of all sorts of data is considered. The only penalty in the use of ASCII will be that pure text messages will require slightly longer trans-

mission times than if Baudot coding had been used.

I recommend that we use asynchronous ASCII coding for our inter-computer communications because the design of the receiving hardware and software is simpler. Also, the timing accuracy requirements of the sending and receiving computers are greatly reduced compared to those required with synchronous codes (no start or stop pulses). The code will use a 1-unit start pulse, 8 bits of data, and a 1.5-unit stop pulse—similar to present RTTY coding.

We can take a tremendous step and obtain error-free reception of data by employing error-detecting or error-correcting codes in our scheme. These are special methods of coding the basic ASCII characters of a message so that the receiving computer can determine, after it has received the full message, whether there were any errors in it. If there were, it can request a retransmission of portions of the message from the sending computer. The sending computer can retransmit data blocks that were garbled in transmission whenever necessary until the receiving computer has received the entire message correctly. (There is a catch, of course, in that as more transmission errors occur, data blocks must be retransmitted more often, and the longer it then takes to receive the entire message error-free.)

Since we can expect a lot of interference on the ham bands, it is best to break up the data we are sending into small blocks containing perhaps 16 or 32 characters each. A typical transmission might contain 20 or 30 blocks, and only garbled blocks would need to be repeated, not the entire transmission. (This is known as "block coding.")

Diversity

As mentioned earlier, the use of FSK with block coding and error-detecting or error-correcting codes will in turn allow the use of diversity receivers. After detecting both the mark and space signals complete with error-detecting information, the receiving computer can request retransmission of garbled blocks. Since the receiving computer need receive only one of the two signals without garble to receive a complete block, the system is now much more nearly immune to narrowband QRM and selective fading.

What Now?

The hardware and software needed to implement all of these ideas has not yet been completed, but it is under development. Much experimentation will still be required, even within the framework of ideas presented here, to determine which of the several possible schemes is really optimum for use on the HF bands for computer linking. The most experimentation will probably be required in determining which of the many available error-detection and error-correction schemes we want to use. I am starting to work along these lines and would like very much to hear from others interested in participating in this development effort.

The ideas presented here are intended to be a starting point for discussion and experimentation within the amateur community, with the eventual goal being an optimum agreed-to standard for inter-computer communications on the HF bands. Let's give this topic some thought and ensure that the eventual FCC rules authorize us to use state-of-the-art techniques for linking our personal computers. ■

Ned Novice and his Capacitance Meter

— you, too, can build one

Ned Novice visited Mike Cord (the boy electronics wizard) the other day with a perplexing problem pertaining to plastic parts. Ned asked, "Mike, what are these?" and set a box of parts on the workbench.

Mike replied, as he pawed through the box of parts, "They seem to be capacitors with no markings as to value."

"Do you know a way to determine the value of these parts?" asked Ned quizzically.

"First of all," Mike replied, "let's get back to basics."

The Capacitor Defined

"My father's physics book should be of help. Hmm... Ah, yes, here it is... $Q=CV$. This says that the charge on a capacitor in coulombs is equal to the capacitance in farads multiplied by the voltage."

"How can that relationship be of use to me?" interjected Ned.

"Quite easy," replied Mike. "If we charge up a capacitor to a known voltage

and measure the coulombs, we will have it."

Ned thought for a few moments before retorting: "But I have never heard of a coulomb meter!"

Mike grinned and searched through his junk box for a few moments before coming up with a 0 to 100 microammeter. "With this we will measure your capacitors."

"You do have a coulomb meter, then," said Ned, hopefully.

Mike replied, "Look at it this way, Ned. The defini-

tion of the Ampere is one coulomb per second, so what we will do is measure the current."

Mike wrote the cryptic formula: $I=Qf=CVf$. "We will charge and discharge the capacitor at a frequency. The measurement of picofarads will be indicated by microamps," he stated in a firm voice, with the confidence one would expect only from a more mature individual.

The Circuit Designed

"Now for specific values," said Mike as he studied over the scratch pad for a moment. He wrote down: $V=4.5$ volts, $I=100$ microamperes, $C=100$ picofarads full scale.

"Therefore, $f=I/CV=222$ kHz!" exclaimed Mike as he turned off his calculator. "And to change ranges all you have to do is change frequency. Thus, 100 pF = 222 kHz, 1000 pF = 22.2 kHz, $.01$ uF = 2.22 kHz, $.1$ uF = 222 Hz, and 1 uF = 22.2 Hz."

Just then Mike's father entered the ham lab and asked what fun the boys were into today. Mike related all that had happened and asked his dad if he had any suggestions.

"So far, so good, Mike."

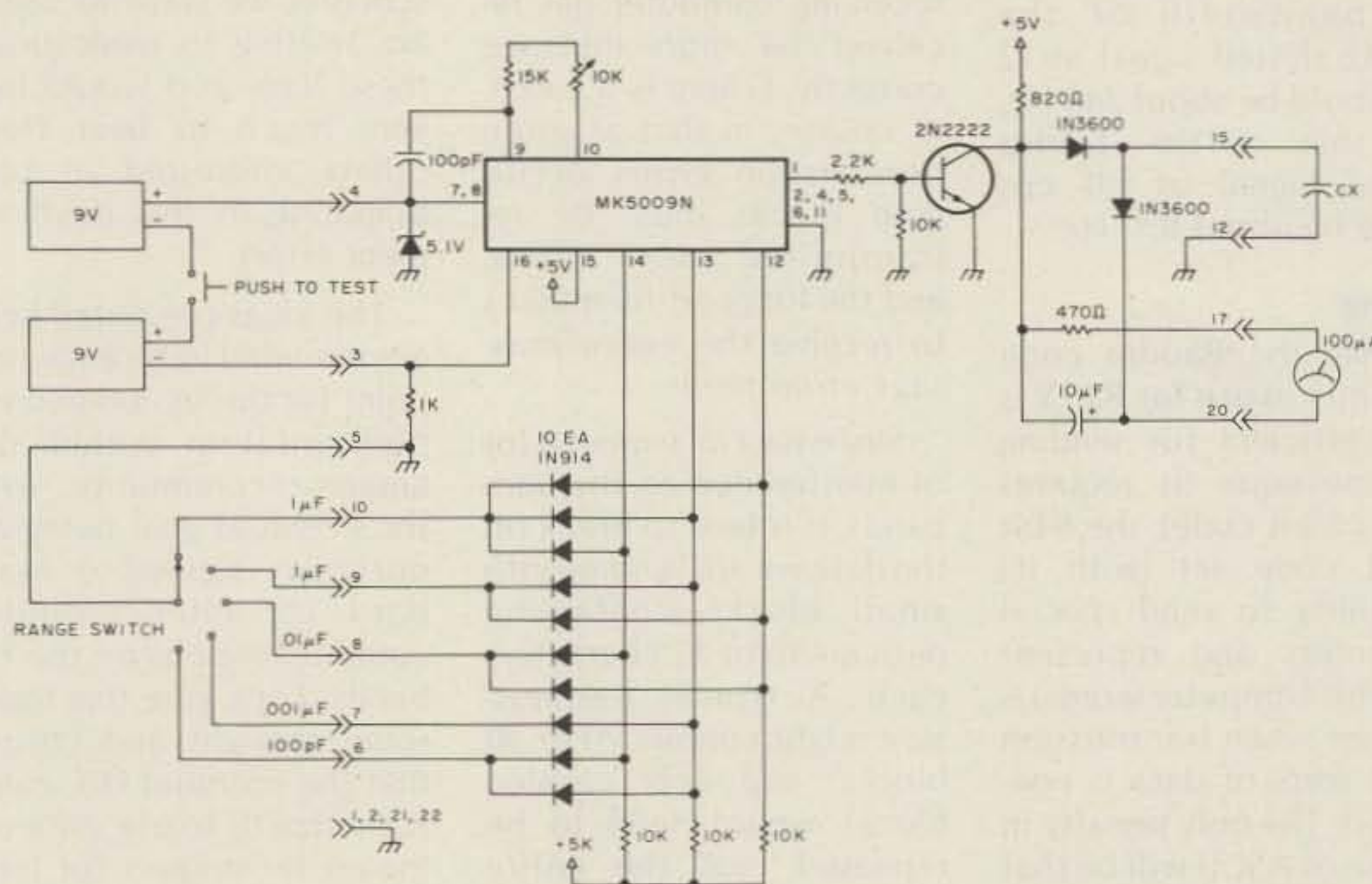

Fig. 1. Capacitor meter schematic.

PROFESSIONAL HEADPHONES & HEADSETS BOOM MIC HEADSETS

For the ultimate in communications convenience and efficiency select a boom mic headset. Long-time favorites of professional communications, boom mic headsets allow more personal mobility while always keeping the mic properly positioned for fast, precise voice transmission. Boom microphones are completely adjustable to allow perfect positioning. And, boom headsets leave both hands free to perform other tasks.

All models are supplied with "close talking" microphones to limit ambient noise pick-up and provide superior intelligibility. Each model as a convenient, inline push-to-talk switch, which can be wired for either push-to-talk relay control or mic circuit interrupt for voice operated transmitters. The switch may be used as a momentary push-button or it can be locked in the down position. All models have tough, flexible, 8 foot cords which are stripped and tinned, unterminated.

TELEX



Headphone Jack Box

Ham Clubs, field day contest operation. No more jury rigs for multiple headphones. Six 1/4" phone jacks with individual volume controls, 4 foot cord with 1/4" phone plug. **\$14.30**



MODEL	C-610	SWL-610	C-1210	C-1320	CM-610	CM-1210	CM-1320	CM-1320S	PC-100	HTC-2	HMC-2	HFC-91
Headphone Sensitivity Ref 0002 Dynes/cm ² @ 1mW input, 1kHz	103dB SPL ±5dB	103dB SPL ±5dB	103dB SPL ±3dB	105dB SPL ±5dB	103dB SPL ±5dB	103dB SPL ±3dB	105dB SPL ±5dB	105dB SPL ±dB				
Headphone Impedance	3.2 20 ohms	2000 ohms	3.2 20 ohms	3.2 20 ohms	3.2 20 ohms	3.2 20 ohms	3.2 20 ohms	3.2 20 ohms	8 200 ohms	3.2 20 ohms	3.2 20 ohms	3.2 20 ohms
Microphone Frequency Response					50 8000 Hz	50 8000 Hz	50 8000 Hz	50 8000 Hz	50 1200 Hz	100 3000 Hz	100 3000 Hz	100 3000 Hz
Microphone Impedance					High	High	High	High	Low	Low	Low	Low
Microphone Sensitivity Below 1 volt/microbar at 1 kHz					51 dB ±5 dB	51 dB ±5 dB	51 dB ±5 dB	51 dB ±5 dB				
PRICE:	\$10.45	\$12.25	\$29.70	\$41.80	\$47.20	\$62.75	\$75.25	\$59.95	\$16.95	\$24.50	\$15.50	\$9.90

THOMSON-CSF NPC ELECTRONICS

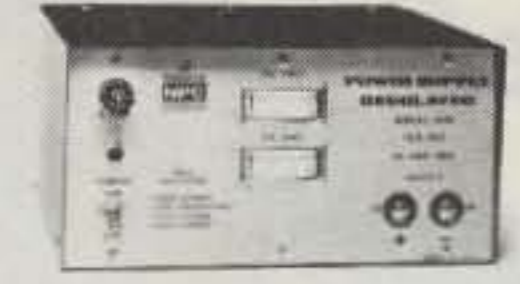

MODEL	PRICE	MODEL	PRICE
12V4	\$19.95	104R	\$ 59.95
102	26.95	108RA	89.95
107	36.95	108RM	99.95
103R	42.95	109R	159.95

MODEL 109R \$159.95
NPC 25 Amp Regulated Power Supply. 4 Way Protected. Output Voltage and Current Meters.
Extra heavy-duty unit quietly converts 115 volts AC to 13.6 volts DC - 200 millivolts. 10 amps continuous, 25 amps max. All solid state. Features dual current overload, overvoltage and thermal protection. Ideally suited for operating mobile Ham radio and linear amplifier in your home or office. Excellent bench power supply for testing and servicing of mobile communications equipment.

MODEL 107 \$36.95



NPC 4 Amp Power Supply, 6 Amp Max. Solid State. Overload Protected.
Functions silently in converting 115 volts AC to 12 volts DC. 4 amps continuous, 6 amps max. Enables anyone to enjoy CB radio, car 8-track cartridge, cassette player or car radio in a home or office.

MODEL 12V4 \$19.95



NPC 1.75 Amp Power Supply. 3 Amp Max.
Functions silently in converting 115 volts AC to 12 volts DC. Ideally suited for most applications including 8-track stereo, burglar alarm, car radio and cassette tape player within power rating.

MODEL 108RM \$99.95



NPC 12 Amp Regulated Power Supply. Solid State. 3 Way Protected. Current Meter.
This heavy-duty unit quietly converts 115 volts AC to 13.6 volts DC - 200 millivolts. 8 amps continuous, 12 amps max. All solid state. Features dual current overload and overvoltage protection. Ideally suited for operating mobile Ham radio 2 meter AM/FM USB transceiver in your home or office. Can also be used to trickle-charge 12 volt car batteries.

MODEL 104R \$59.95



NPC 6 Amp Power Supply Regulated. Solid State. Dual Overload Protection.
Converts 115 volts AC to 13.6 volts DC - 200 millivolts. Handles 4 amps continuous and 6 amps max. Ideally suited for applications where excellent DC stability is important, such as CB transmitter, small Ham radio transmitter, and high quality eight-track car stereo. Can be used to trickle-charge 12 volt car batteries.

MODEL 103R \$42.95



NPC 4 Amp Regulated Power Supply. Solid State. Dual Overload Protection.
Converts 115 volts AC to 13.6 volts DC - 200 millivolts. Handles 2.5 amps continuous and 4 amps max. Ideally suited for applications where no hum and DC stability are important such as CB transmitter, small Ham radio transmitter, and high quality eight-track car stereo. Can also be used to trickle-charge 12 volt car batteries.

MODEL 102 \$26.95



NPC 2.5 Amp Power Supply. 4 Amp Max. Solid State. Overload Protected.
Functions silently in converting 115 volts AC to 12 volts DC. 2.5 amps continuous, 4 amps max. Enables anyone to enjoy CB radio, car 8-track cartridge, cassette tape player or car radio in a home or office.

Unarco-Rohn

COMPLETE 25G TOWER PACKAGES

50' Guyed Tower: Includes top section, 4 regular sections, base plate, rotor plate, 50' guy wire, 2 guy assemblies with torque bars, 3 concrete guy anchors and other miscellaneous hardware.

REGULAR PRICE \$698.00
SALE PRICE 499.00
SAVE \$199.00

50' Bracketed Tower: Includes top section, 4 regular sections, base plate, rotor plate and universal house bracket.

REGULAR PRICE \$430.00
SALE PRICE 299.00
SAVE \$131.00

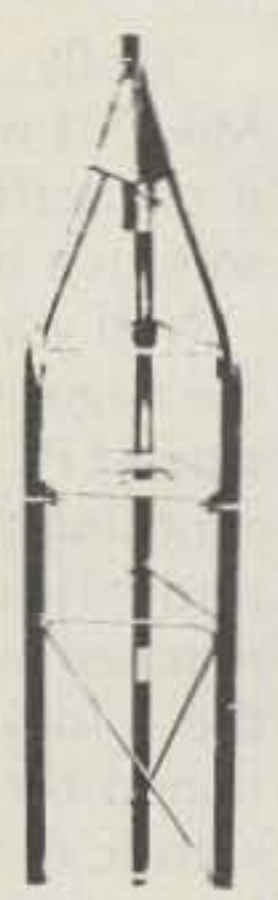



\$299.00

BEARCAT 220
Aircraft, Marine, Public Service. The 220 adds features and advanced sophistication.

- Aircraft and Marine — press button to search entire Aircraft Band, another for Marine
- 7 Bands — Low, High, UHF, UHF-T, 2m amateur and 75 CM Ham — plus the Aircraft Band
- 20 Channels — scan up to 20 frequencies or either of two banks of 10 channels each
- Automatic Search — Selective Scan Delay — Automatic Lock-Out — Patented Track Tuning — Manual Scan Control — Single Antenna
- Priority — automatically samples designated channel every two seconds
- AC/DC operation



BEARCAT 300 \$429.95

Service Search
Over 2100 pre-programmed frequencies.

- 11 Service Search categories arrange stored frequencies into "interest" groups — Police, Fire, Marine, HAM, Emergency, Telephone, Government, Forestry, Industrial, Transportation and Aircraft.
- 50 Channels/5 bands
- 7 Bands (Low & High VHF, UHF, and UHF-T, AM Aircraft, 2m & 75 CM Amateur)
- Non-volatile memory, AC/DC
- Automatic Search with Hold & Resume functions
- Patented Selective Scan Delay
- Vacuum Fluorescent Decimal-Display with Dimmer Control
- Speed Control
- Quartz Clock
- Patented Track Tuning
- Direct Channel Access
- Automatic Squelch

Bearcat



NEW!

\$149.95

BEARCAT®
FOUR-SIX
THIN SCAN™

More bands, more channels — more scanning capabilities than other Hand-Helds.

- 4 Bands (Low, High, UHF and UHF-T)
- 6 Channels — more monitoring capacity
- "Rubber Ducky" Antenna
- Belt Clip frees hands while monitoring
- 8 channels per second scan speed
- Automatic or manual scanning
- Individual channel lock-outs
- Portable — weighs only 12 ounces
- Battery operated (6 Vdc)



\$199.95

BEARCAT 210

The one that pioneered synthesized scanning — and unlocks new channels of communication.

- No crystals to buy — full 6-band coverage.
- Keyboard programming makes frequency selection as easy as punching a push-button telephone.
- Decimal display and exclusive rolling zeros to show what's being programmed and monitored.
- Automatic search for finding new frequencies.



PUNCHES THROUGH LOUD and CLEAR

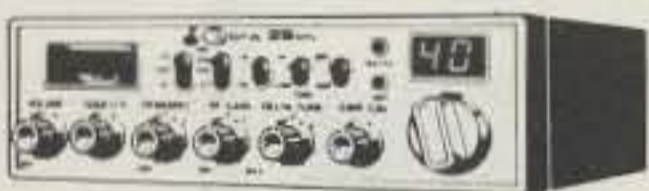

Only \$179.00

Cobra 29GTL Recognized Industry Standard
Cobra's most popular CB mobile—the "Truckers' choice".

- Delta tune • DynaMike • Antenna warning indicator • Illuminated S/R/F:SWR meter • Switchable automatic noise limiting and noise blanking



Only \$89.95
Cobra 78X Dollar Saver

Talk to the best of them with this economy-sized, economy-priced CB: • Large illuminated tuning dial • Sensitive squelch control • Full range volume control • PA jack • Legal maximum output of four watts



Only \$124.95

Cobra 25GTL Full Feature Compact
You'll know your voice is out there being heard: • "DynaMike" • LED channel display with brightness control • LED transmit/receive indicator • PA/external speaker jacks • RF gain control



Only \$96.00

Cobra 21GTL Command Performance/"Mini" Size
Has all the beef to punch through loud and clear: • Digital LED channel display • "DynaMike" • Switchable automatic noise limiting • Illuminated S/R/F Meter and much more



Only \$249.95

The Cobra 140GTL mobile gives you maximum distance with 12 full watts of power, plus quieter communications and 120 channels (80 on sideband). A perfect match for the Cobra 142GTL!



Only \$359.95

Cobra 142GTL CB Base Station

The COBRA 142GTL SSB/AM Base Station is for CB-ers who want extra distance, full 12 watts of power, quieter communications due to elimination of AM "clutter," and 120 channels — 80 of them on sideband.

avanti antennas

base stations

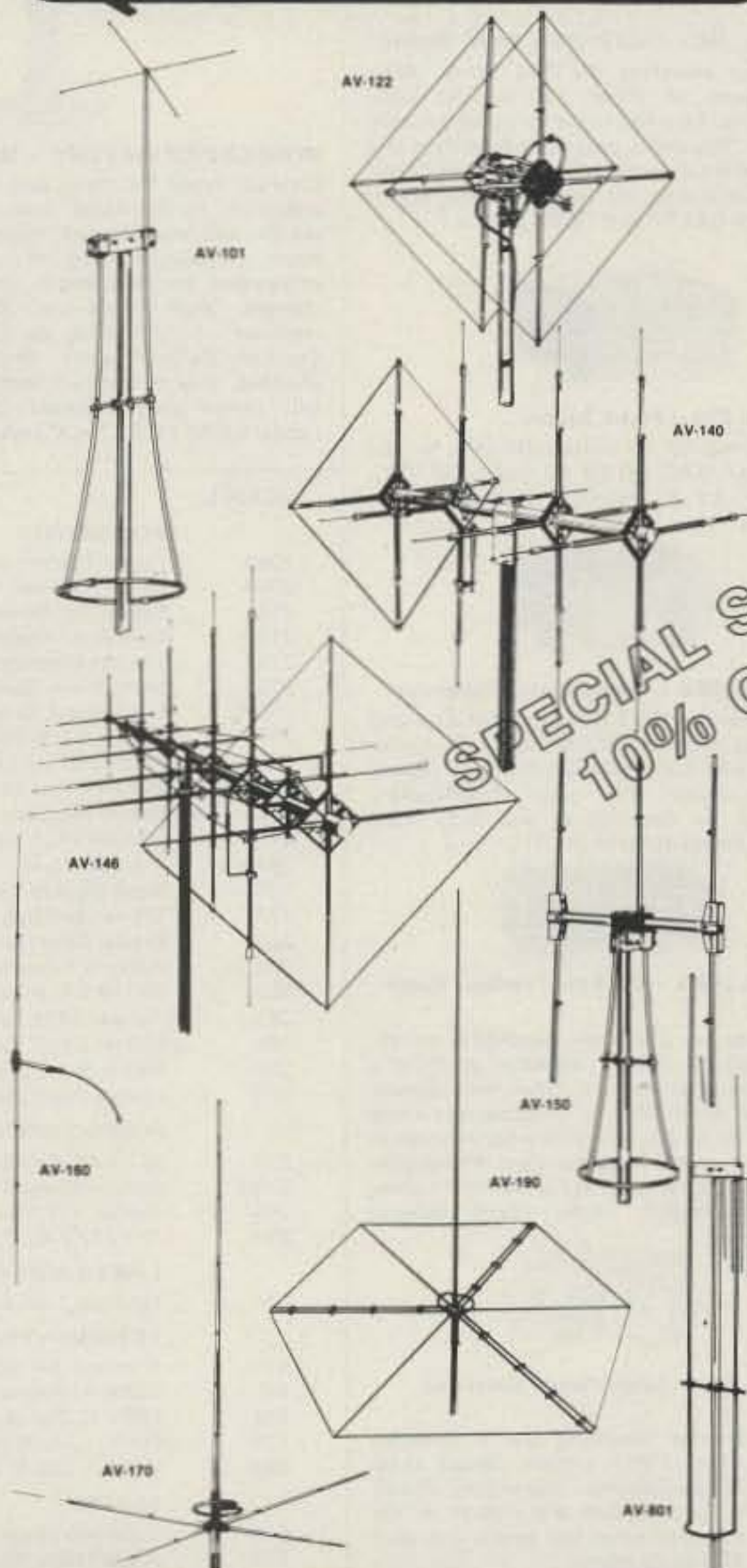

CB Antennas

AV-101 ASTRO PLANE™ — Patented performance. Best value available today in an omni directional base antenna.

\$47.95

AV-122 PDL II™ — Patented design dual polarity antenna with orbital gamma match. Light weight and long range communication in a beam antenna. Five elements on each polarity.

\$199.95

AV-140 MOONRAKER® — America's most popular and most imitated CB antenna design in a dual polarity beam. Includes cast aluminum hubs, stainless steel tip wires and many other Avanti quality features.

\$515.95

AV-146 MOONRAKER® — King of CB antennas. All the quality features of Avanti Moonraker 4 plus the exclusive 4-way boom support that protects against structural failures common to competitor's super big beam antennas.

\$99.95

AV-150 ASTRO BEAM™ — Big power in a small package. Unprecedented 40 dB front-to-back ratio in three element vertical beam.

\$29.95

AV-160 RAMROD™ — The versatile all purpose antenna • CB • low or high band Business radio • short wave listening • monitor • TV-FM • civil defense • amateur • aircraft • marine • experimenting • a no nonsense full 1/2 wave antenna that is fully adjustable from 25 to 175 MHz (adjustment chart provided).

\$29.95

AV-170 SIGMA II™ — Second generation 5/8 wave with incredibly low S.W.R., 5.14 dBi gain. New static arrester system. Easy installation. New H.D. mounting tube. Aircraft quality aluminum. New low price.

\$89.95

AV-190 SATURN™ — New scientific breakthrough. Now vertical and horizontal polarity in an omni directional antenna. Strong, long distance power in a unique dual polarity design. Unsurpassed omni power gain and SWR characteristics. Static arrester system for clearest possible communications in all weather conditions. Easy assembly — aero space light, high strength construction tested to withstand years of wind and weather. Switchbox included.

\$199.95

Tri-Band Monitor Antenna

AV-801 ASTRO SCAN™ — A patented Tri-band base monitor design with no compromises. Unmatched gain over the whole tri-band range from 25 MHz to 512 MHz, including the new "T" band. Aerospace light construction of aircraft quality aluminum and stainless steel is well balanced on the mast to withstand years of severe wind and weather.

\$34.95

SPECIAL SAVE 10% OFF

TUFTS Electronic Department Store TUFTS

TUFTS Electronic Department Store TUFTS

OMNI TEN-TEC, INC.



OMNI-Series C.

OMNI moves boldly forward to meet the new decade. With new features, new conveniences, new techniques, and new band coverage. Full amateur band coverage from 160 through 10 meters. With its new hf capability, OMNI-C covers all six of the present hf bands and all three of the new hf bands. Crystals are supplied for seven bands (crystals for 18 and 24.5 MHz bands will be available when the bands are ready). New built-in noise blanker is standard equipment in the OMNI-C. A new design with a 2-pole monolithic crystal filter to handle the big signals with ease, to make impossible locations usable. New "Hang" AGC for smoother operation, less abrupt action.



Model 255 - Deluxe Power Supply/ Speaker Combination.

Includes the electronics of Model 280 power supply plus a built-in 3" x 5" front facing speaker.

NOVICE SPECIAL



570

Century 21 (570)

Novice Exclusive

Purchase your Century 21-570 from us and have up to one year to apply the full purchase price towards a Ten-Tec model of your choice when you upgrade your station.



MODEL 243 - Remote VFO

A duplicate of the OMNI VFO, Model 243 VFO, is housed in a matching enclosure and provides 6 modes of dual frequency operation. LEDs indicate selection of any of six modes of operation. OMNI transmit and receive, REMOTE transmit and receive, OMNI transmit-REMOTE receive, REMOTE transmit-OMNI receive, OMNI transmit-both receive, or REMOTE transmit-both receive. Full break-in is retained in all modes. Frequency range and accuracy is the same as OMNI.

In addition to the remote VFO capability, Model 243 also has a 4-position crystal oscillator for fixed frequency operation. Out-of-band crystal frequencies (with some limitations) may be used as well as any n-band amateur frequencies.

Model 243 comes with connecting cable, less crystals. Power is obtained from the OMNI system. Semiconductors: 9 transistors, 5 diodes, 6 LEDs. SIZE: HWD 5 1/2 x 8 1/2 x 8. Wt.: 3 lbs.



DELTA - Transceiver

DELTA is the name of a great new TEN-TEC transceiver. All 9 HF bands. First new rig since WARC. 160m through 10, including the new 10, 18 and 24.5 MHz bands! With everything incorporated except the plug-in crystals for 18 and 24.5 MHz segments (available when bands open to amateurs). No receiver front end or final amplifier adjustments. From the pioneer in broadband design. 200 Watts input on all bands including 10m (with 50 ohm load). High SWR does not automatically limit output to a few watts. With a proven, conservatively rated final amplifier whose solid-state output devices are fully warranted the first year and pro-rata warranted for an additional five years. Has all the options you could want. Model 289 Noise Blanker, Model 282 200 Hz CW Filter, Model 285 500 Hz CW Filter, Model 283 Remove VFO, Model 287 Mobile Mount, Model 280 18A Power Supply with over-current and over-voltage protection. Other matching accessories include Model 645 Dual Paddle Keyer, Model 670 Single Paddle Keyer, Model 247 Antenna Tuner, Model 234/214 Speech Processor and Microphone, Models 215P and 215PC Ceramic Microphones, Model 252MO Power Supply.



MODEL 280 - Dual Primary Power Supply

Ideal for powering the DELTA or OMNI transceivers on either 115 or 230 VAC, 50-60 Hz. Easy to change for either primary voltage. Regulated output, over-voltage and over-current protected, and can be switched from transceiver or power supply. Styled to match DELTA and OMNI colors.



MODEL 210 - Power Supply

Delivers up to 15 watts, sufficient for the 515. 117 VAC, 50-60 Hz input, 13 VDC, ±0.5 V, 1.2 A. output. Solid-state. Finish matches 515.



MODEL 206A - Pulsed Crystal Calibrator

Companion to the 515, but useful with any receiving system. 25 and 100 kHz fundamental with harmonics into the VHF region. Pulsed output for easy identification. Powered by the 515 or any 9-12 VDC source. Finish matches the 515.



MODEL 208A - CW Filter/Variable Notch Filter.

CW filter has 3-position bandwidth switch, 450, 300, or 150 Hz, centered at 750 Hz; "off" position removes filter from circuit. Variable notch filter is effective over range of 200 Hz to 3.5 kHz with a depth down to 50 dB or more. Together these filters offer superb defense against unwanted signals, allow operation under most adverse conditions.



MODEL 670 - Single Paddle Electronic Keyer

Uses transistor switching and is powered through the OMNI system. Speed 6-50 wpm. Self-completing characters. Preset weighting for optimum articulation in the most used speed range (dit length increased approx. 10% at 20 wpm).



HERCULES 444

All Solid-State KW Linear Amplifier

No tubes, no tuning, full coverage: 160-15m, bands switched from OMNI panel or linear, instant break-in. 1000 Watts input, all bands. 600 Watts output, typical. Forced air cooling, automatic line voltage correction, automatic exciter by-pass, black-out meter panel, 6 status monitors with LEDs. Two meters - collector current and voltage - forward and reverse power. Negative ALC voltage, adjustable. Built-in control power supply. Tape wound transformer and choke in, separate power supply. 117/230 VAC. Styles to match OMNI.



MODEL 247 - Antenna Tuner.

Matches 50 ohm unbalanced output of OMNI to variety of balanced or unbalanced antenna impedances. Universal Transmatch circuit. 46-tap inductor allows vernier adjustment. 200 watts intermittent, 100 watts continuous.

MODEL 217 - 500 Hz 8-Pole Crystal Ladder CW Filter

MODEL 218 - 1.8 kHz 8-Pole Crystal Ladder SSB Filter.

MODEL 219 - 250 Hz 6-Pole Crystal Ladder CW Filter.



MODELS 215P and 215PC - Microphones

Ceramic types for hand held or desk top operation. Include cable, 3-circuit plug, PTT switch, and separate desk stand. Offer optimum articulation, free of power peaks, impervious to temperature and humidity changes. High impedance; 200-4000 Hz response; -50 dB level; die cast zinc and Cyclocac; 8 1/2" h; 4" cable, single conductor shielded, two conductors unshielded. 3-circuit phone plug included. 215P has 4' regular cable; 215PC has 4' coiled cable.



Argonaut 515 - ORP Transceiver

Totally solid state, full band coverage: 3.5, 7, 14, 21, and 28 MHz (optional crystals for 29-30 MHz). 10m band now in four 500 kHz segments for greater bandwidth. Improved receiver sensitivity: 0.35uV for 10 dB S+N/N, max. Four-pole 9 MHz crystal filter, 2.4 kHz Bandwidth, 1.7 shape factor. New heterodyne VFO with new permeability tuned oscillator for new frequency calibration accuracy. Direct frequency readout with new dial pointer zero-set. WWV receive at 10 and 15 MHz. Offset receiver tuning with new LED indicator. Receiver resonate control. New design no-tune broadband final amplifier. New LED rf output indicator flashes on 2 Watt voice peaks, PTT.



MODEL 645 Dual Paddle Electronic Keyer

The 645 keyer uses transistor switching and is powered by the transceiver. Adjustable magnetic paddle return. Paddle force 5-50 gms. Speed 6-50 wpm. Weighting ratio 50-150% of classical dit length. Self-completing characters. Dit and dah memories with defeat switches. Torque drive paddles with 4 ball bearing pivots. Powered through the OMNI system.



MODELS 214/234 - Speech Processor and Microphone

Extends operating range of ssb transmitters under adverse and low propagation conditions. Converts audio signal into ssb signal, clips and processes it through 4-pole monolithic filter for greater average envelope power and converts signal back into audio. Adjustable levels of processing and output plus disable switch and passband adjustment. Powered through the OMNI system or by calculator type plug-in AC adapter which supplies 12 VDC @ 75 mA. Model 214 Electret Microphone is designed specifically to be used with Model 234 Processor.

MODEL	DESCRIPTION	PRICE
ACCESSORIES		
206A	Crystal Calibrator	\$ 34.50
208A	Notch/CW Filter for Model 515	39.00
212	Crystal, for Model 515, 29.0-29.5 MHz	5.00
213	Crystal, for Model 515, 29.5-30.0 MHz	5.00
214	Electret Microphone for Model 234	39.00
215P	Microphone, Ceramic with plug	29.50
215PC	Microphone, Ceramic with plug and coil cord	34.50
217	500 Hz 8 Pole Ladder Filter, for Models 545/546	55.00
218	1.8 kHz 8 Pole Ladder Filter, for Models 545/546	55.00
219	250 Hz 6 Pole Ladder Filter, for Models 545/546	50.00
234	Speech Processor	124.00
243	Remote VFO, for Models 545/546	139.00
247	Antenna Tuner	69.00
248	Noise Blanker, for Models 545/546	49.00
273	Crystal, for Model 570, 28.5-29.0	5.00
276	Crystal Calibrator, for Model 570	29.00
277	Antenna Tuner/SWR Bridge, for Model 570	85.00
282	250 Hz 6 Pole Ladder Filter, for Model 580	50.00
283	Remote VFO, for Model 580	179.00
285	500 Hz 6 Pole Ladder Filter, for Model 580	45.00
287	Mobile Mount, for Model 580	TBA
289	Noise Blanker, for Model 580	\$ 39.00
POWER SUPPLIES		
210	117 VAC, 13 VDC, 1A	\$ 34.00
210/E	Same as Model 210, but 115/230 VAC	39.00
255	Deluxe, 117 VAC, 13.5 VDC, 18 A with 3" x 5" speaker	169.00
280	117/230 VAC, 13.5 VDC, 18 A	139.00
LINEAR AMPLIFIERS		
444	Hercules, 1 kW with 115/230 VAC Power Supply	\$1575.00
TRANSCIVERS		
515	Argonaut, 5W, SSB/CW, 3.5-30MHz	\$ 429.00
545	OMNI-A, Analog, Series B, SSB/CW, 1.8-30 MHz	949.00
546	OMNI-D, Digital, Series C, SSB/CW, 1.8-30 MHz	1189.00
570	Century/21, 70 W, CW, 3.5-29 MHz	349.00
580	DELTA, 200 W, SSB/CW, 1.8-30 MHz	849.00
KEYERS		
645	Ultramatic, Dual Paddle	\$ 85.00
670	Single Paddle Keyer	34.50

DRAKE



TUFTS Electronic Department Store TUFTS

Drake "Dry" Dummy Loads—no oil required



\$53.00

\$26.95

Model 1551 Drake DL-1000
 • 1000 watts for 30 seconds with derating curve up to 5 minutes. Designed to accept Drake FA-7 cooling fan for extended high power operation.
 • VSWR of 1.5:1 max. 0-30 MHz.
 • Provided with SO-239 coax connector, and rubber feet for desk or bench use.
 • Size 14" x 3.8" (35.6 x 9.1 cm) Wt. 2 lbs (910 g)

Model 1550 Drake DL-300
 • 300 watts for 30 seconds with derating curve to 5 minutes.
 • Built-in PL-259 coax connector for direct connection to rear of transmitter or transmitter — no jumper coax necessary.
 • VSWR of 1.1:1 max. 0-30 MHz 1.5 max. 30-160 MHz.
 • Ideal as bench test device for amateur or commercial hf and vhf gear.
 • Small size fits conveniently in any field service tool box. 6.7" x 2.08" (17.0 x 5.3 cm) Wt. 11 Oz (310 g)



Drake L-7
2kW Linear Amplifier
 10m-160m coverage. 2kW PEP, 1kW CW, RTTY, SSTV operation — all modes, full rated input, continuous duty cycle. Accurate built-in rf wattmeter, with forward/reverse readings, is switch selected. By-pass switching for straight through, low power operation without having to turn off amplifier. Bandpass tuned input circuitry for low distortion and 50 Ohm input impedance. Operates from 120/240 Vac, 50/60 Hz primary line voltage.



Drake UV-3
UHF-VHF FM Transceiver
 • Fully synthesized on each band, 5 kHz steps, digital readout.
 • FM coverage on complete 144, 220 and 440 Amateur bands, depending on model purchased. Completely band-switched from front panel.
 • Four extra diode programmable fixed channels, with offsets, available for each band, in addition to the synthesizer.
 • Diode programmable non-standard offsets available for each band.
 • Separate SO-239 Antenna Connector for each band.
 • Scan a programmed fixed channel from any synthesizer frequency. Scan any synthesizer frequency from a programmed fixed channel. Scan a specific programmed fixed channel from another programmed fixed channel.

UV-3 OPTIONAL ACCESSORIES:
 • Removable control head will operate radio in trunk compartment from driver's seat.
 • PS-3 — companion ac power supply.
 • Drake 1525EM Encoding Mike.

DRAKE PRICE LIST

MODEL NUMBER	MODEL	DESCRIPTION	PRICE
COMMUNICATIONS RECEIVERS AND ACCESSORIES			
1242	DSR-2	VLF-HF Digital Synthesized SSB, AM, CW, RTTY, ISB Laboratory Communications Receiver	\$3400.00
1240	R7-/DR-7	0-30 MHz General Coverage, Digital Synthesized Receiver	1449.00
1548	R-7/TR-7	Cable Interface Kit	24.50
1532	NB-7A	Noise Blanker for R-7	90.00
7021	SL-300	300 Hz CW Filter for 7-line	55.00
7022	SL-500	500 Hz CW Filter for 7-line	55.00
7023	SL-1800	1800 Hz RTTY Filter for 7-line	55.00
7026	SL-4000	4000 Hz AM Filter for R-7	55.00
7024	SL-6000	6000 Hz AM Filter for 7-line	55.00
1531	MS-7	Speaker for 7-line	39.00
1217	4-NB	Noise Blanker for R-4C	74.00
7011	FL250	250 Hz CW Filter for R-4C	55.00
7013	FL-500	500 Hz CW Filter for R-4C	55.00
7015	FL-1500	1500 Hz RTTY Filter for R-4C	55.00
7017	FL-4000	4000 Hz AM Filter for R-4C	55.00
7019	FL-6000	6000 Hz AM Filter for R-4C	55.00
VHF-FM TRANSCEIVERS AND ACCESSORIES			
1330	UMK-3	Remote Trunk Kit for UV-3	69.95
1339		Extra Control Head for UV-3	90.00
1525	1525EM	Encoder Microphone for UV-3	49.95
AMPLIFIERS			
1528	L-7	160-15m Amplifier, Power Supply	1090.00
1578	L-7E	160-10m Amplifier, Power Supply	1090.00
ANTENNA TUNERS AND ACCESSORIES			
1538	MN-7	250W, 160-10m Tuner	175.00
1539	MN-2700	2KW, 160-10m Tuner	299.00
1510	B-1000	4:1 Balun for MN-7/MN-2700	26.95
1533	CS-7	Remote Controlled Antenna Switch	169.00
1514	WH-7	1.8-54 MHz 20/200/2000 Wattmeter	99.00
1550	DL-300	300W Dummy Load	26.95
1551	DL-1000	1000W Dummy Load	53.00
1529	FA-7	Fan for DL-1000/TR-7/PS-7	29.00
HF TRANSCEIVERS AND ACCESSORIES			
1336	TR-7/DR-7	Digital HF transceiver 160-10m (receives 1.5-30MHz)	\$1549.00
1537	NB-7	Noise Blanker for TR-7	90.00
7021	SL-300	300 Hz CW Filter for 7-line	55.00
7022	SL-500	500 Hz CW Filter for 7-line	55.00
7023	SL-1800	1800 Hz RTTY Filter for 7-line	55.00
7024	SL-6000	6000 Hz AM Filter for 7-line	55.00
1536	AUX-7	Auxiliary Range Program Board for TR-7 (for out of band coverage)	45.00
1546	RRM-7	Range Receive Modules	8.50
1547	RTM-7	Range Transceive Modules	8.50
1529	FA-7	Fan for TR-7/PS-7/DL-1000	29.00
1338	RV-7	Remote VFO for TR-7	195.00
1531	MS-7	Speaker for 7-line	39.00
1335	MMK-7	Mobile Mount for TR-7	49.95
7073	7073	Dynamic Mobile mic. w/Plug TR-7	24.50
7077	7077	Dynamic Desk mic. w/Plug TR-7	49.00
7037	7037	TR-7 Service Kit	50.00
POWER SUPPLIES AND ACCESSORIES			
1501	AC-4	Power Supply for 4-line, 110/220V	\$ 150.00
1505	DC-4	12 VDC Power Supply for 4-line	195.00
1504	PS-3	Power Supply for UV-3, 110/220V	89.95
1502	PS-7	Power Supply for TR-7, 110/220V	299.00
1529	FA-7	Fan for PS-7/TR-7/DL-1000	29.00
LOW PASS AND HIGH PASS TVI FILTERS			
1605	TV-42LP	100W Low Pass Filter	14.60
1608	TV-3300LP	1000W Low Pass Filter	26.60
1603	TV-300HP	High Pass Filter for 300 Ohm Twin Lead	10.60
1610	TV-75HP	High Pass Filter for 75 Ohm	13.25
ACCESSORY CRYSTALS			
		Crystals for 2C/R4B/R4C/SW4A/SPR4/ML2/T4XB/T4XC/TR4C/TR4CW Crystals for fixed frequency operation of tunable units/2NT	9.50
		Crystals for TR22/TR22C	10.50
		Crystals for TR72/TR33C	9.50

TR7/DR7 TRANSCEIVER



In the past few years, several amateur transceivers have appeared on the market boasting features and techniques considered to be "state-of-the-art" in regards to communications technology. More often than not, these features and techniques have been incorporated without the initial expense of the development time necessary to assure that the resulting equipment represented an advancement in communications technology with respect to both performance and operator convenience.

The Drake TR7 Transceiver represents a unique blend of proven state-of-the-art techniques culminating in the first truly state-of-the-art transceiver presently available.

A product of the Drake "anything worth doing is worth doing right" philosophy, the TR7's many new techniques and operational features complement each other producing performance and convenience which will remain unexcelled for many years to come.

High Pass Filters for TV Sets

provide more than 40 dB attenuation at 52 MHz and lower. Protect the tv set from amateur transmitters 6-160 meters.



DRAKE TV-300-HP
 Model No. 1603
 For 300 Ohm twin lead. New terminals for easy installation.



DRAKE TV-75-HP
 Model No. 1610
 For 75 Ohm tv coaxial cable; tv type "F" connectors installed.

Low Pass Filters for Transmitters

have four pi sections for sharp cut off above the hf amateur bands and to attenuate transmitter harmonics falling in any tv channel and FM band. 52 Ohm. SO-239 connectors built in.



DRAKE TV-3300-LP
 Model No. 1608
 1000W max. below 30 MHz. Attenuation better than 80 dB above 41 MHz. Helps tv i-f interference, as well as harmonic interference.



DRAKE TV-42-LP
 Model No. 1605
 A four section filter designed with 43.2 MHz cut-off and extremely high attenuation in all tv channels for transmitters operating at 30 MHz and lower. Rated 100W input.

PALOMAR ENGINEERS



\$299.95

ANTENNA TUNER

Here is a new tuner that puts more power into your antenna, works from 160m-10m, handles full legal power and then some, and works with coax, single wire and balanced lines. And it lets you tune up without going on the air.

All tuners lose some rf power, mostly in the inductance coil and the balun core. To avoid this we switched from No. 12 wire for the main inductor to 1/4" copper tubing. It can carry ten times the rf current. And we've moved the balun from the output, where it almost never sees its design impedance, to the input where it always does. Thus more power to your antenna.

The biggest problem with tuners is getting them tuned up. With three knobs to tune on your transceiver and three on the tuner and ten seconds to do it (see the warning in your transceiver manual) that's 1 1/2 seconds per knob. We have a better way; a built-in 50 Ohm noise bridge that lets you set the tuner controls without transmitting. And a switch that lets you tune your transmitter into a dummy load. So you can do the whole tuneup without going on the air. Saves that final, cuts QRM.



TEMPO
the first in synthesized portables gives you the broadest choice at the lowest price

TEMPO

PRICE LIST

Tempo S-5	\$299.00
Tempo S-5 with touch tone pad	339.00
12 Button touch tone pad (not installed)	39.00
16 Button touch tone pad (not installed)	48.00
Tone burst generator	29.95
CTCSS sub-audible tone control	29.95
Rubber flex antenna	8.00
Leather holster	16.00
Cigarette lighter plug mobile charging unit	6.00
Matching 30 watt output 13.8 VDC power amplifier (S30)	89.00
Matching 80 watt output power amplifier (S80)	149.00
Tempo S-2	349.00
Tempo S-2 with touch tone pad	399.00
Tempo S-1	259.00
Tempo S-1 with touch tone pad	289.00

... the new S-5

- ★ The only synthesized hand-held offering 5 watts output. (Switchable for 1 or 5 watt operation)
- ★ The same dependability as the time proven S-1. Circuitry that has been proven in more than a million hours of operation.
- ★ Heavy duty battery pack.
- ★ Telescoping whip antenna.
- ★ Ni-cad battery pack, charger.
- ★ External microphone capability.

the Tempo S-2

- ★ Tempo is first again. This time with a superior quality synthesized 220 MHz hand-held transceiver. With an S-2 in your car or pocket you can use 220 MHz repeaters throughout the U.S. It offers all the advanced engineering, premium quality components and exciting features of the S-1. The S-2 offers 1000 channels in an extremely lightweight but rugged case.

If you're not on 220 this is the perfect way to get started. With the addition of the S-25 (25W output) or S-75 (75W output) Tempo solid state amplifier it becomes a powerful mobile or base station. If you have a 220 MHz rig, the S-2 will add tremendous versatility. Its low price includes an external microphone capability, heavy duty ni-cad battery pack, charger, and telescoping whip antenna.

Tempo S-1

- ★ The first and most thoroughly field tested hand-held synthesized radio available. 800 channels in the palm of your hand.
- ★ Simple to operate. (You don't need a degree in computer programming).
- ★ Heavy duty battery pack allows more operating time between charges.
- ★ External microphone capability.

R-X NOISE BRIDGE \$55.00



- Learn the truth about your antenna.
- Find its resonant frequency.
- Find R and X off-resonance.
- Broadband 1-100 MHz.
- Simple to use. — Self contained.

VLF CONVERTER \$59.95



- New device opens up the world of VLF radio.
- Converts VLF to 80 meters. For use with any shortwave receiver covering 3.5-4 MHz.
- Advanced design for simple operation, high performance.
- Gives reception of the 1750 meter band.
- Also covers navigation radiobeacons, WWVB, ship-to-shore, and LF broadcast band.

LOOP ANTENNA

Loop Amplifier \$67.50
Plug-in loops \$47.50 ea.

- Plug-in loops available for:
1600-5000 KHz (160/80 meter amateur bands)
550-1600 KHz (Broadcast Band)
150-550 KHz (VLF, 1750 meter band)
40-150 KHz (WWVB, Loran)
10-40 KHz (Omega)
- Nulls out interference



IC KEYS \$ 117.50



- Sends Manual, Semi-Automatic, Full Automatic, Dot Memory, Dash Memory, Squeeze and Iambic.
- More Features than any other keyer. Built-in sidetone, speaker, speed and volume controls.
- Fully Adjustable contact spacing and paddle tension. The perfect paddle touch will Amaze you.
- Battery Operated. Heavy shielded die-cast metal case. 3-lb. steel base.
- By the World's oldest manufacturer of electronic keys.

FREQUENCY STANDARD \$42.50

- 100, 50, 25, 10 and 5 KHz. Markers selectable by panel switch.
- Crystal controlled.
- A true secondary frequency standard.
- Square Wave Signal. Rich harmonics usable from 5 kHz to 50 MHz.
- Sharp Clear Output. Exclusive circuit suppresses unwanted markers.
- Battery Operated. No line cord. Self contained battery.



RF TRANSFORMER \$42.50



- Full 2000 watt CW (5-Kw PEP).
- Matches 32, 28, 22, 18, 12, 8, 5 ohm antennas.
- For all verticals and mobile whip antennas.
- Smaller size. Higher efficiency.
- RF ferrite toroid core.

500 W. RF TRANSFORMER \$35.00



- Full 500 watt CW capability. No time limit.
- Convenient switch selection of impedance taps.
- Small size. High efficiency.
- RF ferrite toroid core.

CW FILTER \$39.95



- Steep skirts. No ringing.
- Simulated-stereo technique filters QRM, improves copyability of CW signals.
- 80 Hz bandwidth.
- Eight pole IC filter.

ALL BANDS PREAMPLIFIER \$89.50



- Tunes 1.8 to 54 MHz. Covers ALL amateur bands 160 to 6 meters. ALL shortwave broadcast bands.
- For receivers AND transceivers.
- Up to 20 db gain.
- Peps up that tired receiver.
- Reduces image and spurious response.

BEAM BALUN \$47.50



- 3 Kw CW, 6 Kw PEP input power.
- U bolt for 2" boom.
- 1.7 - 30 MHz.
- 1:1 or 4:1 ratio available.
- All stainless steel hardware.

MODEL 2K BALUN \$42.50



- 3 Kw CW, 6 Kw PEP input power.
- Replaces center insulator.
- 1.7 - 30 MHz.
- 1:1 or 4:1 ratio available.

MODEL 1K BALUN \$22.50







- 1.5 Kw CW, 3 Kw PEP input power.
- Replaces center insulator.
- 1.7 - 30 MHz.
- 1:1 or 4:1 ratio available.

PALOMAR ENGINEERS

Tools, Parts, Accessories

Diagonal Pliers

-  **\$6.60**
Midget 4" size for close quarter work.
-  **\$7.13**
5" Plier for most cutting needs.
-  **\$8.87**
4" long, for fast, clean, easy tip cutting of fine wires in close quarters.
-  **\$7.48**
6" all-purpose diagonal plier.
-  **\$7.33**
7" diagonal pliers for heavy duty cutting.

Needle-Nose Pliers

-  **\$8.37**
*56CG
6" size Long, thin serrated jaws permit entry inaccessible to regular long nose plier.
-  **\$8.27**
*57CG
5 1/2" size with fine serrated jaws and coil spring for firm gripping and looping of wire.

Long-Nose Pliers

-  **\$6.85**
*41CG
Midget 4" pliers serrated jaws, without side cutters.
-  **\$7.92**
*51CG
6" long-nose pliers with side cutters.
-  **\$6.37**
*52CG
6" long-nose pliers without side cutters.

Xcelite® XST-5 — Super-Tru Tip (Phillips type) Screwdriver Set

Contains 5 pieces — all Phillips.



\$13.97

SDS-44 — Square Blade Screwdriver Set

Contains 5 Square Blade Screwdrivers for slot head screws. Catalog Nos S-141, S-3164, S-144, S-5166, S-388.

\$14.76

Adjustable Wrenches

Xcelite's exclusive thin-pattern design permits access where regular adjustables will not fit. Rugged construction, chrome-plated, polished heads, with quick one-hand adjustment and Cushion-Grip (CG).

- *44CG — 4" length, 1/2" opening **\$6.38**
- *46CG — 6" length, 3/4" opening **\$6.45**
- *48CG — 8" length, 1" opening **\$7.28**

Wire Strippers & Cutters

With Cushion Grip Handles

-  **\$2.63**
*100-X
Has adjustable screw stop for different wire sizes, and cushion grips. Cuts and strips both solid and stranded wire cleanly, neatly. Hardened with ground blades.
-  **\$3.32**
*101-S
Specifications same as 100 except with spring equipped self-opening handles.
-  **\$4.12**
*103-S
Has unique cam stop adjustment for different wire sizes. Cam adjustment stays put, won't move, even with screw loose. Fine for industrial use.
-  **\$10.08**
104CG Wire Stripper and Cutter
Cutter, stripper and crimper for all types and sizes of wire, with a wide size range bolt cutter. Features scissor action-up front wire cutting and wire stripping, bolt cutters, cushion grips, plier nose, hardened pivot joint bushing and crimp stations.

Quality Coaxial Cable for All Applications

- LOW LOSS CABLE • NON TARNISHING CONNECTORS
- FACTORY ASSEMBLED, TESTED FOR 100% RELIABILITY

RG58/U Type

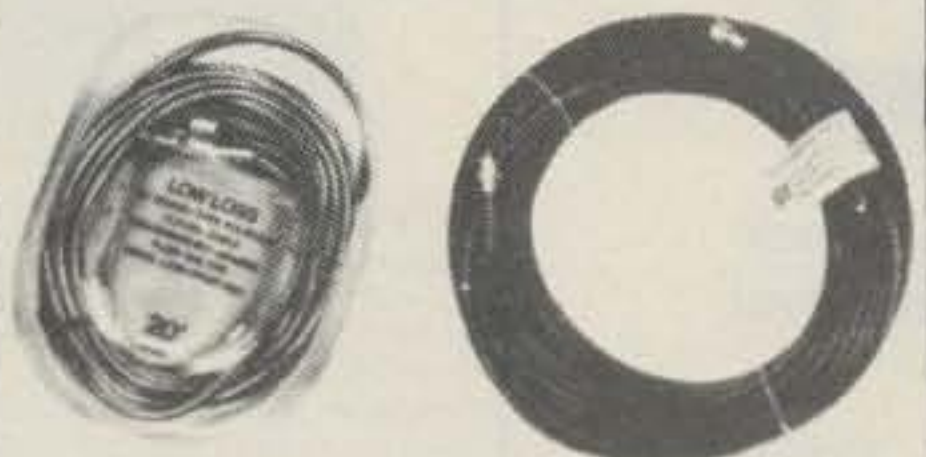

RG 58/U Type RG 8/U Low Loss Type

RG 8/U Low Loss Type

PART NUMBER	DESCRIPTION	APPLICATIONS
581-58018 *	18" length with UHF CB plugs on both ends.	Used as patch cords for mobile & base station SWR & power meters, antenna switches, and SWR matchers.
581-583 *	3' length with UHF CB plugs on both ends.	
581-585I *	5' length with UHF CB plug & spade lugs.	
581-5812L *	12' length with UHF CB plug & spade lugs.	Used to connect mobile CB sets to trunk, mirror, gutter or bumper mount antennas using spade lug terminations to the antenna.
581-5820L *	20' length with UHF CB plug & spade lugs.	
581-5812 *	12' length with UHF CB plugs on both ends.	Used to connect mobile CB sets to trunk, mirror, gutter or bumper mount antennas requiring a UHF CB plug termination to the antenna.
581-5820-259 *	20' length with UHF CB plugs on both ends.	
581-5850-420	50' length with UHF CB plugs on both ends.	Used where smaller diameter cable is required and signal loss is not critical.
581-5875-420	75' length with UHF CB plugs on both ends.	
581-58100-420	100' length with UHF CB plugs on both ends.	

PART NUMBER	DESCRIPTION	APPLICATIONS
581-83 *	3' lengths with UHF CB plugs on both ends.	Used as patch cords for mobile and base station SWR and power meters, antenna switches, & SWR matchers.
581-820	20' length with UHF CB plugs on both ends.	Used to connect mobile or base stations with antennas requiring a UHF CB plug termination at the antenna.
581-850-420	50' length with UHF CB plugs on both ends.	Used to connect base station CB sets with base antennas. Where loss is critical these cables will out perform RG 58/U cables of the same length.
581-875-420	75' length with UHF CB plugs on both ends.	
581-8100-420	100' length with UHF CB plugs on both ends.	

LAB QUALITY CABLES

BNC Test Voltage

1500 vac; Frequency: 0-4 GHz; Impedance: 50 Ohms nominal; Cable Retention Force: 60 lbs. minimum (RG-58C/U)

UHF Test Voltage

1500 vac; Frequency: 0-500 MHz; Impedance: Non Constant; Cable Retention Force: 60 lbs. minimum (RG-58C/U)



50 ohm UHF Plug to UHF Plug

- No. 651 3 feet \$ 6.52
- No. 652 5 feet \$ 7.05
- No. 653 10 feet \$ 8.34



50 ohm BNC Plug to UHF Plug

- No. 657 1 foot \$ 7.20
- No. 658 3 feet \$ 7.72
- No. 656 5 feet \$ 8.24



50 ohm BNC Plug to BNC Plug

- No. 668 3 feet \$ 8.91
- No. 662 5 feet \$ 9.43
- No. 666 10 feet \$10.73

TUFTS Electronic Department Store TUFTS

Panasonic



\$179.00
Panasonic RF-2200
International Band

Eight-band worldwide shortwave radio. AC or battery power. Includes AM, FM and six shortwave bands. Combination 2-stage selectivity and AFC switch. RF gain control. Separate bass, treble, and volume controls. FM/SW telescoping antennas. Four "D" batteries, AC power cord, and earphone included.



\$239.00
Command Series RF-2600

Six-band portable shortwave radio with all-band, five-digit fluorescent frequency display. SW frequencies from 3.9-28 MHz. FM/AM radio. Battery/signal strength meter. AFC on FM. RF gain control. 4" dynamic speaker. Comes with AC power cord, shoulder belt and earphone. Operates on 6 "D" batteries (not included).



\$249.00
Command Series RF-2900

Portable 5-band shortwave radio. Five-digit fluorescent display. SW from 3.2 to 30 MHz. RF gain control. BFO pitch control. Comes with AC power cord, shoulder belt, dial hood and earphone. Operates on 6 "D" batteries (not included).



\$399.00
Command Series RF-4900

Ten-band communications receiver with 5-digit, all-band fluorescent display. SW from 1.6 to 30 MHz. FM and AM frequencies. FET RF amplifier. BFO pitch control. RF gain control. Comes with earphone, AC power cord and headphone converter. Operates on 8 "D" batteries (not included).

Kantronics

Our smart machine reads sloppy copy.



NEW! INCLUDES 24-hour UTC Clock
110 and 300 baud ASCII, & tuning eye!

Kantronics **Field Day[®]** \$399.00

If someone tells you they offer the same features we do, check them out with the list below.

- Morse copying ability
- 3 to 80 WPM Morse range
- Computer programs for improving sloppy Morse
- Radioteletype copying ability - 60, 67.75 and 100 WPM Baudot
- ASCII radioteletype ability - 110 and 300 WPM baud
- Copies any shift of RTTY
- 24-hour UTC clock available in any mode
- Entire unit contained in one package
- Automatic code-speed tracking
- Full 10-character, large-size display
- Displays code speed
- Tuning eye for faster tuning
- Full year limited warranty
- Internal speaker
- Requires no TV set for use
- Advanced demodulator circuits
- Internal 200 Hz bandwidth filter
- All letters, numbers and punctuation plus special Morse characters and 5 special RTTY characters

DRAKE

See back cover for specials!

Drake R-7 / DR-7

Synthesized, General Coverage Receiver

- Fully synthesized with a permeability tuned oscillator (PTO) for smooth, continuous tuning.
- Covers complete range 0-30 MHz. Both digital and analog readout.
- Special low distortion "synchro-phase" AM detector provides superior international shortwave broadcast reception.
- Tunable IF notch filter effectively reduces heterodyne interference from nearby stations.
- Multi-function antenna selector/50 Ohm splitter is switch-selected from the front



\$1449.00

- panel. Provides simultaneous dual receive with the TR-7, making possible the reception of two different frequencies at the same time.
- Built-in power supply operates from 100, 120, 200, 140 Vac, 50/60 Hz, or nominal 13.8 Vdc.
- Much more!

See back cover for specials!

YAESU



FRG-7000 **\$599.00**

Digital Display Communications Receiver with CPU Digital Clock and Timer

- 0.25 Thru 29.9 MHz Coverage with 1 kHz Readout

Computer technology and convenience features are brought together in the FRG-7000, a digital-display general coverage receiver for the discriminating SWL. The digital clock and timer, controlled by a CPU (Central Processing Unit) chip, will read out both local and GMT time, and will control peripheral station equipment such as a tape recorder.



FRG-7 **\$299.00**

General Coverage Receiver

- 0.5-29.9 MHz Coverage with 10 kHz Readout

The FRG-7 is a precision-built all-purpose communications receiver, featuring all solid state construction for long life and high performance. Utilizing the Wadley Loop drift cancellation system, in conjunction with a triple conversion superheterodyne circuit, the FRG-7 boasts high sensitivity along with excellent stability.

KENWOOD

...pacesetter in amateur radio



Kenwood R-1000

The R-1000 is a highly advanced communications receiver. Up-conversion, PLL circuitry and other new technology provide optimum sensitivity, selectivity, and stability from 200 kHz to 30 MHz. Featuring easy-to-operate single-knob tuning and digital frequency display, it's perfect for listening to shortwave, medium-wave, and long-wave bands. Even SSB signals are received perfectly. Included is a quartz digital clock and timer.

\$499.00

R-1000 FEATURES:

- Continuous frequency coverage from 200 kHz to 30 MHz.
- 30 bands, each 1 MHz wide.
- Five-digit frequency display and illuminated analog dial.
- Quartz digital clock and ON/OFF timer.
- Multi-modes... AM (wide and narrow), SSB (USB and LSB), and CW.
- Three IF filters... 2.7 kHz for SSB and CW, 6.0 kHz for AM narrow, and 12 kHz for AM wide.
- Effective noise blanker, built-in speaker, three antenna terminals, rf step attenuator, tone control, recording terminal.
- Remote terminal, for access to timer relay ON/OFF circuit and muting circuit.
- SSB sensitivity of 0.5 μ V from 2 to 30 MHz.
- More than 60 dB IF image ratio.
- More than 70 dB IF rejection.

FINCO STINGER VHF/UHF Antennas

On this page Tufts brings you . . .
Finco Stinger **Hitachi**
Ham-Key **Alliance**

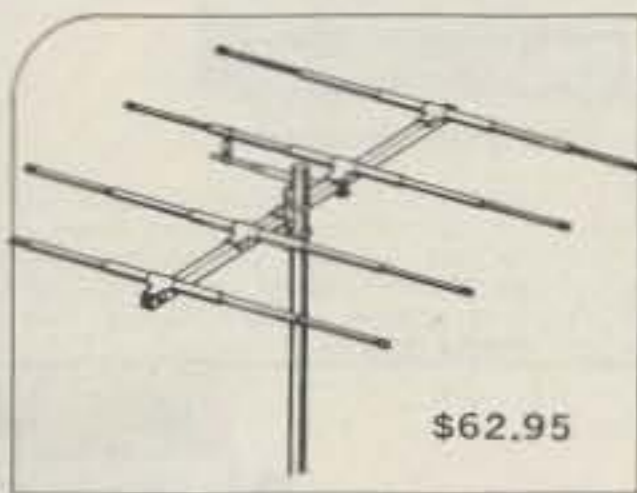

10 meter
STINGER A 10-4 DESCRIPTION
 The model Stinger A 10-4 is a wide spaced, full size, high gain four element 10-meter antenna designed for optimum DX performance. Utilizing the exclusive Stinger Series square boom construction, the A 10-4 is light enough to be easily stacked for an additional 3 dB gain yet strong enough to withstand the most adverse weather conditions. The highly efficient gamma match system easily withstands 2,000 watts P.E.P. of power and maintains a relatively low V.S.W.R. across the entire 10-meter amateur band.

SPECIFICATIONS - A 10-4

ELECTRICAL -	MECHANICAL -
Forward Gain 10dB	Boom Length 16 ft.
Front-to-Back Ratio 25dB	Longest Element 16.2 ft.
V.S.W.R. (at resonance) 1:1	Tuning Radius 7.4 ft.
Half Power Beam Width 55°	Maximum Surface Area 4.4 sq. ft.
Bandwidth 28 to 30 MHz	Wind Load at 80 MPH 1.18 lbs.
Impedance 50 Ohms	Weight 12.5 lbs.
Matching System: Adjustable Gamma	

\$62.95

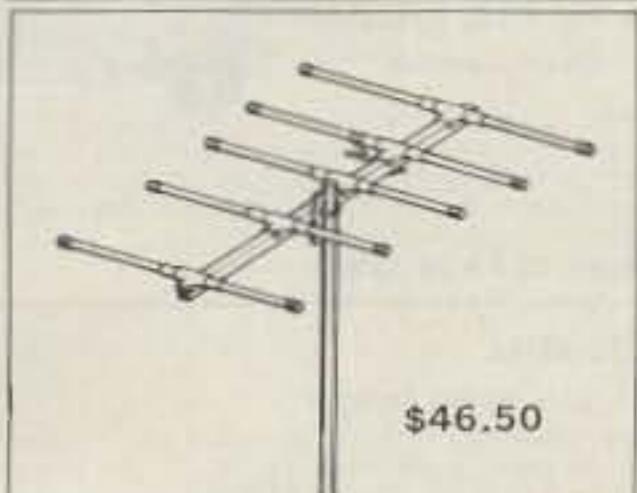

6 meter
STINGER A 6-5 DESCRIPTION
 The model Stinger A 6-5 is a highly directional 6-meter five element beam antenna specifically designed for maximum forward gain with a "no compromise" front to back ratio. The elements are constructed of high tensile strength aluminum alloy tubing plus the exclusive Stinger square boom and bracket assemblies. For maximum power transfer and low V.S.W.R., a carefully designed gamma matching assembly capable of withstanding 2,000 watts P.E.P. is incorporated. Wide element spacing assures optimum DX performance and good operating efficiency across the entire 50 to 54 MHz 6-meter band. The square boom of low optional vertical mounting for accessing 6-meter repeaters.

SPECIFICATIONS - A 6-5

ELECTRICAL -	MECHANICAL -
Forward Gain 11dB	Boom Length 13 ft.
Front-to-Back Ratio 25dB	Longest Element 10 ft.
V.S.W.R. (at resonance) 1:1	Tuning Radius 9.3 ft.
Half Power Beam Width 52°	Maximum Surface Area 3.23 sq. ft.
Bandwidth 50 to 54 MHz	Wind Load at 80 MPH 40.2 lbs.
Impedance 50 Ohms	Weight 11.5 lbs.
Matching System: Adjustable Gamma	

\$46.50



STINGER A 6-3 DESCRIPTION
 The model Stinger A 6-3 is a 3-element high gain 6-meter beam antenna like the A 6-5 but expressly designed for the casual 6-meter enthusiast. It offers the same excellent application for portable use as it does for the fixed station. Due to the units light weight and minimum wind load, the antenna is ideal for double stacked and quad stacked arrays for maximum performance. The A 6-3 is rated at 2,000 watts P.E.P. and incorporates high tensile strength aluminum elements.

SPECIFICATIONS - A 6-3

ELECTRICAL -	MECHANICAL -
Forward Gain 9.5dB	Boom Length 6.0 ft.
Front-to-Back Ratio 22dB	Longest Element 10 ft.
V.S.W.R. (at resonance) 1:1	Tuning Radius 5.4 ft.
Half Power Beam Width 52°	Maximum Surface Area 1.76 sq. ft.
Bandwidth 50 to 54 MHz	Wind Load at 80 MPH 17.8 lbs.
Impedance 50 Ohms	Weight 7 lbs.
Matching System: Adjustable Gamma	

\$30.00

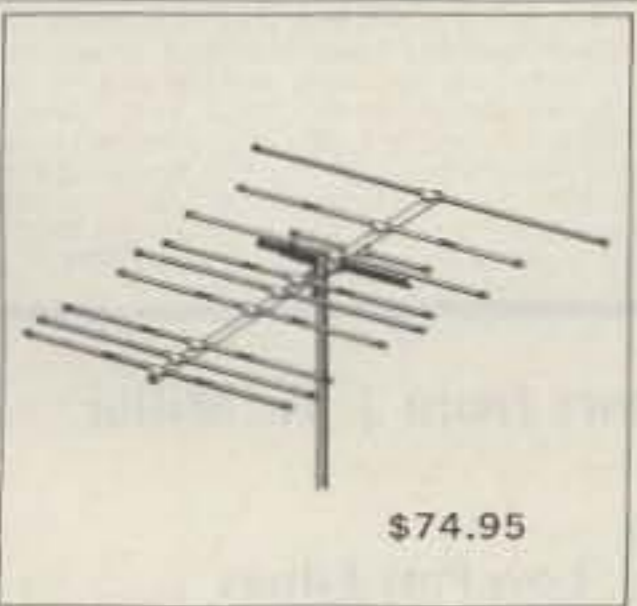

6 and 2 meter
STINGER A 62 DESCRIPTION
 The model Stinger A 62 is a truly remarkable combination 6 and 2 meter beam antenna designed for optimum performance on both bands yet only requiring ONE transmission line. This is accomplished through the use of exclusive phasing elements to accomplish dual band operation with no sacrifice to either band - NO SWITCHING REQUIRED!
 On 2 meters, the A 62 has 6 collinear elements - equivalent to three 1/2 λ 6-element yags stacked side by side - thus giving outstanding performance. Maximum forward gain is assured on 6-meters through the use of four wide spaced elements. The heavy duty Stinger construction is used throughout so that the antenna will withstand 100 mph plus wind loads.
 The A 62 is ideal for mounting on the same mast as your 60 band or other antenna thus easily opening up the world of 6 and 2 meter VHF communication.

SPECIFICATIONS - A 62

ELECTRICAL -	MECHANICAL -
Forward Gain 6 meters 9.5dB	Boom Length 10.1 ft.
Front-to-Back Ratio 2 meters 12.5dB	Longest Element 10 ft.
Front-to-Back Ratio 6 meters 15dB	Tuning Radius 6.7 ft.
Front-to-Back Ratio 2 meters 22dB	Maximum Surface Area 4.46 sq. ft.
V.S.W.R. (6 & 2 meters) 1:1	Wind Load at 80 MPH 43 lbs.
Half Power Beam Width 40° to 55°	Weight 13.8 lbs.
Bandwidth 6 meters 50 to 54 MHz	
2 meters 144 to 148 MHz	
Impedance 50 Ohms	
Matching System: Adjustable Gamma	

\$74.95

2 meter
STINGER A 2-10 DESCRIPTION
 The model Stinger A 2-10 is a high performance wide spaced ten-element 2-meter yag design for the serious VHF operator. Utilizing the Stinger construction features, the A 2-10 is almost indestructible no matter what weather conditions are encountered. Complete coverage of the 2-meter band and low V.S.W.R. is assured through the use of non-linear spaced elements that also achieving maximum forward gain. Power rating - 2,000 watts P.E.P.
 The A 2-10 can be mounted for vertical polarization, thereby making the antenna quite useful in repeater accessing, or mounted for horizontal polarization for station to station VHF DX work. Additional boys of the A 2-10 can be easily stacked for even greater gain and front to back ratio.

SPECIFICATIONS - A 2-10

ELECTRICAL -	MECHANICAL -
Forward Gain 13.8dB	Boom Length 10 ft.
Front-to-Back Ratio 25dB	Longest Element 42 in.
V.S.W.R. (at resonance) 1:1	Tuning Radius 21 in.
Half Power Beam Width 40°	Maximum Surface Area 2.36 sq. ft.
Bandwidth 144 to 148 MHz	Wind Load at 80 MPH 26.2 lbs.
Impedance 50 Ohms	Weight 9.8 lbs.
Matching System: Adjustable Gamma	

\$44.95

STINGER A 2-5 DESCRIPTION
 The model Stinger A 2-5 is a five element high gain antenna similar to the A 2-10 but having physically less of a profile. The A 2-5 finds excellent application as a portable antenna as it disassembles into a very compact package. Like the A 2-10, the antenna can be mounted for vertical or horizontal polarization for repeater or general coverage work. Constructed of the Stinger heavy duty materials, the A 2-5 is ideal for locations encountering adverse weather conditions. Power rating 2,000 watts P.E.P.

SPECIFICATIONS - A 2-5

ELECTRICAL -	MECHANICAL -
Forward Gain 9.5dB	Boom Length 5.5 ft.
Front-to-Back Ratio 22dB	Longest Element 41 in.
V.S.W.R. (at resonance) 1:1	Tuning Radius 27 in.
Half Power Beam Width 52°	Maximum Surface Area 1.33 sq. ft.
Bandwidth 144 to 148 MHz	Wind Load at 80 MPH 13.3 lbs.
Impedance 50 Ohms	Weight 6.5 lbs.
Matching System: Adjustable Gamma	

\$27.95

STINGER A 2-2 DESCRIPTION
 The model Stinger A 2-2 is a ten-element, dual polarization 2-meter antenna designed for OSCAR communications or where switching from horizontal to vertical polarization is required. The A 2-2 can even be phased to operate on both horizontal and vertical polarization at the same time. This is not only useful for OSCAR work but gives your station versatility for ground communication. Maximum element spacing gives the A 2-2 superior gain, however, since it is a four element beam in one given plane, the half power beam width does not make satellite tracking difficult because of sharp directivity. The dual gamma match assemblies provide for a very low V.S.W.R. and will withstand 2,000 watts P.E.P.

The Stinger construction features make the A 2-2 extremely heavy duty. Provisions are made for mounting the antenna at the end of the boom - for azimuth control - or at the middle of the boom for normal applications.

SPECIFICATIONS - A 2-2

ELECTRICAL -	MECHANICAL -
Forward Gain 9.5dB	Boom Length 6 ft.
Circular Gain 10.5dB	Longest Element 41 in.
Front-to-Back Ratio 22dB	Tuning Radius 5.5 ft.
Half Power Beam Width 52°	End Mount 3.4 ft.
Horizontal Polarization 52°	Center Mount 3.4 ft.
E Plane 52°	Maximum Surface Area 1.51 sq. ft.
Vertical Polarization 52°	Wind Load at 80 MPH 13.4 lbs.
E Plane 52°	Weight 11 lbs.
Circular Polarization 52°	
E Plane 52°	
Bandwidth 144 to 148 MHz	
Impedance 50 Ohms	
Matching System: Adjustable Gamma	

\$46.50

1 1/4 meter
STINGER A 1 1/4 - DESCRIPTION
 The model Stinger A 1 1/4 is a ten element 1 1/4 meter (220 MHz) high performance yag designed for all 220 MHz communication needs. Designed to be mounted in either the vertical or horizontal plane, the A 1 1/4 is adaptable for OSCAR, repeater, or general communication work. Incorporating the Stinger heavy duty elements, boom and boom to mast assemblies, the antenna easily withstands 120 mph wind loads under 1/4" ice conditions. A low loss gamma matching system assures a low V.S.W.R. and is power rated at 1,000 watts.

SPECIFICATIONS - A 1 1/4

ELECTRICAL -	MECHANICAL -
Forward Gain 13.8dB	Boom Length 8 ft.
Front-to-Back Ratio 25dB	Longest Element 28 in.
V.S.W.R. (at resonance) 1:1	Tuning Radius 4.3 ft.
Half Power Beam Width 40°	Maximum Surface Area 1.32 sq. ft.
Bandwidth 220 to 226 MHz	Wind Load at 80 MPH 17.9 lbs.
Impedance 50 Ohms	Weight 8 lbs.
Matching System: Adjustable Gamma	

\$32.95

slinky

SLINKY! \$43.95 Kit A LOT of antenna in a LITTLE space New Slinky® dipole* with helical loading radiates a good signal at 1/10 wavelength long!

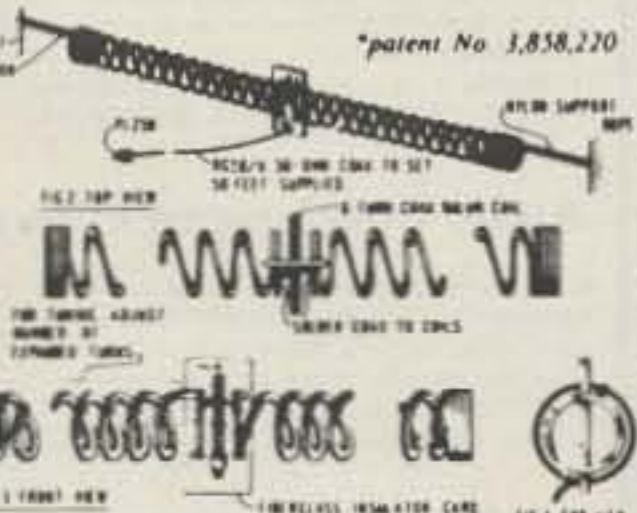

This electrically small 80/75, 40 & 20 meter antenna operates at any length from 24 to 70 ft. • no extra balun or transmatch needed • portable - erects & stores in minutes • small enough to fit in attic or apt. • full legal power • low SWR over complete 80/75, 40 & 20 meter bands • much lower atmospheric noise pick-up than a vertical & needs no radials • kit incl. a pr. of specially-made 4" dia. by 4" long coils, containing 335 ft. of radiating conductor, balun, 50 ft. RG58/U coax, PL259 connector, nylon rope & manual.

HAM-KEY

Model HK-3M



Deluxe straight key
 • Auto tip bracket, C-71 tip
 • Heavy base. No need to attach to desk
 • CC 3P shielded cable & plug for HK-3M \$24.99
 • Add \$ 50 Shipping & Handling
 Model AT B anti-tip bracket only. To convert any HK-3 to HK-3M \$2.99

\$19.95

Model HK-4



Combination HK-1 & HK-3 on same base
 • Straight key may be used conventionally or as a switch to trigger a memory.
 CC 1-3P shielded cable with plugs for HK-4 \$5.99

\$44.95

RADIO TELEGRAPH SENDING DEVICES

Model HK-1



Dual lever squeeze paddle
 • For use with all electronic keyers
 • Heavy base with non-slip rubber feet
 • Paddles reversible for wide or close finger spacing

\$29.95

Model HK-5A



• Latching circuit for squeeze keying
 • Self-completing dots & dashes
 • Dot & dash memory
 • Built in sidetone
 • Battery operated with provisions for external power

\$69.95

DATONG



MODEL FL1 \$219.95
 Frequency - Agile Audio Filter
 The Datong Frequency-Agile Audio Filter is intended primarily for post-detector signal filtering in RF and LF communications receivers for SSB and CW. It offers an unusually versatile combination of benefits to the user including:

- For the SSB operator:
- Fast automatic suppression of interfering heterodyne whistles in the range 280-3000 Hz by a unique search-lock-and-track notch filter. The tracking notch can be left in circuit with no audible effect until a whistle appears in which case the whistle will 'disappear' within typically one second.
 - A continuously adjustable audio 'window' or a variable-width notch to improve reception in the presence of other off-tune SSB, RTTY or SSTV signals.
- For the CW operator:
- Continuously variable center-frequency (280-3000 Hz) and bandwidth (25-1000 Hz) for perfect matching of receiver passband to changing band conditions, sending speeds, and personal preference.
 - Flat-topped, steep-skirted response shape for optimum ease of tuning combined with excellent noise rejection.
 - Linear tuning law with bandwidth independent of frequency and gain independent of bandwidth for natural 'feel'.

TUFTS Electronic Department Store TUFTS

JANEL LABORATORIES



CLASSIC 2 METER PREAMP

This widely used 2 meter preamp is probably the most sensitive available today. One model provides a uniformly low noise figure across the full band. Equally applicable for DX, AM, SSB, FM and OSCAR. 18 dB gain, 2 dB noise figure, 12 vdc power (5mA) BNC connectors. Aluminum box is 1 1/2"x2 1/2"x2 1/2".
Model 144PB 144-148MHz

MODEL	DESCRIPTION	PRICE
PREAMPS		
30PB	28-30 MHz (BNC)	\$ 21.95
50PB	50-52 MHz (BNC)	21.95
53PB	52-54 MHz (BNC)	21.95
137PB	135-139 MHz (BNC)	21.95
144PB	144-148 MHz (BNC)	21.95
PM-1	2m Preamp Module (Solder Terminals)	16.95
QSA 5	144-148 MHz for Transceivers (50-239)	41.95
QSA 6	50-52 MHz (50-239)	43.95
220PB	220-225 MHz (BNC)	21.95
432PA	420-450 MHz (BNC) 3.5 dB maximum NF	33.00
432PC	420-450 MHz (BNC) 2.0 dB maximum NF	54.95
432PE	1.0 dB typical NF	90.00
PB	Any single frequency between 30 and 50, or 148-174 MHz (BNC)	27.00
CONVERTERS		
144CF	144-146 MHz IN, 28-30 MHz OUT (BNC) 2nd crystal for 144CF (146-148 IN, 28-30 OUT)	\$ 79.95 12.00
432CF	432-434 MHz IN, 28-30 MHz OUT (BNC) 2nd crystal for 432CF (434-436 IN, 28-30 OUT) (Also available with 434-436 MHz IN and 28-30 MHz OUT, (Oscar 8, Mode J)	79.95 10.00 79.95
OSCILLATORS		
01-A	Precision, Specify 4 or 10 MHz	\$ 79.95
D1-A	10 to 1 Digital Divider	11.95
D8-A	Eight, 10 to 1 Dividers	27.95
USEFUL ACCESSORIES		
17013	BNC to BNC, 36" RG-58C/U Cable	\$ 6.00
17010	BNC to UHF, 36" RG-58C/U Cable	6.00
17014	BNC to RCA Phono, 36" RG-58C/U Cable	6.00
03005	Adaptor, BNC Plug to UHF Jack	4.00
03006	BNC Connector, UG-88/U for RG-58 size cable	1.25
MISCELLANEOUS		
ISOLINE	Antenna Isolator, 144-174 MHz (50-239)	\$ 14.95
432FA	Cavity Filter, .5 dB loss	105.00
432FA.2	Cavity Filter, .2 dB maximum loss	115.00



QSA5 PREAMP For Transceivers

The QSA 5 preamp is a high performance, low noise preamp for improving the receiving sensitivity of 2 Meter transceivers. This preamp features easy installation with no modification to the transceiver required. This preamp can be used with virtually all 2 meter transceivers and on all modes — FM, SSB, CW or AM. Relays in the QSA 5 automatically bypass the preamp when transmit power is sensed. A LED indicator shows the status of the QSA 5. A front panel switch allows the preamp to be bypassed while receiving. The low noise figure of the QSA 5 provides for exceptional sensitivity. The gain has been set to optimize the performance with 2 meter transceivers.

Model PM-1



PREAMP MODULE

This low noise preamp is designed to be easily incorporated into new or existing 2 meter equipment. Solder pins are provided for mounting to a PC board or for connection to wire or coax. Uses low noise JANEL MOSFET circuitry. Each unit is fully tested for gain and noise figure. Quantity prices are available for OEM's.



UHF PREAMPS

Model 432PA 420-450MHz
Low Cost All Around Favorite

This two stage amplifier provides high sensitivity across the full 420 to 450 MHz band. A low 3.5 dB noise figure makes this preamp ideal for most amateur applications. Can be used for all modes. 17dB gain, 12vdc power (10mA), BNC connectors (50 ohms), aluminum box 1 1/2"x4x2 1/2".

Model 432PC 420-450MHz
Extremely Sensitive

This preamp provides a low noise figure required for demanding applications. A premium state-of-the-art transistor is used to provide extremely high sensitivity. Two stages, 20 dB gain, 2 dB maximum noise figure (1.7 dB typical), 12 volt dc power BNC connectors.

6 METER PREAMP

Ideal for DX

This low noise preamp significantly improves the sensitivity of most 6 meter receivers. Available in two frequency versions to cover DX and FM portions of the band. 18 dB gain, 2 dB noise figure, 12 vdc power, BNC connectors.
Model 50PB 50-52MHz, Model 53PB 52-54MHz.



For 6 Meter Transceivers

All of the features of our popular QSA-5 but for 6 meters. Fully compatible with transceivers running 30 watts or less. All mode use. Noise Figure 2dB Gain, 15dB VSWR (transmit) 1:2. Available for 50-52 or 52-54MHz (specify when ordering) UHF connectors. **Model QSA-6.**

10 METER PREAMP Oscar Special



Ideal for pulling weak satellite signals out of the noise. This preamp has been responsible for producing many "impossible" OSCAR QSO's. 18 dB gain, 2 dB noise figure, 12vdc power (5mA), BNC connectors. Aluminum box is 1 1/2"x2 1/2".
Model 30 PB 28-30MHz.

220 MHz

Low Noise Preamp

1 1/4 Meters-Covers full 220-225 MHz range with 15 dB gain, 3 dB noise figure, 12 volt power and BNC connectors. **Model 220PB.**



Our Finest UHF Preamp—1.0 dB NF

This outstanding 432 MHz preamp provides the lowest practical noise figure. The finest transistors available today are combined with the ultimate in construction and alignment. Single stage. Gain 15dB (min) Noise Figure 1.2dB (max including measurement uncertainty), 0.8 to 1.0dB typical. Bandwidth 100 MHz, 12 volts at about 7 mA. Type N connectors. Size 1 1/2"x3 1/2" inches. Center Frequency 400 to 512 MHz (specify when ordering) **Model 432PE.**

\$65.95

DAIWA



\$20.95

Coaxial Switches
 2 Position/Model CS-201
 4 Position/Model CS-401



RF-440

\$135.95

RF Speech Processor
 Models RF-400

Increases talk power with splatter free operation. RF clipping assures low distortion. Simply install between microphone and transmitter.
 Talk Power: Better than 6 dB.
 Frequency Response: 300-3000 Hz at 12 dB down.
 Distortion: Less than 3% at 1 kHz, 20 dB clipping.

CN-720 and CN-620

Frequency Range: 1.8-150 MHz
 SWR Detection Sensitivity: 5W min.
 Power: 3 Ranges (Forward, 20/200/100W)
 (Reflected, 4/40/200W)

SWR & Power Meters
 Models CN-720, CN-620 and CN-630
 Professionally engineered cavity construction.
 Power Rating: 2.5kW PEP, 1kW CW
 Impedance: 50 Ohms
 Connectors: SO-239
 Insertion Loss: Less than 2 dB
 VSWR: 1:1.2
 Maximum Frequency: 500 MHz
 Isolation: Better than 50 dB at 300 MHz; better than 45 dB at 450 MHz; adjacent terminal.
 Unused Terminals grounded.



CN-720 \$166.95



\$140.50

CN-620

Interference Filters from J. W. Miller

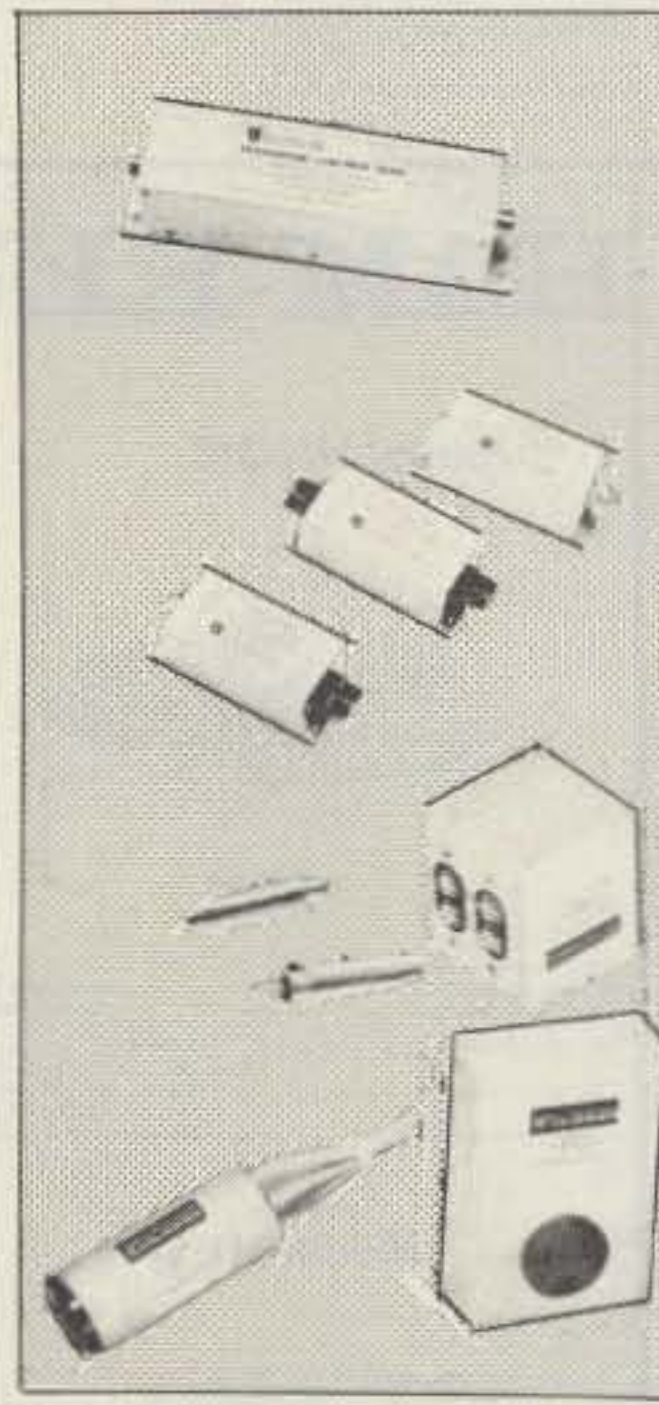

Low Pass Filters

Eliminate or greatly reduce interference to TV receivers by radio amateur stations when installed in antenna lines of those transmitters. Input and output impedance 50 ohms. Insertion loss .3 dB max.; VSWR 1.2:1. Attenuation greater than 75 dB above 41 MHz.
 C-511-T: 25 W AM 50 W PEP SSB \$19.50
 C-514-T: 1000 W AM 2000 W PEP SSB \$26.80

High Pass Filters

When installed in the antenna, eliminate or greatly reduce front end overload interference to TV or FM receivers caused by amateur radio transmitters and other high frequency radio services. Filter attenuates signals below 40 MHz by a power factor greater than 1,000,000:1. Impedance C-513-T: 1: 75/300 ohm \$10.18
 C-513-T2: 75/75 ohm; C-513-T3: 300/300 ohm \$10.18

Audio Interference Filters

Eliminate interference caused in your audio equipment by radio amateur transmitters and other radio services. C-505-R installs in the input lines of audio equipment. Consists of 1 pair. C-506-R installs in speaker lines. Unit will take care of stereo speaker system.
 C-505-R \$5.07
 C-506-R \$6.67

AC Power Line Filters

Eliminate or reduce interference to radio amateur receivers, TV's and radios, and prevent radio signals from entering power line.
 C-508-L: 3 section LC filter, 3 A max. \$ 8.33
 C-509-L: 5 section LC filter (for more severe interference), 5 A max. \$18.35

CN-630

Frequency Range: 140-450 MHz
 Power: 2 Ranges (Forward 20/200W)
 (Reflected 4/40W)

CN-630

\$139.00



BIRD
Electronic Corporation

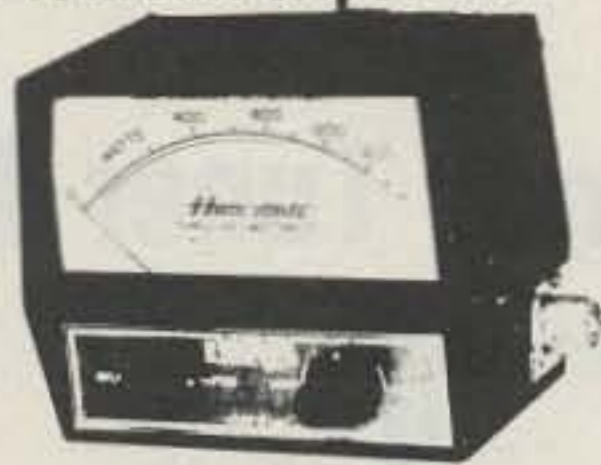

\$99 VHF model 4362 (140-180 MHz)
\$99 HF model 4360 (18-30 MHz)

The 4360, 4362 HAM-MATE Directional Wattmeters are insertion type instruments for measuring forward or reflected power in 50-ohm coaxial transmission lines. They are direct descendants of the model 43 THRULINE® Wattmeter—the professional standard of the industry—and will accurately measure RF power flow under any load condition. Each wattmeter is made up of a precisely machined section of 50-ohm line, a rotatable sensing element and meter calibrated in watts, all mounted in a high-impact plastic housing. It is this type of solid construction and the directional THRULINE coupling circuit, without toroids, that account for the superiority of the HAM-MATE Wattmeters.

the indispensable
BIRD 43
THRULINE
WATTMETER



Power Range	Frequency Bands (MHz)				
	2-30	25-100	100-250	200-500	400-1000
1 watt	—	1A	1C	1D	1E
10 watts	—	10A	10C	10D	10E
25 watts	—	25A	25C	25D	25E
50 watts	50H	50A	50C	50D	50E
100 watts	100H	100A	100C	100D	100E
250 watts	250H	250A	250C	250D	250E
500 watts	500H	500A	500C	500D	500E
1000 watts	1000H	1000A	1000C	1000D	1000E
2500 watts	2500H	—	—	—	—
5000 watts	5000H	—	—	—	—

MODEL 43
Elements (Table 1) 2-30 MHz \$135.00
Elements (Table 1) 25-1000 MHz 50.00
Carrying case for Model 43 & 6 elements 42.00
Carrying case for 12 elements 28.00
Carrying case for 12 elements 17.00

READ RF WATTS DIRECTLY! (Specify Type N or SO239 connectors) 0.45 – 2300 MHz, 1-10,000 Watts ±5%, low insertion VSWR – 1.05. Unequaled economy and flexibility. Buy only the element(s) covering your present frequency and power needs, add extra ranges later if your requirements expand.

AMPHENOL BUNKER RAMO

SERIES 31 – BNC CONNECTORS
Amphenol's BNC connectors are small, lightweight, weatherproof connectors with bayonet action for quick disconnect applications.

Shells, coupling rings and male contacts are accurately machined from brass. Springs are made of beryllium copper. All parts in turn are ASTRO-plated® to give you connectors that can take constant handling, high temperatures and resist abrasion.

BNC BULKHEAD RECEPTACLE 31-221-385 UG-1094
Mates with any BNC plug. Receptacle can be mounted into panels up to 1/4" thick. \$1.25

BNC (M) TO UHF (F) ADAPTER 309-2900-385 UG-255
Adapts any BNC jack to any UHF plug. \$3.63

DOUBLE MATE ADAPTER 83-877-385
Both coupling rings are free turning. Connects 2 female components. \$2.72

JACK ADAPTER 575-102-385
575-102-385 Adapts 83-1SP-385 to Motorola type auto antenna jack or pin jack. \$1.95

PANEL RECEPTACLE 83-1R-385 SO239
Mounts with 4 fasteners in 21/32" diameter hole. \$1.17

PANEL RECEPTACLE SO239

BNC (F) TO UHF (M) ADAPTER 31-028-385 UG-273
Adapts any BNC plug to any UHF jack. \$2.39

PUSH-ON 83-5SP-385
Features an unthreaded, springy shell to push fit on female connectors. \$2.27

LIGHTNING ARRESTOR 575-105-385
Eliminates static build-up from antenna. Protects your valuable equipment against lightning damage. \$4.80

BNC PLUG 31-002-385 UG-88
Commonly used for communications antenna lead cables. For RG 55/U & RG 58/U cables. \$1.59

BNC STRAIGHT ADAPTER 31-219-385 UG-914
1 9/32" long, allows length of cables to be joined. Mates with BNC plugs. \$2.12

BNC PANEL RECEPTACLE 31-003-385 UG-290
Mounts with 4 fasteners in 29/64" diameter hole. \$1.74

83-878-385 SO239SH
Mounts in single 21/32" diameter hole. Knurled lock nuts prevent turning. \$1.59

BNC ANGLE ADAPTER 31-009-385 UG-306
Adapts any BNC plug for right angle use. \$4.23

BNC TEE ADAPTER 31-008-385 UG-274
Adapts 2 BNC plugs to 31-003-385 or other female BNC type receptacle. \$4.56

SO239SH

UG-306

UG-274



First is the Fox XK. It reads all bands and tucks away on the visor.



Our remote (RW) unit is "out-of-sight" when installed. Out-of-sight in performance, too.



And now there's Superfox!

The first remote, superheterodyne radar warning system. Superfox has 10 times the sensitivity capability of any conventional radar detector. It is ideal for custom installations.

PRICE LIST

Order No.	Description	Price
60	Fox XK All band detector w/self contained aural/visual alarm	\$109.00
60-2	Fox XK (RW) All band detector w/remote control, waterproof	\$139.00
60-3	Super Fox Super-Heterodyne remote radar warning system	\$279.95

HITACHI
OSCILLOSCOPES

SPECIAL!
15% OFF ALL
HITACHI SCOPES

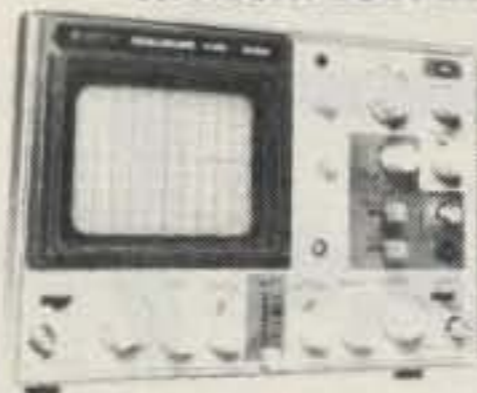

Single and dual trace, 15 and 30 MHz. All four high sensitivity Hitachi oscilloscopes are built to demanding Hitachi quality standards and are backed by a 2-year warranty. They're able to measure signals as low as 1mV/division (with X5 vertical magnifier). It's a specification you won't find on any other 15 or 30 MHz scope. Plus: Z-axis modulation, trace rotation, front panel X-Y operation for all four scope models, and X10 sweep magnification. And, both 30 MHz oscilloscopes offer internal signal delay lines. For ease of operation, functionally-related controls are grouped into three blocks on the color coded front panel.

- V-302 30 MHz Dual Trace \$850.50
- V-301 30 MHz Single Trace \$670.50
- V-152 15 MHz Dual Trace \$625.25
- V-151 15 MHz Single Trace \$490.50

ALLIANCE

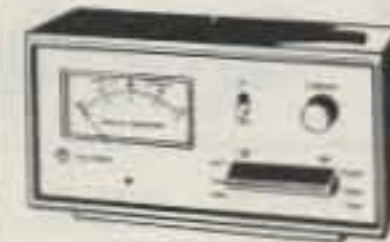

\$119.95

HD-73 HEAVY-DUTY
ROTATOR

with exclusive Dual-Speed Control!

For antennas up to 10.7 sq. ft. of wind load area. Mast support bracket design permits easy centering and offers a positive drive no-slip option. Automatic brake action cushions stops to reduce inertia stresses. Unique control unit features DUAL-SPEED rotation with one five-position switch. SPECIFICATIONS: Max. wind load bending moment – 10,000 in.-lbs. (side-thrust overturning); Starting torque – 400 in.-lbs.; Hardened steel drive gears; Bearings – 100-3/8" diameter (hardened); Meter – D'Arsonval, taut band (back-lighted). There's much, much more.



Two NEW Rotors
from Cornell-Dubilier

TAIL TWISTER™

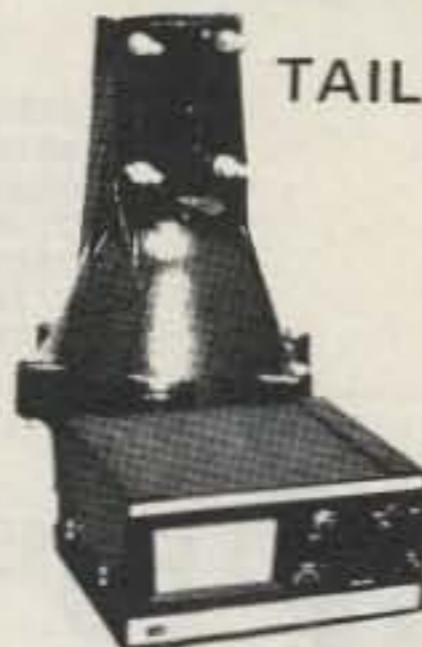

HAM IV



- For the New Super Communications Antennas
- New Thickwall Casting
- New Steel Ring Gear
- New Metal Pinion Gear
- New Motor Prebrake
- New Super Wedge Brake
- New L.E.D. Control Box
- Safe 26 Volt Operation

Designed for the newest of the king-size communications antennas, the TAIL TWISTER™ is the ultimate in antenna rotational devices. The TAIL TWISTER™ starts with a deluxe control box featuring snap action controls for brake and directional controls; L.E.D. indicators signal rotation and brake operation, while the illuminated meter provides direction readout. This new control box couples to the newest bell rotor principle, the TAIL TWISTER™ is a brand new design with thickwall castings and six bolt assembly. A brand new motor with prebrake action brings the antenna system to an easy stop, while the massive square front brake wedge locks the assembly in place. A new stainless steel spur gear system provides final drive

into a new steel ring gear for total reliability. Triple race, 138 ball bearing assembly carries dead weight and maintains horizontal stability.

An optional heavy duty lower mast adaptor is available for lighter loads with mast mounting. Price: \$249.00

The HAM IV sets new levels of performance. Snap action switched wedge brake and rotational controls brings pinpoint accuracy to large directional arrays popular in communications. A new motor provides pre-brake action to assist in slowing down rotational mass, and the new thicker wedge brake offers far stronger lock-in phase action. To take full advantage of this new design, the HAM III is designed for in-tower mounting. A new optional heavy duty lower mast adaptor is available when the HAM III is to be mast mounted with smaller arrays. A stainless steel spur gear system multiplies the torque into the dual race 98 ball bearing support assembly assuring years of trouble free performance. Price: \$169.00

TUFTS Electronic Department Store TUFTS

MFJ INTRODUCES THE NEW! GRANDMASTER MEMORY KEYERS

At \$139.95 this MFJ-484 GRANDMASTER memory keyer gives you more features per dollar than any other memory keyer available — and Here's Why . . .

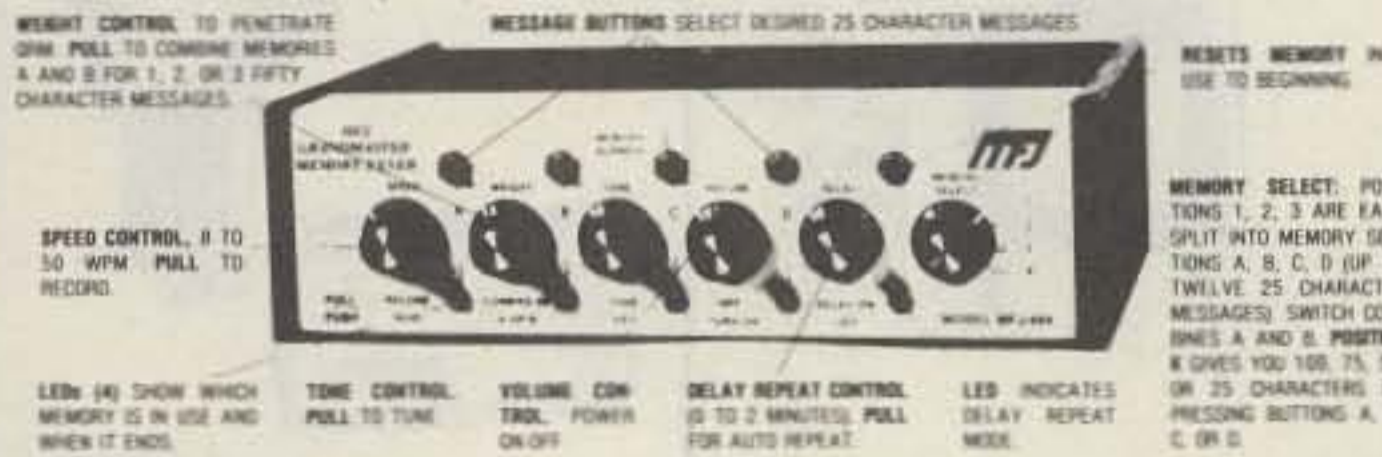

MEMORY KEYERS

MFJ-484	Grandmaster Memory Keyer. Up to twelve 25 character messages plus a 100, 75, 50, or 25 character message.	139.95
MFJ-482	Grandmaster Memory Keyer. Four 25 or a 50 and two 25 character messages.	99.95
MFJ-481	Grandmaster Memory Keyer. Two 50 character messages.	79.95
HK-1	Optional Squeeze Key.	29.95

PROFESSOR MORSE

MFJ-410	Professor Morse. Random code generator/keyer. Morse code teaching computer. Sends alpha only or alphanumeric, full feature Curtis keyer, speed readout, delay for spacing letters up to three seconds.	149.95
---------	--	--------

TELEPHONE PATCHES

MFJ-624	Crisp clear professional sounding audio, Vu meter for monitoring line level and for nulling for maximum separation of transmitter and receiver, easy patch in patch out connections.	59.95
MFJ-620	Same as MFJ-624 except without meter.	49.95



MFJ-40T QRP Transmitter

\$29.95

MISCELLANEOUS

MFJ-202	RF Noise Bridge.	59.95
MFJ-1030BX	Receiver Preselector.	49.95
MFJ-200BX	Frequency Standard.	29.95
MFJ-40T	QRP Transmitter.	29.95
MFJ-40V	Companion QRP VFO for 40T.	29.95
CPO-555	Code Practice Oscillator.	17.95
TK-555	Optional Telegraph Key.	1.95



LSP-520BX

\$49.95



LSP-520BX II

\$59.95

SPEECH PROCESSOR

MFJ-525	RF Speech Processor. Plugs between microphone and rig. Powerful natural sounding speech. Vu meter for adjustment of processing, 4 pin mic jack, 6 dB more average SSB power, use with any rig and any mic, push button on-off/bypass.	119.95
LSP-520BX II	Logarithmic Speech Processor, Deluxe model.	59.95
LSP-520BX	Logarithmic Speech Processor.	49.95



CMOS-8043 Electronic Keyer
State of the art design uses CURTIS-8043 Keyer-on-a-chip

\$54.95

- Built-in Key • Dot memory • Iambic operation with external squeeze key • 0 to 50 WPM • Sidetone and speaker • Speed, volume, tone, weight controls • Ultra reliable solid state keying • 300 volts max • 4 position switch for TUNE, OFF, ON, SIDETONE OFF • Uses 4 penlight cells • 2.3 1/8 x 3.1 1/4 x 4 inches.

ELECTRONIC KEYERS

MFJ-8044IC	Deluxe Keyer. Dot and dash memory.	69.95
MFJ-404	Econo Keyer. Built-in paddle, plus extras.	59.95
MFJ-402	Econo Keyer. Built-in paddle.	44.95
MFJ-400	Econo Keyer. External Key.	49.95
MFJ-408	New Deluxe Electronic II, speed readout meter, socket for: Memory, random code generator, keyboard. 8044IC keyer chip dot and dash memory. Up to 50 WPM.	79.95
BY-1	Bencher Deluxe Iambic Paddles. Heavy steel base, non-skid feet.	39.95

MFJ ENTERPRISES DELUXE Versa Tuner II



BRAND NEW

MFJ-984	Deluxe 3kW Versa Tuner IV. SWR, forward-reflected wattmeter, rf ammeter, dummy load, antenna switch, balun, 3kW PEP.	299.95
MFJ-982	3kW Versa Tuner IV. 7 position antenna switch, balun, 3kW PEP.	199.95
MFJ-981	3kW Versa Tuner IV. SWR, forward-reflected wattmeter, balun, 3kW PEP.	199.95
MFJ-980	3kW Versa Tuner IV. Built-in balun, 3kW PEP.	169.95
MFJ-962	1.5 kW Versa Tuner III. SWR, forward-reflected wattmeter, 6 position antenna switch, balun, 1.5kW PEP.	169.95
MFJ-961	1.5kW Versa Tuner III. 6 position antenna switch, balun for balanced lines, 1.5kW PEP.	149.95
MFJ-949	Deluxe Versa Tuner II. Ultimate in antenna tuners: SWR, dummy load, forward-reflected wattmeter, front panel antenna switch, balun, 300W output.	129.95
MFJ-941B	Versa Tuner II. Improved model with SWR/wattmeter, antenna switch, balun, mobile mounting bracket, 300W output.	79.95
MFJ-940	Versa Tuner II. SWR/wattmeter, antenna switch, no balun, no mobile mount, 300W.	69.95
700-0014	Mobile mount for MFJ-940.	3.00
MFJ-945	Versa Tuner II. With SWR/wattmeter and mobile mounting bracket, less 6 position antenna switch, 300W.	69.95
MFJ-944	Versa Tuner II. With antenna switch and mobile mounting bracket, less SWR/wattmeter, 300W output.	69.95
MFJ-943	Versa Tuner II. Less SWR/wattmeter, antenna switch mounting bracket, 300W output.	59.95
MFJ-901	Versa Tuner. Matches anything. Coax, random wires, balance lines, 200W output.	49.95
MFJ-900	Econo Tuner. Matches coax and random wires. 200W.	39.95
MFJ-16010	Random Wire Tuner. For random and long wires, 200W.	29.95

24-HOUR DIGITAL CLOCK SOLID-STATE



\$29.95

24 HOUR DIGITAL CLOCK

MFJ-101	24 hour digital clock, totally solid state, .6" blue display (like TS-820S), 1D time, lock function (prevents accidental missetting of time).	29.95
---------	---	-------

These MFJ active filters are the most copied in industry.

CWF-2BX MFJ SUPER CW FILTER

\$29.95 each

SBF-2BX MFJ SSB FILTER

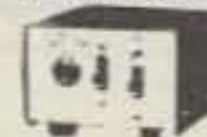

Best performance in our class. Only MFJ filter actively used in the ham community. Each CW filter is active on its own.

SSB/CW FILTERS

MFJ-752	Dual tunable SSB/CW active filter Signal Enhancer II. 2 noise limiters, inputs for 2 rigs, 110VAC or 12 VDC.	79.95
MFJ-751	Tunable SSB/CW active filter Signal Enhancer. 110VAC or 12 VDC.	59.95
MFJ-721	Super CW/SSB Filter. 2W amplifier, noise limiters, inputs for 2 rigs. 12VDC or 110VAC with optional AC adapter.	59.95
MFJ-720	Deluxe Super CW Filter. 2W amplifier, 12VDC or 110VAC with optional AC adapter.	44.95
CWF-2BX	Super CW Filter	29.95
SBF-2BX	Single Sideband Filter	29.95
AC Adapter	12 VDC, 200 mA.	7.95
CWF-2PC	Same wired and tested PC board as in CWF-2BX with 4 position switch	19.95
SBF-2PC	Same wired and tested PC board as in SBF-2BX with 4 position switch	19.95
AC Adapter	6 VDC, 300 mA.	7.95

Daze of Whine and Noises

—intoxicating information about alternators

One of the puzzling problems that crop up in our VHF FM equipment is the sudden appearance of alternator whine. It is usually the first comment you receive if you have it on your signal. As befits the individualistic aspect of the hobby, there are many myths pertaining to its elimination which I shall attempt to dispel, after which I will suggest some ways of eliminating it. First, however, we should understand the reason for its being, and learn where to look for its source. The charging system in your car is the cause; the reason

we have the charging system is to keep the source of all of your car's electrical power at its proper potential; the source being the car battery.

Fig. 1 diagrams the charging system for late-model GM cars. Note that the alternator is a 3-phase full-wave bridge with an output shown in Fig. 2. It is the dc component of the pulsating output voltage of the alternator that charges the battery. Since the output of the alternator will vary with engine speed—anywhere from slow idle of about 600 rpm to several thousand rpm—a

regulator is added to ensure an almost constant charging voltage to the battery. This constant voltage is perhaps one to one-and-one-half volts higher than the 12.5-volt battery. Note that the battery is 12.5 volts, not the 12 volts often assumed.

At one time, it was possible to adjust the charging voltage and current. My late-model car is permanently adjusted. The regulator module is mounted inside the alternator. Granted, it is a solid-state assembly, but if the permanent adjustment becomes temporary, the regulator must be replaced in its entirety. A very positive aspect of these new-fangled solid-state regulators is that there are no longer any arcing contacts involved. The older regulators had (at least) one set of contacts (voltage-adjust) opening and closing all the time the engine was running. The spurious radiation from these beauties was stultifying!

Alternator whine is the squeal mixed in with your audio that the receiving stations hear when you transmit. It varies in frequency in proportion to engine speed. The root cause of alternator whine is related to diode switching and the chopping

action of the regulator. Rather than the ideal waveform shown in Fig. 2, the output of an alternator is the square wave shown in Photo A—a photo of alternator output under actual load conditions. All the scope-trace photos used a setting of 5 v/cm on the vertical axis and 500- μ s time-base for the horizontal sweep.

Square waves contain many harmonics extending well into the VHF range, and since automotive designers may not be aware of the fact that we amateurs are installing VHF equipment in our cars, they don't spend too much time properly routing wiring. Nor do they spend time or additional parts trying to clean up the garbage you will see on a 12-V (sic) bus in the car, should you happen to put a scope on the Vcc line to your radio. They design in only what they have to for general usage. The fact that cars are becoming physically smaller compounds the felony. All wires, by necessity, are closer together.

In most cases, spurious radiation in the audio frequency range gets into your rig via what automotive engineers call backway point of entry. This means

Photos courtesy of Ford Motor Co.

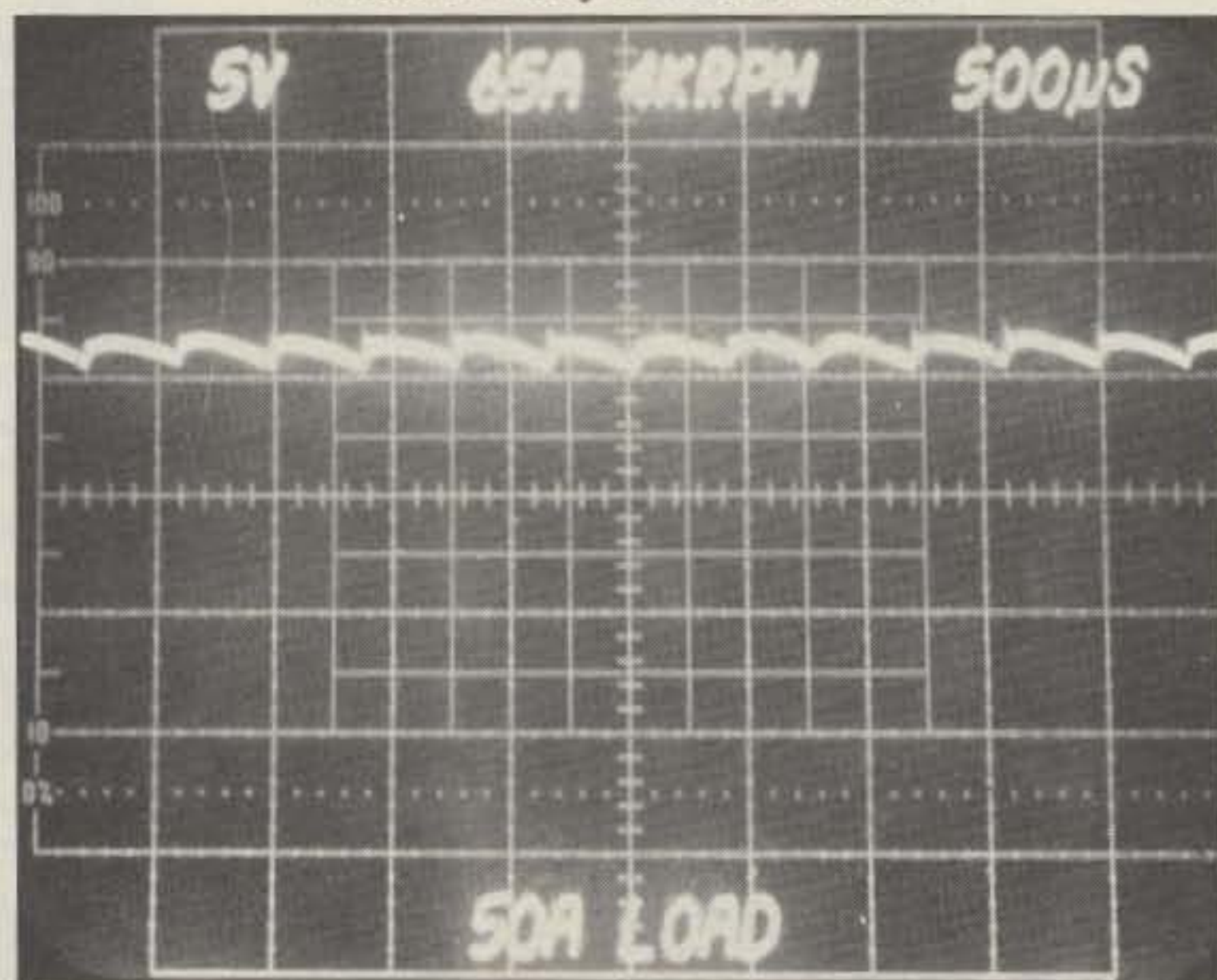

Photo A. Alternator output under actual load condition.

through the "A" lead to your rig. The result of this is the modulation of your signal with an unwanted audio signal, represented by the squeal, in addition to the desired modulation from the microphone. I would hazard a guess that the reason that the whine manifests itself more on the transmitted signal, as opposed to receiver audio, is related to total gain in each audio circuit and the number of stages (discrete and/or IC) in the chain. I have experienced whine in a receiver, but not in its transmitter in one instance, and vice versa in another.

The spurious audio is generated by the unique nature of the alternator system. Its frequency is related to alternator rpm times a constant, K, where K equals the number of poles times the number of phases times the diode rectification factor, all divided by 60 (the conversion of rpm to Hz).

For Ford cars, which use a six-pole alternator, $K = 0.6$; for GM cars, which use a seven-pole alternator, $K = 0.7$. With an engine speed of 600 rpm, the alternator rotates at approximately 2400 rpm, since there is about a four-times multiplication factor between the engine pulley and the alternator pulley.

The spurious is therefore about 1440 Hz (0.6×2400) for Fords—right in the middle of the audio range.

All FM gear uses audio wave-shaping in the receiver audio system not only to de-emphasize, but also to limit bandwidth. Audio is usually cut off above three kHz. Any spurious audio is also reduced in amplitude; therefore, when a radio is transmitting, alternator whine, you will usually hear it only at low speeds of travel or at idle speeds. The whine may still be there, but your radio's audio system cuts it off or reduces it by a substantial amount. As a point of information, you can, with a little mathematical manipulation, ascertain that when you rev up your Ford engine above 1300 rpm, a ham, listening for your whine, will no longer hear it. All of this presupposes that your charging system is in perfect working order.

Photos B and C show the results of a failure in one of the rectifier diodes in an alternator. Photo B shows a shorted diode; Photo C, an open diode. Note first that the average output voltage drops just a little but, more importantly, that the waveform is more distorted. Without getting into a Fourier analysis, it follows

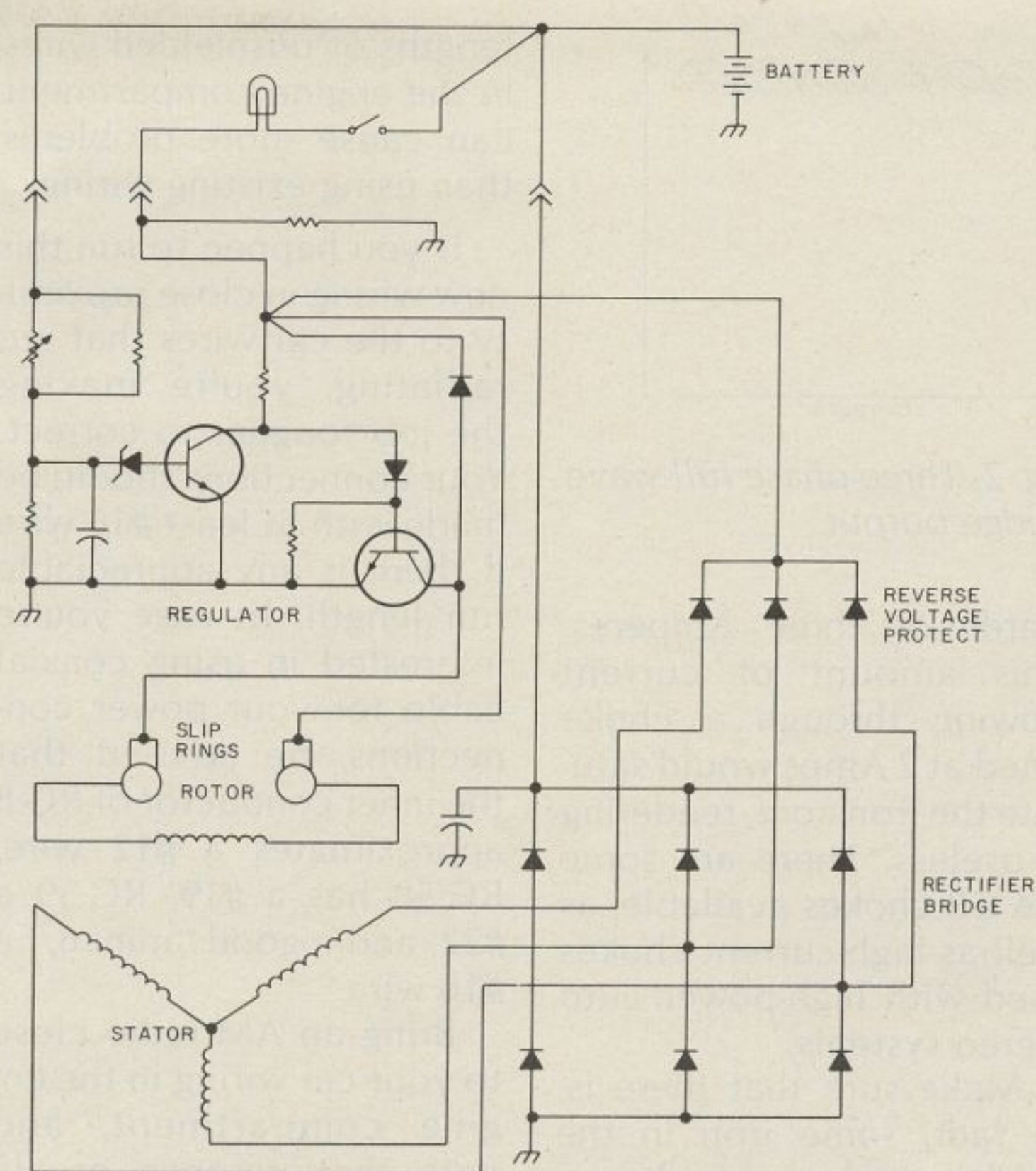

Fig. 1. The charging system for late-model GM cars.

that more spurious harmonics will be generated along with more spurs in the audio range. This will affect the "purity" of the whine you transmit. Get the hint? If your whine suddenly changes its characteristics, check your alternator diodes! Hopefully, you will have removed this annoying signal from the air long before any diodes break down.

Much has been said, but little written regarding ways

to reduce the spurious transmission of whine. The most effective way that I have found, borne out by automotive people I've contacted, is to insert a properly rated choke in series with the "A" line to your radio. A value of about 20 mH worked for me. The most flagrant error made is to attempt to use a standard CB-type choke. These things are rated at only 2 Amperes. Most amateur equipment draws up-

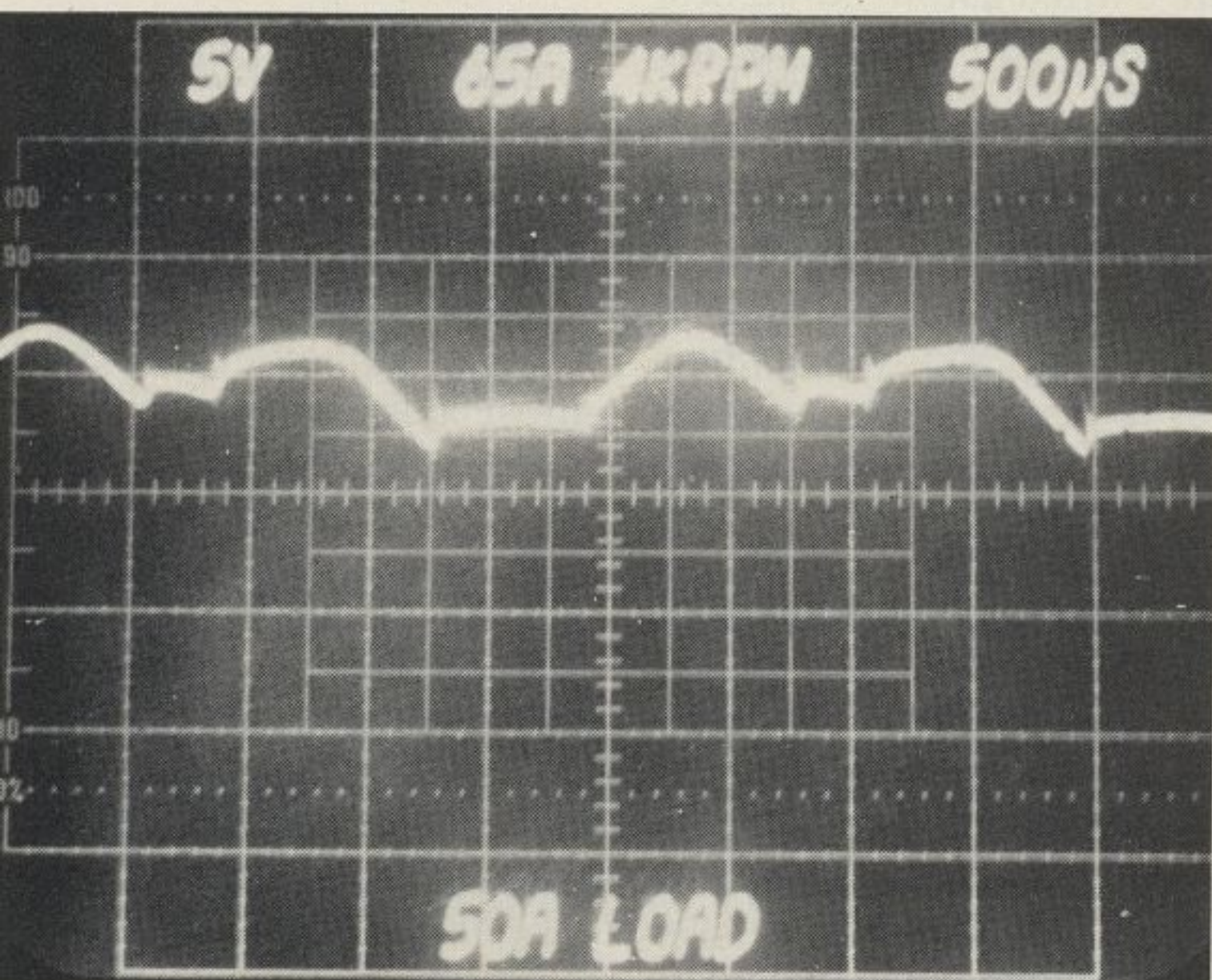

Photo B. Result of shorted diode in an alternator.

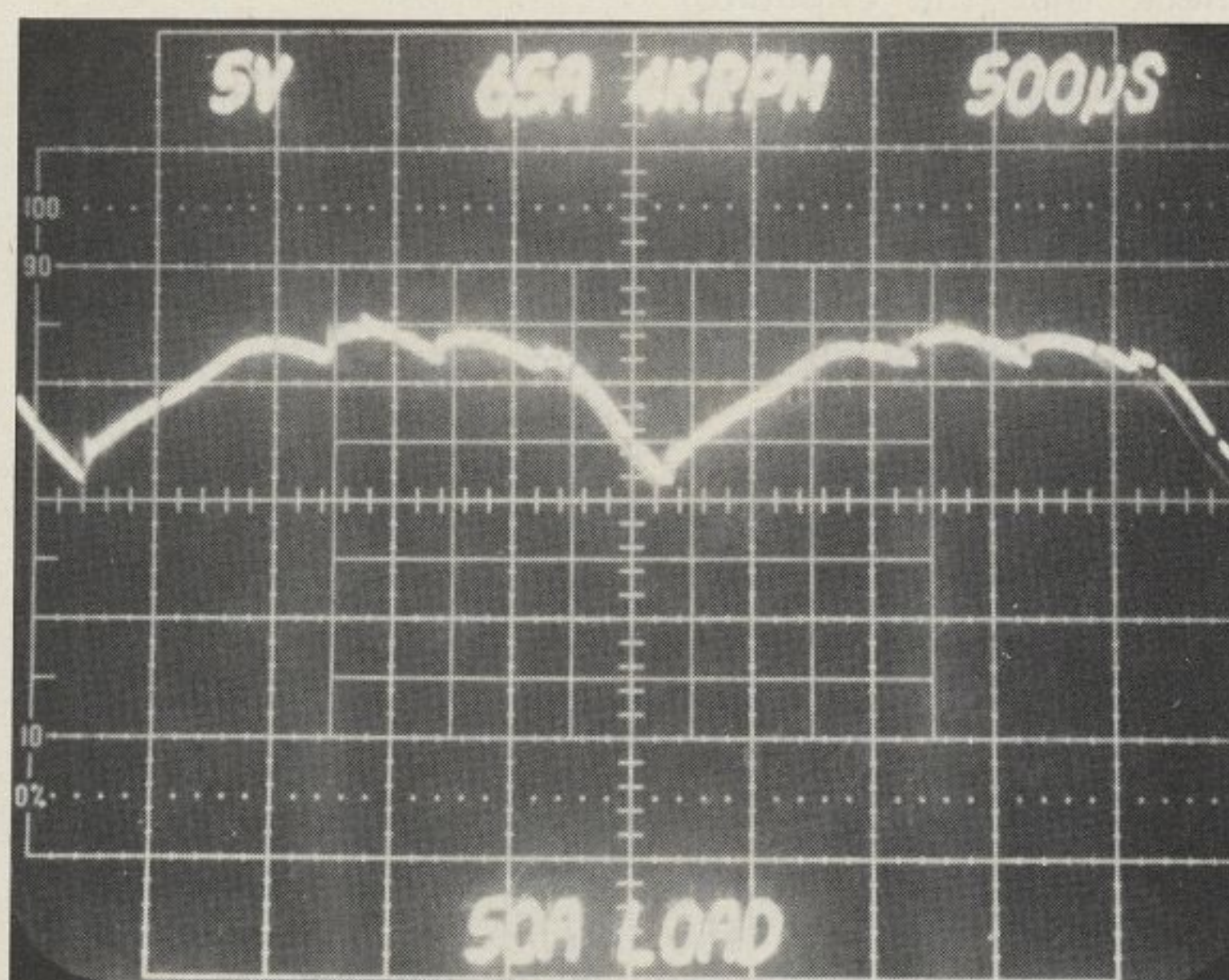

Photo C. Result of open diode in an alternator.

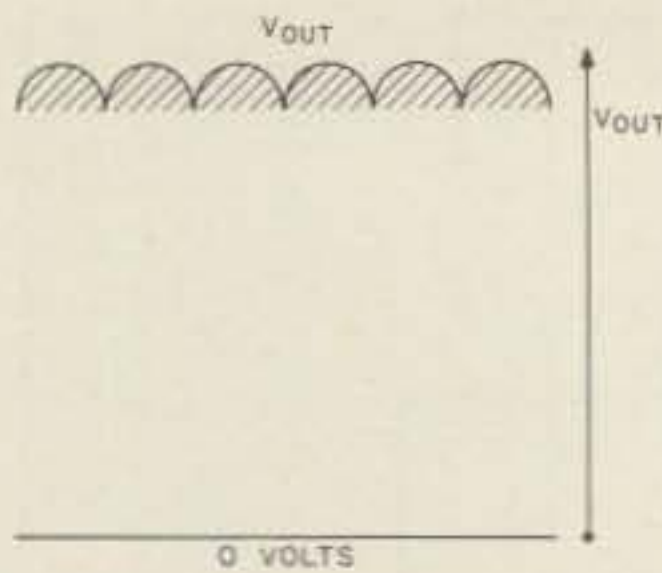

Fig. 2. Three-phase full-wave bridge output.

wards of three Amperes. This amount of current flowing through a choke rated at 2 Amps would saturate the iron core, rendering it useless. There are some 5-A CB chokes available, as well as high-current chokes used with high-power auto stereo systems.

Make sure that there is, in fact, some iron in the choke you buy. I built one on a toroidal core which had strip-iron as its base—not ferrite. Since it involved winding about 100 turns of #16 wire through the toroid, I don't recommend it—unless, of course, your hands are really calloused. I don't find that adding electrolytics across the power line is as effective as a good 0.1-to-0.5- μ F capacitor. Among others, Sprague makes an excellent line of feedthrough capacitors (48P series). These should be connected in series with the battery output terminal of the alternator after you check that the capacitor case is truly grounded to the alternator case. Be sure to get a capacitor with an adequate current rating. Remember, the environment under the hood of a car is severe insofar as temperature is concerned.

For years I've been hearing that the only way to eliminate whine is to run the Vcc feed directly to the battery. One problem with this approach is that the batteries in the new cars have terminals that do not lend themselves to adding external connections. The other problem with this approach is that running long

lengths of unshielded wires in the engine compartment can cause more problems than using existing wiring.

If you happen to run this new wiring in close proximity to the car wires that are radiating, you're making the job tougher to correct. Your connections should be made with at least #16 wire if there is any appreciable run length. In case you're interested in using coaxial cable for your power connections, be advised that the inner conductor of RG-8 approximates a #12 wire, RG-58 has a #19, RG-59 a #22, and a good "mini 8," a #16 wire.

Bring an AM radio close to your car wiring in the engine compartment, and note the presence or absence of whine. Don't worry too much about the other noises you hear. What you are listening to is the snap, crackle, and pop of the primary and secondary of the ignition system, the myriad solenoids and valves that are now added to the engine for pollution control. The saving grace in all this is that all of the aforementioned snap, crackle, and pop is in the form of amplitude modulation. Our VHF equipment, being frequency modulated, is pretty much immune to these spurious AM radiations. Generally, only whine is the problem.

In view of the number of models of autos on the road, it is obviously impossible to list specific fixes for whine. In general, make sure that you are making good grounds in your installation. If you are connecting your ground to a factory-installed ground, be sure the latter is a *zero resistance* connection to the battery. Arm yourself beforehand with a roll of bonding braid (Belden 8663, 8669, or equal) and literally bond your car together—electrically. You can use the same braid to shield

long runs of wire by snaking the wire through the expanded braid and then grounding one or both ends of the braid.

Move some of the wires in the engine compartment away from each other to see if the induced spurs are reduced. Be careful in this operation. The SAE (Society of Automotive Engineers) has had much experience (75 years) in routing wires to prevent them from being wrapped around fans, belts, and other moving parts guaranteed to rip a harness from your car. I cannot stress too strongly the need for good grounding, and one area you should be sure to check is the antenna-to-radio ground connection if you use a magnetic-mount antenna. Remember, the base of this antenna is not grounded—it is insulated from car ground by the paint on the car, rubber gasket, or other nonconducting base material. If you use a gutter-clip mount or a trunk mount, be sure that the mounting screw(s) break through the paint and make zero-resistance contact with the body of the car. These points should be checked regularly to ensure that no oxidation or corrosion sets in to take your antenna off ground.

In my previous car, I used an extra Faston connector in the fuse block as my source of power with a choke in series with my Vcc line. But with the purchase of a new car, I found, much to my chagrin, that GM (at least) changed this connector to a special one, not yet available to the public. Temporarily, I used the cigarette lighter to power my rig with the same choke in the line. According to current myth, this is supposed to be a no-no, but I've had no complaints with that setup. I have since made a direct connection to an unused connector in the fuse block, because the ciga-

rette lighter connection was sloppy and I wanted—or at least my wife wanted—a neater installation. This also provided me with the advantage of ignition-key control of power.

Speaking of cigarette lighters, I have been told that some new cars have reverse polarity. Be sure to check for this, because if you don't have reverse-voltage protection in your rig, you may well cause serious (and expensive) damage to your equipment. When your car is delivered with a factory-installed radio, the manufacturer usually installs a bypass capacitor—probably at the fuse block. After all, they have to have some justification for the prices charged for radios. You might consider tapping the lead that goes to your AM/FM radio for a source of power. This is easily accomplished by three-way pressure taps available in auto supply stores.

In an older car, I once was advised that I had whine where I didn't have it before and that the cause was a "weak" battery; that the internal resistance of the battery was increasing and causing whine. Well, it may have been true that the internal resistance of the battery was increasing with age, but putting in a new battery—which I hastened to do—did nothing to eliminate alternator whine!

Now, after a great deal of time expended in communicating with people at both General Motors and Ford—all of whom have been most cooperative—I have come to the conclusion that eliminating alternator whine must be done at the source—that is, at the alternator. Capacitive bypassing plus a suitable choke in series with the power feed to your radio (at the radio), in addition to good grounding practice should alleviate, if not eliminate, most whine problems. ■

LOOKING WEST

from page 12

this service, I have the knowledge to do so. Why don't I? Simply because I want to see pay-TV flourish. I feel that it has a lot to offer in quality of entertainment and consider the monthly service fee to be the same as money given to support public broadcasting. I am, however, very critical of the subscription-TV services themselves because I feel that the piracy problem is one that they have indirectly generated, and, therefore, it's one that they must solve without government intervention.

SIX METERS: A NEW YEAR'S RESOLUTION

The mail has something to say, and I am delighted with what it says. Amateurs who had put their six-meter gear in the attic or garage are taking it out and putting it back into operation. Others tell me of next-to-nothing purchases that they're making at flea markets. They're gobbling up old Heath Sixers for 10 bucks or less, and grabbing Gonset Communicators for a song, and Clegg 99ers, radios that for years had been a collector's item, are being put back into service. People are coming back to good old six meters and having fun to boot. Many call it a return to the good old days of ham radio. No, it's not a mass exodus from other bands. In fact, it's not a mass anything—not yet. But movements take time to gain momentum and repopulating six meters will not be an overnight affair.

With the exception of one letter from a VRAC chap, all correspondence received has been highly positive. Some did question the wisdom of a return of activity to six in light of possible severe TVI, but in most cases, those writing said they would chance such a move if some good low-pass filters could be found. Many stated that the low-pass filters marketed may claim a 52-MHz cut-off but that they do not seem to be very effective. True, most are not very effective, as years of six-meter operation have shown me firsthand but,

back in the early 60s, there was a very effective low-pass filter. The next time you hit a swap meet, keep your eyes open for a dull-gray aluminum box with the name "Gavin" marked on it. If you can find one of these beauties, you can literally tune away most TVI caused by six-meter transmitters operating below 52 MHz.

As I remember it, the Gavin six-meter filter had 6 sections with a tuning capacitor for each section brought out to the front panel. As I remember it, you first tuned it for maximum forward power and then re-tuned it for minimum TVI... and it worked. My buddy, Larry Levy WA2INM, had one of them, and it's the only filter he ever condescended to use on his home-brew six-meter masterpiece.

Larry's transmitter was a 6U8 driving a 6146 with an outboard pair of 1625s as class B modulators. The transmitter was not shielded in any way, shape, or form and completely took out the low VHF band on a TV in the next room. When Gavin came out with their filter, 73 gave it to Larry for evaluation. Reluctantly, Larry installed a coax connector on his transmitter and put the filter in-line. (ed note: Until that time, WA2INM's transmitter had no connectors in the rf circuitry. The only break in the coax came at the antenna changeover relay—an antique itself.) A "tune-for-minimum-scream" technique was employed wherein Larry tuned and waited for the screams of anguish from the other room to subside. Amazingly, in short order they did.

Later on, I borrowed the same filter from Larry and tried it at my place with the same results. In my case, the filter had an even harder job since my 6BQ6 final amplifier tube was also a doubler rich in harmonic content, and the transmitter had a link-coupled output. (ed note: I did use coax connectors and my transmitter was in a shielded enclosure.) The Gavin filter completely eliminated every trace of TVI on both the RCA set in the living room and the old DuMont

upon which the entire station sat.

I do not know what ever happened to the manufacturer of this device. For a while they were involved in the consumer-TV antenna business, but seem to have now dropped from sight. Maybe one of you out there knows where they are, or perhaps how to contact someone from that company in relation to obtaining the specifications for their six-meter filter. If we were able to obtain such specifications, along with the necessary clearance to publish the data, I would be happy to do so. The Gavin filter worked; I can attest to this from firsthand experience. I also have the inimitable "INM" to back me up in this one.

Another important matter discussed in the received mail was that of converting older AM equipment to FM. I have personally converted only three radio types to FM service. They were the Lafayette HE-45 series, the Gonset Communicator II, and, believe it or not, one Heath Sixer. The Sixer was the easiest, since the superregenerative detector was broad as a barn door to start with, permitting marginal FM reception as it stands. It's only necessary to FM the transmit oscillator stage using the existing internal modulator, while rerouting the final amplifier B+ supply around the modulation transformer and directly to unmodulated B+.

I should warn you that the early HW-32s that used 50-MHz overtone crystals were extremely unstable, and conversion to 8-MHz crystals is a necessity. This means adding another tube on a sub-chassis as an electron-coupled oscillator, and converting the original oscillator to a doubler stage. Again, those of you with a good library of older 73 Magazines are in good luck here, since Larry Levy and others wrote countless articles on how to modify a Sixer. The later HW-32As used an 8-MHz oscillator, so here it's just a simple rewire job. But, the Sixer receiver on FM? Well, if you must, but remember that they were barely marginal on AM.

The easiest FM conversions are to the Gonset Communicators. Here, there are two ways to go. If you have a matching Communicator vfo, you need only to plug in a mike and preamp. Or you can again rewire the existing transmit oscillator and

screen-grid modulate it. Transmitter conversions in general are usually a matter of rerouting existing wiring. Receiver mods run the gamut from "use as they are and slope detect" to "crystal control and quad-detector installation." Here, the choice is yours.

With equipment costs as low as they are for old six-meter gear, we can afford to experiment to our hearts' content—kind of like the experimentation with 10-meter gear salvaged from the 11-meter CB service. The 11-to-10 and what is starting to happen on six meters are similar. The idea of getting back to low-cost basics. As my friend Bob Heil K9EID says in his new book about 10-meter FM, it's "putting the ham back into amateur radio." In fact, I am in the process of reading Bob's new book at this moment, and may have a review for you next month.

I guess the greatest joy I am getting out of all of this is the stir I seemed to have generated among the 10½-meter illegals. I am very proud to tell you that I have become a thorn in their side, and consider being hated by that crowd a position of honor in our society. The other evening I sat glued to my Realistic DX-160 as one of them read what he termed a "73 Magazine exposé" to his cronies, and then listened as this group of fanatics discussed ways to get even. Obviously, we amateurs are not the only ones who read 73.

For those of you who may wonder if my divulging of what I have overheard is legal, well, Section 605 does not offer any form of protection to those who operate illegally, out-of-band, and unlicensed. And I do not worry about them either. Like those who harass two meters and other bands, their bark is greater than their bite. Remember, I am also a persona non grata among certain segments of the Los Angeles two-meter community, and consider this also something to be proud of. When I took to writing this column, I did not intend for it to become a popularity contest. I believe in calling things as I see them, and if certain elements of our society don't like it, such is life.

I'm not out to win any popularity contest, be it with the ARRL or anyone else. But, it's also the

same reason that I have waited a long time in some cases to report on some items, such as cases involving malicious interference. I have no intention of "trying cases in print." It's for the courts to make the legal decisions—we report. I know this is a bone of contention with some readers, but here in this nation, a person is considered innocent until proven otherwise. With the slow movement of the bureaucratic system, coupled with normal magazine lead time, it's sometimes months before you read something here that might appear in other news services sooner, though in far less detail.

But we are getting off the subject. The main thing I want to report is that people are coming to six meters little by little. They're discovering a whole new world in amateur radio. A world seemingly untouched by time. A place where they can still experiment, rag-chew, and enjoy a hobby, and do so with practically no monetary outlay. Eventually those who supply equipment for our service will catch on and start promoting new goodies, but in the meantime we can still sit back and enjoy what amateur radio is really all about. Six meters may be the band that time forgot, but, in retrospect, this may have been a blessing in disguise.

WESTLINK UPDATE DEPARTMENT

Another question that is often asked of me is why I continue to produce a weekly amateur radio

newscast when there is no way to subsidize it. Actually, I am not the only one who subsidizes it, there are two of us. For the most part, the funding to keep the Westlink Amateur Radio News alive comes from Bill Orenstein KH6IAF and me. Currently, it costs us close to \$500 each month, a cost that we share. And we cannot use Westlink as a tax deduction since it's not a charity, business, or any known category of business operation. It's simply the "free service" that its founder, Jim Hendershot WA6VQP, meant it to be and we intend to keep it that way. Every now and then we do receive a small donation but after doing the math out a few weeks ago, the results show that Bill and I fund over 97% of the operational costs.

Unlike other similar services, we do not solicit financial support and only accept that which is offered with no strings attached. It's this concept of total autonomy that has kept us from soliciting support from any organized group, including the ARRL. It has also kept us from asking funding from the amateur manufacturers and publishers. One cannot be autonomous if one accepts the open support of industry or anyone else. So, we just continue as best we can. It's not ego. It may have been in the beginning, but spending 10 hours a week in producing a 10-minute newscast can become an ego buster really quickly. Yet, instead of falling apart, we are growing! And I think I know the reason.

Unlike anything else in amateur radio, save one's own private station, Westlink is the only entity of its type. First, it costs the amateur nothing but a phone call to get news about his hobby service, and another phone call by him may put him into the position of providing an important story to his peers. These days, better than half of our news stories are those which are phoned to us. True, the 10-minute time constraint of our format makes it impossible to use every story we receive, but, nonetheless, the input from the amateur community itself coupled with other standard news sources is what makes it really work. It adds up to about 10 hours each week, 52 weeks a year. We take no holidays.

The reason for bringing this all up at this time is to tell you about the latest expansion of the Westlink news service: A second automated number located in the Dayton, Ohio, area is intended to provide bulletin stations and visually handicapped amateurs in the eastern and central time zones with a more economic method of obtaining the weekly newscast. The people sponsoring the new automated newsfeed are the same people who put on the nation's largest amateur radio convention each year. I speak of the Dayton Amateur Radio Association and its current President, Vic Stauder WA2KOO/8.

The whole idea started over a late snack during the 1980 Hamvention and became a reality in

late September of 1980 when the Dayton newsfeed went into full-time operation. Both the Los Angeles (213)-465-5550 and the Dayton (513)-275-9991 numbers carry the same information produced in the Los Angeles Westlink facilities. The new service was inaugurated with newscast number 156, the start of the 4th year of Westlink operation. Another change made was to make the dial-in numbers public. We realize that there will be some who may abuse the service as a result of this change, but we also feel that it is far more important to have the service available to all who may need it with as little effort in obtaining it as is possible.

So, to those who ask why people like Bill Orenstein, Alan Kaul W6RCL, Jim Davis KA6IUH, Lenore Jensen W6NAZ, Burt Hicks WB6MQV, and others far too numerous to mention devote their time and effort to something that has no monetary reward, I can only tell you that we do it because we love the Amateur Service, and if nothing else, it's our way of paying back a bit of the debt we each owe amateur radio for the many hours of enjoyment we have obtained from it.

Personally, I know that Westlink, this column, and everything else I do in the name of amateur radio will never begin to repay the debt I owe the hobby, a debt that goes back many years when it was my fellow hams who carried me through one of the worst times in my life.

FUN!

from page 22

5) Believe it or not, Hiram Percy Maxim wrote an autobiographical book about his experiences as a youngster, called *A Genius in the Family*. Later, it was adapted as a motion picture and retitled. What was the name of this movie, and who played HPM's parents?

- 1) "That Gang of Mine"—Leo Gorcey and Joyce Bryant.
- 2) "Black Like Me"—James Whitmore and Judy Canova.
- 3) "You for Me"—Peter Lawford and Jane Greer.
- 4) "So Goes My Love"—Don Ameche and Myrna Loy.

ELEMENT 4—TRUE-FALSE

- | | True | False |
|---|-------|-------|
| 1) The original Novice license restricted its holders to QSOs of ten minutes or less, and limited conversations to discussions of signal reports, names, QTHs, weather, and rigs. | _____ | _____ |
| 2) A technical editor of <i>QST</i> once electrocuted himself. | _____ | _____ |
| 3) Nikola Tesla, father of practical ac power, was deathly afraid of round objects (such as baseballs and pearls) and spent many years trying to invent a device that would photograph a person's thoughts from his retina. | _____ | _____ |
| 4) SSB was originally called SSSC. | _____ | _____ |
| 5) The first "W" calls were issued in 1929. | _____ | _____ |
| 6) Before 1950, you only had to confirm 80 countries to become a DXCC member. | _____ | _____ |
| 7) Major Edwin H. Armstrong, inventor of FM radio, committed suicide by leaping from a 13th story window. He was despondent over the fact that commer- | _____ | _____ |

cial interests were using his invention without paying due compensation.

- 8) ARRL Headquarters has two club stations, W1AW and W1INF. _____
- 9) Before 1940, the continental code for a "period" was, not today's .-.-.-. _____
- 10) During the "atom scare" of the late 1950s, the FCC required amateurs to monitor a broadcast station while operating in case of an enemy attack. _____
- 11) Louis Daguerre invented the resistor. _____
- 12) The average spark transmitter used up to 18 tubes. _____
- 13) The US Post Office issued an amateur radio commemorative stamp in 1952. _____
- 14) In 1957, ARRL membership cost only \$5.00. _____
- 15) First marketed in 1946, Collins' KWM-1 was the world's first fully transistorized transceiver. _____

Five Questions About Marconi

- 16) Marconi had only one eye. _____
- 17) Marconi won a Nobel Prize for inventing radio. _____
- 18) Marconi was a Fascist. _____
- 19) Marconi was half-Irish. _____
- 20) Marconi held the amateur callsign I2CC. _____

ELEMENT 5—SCRAMBLED WORDS

Unscramble these names of men who made Amateur Radio possible.

zerht	atwt	soomli
atvlo	xlwemla	yfaaard
miteteszn	ploprd	pamree
mroinac		

THE ANSWERS

- Element 1:**
See illustration 1A.
- Element 2:**
1-J, 2-P, 3-T, 4-S, 5-U, 6-H, 7-C, 8-E, 9-N, 10-F, 11-K, 12-A, 13-G, 14-L, 15-I, 16-R, 17-O, 18-M, 19-D, 20-Q.
- Element 3:**
1-1 Sort of makes you think that ham radio hasn't really come all that far in the past 60 years, doesn't it?
2-3 Named after GE's founder, this award was tossed on the scrap heap when the company ceased selling its products to amateurs.
3-1 DX clubs and foundations, prepare your spaceships!
4-2 But friends just called him Al.
5-4 I'll bet you wonder where I dig up this info. Never mind. Just let me know the next time it appears on the *Late Show*. Perhaps the ARRL should spring some loot for a print of this classic. Bet it would be a great draw at hamfests and conventions.
- Element 4:**
1 False—But it sounds like a typical Soviet QSO.
2 True—Ross Hull's last experiment in 1938 involved touching the high-voltage cage on an experimental TV.
3 True—He also thought you could beam electricity from satellites in orbit around the Earth. A "crazy" idea that may actually come true in the future.
4 True—"Single-sideband, suppressed carrier" was the original name.
5 True—Before then, things were pretty confusing when you had a 2XYZ in 40 different countries.
6 False—Eighty countries isn't a "century," is it?
7 True—Typical American "success" story.
8 True—It was abuses like this that led the FCC to eliminate all

new club callsigns.

- 9 True—And the exclamation point was - - . - - until the change.
- 10 True—It was hard trying to keep the music from going out over the air.
- 11 False—He invented photography.
- 12 False—Spark transmitters didn't use tubes, silly!
- 13 False—1964.
- 14 False—It was only \$4.00.
- 15 False—That would have been a neat trick, considering that the transistor wasn't even invented until a few years later.
- 16 True—He lost his right eye, in 1910, in an auto accident.
- 17 True—A prize which he shared with radio's "co-inventor," Karl F. Braun. By the way, the unknown Braun was so amazed that he was chosen for the honor, he actually apologized to Marconi at the awards ceremony.
- 18 True—Politically naive, he was an early supporter of Mussolini's Blackshirts.
- 19 True—His mother was born in Ireland. Marconi's first wife was also Irish.
- 20 False—Marconi was never a licensed amateur.

Element 5:

(Reading from left to right) Hertz, Marconi, Loomis, Volta, Watt, Faraday, Steinmetz, Maxwell, Ampere, Doppler.

SCORING

Element 1:

Twenty points for the complete puzzle, or 1/2 point for each question correctly answered.

Element 2:

One point for each manufacturer/distributor you matched to its QTH.

Element 3:

Four points for each correct answer.

Element 4:

One point for each correct answer.

Element 5:

Two points for each name successfully unscrambled.

- 0-20 points—Novice school dropout
- 21-40 points—Vacuum resident
- 41-60 points—RCC member
- 61-80 points—Good memory
- 81-100+ points—Ham historian



Illustration 1A.

W2NSD/1 NEVER SAY DIE

editorial by Wayne Green

from page 8

duce already invented and developed products more cheaply than other countries.

Further, I said that I felt that this was a perilous long-term course. Only by the development of their own electronic engineers and technicians will they be able to compete with Japan in technology. I then quoted the figures on hams in Japan... 500,000 active, and the US with perhaps 200,000 active. I further said that the technologies of all countries of the world are surprisingly proportional to their ham populations. Taiwan could hardly expect to compete with these other countries when it has but one single licensed radio amateur.

I told them that you get people interested in technical careers when they are teenagers and that these are the people who have always made the technology breakthroughs. Recognizing the security problem which is almost paranoid in Taiwan, I mentioned that amateur radio had been introduced in the country of Jordan right in the middle of their civil war and that no security problems had been encountered.

The Taiwan businessmen came up after the talk to thank me for it and say how much they appreciated me speaking out like that. One American was furious with me... a representative of the Electronic Industries Association (EIA) who felt that we should try to keep technology in the US and not encourage other countries to compete.

Two of the newspaper reporters present wanted copies of my talk to publish, so Sherry typed it up for them from her recording of my impromptu remarks. They also sent photographers to take pictures of me to go with the articles. Whether this will have any long-range effect or not remains to be seen.

To show that Japan is decidedly ahead of us in the development of electronics products, all I have to do is open my gadget

bag which I cart around. Out comes a Sony TCS-300 stereo recorder, a Sony 400 micro-recorder, a Sharp Talking Clock, A Casio musical calculator or two... things like that. On my wrist is a Casio C-80 calculator watch which has replaced the Rolex I wore for many years. Sherry usually has her Sharp computer and cassette interface in her bag, along with her Sony recorder for program and data storage. This is the same unit Radio Shack is importing and selling as their TRS-80PC. With about twice the number of active hams in Japan, is it any wonder they are so far ahead of us in electronics technology?

My recent visit to Kenwood in Tokyo did not brighten my view of the prospects for American firms. I've seen nothing here to compare with the Kenwood development lab... and with the Yaesu lab which I visited last year. These labs are packed with hams, all having a ball designing next year's ham rigs.

JAPAN AND REPEATER JAMMING

Since repeaters are not yet permitted in Japan, what is the connection I'm trying to make? This one is a bit far afield, but perhaps you'll come with me and see some parallels. By the way, with regard to repeaters in Japan, the benefits of repeaters in other countries have not been entirely lost on the Japanese... it's just that their version of the FCC moves far more slowly than ours, though you may think that impossible.

Having recently wandered the streets of several Asian countries, often at night, and never once having to fear that I would be in trouble, I have been wondering about this. Why is it that women can walk alone at night in Tokyo with no worries? Why is it that I have no problems when I walk in even the seemingly worst parts of Hong Kong at night? Yet, there are many areas of New York City which are not even safe during the daytime?

One of the reasons why I de-

serted New York almost 20 years ago had to do with the deterioration of life there. Nowadays, when I do have to visit the city on business or for a show, I can feel the fear which grips New Yorkers as they plod through the subway stations or walk the streets... even the well-lighted streets... at night.

Another indication of the wide difference between the Asian cities and our U.S. cities is evidenced in the graffiti. This is just one clear evidence of resentment which is not well hidden... the growing hate of the government by the people. This manifests itself in incessant vandalism, where anything which can be destroyed usually is. You don't see this in Japan, Hong Kong, Taiwan, and Singapore.

Milton Friedman put his finger on this in a recent *Newsweek* column... and I think he is right. This vandalism and the growing crime are results of the frustrations people are having with government. The recent election results certainly showed that the frustration level is high. It makes sense to me.

Having recently read the William Simon paperback, *A Time For Truth*, an expose of the gradual encroachment upon us by our government... and having felt the helpless frustration of being in the clutches of that government myself... I am beginning to understand what has happened to our country... and to much of Europe, which has been going along with the same political tide. In the Asian countries which I have visited, the governments for the most part are not interfering with business and with the people... certainly not to the extent which we have developed.

Having been around since before these great changes started, back in the 30s, I've seen personally the enormous change which we have undergone in our country... and been frustrated by it. Much of this has been in reaction to the panic and depression of the 30s, yet we know now that that was brought about primarily by the actions of our government and was not a failure of business at all. Friedman, in his TV series, *A Time To Choose*, made this clear.

Hong Kong and Singapore are shining examples of what can result when the government does not try to shackle business

and dominate the people. Both are centers of great industrial growth and wealth. Indeed, you see more Mercedes cars per block in these countries than anywhere else in the world I've visited. Yet this wealth is not gained from taking advantage of workers, who also are enjoying a level of living which is attracting people from all over the world.

One wonders what would happen to the spirit of our country if the government stopped trying to manage the economy and business... a sort of small-scale copy of the Russian management system, which has failed so monstrously. It does seem likely that our oil problems would be resolved in a free market... that businesses could save billions a year if they could stop having to fill out forms for the government. I know that even in a business as small as mine, we are spending an estimated \$75,000 a year just in filling out forms for the government... gathering information that we have no need for ourselves and sending it in. That may not seem like much, but that's almost a dollar per subscriber for 73.

It may be that Reagan will be able, as none before him has, to start cutting down on the government proliferation. Will they be able to get rid of the HEW? Of the ICC? OSHA? The Energy Department... and so on? And will that eventually bring about happier people and less crime? My end question... I wonder, if we are able to make these changes, if it will result in a spirit in our country which will still the jamming of repeaters, the cursing on the bands, and the general unhappiness which is being demonstrated on our ham bands?

We really don't have to just learn from our past, when we did not have the government bureaucrats all over us and things were happier... we can learn from the lessons of those few countries where there is freedom and they do show the same spirit I saw here when I was young... and which I think we can regain.

The people in Japan are happy and their subways clean. There is not one hint of the graffiti which covers every car and station in the New York subway system. In describing what I saw in a public toilet in the leading restaurant in Canton, China, I

was moved to compare it with the filth and smells of a toilet in a New York subway...only worse, if such is imaginable. Japan, though close to China, has nothing like that.

Several of the people on our visit to China described the frequent serving of tea as the Chinese water torture...since the use of any bathroom but that in our hotel was almost impossible for the women...and the tourist service kept us away from the hotel from early morning till very late at night.

OOPS, WE GOOFED AGAIN?

A few years ago, I ran an article in 73 by a chap who told about discovering the principle of the transistor back in the 1930s...the only problem was that he didn't recognize what he had discovered. Thus amateur radio managed to miss out on one of the most startling discoveries of history. Win a few, lose a few.

Some recent events lead me to wonder if we may not have managed to miss the boat again, though this time there is still an opportunity to pick up the marbles and claim ourselves winners.

Thirty years ago, when amateur radio was in a period of very rapid development using ideas left over from the War and catching up for the time lost from 1941-1945 when we were off the air, we saw the beginnings of VHF repeaters, the first single sideband rigs, and a brief experimentation with double sideband. But, let me explain some recent events so you'll see what I'm talking about.

My success in recording business meetings and symposiums with a miniature Sony TCM-600 cassette recorder was such that when the need arose for a second recorder for this purpose, nothing else was even considered. It is small, light, and amazingly sensitive, putting similarly sized recorders of other brands to shame. Fortunately for me...and possibly for you...the local Sony dealer was out of TCM-600s when I wanted one.

A few days later, I saw an ad in *The New Yorker* for a Sony TCS-300, a miniature stereo cassette recorder. Having enjoyed the phenomenal reproduction of the Sony Walkman stereo cassette player, the idea of being able to make stereo recordings with something not much

larger than the player was attractive. And the ad pointed out that a stereo recording of a meeting made it possible to sort out the various voices talking with ease, while a mono recorder mixed them all together. Definitely a plus.

Despite the full-page ads for the new recorder, Sony had no TCS-300 recorders available when I called. Okay, I'd be in Tokyo in a few days and I'd get one there. Sure enough, I checked with the Sony store in Tokyo and was able to get a 300 immediately. Further, the price was \$130 instead of the U.S. price of \$220—a plus. I'd brought along my Walkman Sony and some music tapes, so I checked them out on the 300 and found it as fantastic on music as the Walkman...though a bit more bulky to carry.

As a side note, the Sony Walkman has been such a hit worldwide that I saw imitations of it at all of the consumer electronic shows...in Tokyo, Seoul, Taipei, and Hong Kong. They all seemed to be good buys and less expensive than the Sony. Once you hear one of these tiny stereo cassette players, you almost have to have one. I use one while I walk, to make the time pass better on plane trips, and even while skiing.

On the Asian trip, I began to use the 300 to make recordings during some of the dinners. When I checked the recordings, I was surprised to find that I could indeed hear what everyone around the table was saying, despite the high level of din from surrounding tables. Most Chinese meals call for ten people to a table, so there are two to five simultaneous conversations going on. With the stereo I could "tune in" with my mind and listen to any of them.

This brought to mind a letter to the editor in one of the ham magazines back in the early 50s. It had to do with using the General Electric Signal Splitter, with one earphone connected to the upper sideband output and the other to the lower sideband. The letter reported that using this system it was possible to tune in one double sideband signal and hear it much more clearly than with ordinary monophonic reception. I tried the idea at the time and found that the writer was right—the result was a very easy to copy phone signal which could be heard clearly through

considerable interference.

The next idea came quickly...what would happen if we were to use stereo microphones on our double sideband transmitter and separate channels into stereo earphones for reception? I suspect that the result would be much the same as listening to the individuals around the table amid the babble in the background...something which completely ruins monophonic recordings.

Would it be possible to use stereo DSB on the ham bands? With such a system, would it be possible for us to operate with stations every few Hertz up and down the band? I suspect that this might well be so. We know that monophonic double sideband signals with a synchronous detector can give good results with very narrow channel spacing. Using the human brain for the filter we should be able to get even better operation since no filter has ever even come close to the ability of the brain to do this kind of work.

The ball is in your court. There is the idea...now it is up to you to do the experimentation and development. Will it be possible for phone stations to operate at a density of perhaps 50 times that presently possible using single sideband...and with far less interference? I suspect this may be true. If it is, we may have another amateur radio breakthrough in communications techniques. You may be sure that I'm interested in getting articles for 73 on your experimental work...and the results.

As I've written recently, the possibilities for DSB seem greater than those for SSB and one is led to wonder what might have happened in history if General Electric had supported John Costas and his DSB work as well as Art Collins did single sideband. Amateurs who were active on the DX bands in the 50s remember the many experimental flights of SAC planes with Collins sideband gear aboard. I remember Mort Kahn W2KR and Don Merten W2UOL (also K2AAA) and their efforts to promote SSB for Collins. I don't know how much they got out of their work, but I know Mort would be unlikely to work that hard for much less than millions. Since billions were at stake, a few million would have been a small investment.

It thus turns out that Kahn

has had a substantial impact on amateur radio...and the world, for that matter. He originally owned Tempco, a firm making transmitters, but which he sold to Otis Elevator. Kahn retired to his yacht with several million dollars from the sale, as I understand the story. The SSB coup did not hurt his fortunes and I think got him interested in taking over the ARRL, which he did almost singlehandedly during the early 60s.

I've already reported on how Kahn managed to get elected to the ARRL and how he quickly took over running the organization. I've also covered how he engineered the move toward a return to the Class A and B licensing which stopped U.S. ham growth for over ten years and set up Japan to surpass us in technology in the 1980s.

If DSB/stereo turns out to be as efficient a communications medium as it appears, we may find that Kahn, by masterminding the sales pitch for Art Collins on SSB, did it to us again.

HORIZONS' FALL

Ham Radio Horizons, which was started in early 1977...about the same time that I started *Kilobaud MICROCOMPUTING*...and reached its peak about a year later when we had a fair number of new hams in need of the simplified articles they presented, finally threw in the towel. With the number of ad pages shrinking constantly, the magazine was losing money every month. A last-ditch effort to rescue it by changing it from a Novice magazine into another *Ham Radio* was doomed to failure.

Ham Radio itself seems to be going the same route, with the average number of ad pages dropping off. In 1977 they had 66 pages average...in 1978 there were 65 pages. By 1979 it was down to 54 pages. This year the average is down to under 35 pages of ads per month! That's obviously a catastrophe.

Part of this has been due to the competition with 73, where most authors are aware of the better payment they get for articles in the larger circulation magazine, thus bringing the best articles first to 73. Part has been due to the drop in interest in amateur radio in general...reflected in a particular drop in esoteric, high-technology articles. Part has been due to the

troubles between the top management of the magazine, now resolved with the death of Jim Fisk, which was reflected in the magazine content. Part was the result of the gathering depression on everyone at the publication over the failure of *Horizons* and the panic over the failure of *Ham Radio* to cope with the changing market.

These are generally hard days for the starting of new magazines. Much of the economy is hurting. Even computer magazines have been more characterized by failure than success. We've seen *Microtrek* and *ROM* give it a big try, only to fail. We've seen *Personal Computing* magazine stagger alone, losing money for several years before throwing in the towel and giving up (it's now in the hands of Hayden Publishing, who is going to have a try at it). One of the worst debacles in the computer field has been the *Byte* offspring, *onComputing*. . . a total disaster. Despite incredible investments in circulation ads, the magazine has brought little more than laughs to the industry.

Our *MICROCOMPUTING* and *80-MICROCOMPUTING* magazines showed that it was not the market, only the understanding of the market that was responsible for the success or failure of a magazine. *80-MICROCOMPUTING* has been one of the most successful high-technology publications in the history of publishing.

Frankly, though the failure of *Horizons* came as no surprise, we were really expecting *CQ* to go down for the final count first. Cowan ran it into the ground before turning it over to the new crew. Despite major efforts at bringing it back to life, neither circulation nor advertising has seemed to really respond. The pages of ads have dropped from

40 average in 1979 to 36 in 1980. With the ham market continuing to drop off, the going is getting tougher for all ham magazines. . . and the weaker can be expected to go under. Even *QST* has been dropping. . . from 107 pages average in 1979 to 95 in 1980. *73* dropped a little, about 2½ pages average, running now about even with *QST*.

What will 1981 bring? Unless amateurs are able to get the hobby going again, there are going to be fewer magazines. . . and fewer sources of information.

THE NEW ENGLAND CONVENTION

Though I was in Tokyo at the time of the show, some spies have reported on the Boxborough ARRL convention. It appears that a fair crowd turned out for Saturday, but it was virtually deserted on Sunday. There is considerable difference of opinion on the actual number of attendees, with exhibitors putting it at around 3,500 and management at 4,500 or so. Judging from the response at the *73* booth, even the 3,500 figure is generous.

There were only two dealers at the show exhibiting. . . Tufts and Harrison Radio. Harrison, which seems to be in trouble these days, had little merchandise, but was promising shipment. With all but one of their stores closed and a lot of rumors flying, it was good to see that there was some life left. Tufts, which had piles of equipment available, racked up record sales for a convention.

The *73* booth kept active all through the convention, but some of the other magazines folded up early due to inactivity. *CQ* apparently has yet to win over many amateurs with their "new" format. . . which looks amazingly like the one which sunk it for Cowan. *HR* and *HRH*,

with the loss of Fisk, seem to have lost direction and the resulting boredom with the publications was evident at the convention.

The hit of the show was a new slow-scan system from KW Control Systems. This new system provided virtually 500-line resolution pictures and had just about everything you could ask. Kenwood was there with their new equipment and that certainly got the blood going. Ditto the new Icom gear. Yaesu seems to have lost enthusiasm and was not present. . . nor was Den-Tron. There are rumors of a change in management at Den-Tron, with emphasis on non-ham equipment.

The Avanti and Kantronics booths were packed all through the show, as was the Optoelectronics booth. The convention was definitely worthwhile for the attendees. . . and for the exhibitors. . . no matter the actual attendance numbers.

RADAR DETECTOR PRECEDENT

The state of Connecticut was recently backed down by the courts and prohibited from confiscating radar detectors. Since this decision came from the Appeals Court, it will act as a precedent for other courts. The court also affirmed the right to a jury trial for radar detector defendants, which should further discourage that state from harassing detector users.

I WANT YOU!

With most magazines, your responsibility as a reader ends once you have subscribed or bought a single copy. This is not true with *73*. When you decide to read *73*, you are committing yourself to much more. I expect you to do your part toward making the magazine interesting and to accept some responsibility for this.

For instance, one of the reasons you enjoy *73* is because we have the newest in state-of-the-art articles. In fact, many professionals write to say that they are able to find out far more about new ideas by reading *73* than by reading the dry papers in the professional journals. You can help with this by keeping your eyes open for any friend who has done something or built something which we all should know about. For some reason, those who do the most brilliant work are usually least interested in doing the paperwork, so they need to have you lean on them.

You should be aware of one other factor: The more readers we have, the more advertisers we will have. . . and the more pages of articles we will be able to publish. So see that everyone in your ham club knows about *73*, spread the word at work, and help us to grow.

You can help me get information, too. Though I breeze through some 200 magazines a month, with several thousand out there I don't see, it is very likely that I am missing a lot of things which I should know about. So, if you run into something which you think might be of interest to me, please cut it out or make a copy and send it so I can read it. I'm interested in many things. . . anything on hamming, radar detectors, UFOs, Jordan, getting the US going again, microcomputers, etc.

Each month I read *Car and Driver* magazine with envy. . . noting their many interesting editorials. I do wish that more readers with interesting ideas and experiences would write in. With the color we are able to use in the magazine these days, we can do a much better job on DXpedition reports. So keep those cards and letters coming.

HAM HELP

I wish to convert a Lafayette model HB-740 CB rig to 10 meters. I need a schematic for this rig since Lafayette has gone out of business. Any hints or suggestions for converting the

HB-740 to 10 meters will be greatly appreciated. I'll be glad to pay all costs.

Chris Van Veen N1AUD
440 Main Street
Concord MA 01742

I am in need of an ac power supply for a Collins KWM-2A.

H. F. Schnur
115 Intercept Ave.
N. Charleston SC 29405

I have a James Thomas HCV-3KB-1 keyboard for SSTV. I would like to hear from anyone who knows of a successful way to superimpose lettering over other video SSTV pictures generated by the Robot 400 scan

converter. I'm also looking for any information on the RTTY and CW add-on boards for the HCV-3KB-1.

Any and all information and/or ideas would be greatly appreciated and passed on to other James Thomas owners. Thank you.

Michael Larson WD0EZK
RR2, Box 57
Jewell IA 50130
(515)-539-4345 (collect)

CONTESTS

from page 14

ble on 160-meter phone in a maximum of 30 hours allowable contest time. Multi-operator stations may operate the entire 48-hour contest period. Entry categories include single- and multi-operator, both with single transmitter on phone only.

EXCHANGE:

Stations within the Continental USA and Canada transmit RS report and state or province. All others transmit RS report and DX country.

SCORING:

All valid two-way contacts score 5 points per QSO. A station may be worked only once for contest credit! Multipliers are as follows: 1 multiplier point for each of the Continental US states (48 max.); 1 multiplier point for each of the Canadian provinces (13 max.); 3 multiplier points for each DX country outside the Continental US and Canada.

The final score is the total QSO points times the total multiplier points.

DX WINDOW:

Stations are expected to observe the DX window from 1.825 to 1.830 MHz as mutually agreed by Top Band operators. Stations in the US and Canada are asked not to transmit in this 5-kHz segment of the band.

AWARDS:

Contest awards will be issued in each award category in each of the Continental US states, each Canadian province, and each DX country.

DISQUALIFICATIONS:

Disqualifications may result if contestant omits any required entry forms, operates in excess of legal power authorized for his given area, manipulates operating times to achieve a score advantage, or fails to omit duplicate contacts which reduce the overall score more than 2%.

ENTRIES:

Each entry must include log sheet, dupe sheet for 100 or

more contacts, a contest summary sheet, and a multiplier checklist. All entries must be postmarked no later than February 21st. To request contest forms or submit your entry, write: Dan Murphy WA2GZB, PO Box 195, Andover NJ 07821 USA. Please include an SASE!

FREEZE YOUR ARCTIC OFF EXPEDITION

Starts: 2000 GMT January 17
Ends: 1500 GMT January 18

The Ford Tin Lizzy Club's North Metro Chapter will endure their third expedition out on the frozen wastes of Lake Saint Clair. Operating frequencies will be 7275, 21380, 146.52, 146.55, and 146.58, as propagation allows. One station will always be active on 7275! The callsign is AD8R/8 and, as usual, a handsome certificate will be awarded to all contacts. QSL to Box 545, Sterling Heights MI 48078. No SASE is needed!

MICHIGAN QRP CLUB CW CONTEST

Starts: 1500 GMT January 17
Ends: 1500 GMT January 18

This is a CW-only allband (160-10 meters) QRP contest in conjunction with the dates of the AGCW-DL QRP contest. This contest is open to all amateurs and all are eligible for the awards. Each station will be competing within own state, province, or country in the three categories listed: (1) one Watt or less of output power; (2) five Watts or less of output power; (3) over five Watts of output power. A station may be worked only once per band for point credit.

EXCHANGE:

RST, QSO number, and power output.

SCORING:

Each contact is worth one point.

AWARDS:

Certificates awarded to the highest-scoring station in each state, province, and country.

ENTRIES:

Log information must include

full log data, name, address, equipment used, and power output. Logs must be received by the contest manager no later than 6 weeks after the end of the contest. US and Canadian entries please include an SASE. All others please include one IRC for contest results. Send all logs to: Contest Manager, Michigan QRP Club, 281 Crescent Drive, Portland MI 48875.

QRP ARCI JANUARY SSB PARTY

Starts: 2000 GMT January 17
Ends: 0200 GMT January 19

The contest is open to all amateurs and all are eligible for the awards. Stations may be worked once per band for QSO and multiplier credits. No repeater contacts are allowed. VHF/UHF contacts must be direct.

EXCHANGE:

Members—RS, state/province/country, and QRP number. Non-members—RS, state/province/country, and power input.

SCORING:

Each member QSO counts 3 points. Non-member QSOs are 2 points, and stations other than W/VE count 4 points each. Multipliers are as follows: more than 100 Watts input— $\times 1$; 25.1-100 Watts input— $\times 1.5$; 5.1-25 Watts input— $\times 2$; 1.1-5 Watts input— $\times 3$; less than 1 Watt input— $\times 5$.

Final score is total QSO points times total number of states/provinces/countries per band times the power multiplier. Any bonus points are then added to the final score. Stations powered by solar or wind power can add 300 bonus points. Stations powered by other emergency-type power (batteries, generator, etc.) can add 100 bonus points.

FREQUENCIES:

SSB—1810, 3985, 7285, 14285, 21385, 28885, 50385.

AWARDS:

Certificates to the highest-scoring station in each state, province, or country with more than two entries.

LOGS & ENTRIES:

Send full log data, including full name, address, and bands used, plus equipment, antennas, power used, and method used for determining bonus points. Members should include

their QRP number on the summary sheet with the scoring. Entrants desiring results sheet and scores, please enclose a business-size envelope with sufficient return postage. Logs must be received by March 25th to qualify. Logs arriving after this date will be used as check logs. Finally, in case of disputes with scoring, the decision of the contest chairman shall be irrevocable. Send all logs and data to: QRP ARCI Contest Chairman, Edwin R. Lappi WD4LOO, 203 Lynn Drive, Carrboro NC 27510.

FRACAP WORLDWIDE CONTEST

Starts: 0000 GMT January 18
Ends: 2400 GMT January 18

Use all bands, 10 through 160 meters, on SSB only. Operating categories include single-operator, one band, and all bands.

EXCHANGE:

RS report plus a three-figure contact number starting with 001.

SCORING:

Stations in FRACAP: Each contact with another FRACAP country counts 3 points; others count 1 point.

Stations in the rest of the world: Each contact with a FRACAP country counts 5 points; others count 1 point.

The multiplier is the total number of FRACAP countries plus all call areas in the 6 FRACAP countries worked. Final score is then the total QSO points times the sum of the multipliers.

AWARDS:

Certificates to all stations with at least 20 contacts with FRACAP countries. Plaque for the first-place station in each FRACAP country in each category, and for the winner outside FRACAP. Other awards according to participation.

ENTRIES:

Entries must be postmarked no later than February 28th and addressed to: PO Box 2412, San Jose, Costa Rica, C.A. For additional information, write to the same QTH.

TEXAS QSO PARTY

Starts: 0000 GMT January 24
Ends: 2400 GMT January 25

Sponsored by the West Texas Amateur Radio Club of Odessa TX. Use all bands and modes.

Each station may be worked on each band and each mode. Mobiles may be worked again upon each county change.

EXCHANGE:

QSO number (beginning with 001) and state, province, country, or Texas county.

FREQUENCIES:

Novice—3710, 7110, 21110, 28110.

Phone—3940, 7260, 14280, 21370, 28600.

CW—3575, 7055, 14070, 21070, 28090.

SCORING:

All non-Texas stations score points as follows: Phone contact with fixed station in TX = 1 point; CW contact with fixed station in TX = 2 points; phone contact with mobile station in TX = 5 points; CW contact with mobile station in TX = 7 points. Multiply by the number of Texas counties worked (254 max).

All Texas stations score 1 point per contact on phone, 2 points on CW regardless of

fixed or mobile. Multiply by the number of state, countries, and Canadian provinces worked.

AWARDS:

Plaques to top scores: US, US Novice, DX, Canada, Texas fixed, Texas mobile, Texas Novice. Certificates to top score in each state, country, and province. Special awards as activity dictates.

ENTRIES:

All logs must be received by March 15th. Mail entries to: Tom Horton K5IID, 2708 Halifax, Odessa TX 79762.

SNOWFLAKE MADNESS

The Michigan Technological University Amateur Radio Club and the Copper Country Radio Amateur Association announce a radio celebration of our Winter Carnival festivities in the northernmost part of Michigan's Upper Peninsula.

Tech's Winter Carnival is probably the most spectacular winter festival in America with fantastic snow sculptures, dog-

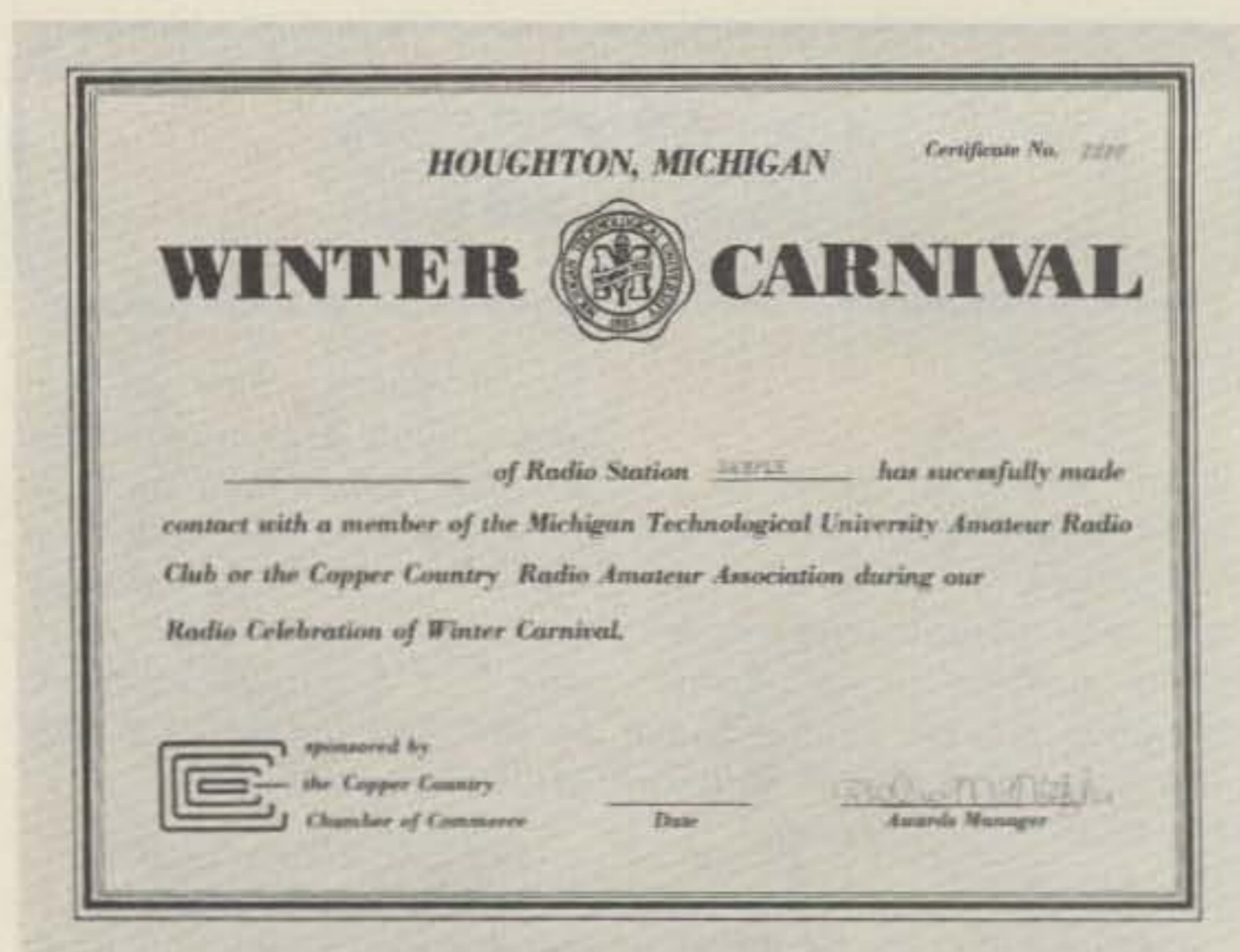

sled races, lots of skiing, and other festive events.

In association with the Copper Country Chamber of Commerce, we are issuing a certificate to all amateurs who make contact with any ham in the Copper Country between 0000Z February 2 and 0000Z February 9. Only one contact is required for the certificate.

Suggested frequencies are: 3.705, 3.975, 7.085, 7.105, 7.285, 14.085, 14.305, 21.085, 21.185, 21.385, 28.185, and 28.685. On CW, listen for "CQ Winter Carnival."

Send your QSL along with two 15¢ stamps (for postage and handling) to: Debbie Nietzke WD8JPX, 2005D Woodmar Dr., Houghton MI 49931.

NEW PRODUCTS

from page 35

The SC-422 is housed in a 12-x 4-x 7-inch aluminum cabinet. The US distributor for the SC-422 is *KW Control Systems, Inc., Box 114C, RD#4 South Plank Road, Middletown NY 10940*. Reader Service number 479.

1750-METER TRANSMITTER

Palomar Engineers has announced a new transmitter kit for the 160-190-kHz experimenters' band. Operation at one Watt input power and with a 50-foot maximum antenna length is permitted by the FCC with no license required.

The transmitter is in two parts. The main transmitter assembly and wiring (including winding the Litz wire coils) is factory-completed. Wiring of the kit takes about an hour with simple tools. Complete assembly and operating instructions are supplied. The transmitter is for CW operation but easily can be AM-modulated if desired. For

further information, contact *Palomar Engineers, Box 455, Escondido CA 92025*.

NEW NLS TOUCH TEST 20 DMM

Futuristic touch controls and a multitude of test functions are featured in Non-Linear Systems' new Touch Test 20 digital multimeter.

The 3½-digit Touch Test 20 measures 10 parameters and 20 functions and includes 44 ranges. Test parameters include ac and dc volts, ac and dc current, resistance, capacitance, temperature, continuity, conductance, and diode test. The package size is a small 2.9 inches high by 6.4 inches wide by 8 inches deep. Weight is less than 3 pounds. Touch Test 20 may be purchased as a line powered unit or (optionally) comes equipped with rechargeable batteries for battery or line operation.

Accessories included with the instrument are OSHA-style test leads, a temperature probe,



Palomar Engineers' 1750m transmitter.

and a component test adapter for radial lead components.

An optional leather carrying case allows the Touch Test 20 to be operated while worn around the neck or on the belt, providing

hands-free operation.

For further information, contact *Non-Linear Systems, Inc., PO Box N, Del Mar CA 92014; (714)-755-1134*. Reader Service number 481.

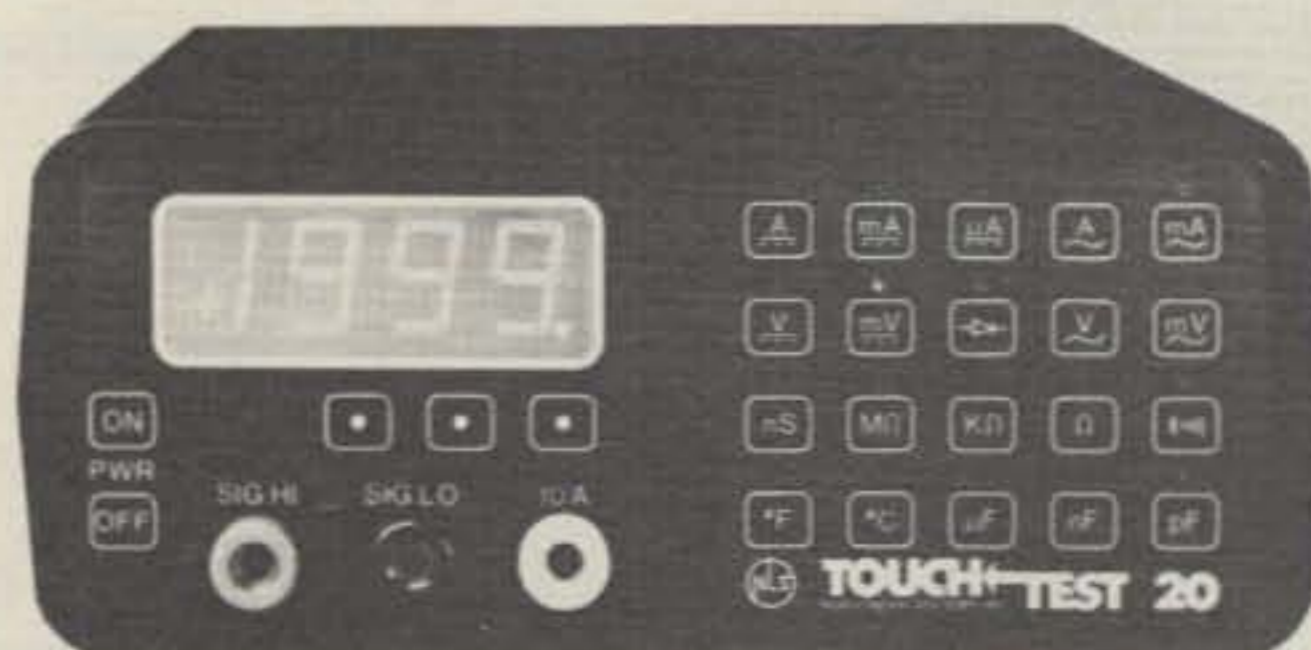

NLS's Touch Test 20.

REVIEW

from page 39

only this time you hold down the "6" button. When you think about it, this is pretty much the same way that a traditional keyer is adjusted, except that AEA has taken out the knob-twiddling.

If variable speed doesn't suit your taste, the CK-1 offers two preset speeds as well. You simply press the "*" button twice, and then press the "8". Following that, you enter the exact speed you desire. If that happens to be, say, 15 wpm, you press the "1" and then the "5". Presto! You're now operating at exactly 15 wpm. And just in case there is another CW fan in the family, you can preset another speed in the same manner, this time using the "9" key instead of the "8". Either memory can then be recalled. In either the variable mode or the preset, you can select speeds from 2 wpm all the way up to 99 wpm.

Well, so far we've discussed a lot of interesting features, but nothing of exceptional interest. Don't worry, it gets better! When AEA called this a memory keyer, they weren't joking. The CK-1 has a total capacity of about 500 characters, and this capacity is soft-partitioned, allowing you to divide the memories into up to ten messages of any length as long as the total does not exceed the storage capacity. If you want to put 400 characters in memory location "1" and 50 characters each in memory locations "2" and "3", it's perfectly possible. 50 characters in each of the ten memories? Fine. There aren't too many keyers that offer this flexibility. No matter how you juggle those memories, five hundred characters is a lot of memory. Get out your calculator and figure out how long it would take to send that at your usual speed, and you'll see what I mean. You'll have a blast loading it up with all the name, QTH, rig, and antenna information you can think of—and there still will be room for more!

"Aha," you say. "How hard is it to load?" Loading the mem-

ories couldn't be easier. Select the memory-load mode with the switch on the side of the keyer, push any button "1" through "0" to select a memory location, and start sending. This loading mode has automatic character and word-space loading. If you pause for a normal word space or longer between characters, it will insert a normal word space in the memory and no more, so you can sit and think about what you are going to say next without filling up your memory with empty space. This provides a distinct advantage over most keyers that limit you to a real-time method of loading memory.

Admittedly, it sometimes is useful to be able to load in real time. For instance, if you are going to make a sally into the Novice bands, you may want to send at about 18 wpm but space your characters and words out so that actually you are sending at 10 wpm. Surprise! The CK-1 can do this, too. Just remember that like any real-time loading keyer, it then will eat up your available memory a lot quicker than if you send with "correct" spacing.

As you contemplate filling up that vast memory with seamless CW, the awful specter of *mistakes* rears its ugly head. Don't fret; the CK-1 has full editing capability, so when you err, you won't have to start all over again. If you get completely fed up with a particular message, it is a simple matter to erase the whole thing. You just press the memory location number (say "2") and the "*". Whatever was in location "2" is gone forever. Naturally, if you shut the keyer off completely, *everything* goes. It is more blessed to leave the CK-1 on all the time than to reload its memories every time you operate.

By now, all the CW contesters are jumping up and down and yelling, "But does it do serial numbers?" Suffice it to say that the CK-1 will send and automatically increment any numbers between 01 and 9999, starting with the number of your choice. If you work more than 9999 stations in any single contest, you

are either cheating or hallucinating.

There are a lot more things that the CK-1 can do, but I think I'll leave you to discover them on your own. All in all, I have only one complaint regarding the CK-1, and this involves the audio confirmation it gives you on each entry. I think this is a wonderful idea, but for various reasons I prefer to use the sidetone in the transceiver rather than the sidetone in the keyer. When you turn down the sidetone on the keyer, you lose the audio confirmation feature. Perhaps AEA could provide the option of having audio confirmation without the sidetone. This is, of course, a very small complaint, particularly in light of the fact that the CK-1 provides an excellent tactile response to each entry.

A commonly asked question is, "How do you remember which buttons to push?" I must confess that I was a little worried about this at first, but after about an hour with the thing I found myself handling the touchpad automatically. It's as though the keyer becomes an extension of your mind, and you suddenly realize that you are making it do what you want it to, without even thinking about it. I can't tell you exactly why, but the touchpad entry is much easier to handle than the knobs and switches on more traditional keyers. If you do forget how to make the keyer perform a particular function, you can simply refer to the clear and straightforward chart that AEA provides on the back of the instruction book.

Perhaps the most amazing thing about the CK-1 is its price. At the time of this writing, the list price is \$129.95. A memory keyer with the features of the CK-1 can be a very useful tool for the CW operator; at the price, a lot of hams will be able to afford one. The CK-1 may well become the standard against which all other keyers are measured.

For further information, contact *Advanced Electronic Applications, Inc.*, PO Box 2160, Bldg. O & P, 2006-196th SW, Lynwood WA 98036; (206)-775-7373/524-7374.

Paul Grupp KA1LR
73 Staff

KRECO MODEL CO2A COAXIAL ANTENNA

When hams decide to put up a base station antenna for two meters, thoughts often turn to the ubiquitous quarter-wave ground plane. The usual approach is to mangle some coat hangers and solder the results to an SO-239 chassis-mount connector. This might be the cheapest solution, but it is not necessarily the best. This configuration has a relatively high angle of radiation and is not what could be referred to as a neighbor-pleasing design. Worse, the antenna-to-coax connection is exposed to nature; if your area receives a lot of precipitation, all you can do is buy lots of plastic tape and hope for the best.

The Kreco coaxial antenna makes up for all these deficiencies, and more. As suggested by its name, this antenna uses the coaxial method of achieving a ground plane. Instead of radials, a sleeve or skirt made of aluminum is connected to the shield of your 50-Ohm coax. The sleeve fits over the support pipe, and attaches to the antenna with a reassuringly large number of hefty sheet metal screws.

All this provides several advantages over the mangled-coat-hanger approach. The angle of radiation is lowered somewhat, and the coax feedline is effectively decoupled from the antenna, allowing your transmitter's power to be put to work where it will do the most good. Best of all, since the sleeve completely covers the coax connection, you don't have to worry about water getting into your expensive coax. Finally, the whole thing screws securely onto a 3/4-inch threaded pipe. If the pipe is well supported, the Kreco antenna will survive anything short of a tornado.

So how does it work? Very well indeed. Kreco makes no claims for spectacular gain; what they offer is good basic performance in a sleek package that can be put up and left up for years and never require attention. I'll never mangle another coat hanger again!

For further information, contact *Herb Kreckman Company*, Cresco PA 18326. Reader Service number 478.

Paul Grupp KA1LR
73 Staff

LETTERS

from page 20

I'm sure that hams could come up with some pretty good ideas.

Mike Desharnais WA1IPD
Somersworth NH

IT'S YOUR FAULT

Some observations: *73 Magazine* is the only ham radio magazine that I have subscribed to since 1963. Before then, I was an ardent supporter of *QST*, but when they got whole-hawg behind this incentive licensing and helped snatch away privileges I had earned fair and square and enjoyed for ten years, then the hell with them. They couldn't pay me to become an ARRL member—now or ever!

I don't go out of my way to bad-mouth the ARRL, but I don't hesitate to voice my own opinions on the air when asked, either. My philosophy has always been "the first time they do it to you is their fault, but if you go back for more and they do it to you again, then it's *your* fault!"

If anyone can show me where the incentive licensing change of 1968 helped amateur radio more than it devastated it, then I'll be the first to back-paddle, but first I'll need a satisfactory answer to why today—twelve years afterward—one must tune and search across the Advanced- and Extra-class portions of the bands, especially 40 and 75 meters, to find a QSO in progress while the General part is overflowing with nets and,

yes, Advanced- and Extra-class hams, all bitching about the QRM!

Oh, I know the theory behind incentive licensing—everyone does. But it hasn't really worked out, has it? The way I see it, about all it accomplished was to crowd all the activity into the upper ends of the phone bands and leave the lower ends sparsely used. And this in present-day overcrowded bands! Well, there! That's off my chest. Oh, I don't expect it to do a bit of good, but it helps to relieve the pressure inside. Thanks for listening.

Bill Skipper K0ARG
Greeley CO

THANK YOU, DICK

I have enjoyed your magazine for several years but best of all was the article on Dick Bash. It gave me the idea to upgrade to Advanced, so I sat down and ordered the "Bash cheat sheet."

I want to tell you that the Final

Exam is not something to "just memorize." I followed his advice and read the guide over 10 times, but, when I came to a question that I didn't understand, I would look it up in other books.

By the time I had finished the guide, I had read many articles pertaining to electronics. When I did go to the FCC to take the test, I actually knew much more than when I started the Bash system. I also found one question in the FCC test that was exactly as Bash stated it would be. But, I knew enough to pass with flying colors.

Thanks to Dick Bash and the Final Exam, I got the shot in my arm to get off my duff and study enough to pass one more exam. Now I am looking forward to sending for the *Final Exam* for Extra and trying to upgrade for the final time.

Thank you, Mr. Bash, for not giving me anything except the incentive to learn something.

Leo Mercer N0AHH
Albert Lea MN

AWARDS

from page 16

There are no band or mode restrictions; however, I am told if the applicant wishes to be recognized for single band or mode accomplishments, the preference should be stated when making application.

The Onion Award is issued on a point basis. Stations in Belgium need to total 10 points for the award; Europeans need 5 points; other DX stations must accumulate a total of 3 points. These points are earned as follows: one (1) point for a contact with an amateur located in the Aalst section of Belgium and two (2) points for a club station within Aalst.

To apply, have your list verified by two amateurs or a local radio club official. Enclose your confirmed list with 10 IRCs and send to: Onion Award Manager, Beulens Annemie, Ravenakkerstraat 52, 9390 Moorsel, Aalst, Belgium.

Stations which qualify for points are: ON1CH, ON1JA,

ON1MC, ON1MV, ON1MW,
ON4JT, ON4MS, ON4NJ,
ON5HZ, ON5KC, ON5NM,
ON5QT, ON5SU, ON5VP,
ON5VW, ON6AZ, ON6BA,
ON6BN, ON6BP, ON6CW,
ON6EE, ON6ED, ON6EJ,
ON6HW, ON6HX, ON6IR,
ON6NN, ON6NV, ON6OX,
ON6PZ, ON6RK, ON6SM,
ON6VW, ON6WA, ON6WS,
ON6YZ.

WAC YL AWARD

The Young Ladies Radio League issues the Worked All Continent Young Ladies Award to any licensed amateur who can meet the requirements of their program.

Two-way communications must be established with Young Lady amateurs in each of the six continents of the world: North America, South America, Europe, Asia, Africa, and Oceania. The applicant may utilize any band or mode of operation; however, crossband contacts will not be valid. There is no date limitation.

While all contacts with the six continents must have been made with duly licensed women operators, your contacts must have been made from the same QTH or community not to exceed a 25-mile radius.

To apply, applicant must prepare a list of contacts and also submit QSL cards or written proof of each contact along with the application.

While there is no charge for the award, applicants are requested to forward sufficient postage to cover first class return of your QSL cards. The YL Radio League assumes no responsibility for damaged or lost cards.

Forward your applications to the Award Custodian: Miriam Blackburn W3UUG, Box 2, In-gomar PA 15127.

While on the subject of YL awards, the YL Radio League also sponsors a Worked All States effort as well.

WORKED ALL STATES—YL

If you thought for one minute that the Worked All USA Award was fairly simple, try your luck at working each state with a YL contact! Not so easy, is it?

The Young Ladies Radio League makes available the WAS-YL Award to any licensed

amateur who can establish two-way contact with a YL in each of the 50 US states.

While there are no date, band, or mode restrictions, you can request single band or mode recognition at the time application is made.

To qualify, all contacts must have been made within 25 miles of your QTH and any call you possess may be used to make contact with the 50 state YLs.

To apply, place your contacts in order by state beginning with Alabama and working alphabetically through your list. Include QSL cards or other forms of written confirmation for each contact claimed.

Forward your QSL cards, your application, and the list of claimed contacts to: Stella McPherson WA4WPN, 2029 Elbow Road, Chesapeake VA 23320. Be sure to include sufficient postage for first class mail return of your QSL cards. While there is no award fee, the League will not assume responsibility for the loss or damage of your cards.

WORKED ALL TRANSKEI

Early this week I received a very nice letter from Len S8AAT and he told of the very popular

Transkei Amateur Radio League Award now being offered.

The Transkei Amateur Radio League has formally announced the Worked All Transkei Award which is made available to licensed amateurs throughout the world.

To qualify for the award, stations within Zone 38 must log a total of 4 Transkei (S8 prefix) stations since October 26, 1976. Stations outside of Zone 38 need only log two stations in Transkei.

There are no restrictions on bands or modes and even cross-band contacts are permitted. Stations wishing to be recognized for single band or mode achievements may request recognition at the time application is made.

To apply for this award, prepare a list of claimed contacts and have it verified by at least two fellow amateurs or a local radio club official. Forward this list and an award fee of \$1.00 or 10 IRCs to: The Transkei Amateur Radio League, PO Box 750, JMTATA, Republic of Transkei, South African Coast.

DIPLOMA DOS CONCELHOS PORTUGUESES

Sponsored by Associacao de radioamadores Portugueses, this Portuguese County Award is available to licensed amateurs of the world under the following rules and conditions.

First of all, the DCP (Diploma of Portuguese Counties) is issued in four (4) classes: Class A—fixed HF; Class B—HF mobile; Class C—fixed VHF; Class D—VHF mobile. According to the number of Portuguese counties confirmed, the applicant may achieve one of the following grades of award: Grade I—75 counties; Grade II—125 counties; Grade III—175 counties; Grade IV—200 counties; Grade V—255 counties; Grade VI—250 counties; Grade VII—the maximum of 274 counties.

When making application for the DCP Award, the applicant is advised first to obtain the special awards booklet available from WB9RLY, who is the Canadian and US associate of the Amateur Radio Club of Portugal.

This booklet will be extremely helpful to the applicant in establishing county locations and for finally submitting his or her application.

Do not send QSL cards! Have your list of confirmed contacts verified by at least two fellow amateurs or a local radio club secretary. Forward your application and an award fee of \$2.50 or 7 IRCs to: ARP, PO Box 2145, 4021 Porto Codex, Portugal.

RCCI DX AWARD

This week I was very happy to hear from my dear friend Professor Giulio Nardona, the President of the Radio Club Ciechi d'Italia. Giulio and his fellow amateurs are particularly proud of the following two awards.

The Radio Club of Blind Radio Amateurs of Italy has organized a new award entitled the RCCI DX Award. Starting from December 25, 1975, this award is open to all radio amateurs who can accumulate a total of 350 points as prescribed by the rules of the award.

Increments of 400, 500, and 600 points are earned with the delivery of blue, silver, and gold cockades to be fixed to the basic RCCI Award. In addition, every year prizes will be given to the first three amateurs better classified according to the points totaled during that year. Applicants scoring 600 points in the maximum of 10 years will be listed in the Honor Roll and will become Honorary Members of RCCI and will become "Jolly Stations" for this award.

To determine points, each country listed on the DXCC list of 1975 will have a value of one (1) point if worked on 15 and/or 20 meters. For contacts on 10, 40, or 80 meters, two points may be credited. A country may be worked only once on a band and contact with a Jolly Station may earn you 15 points; however, a Jolly Station may only be worked once.

Do not send QSL cards! Prepare a list of contacts, including date and time worked in GMT, band and mode of operation, and the points claimed for each contact. Have this list verified by at least two amateurs.



I0LL, the chairman of RCCI (Italian Radio Club for Blind Operators), in his shack. He is showing some of the instruments specifically manufactured by RCCI for blind amateurs.

Forward your application and an award fee of \$4.00 or 10 IRCs to: RCCI Awards, I8KUT, PO Box 2011, 80100 Napoli, Italy, Europe.

The following stations earn the applicant 15 points: I0LL, I0PNK, I0SUQ, I0WFI, I0WHY, I1KJ, I3ANE, I4LDY, I8DOE, I8FTV, I8KUT, I8NMM, I8SRP, I8YRK, I0OGT, IT9VQC, and GM4ELV.

WORKED ITALIAN PREFIX AWARD

In remembrance of Pietro Spriano I0KA, founder and first President of the Radio Club of Blind Radio Amateurs of Italy, the organization has organized

the Worked All Italian Prefix Award which becomes available to amateurs worldwide.

To qualify, all contacts must have been made on or after June 5, 1977. Contacts must be made with the following Italian prefixes: I1 through I0, IS0, IT9, one of the special ARI stations (IZ0ARI or I3ARI as examples), or one of the special memorial stations such as I14FGM or IY4FGM.

As with the RCCI Award, do not send QSL cards. GCR apply. Forward your application and an award fee of \$4.00 or 10 IRCs to: I8KUT, PO Box 2011, 80100 Napoli, Italy, Europe.

HAM HELP

I would like to obtain the service or instruction manual for a Wavetek VCG (generator), model 155. I will gladly pay a reasonable amount for a copy or the manual itself.

Arthur Hagopian W6LGQ
34 Laurel Ave.
Petaluma CA 94952

I need a copy of assembly instructions for a Hy-Gain tri-band beam, circa 1960. Commonly called the eggbeater because of the 23" loops on each end of the three elements, it has four open coils on each element and an 18' boom. I will pay for a copy.

Leslie Hogg WB8NVJ
28423 Kendallwood Dr.
Farmington Hills MI 48018

I am in need of operating manuals and schematics for the following test equipment: H-P model 520 high-speed decade scaler and model 500BR frequency meter and Sweep-Systems, Inc., model 950 oscilloscope. I will buy or reproduce and return and pay shipping costs. Thank you.

Stan Boler WD9BBV
116 S. Washington
Knightstown IN 46148

I need a manual for an AN/USM 106 video voltmeter made by Ballantine. I will pay postage and copying costs and prefer to copy here and return.

John Weber K4JW
102 Southgate Blvd.
Melbourne FL 32901

Congratulations to Vernon G. Dameron, Jr. K1DRN of Bedford MA. He was the winner of a lifetime subscription to 73 Magazine at the New England Division Convention, October 4 and 5, at Boxboro MA.

SOCIAL EVENTS

Listings in this column are provided free of charge on a space-available basis. The following information should be included in every announcement: sponsor, event, date, time, place, city, state, admission charge (if any), features, talk-in frequencies, and the name of whom to contact for further information. Announcements must be received two months prior to the month in which the event takes place. They should be sent directly to Editorial Offices, 73 Magazine, Pine Street, Peterborough NH 03458, Attn: Social Events.

SOUTH BEND IN JAN 4

A hamfest swap & shop will be held on Sunday, January 4, 1981, at New Century Center, across from St. Joseph Bank building, US 33 north, South Bend IN. Tables are \$3.00 each. There is a half acre of carpeted floor in the same building as the industrial history museum. Talk-in on 146.52/.52, .04/.64, .34/.94 and 147.99/.39, .93/.33, .78/.18, .69/.09.

OAK PARK MI JAN 11

The Oak Park ARC will hold its annual indoor Swap & Shop on January 11, 1981, at the Oak Park High School, Oak Park Boulevard (9½ miles west of Coolidge Highway), Oak Park MI. Doors will be open from 8:00 am to 3:00 pm and admission is \$2.00 per person. Features will include an ARRL table, a door prize, a YLRL table, food, refreshments, and free parking. Talk-in on 146.04/.64 and 146.52. For more information, send an SASE to Rob Numerick, 23737 Couzens, Hazel Park MI 48030, or call (313)-398-3189.

CHESTERFIELD VA JAN 11

The Richmond Amateur Telecommunications Society will hold Frostfest 1981 on Sunday, January 11, 1981, at the Chesterfield County Fairgrounds, Chesterfield VA, from 8:00 am to 4:00 pm. New and large facilities include spacious aisles, and plenty of on-site parking, with charter buses welcome. Admission is \$3.00 for each four-foot-

long flea market table, and \$2.00 for each tailgating vehicle. Features will include commercial exhibitors, a flea market, an auction, and prizes consisting of a color TV, a Bird Wattmeter with slug, a digital VOM, and many more. Talk-in on 146.34/.94 and 146.28/.88. For further information, contact the Richmond Amateur Telecommunications Society, PO Box 1070, Richmond VA 23208.

ARLINGTON HEIGHTS IL JAN 25

The Wheaton Community Radio Amateurs' hamfest will be held on January 25, 1981, at the Arlington Park Race Track EXOP Center, Arlington Heights IL. Doors open at 8:00 am. Tickets are \$2.00 in advance and \$3.00 at the door. There will be 300 free flea market tables available, plus 100 commercial booths and clear paved parking. Prizes will be awarded. Talk-in on 146.94 and 146.01/.61. For advance tickets, send an SASE to WCRA, PO Box QSL, Wheaton IL 60187. For information, call (312)-766-1684 or (312)-629-3296.

MIAMI FL FEB 7-8

The 21st annual Tropical Hamboree and 1981 ARRL Florida State Convention will be held on February 7-8, 1981, at the Flagler Dog Track, Miami FL. Registration is \$3.00 in advance and \$4.00 at the door. Swap tables are an additional \$12.00 for both days, \$7.00 for Saturday only, and \$6.00 for Sunday only. Events will include tech talks and forums, over 100 exhibit booths, 400 swap tables, ladies' programs, group meetings, and many awards. There will be free overnight RV parking for self-contained units at the site (advance registration is recommended). Special gatherings are planned for QCWA/OOTC/SOWP and DXers. For further information and special hotel rates, write Dade Radio Club, PO Box 350045 Riverside Station, Miami FL 33135.

MANSFIELD OH FEB 15

The Mansfield midwinter

hamfest auction will be held on February 15, 1981, at the Richland County Fairgrounds, Mansfield OH. Doors will open to the public at 8:00 am. Tickets are \$1.50 in advance and \$2.00 at the door. Features will include prizes, an auction, and a flea market, all in a large heated building. Talk-in on 146.34/.94. For additional information, advance tickets, and/or tables, send an SASE to Harry Frietchen K8HF, 120 Homewood Road, Mansfield OH 44906, or phone (419)-529-2801.

LIVONIA MI FEB 22

The Livonia Amateur Radio Club will hold its 11th annual LARC Swap 'n Shop on Sunday, February 22, 1981, from 8:00 am to 4:00 pm, at Churchill High School, Livonia MI. There will be plenty of tables available. Other features include door prizes, refreshments, and free parking. Talk-in on 146.52. For further information, send an SASBE (4" x 9") to Neil Coffin WA8GWL, c/o Livonia Amateur Radio Club, PO Box 2111, Livonia MI 48150.

DAVENPORT IA MAR 1

The Davenport Radio Amateur Club will hold its tenth annual hamfest on March 1, 1981, from 8:00 am to 4:00 pm at the Davenport Masonic Temple, Highway 61 (Brady Street) and 7th Street, Davenport IA. Tickets are \$2.00 in advance, \$3.00 at the door. Tables are \$4.00 each with a \$2.00 additional charge for an electrical hookup (limited number). Features will include over

\$2,000 worth of major prizes. Hotel discounts and refreshments will be available. There will be a pre-hamfest Saturday night banquet with Paul Graver, midwest ARRL SCM, as guest speaker. Banquet tickets are \$8.00 and reservations must be paid by February 18, 1981. Talk-in on 146.28/.88, W0BXR. For advance tickets, dinner, and table reservations, write Dave Johannsen WB0FBP, 2131 Myrtle, Davenport IA 52804.

STERLING IL MAR 8

The Sterling-Rock Falls Amateur Radio Society will hold its 21st annual hamfest on Sunday, March 8, 1981, at the Sterling High School field house, 1608 4th Avenue, Sterling IL. Advance tickets are \$2.00 and tickets at the door are \$2.50. A large indoor flea market will be restricted to radio and electronic items only. Tables are available for \$5.00 for commercial and \$3.00 for others. Plenty of free parking will be available, including an area to accommodate campers and mobile trailers. Many prizes will be given away, including a first prize of a mini-computer. Doors open at 7:30 am. Featured will be a movie "The World of Amateur Radio," to be shown throughout the day, bargains, good food, and plenty of close-by activities for XYLs and kids. Talk-in on .52 and WR9AER .25/.85. For advance tickets and tables, write Sue Peters KA9GNR, 511 8th Avenue, Sterling IL 61081. Make checks payable to Sterling-Rock Falls Amateur Radio Society and enclose an SASE.

CORRECTIONS

In "Single-Tone Paging for Wilson HTs," December, 1980, pp. 112-114, several errors managed to creep in, not the least of which was the author's old callsign. Fred's call is W4CK.

On page 112, zener D2 in Fig. 1 should be a 1N751A. This change should be reflected in the parts list on page 114, too. Also, on page 113, column 1, at the beginning of the bottom paragraph, the opening line should read "There is no disad-

vantage in..."

An improvement over the insulation technique described on page 114, column 2, lines 19 through 25, would be to use non-conducting styrofoam cut to the shape of the PCB.

Finally, at the bottom of the parts list, time and inflation have had their effect. Microsizer Co. (at the same address) now offers the kit for \$17.95 and the PCB alone for \$4.50.

Gene Smarte WB6TOV
News Editor

**this publication
is available in
microform**



University Microfilms International

300 North Zeeb Road
Dept. P.R.
Ann Arbor, MI 48106
U.S.A.

18 Bedford Row
Dept. P.R.
London, WC1R 4EJ
England

FREE CATALOG



NEW!
CATALOG OF
HARD-TO-FIND
PRECISION TOOLS

✓ 354

**Also contains test equipment
plus wide selection of
tool kits and cases**

Jensen's new catalog is jam-packed with more than 2000 quality items. Your single source for hard-to-find precision tools and tool kits used by electronic technicians, scientists, engineers, instrument mechanics, schools, laboratories and government agencies. Send for your free copy today!



JENSEN TOOLS INC.

1230 S. PRIEST DR. - TEMPE, AZ 85281

225-400 Mhz CONVERTER AM-914/TRC Amplifier-Converter



Originally used with military R-417 receiver for the 225-400 Mhz range. Continuous tuning of RF and oscillator; 30 Mhz I.F. Has tubes 5670 and 4/6J4. See 10/80 CQ - R. Grove's conversion of this unit. 7 1/2 x 6 1/2 x 9 1/2, 17 lbs. sh.

wt. Used, repairable **\$34.95**

AC LINE FREQUENCY METER

48-52 and 58-62 Hz 100-150 VAC using ten reeds. 3 1/2" round; sealed. H.H. Sticht mfg. 2 lbs. sh. wt. #974-9364, unused **\$27.95**

TMC MSR-4 (CV-591) SSB Converter

for use with 2-32 Mhz receivers having 455 KHz IF's. USB, LSB, AM, CW, FSK, and FAX. Input voltage 0.1 to 10 V-rms. Requires 115/230 VAC 50-60 Hz. 5 1/4 x 19 x 13 1/2, 28 lbs. sh. Used, repairable **\$145.00**

Prices F.O.B. Lima, O. • VISA, MASTERCARD Accepted.

Send for our New FREE SURPLUS CATALOG Today!
Address Dept. 73 • Phone: 419/227-6573

FAIR RADIO SALES ✓ 22

1016 E. EUREKA • Box 1105 • LIMA, OHIO • 45802

AMATEUR RADIO PROFILES

The most meaningful equipment review publication to hit the amateur ranks in years. No commercial advertisers, thus no obligation to the manufacturers. We tell it like it is, good and bad, in plain, easy-to-understand language by amateur enthusiasts who have used, tested, and compared. "Is the TR-7 that good?", "What \$500 transceiver is giving the \$1000 units a run for their money?", "Need a tri-bander?", study the "Battle of the amps". Get the true story before you buy or trade. Check the "dream system", best dollar value, good, better, best systems by performance versus cost. Know what to expect, both negatively and positively, from that gear you're planning to buy, before you buy!!—thus no surprises; you know what you're buying because you read A.R.P.

\$13.00 yearly—multi issues.

A.R.P. P.O. Box 164
Cataula, Georgia 31804

SATELLITE TV ANTENNA MANUAL



*Unique design...
Accurate...
No special tools
required...
...It works!!*

**Complete plans to build
an all-aluminum 12 foot
stressed-rib parabolic
reflector. Send \$30 or
for more information
send SASE to:**

s a electronics ✓ 394
P.O. Box 277
So. Milwaukee, WI
53172

7500 SALES OPPORTUNITIES FOR YOUR COMPANY

Be part of the ROCHESTER SHOW
MAY 15-16. Largest show in NORTH-
EAST and CANADA.

Call or write HAROLD SMITH

P.O. Box 1388
Rochester, NY 14603

716-424-1100

HAM HELP

I am in need of a Galaxy III schematic and owner's manual. I will pay for original or copy. Thank you.

Phillip R. Lofton WA4NVE
349 Quinn Rd.
Collierville TN 38017

I am in need of the manual(s) or two Gonset, Inc., FM 150-175-MHz radios. One is a model 960A, series (G40033), while the other lacks a model number but is stamped with the series (G40019). The two are

identical but for power supplies and number of channels.

I would, of course, be willing to pay for any costs involved in obtaining the paperwork for these radios.

Zak Hargraves, KA0EGW
550 East 30th Street
Durango CO 81301

I came across a few schematics the other day and started to destroy them and then I thought that someone

might want them.

I have schematics available for the following: HT-33-B linear amplifier, Globe DSB-100 Sidebander, Heathkit® V-2 VTVM, typical Command Set transmitter, with power-plug connections for "BC" series, modification of Heath HP-10 for use with Collins KWM series, and the popular Command Receiver.

These are free for the asking—an SASE would be appreciated, however.

Reid Martin W4BP
Rt. #3 Box 250
Tavares FL 32778

I need very badly a noise blanker for a Drake TR-4C. The unit Drake made for this rig was numbered 34-PNB. I would like

to buy an original unit or obtain photocopies of printed information pertaining to it (schematics, photos, etc.). I will pay a reasonable price for either or both, and, of course, all shipping costs.

If you have a 34-PNB that you are willing to sell, or have information (or know where I can get either), please drop me a note at the address given below. Please state condition of unit, nature of information, and a price (please exclude shipping costs from this figure). Your time and attention is greatly appreciated.

Keith Inman, President
Bucknell Amateur Radio Club
Box C-281
Bucknell University
Lewisburg PA 17837

FAST SCAN ATV

WHY GET ON FAST SCAN ATV?

- You can send broadcast quality video of home movies, video tapes, computer games, etc. at a cost that is less than slocan.
- Really improves public service communications for parades, RACES, CAP searches, weather watch, etc.
- DX is about the same as 2 meter simplex - 15 to 100 miles.

ALL IN ONE BOX



TC-1 Transmitter/Converter
Plug in camera, ant., mic, and TV and you are on the air. Contains AC supply, T/R sw, 4 Modules below \$ 399 ppd

PUT YOUR OWN SYSTEM TOGETHER



TXA5 ATV Exciter contains video modulator and xtal on 434 or 439.25 MHz. All modules wired and tested \$ 89 ppd

PA5 10 Watt Linear matches exciter for good color and sound. This and all modules run on 13.8 vdc. \$ 79 ppd

TVC-2 Downconverter tunes 420 to 450 MHz. Outputs TV ch 2 or 3. Contains low noise MRF901 preamp. \$ 55 ppd

PACKAGE SPECIAL all four modules \$ 239 ppd

FMA5 Audio Subcarrier adds standard TV sound to the picture \$ 29 ppd

SEND FOR OUR CATALOG, WE HAVE IT ALL

Modules for the builder, complete units for the operator, antennas, color cameras, repeaters, preamps, linears, video ider and clock, video monitors, computer interface, and more. 19 years in ATV.

Credit card orders call (213) 447-4565. Check, Money Order or Credit Card by mail.



P.C. ELECTRONICS ✓57
Maryann WB6YSS 2522 PAXSON ARCADIA, CA 91006 Tom W6ORG



CONTESTING?



THE NEW LOW COST AEA CONTEST KEYSER MODEL CK-1 WILL MAKE YOU MORE COMPETITIVE THAN EVER!

\$129.95

SUGGESTED AMATEUR NET

- Automatic Serial Number Generator From 01 to 9999.
- 500 Character Soft Partitioned™ Memory That Can Be Divided Into as Many as 10 Messages.
- Exclusive AEA Memory Editing Capability.
- Two Presettable Speeds With Fast Recall Plus Stepped Variable Speed Selection.
- Iambic Operation From 1 to 99 wpm and Complete Weighting Control.
- Extreme R.F. Immunity, Will Key Any Modern Transceiver, Operates from 12 ± 3 Volts D.C.

Mid Com Electronics, Inc., 8516 Manchester Road, St. Louis, MO 63144. Call 1-800-325-3609, 314-961-9990

AEA Brings you the Breakthrough!



FOX-TANGO CORP.

Box 15944S, West Palm Beach, FL 33406

Visa/MC welcomed. Money back if not satisfied.

8-POLE FILTER BANDWIDTHS IN STOCK

CRYSTAL FILTER	CW (Hz)						SSB-AM (kHz)				
	125	250	400	500	600	800	1.8	2.1	2.4	6.0	8.0
YAESU	\$55 EACH										
*FT-101/F/FR-101	✓	✓	✓	✓	✓	✓	✓	✓	✓	✓	✓
*FT-301/FT-7B/620	✓	✓	✓	✓	✓	✓	✓	✓	✓	✓	✓
*FT-901/101ZD/107	✓	✓	✓	✓	✓	✓	✓	✓	✓	✓	✓
FT-401/560/570	✓	✓	✓	✓	✓	✓	✓	✓	✓	✓	✓
FT-200/TEMPO I	✓	✓	✓	✓	✓	✓	✓	✓	✓	✓	✓
KENWOOD	\$55 EACH										
*TS-520/R-599	✓	✓	✓	✓	✓	✓	✓	✓	✓	✓	✓
*TS-820/R-820	✓	✓	✓	✓	✓	✓	✓	✓	✓	✓	✓
											• 2nd IF \$125 for R-820 only
HEATH	\$55 EACH										
ALL HF	✓	✓	✓	✓	✓	✓	✓	✓	✓	✓	✓
DRAKE	FOR PRICES SEE NOTES										
R-4C	GUF-1 Broad 1st IF Superior Shape Factor/Ult Rej \$65 ✓ ✓										
	GUF-2 Narrow 1st IF ✓ ✓ + pcb w sw relays \$90										
	56H125 ✓ - Plug in type - ✓ \$55										
	GUD Product Detector - w pcb w relay double balanced type \$30										
COLLINS:	SPECIAL \$125 EACH										
75S-3B/C	✓	EQUALS OR EXCELS \$400 COLLINS UNIT									

*DIODE SWITCHING BOARDS available to permit 1, 2 or more filters than those for which manufacturer provides room. SPECIFY make and model.

Single-filter type: \$12 Airmail postpaid

Dual-filter type: \$21 Airmail postpaid

Florida residents add 4% (sales tax) (FOREIGN ADD \$3 per filter)



BROCHURE ON REQUEST

Dealer Inquiries Welcomed ✓ 323

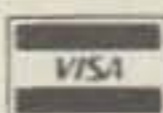

New Improved Adhesive Mount for the 2 Meter Avanti Mobile Antenna.

Mounts on glass — no holes!

- Receives and transmits through glass.
- Superior performance equivalent to 5/8 wave.
- Superior radiation full Omni-Directional.

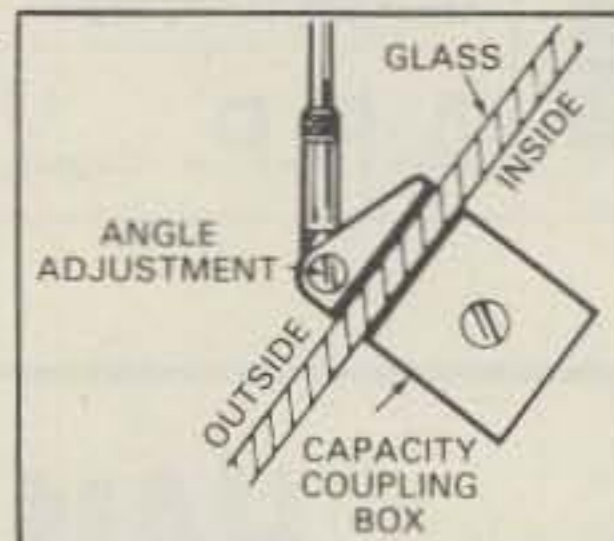

It's easy to install — No holes to drill, no magnet to scratch the paint, no clamps. Uses an especially developed silicone adhesive that secures antenna to window. The capacity coupling box is simply attached with a special adhesive tape to inside of window. Worried about crimping or corroding coaxial cables? It's all inside and out of sight.

Models also available for 220 MHz and 450 MHz.

See Avanti's other new mobile and base antennas. Write for new catalog today. Send 50¢ for handling and postage.

avanti® antennas

AVANTI COMMUNICATIONS
340 Stewart Ave., Addison, IL 60101 (312) 628-9350
In Canada: Cardon Comm., Hamilton, ONT (416) 527-1040

MAKE MONEY... SELL 73 MAGAZINE

Selling 73 Magazine, the ham radio magazine that offers quality and quantity, brings the ham into your store. Once through the door you can sell him anything.

Our dealers are telling us that "73" outsells them all... so call today and join the dealers who make money with 73 Magazine.

For information on selling 73 Magazine call 603-924-7296 and speak with Ginnie Boudrieau, our Bulk Sales Manager. Or write to her at:

73 MAGAZINE
80 PINE STREET
PETERBOROUGH NH 03458

CAN 20% BE WRONG?



A recent survey showed that 20% of the 73 subscribers also read Kilobaud MICROCOMPUTING magazine . . . and enjoy it. This is the best way to learn and keep up with the rapidly developing world of microcomputers. There's nothing to be afraid of, you just have to read an interesting magazine and you'll learn. Try a subscription to Kilobaud MICROCOMPUTING and see for yourself.

New subscription Renewal 12 issues for \$25.00
 Payment enclosed \$ _____ 24 issues for \$38.00
 VISA MC AE Bill me 36 issues for \$53.00

Card # _____ Interbank # _____
 Signature _____ Exp. date _____
 Name _____
 Address _____
 City _____ State _____ Zip _____

—for even faster ordering service call toll free (800) 258-5473
 Canadian: \$27, one year only, U.S. funds. Other foreign:
 \$35, one year only, U.S. funds. Please allow 6-8 weeks for delivery.

311B6

MICROCOMPUTING • POB 997 • Farmingdale NY 11737

TRS 80* OWNERS ARISE!



Arise and subscribe to 80 MICROCOMPUTING, the newest and fastest growing microcomputer magazine. This is full of news about programs, accessories and theory on the world's largest selling computer, the TRS-80*. Definitely beginner level and includes lots of program listings. Find out what all the fuss is about.

New subscription Renewal 12 issues for \$18
 Payment enclosed \$ _____ 24 issues for \$30
 VISA MC AE Bill me 36 issues for \$45

Card # _____
 Interbank # _____ Exp. date _____
 Signature _____
 Name _____
 Address _____
 City _____ State _____ Zip _____

Please allow 6 to 8 weeks for delivery
 Canadian: 1 yr. only/\$20 in U.S. Funds
 Foreign: 1 yr. only/\$28 in U.S. Funds

80 microcomputing
 • P.O.B. 981 • Farmingdale N.Y. 11737
 *TRS-80 is a trademark of Tandy Corporation.

311B6

MICROWAVE

DOWN CONVERTER POWER SUPPLY KIT \$39.95
 All Parts included,
 Quality Case, 250 ma
 regulated, very detailed
 instructions, two models-
 works with all down converters
 TU-8 8-12 VDC
 TU-12 12-16 VDC

Introduction to 2 GHz Study Course, includes a quality down converter kit, detailed step-by-step instructions. Requires 8-12V
 FREE BONUS: Microwave Antenna Cookbook

MICROWAVE ANTENNA COOKBOOK \$10.00

Information on SMP products \$ASE
 \$2.00 handling charge,
 Maryland residents add sales tax
 VISA and Master Charge accepted.

SMP ✓376

Post Office Box 2050
 Gaithersburg, Maryland 20760
 (301) 258-5150

UNIVERSAL CONVERTER ASCII - BAUDOT - MORSE ABM-200

+5v

MORSE

ASCII

BAUDOT



The ABM-200 is a universal code converter for translating between ASCII and Baudot, or between Morse and ASCII (or Baudot). Also used as TTY® speed and line length converter. Inserts directly between TU and TTY®. RS232 & current plus 40 char FIFO buffer. Write for details\$189.



OEM Inquiries Invited.

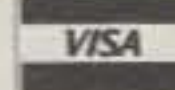

XITEX Corporation ✓82
 9861 Chartwell Dr.
 Dallas, Texas 75243
 214-349-2490

C.O.D.

Check

2300 MHZ Antenna



This antenna is for your 2300 MHZ down converter. Design gain of up to 20DB. Some assembly required. Variable voltage, 150MA power supply for down converters, 8V-15V.

	PRICE	SHIP. & HNDL.
2300 MHZ antenna only	45.00	5.00
Power supply kit	35.00	2.00
Power supply PC board only	5.00	PPD
2300 MHZ conv. board only	20.00	1.00

Complete system: 2300 MHZ converter, antenna, power supply, 18" coax, 50' coax. Ready to hook up and turn on. \$200.00 PLUS \$5.00 U.P.S.

No C.O.D. Cash only in money order or cashier check

H.M. GOODWIN W5EEY
 11421 FERNALD AVE.
 DALLAS, TX 75218 ✓393

2m AMPLIFIER

SALE
 THRU MARCH

\$54.95
 (p. pd USA)



35w 2m FM AMPLIFIER KIT ● MODEL 335-K ● 3 IN - 35 OUT ● 2 IN - 30 OUT
 ● 1 IN - 15 OUT ● COR ● CLASS C
 ● 4.5 A AT 13.6VDC ● BNC CONNECTORS ASK ABOUT OUR OTHER VHF & UHF MODELS

COMMUNICATION CONCEPTS INC.

2648 NORTH ARAGON AVE.
 DAYTON, OHIO 45420

(513) 296-1411 ✓382

NOISE AND FLASHES CAN'T STOP THEFT!!!

BUT *AutoPage* CAN
 UNIT PAGES YOU



129⁹⁵
 POST PAID



YOU CALL POLICE

CAR - HOME - OFFICE

CHECK OR MONEY ORDER
 CAL. RES. ADD 6 PERCENT TAX
 ADD 2.50 FOR C.O.D. ✓374

SK ELECTRONICS

10672 WOODBURY ROAD
 GARDEN GROVE, CA 92643

Enjoy Satellite TV Now



Better than Cable TV—Over 200 TV and radio services. Why waste money? Learn the whole story and build a video system the family can enjoy. No commercials, FREE movies, sports and Vegas shows—worldwide, crystal clear reception connects to any TV set. Big (8×11 in. book loaded with details, photos, plans, kits—TELLS EVERYTHING! Satisfaction Guaranteed. Send \$7.95 TODAY! Add \$2.00 for 1st class (air mail) or call our 24 hour C.O.D. rush order line (305) 862-5068. GLOBAL ELECTRONICS, P.O. Box 219-H, Maitland, Florida 32751

Kreco CO-AXIAL ANTENNA

All Aluminum

LIGHT · STRONG · EFFICIENT

SPECIAL SALE

Model CO-2A
 2 Meters

\$19.95 Delivered

Herb Kreckman Co.
 Cresco, PA. 18326 ✓375

Scanners

BEARCAT

REGENCY

210XL	\$229	R804	\$ 89
300	360	R106	105
220	290	M100	209
250	290	M400	279
T/S 4-6	129	N.J. RESIDENTS	
160	199	ADD 5% SALES TAX	

NO COD'S, CHECKS, MONEY ORDERS VISA OR MASTERCARD ARE ACCEPTABLE. ADD \$3.50 EACH ITEM FOR SHIPPING AND HANDLING.

PAUL DAVIS ELECTRONICS
 PEDDLERS VILLAGE
 MANASQUAN, NJ 08736

TEL: 201-223-9298 WEEKENDS
 201-493-4511 EVE'S

ELECTRONIC TECHNICIAN

If you'd like to switch from soldering iron to typewriter and have a good command of the English Language, tell us all about yourself, including past education and experience.

Location, Western Mass., with nationally-known manufacturer. Position involves preparation of data sheets, engineering bulletins, technical manuals, etc.

73 Magazine
 Box 186
 Peterborough, NH 03458

We Are An
 Equal Opportunity Employer
 m/f

**2300 MHZ
DOWN CONVERTER**

MERRY CHRISTMAS

FROM
UNIVERSAL COMMUNICATIONS

DEBORAH and STEVE (wb5KUL)

KNOWN AS THE STOP SIGN BOARD.
THIS 2300 mhz DOWNCONVERTER KIT
WORKS. THE IMPROVED BOARD EVEN
MAKES IT BETTER THAN BEFORE.
SO WHY PAY TWICE AS MUCH?

Kit supplied with a 6 page
brochure, PC board, Diodes,
Chip Caps, Transistors, and
all parts to complete a
working board. \$38⁵⁰

POWER
SUPPLIES avail

Money Order or Check
mail or phone

UNIVERSAL COMMUNICATIONS

P.O. BOX 6302, ARLINGTON, TEX. 76011
817-265-0391

CB TO 10 METER

**10 METER CONVERSION KITS
FOR CB RADIOS AM-FM & SSB**

- Kits for over 300 Models of CB Radios
- Low Cost from \$10.00
Easy to Install with All Instructions
Tune-Up Procedure Alignment
- KITS FOR MOST POPULAR UNITS
Over 5,000 Satisfied Customers
- Write or Call Today for Our Free
1980 Catalogue

AMERICAN CRYSTAL SUPPLY COMPANY

PO Box 638
W Yarmouth, MA 02673
(617) 771-4634 ✓7

Radio Amateurs!

Tempo Handheld!

S-1	\$232.80	2 Meter	
S-1T	\$260.90	With Tone Pad	
S-2	\$315.00	220 MHz	
S-2T	\$350.00	With Tone Pad	
S-5	\$264.50	2 Meter 5 Watt	
S-5T	\$299.95	With Tone Pad	
AZDEN PCS-2000	2 Meter	\$259.95	
Azden PCS-2800	10 meter	\$259.95	
AZDEN PCS-2800	10 Meter	\$259.95	
SWAN ASTRO 102BX			
160:10 Meters		\$978.46	
Astro 150		\$760.32	
100 MX		\$574.00	
TEN-TEC OMNI C	new	\$933.90	
TEN-TEC OMNI D		\$795.00	
Ten-Tec Hercules 444		\$1299.95	

Six others lower priced Limited Quantities.

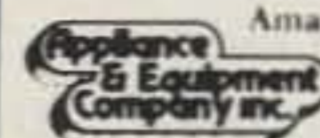

Amateur equipment accessories & antennas.
COD'S USA. Export Anywhere.
Amateur & commercial repair service.

2317 Vance Jackson Rd. San Antonio, TX 78213

800-531-5405

(512) 734-7793 (TX)

MICROWAVE ANTENNAS & KITS

- MICROWAVE TRANSISTORS
- AZ-EL OPTION KITS
- MICROWAVE DIODES
- PARABOLIC REFLECTORS
- ALUMINUM FEED-HORNS



Your source of supplies for the fastest growing field
of communications. Here is a low cost entry into the
fascinating area of microwave technology. We offer a
complete line of antennas, receivers, pre-amps,
power supplies, etc..... Call or write for details.

DATA SERVICE COMPANY ✓346
3110 Evelyn Street
Roseville, MN 55113
612-636-9469

**SLOTTED ARRAY
ANTENNA** ✓378



- 2100 +/- 100 MHz
- 16 dBi gain
- 14 x 98 degree beamwidth
- H or V polarization
- Type N connector
- Low wind loading
- Alodined
- 24" x 5" x 1"
- Mast mount
- Superior to 20" dish
- Commercial grade
- Mast mount

Postpaid.....\$35

Optional small corner reflector narrows
beam width to 14 x 14 degrees; in-
creases gain 4 dBi. FREE PLAN.

HVB 1508 Ports O'Call
Plano, Texas 75075

**UPGRADE
SUCCESSFULLY!**

—PASS THE FCC EXAM—

ANNOUNCING

the New 1981

LICENSE THEORY REVIEWS

FOR THE

TRS-80 16K Computer

- 12 Programs Per License Class
- Each Comprehensive Package
Totals 98,000 Bytes.
- General, Advanced or Extra.

\$19.95 or \$39.95
each ✓383

µ80™

MICRO-80™ INC.
S-2665 No. Busby Road
Oak Harbor, WA 98277

Satellite TV

FOR THE HOME

Sick of Network TV?

Our receiver lets you get
over 75 channels of televi-
sion directly from earth-
orbiting cable TV satellites!
HBO, Showtime, super sta-
tions, sports and movies
from around the world.



**We don't just sell information!
We Manufacture Hardware!**

Our 94-page catalog and information book tell
the whole story! Inexpensive dishes, high pro-
feeds, computer aiming software! Specs, kits
and more! Send \$7.95 today!

24-hour C.O.D Hotline
(305) 339-7600



SPACECOAST RESEARCH ✓309
Dept. S, P.O. Box 442, Altamonte Springs, FL 32701

**SYNTHESIZED
SIGNAL GENERATOR**



- Covers 100 to 179.999 MHz in 1 kHz steps with
thumb-wheel dial
- Accuracy .00001% at all fre-
quencies
- Internal frequency modulation from 0 to
over 100 kHz at a 1 kHz rate
- Spurs and noise at
least 60dB below carrier
- RF output adjustable from
50 to 500mv across 50 ohms
- Operates on 12vdc
@ 1/2 amp
- Price \$299.95 plus shipping.

In stock for immediate shipping. Overnight
delivery available at extra cost. Phone: (212)
468-2720. ✓311

VANGUARD LABS
196-23 Jamacia Ave. Hollis, NY 11423

PILOTS



Build your own aircraft
transceiver. For details send
for FREE CATALOG.

(916)
272-2203

**Radio Systems
Technology, Inc.** ✓381
10985-T GRASS VALLEY AVE.
GRASS VALLEY, CA 95945

NEW RADAR DETECTOR BOARDS

- #1 - Includes 3 - 741 op amps, 1NE555 Timer, and 1 - LM311 **\$ 2/1.00**
- #2 - Includes 1 - NE567 PLL, 1NE555 Timer, 1 - 5634 Low Noise op amp for high quality audio, 2 - 741 op amps, and 1 - 78M08 voltage Regulator: 8V. 500MA. **\$.75 Each or 3/2.00**

Each of these boards contain many other parts too numerous to list.

74177 BINARY COUNTER/LATCH

Divide by 2, 4, 8, 16
Pre-settable Input **\$.60**

2111 By Sprague FM Detector and Limiter

Full Data **\$1.25**

MICROWAVE DIODE

For Down Converters
5082 - 2835 **\$1.50 or 5 For \$6.00**

DC HORN #2

Very Small Size — LOUD

2½ to 12 Volts DC Draws 5 ma. at 2.5 Volts
12.5 ma. at 5 Volts — 20 ma. at 7.5 Volts
35 ma. at 10 Volts — 40 ma. at 12 Volts
1¼ inch x ⅝ inch Base — ¾ inch High

LIMITED QUANTITY

\$.50 Each or 5 For \$2.00

MICRO MINI TOGGLE SWITCHES

6 for \$5 with hardware



99¢ EACH

LAB-BENCH VARIABLE POWER SUPPLY KIT \$12.00 KIT SUPER SALE
5 to 20 VDC at 1 AMP. Short circuit protected by current limit. Uses IC regulator and 10 AMP Power Darlington. Very good regulation and low ripple. Kit includes PC Board, all parts, large heatsink and shielded transformer. 50 MV. TYP. Regulation.

RCA SENSITIVE GATE TRIAC

TO-5 CASE. HOUSE #40531
ALSO SAME AS T2300D.
2.5 AMPS 400 PIV

5/\$1.19

Perfect for Dimmers, Color Organs, etc. PC LEADS



\$4.95

60 Hz CRYSTAL TIME BASE (Complete Kit)
Uses MM5369 CMOS divider IC with high accuracy 3.579545 MHZ Crystal. Use with all MOS Clock Chips or Modules. Draws only 1.5 MA. All parts, data and PC Board included. 100 Hz, same as above, except \$5.95.

D.C. HORN VERY LOUD!

6-12 VDC
Like Used In Smoke Alarms.
FANTASTIC SAVINGS.
Compare this true value.
.60 ea. 4 For \$2.00

SG3501A VOLTAGE REGULATOR

By Silicon General

14 Pin Dip, ± 15v Regulator - Great for OP Amp Supplies - Output Adjustable For ± 10v to ± 23v Thermal Shutdown Protected.

*** \$.75 Each or 3/\$2.00 ***

PMD-11K-60 (Darlington)
60 Volts. HFE 800-20K
12 Amps. PNP TO-3
150 Watts. By Lambda.
\$1.50

BRAND NEW!

Crystal Super Savings
4.433618 MHZ
2/\$1.10

TIP 29C Power Transistor TO - 220 Case

1 Amp 30 Watts 100 Volt NPN
LIMITED QUANTITY 3/\$1.25

SUPER CUSTOM IC #17564-4

Has a C-MOS oscillator, Decade Counter Decoder/Driver. At the push of a button will flash a LED 24 times. At the end of which it will display the number of times it has gone through the cycle, up to 99. Variable speed pulses - Perfect for timing. **FULL DATA — \$1.00**

Push Button Switch - Normally Closed 6/\$1.25

7806 VOLTAGE REGULATOR

6 Volt 1 Amp **\$1.20**



10 Ohm Button Trim Pot

4/\$1.00

SWITCH

Same type as used on some computer boards. **\$.69 Each DPST or can be arranged SPDT.**

5 For \$2.50



OPCOA CLOCK #R1200 AC

12 Hour Format. 12 Volt Operation. .3 Inch Display. Has Radio (Alarm) Output. Complete with On-Board Switches and 4 Pin connection for easy hook up. With Data.

Add 60Hz Time Base for DC Operation.

SUPER SPECIAL 2/8.00 or \$4.28 each

Plug in transformer and all parts to make clock operational \$2.20.

M3-6501

256 By 4 CMOS Ram. By Harris. Super Low Current Drain! Data retention Voltage 2 Volts. Great for battery power or back-up.

\$1.99 each

5 VOLT REED RELAY

An absolutely fantastic item. Compare this price with any advertiser. **While They Last!** Normally Open. SPST. Turns on at 10 MA. Drops out at 5 MA.

SUPER SPECIAL! 2/1.20 or 10/4.00

Digital Research: Parts

(OF TEXAS)

P.O. BOX 401247 • GARLAND, TEXAS 75040 • (214) 271-2461

TERMS: Add 50¢ postage, we pay balance. Orders under \$15 add 75¢ handling. No C.O.D. We accept Visa, MasterCard and American Express cards. Tex. Res. add 5% Tax. Foreign orders (except Canada) add 20% P&H. 90 Day Money Back Guarantee on all items.

SEND FOR CATALOG WITH SUPER SAVINGS!!

MHz electronics

Toll Free Number
800-528-0180
(For orders only)

1900 MHz to 2500 MHz DOWN CONVERTER

This receiver is tunable a range of 1900 to 2500 mc and is intended for amateur radio use. The local oscillator is voltage controlled (i.e.) making the i-f range approximately 54 to 88 mc (Channels 2 to 7).

PC BOARD WITH DATA	\$19.99
PC BOARD WITH CHIP CAPACITORS 13	\$44.99
PC BOARD WITH ALL PARTS FOR ASSEMBLY	\$69.99
PC BOARD WITH ALL PARTS FOR ASSEMBLY PLUS 2N6603	\$89.00
PC BOARD ASSEMBLED AND TESTED	\$99.99
PC BOARD WITH ALL PARTS FOR ASSEMBLY, POWER SUPPLY AND ANTENNA	\$159.99
POWER SUPPLY ASSEMBLED AND TESTED	\$49.99
YAGI ANTENNA 4' LONG APPROX. 20 TO 23 dB GAIN	\$49.99
YAGI ANTENNA 4' WITH TYPE (N, BNC, SMA Connector)	\$64.99
2 FOOT DISH WITH FEED AND MOUNT	\$59.99
2300 MHz DOWN CONVERTER	
Includes converter mounted in antenna, power supply, Plus 90 DAY WARRANTY	\$259.99
OPTION #1 MRF902 in front end. (7 dB noise figure)	\$299.99
OPTION #2 2N6603 in front end. (5 dB noise figure)	\$359.99
2300 MHz DOWN CONVERTER ONLY	
10 dB Noise Figure 23 dB gain in box with N conn. Input F conn. Output	\$149.99
7 dB Noise Figure 23 dB gain in box with N conn. Input F conn. Output	\$169.99
5 dB Noise Figure 23 dB gain in box with SMA conn. Input F conn. Output	\$189.99
DATA IS INCLUDED WITH KITS OR MAY BE PURCHASED SEPARATELY	\$15.00

Shipping and Handling Cost:

Receiver Kits and \$1.50, Power Supply add \$2.00, Antenna add \$5.00, Option 1/2 add \$3.00, For complete system add \$7.50.

HOWARD/COLEMAN TVRO CIRCUIT BOARDS

DUAL CONVERSION BOARD	\$25.00
This board provides conversion from the 3.7-4.2 band first to 900 MHz where gain and bandpass filtering are provided and, second, to 70 MHz. The board contains both local oscillators, one fixed and the other variable, and the second mixer. Construction is greatly simplified by the use of Hybrid IC amplifiers for the gain stages. Bare boards cost \$25 and it is estimated that parts for construction will cost \$270. (Note: The two Avantek VTO's account for \$225 of this cost.)	
47 pF CHIP CAPACITORS	\$6.00
For use with dual conversion board. Consists of 6-47 pF	
70 MHz IF BOARD	\$25.00
This circuit provides about 43 dB gain with 50 ohm input and output impedance. It is designed to drive the HOWARD/COLEMAN TVRO Demodulator. The on-board band pass filter can be tuned for bandwidths between 20 and 35 MHz with a passband ripple of less than 1/2 dB. Hybrid ICs are used for the gain stages. Bare boards cost \$25. It is estimated that parts for construction will cost less than \$40	
.01 pF CHIP CAPACITORS	\$7.00
For use with 70 MHz IF Board. Consists of 7-.01 pF	
DEMODULATOR BOARD	\$40.00
This circuit takes the 70 MHz center frequency satellite TV signals in the 10 to 200 millivolt range, detects them using a phase locked loop, deemphasizes and filters the result and amplifies the result to produce standard NTSC video. Other outputs include the audio subcarrier, a DC voltage proportional to the strength of the 70 MHz signal, and AFC voltage centered at about 2 volts DC. The bare board cost \$40 and total parts cost less than \$30.	
SINGLE AUDIO	\$15.00
This circuit recovers the audio signals from the 6.8 MHz frequency. The Miller 9051 coils are tuned to pass the 6.8 MHz subcarrier and the Miller 9052 coil tunes for recovery of the audio.	
DUAL AUDIO	\$25.00
Duplicate of the single audio but also covers the 6.2 range	
DC CONTROL	\$15.00
This circuit controls the VTO's, AFC and the S Meter.	

TERMS:

WE REGRET WE NO LONGER ACCEPT BANK CARDS.

PLEASE SEND POSTAL MONEY ORDER, CERTIFIED CHECK, CASHIER'S CHECK OR MONEY ORDER.
PRICES SUBJECT TO CHANGE WITHOUT NOTICE. WE CHARGE 15% FOR RESTOCKING ON ANY ORDER.

ALL CHECKS AND MONEY ORDERS IN US FUNDS ONLY.

ALL ORDERS SENT FIRST CLASS OR UPS.

ALL PARTS PRIME AND GUARANTEED.

WE WILL ACCEPT COD ORDERS FOR \$25.00 OR OVER. ADD \$2.50 FOR COD CHARGE.

PLEASE INCLUDE \$2.50 MINIMUM FOR SHIPPING OR CALL FOR CHARGES.

WE ALSO ARE LOOKING FOR NEW AND USED TUBES,
TEST EQUIPMENT, COMPONENTS ETC.

WE ALSO SWAP OR TRADE

FOR CATALOG SEE JANUARY, 1980, 73 Magazine, 10 Pages.

(602) 242-8916

2111 W. Camelback
Phoenix, Arizona 85015

FAIRCHILD VHF AND UHF PRESCALER CHIPS

95H90DC	350 MHz Prescaler Divide by 10/11	\$9.50
95H91DC	350 MHz Prescaler Divide by 5/6	9.50
11C90DC	650 MHz Prescaler Divide by 10/11	16.50
11C91DC	650 MHz Prescaler Divide by 5/6	16.50
11C83DC	1 GHz Divide by 248/256 Prescaler	29.90
11C70DC	600 MHz Flip/Flop with reset	12.30
11C58DC	ECL VCM	4.53
11C44DC/MC4044	Phase Frequency Detector	3.82
11C24DC/MC4024	Dual TTL VCM	3.82
11C06DC	UHF Prescaler 750 MHz D Type Flip/Flop	12.30
11C05DC	1 GHz Counter Divide by 4	50.00
11C01FC	High Speed Dual 5-4 input NO/NOR Gate	15.40

TRW BROADBAND AMPLIFIER MODEL CA615B

Frequency response 40 MHz to 300 MHz
Gain: 300 MHz 16 dB Min., 17.5 dB Max.
50 MHz 0 to -1 dB from 300 MHz
Voltage: 24 volts dc at 220 ma max. **\$19.99**

CARBIDE — CIRCUIT BOARD DRILL BITS FOR PC BOARDS

Size: 35, 42, 47, 49, 51, 52	\$2.15
Size: 53, 54, 55, 56, 57, 58, 59, 61, 63, 64, 65	1.85
Size: 66	1.90
Size: 1.25 mm, 1.45 mm	2.00
Size: 3.20 mm	3.58

CRYSTAL FILTERS: TYCO 001-19880 same as 2194F

10.7 MHz Narrow Band Crystal Filter
3 dB bandwidth 15 kHz min. 20 dB bandwidth 60 kHz min. 40 dB bandwidth 150 kHz min.
Ultimate 50 dB: Insertion loss 1.0 dB max. Ripple 1.0 dB max. Ct. 0 +/- 5 pf 3600 ohms. **\$5.95**

MURATA CERAMIC FILTERS

Models: SFD-455D 455 kHz	\$3.00
SFB-455D 455 kHz	2.00
CFM-455E 455 kHz	7.95
SFE-10.7 10.7 MHz	5.95

TEST EQUIPMENT — HEWLETT PACKARD — TEKTRONIX — ETC.

Hewlett Packard:

491C TWT Amplifier 2 to 4 Gc 1 watt 30 dB gain	\$1150.00
608C 10 mc to 480 mc .1 uV to .5V into 50 ohms Signal Generator	500.00
608D 10 to 420 mc .1 uV to .5V into 50 ohms Signal Generator	500.00
612A 450 to 1230 mc .1 uV to .5V into 50 ohms Signal Generator	750.00
614A 900 to 2100 mc. Signal Generator	500.00
616A 1.8 to 4.2 Gc Signal Generator	400.00
616B 1.8 to 4.2 Gc Signal Generator	500.00
618A 3.8 to 7.2 Gc Signal Generator	400.00
618B 3.8 to 7.2 Gc Signal Generator	500.00
620A 7 to 11 Gc Signal Generator	500.00
623B Microwave Test Set	900.00
626A 10 Gc to 15 Gc Signal Generator	2500.00
695A 12.4 to 18 Gc Sweep Generator	900.00

Alltech:

473 225 to 400 mc AM/FM Signal Generator	750.00
--	--------

Singer:

MF5/VR-4 Universal Spectrum Analyzer with 1 kHz to 27.5 mc Plug In	1200.00
--	---------

Keltek:

XR630-100 TWT Amplifier 8 to 12.4 Gc 100 watts 40 dB gain	9200.00
---	---------

Polarad:

2038/2436/1102A Calibrated Display with an SSB Analysis Module and a 10 to 40 mc Single Tone Synthesizer	1500.00
---	---------

RF TRANSISTORS

TYPE	PRICE	TYPE	PRICE	TYPE	PRICE
2N1561	\$15.00	2N5590	\$8.15	MM1550	\$10.00
2N1562	15.00	2N5591	11.85	MM1552	50.00
2N1692	15.00	2N5637	22.15	MM1553	56.50
2N1693	15.00	2N5641	6.00	MM1601	5.50
2N2632	45.00	2N5642	10.05	MM1602/2N5842	7.50
2N2857JAN	2.52	2N5643	15.82	MM1607	8.65
2N2876	12.35	2N5645	12.38	MM1661	15.00
2N2880	25.00	2N5764	27.00	MM1669	17.50
2N2927	7.00	2N5842	8.78	MM1943	3.00
2N2947	18.35	2N5849	21.29	MM2605	3.00
2N2948	15.50	2N5862	51.91	MM2608	5.00
2N2949	3.90	2N5913	3.25	MM8006	2.23
2N2950	5.00	2N5922	10.00	MMCM918	20.00
2N3287	4.30	2N5942	46.00	MMT72	1.17
2N3294	1.15	2N5944	8.92	MMT74	1.17
2N3301	1.04	2N5945	12.38	MMT2857	2.63
2N3302	1.05	2N5946	14.69	MRF245	33.30
2N3304	1.48	2N6080	7.74	MRF247	33.30
2N3307	12.60	2N6081	10.05	MRF304	43.45
2N3309	3.90	2N6082	11.30	MRF420	20.00
2N3375	9.32	2N6083	13.23	MRF450	11.85
2N3553	1.57	2N6084	14.66	MRF450A	11.85
2N3755	7.20	2N6094	7.15	MRF454	21.83
2N3818	6.00	2N6095	11.77	MRF458	20.68
2N3866	1.09	2N6096	20.77		
2N3866JAN	2.80	2N6097	29.54		
2N3866JANTX	4.49	2N6136	20.15	MRF502	1.08
2N3924	3.34	2N6166	38.60	MRF504	6.95
2N3927	12.10			MRF509	4.90
2N3950	26.86			MRF511	8.15
2N4072	1.80	2N6439	45.77	MRF901	3.00
2N4135	2.00	2N6459/PT9795	18.00	MRF5177	21.62
2N4261	14.60	2N6603	12.00	MRF8004	1.60
2N4427	1.20	2N6604	12.00	PT4186B	3.00
2N4957	3.62	A50-12	25.00	PT4571A	1.50
2N4958	2.92	BFR90	5.00	PT4612	5.00
2N4959	2.23	BLY568C	25.00	PT4628	5.00
2N4976	19.00	BLY568CF	25.00	PT4640	5.00
2N5090	12.31	CD3495	15.00	PT8659	10.72
2N5108	4.03	HEP76/S3014	4.95	PT9784	24.30
2N5109	1.66	HEPS3002	11.30	PT9790	41.70
2N5160	3.49	HEPS3003	29.88	SD1043	5.00
2N5179	1.05	HEPS3005	9.95	SD1116	3.00
2N5184	2.00	HEPS3006	19.90	SD1118	5.00
2N5216	47.50	HEPS3007	24.95	SD1119	3.00
2N5583	4.55	HEPS3010	11.34		
2N5589	6.82	HEPS5026	2.56		
		HP35831E/		TRWMRA2023-1.5	42.50
		HXTR5104	50.00	40281	10.90
		MM1500	32.20	40282	11.90
				40290	2.48

CHIP CAPACITORS

1pf	27pf	220pf	1200pf
1.5pf	33pf	240pf	1500pf
2.2pf	39pf	270pf	1800pf
2.7pf	47pf	300pf	2200pf
3.3pf	56pf	330pf	2700pf
3.9pf	68pf	360pf	3300pf
4.7pf	82pf	390pf	3900pf
5.6pf	100pf	430pf	4700pf
6.8pf	110pf	470pf	5600pf
8.2pf	120pf	510pf	6800pf
10pf	130pf	560pf	8200pf
12pf	150pf	620pf	.010mf
15pf	160pf	680pf	.012mf
18pf	180pf	820pf	.015mf
22pf	200pf	1000pf	.018mf

We can supply any value chip capacitors you may need.

PRICES

1 to 10	1.49
11 - 50	1.29
51 - 100	.89
101 - 1,000	.69
1,001 up	.49

HAMLIN SOLID STATE RELAYS:

120vac at 40 Amps. Input Voltage 3 to 32vdc. 240 vac at 40 Amps. Input Voltage 3 to 32 vdc.	YOUR CHOICE \$4.99
--	---------------------------

ATLAS CRYSTAL FILTERS FOR ATLAS HAM GEAR

5.52-2.7/8 5.595-2.7/8/U 5.595-500/4/CW 5.595-2.7LSB 5.595-2.7USB 5.645-2.7/8 9.0USB/CW	YOUR CHOICE \$24.95
---	----------------------------

MRF454

\$21.83

NPN SILICON RF POWER TRANSISTORS

... designed for power amplifier applications in industrial, commercial and amateur radio equipment to 30 MHz.

- Specified 12.5 Volt, 30 MHz Characteristics —
Output Power = 80 Watts
Minimum Gain = 12 dB
Efficiency = 50%

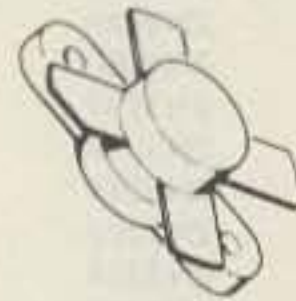

MRF458

\$20.68

NPN SILICON RF POWER TRANSISTOR

... designed for power amplifier applications in industrial, commercial and amateur radio equipment to 30 MHz.

- Specified 12.5 Volt, 30 MHz Characteristics —
Output Power = 80 Watts
Minimum Gain = 12 dB
Efficiency = 50%
- Capable of Withstanding 30:1 Load VSWR @ Rated P_{OUT} and V_{CC}

NPN SILICON RF POWER TRANSISTOR

... designed primarily for use in large-signal output amplifier stages. Intended for use in Citizen-Band communications equipment operating at 27 MHz. High breakdown voltages allow a high percentage of up-modulation in AM circuits.

MRF472

\$2.50

- Specified 12.5 V, 27 MHz Characteristics —
Power Output = 4.0 Watts
Power Gain = 10 dB Minimum
Efficiency = 65% Typical



MRF475

NPN SILICON RF POWER TRANSISTOR

... designed primarily for use in single sideband linear amplifier output applications in citizens band and other communications equipment operating to 30 MHz.

- Characterized for Single Sideband and Large-Signal Amplifier Applications Utilizing Low-Level Modulation.
- Specified 13.6 V, 30 MHz Characteristics —
Output Power = 12 W (PEP)
Minimum Efficiency = 40% (SSB)
Output Power = 4.0 W (CW)
Minimum Efficiency = 50% (CW)
Minimum Power Gain = 10 dB (PEP & CW)
- Common Collector Characterization



\$5.00

MHW710 - 2

\$46.45

440 to 470MC

UHF POWER AMPLIFIER MODULE

... designed for 12.5 volt UHF power amplifier applications in industrial and commercial FM equipment operating from 400 to 512 MHz.

- Specified 12.5 Volt, UHF Characteristics —
Output Power = 13 Watts
Minimum Gain = 19.4 dB
Harmonics = 40 dB
- 50 Ω Input/Output Impedance
- Guaranteed Stability and Ruggedness
- Gain Control Pin for Manual or Automatic Output Level Control
- Thin Film Hybrid Construction Gives Consistent Performance and Reliability



Tektronix Test Equipment

B	Wideband High Gain Plug In	\$ 51.00
CA	Dual Trace Plug In	120.00
K	Fast Rise DC Plug In	61.00
N	Sampling Plug In	200.00
R	Transistor Risettime Plug In	116.00
W	High Gain Differential Comparator Plug In	283.00
TU-2	Test Load Plug In for 530/540/550 Main Frames	50.00
1A2	Wideband Dual Trace Plug In	216.00
151	Sampling Unit with 350PS Risettime DC to 10KHz	730.00
2A61	AC Differential Plug In	133.00
353	Dual Trace Sampling DC to 10KHz Plug In	250.00
3576	Dual Trace Sampling DC to 875MHz Plug In	250.00
3T77A	Sampling Sweep Plug In	250.00
3L10	Spectrum Analyzer 1 to 30MHz Plug In	1000.00
50	Amplifier Plug In	50.00
51	Sweep Plug In	50.00
530	Wideband High Gain Plug In	25.00
53/540	Wideband High Gain Plug In	45.00
53/54C	Dual Trace Plug In	112.50
53/54D	High Gain DC Differential Plug In	38.00
53/54G	Wideband DC Differential Plug In	68.00
53/54L	Fast Rise High Gain Plug In	68.00
84	Test Plug In For 580/581 Main Frames	75.00
107	Square Wave Generator .4 to 1MHz	48.00
RM122	Preamplifier 2Hz to 40KHz	63.00
123	AC Coupled Preamplifier	25.00
131	Current Probe Amplifier	50.00
184	Time-Mark Generator	363.00
R240	Program Control Unit	150.00
280	Trigger Countdown Unit	84.00
455	Portable Dual Trace 50MHz Scope	2000.00
465	Portable Dual Trace 100MHz Scope	2500.00
503	DC to 450KHz Scope Rack Mount	250.00
535A	DC to 15MHz Scope Rack Mount	263.00
543	DC to 33MHz Scope	300.00
561	DC to 10MHz Scope Rack Mount	150.00
561A	DC to 10MHz Scope Rack Mount	200.00

Scopes with Plug-ins

561A	DC to 10MHz Scope with a 3576 Dual Trace DC to 875MHz Sampling Plug In and a 3T77A Sweep Plug In. Rack Mount	600.00
565	DC to 10MHz Dual Beam Scope with a 2A63 Diff. and a 2A61 Diff. Plug In's	900.00
581	DC to 80MHz Scope with a R2 Dual Trace High Gain Plug In	650.00

Tubes

2E26	\$ 5.00	4CX350FJ	\$116.00	6146W	12.00
3-5002	102.00	4CX1000A	300.00	6159	10.60
3-1000Z	268.00	4CX1500B	350.00	6161	75.00
3B2B/866A	5.00	4CX15000A	750.00	6293	18.50
3X2500A1	150.00	4E27	50.00	6360	6.95
4-65A	45.00	4X150A	41.00	6907	40.00
4-125A	58.50	4X1500	52.00	6939	14.75
4-250A	68.50	4X150G	74.00	7360	12.00
4-400A	71.00	572B/T160L	39.00	7984	10.40
4-1000A	184.00	6L6	5.00	8072	49.00
5-500A	145.00	6L06	5.00	8106	2.00
4CX250B	65.00	811A	12.95	8156	7.85
4CX250F/G	55.00	813	29.00	8226	127.70
4CX250K	113.00	5894/A	42.00	8295/PL172	328.00
4CX250R	92.00	6146	5.00	8458	25.75
4CX300A	147.00	6146A	6.00	8560A/A5	50.00
4CX350A	107.00	6146B/8298A	7.00	890R	9.00
				8950	9.00

MICROWAVE COMPONENTS

ARRA

2416	Variable Attenuator	\$ 50.00
3614-60	Variable Attenuator 0 to 60dB	75.00
KU520A	Variable Attenuator 18 to 26.5 GHz	100.00
4684-20C	Variable Attenuator 0 to 180dB	100.00
6684-20F	Variable Attenuator 0 to 180dB	100.00

General Microwave

Directional Coupler 2 to 4GHz 20dB Type N	75.00
---	-------

Hewlett Packard

H487B	100 ohms Neg. Thermistor Mount (NEW)	150.00
H487B	100 ohms Neg. Thermistor Mount (USED)	100.00
477B	200 ohms Neg. Thermistor Mount (USED)	100.00
X487A	100 ohms Neg. Thermistor Mount (USED)	100.00
X487B	100 ohms Neg. Thermistor Mount (USED)	125.00

J468A	100 ohms Neg. Thermistor Mount (USED)	150.00
478A	200 ohms Neg. Thermistor Mount (USED)	150.00

J382	5.85 to 8.2 GHz Variable Attenuator 0 to 50dB	250.00
X382A	8.2 to 12.4 GHz Variable Attenuator 0 to 50dB	250.00

394A	1 to 2 GHz Variable Attenuator 6 to 120dB	250.00
NK292A	Waveguide Adapter	65.00
K422A	18 to 26.5 GHz Crystal Detector	250.00

8436A	Bandpass Filter 8 to 12.4 GHz	75.00
-------	-------------------------------	-------

8439A	2 GHz Notch Filter	75.00
8471A	RF Detector	50.00

H532A	7.05 to 10 GHz Frequency Meter	300.00
G532A	3.95 to 5.85 GHz Frequency Meter	300.00
J532A	5.85 to 8.2 GHz Frequency Meter	300.00

809A	Carriage with a 444A Slotted Line Untuned Detector Probe and 809B Coaxial Slotted Section 2.6 to 18 GHz	175.00
------	---	--------

Merrimac

AU-25A/	801115 Variable Attenuator	100.00
AU-26A/	801162 Variable Attenuator	100.00

Microlab/FXR

X6385	Horn 8.2 - 12.4 GHz	60.00
601-B18	X to N Adapter 8.2 - 12.4 GHz	35.00
Y6100	Coupler	75.00

Narda

4013C-10/	22540A Directional Coupler 2 to 4 GHz 10dB Type SMA	90.00
4014-10/	22538 Directional Coupler 3.85 to 8 GHz 10dB Type SMA	90.00
4014C-6/	22876 Directional Coupler 3.85 to 8 GHz 6dB Type SMA	90.00
4015C-10/	22539 Directional Coupler 7.4 to 12 GHz 10dB Type SMA	95.00
4015C-30/	23105 Directional Coupler 7 to 12.4 GHz 30dB Type SMA	95.00
3044-20	Directional Coupler 4 to 8 GHz 20dB Type N	125.00
3040-20	Directional Coupler 240 to 500 MC 20dB Type N	125.00

3043-20/	22006 Directional Coupler 1.7 to 4 GHz 20dB Type N	125.00
3003-10/	22011 Directional Coupler 2 to 4 GHz 10dB Type N	75.00
3003-30/	22012 Directional Coupler 2 to 4 GHz 30dB Type N	75.00

3043-30/	22007 Directional Coupler 1.7 to 3.5 GHz 30dB Type N	125.00
22574	Directional Coupler 2 to 4 GHz 10dB Type N	125.00
3033	Coaxial Hybrid 2 to 4 GHz 3dB Type N	125.00
3032	Coaxial Hybrid 950 to 2 GHz 3 dB Type N	125.00
784/	22380 Variable Attenuator 1 to 90dB 2 to 2.5 GHz Type SMA	550.00
22377	Waveguide to Type N Adapter	35.00
720-6	Fixed Attenuator 8.2 to 14.4 GHz 6 dB	50.00
3503	Waveguide	25.00

PRD

U101	12.4 to 18 GHz Variable Attenuator 0 to 60dB	300.00
X101	8.2 to 12.4 GHz Variable Attenuator 0 to 60dB	200.00
C101	Variable Attenuator 0 to 60dB	200.00
205A/367	Slotted Line with Type N Adapter	100.00
195B	8.2 to 12.4 GHz Variable Attenuator 0 to 50dB	100.00
185B51	7.05 to 10 GHz Variable Attenuator 0 to 40dB	100.00
196C	8.2 to 12.4 GHz Variable Attenuator 0 to 45dB	100.00
170B	3.95 to 5.85 GHz Variable Attenuator 0 to 45dB	100.00
588A	Frequency Meter 5.3 to 6.7 GHz	100.00
140A,C,D,E	Fixed Attenuators	25.00
109J,I	Fixed Attenuators	25.00
WEINSCHEL ENG.	2692 Variable Attenuator +30 to 60dB	100.00

COMPUTER I.C. SPECIALS

MEMORY

2708	2716/2516	2114/9114	2114L2	2114L3	4027	4060/2107	4050/9050	2111A-2/8111	2112A-2	2115AL-2	6104-3/4104	7141-2	MCM6641L20	9131
------	-----------	-----------	--------	--------	------	-----------	-----------	--------------	---------	----------	-------------	--------	------------	------

DESCRIPTION

1K x 8 EPROM	2K x 8 EPROM 5Volt Single Supply	1K x 4 Static RAM 450ns	1K x 4 Static RAM 250ns	1K x 4 Static RAM 350ns	4K x 1 Dynamic RAM	4K x 1 Dynamic RAM	4K x 1 Dynamic RAM	256 x 4 Static RAM	256 x 4 Static RAM	1K x 1 Static RAM 55ns	4K x 1 Static RAM 320ns	4K x 1 Static RAM 200ns	4K x 2 Static RAM 200ns	1K x 1 Static RAM 300ns
--------------	----------------------------------	-------------------------	-------------------------	-------------------------	--------------------	--------------------	--------------------	--------------------	--------------------	------------------------	-------------------------	-------------------------	-------------------------	-------------------------

PRICE

\$ 7.99	20.00	6.99	8.99	7.99	3.99	3.99	3.99	3.99	3.99	4.99	14.99	14.99	14.99	10.99
---------	-------	------	------	------	------	------	------	------	------	------	-------	-------	-------	-------

C.P.U.'s EGT.

MC6800L	MC6810AP	MC68A10P	MC68B10P	MC6820P	MC6820L	MC6821P	MC68821P	MCM6830L7	MC6840P	MC6845P	MC6845L	MC6850L	MC6852P	MC6852L	MC6854P	MC6860CJCS	MC6862L	MK3850N-3	MK3852P	MK3852N	MK3854N	8008-1	8080A	Z80CPU	6520	6530	2650	TMS1000NL	TMS4024NC	TMS6011NC	MC14411	AY5-4007D	AY5-9200	AY5-9100	AY5-2376	AY2-8500	TR1402A	PR1472B	PT1482B	8257	8251	8228	8212	MC14410CP	MC14412	MC14408	MC14409	MC1488L	MC1489L	MC1405L	MC1406L	MC1408/6/7/8	MC1330P	MC1349/50	MC1733L	LM565
Microprocessor	128 x 8 Static RAM 450ns	128 x 8 Static RAM 360ns	128 x 8 Static RAM 250ns	PIA	PIA	PIA	PIA	Mikbug	PTM	CRT Controller	CRT Controller	ACIA	SSDA	SSDA	ADLC	0-600 BPS Modem	2400 BPS Modem	F8 Microprocessor	F8 Memory Interface	F8 Memory Interface	F8 Direct Memory Access	Microprocessor	Microprocessor	Microprocessor	PIA	Support For 6500 series	Microprocessor	Four Bit Microprocessor	9 x 64 Digital Storage Buffer (FIFO)	UART	Bit Rate Generator	Four Digit Counter/Display Drivers	Repertory Dialler	Push Button Telephone Diallers	Keyboard Encoder	TV Game Chip	UART	UART	UART	DMA Controller	Communication Interface	System Controller & Bus Driver	8 Bit Input/Output Port	2 of 8 Tone Encoder	Low Speed Modem	Binary to Phone Pulse Converter	Binary to Phone Pulse Converter	RS232 Driver	RS232 Receiver	A/D Converter Subsystem	6 Bit D/A Converter	8 Bit D/A Converter	Low Level Video Detector	Video IF Amplifier	LM733 OP Amplifier	Phase Lock Loop
13.80	3.99	4.99	5.99	8.99	9.99	8.99	9.99	14.99	8.99	29.50	33.00	10.99	5.99	11.99	22.00	29.00	14.99	9.99	16.99	9.99	9.99	4.99	8.99	14.99	7.99	15.99	10.99	9.99	9.99	11.99	8.99	9.99	7.99	19.99	5.99	9.99	9.99	9.99	9.99	9.99	5.00	5.00	9.99	14.99	12.99	12.99	1.00	1.00	9.00	7.50	4.50	1.50	1.17	2.40	2.50	

MHz electronics

Toll Free Number

800-528-0180

(For orders only)

(602) 242-8916

2111 W. Camelback

Phoenix, Arizona 85015

KLM

SATELLITE RECEIVER SYSTEM

The entertainment opportunity of a lifetime!

Look what KLM,s SKY EYE 1 offers:Nearly 100 channles of the latest movies, sports, news, comedy, classic films, specials, religious programs and much more.....all in clear, sharp studio quality picture and sound. Forget about "fringe" or no-reception areas, ghosts, fading, imaging and all the other problems of TV reception. KLM,s SKI EYE 1 is your direct link to the 11 TV satellites now orbiting above the U.S. You,ll experience great shows and the greatest picture quality you,ve ever seen.

KLM,s SKY EYE 1 is a complete system, featuring performance-proven "state of the art" electronics design and materials. All you need is a modest amount of space for the special parabolic antenna(it,s screened surface blends with the landscaping to become a discrete addition to your yard).Inside your home,all those channels are accessible through the compact SKY EYE 1 Control Center.

With KLM,s SKY EYE 1 your TV becomes a true enterainment center, bringing you an amazing variety of great shows-something to please every member of your family.

KLM,s SKY EYE 1 SYSTEM Control Center

- * CONTINUOUS CHANNEL TUNING
- * CONTINUOUS AUDIO TUNING 5.8 TO 7.4 MHZ
- * POLARITY CONTROL CAPACITY,MOMENTARY AND LIMIT MODELS
- * SEPARATE REGULATED POWER SUPPLIES FOR LNA AND RECEIVER
- * STANDARD RG-59 COAX TO RECEIVER UNIT

Receiver Unit

- * SINGLE CONVERSION IMAGE REJECTION MIXER(greater linearity and video reponse than any PLL)
- * BUILT IN DC BLOCK
- * MODULAR CONSTRUCTION
- * WEATHER-PROOF ENCLOSURE

CONTROL CENTER and RECEIVER UNIT

\$1500.00

Antenna: KLM Parabolic Dish

- * SCREENED FOR LIGHT WEIGHT AND LOW WINDLOAD
- * EASY AZIMUTH AND ELEVATION CHANGES
- * MODEST BASEMOUNT REQUIREMENTS
- * HIGH GAIN LNA (AVANTEK)
- * MOTOR DRIVEN POLARITY CHANGES
- * 12 FOOT OR 16 FOOT PARABOLIC DISHES

\$ 800.00

12 Foot \$3000.00

16 Foot \$3500.00

MHz Toll Free Number
800-528-0180
electronics

TEST EQUIPMENT SALE

<u>Manufacture & Model</u>	<u>Description</u>	<u>Price</u>
AIL		
124A	200 to 2500MHZ Wide Range Power Oscillator	\$ 300.00
390A-3	Microwave Diode Test Set	25.00
AILTECH		
473A	Swept RF Power Source 225 to 400MHZ	500.00
ALTO		
34A1	FM TV Receiver 220MHZ	200.00
B&K		
161	Transistor Tester	75.00
607	Tube Tester	100.00
Ballantine		
303-06	AC Voltmeter	100.00
355	Digital Voltmeter AC/DC	75.00
6130A	Time Mark Generator	350.00
Bell & Howell		
2970	Color Video TV Camera with Monitor	300.00
Bird		
67C	RF Wattmeter 0 to 2.5KW at 30 to 500MHZ	200.00
TS-118A/AP	RF Wattmeter 2 to 500W at 20 to 1400MHZ	150.00
CY-1764/UPM	RF Wattmeter	
Birtcher		
10-AC	Hybrid Parameter Plug In For Model 70	50.00
10-C	Transistor Leakage Plug In For Model 70	50.00
10-E	Test Plug In For Model 70	50.00
70	Transistor Test Set For Above Plug In,s	175.00
Boonton		
63M	Inductance Bridge	500.00
71AR	Capacitance Inductance Bridge	600.00
71D	Capacitance Inductance Refrence	200.00
74CS8	Capacitance Bridge	600.00
91CA	RF Voltmeter 300uV/3V at 10Hz/600MHZ	300.00
91H	RF Voltmeter 100uV/300V at 20Hz/1.2GHZ	350.00
95AR	DC Microvolt/Picoammeter 10uV/1000V . 1pA/1A	200.00
Boonton/Hewlett Packard		
190A	Q Meter 20 to 260MHZ	500.00
207H	Univerter 100KHZ to 55MHZ	100.00
230A	Power Amplifier 10 to 500MHZ 4.5watts	500.00
230B	Power Amplifier Later Version of 230A	900.00
240A	Sweep Generator 4.5 to 120MHZ	200.00
250A	R X Meter .5 to 500MHZ	1500.00
260A	Q Meter 50KHZ to 50MHZ	500.00
280A	Q Meter 200 to 600MHZ	500.00
Clevite Brush		
13/4214-00	Log Amplifier	75.00
Cohu		
204AR	Galvenometer	75.00
Chromally/Military		
ACR/TS-20	Radio Test Set	100.00
Dana		
5500/130	Digital Voltmeter	150.00
5740	Digital Voltmeter	150.00
5800	Digital Ratiometer/Multimeter	200.00
Dymec/Hewlett Packard		
2650A	Oscillator Synchronizer	100.00
Dynamic		
504	Multimeter DC Micromiltimeter	100.00
E.H.LAB		
120D	Pulse Generator 100HZ to 20MHZ	200.00
E.I.P.		
101A	Spectrum Analyzer Plug In and Power Supply 700MHZ to (15.4GHZ)	1500.00
Electronic Service		
710A	Crystal Impedance Meter	300.00
Empire/Singer		
NF105	Noise & Field Intensity Meter	400.00
TA/NF105	150KHZ to 30MHZ Mod.M126 For NF105	200.00
TX/NF105	14KHZ to 150KHZ Mod.M126 For NF105	200.00
T1/NF105	20MHZ to 200MHZ Mod.M126 For NF105	200.00
T2/NF105	200MHZ to 400MHZ Mod.M126 For NF105	200.00
T3/NF105	400MHZ to 1000MHZ Mod.M126 For NF105	200.00
TA/NF105	150KHZ to 30MHZ For NF105	200.00
T2/MM120	50MHZ to 1000MHZ	200.00
T2/NF112	2000MHZ to 4000MHZ For NF112	200.00
T3/NF112	3900MHZ to 7200MHZ For NF112	200.00
Fairchild		
74-03	Time Base Plug In For 700 Series Scopes	150.00
76-01A	Single Input Vertical Amplifier For 700 Series Scopes	75.00
757	Oscilloscope	200.00
FEL	Microwave Synchronizer	300.00

MHz electronics
 Toll Free Number
 800-528-0180

<u>F.L.Mosley/Hewlett Packard</u>		
3S	X Y Recorder .5mv to 10v	225.00
60D	Logarithmic Converter	100.00
<u>Fluke</u>		
80E	High Voltage Divider	250.00
102	VAW Meter	150.00
710A	Impedance Meter Bridge	250.00
845AB	DC Null Detector/High Impedance Voltmeter	250.00
853A	Differential Meter	250.00
871A	DC Differential Voltmeter	250.00
<u>General Microwave</u>		
454AR	Microwave Power Meter	100.00
<u>General Radio</u>		
546C	Audio Frequency Microvolter	25.00
631D	Strobe	50.00
670F	Compensated Decade Resistor	50.00
740B	Capacitance Test Bridge	75.00
1203A	Power Supply	40.00
1203B	Power Supply	60.00
1208B	Oscillator 65 to 500MHZ	75.00
1211C	Oscillator .5 to 50MHZ	100.00
1212A	Null Detector	50.00
1214AS2	Unit Oscillator	50.00
1214D	Unit Oscillator	50.00
1215B	Unit Oscillator 50 to 250MHZ	100.00
1215C	Unit Oscillator 50 to 250MHZ	200.00
1216A	IF Amplifier	75.00
1217B	Unit Pulse Generator	50.00
1231P3	Tune Circuit	15.00
1269A	Power Supply	100.00
1363	Unit Oscillator 50 to 500MHZ	300.00
1382	Noise Generator	275.00
1390B	Noise Generator	200.00
1391B	Pulse,Sweep,Time Delay Generator With 1391P2 Power Supply	450.00
1604B	Comparison Bridge	125.00
1617A	Capacitance Bridge	500.00
1652A	Resistance Linmit Bridge	100.00
W50HM	Variac	200.00
<u>Gertsch</u>		
SB-4C-4R	Synchro Bridge	50.00
ST-100	Transformer	15.00
<u>Heathkit</u>		
IO-4560	Oscilloscope	75.00
<u>Hewlett Packard/F.L.Mosley</u>		
2DR2	X Y Recorder .1 to 20v	350.00
<u>Hewlett Packard</u>		
AC-60K	Barretter Matching Transformer	15.00
196A	Scope Camera	200.00
214A	Pulse Generator 10HZ to 1MHZ	650.00
216A	Pulse Generator to 100MHZ	650.00
350D	Attenuator Set	100.00
354A	Attenuator	250.00
400DR	VTVM 10HZ to 4MHZ	50.00
403A	AC Transistor Voltmeter	150.00
410B	VTVM	125.00
411AR	RF Millivoltmeter	250.00
413AR	DC Null Voltmeter	100.00
415B	VSWR Meter	50.00
416A	Ratio Meter	100.00
417A	VHF Detector 10 to 500MHZ	125.00
425A	DC Microvolt/Ammeter	250.00
428A	Clip ON DC Ammeter	275.00
430C	Microwave Power Meter DC to 10GHZ 10mw.	100.00
431B	Microwave Power Meter 10MHZ to 40GHZ 10uw to 10mw	200.00
431C	Microwave Power Meter 10MHZ to 40GHZ 10uw to 10mw	350.00
434A	Caloimetric Power Meter DC to 12.4GHZ 10watts	450.00
457A	AC DC Converter	75.00
500BR	Frequency Meter	100.00
508A	Motor	25.00
1105A	Pulse Generator	50.00
1111A	AC Current Amplifier	75.00
1510A	Electromyograph Plug In	250.00
1752A	High Gain Vertical Plug In For 175A Scope	50.00
1780A	Auxiliary Plug In For 175A Scope	25.00
2470A	Amplifier	100.00
2772A	Power Supply	100.00
3301A	Auxiliary Plug In	25.00
3310A	Function Generator	500.00
3406A	Broadband Sampling Voltmeter 10KHZ to 1.2GHZ	750.00

MHz Toll Free Number
800-528-0180
electronics

Hewlett Packard

3430A	Digital Voltmeter	150.00
3434A	Comparator	250.00
3441A	Range Selector For 3439A/ 3440A	75.00
3442A	Plug In For 3439A Automatic Range Selector & 3440A	50.00
3443A	High Gaun Auto Range Plug In For 3439A/3440A	200.00
3445A	AC DC Range Plug In For 3439A/3440A	175.00
3446A	AC DC Remote Plug In For 3439A/3440A	150.00
3450A	Digital Voltmeter	750.00
4260A	Universal Bridge	900.00
4910F	Open Fault Locator	250.00
5252A	Prescaler For 5245L/5246L to 350MHZ	250.00
5260A	Frequency Divider to 12.4 GHZ	1000.00
5327B	Timer Counter DVM to 512MHZ	1000.00
5383A	520MHZ Frequency Counter	300.00
5480A	with a 5486A and a 5485A , Memory Display, Control , and a Two Channel Input	3500.00
8005B	Pulse Generator	750.00
8007A	Pulse Generator	750.00
8402A	Calibrator For 431A and 431B	250.00
8601A	Generator/Sweeper	1200.00
8802A	Medium Gain Amplifier	100.00
10405	Vertical Response Tester	100.00
10407B	Plug In Extender	100.00
10411A	Horizontal Gain Calibrator	100.00
H03-353A	Attenuator Set	100.00
<u>Hickok</u>		
CA-4	Compactron Adapter For Tube Tester	150.00
DP100	DC Plug In	25.00
<u>Hughes/Cobilt</u>		
TCB-440/PE-100	Die Bonder (Like New)	1000.00
<u>ITT/Standard Telephones and Cables Ltd.</u>		
74834SG	Distortion Measuring Equipment	100.00
<u>Kay</u>		
110A	Mega Sweep	100.00
570A	Rada Pulse Sr. 10 to 80MHZ	100.00
990A	Utilator 4.5 to 220MHZ	100.00
<u>Keithley</u>		
200B	DC VTVM	50.00
250	Static Meter	300.00
416	Pico Ampmeter	100.00
600A	Electrometer	200.00
<u>Keltec</u>		
XR630-100	TWT Amplifier 8 to 12.4GHZ at 100watts 40dB Gain	5000.00
<u>Krohn Hite</u>		
310ABR	Band Pass Filter 20CPS to 200KC	100.00
350A	Ultra Low Frequency Rejection Filter .02HZ to 2KHZ	100.00
360AR	Rejection Filter 20CPS to 200KC	100.00
<u>Leeds & Northrup</u>		
Spectray 90	Temp. Detector	100.00
8686	Millivolt Potentiometer	250.00
<u>Meguro</u>		
MSG2282A	Signal Generator	500.00
<u>Millitary</u>		
AN/URM90	Impedance Bridge	150.00
SG-103/URM25F	H F Signal Generator 10KHZ to 50MHZ	250.00
ME180B/USM116B	RF Viltmeter Multimeter	100.00
TV-7DU	Tube Tester	125.00
<u>Millivac</u>		
828A	RF Microvoltmeter Solid State (NO PROBE)	100.00
<u>Nelson Ross</u>		
PSA-023	Spectrum Analyzer OKC to 500KC	300.00
PSA-034	Spectrum Analyzer 1KC to 2MHZ	300.00
<u>NLS</u>		
FM-7	Frequency Counter	100.00
MS-215	Scope	200.00
SC-5	Prescaler	150.00
<u>North Atlantic</u>		
RB-503C/S-1177	Ratio Box	75.00
VM-204	Phase Angle Voltmeter	100.00
<u>Singer</u>		
MF-5	Spectrum Analyzer with a UR-3 and a VR-4 1KHZ to 27.5MHZ	1200.00
<u>Philco/Sierra</u>		
470A-500	High Power Signal Generator 200 to 500MHZ 50watts	1100.00
<u>Polarad</u>		
SD-1	Multi Pulse Spectrum Analyzer	75.00
1001M4	Modulator	150.00

MHz Toll Free Number
800-528-0180
electronics

Polarad		
1107	Signal Generator 3.8 to 8.2GHZ	\$ 500.00
1108	Signal Generator 6.95 to 11GHZ	500.00
1108M4	Signal Generator 7 to 11GHZ	500.00
1206	Signal Generator 1.95 to 4.2GHZ	500.00
PRD		
680/X670	Calorimetric Power Meter with Dry Calorimeter 8.2 to 14.4 GHZ	300.00
Radio Ometer Copenhagen		
SMG-1	Stereo Generator	500.00
Ramcor		
1200	Densimeter	250.00
RCA		
WV-98C	Senior Volt Ohmyst	75.00
RFL		
107A	Magnet Charger	500.00
541A	10KC to 1100KC Crystal Impedance Meter	400.00
541C	2.5KC to 1100KC Crystal Impedance Meter	500.00
942A-8/HB7778	Magnet Charger with Transformer	1000.00
Rohde & Schwarz		
KRT	Capacitance Meter	500.00
SLRD	UHF Power Signal Generator 275 to 2750MHZ 20watts	1000.00
Sencor		
CA122B	Color Circuit Analyzer	200.00
Siemens		
3D3325	Selective Voltmeter	250.00
Spectra		
UBD 1/20	Photo Research Spotmeter	1500.00
Stoddart		
NM-10A	RFI Meter 10 to 250KHZ	200.00
NM-40A	RFI Meter 30HZ to 15KHZ	300.00
Teca Corp		
CH-3	Variable Pulse Generator & Chronavie Meter	150.00
Tele Signal Corp		
320	Test & Meter Unit	100.00
Telonic		
SM2000	Sweeper	300.00
Tektronix		
B	Wideband High Gain Plug In	35.00
CA	Dual Trace Plug In	100.00
D	High Gain Differential	25.00
H	Wideband High Gain DC	50.00
K	Fast Rise DC	35.00
M	Four Trace	200.00
N	Sampling	200.00
Q	Transducer & Strain Gage	200.00
R	Transistor Risetime	75.00
TU-2	Test Load	35.00
W	High Gain Differential Comparator	100.00
1A2	Dual Trace	200.00
1A5	Differential Comparator Amplifier	250.00
1S1	Sampling Unit with 350ps Risetime DC to 1GHZ	300.00
2A61	AC Differential	75.00
2A63	Differential	75.00
2B67	Time Base Single Sweep	200.00
3A75	Wideband DC	75.00
3S3	Dual Trace Sampling DC to 1GHZ	250.00
3S76	Dual Trace Samplins DC to 875MHZ	200.00
3T4	Programmable Sampling Sweep	300.00
3T77	Sampling Sweep	200.00
3T77A	Sampling Sweep	250.00
4S1/4S2/4S3/5T1/661	Sampling Scope with Dual Trace Sampling Units (3) and Timing Unit.	1000.00
7A15AN-11	Vertical Amplifier DC to 80MHZ	450.00
10A1	Differential Amplifier	250.00
10A2A	Dual Trace	250.00
RM15	Oscilloscope Same as 515 15MHZ	200.00
RM31A	Oscilloscope Same as 531A with Dual Trace Plug In 15MHZ	300.00
RM35A	Oscilloscope Same as 535A with Dual Trace Plug In 15MHZ	300.00
RM41A	Oscilloscope Same as 541A with Dual Trace Plug In 30MHZ	350.00
50	Amplifier	50.00
51	Sweep	50.00
53A	Wideband DC Plug In	20.00
53B	Wideband High Gain	25.00
53/54B	Wideband High Gain	30.00
53/54C	Dual Trace	75.00
53/54D	High Gain Differential	20.00
53/54K	Fast Rise DC	45.00
63	Differential	65.00
81	Plug In Adapter For 581/A & 585/A	65.00

MHz | Toll Free Number
800-528-0180
electronics

<u>TEKTRONIX</u>		
81A	Adapter For 581/A & 585/A	\$ 90.00
84	Test Unit	75.00
107	Square Wave Generator	50.00
RM122	Preamplifier	50.00
123	AC Coupled Preamplifier	20.00
131	Current Probe Amplifier	75.00
240	Control Unit	150.00
280	Trigger Countdown Unit	75.00
RM503	Oscilloscope 450KHZ	200.00
535	Oscilloscope with Dual Trace Plug In 15MHZ	325.00
535A	Oscilloscope with Dual Trace Plug In 15MHZ	375.00
543	Oscilloscope with Dual Trace Plug In 33MHZ	350.00
543A	Oscilloscope with Dual Trace Plug In 33MHZ	400.00
545A	Oscilloscope with Dual Trace Plug In 30MHZ	450.00
555	Dual Beam Oscilloscope with Dual Trace Plug In 33MHZ	500.00
561	Oscilloscope 10MHZ	100.00
RM561	Oscilloscope 10MHZ Same as 561	100.00
RM561A	Oscilloscope 10MHZ Same as 561A	175.00
561B	Oscilloscope 10MHZ	250.00
564	Split Screen Storage Oscilloscope	450.00
RM565	Oscilloscope Same as 565 Dual Beam 10MHZ	650.00
581	Oscilloscope with 81 Adapter and Dual Trace Plug In	550.00
601	Storage Display	250.00
611	Storage Display	1000.00
1791	NC Program Verfier	1500.00
067-0513-00	Calibration Fixture	100.00
067-0591-00	Calibration Fixture	100.00
067-508	Calibration Fixture	100.00
TIC		
T-10A	DME Pulse Generator	200.00
T-10M	DME Speed Indicator Adapter	200.00
<u>Teradyne</u>		
ACT1	Analogical Circuit Tester with Boards	500.00
<u>Texscan</u>		
HS-85	Sweep Generator 400 to 1000MHZ	250.00
VS-73	Sweep Generator 400 to 450MHZ	100.00
<u>Theta</u>		
SSB-11E	System Error Bridge	75.00
<u>Wandel u Goltermann</u>		
LDE2 & LDS2	Measurins Set For Group Delay Attenuation and Receiver and Attenuation Generator	Make Offer
<u>Weinschel Eng.</u>		
BA5	Attenuation Calibrator	100.00
675	Thermistor Mount	100.00
935N	Thermistor Mount	100.00
<u>Western Reserve</u>		
RFI RF-204U	RFI Receiver	200.00
<u>Wiltron</u>		
321/322/326/327/640G50	Phase & Amplitude Indicator with Local Oscillator 2.5 to 100MHZ , Time Delay Unit , High Resolution Time Delay Unit , Modulation Unit	750.00
640G50	Sweep Generator to 500MHZ	750.00
<u>LATE ADD ON,s</u>		
<u>Textron</u>		
N160	X Y Recorder	200.00

All Prices Are In US Dollars.
 All Equipment Shipped Airfreight or UPS FOB Phoenix , Arizona
 All Equipment Working Unless Other Wise Stated.60 Day Warranty On All Equipment.
 We Do Not Take P.O.,s Unless COD , or Check With Order.
 Manuals Not Included But Some In Stock At A Small Charge.

MHz ^{✓48} **electronics**

TOLL FREE #
 (800) 528-0180
 (for orders only)

(602) 242-8916

2111 W. Camelback
 Phoenix, Arizona 85015

We now have available a bunch of goodies too good to bypass. Items are limited so order today

Call Your Phone Order in Today
TERMS: Satisfaction guaranteed or money refunded. C.O.D. add \$2.00. Minimum order \$6.00. Orders under \$10.00 add \$1.50. Add 5% for postage, insurance, handling. Overseas add 15%. N.Y. residents add 7% tax.

**MINI KITS - YOU HAVE SEEN THESE BEFORE NOW
HERE ARE OLD FAVORITE AND NEW ONES TOO.
GREAT FOR THAT AFTERNOON HOBBY.**

FM MINI MIKE

A super high performance FM wireless mike kit! Transmits a stable signal up to 300 yards with exceptional audio quality by means of its built in electret mike. Kit includes case, mike, on-off switch, antenna, battery and super instructions. This is the finest unit available

FM-3 Kit **\$14.95**
FM-3 Wired and Tested **19.95**

Color Organ

See music come alive! 3 different lights flicker with music. One light each for, high, mid-range and lows. Each individually adjustable and drives up to 300 W. runs on 110 VAC.

Complete kit, ML-1 **\$8.95**

Video Modulator Kit
Converts any TV to video monitor. Super stable, tunable over ch 4-6. Runs on 5-15V, accepts std. video signal. Best unit on the market! Complete kit, VD-1 **\$7.95**

Led Blinky Kit
A great attention getter which alternately flashes 2 jumbo LEDs. Use for name badges, buttons, warning panel lights, anything! Runs on 3 to 15 volts. Complete kit, BL-1 **\$2.95**

Super Sleuth
A super sensitive amplifier which will pick up a pin drop at 15 feet! Great for monitoring baby's room or as general purpose amplifier. Full 2 W rms output, runs on 6 to 15 volts, uses 8-45 ohm speaker. Complete kit, BN-9. **\$5.95**

CPO-1
Runs on 3-12 Vdc 1 wall out, 1 KHZ good for CPO, Alarm, Audio Oscillator. Complete kit **\$2.95**

CLOCK KITS

Your old favorites are here again. Over 7,000 Sold to Date. Be one of the gang and order yours today!

Try your hand at building the finest looking clock on the market. Its satin finish anodized aluminum case looks great anywhere, while six .4" LED digits provide a highly readable display. This is a complete kit, no extras needed, and it only takes 1-2 hours to assemble. Your choice of case colors: silver, gold, black (specify).
Clock kit, 12/24 hour, DC-5 **\$24.95**
Clock with 10 min. ID timer, 12/24 hour, DC-10 **\$29.95**
Alarm clock, 12 hour only, DC-8 **\$29.95**
12V DC car clock, DC-7 **\$29.95**

For wired and tested clocks add \$10.00 to kit price. SPECIFY 12 OR 24 HOUR FORMAT

FM Wireless Mike Kit

Transmits up to 300' to any FM broadcast radio, uses any type of mike. Runs on 3 to 9V. Type FM-2 has added sensitive mike preamp stage.

FM-1 kit **\$3.95** FM-2 kit **\$4.95**

Whisper Light Kit

An interesting kit, small mike picks up sounds and converts them to light. The louder the sound, the brighter the light. Includes mike, controls up to 300 W, runs on 110 VAC. Complete kit, WL-1 **\$6.95**

Tone Decoder

A complete tone decoder on a single PC board. Features 400-5000 Hz adjustable range via 20 turn pot, voltage regulation, 567 IC. Useful for touch-tone burst detection, FSK, etc. Can also be used as a stable tone encoder. Runs on 5 to 12 volts. Complete kit, TD-1 **\$5.95**

Universal Timer Kit

Provides the basic parts and PC board required to provide a source of precision timing and pulse generation. Uses 555 timer IC and includes a range of parts for most timing needs.

UT-5 Kit **\$5.95**

Mad Blaster Kit

Produces LOUD ear shattering and attention getting siren like sound. Can supply up to 15 watts of obnoxious audio. Runs on 6-15 VDC. Complete kit, MB-1 **\$4.95**

Siren Kit

Produces upward and downward wail characteristic of a police siren. 5 W peak audio output, runs on 3-15 volts, uses 3-45 ohm speaker. Complete kit, SM-3 **\$2.95**

60 Hz Time Base
Runs on 5-15 VDC. Low current (2.5ma) 1 min/month accuracy TB-7 Kit **\$5.50**
TB-7 Assy. **\$9.95**

Car Clock

The UN-KIT, only 5 solder connections

Here's a super looking, rugged and accurate auto clock, which is a snap to build and install. Clock movement is completely assembled - you only solder 3 wires and 2 switches takes about 15 minutes! Display is bright green with automatic brightness control photocell - assures you of a highly readable display, day or night. Comes in a satin finish anodized aluminum case which can be attached 5 different ways using 2 sided tape. Choice of silver, black or gold case (specify).

DC-3 kit, 12 hour format **\$22.95**
DC-3 wired and tested **\$29.95**

Calendar Alarm Clock

The clock that's got it all! 6-5" LEDs, 12/24 hour, snooze, 24 hour alarm, 4 year calendar, battery backup and lots more. The super 7001 chip is used. Size: 5x4x2 inches. Complete kit, less case (not available) DC-9 **\$34.95**

Under Dash Car Clock

12/24 hour clock in a beautiful plastic case features 6 jumbo RED LEDs, high accuracy (.001%), easy 3 wire hookup, display blanks with ignition and super instructions. Optional dimmer automatically adjusts display to ambient light level. DC-11 clock with mtg. bracket **\$27.95 kit**
DM-1 dimmer adapter **\$2.50**
Add \$10.00 Assy. and Test

Universal Timer Kit

Provides the basic parts and PC board required to provide a source of precision timing and pulse generation. Uses 555 timer IC and includes a range of parts for most timing needs.

UT-5 Kit **\$5.95**

Mad Blaster Kit

Produces LOUD ear shattering and attention getting siren like sound. Can supply up to 15 watts of obnoxious audio. Runs on 6-15 VDC. Complete kit, MB-1 **\$4.95**

Siren Kit

Produces upward and downward wail characteristic of a police siren. 5 W peak audio output, runs on 3-15 volts, uses 3-45 ohm speaker. Complete kit, SM-3 **\$2.95**

60 Hz Time Base
Runs on 5-15 VDC. Low current (2.5ma) 1 min/month accuracy TB-7 Kit **\$5.50**
TB-7 Assy. **\$9.95**

Video Terminal

A completely self-contained, stand alone video terminal card. Requires only an ASCII keyboard and TV set to become a complete terminal unit. Features are: single 5V supply, XTAL controlled sync and baud rates (to 9600), complete computer and keyboard control of cursor, parity error control and display. Accepts and generates serial ASCII plus parallel keyboard input. The 6416 is 64 char. by 16 lines with scrolling, upper and lower case (optional) and has RS-232 and 20ma loop interfaces on board. Kits include sockets and complete documentation. RE-6416 terminal card kit (add \$60.00 for wired unit) **\$189.95**
Lower Case option **\$13.95**
Power Supply **\$14.95**
RF Modulator kit **\$7.95**

PARTS PARADE

IC SPECIALS

LINEAR

301 **\$.35**
324 **\$1.50**
380 **\$1.50**
555 **\$.45**
556 **\$1.00**
565 **\$1.00**
566 **\$1.00**
567 **\$1.25**
741 **\$2.00**
1458 **\$.50**
3900 **\$.50**
3914 **\$2.95**
8038 **\$2.95**

TTL

74S00 **\$.40**
7447 **\$.65**
7475 **\$.50**
7490 **\$.50**
74196 **\$1.35**

SPECIAL

11C90 **\$15.00**
10116 **\$ 1.25**
7208 **\$17.50**
7207A **\$ 5.50**
7216D **\$21.00**
7107C **\$12.50**
5314 **\$ 2.95**
5375AB/G **\$ 2.95**
7001 **\$ 6.50**

CMOS

4011 **.50**
4013 **.50**
4046 **\$1.85**
4049 **.50**
4059 **\$9.00**
4511 **\$2.00**
4518 **\$1.35**
5639 **\$1.75**

Resistor Ass't

Assortment of Popular values - 1/2 watt. Cut lead for PC mounting, 1/2" center, 1/2" leads, bag of 300 or more. **\$1.50**

Switches

Mini toggle SPDT **\$1.00**
Red Pushbuttons N.O. **3/\$1.00**

Earphones

3" leads, 8 ohm, good for small tone speakers, alarm clocks, etc. **5 for \$1.00**

Mini 8 ohm Speaker
Approx 2 1/2" diam Round type for radios, mike etc. **3 for \$2.00**

Crystals

3.579545 MHZ **\$1.50**
10.00000 MHZ **\$5.00**
5.248800 MHZ **\$5.00**

AC Adapters

Good for clocks, nicad chargers, all 110 VAC plug one end.
8.5 vdc @ 20 mA **\$1.00**
16 vac @ 160mA **\$2.50**
12 vac @ 250mA **\$3.00**

Solid State Buzzers

small buzzer 450 Hz, 86 dB, sound output on 5-12 vdc at 10-30 mA, TTL compatible **\$1.50**

Slug Tuned Coils
Small 3/16" Hex Slugs turned coil 3 turns **10 for \$1.00**

AC Outlet
Panel Mount with Leads **4/\$1.00**

CAPACITORS

TANTALUM	ALUMINUM	DISK CERAMIC
Dipped Epoxy	Electrolytic	01 16V disk 20/\$1.00
1.5 uF 25V 3/\$1.00	1000 uF 16V Radial \$.50	1 16V 15/\$1.00
1.8 uF 25V 3/\$1.00	500 uF 20V Axial \$.50	001 16V 20/\$1.00
.22 uF 25V 3/\$1.00	150 uF 16V Axial 5/\$1.00	100 pF 20/\$1.00
	10 uF 15V Radial 10/\$1.00	047 16V 20/\$1.00

FERRITE BEADS

With info and specs **15/\$1.00**
6 Hole Balun Beads **5/\$1.00**

READOUTS

FND 359 4" C.C. **\$1.00**
FND 507/510 5" C.A. **1.00**
MAN 72/HP7730 33" C.A. **1.00**
HP 7651 43" C.A. **2.00**

Sockets

8 Pin **10/\$2.00**
14 Pin **10/\$2.00**
16 Pin **10/\$2.00**
24 Pin **4/\$2.00**
28 Pin **4/\$2.00**
40 Pin **3/\$2.00**

DC-DC Converter

+5 vdc input prod. -9 vdc @ 30ma
+9 vdc produces -15 vdc @ 35ma **\$1.25**

25K 20 Turn Trim Pot **\$1.00**
1K 20 Turn Trim Pot **\$.50**

Ceramic IF Filters

Mini ceramic filters 7 kHz B.W. 455 kHz **\$1.50 ea.**

Trimmer Caps
Sprague - 3-40 pf Stable Polypropylene **.50 ea.**

TRANSISTORS

2N3904 NPN C-F **15/\$1.00**
2N3906 PNP C-F **15/\$1.00**
2N4403 PNP C-F **15/\$1.00**
2N4410 NPN C-F **15/\$1.00**
2N4916 FET C-F **4/\$1.00**
2N5401 PNP C-F **5/\$1.00**
2N6028 C-F **4/\$1.00**
2N3771 NPN Silicon **\$1.50**
2N5179 UHF NPN **3/\$2.00**
Power Tab NPN 40W **3/\$1.00**
Power Tab PNP 40W **3/\$1.00**
MPF 102/2N5484 **\$.50**
NPN 3904 Type T-R **50/\$2.50**
PNP 3906 Type T-R **50/\$2.50**
2N3055 **\$.80**
2N2646 UJT **3/\$2.00**

Diodes

5.1 V Zener **20/\$1.00**
1N914 Type **50/\$1.00**
1KV 2Amp **8/\$1.00**
100V 1Amp **15/\$1.00**

Crystal Microphone

Small 1" diameter 1/4" thick crystal mike cartridge **\$.75**

Mini RG-174 Coax

10 ft. for **\$1.00**

Coax Connector

Chassis mount BNC type **\$1.00**

9 Volt Battery Clips

Nice quality clips **5 for \$1.00**
1/4" Rubber Grommets **10 for \$1.00**

Parts Bag

Ass't of chokes, disc caps, tant resistors, transistors, diodes, MICA caps etc. sm. bag (100 pc) **\$1.00** lg. bag (300 pc) **\$2.50**

Connectors

6 pin type gold contacts for mA-1003 car clock module price **.75 ea.**

Leds - your choice, please specify
Mini Red, Jumbo Red, High Intensity Red, Illuminator Red **8/\$1**
Mini Yellow, Jumbo Yellow, Jumbo Green **6/\$1**

Varactors

Motorola MV 2209 30 PF Nominal cap 20-80 PF - Tunable range - **.50 each or 3/\$1.00**

600 MHz PRESCALER



Extend the range of your counter to 600 MHz. Works with all counters. Less than 150 mv sensitivity. specify - 10 or -100

Wired, tested, PS-1B **\$59.95**
Kit, PS-1B **\$44.95**

30 Watt 2 mtr PWR AMP

Simple Class C power amp features 8 times power gain, 1 W in for 8 out, 2 W in for 15 out, 4W in for 30 out. Max output of 35 W, incredible value, complete with all parts, less case and T-R relay.
PA-1, 30 W pwr amp kit **\$22.95**
TR-1, RF sensed T-R relay kit **6.95**

MRF-238 transistor as used in PA-1 8-10db gain 150 mhz **\$11.95**

Power Supply Kit

Complete triple regulated power supply provides variable 6 to 18 volts at 200 ma and +5 at 1 Amp. Excellent load regulation, good filtering and small size. Less transformers, requires 6.3 V @ 1 A and 24 VCT. Complete kit, PS-3LT **\$6.95**

RF actuated relay senses RF (1W) and closes DPDT relay. For RF sensed T-R relay TR-1 Kit **\$6.95**

OP-AMP Special

BI-FET LF 13741 - Direct pin for pin 741 compatible, but 500,000 MEG input z, super low 50 pa input current, low power drain. **50 for only \$9.00** **10 for \$2.00**

Regulators

78MG **\$1.25**
79MG **\$1.25**
723 **\$.50**
309K **\$1.15**
7805 **\$1.00**

7812 **\$1.00**
7815 **\$1.00**
7905 **\$1.25**
7912 **\$1.25**
7915 **\$1.25**

Shrink Tubing Nubs
Nice precut pcs of shrink size: 1" x 1/4" shrink to 1/8" Great for splices **50/\$1.00**

Mini TO-92 Heat Sinks
Thermalloy Brand **5 for \$1.00**
To-220 Heat Sinks **3 for \$1.00**

Opto Isolators - 4N28 type **\$.50 ea.**
Opto Reflectors - Photo diode + LED **\$1.00 ea.**

Molex Pins
Molex already precut in length of 7. Perfect for 14 pin sockets. **20 strips for \$1.00**

CDS Photocells
Resistance varies with light. 250 ohms to over 3 meg **3 for \$1.00**

These Low Cost SSB TRANSMITTING CONVERTERS

Let you use inexpensive recycled 10M or 2M SSB exciters on UHF & VHF!

- Linear Converters for SSB, CW, FM, etc.
- A fraction of the price of other units; no need to spend \$300 - \$400!
- Use with any exciter; works with input levels as low as 1 mW.
- Use low power tap on exciter or simple resistor attenuator pad (instructions included).
- Link osc with RX converter for transceive.

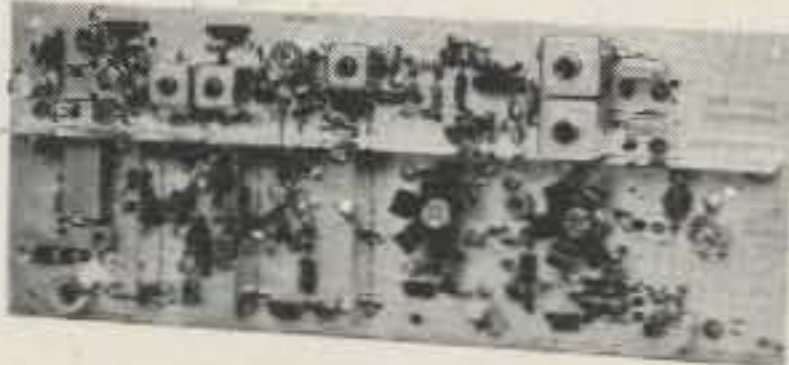

XV4 UHF KIT — ONLY \$99.95

28-30 MHz in, 435-437 MHz out; 1W p.e.p. on ssb, up to 1½W on CW or FM. Has second oscillator for other ranges. Atten. supplied for 1 to 500 mW input, use external attenuator for higher levels.

Extra crystal for 432-434 MHz range.....\$5.95
XV4 Wired and tested\$149.95

XV2 VHF KIT - ONLY \$69.95

2W p.e.p. output with as little as 1mW input. Use simple external attenuator. Many freq. ranges available.

MODEL	INPUT (MHz)	OUTPUT (MHz)
XV2-1	28-30	50-52
XV2-2	28-30	220-222
XV2-4	28-30	144-146
XV2-5	28-29 (27-27.4 CB)	145-146 (144-144.4)
XV2-7	144-146	50-52

XV2 Wired and tested\$109.95

XV28 2M ADAPTER KIT - \$24.95

Converts any 2M exciter to provide the 10M signal required to drive above 220 or 435 MHz units.



NEW! COMPLETE TRANSMITTING CONVERTER AND PA IN ATTRACTIVE CABINET

Far less than the cost of many 10W units!

Now, the popular Hamtronics® Transmitting Converters and heavy duty Linear Power Amplifiers are available as complete units in attractive, shielded cabinets with BNC receptacles for exciter and antenna connections. Perfect setup for versatile terrestrial and OSCAR operations! Just right for phase 3! You save \$30 when you buy complete unit with cabinet under cost of individual items. Run 40-45 Watts on VHF or 30-40 Watts on UHF with one integrated unit! Call for more details.

MODEL	KIT	WIRED and TESTED
XV2/LPA2-45/Cabt (6M or 2M)	\$199.95	\$299.95
XV4/LPA4-30/Cabt (for UHF)	\$229.95	\$349.95

Easy to Build FET RECEIVING CONVERTERS

Let you receive OSCAR and other exciting VHF and UHF signals on your present HF or 2M receiver



- NEW LOW-NOISE DESIGN
- ATTRACTIVE WOODGRAIN CASE
- Less than 2dB noise figure, 20dB gain

MODEL	RF RANGE	OUTPUT RANGE
CA28	28-32 MHz	144-148 MHz
CA50	50-52	28-30
CA50-2	50-54	144-148
CA144	144-146	28-30
CA145	145-147-or-144-144.4	28-30
CA146	146-148	27-27.4 (CB)
CA220	220-222	28-30
CA220-2	220-224	144-148
CA110	Any 2MHz of Aircraft Band	26-28 or 28-30
CA432-2	432-434	28-30
CA432-5	435-437	28-30
CA432-4	432-436	144-148

Easily modified for other rf and if ranges.

STYLE	VHF	UHF
Kit less case	\$34.95	\$49.95
Kit with case	\$39.95	\$54.95
Wired/Tested in case	\$54.95	\$64.95

Professional Quality VHF/UHF FM/CW EXCITERS

- Fully shielded designs
- Double tuned circuits for spurious suppression
- Easy to align with built-in test aids

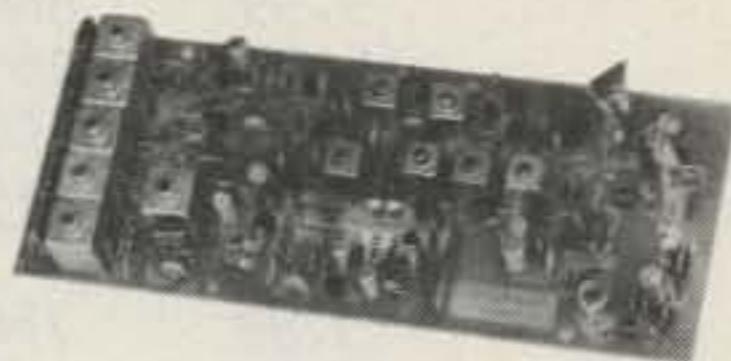

T50-50	6-chan, 6M, 2W Kit.....	\$44.95
T50-150	6-chan, 2M, 2W Kit.....	\$44.95
T50-220	6-chan, 220 MHz, 2W Kit.....	\$44.95
T450	1-chan, 450 MHz, ¼W Kit.....	\$44.95

See our Complete Line of VHF & UHF Linear PA's

- Use as linear or class C PA
- For use with SSB Xmtg Converters, FM Exciters, etc.

LPA2-15	6M, 2M, 220; 15 to 20W.....	\$59.95
LPA2-30	6M, 2m; 25 to 30W.....	\$89.95
LPA2-40	220 MHz; 30 to 40W.....	\$119.95
LPA2-45	6M, 2M; 40 to 45W.....	\$119.95
LPA4-10	430MHz; 10 to 14W.....	\$79.95
LPA4-30	430MHz; 30-40W.....	\$119.95

See catalog for complete specifications

FAMOUS HAMTRONICS PREAMPS

Let you hear the weak ones too! Great for OSCAR, SSB, FM, ATV. Over 14,000 in use throughout the world on all types of receivers.

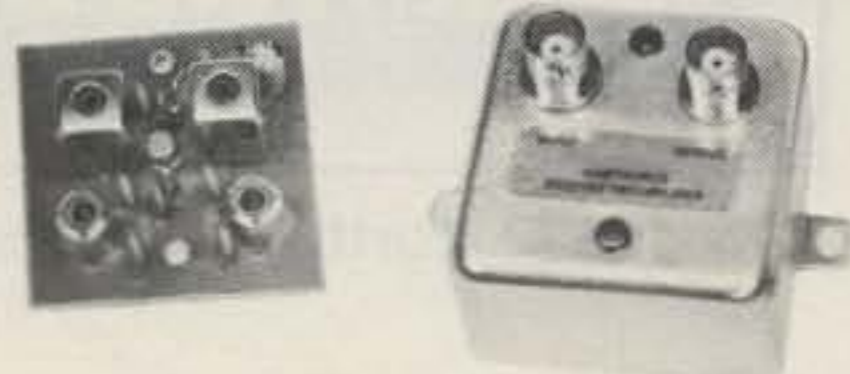

- NEW LOW-NOISE DESIGN
- Less than 2 dB noise figure, 20 dB gain
- Case only 2 inches square
- Specify operating frequency when ordering

MODEL P-30 VHF PREAMP, available in many versions to cover bands 18-300 MHz.

MODEL P432 UHF PREAMP, available in versions to cover bands 300-650 MHz.

STYLE	VHF	UHF
Kit less case	\$12.95	\$18.95
Kit with case	\$18.95	\$26.95
Wired/Tested in Case	\$27.95	\$32.95

NEW VHF/UHF FM RCVRs

Offer Unprecedented Range of Selectivity Options

- New generation
- More sensitive
- More selective
- Low cross mod
- Uses crystal filters
- Smaller
- Easy to align

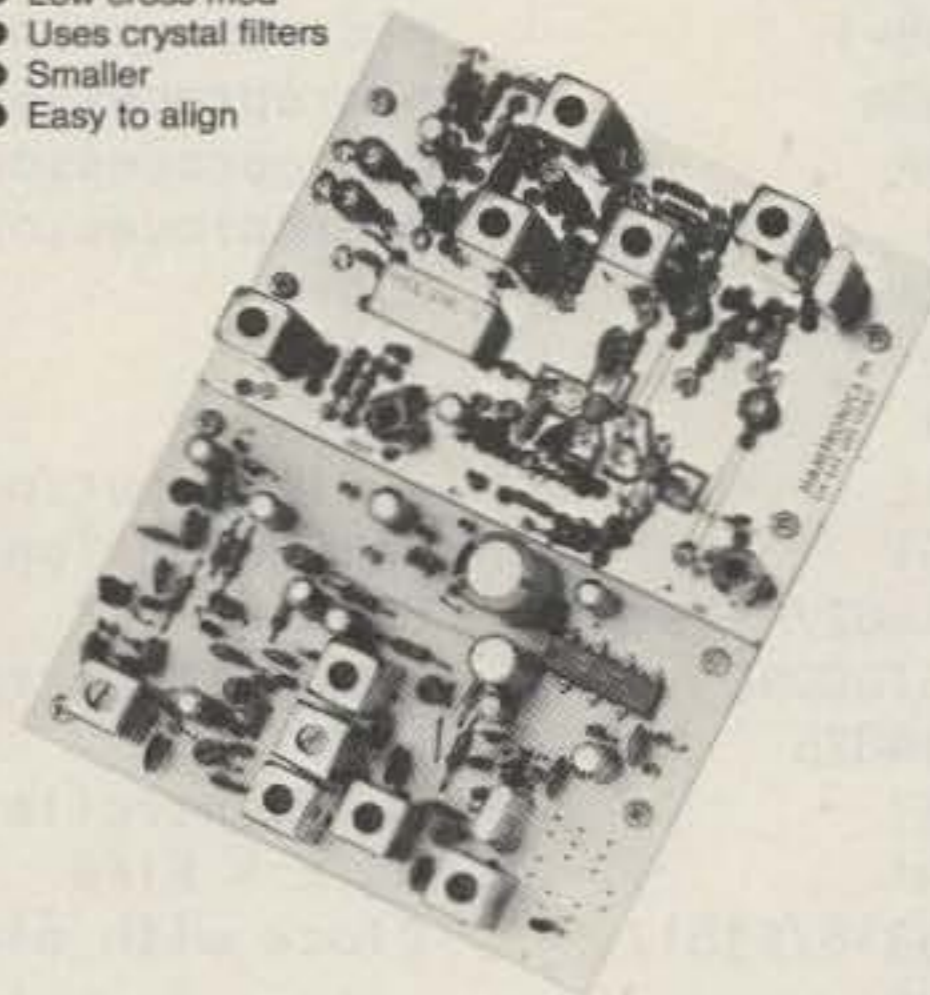

R75A* VHF Kit for monitor or weather satellite service. Uses wide L-C filter. -60dB at ± 30 kHz.....\$69.95

R75B* VHF Kit for normal nbfm service. Equivalent to most transceivers. -60dB at ± 17 kHz, -80dB at ± 25 kHz....\$74.95

R75C* VHF Kit for repeater service or high rf density area. -60dB at ± 14kHz, -80dB ± 22kHz, -100dB ± 30kHz....\$84.95

R75D* VHF Kit for split channel operation or repeater in high density area. Uses 8-pole crystal filter. -60dB at ± 9kHz, -100dB at ± 15 kHz. The ultimate receiver!...\$99.95

* Specify band: 10M, 6M, 2M, or 220 MHz. May also be used for adjacent commercial bands. Use 2M version for 137 MHz WX satellites.

R450() UHF FM Receiver Kits, similar to R75, but for UHF band. New low-noise front end. Add \$10 to above prices. (Add selectivity letter to model number as on R75.)

A14 5 Channel Adapter for Receivers.....\$9.95

NEW R110 VHF AM RCVR

AM monitor receiver kit similar to R75A, but AM. Available for 10-11M, 6M, 2M, 220 MHz, and 110-130 MHz aircraft band \$74.95. (Also available in UHF version.)

IT'S EASY TO ORDER!

- Write or phone 716-392-9430 (Electronic answering service evenings & weekends)
- Use Credit Card, UPS COD, Check, Money Order
- Add \$2.00 shipping & handling per order

Call or Write to get FREE CATALOG With Complete Details (Send 4 IRC's for overseas mailing)

HAMTRONICS® IS A REGISTERED TRADEMARK

hamtronics, inc.

65J MOUL RD • HILTON, NY 14468

SEMICONDUCTORS SURPLUS

2822 North 32nd Street, #1 • Phoenix, Arizona 85008 • Phone 602-956-9423

MEMORY

	Description	Price
2708	1K x 8 Eprom	\$ 5.00
2716/2516	2K x 8 5V single supply	9.99
2114/9114	1K x 4 Static	5.00
4027	4K x 1 Dynamic Ram	2.99
2117/4116	16K x 1 Dynamic Ram	5.00
2732-6	32K Eprom	39.95

C.P.U.'s, Etc.

MC6800P	Microprocessor	9.99
MC68B21P	PIA	6.99
MC6845P	CRT Controller	25.00
MC6850P	ACIA	4.99
MC6852P	SSDA	5.00
8008-1	Microprocessor	5.00
8080A	Microprocessor	5.00
Z80A	Microprocessor	10.99
Z80	Microprocessor	8.99
Z80A	PIO	9.99
Z80	SIO/O	22.50
Z80	SIO/I	22.50
8212	8 Bit input/output part	3.99
8251	Communication Interface	6.99
TR1602/AY5-1013	UART	6.99
TMS1000NL	Four Bit Microprocessor	4.99
PT1482B	PSAT	5.99
8257	DMA Controller	8.99
3341	64 x 4 FIFO	3.00
MM5316/F3817	Clock with alarm	5.99
8741		60.00
8748	8 Bit Microcomputer with programmable/erasable EPROM	60.00
MC1408L/6	6 Bit D/A	3.25
COM2502		9.99
COM2601		9.99

CRYSTAL FILTERS

TYCO 001-19880 Same as 2194F
 10.7 MHz narrow band
 3 dB bandwidth 15 KHz min.
 20 dB bandwidth 60 KHz min.
 40 dB bandwidth 150 KHz min.
 Ultimate 50 dB insertion loss 1 dB max.
 Ripple 1 dB max. Ct. 0+/-5 pf 3600 Ohms
 \$3.99 each

MRF454, same as MRF458 12.5 VDC, 3-30 MHz
 80 Watts output, 12 dB gain \$17.95 each

MRF472

12.5 VDC, 27 MHz
 4 Watts output, 10 dB gain
 \$1.69 each

CARBIDE CIRCUIT BOARD DRILL BITS
 for PCB Boards
 5 mix for \$5.00

MURATA CERAMIC FILTERS

SFD 455D	455 KHz	\$2.00
SFB 455D	455 KHz	1.60
CFM 455E	455 KHz	5.50
SFE 10.7 MA	10.7 MHz	2.99

ATLAS CRYSTAL FILTERS FOR ATLAS

HAM GEAR
 5.52 - 2.7/8
 5.595 - 2.7/8/U
 5.645 - 2.7/8
 5.595 - .500/4/CW YOUR CHOICE
 5.595 - 2.7 USB \$12.99 each
 5.595 - 2.7/8/L
 5.595 - 2.7 LSB
 9.0 - USB/CW

J310 N-CHANNEL J-FET 450 MHz
 Good for VHF/UHF Amplifier,
 Oscillator and Mixers 3/\$1.00

AMPHENOL COAX RELAY

26 VDC Coil SPDT #360-11892-13
 100 Watts Good up to 18 GHz
 \$19.99 each

78M05 Same as 7805 but only 1/2 Amp @
 5 VDC 49¢ each or 10/\$3.00

NEW TRANSFORMERS

F-18X	6.3 VCT @ 6 Amps	\$6.99 ea.
F-46X	24 V @ 1 Amp	5.99 ea.
F-41X	25.2 VCT @ 2 Amps	6.99 ea.
P-8380	10 VCT @ 3 Amps	7.99 ea.
P-8604	20 VCT @ 1 Amp	4.99 ea.
P-8130	12.6 VCT @ 2 Amps	4.99 ea.
K-32B	28 VCT @ 100 MA	4.99 ea.
E30554	Dual 17V @ 1Amp ea.	6.99 ea.

EIMAC FINGER STOCK #Y-302
 36 in. long x 1/2 in. \$4.99 each

NO ORDERS UNDER \$10

SEMICONDUCTORS SURPLUS

2822 North 32nd Street, #1 • Phoenix, Arizona 85008 • Phone 602-956-9423 ✓64

MRF203	\$P.O.R.	BFW92A	\$ 1.00	UHF/VHF RF POWER TRANSISTORS
MRF216	19.47	BFW92	.79	CD2867/2N6439
MRF221	8.73	MMCM913	14.30	60 Watts output
MRF226	10.20	MMCM2222	15.65	Reg. Price \$45.77
MRF227	2.13	MMCM2369	15.00	SALE PRICE \$19.99
MRF238	10.00	MMCM2484	15.25	
MRF240	14.62	MMCM3960A	24.30	1900 MHz to 2500 MHz DOWNCONVERTERS
MRF245	28.87	MWA110	6.92	Intended for amateur radio use
MRF247	28.87	MWA120	7.38	Tunable from channel 2 thru 6
MRF262	6.25	MWA130	8.08	34 dB gain 2.5 - 3 dB noise
MRF314	12.20	MWA210	7.46	Warranty for 6 months
MRF406	11.33	MWA220	8.08	Model HMR II with dish antenna
MRF412	20.65	MWA230	8.62	Complete Receiver and Power Supply
MRF421	27.45	MWA310	8.08	\$225.00 (does not include coax)
MRF422A	38.25	MWA320	8.62	4 foot Yagi antenna only
MRF422	38.25	MWA330	9.23	\$39.99
MRF428	38.25			Downconverter Kit - PCB and parts
MRF428A	38.25	TUBES		\$69.95
MRF426	8.87	6KD6	\$ 5.00	Power Supply Kit - Box, PCB and parts
MRF426A	8.87	6LQ6/6JE6	6.00	\$49.99
MRF449	10.61	6MJ6/6LQ6/6JE6C	6.00	Downconverter assembled
MRF449A	10.61	6LF6/6MH6	5.00	\$79.99
MRF450	11.00	12BY7A	4.00	Power Supply assembled
MRF450A	11.77	2E26	4.69	\$59.99
MRF452	15.00	4X150A	29.99	Complete Kit with Yagi antenna
MRF453	13.72	4CX250B	45.00	\$109.99
MRF454	21.83	4CX250R	69.00	REPLACEMENT PARTS
MRF454A	21.83	4CX300A	109.99	MRF901 \$ 3.99
MRF455	14.08	4CX350A/8321	100.00	MBD101 1.29
MRF455A	14.08	4CX350F/J/8904	100.00	.001 Chip Caps 1.00
MRF472	2.50	4CX1500B/8660	300.00	Power supply PCB 4.99
MRF474	3.00	811A	20.00	Downconverter PCB 19.99
MRF475	2.90	6360	4.69	
MRF476	2.25	6939	7.99	NEW ASCII ENCODED KEYBOARDS
MRF477	10.00	6146	5.00	110 Keys Numeric and Cursor Pad
MRF485	3.00	6146A	5.69	No data available \$19.99
MRF492	20.40	6146B/8298	7.95	
MRF502	.93	6146W	12.00	86 PIN MOTOROLA BUS EDGE CONNECTORS
MRF604	2.00	6550A	8.00	Gold plated contacts
MRF629	3.00	8908	9.00	Dual 43/86 pin .156 spacing
MRF648	26.87	8950	9.00	Solder tail for PCB \$3.00 each
MRF901	3.99	4-400A	71.00	
MRF902	9.41	4-400C	80.00	CONTINUOUS TONE BUZZERS
MRF904	3.00	572B/T160L	44.00	12 VDC \$2.00 each
MRF911	4.29	7289	9.95	
MRF5176	11.73	3-1000Z	229.00	110 VAC MUFFIN FANS
MRF8004	1.39	3-500Z	129.99	New \$11.95 Used \$5.95
BFR90	1.00			
BFR91	1.25	TO-3 TRANSISTOR SOCKETS		PL-259 TERMINATION 52 Ohm 5 Watts
BFR96	1.50	Phenolic type 6/\$1.00		\$1.50 each

NO ORDERS UNDER \$10

SEMICONDUCTORS SURPLUS

2822 North 32nd Street, #1 • Phoenix, Arizona 85008 • Phone 602-956-9423 ✓64

2N2857JAN	\$ 2.50	2N6097	\$28.00
2N2949	3.60	2N6166	38.00
2N2947	15.00	2N6368	22.99
2N2950	4.60	2N6439	40.00
2N3375	8.00	A210/MRF517	2.00
2N3553	1.57	BLY38	5.00
2N3818	5.00	40280/2N4427	1.10
2N3866	1.00	40281/2N3920	7.00
2N3866JAN	2.50	40282/2N3927	10.48
2N3866JANTX	4.00		
2N3925	10.00	NE555V TIMERS	
2N3948	2.00	39¢ each or 10/\$3.00	
2N3950	25.00		
2N3959	3.00	NEW DUAL COLON LED	
2N3960JANTX	10.00	69¢ each or	
2N4072	1.60	10/\$5.00	
2N4427	1.10		
2N4429	7.00	HEP170 1000 PIV	
2N4877	1.00	2.5 Amps 25¢ each or	
2N4959	2.00	100/\$15.00	
2N4976	15.00		
2N5070	8.00	HIGH VOLTAGE CAPS	
2N5071	15.00	420 MFD @ 400 VDC OR	
2N5108	4.00	600 MFD @ 400 VDC	
2N5109	1.50	\$6.99 each	
2N5179	1.00		
2N5583	4.00	NEW ROTRON BISCUIT FANS	
2N5589	6.00	Model BT2A1 115 VAC	
2N5590	8.00	\$12.99 each	
2N5591	11.00		
2N5635	5.44	TORIN TA700 FANS NEW	
2N5636	11.60	Model A30340	
2N5637	20.00	230 VAC @ .78 Amps	
2N5641	5.00	Will also work on 115 VAC	
2N5643	14.00	\$29.99 each	
2N5645	10.00		
2N5842	8.00	DOOR KNOB CAPS	
2N5849	20.00	470 pf @ 15 KV \$3.99 each	
2N5942	40.00	Dual 500 pf @ 15 KV 5.99 each	
2N5946	14.00	680 pf @ 6 KV 3.99 each	
2N5862	50.00	800 pf @ 15 KV 3.99 each	
2N6080	7.00	1000 pf @ 20 KV 5.00 each	
2N6081	10.00	2700 pf @ 40 KV 5.99 each	
2N6082	11.00		
2N6083	13.00	NEW & USED BCD SWITCHES	
2N6084	14.00	3 switch with end plates	
2N6095	11.00	New \$8.99	
2N6096	20.00	Used \$6.95	

ORDERING INSTRUCTIONS

Check, money order, or credit cards welcome. (Mastercharge and VISA only) No personal checks or certified personal checks for foreign countries accepted. Money order or cashiers check in U.S. funds only. Letters of credit are not acceptable.

Minimum shipping by UPS is \$2.35 with insurance. Please allow extra shipping charges for heavy or long items.

All parts returned due to customer error will be subject to a 15% restock charge.

If we are out of an item ordered, we will try to replace it with an equal or better part unless you specify not to, or we will back order the item, or refund your money.

PRICES ARE SUBJECT TO CHANGE WITHOUT NOTICE. Prices superseade all previously published. Some items offered are limited to small quantities and are subject to prior sale.

We now have a toll free number but we ask that it be used for CHARGE ORDERS ONLY. If you have any questions please use our other number. We are open from 8:00 a.m. - 5:00 p.m. Monday thru Saturday.

Our toll free number for orders only is 800-528-3611.

JUMBO LED's

Red	8/\$1.00
Clear	6/\$1.00
Yellow	6/\$1.00
Green	6/\$1.00
Amber	6/\$1.00

MEDIUM LED's

Red	6/\$1.00
Green	6/\$1.00

NEW G.E. OPTO COUPLERS 4N26
69¢ each or 10/\$5.00

MICRO-MINI WATCH CRYSTALS
32.768 Hz \$3.00 each

NEW 2 inch ROUND SPEAKERS
100 Ohm coil 99¢ each

PLASTIC TO-3 SOCKETS 4/\$1.00

NO ORDERS UNDER \$10

INTRODUCING SONY'S NEW DIGITAL DIRECT ACCESS RECEIVER!

A Whole New Breed Of Radio

Innovative design. Advanced technology. Digital key-touch tuning. The ICF-2001. It's a whole new breed of radio. A receiver that supplants the conventional multi-band concept, receiving a wide amplitude-modulated frequency range—shortwave, mediumwave and most longwave broadcasts. Plus FM, SSB and CW. Even more important, the 2001 replaces the ordinary tuning knob and dial with a direct-access tuning keyboard and a Liquid Crystal Display (LCD) for digital frequency readout. Which make the unit as easy to use as a pocket calculator. Instant, direct-access tuning modes and six memory-station presets assure maximum ease of use. And the quartz-crystal, frequency-synthesized circuitry behind them assures outstanding reception. Reception of local broadcasts and exciting news, music, sports, entertainment and information from around the world. You'll get the inside, local news stories from foreign countries... exclusive coverage of world sports events... plus everything from informal "ham" to marine communications. All at your fingertips.

Key-Touch Tuning

To tune a station manually, you simply punch in the station frequency numerals on the direct-access, digital tuning keyboard. Press the "Execute" key and the command is entered, the station is received and LCD readout confirms tuning. If you punch in an incorrect frequency by mistake, the ICF-2001 tells you to "Try Again" by flashing those words on the display. The instant, fingertip tuning provides total accuracy and convenience. And the LCD digital frequency display confirms the exact, drift-free signal reception.

Automatic Scanning

In auto-scan mode, the tuner can be set for continuous scanning of a given frequency range, which you set by means of upper and lower limit keys designated "L₁" and "L₂." You may want to scan an entire frequency range. For instance, the 76 to 108 MHz FM spectrum. If you want scanning to stop at any strong signal—one that reads "4" or "5" on the LED signal-strength indicator—switch on "Scan Auto Stop." For continuous scanning, leave the switch off, and just press the "Start/Stop" key to listen to a station or resume scanning.

Manual Tuning

Like the auto-scanning mode, manual tuning is useful for quick signal searching when you don't know particular station frequencies within a given range. You simply press the "Up" or "Down" key, and the tuner does the searching for you. And if you press the "Fast" key at the same time, the scanning rate increases for especially rapid station location. When you hear a broadcast you want to receive, just release the keys for instant reception, pressing the "Up" or "Down" key again if necessary for exact tuning.

Memory Presets

After you've tuned a station using punch-in, key-touch tuning or either scanning mode, you can enter it in the 2001's memory for instant, one-touch preset reception. Which means no retuning hard-to-find foreign broadcasts. Plus instant access to your favorite local stations for music and news. Six preset buttons allow up to six stations—in any wave range—to be memorized. And there's LCD digital readout of the memory buttons being used on each band. What's more, the upper and lower limit keys can be used as memory presets when they're not being used for scanning, allowing a total of eight frequencies to be memorized for instant, one-touch reception.



Frequency Synthesis

The 2001's direct-access tuning and outstanding reception quality are made possible by the unit's all-band quartz-crystal, PLL frequency synthesis. Instead of the conventional analog tuning system, with its variable tuning capacitor, the 2001 incorporates an LSI and a quartz-crystal reference oscillator. Which means that the local-oscillator frequencies used in superheterodyning are locked to the "synthesized" quartz reference frequencies. The result is the utmost in tuning stability, without a trace of tuning drift. In addition, dual-conversion superheterodyning for AM assures exceptionally clean, clear reception across the entire 150-to-29,999kHz spectrum.

Features

- FM/AM/SSB/CW/wide spectrum coverage
- Dual-conversion superheterodyne circuitry of AM assures high sensitivity and interference rejection
- Quartz-crystal, phase-locked-loop frequency synthesis for all bands assures the utmost tuning stability, without a trace of tuning drift
- Direct-access, digital tuning keyboard and LCD digital frequency readout for quick, key-touch station selection—maximum accuracy and ease of use
- Manual tuning and automatic scanning for effortless signal searching, easy DXing
- 6-station presets, plus 2 auxiliary presets, for instant reception of memorized stations on any band—plus LCD memory indication.
- 5-step LED signal-strength indicator
- Local/Normal/DX sensitivity selector for AM
- SSB/CW compensator for low-distortion reception
- Telescopic antenna, plus external antenna included
- 4" speaker for full, rich sound
- Slide-bar bass and treble controls
- Sleep timer—with LCD readout—can be set in 10-minute increments for up to 90 minutes of play before automatic radio shut-off

Only **\$299**⁹⁵

Plus \$5.00 S&H (Cont'l U.S.A. Only)



PHONE: (312) 848-6777



SPECTRONICS, INC. — 1009 GARFIELD ST., OAK PARK, ILL.-60304

BULLET ELECTRONICS

P.O. Box 401244-E

Garland, TX. 75040

(214) 278-3553

The Greatest Breakthrough In Electronic Music Ever!

New!
The
Super Music Maker
REVISION 2
\$24.95
(Basic Kit)

Does not include speaker switches or 2708 ROM.

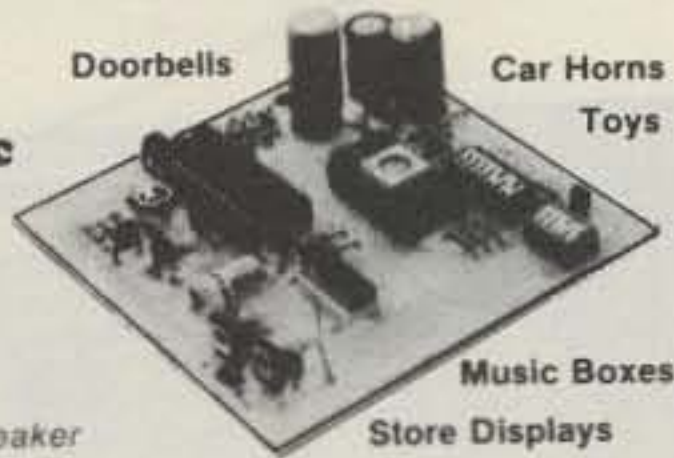

Now you can play hundreds of songs using the Bullet Super Music Maker. The unit features a single factory programmed microprocessor IC that comes with 20 pre-programmed short tunes. By adding the additional PROMS (2708's) the system can be expanded to play up to 1000 notes per PROM. Just think... a compact electronic instrument that will play dozens, hundreds or even thousands of selections of music. The kit comes with all electronic components (less the PROM), and a drilled, plated and screened PC Board which measures 4" x 4 1/4". The 7 watt amplifier section is on the same PC board and drives an 8 ohm speaker (not included), from a whisper to ear splitting volume. Since the unit works on 12 VDC or 12 VAC*, vehicle or portable operation is possible. **What do you get for \$24.95? Everything but a speaker, transformer, case, switches, and PROM.** Additional 2708 albums containing popular tunes are available for \$15.00 each or you can program your own PROMS using information provided with the kit instructions. Lists of available PROM albums are available on request. (Note: Unit plays electronic music one note at a time, it is not possible to play chords or a melody with harmony simultaneously.)

- * Envelope control gives decay to notes.
- * "Next tune" feature allows sequential playing of all songs.
- * On board inverter allows single voltage (+12) operation.

OPTIONAL ACCESSORIES

DIP Switches	One 8 pos., One 5 pos.	2.00/Set
(Can be directly soldered to PC Bd. to access tunes)		
Rotary Switches	Two 5 position	2.00/Set
(For remote wiring to PC Bd. to access tunes)		
Attractive Black Plastic Case		6.50
Wallplug Transformer		3.00
(For operation on 117VAC house voltage)		

Super Value Power Transformer

Well made, open frame transformer with mounting ears. Build a +5 and ±12 supply with inexpensive parts. Free schematics of several designs. Primary 117VAC. SEC #1 15VAC @ .5A SEC #2 15 VAC @ .5A SEC #3 8VAC @ 2.5A **\$2.95**
ORDER: BET-0005

7 Watt Audio Amp Kit \$5.95

SMALL, SINGLE, HYBRID IC AND COMPONENTS FIT ON A 2" x 3" PC BOARD (INCLUDED). RUNS ON 12VDC. GREAT FOR ANY PROJECT THAT NEEDS AN INEXPENSIVE AMP. LESS THAN 3% THD @ 5 WATTS. COMPATIBLE WITH SE-01 SOUND KIT.

Overvoltage Protection Kit \$6.95

Protect your expensive equipment from overvoltage conditions. Every computer should have one! Works with any fused DC power source from 10 to 20 volts up to 25 amps.

AY3-8910 PROGRAMMABLE SOUND GENERATOR

The AY3-8910 is a 40 pin LSI chip with three oscillators, three amplitude controls, programmable noise generator, three mixers, an envelope generator, and three D/A converters that are controlled by 8 BIT WORDS. No external pots or caps required. This chip hooked to an 8 bit microprocessor chip or Buss (8080, Z80, 6800 etc.) can be software controlled to produce almost any sound. It will play three note chords, make bangs, whistles, sirens, gunshots, explosions, bleats, whines, or grunts. In addition, it has provisions to control its own memory chips with two IO ports. The chip requires +5V @ 75ma and a standard TTL clock oscillator. A truly incredible circuit.

12.95 W/Basic Spec Sheet (4 pages)
60 page manual with S-100 interface instructions and several programming examples. **\$3.00 extra**

ZULU II CLOCK KIT X-RATED!

WITH CALENDAR AND NOX™ CIRCUIT

19.95

LESS CASE ACCESSORIES

Custom High Impact Molded Case with Ruby Lens. Available in Blue or Tan.

\$6.50

117 VAC to 12 VAC Transformer.

\$1.35

*9V Battery Not Included

X-TRA VALUE: All the components and high quality plated G-10 PC Boards are provided.

X-TRA CARE IN DESIGN: Easy Assembly! Large open layout.

X-CELLENCE IN IDEAS: 5 years of designed products for the amateur radio market.

X-CELLENCE IN INSTRUCTIONS: Clear step-by-step instructions with quality illustrations and schematic.

X-TRA FEATURES: There has never been a clock kit with so many features — at any price!

- Unit operates on either 12 VAC or 12 VDC.
- On board QUARTZ XTAL TIMEBASE or 60Hz AC line freq. can be used.
- Automatic BATTERY BACKUP*
- Reads true 24 HOUR TIME and 31 DAY CALENDAR.
- Unique NOX™ CIRCUIT activates readouts with a handclap followed by the date for 4 seconds. Or they can be turned on constantly.
- When used mobile readouts blank when ignition is off.
- Special NOISE SUPPRESSION and battery reversal circuits.
- Bright 1/2" LED's show hours, minute and seconds.

Sound Effects Kit 18.50

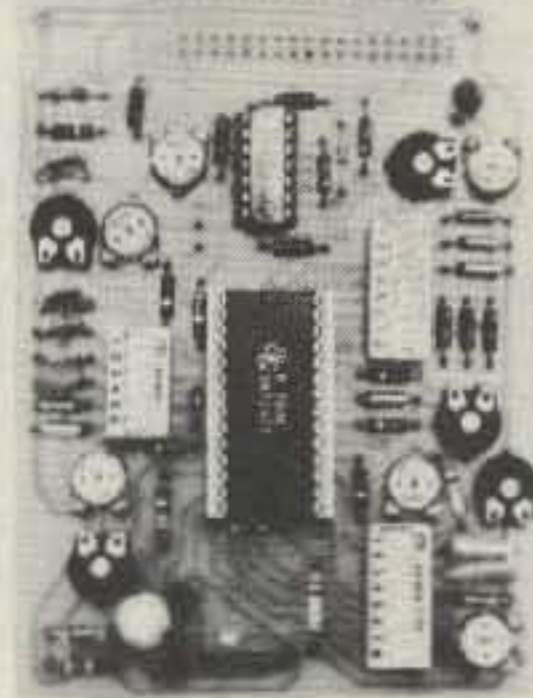

The SE-01 Sound Effects Kit is a complete kit; all you need to build a programmable sound effects machine except a battery and speaker. Our kit is designed to really ring out the TI 76477 Sound Chip. Only the SE-01 provides you with additional circuitry that includes a PULSE GENERATOR, MUX OSCILLATOR and COMPARATOR to make more complex sounds a snap. We help you in building the kit with a clear, easy-to-follow construction manual and we show you how to easily program the unit. Other dealers will sell you the chip or a "kit" of parts but you are on your own to do the most difficult part...make neat sounds! Within a short time after you build the SE-01 you can easily create Gunshots, Explosions, Space Sounds, Steam Trains and much more. We think the Bullet SE-01 is the best deal on the market but don't ask us. — ask the 15,000 happy SE-01 owners!

Complete Kit With Quality Plated PC Board **\$18.50**
(Less battery & speaker)

AUTO/VAN CLOCK KIT 16.95

- 12 Hr. Format
- 6 Digit 1/2" LED Readouts
- Quartz XTAL Timebase
- Alarm & Snooze Options
- Noise Filtering
- Easy Assembly • 12 VDC
- 4 5/8" x 3" x 1 1/2"
- All Parts!

ULTRASONIC RELAY KIT

Invisible Beam Works Like A Photo Electric Eye. COMPLETE KIT. All Parts & PC Board. Use Up To 25 Ft. Apart. **\$21.50**

Optional entry delay and Alarm Timeout Circuit will source or sink up to 200 MA DC.

\$3.95

PARTS

LM3046	(CA3046) Xistor Array	.75
RCA 40430	400V 6A TRIAC TO-66	.75
LM567	Tone Decoder	.99
CD4046	PLL CMOS	.99
LM3302	Quad Comparator	.89
2SC 1849	High Freq. NPN TO-92	6/1.00
MPS A 20	NPN General Purpose	8/1.00
TL490	Bar/Graph Driver w/specs	2.50
7812	12V 1A Regulator	.99
7805	5V 1A Regulator	.99
78M05	5V 1/2A Reg TO-5 (Hse #)	.60
LM3911	Temp. Transducer w/specs	1.10
555	Timer IC	.49
2N6028	P.U.T. w/specs	.50
IL-1	Opto Isolator w/specs	.60
LM380	2W Audio IC w/specs	.50
LM377	Dual LM380 w/specs	1.09
TIP-30	PNP Power TO-220	3/1.00
SCR	Sensitive Gate 200V 4A	7/1.00
SCR	Sensitive Gate 600V 4A RCA	3/1.00

GE ST-2	Trigger diode for tracs in	
DIAC	AC phase control operation	.29

TO-3 P.C. BOARD HEATSINK

Perfect for power transistors, or 309 and 340K series voltage regulators.



3/1.10

Thermoloy H6014 Black Anodized

THE PERFECT TRANSFORMER

117VAC primary, 12VAC secondary @ 200ma Great for all your CMOS, or low power TTL projects. PC board mount. **ORDER: 99¢ ea. 3/\$2.50 XFMR 03**
Size: 1.5" W x 1.25" D x 1.25" H

Special Purchase 2N3055



115W NPN POWER TRANSISTOR TO-3 Most popular transistor for power supplies, audio amps, switching, etc.

Limit 20 per customer **50¢ Each**

★ CALL OR WRITE TODAY FOR FREE CATALOG ★

- ★ NO C.O.D.
- ★ SEND CHECK, M.O., OR CREDIT CARD #
- ★ PHONE ORDERS ACCEPTED ON VISA/MASTER CHARGE ONLY (214) 278-3553

P
O
L
I
C
I
E
S

- ★ ADD 5% FOR SHIPPING
- ★ ORDERS UNDER \$10 ADD .75 HANDLING
- ★ TEX. RES. ADD 5% TAX
- ★ FOREIGN ORDERS (EXCEPT CANADA) ADD 10% (20% FOR AIRMAIL).

ramsey

the first name in Counters!



9 DIGITS 600 MHz \$129⁹⁵ WIRED

PRICES:

CT-90 wired, 1 year warranty	\$129.95
CT-90 Kit, 90 day parts warranty	109.95
AC-1 AC adapter	3.95
BP-1 Nicad pack + AC Adapter/Charger	12.95
O.V.1. Micro-power Oven time base	49.95
External time base input	14.95

The CT-90 is the most versatile, feature packed counter available for less than \$300.00! Advanced design features include: three selectable gate times, nine digits, gate indicator and a unique display hold function which holds the displayed count after the input signal is removed! Also, a 10MHz TCXO time base is used which enables easy zero beat calibration checks against WWV. Optionally, an internal nicad battery pack, external time base input and Micro-power high stability crystal oven time base are available. The CT-90, performance you can count on!

SPECIFICATIONS:

Range:	20 Hz to 600 MHz
Sensitivity:	Less than 10 MV to 150 MHz Less than 50 MV to 500 MHz
Resolution:	0.1 Hz (10 MHz range) 1.0 Hz (60 MHz range) 10.0 Hz (600 MHz range)
Display:	9 digits 0.4" LED
Time base:	Standard-10,000 mHz, 1.0 ppm 20-40°C, Optional Micro-power oven-0.1 ppm 20-40°C
Power:	8-15 VAC @ 250 ma

7 DIGITS 525 MHz \$99⁹⁵ WIRED



SPECIFICATIONS:

Range:	20 Hz to 525 MHz
Sensitivity:	Less than 50 MV to 150 MHz Less than 150 MV to 500 MHz
Resolution:	1.0 Hz (5 MHz range) 10.0 Hz (50 MHz range) 100.0 Hz (500 MHz range)
Display:	7 digits 0.4" LED
Time base:	1.0 ppm TCXO 20-40°C
Power:	12 VAC @ 250 ma

The CT-70 breaks the price barrier on lab quality frequency counters. Deluxe features such as; three frequency ranges - each with pre-amplification, dual selectable gate times, and gate activity indication make measurements a snap. The wide frequency range enables you to accurately measure signals from audio thru UHF with 1.0 ppm accuracy - that's .0001%! The CT-70 is the answer to all your measurement needs, in the field, lab or ham shack.

PRICES:

CT-70 wired, 1 year warranty	\$99.95
CT-70 Kit, 90 day parts warranty	84.95
AC-1 AC adapter	3.95
BP-1 Nicad pack + AC adapter/charger	12.95

7 DIGITS 500 MHz \$79⁹⁵ WIRED



PRICES:

MINI-100 wired, 1 year warranty	\$79.95
MINI-100 Kit, 90 day part warranty	59.95
AC-Z Ac adapter for MINI-100	3.95
BP-Z Nicad pack and AC adapter/charger	12.95

Here's a handy, general purpose counter that provides most counter functions at an unbelievable price. The MINI-100 doesn't have the full frequency range or input impedance qualities found in higher price units, but for basic RF signal measurements, it can't be beat! Accurate measurements can be made from 1 MHz all the way up to 500 MHz with excellent sensitivity throughout the range, and the two gate times let you select the resolution desired. Add the nicad pack option and the MINI-100 makes an ideal addition to your tool box for "in-the-field" frequency checks and repairs.

SPECIFICATIONS:

Range:	1 MHz to 500 MHz
Sensitivity:	Less than 25 MV
Resolution:	100 Hz (slow gate) 1.0 KHz (fast gate)
Display:	7 digits, 0.4" LED
Time base:	2.0 ppm 20-40°C
Power:	5 VDC @ 200 ma

8 DIGITS 600 MHz \$159⁹⁵ WIRED



SPECIFICATIONS:

Range:	20 Hz to 600 MHz
Sensitivity:	Less than 25 mv to 150 MHz Less than 150 mv to 600 MHz
Resolution:	1.0 Hz (60 MHz range) 10.0 Hz (600 MHz range)
Display:	8 digits 0.4" LED
Time base:	2.0 ppm 20-40°C
Power:	110 VAC or 12 VDC

The CT-50 is a versatile lab bench counter that will measure up to 600 MHz with 8 digit precision. And, one of its best features is the Receive Frequency Adapter, which turns the CT-50 into a digital readout for any receiver. The adapter is easily programmed for any receiver and a simple connection to the receiver's VFO is all that is required for use. Adding the receiver adapter in no way limits the operation of the CT-50, the adapter can be conveniently switched on or off. The CT-50, a counter that can work double-duty!

PRICES:

CT-50 wired, 1 year warranty	\$159.95
CT-50 Kit, 90 day parts warranty	119.95
RA-1, receiver adapter kit	14.95
RA-1 wired and pre-programmed (send copy of receiver schematic)	29.95

DIGITAL MULTIMETER \$99⁹⁵ WIRED



PRICES:

DM-700 wired, 1 year warranty	\$99.95
DM-700 Kit, 90 day parts warranty	79.95
AC-1, AC adaptor	3.95
BP-3, Nicad pack + AC adapter/charger	19.95
MP-1, Probe kit	2.95

The DM-700 offers professional quality performance at a hobbyist price. Features include: 26 different ranges and 5 functions, all arranged in a convenient, easy to use format. Measurements are displayed on a large 3 1/2 digit, 1/2 inch LED readout with automatic decimal placement, automatic polarity, overrange indication and overload protection up to 1250 volts on all ranges, making it virtually goof-proof! The DM-700 looks great, a handsome, jet black, rugged ABS case with convenient retractable tilt bail makes it an ideal addition to any shop.

SPECIFICATIONS:

DC/AC volts:	100uV to 1 KV, 5 ranges
DC/AC current:	0.1uA to 2.0 Amps, 5 ranges
Resistance:	0.1 ohms to 20 Megohms, 6 ranges
Input impedance:	10 Megohms, DC/AC volts
Accuracy:	10.1% basic DC volts
Power:	4 'C' cells

AUDIO SCALER

For high resolution audio measurements, multiplies UP in frequency.

- Great for PL tones
- Multiplies by 10 or 100
- 0.01 Hz resolution!

\$29.95 Kit \$39.95 Wired

ACCESSORIES

Telescopic whip antenna - BNC plug	\$ 7.95
High impedance probe, light loading	15.95
Low pass probe, for audio measurements	15.95
Direct probe, general purpose usage	12.95
Tilt bail, for CT 70, 90, MINI-100	3.95
Color burst calibration unit, calibrates counter against color TV signal	14.95

COUNTER PREAMP

For measuring extremely weak signals from 10 to 1,000 MHz. Small size, powered by plug transformer-included.

- Flat 25 db gain
- BNC Connectors
- Great for sniffing RF with pick-up loop

\$34.95 Kit \$44.95 Wired

ramsey electronic's, inc.
2575 Baird Rd. Penfield, NY 14526



PHONE ORDERS
CALL 716-586-3950

HERMS

Satisfaction guaranteed - examine for 10 days, if not pleased return in original form for refund. Add 5% for shipping insurance to a maximum of \$10. Overseas add 15%. COD add \$2. Orders under \$10. add \$1.50. NY residents, add 7% tax.

Save on Scanners! NEW Rebates!

Communications Electronics,™ the world's largest distributor of radio scanners, celebrates Christmas early with big savings on Bearcat synthesized scanners. Electra Company, the manufacturers of Bearcat brand scanners is offering consumer rebates on their fantastic line of crystalless scanners purchased between September 15 and November 15, 1980.

We give you excellent service because CE distributes more scanners worldwide than anyone else. Our warehouse facilities are equipped to process thousands of scanner orders every week. We also export scanners to over 300 countries and military installations. Most items are in stock for quick shipment. Do your Christmas scanner shopping early and order today from CE!

Bearcat® 300

The Ultimate Synthesized Scanner!
List price \$519.95/CE price \$329.00/\$20.00 rebate
Your final cost is a low \$309.00

4-Band, 50 Channel • Service Search • No-crystal scanner • AM Aircraft and Public Service bands • Priority Channel • AC/DC Bands: 32-50, 118-136 AM, 144-174, 421-512 MHz.
The new Bearcat 300 is the most advanced automatic scanning radio that has ever been offered to the public. The Bearcat 300 uses a bright green fluorescent digital display, so it's ideal for mobile applications. The Bearcat 300 now has these added features: Service Search, Display Intensity Control, Hold Search and Resume Search keys, Separate Band keys to permit lock-in/lock-out of any band for more efficient service search.

Bearcat® 250

List price \$419.95/CE price \$259.00/\$20.00 rebate
Your final cost is a low \$239.00

50 Channels • Crystalless • Searches Stores • Recalls • Digital clock • AC/DC Priority Channel • 3-Band • Count Feature.
Frequency range 32-50, 146-174, 420-512 MHz.
The Bearcat 250 performs any scanning function you could possibly want. With push button ease you can program up to 50 channels for automatic monitoring. Overseas customers should order the Bearcat 250FB at \$349.00 each. This model is like a Bearcat 250, but designed for international operation with 220 V AC/12 V DC power supply and 66-88 MHz low band coverage instead of 32-50 MHz.

Bearcat® 220

List price \$419.95/CE price \$259.00/\$20.00 rebate
Your final cost is a low \$239.00

Aircraft and public service monitor. Frequency range 32-50, 118-136 AM, 144-174, 420-512 MHz.
The Bearcat 220 is one scanner which can monitor all public service bands plus the exciting AM aircraft band channels. Up to twenty frequencies may be scanned at the same time. Overseas customers should order the Bearcat 220FB at \$349.00 each. This model is like a Bearcat 220, but designed for international operation with 220 V AC/12 V DC power supply and 66-88 MHz low band coverage instead of 32-50 MHz.

NEW! Bearcat® 210XL

List price \$319.95/CE price \$209.00/\$20.00 rebate
Your final cost is a low \$189.00

18 Channels • 3 Bands • Crystalless • AC/DC
Frequency range: 32-50, 144-174, 421-512 MHz.
The Bearcat 210XL scanning radio is the second generation scanner that replaces the popular Bearcat 210 and 211. It has almost twice the scanning capacity of the Bearcat 210 with 18 channels plus dual scanning speeds and a bright green fluorescent display.



NEW! 50-Channel Bearcat 300

FREE Bearcat® Rebate Offer

Get a coupon good for a \$20 rebate when you purchase a Bearcat 300, 250, 220 or 210XL. \$10 rebate on models 211, 210 and 160. To get your rebate, mail this coupon with your original dated sales receipt and the Bearcat model number from the carton to Electra. You'll receive your rebate in four to six weeks. Offer valid only on purchases made between September 15, 1980 and November 15, 1980. All requests must be postmarked by November 29, 1980. Limit of one rebate per household. Coupon must accompany all rebate requests and may not be reproduced. Offer good only in the U.S.A. Void where taxed or prohibited by law. Resellers, companies, clubs and organizations—both profit and non-profit—are not eligible for rebates. Employees of Electra Company, their advertising agencies, distributors and retailers of Bearcat Scanners are also not eligible for rebates. Please be sure to send in the correct amount for your scanner. Pay the listed CE price in this ad. Do not deduct the rebate amount since your rebate will be sent directly to you from Electra. Orders received with insufficient payments will not be processed and will be returned.

NEW! Bearcat® 160

List price \$279.95/CE price \$189.00/\$10.00 rebate
Your final cost is a low \$179.00

16 Channels • 3 Bands • AC only • Priority Dual Scan Speeds • Direct Channel Access
Frequency range: 32-50, 144-174, 440-512 MHz.
The Bearcat 160 presents a new dimension in scanning form and function. The keyboard is smooth. No buttons to punch. No knobs to turn. Instead, finger-tip pads provide control of all scanning operations, including On/Off, Volume and Squelch. Green easy to read fluorescent display.

NEW! Bearcat® 5/800 MHz

The world's first 800 MHz. scanner!
This is a new model. Shipments will begin in December, 1980.

List price \$179.95/CE price \$129.00
8 Crystal Channels • 4 Bands • AC only
Frequency range: 33-50, 144-174, 440-512, 806-870 MHz.
The Bearcat 5/800 MHz is the only scanner on the market today that offers coverage of the 800 MHz. public service band and the other public service bands. Individual channel lockout. Scan Delay. Manual Scan.

Bearcat® 5

List price \$129.95/CE price \$89.00
8 Crystal Channels • 3 Bands • AC only
Frequency range: 33-50, 146-174, 450-508 MHz.
The Bearcat 5 is a value-packed crystal scanner built for the scanning professional — at a price the first-time buyer can afford. Individual lockout switches.

Bearcat® Four-Six ThinScan™

List price \$179.95/CE price \$114.00
Frequency range: 33-47, 152-164, 450-508 MHz.
The incredible, new Bearcat Four-Six Thin Scan™ is like having an information center in your pocket. This three band, 6 channel crystal controlled scanner has patented Track Tuning on UHF. Scan Delay and Channel Lockout. Measures 2 1/4 x 6 1/4 x 1". Includes rubber ducky antenna. Order crystals for each channel. Made in Japan.

NEW! Fanon Slimline 6-HLU

List price \$169.95/CE price \$109.00
Low cost 6-channel, 3-band scanner!
The new Fanon Slimline 6-HLU gives you six channels of crystal controlled excitement. Unique Automatic Peak Tuning Circuit adjusts the receiver front end for maximum sensitivity across the entire UHF band. Individual channel lockout switches. Frequency range 30-50, 146-175 and 450-512 MHz. Size 2 1/4 x 6 1/4 x 1". Includes rubber ducky antenna. Order crystal certificates for each channel. Made in Japan.

NEW! Fanon Slimline 6-HL

List price \$149.95/CE price \$99.00
6-Channel performance at 4-channel cost!
Frequency range: 30-50, 146-175 MHz.
If you don't need the UHF band, get this model and save money. Same high performance and features as the model HLU without the UHF band. Order crystal certificates for each channel. Made in Japan.

FANON SCANNER ACCESSORIES

CHB-6 AC Adapter/Battery Charger \$15.00
CAT-6 Carrying case for Fanon w/Belt Clip \$15.00
AUC-3 Auto lighter adaptor/Battery Charger \$15.00

OTHER SCANNER ACCESSORIES

SP50 AC Adapter \$8.00
SP51 Battery Charger \$8.00
SP58 Carrying Case for Bearcat 4-6 ThinScan™ ... \$12.00
FB-E Frequency Directory for Eastern U.S.A. \$12.00
FB-W Frequency Directory for Western U.S.A. \$12.00
FFD Federal Frequency Directory for U.S.A. \$12.00
B-4 1.2 V AAA Ni-Cad's for ThinScan™ and Fanon ... \$9.00
A-135cc Crystal certificate \$3.00
Add \$3.00 shipping for all accessories ordered at the same time.

INCREASED PERFORMANCE ANTENNAS

If you want the utmost in performance from your scanner, it is essential that you use an external antenna. We have six base and mobile antennas specifically designed for receiving all bands. Order #A60 is a magnet mount mobile antenna. Order #A61 is a gutter clip mobile antenna. Order #A62 is a trunk-lip mobile antenna. Order #A63 is a 3/4 inch hole mount. Order #A64 is a 3/8 inch snap-in mount, and #A70 is an all band base station antenna. All antennas are \$30.00 and \$3.00 for UPS shipping in the continental United States.

TEST ANY SCANNER

Test any scanner purchased from Communications Electronics™ for 31 days before you decide to keep it. If for any reason you are not completely satisfied, return it in original condition with all parts in 31 days, for a prompt refund (less shipping/handling charges and rebate credits).

NEW! Regency® M400

List price \$379.95/CE price \$259.00
30 Channel • Synthesized • Service Search Digital clock • Digital timer • M100 styling Search/Store • Priority Channel • AC/DC
Frequency range: 30-50, 144-174, 440-512 MHz.
The new Regency M400 is a compact programmable FM monitor receiver for use at home or on the road.

OTHER REGENCY® SCANNERS
Touch K100 \$199.00
Touch M100 \$199.00

NEW! Telephone Products

Electra's cordless Freedom Phone does everything an ordinary phone does and more. Because it is cordless, you can take it anywhere, inside or outside—on the patio, by the pool, in the garage, in the workshop...even next door at the neighbor's.

Model FF-500 has pushbutton dialing. Rechargeable ni-cad batteries included. Battery low light. Secure feature. Telescopic antenna. Your cost is \$179.00. Model FF-1500 has the same features as the FF-500 but also includes a charger/cradle that allows the phone's handset to be recharged away from the base station. Your cost for this cordless phone is \$199.00. The model FF-3000 has all the standard features (except charger/cradle) plus interchangeable telescopic and rubber ducky antenna. Redial feature. Belt clip. Carrying case. Greater range. Your cost is \$229.00.

World Scanner Association™

The WORLD SCANNER ASSOCIATION is sponsored as a public service by Communications Electronics.™ When you join, you'll receive a one-year membership and our quarterly newsletter with scanner news and features. You'll also get a wallet I.D. card, an Official WSA Membership Certificate, and more. FREE classified ads for members so you can contact other scanner owners when you want to sell or buy a scanner. FREE membership in the WSA Buyer's Co-op. Your Co-op membership will allow you to get special discounts on scanners and scanner related products. Since the WSA Buyer's Co-op gives you group purchasing power, you can easily pay for your membership dues the first time you make a Co-op purchase. To join, send \$12.00 (\$20.00 outside U.S.A.) for your membership materials.

BUY WITH CONFIDENCE

To get the fastest delivery from CE of any scanner, send or phone your order directly to our Scanner Distribution Center.™ Be sure to calculate your price using the CE prices in this ad. Michigan residents please add 4% sales tax. Written purchase orders are accepted from approved government agencies and most well rated firms at a 10% surcharge for net 30 billing. All sales are subject to availability. All sales on accessories are final. Prices, terms and specifications are subject to change without notice. Out of stock items will be placed on backorder automatically unless CE is instructed differently. Most products that we sell have a manufacturer's warranty. Free copies of warranties on these products are available prior to purchase by writing to CE. International orders are invited with a \$20.00 surcharge for special handling in addition to shipping charges. All shipments are F.O.B. Ann Arbor, Michigan. No COD's please. Non-certified and foreign checks require five weeks bank clearance.

Mail orders to: Communications Electronics,™ Box 1002, Ann Arbor, Michigan 48106 U.S.A. Add \$6.00 per scanner or phone product for U.P.S. ground shipping, or \$12.00 for faster U.P.S. air shipping to some locations. If you have a Master Charge or Visa card, you may call anytime and place a credit card order. Order toll free in the U.S.A. 800-521-4414. If you are outside the U.S. or in Michigan, dial 313-994-4444. Dealer inquiries invited. All order lines at Communications Electronics™ are staffed 24 hours.

WSA,™ Scanner Distribution Center™ and CE logos are trademarks of Communications Electronics.™
† Bearcat and Freedom Phone are federally registered trademarks of Electra Company, a Division of Masco Corporation of Indiana.

‡ Regency is a federally registered trademark of Regency Electronics Inc.

Copyright © 1980 Communications Electronics™



854 Phoenix □ Box 1002 □ Ann Arbor, Michigan 48106 U.S.A.
Call TOLL-FREE (800) 521-4414 or outside U.S.A. (313) 994-4444

We're first with the best.™

7400		7400	
SN7400N	.25	SN74156N	.79
SN7401N	.20	SN74157N	.69
SN7402N	.25	SN74160N	.89
SN7403N	.25	SN74161N	.89
SN7404N	.25	SN74162N	.89
SN7405N	.25	SN74163N	.89
SN7406N	.25	SN74164N	.89
SN7407N	.25	SN74165N	.89
SN7408N	.25	SN74166N	1.25
SN7409N	.25	SN74167N	2.75
SN7410N	.25	SN74170N	1.95
SN7411N	.25	SN74172N	4.95
SN7412N	.25	SN74173N	1.35
SN7413N	.40	SN74174N	.99
SN7414N	.69	SN74175N	.89
SN7416N	.29	SN74176N	.79
SN7417N	.29	SN74177N	.79
SN7420N	.25	SN74179N	1.49
SN7421N	.29	SN74180N	.79
SN7422N	.45	SN74181N	2.25
SN7423N	.25	SN74182N	.79
SN7425N	.25	SN74184N	2.49
SN7426N	.25	SN74185N	2.49
SN7427N	.25	SN74190N	1.25
SN7429N	.39	SN74191N	1.25
SN7430N	.25	SN74192N	.89
SN7432N	.29	SN74193N	.89
SN7437N	.25	SN74194N	.89
SN7438N	.40	SN74195N	.69
SN7439N	.25	SN74196N	.89
SN7440N	.20	SN74197N	.89
SN7441N	.89	SN74198N	1.49
SN7442N	.99	SN74199N	1.49
SN7443N	1.10	SN74221N	1.25
SN7444N	1.10	SN74251N	.99
SN7445N	.89	SN74252N	1.95
SN7446N	.79	SN74253N	.79
SN7447N	.69	SN74254N	1.49
SN7448N	.79	SN74255N	1.49
SN7449N	.79	SN74256N	1.49
SN7450N	.20	SN74257N	1.49
SN7451N	.20	SN74258N	1.49
SN7452N	.20	SN74259N	1.49
SN7453N	.20	SN74260N	1.49
SN7454N	.20	SN74261N	1.49
SN7455N	.20	SN74262N	1.49
SN7456N	.20	SN74263N	1.49
SN7457N	.20	SN74264N	1.49
SN7458N	.20	SN74265N	1.49
SN7459N	.20	SN74266N	1.49
SN7460N	.20	SN74267N	1.49
SN7470N	.29	SN74268N	1.49

74LS		74LS	
74LS00	.29	74LS192	1.15
74LS01	.29	74LS193	1.15
74LS02	.29	74LS194	1.15
74LS03	.29	74LS195	1.15
74LS04	.29	74LS196	1.15
74LS05	.29	74LS197	1.15
74LS06	.29	74LS198	1.15
74LS07	.29	74LS199	1.15
74LS08	.29	74LS200	1.15
74LS09	.29	74LS201	1.15
74LS10	.29	74LS202	1.15
74LS11	.29	74LS203	1.15
74LS12	.29	74LS204	1.15
74LS13	.29	74LS205	1.15
74LS14	.29	74LS206	1.15
74LS15	.29	74LS207	1.15
74LS16	.29	74LS208	1.15
74LS17	.29	74LS209	1.15
74LS18	.29	74LS210	1.15
74LS19	.29	74LS211	1.15
74LS20	.29	74LS212	1.15
74LS21	.29	74LS213	1.15
74LS22	.29	74LS214	1.15
74LS23	.29	74LS215	1.15
74LS24	.29	74LS216	1.15
74LS25	.29	74LS217	1.15
74LS26	.29	74LS218	1.15
74LS27	.29	74LS219	1.15
74LS28	.29	74LS220	1.15
74LS29	.29	74LS221	1.15
74LS30	.29	74LS222	1.15
74LS31	.29	74LS223	1.15
74LS32	.29	74LS224	1.15
74LS33	.29	74LS225	1.15
74LS34	.29	74LS226	1.15
74LS35	.29	74LS227	1.15
74LS36	.29	74LS228	1.15
74LS37	.29	74LS229	1.15
74LS38	.29	74LS230	1.15
74LS39	.29	74LS231	1.15
74LS40	.29	74LS232	1.15
74LS41	.29	74LS233	1.15
74LS42	.29	74LS234	1.15
74LS43	.29	74LS235	1.15
74LS44	.29	74LS236	1.15
74LS45	.29	74LS237	1.15
74LS46	.29	74LS238	1.15
74LS47	.29	74LS239	1.15
74LS48	.29	74LS240	1.15
74LS49	.29	74LS241	1.15
74LS50	.29	74LS242	1.15
74LS51	.29	74LS243	1.15
74LS52	.29	74LS244	1.15
74LS53	.29	74LS245	1.15
74LS54	.29	74LS246	1.15
74LS55	.29	74LS247	1.15
74LS56	.29	74LS248	1.15
74LS57	.29	74LS249	1.15
74LS58	.29	74LS250	1.15
74LS59	.29	74LS251	1.15
74LS60	.29	74LS252	1.15
74LS61	.29	74LS253	1.15
74LS62	.29	74LS254	1.15
74LS63	.29	74LS255	1.15
74LS64	.29	74LS256	1.15
74LS65	.29	74LS257	1.15
74LS66	.29	74LS258	1.15
74LS67	.29	74LS259	1.15
74LS68	.29	74LS260	1.15
74LS69	.29	74LS261	1.15
74LS70	.29	74LS262	1.15
74LS71	.29	74LS263	1.15
74LS72	.29	74LS264	1.15
74LS73	.29	74LS265	1.15
74LS74	.29	74LS266	1.15
74LS75	.29	74LS267	1.15
74LS76	.29	74LS268	1.15
74LS77	.29	74LS269	1.15
74LS78	.29	74LS270	1.15
74LS79	.29	74LS271	1.15
74LS80	.29	74LS272	1.15
74LS81	.29	74LS273	1.15
74LS82	.29	74LS274	1.15
74LS83	.29	74LS275	1.15
74LS84	.29	74LS276	1.15
74LS85	.29	74LS277	1.15
74LS86	.29	74LS278	1.15
74LS87	.29	74LS279	1.15
74LS88	.29	74LS280	1.15
74LS89	.29	74LS281	1.15
74LS90	.29	74LS282	1.15
74LS91	.29	74LS283	1.15
74LS92	.29	74LS284	1.15
74LS93	.29	74LS285	1.15
74LS94	.29	74LS286	1.15
74LS95	.29	74LS287	1.15
74LS96	.29	74LS288	1.15
74LS97	.29	74LS289	1.15
74LS98	.29	74LS290	1.15
74LS99	.29	74LS291	1.15

74S		74S	
74S00	.50	74S244	1.25
74S01	.50	74S251	1.45
74S02	.50	74S252	1.45
74S03	.50	74S253	1.45
74S04	.50	74S254	1.45
74S05	.50	74S255	1.45
74S06	.50	74S256	1.45
74S07	.50	74S257	1.45
74S08	.50	74S258	1.45
74S09	.50	74S259	1.45
74S10	.50	74S260	1.45
74S11	.50	74S261	1.45
74S12	.50	74S262	1.45
74S13	.50	74S263	1.45
74S14	.50	74S264	1.45
74S15	.50	74S265	1.45
74S16	.50	74S266	1.45
74S17	.50	74S267	1.45
74S18	.50	74S268	1.45
74S19	.50	74S269	1.45
74S20	.50	74S270	1.45
74S21	.50	74S271	1.45
74S22	.50	74S272	1.45
74S23	.50	74S273	1.45
74S24	.50	74S274	1.45
74S25	.50	74S275	1.45
74S26	.50	74S276	1.45
74S27	.50	74S277	1.45
74S28	.50	74S278	1.45
74S29	.50	74S279	1.45
74S30	.50	74S280	1.45
74S31	.50	74S281	1.45
74S32	.50	74S282	1.45
74S33	.50	74S283	1.45
74S34	.50	74S284	1.45
74S35	.50	74S285	1.45
74S36	.50	74S286	1.45
74S37	.50	74S287	1.45
74S38	.50	74S288	1.45
74S39	.50	74S289	1.45
74S40	.50	74S290	1.45
74S41	.50	74S291	1.45
74S42	.50	74S292	1.45
74S43	.50	74S293	1.45
74S44	.50	74S294	1.45
74S45	.50	74S295	1.45
74S46	.50	74S296	1.45
74S47	.50	74S297	1.45
74S48	.50	74S298	1.45
74S49	.50	74S299	1.45
74S50	.50	74S300	1.45

CA-LINEAR		CA-LINEAR	
CA3013H	2.15	CA3065N	1.75
CA3023H	1.25	CA3066N	1.95
CA3029H	1.35	CA3130H	1.39
CA3046N	1.30	CA3140H	1.25
CA3059N	1.25	CA3160H	1.25
CA3060N	1.25	CA3401N	.59
CA3080H	1.25	CA3600N	3.50

CD-CMOS		CD-CMOS	
CD4000	.39	CD4082	.39
CD4001	.39	CD4093	.99
CD4002	.39	CD4098	2.49
CD4006	1.19	CD4506	.75
CD4007	.25	CD4507	.99
CD4009	.49	CD4508	3.95
CD4010	.49	CD4510	1.39
CD4011	.39	CD4511	1.29
CD4012	.25	CD4514	3.95
CD4013	.49	CD4515	2.95
CD4014	1.39	CD4516	1.49
CD4015	1.19	CD4518	1.79
CD4016	.59	CD4519	.89
CD4017	1.19	CD4520	1.39
CD4018	.99	CD4521	1.79
CD4019	.99	CD4522	1.79
CD4020	1.19	CD4523	1.95
CD4021	1.39	CD4524	2.79
CD4022	1.19	CD4525	11.95
CD4023	.79	CD4526	2.79
CD4024	.79	CD4527	2.49
CD4025	.23	CD4723	1.95
CD4026	2.95	CD4724	1.95
CD4027	.69	MC14409	14.95
CD4028	.89	MC14410	14.95
CD4029	1.49	MC14411	14.95
CD4030	.49	MC14412	11.95
CD4035	.39	MC14413	4.95
CD4040	1.49	MC14433	13.95

JE608 PROGRAMMER 2708 EPROM PROGRAMMER



The JE608 EPROM Programmer is a completely self-contained unit which is independent of computer control and requires no additional systems for its operation. The EPROM can be programmed from the Hexadecimal Keyboard or from a preprogrammed EPROM. The JE608 Programmer can program a programmed EPROM by the use of its internal RAM circuit. This will allow the user to test or program a program for a system, prior to programming a chip. Any changes in the program can be entered directly into the memory circuits with the Hexadecimal Keyboard so that reprogramming the entire program will not be necessary. The JE608 Programmer contains a Programmer Board with 25 IC's and including power supplies of: -5V, +5V, +12V and +28V. The Hexadecimal Keyboard and LED/TEST Switch Panel Board are separate assemblies within the system.

JE608K KIT \$399.95
JE608A Assembled and tested \$499.95

DISCRETE LEDES

XCS56R .200" red	5/51	MV50 .085" red	5/51	XC111R .190" red	5/51
XCS56G .200" green	4/51	XC209R .125" red	5/51	XC111G .190" green	4/51
XCS56Y .200" yellow	4/51	XC209G .125" green	4/51	XC111Y .190" yellow	4/51
XCS56C .200" clear	4/51	XC209Y .125" yellow	4/51	XC111C .190" clear	4/51
XC22R .200" red	5/51	XC526R .185" red	5/51		
XC22G .200" green	4/51	XC526G .185" green	4/51		
XC22Y .200" yellow	4/51	XC526Y .185" yellow	4/51		
MV10B .170" red	4/51	XC526C .185" clear	4/51		

INFRARED LED
 1/4" x 1/4" x 1/16" flat
 IRL - 5/51

DISPLAY LEDES

C.A. - Common Anode			C.C. - Common Cathode		
Type	Polarity	Ht Price	Type	Polarity	Ht Price
MAN 1	C.A.-red	.270 2.95	DL741	C.A.-red	.600 1.25
MAN 2	5x7 D.M.-red	.300 4.95	DL746	C.A.-red ± 1	.630 1.49
MAN 3	C.C.-red	.125 .25	DL747	C.A.-red	.600 1.49
MAN 52	C.A.-green	.300 1.25	DL750	C.C.-red	.600 1.49
MAN 54	C.C.-green	.300 1.25	DL33B	C.C.-red	.110 .35
MAN 71	C.A.-red	.300 .75	FND358	C.C. ± 1	.357 .99
MAN 72	C.A.-red	.300 .75	FND359	C.C.	.357 .75
MAN 74	C.C.-red	.300 1.25	FND363	C.C. (FND500)	.500 .99
MAN 82	C.A.-yellow	.300 .49	FND507	C.A. (FND510)	.500 .99
MAN 84	C.C.-yellow	.300 .99	HOSP-3401	C.A.-red	.800 1.50
MAN 3620	C.A.-orange	.300			

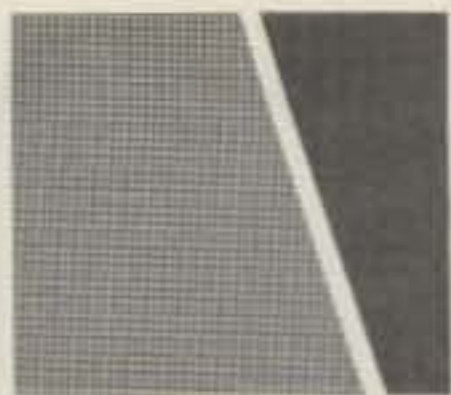

fact: ARMCHAIR COPY begins here!

The NEW Model 444D For: High/Low Impedance SSB/FM

The Model 444D incorporates all the tried-and-proven features that made Shure's Model 444 the recognized "standard" fixed-station microphone among serious amateurs. The 444D retains the Shure-designed, super-rugged CONTROLLED MAGNETIC® microphone element that lets you come across with "armchair copy"! Its unmatched performance characteristics include a tailored response for maximum voice intelligibility, PLUS...

DUAL IMPEDANCE—(150 ohms) Low & High. Impedance selector switch located on bottom of base.

FREE NAMEPLATE IMPRINTED WITH YOUR CALL LETTERS—Personalized nameplate with your station call letters.

ALL-NEW WIRING GUIDE—Provides user instructions for wiring the microphone to major manufacturers' ham equipment.

IMPROVED CONTROL BAR—Shure Million-Cycle push-to-talk (PTT) improved fingertip action actuates microphone and an external relay or control circuit.

VOX/NORMAL SWITCH—Defeats PTT switch, for VOX equipment requiring continuously "on" microphone. Located conveniently on bottom of base.

PROFESSIONAL BLACK FINISH—Sturdy, high impact ARMO-DUR® base and microphone case is metalized for RF shielding. It is comfortable to the touch in any temperature or humidity, and will not rust or deteriorate.

CONVENIENT INSTALLATION
—The coiled cable leads and push-to-talk switch are arranged to permit immediate hookup to transmitters with either isolated or grounded switching.

FREE!

Personalized
call letter
nameplate

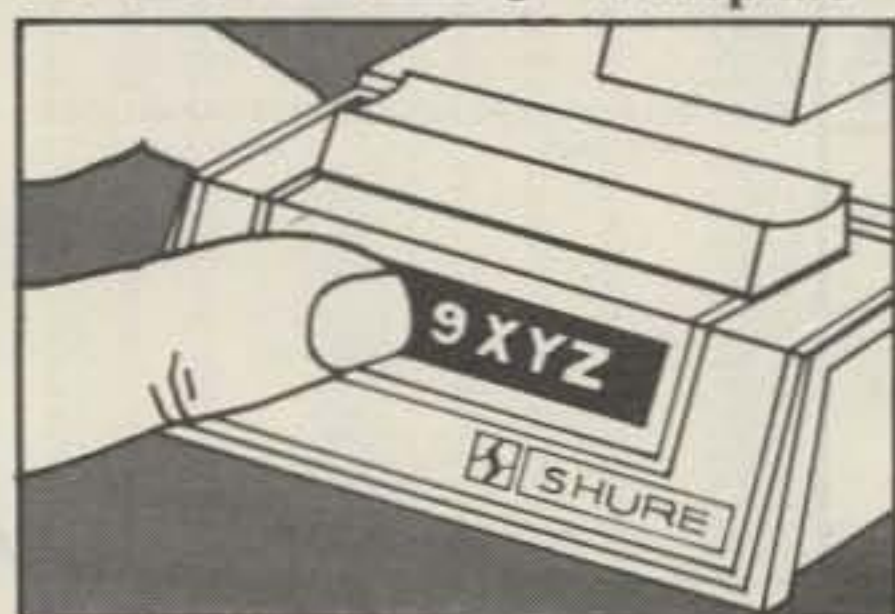

Intelligibility &
Reliability ✓ 396



Shure Brothers Inc., 222 Hartrey Ave., Evanston, IL 60204
In Canada: A. C. Simmonds & Sons Limited

Outside the U.S. or Canada, write to Shure Brothers Inc., Attn: Dept J6 for information on your local distributor.
Manufacturers of high fidelity components, microphones, sound systems and related circuitry.

Radio Bookshop

FOR THE NOVICE

NEW, UPDATED EDITIONS OF OUR FAMOUS NOVICE CLASS STUDY GUIDE AND NOVICE THEORY TAPES.

● **NOVICE STUDY GUIDE**—SG7357—Here is a completely new study guide and reference book for the potential ham. This is not a question/answer memorization course. Electronic and radio fundamentals are presented and explained in an easy-to-understand fashion, preparing the beginner for the Novice exam. Includes the latest FCC amateur regulations, as well as application forms. Easily the best path into the exciting world of ham radio! \$4.95.*

● **NOVICE THEORY TAPES**—CT7300—Startling Learning Breakthrough. You'll be astounded at how really simple the theory is when you hear it explained on these tapes. Three tapes of theory and one of questions and answers from the latest Novice exams give you the edge you need to breeze through your exam. 73 is interested in helping get more amateurs, so we're giving you the complete set of our tapes for the incredibly low price of **ONLY \$15.95.***

Scientists have proven that you learn faster by listening than by reading because you can play a cassette tape over and over in your spare time—even while you're driving! You get more and more info each time you hear it. You can't progress without solid fundamentals. These four hour-long tapes give you all the basics you'll need to pass the Novice exam easily. You'll have an understanding of the basics which will be invaluable to you for the rest of your life! Can you afford to take your Novice exam without first listening to these tapes? Set of 4—\$15.95.*

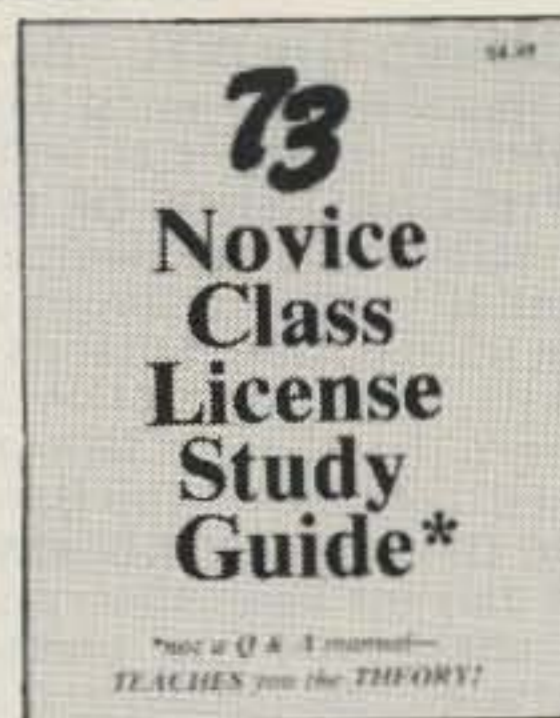

SPECIAL OFFER! BOTH NOVICE CLASS STUDY GUIDE AND NOVICE THEORY TAPES \$20.00 ORDER NP7300.

HANDBOOKS FOR THE HAMSHACK

- NEW!** ● **WORLD REPEATER ATLAS**—BK7315—Completely updated, over 230 pages of repeater listings are indexed by location and frequency. More than 50 maps pinpoint 2000 repeater locations throughout the USA. Foreign listings include Europe, the Middle East, South American and Africa. \$4.95.
- **THE PRACTICAL HANDBOOK OF AMATEUR RADIO FM REPEATERS**—BK1185—by Bill Pasternak WA6ITF (author of 73 Magazine's monthly column "Looking West") This is the book for the VHF/UHF FMer, compiled from material submitted by over a hundred individuals, clubs, organizations and equipment manufacturers. A "must have" for your ham shack shelf. \$9.95.
- **WORLD RADIO TV HANDBOOK 1981, 35TH EDITION**—BK1184—This book is the bible of international broadcasters, providing the only authoritative source of exact information about broadcasting and TV stations world wide. This 1981 edition is completely revised, giving comprehensive coverage of short, medium and long wave, 560 pages of vital aspects of world listening. \$16.50.

OTHER STUDY GUIDES

● **ADVANCED CLASS LICENSE STUDY GUIDE**—SG1081—Ready to upgrade your license? To prevent retaking the FCC theory exam, you need the 73 Advanced theory guide. SSB, antenna theory, transmitters, and electronics measuring techniques are covered in detail in this easy-to-follow study guide. Special modes and techniques, such as RTTY, are also treated. An engineering degree is *not* necessary to master the Advanced theory—try this book before visiting the examiner's office! \$6.95.* (Published by TAB Books previous to recent changes in FCC exam material.)

● **EXTRA CLASS LICENSE STUDY GUIDE**—SG1080—Before going for your 1 x 2 call, it pays to be a master of the Extra class electronics theory. This study guide is the logical extension of the 73 theory course. All the theory necessary to pass the exam is presented. Antennas, transmission lines, swr are discussed, as well as noise, propagation, and specialized communication techniques. This book is not a classroom lecture or memorization guide, but rather a logical presentation of the material that must be *understood* before attempting the Extra exam. Save yourself a return trip to the FCC and try the 73 method first! \$5.95.*



● **UNDERSTANDING AND PROGRAMMING MICROCOMPUTERS**—BK7382—A valuable addition to your computing library. This two-part text includes the best articles that have appeared in 73 and Kilobaud Microcomputing magazines on the hardware and software aspects of microcomputing. Well-known authors and well-structured text helps the reader get involved. \$10.95*

● **40 COMPUTER GAMES**—BK7381—Forty games in all in nine different categories. Games for large and small systems, and even a section on calculator games. Many versions of BASIC used and a wide variety of systems represented. A must for the serious computer gamesman. \$7.95*

● **SOME OF THE BEST FROM KILOBAUD/MICROCOMPUTING**—BK7311—A collection of the best articles that have recently appeared in Kilobaud/ MICROCOMPUTING. Included is material on the TRS-80 and PET systems, CP/M, the 8080/8085/Z80 chips, the ASR-33 terminal. Data base management, word processing, text editors and file structures are covered too. Programming techniques and hardware construction projects for modems, high speed cassette interfaces and TVTs are also included in this large format, 200 plus page edition. \$10.95.*

● **HOBBY COMPUTERS ARE HERE!**—BK7322—If you want to come up to speed on how computers work . . . hardware and software . . . this is an excellent book. It starts with fundamentals and explains the circuits, and the basics of programming, along with a couple of TVT construction projects, ASCII-Baudot, etc. This book has the highest recommendations as a teaching aid. \$4.95.*

● **THE NEW HOBBY COMPUTERS**—BK7340—This book takes it from where "HOBBY COMPUTERS ARE HERE!" leaves off, with chapters on Large Scale Integration, how to choose a microprocessor chip, an introduction to programming, low cost I/O for a computer, computer arithmetic, checking memory boards . . . and much, much more! Don't miss this tremendous value! Only \$4.95.*

*Use the order card in the back of this magazine or itemize your order on a separate piece of paper and mail to: 73 Radio Bookshop • Peterborough NH 03458. Be sure to include check or detailed credit card information. No C.O.D. orders accepted. *Add \$1.00 handling charge. Note: Prices subject to change on books not published by 73 Magazine. Questions regarding your order? Please write to Customer Service at the above address. Please allow 4-6 weeks for delivery.

FOR TOLL FREE ORDERING CALL 1-800-258-5473

RADIO BOOKSHOP

73 TECHNICAL LIBRARY

● **BEHIND THE DIAL**—BK7307—By Bob Grove. Get more fun out of shortwave listening with this interesting guide to receivers, antennas, frequencies and interference. \$4.95.*

● **THE CHALLENGE OF 160**—BK7309—is the newest book in the 73 technical library, dedicated to 160 meter operating. Si Dunn provides all necessary information to get started on this unique band. The all-important antenna and ground systems are described in detail. The introduction contains interesting photos of Stew Perry's (the King of 160) shack. This reference is a must for new and experienced "Top Band" operators. Price: \$4.95.*

● **IC OP-AMP COOKBOOK**—BK1028—by Walter G. Jung. Covers not only the basic theory of the IC op amp in great detail, but also includes over 250 practical circuit applications, liberally illustrated. 592 pages, 5½ × 8½, softbound. \$12.95.*

● **THE POWER SUPPLY HANDBOOK**—BK7305—Need a power supply for a gadget you're building? In the **POWER SUPPLY HANDBOOK** there are dozens ready-to-build, plus detailed steps for designing your own. There are circuits and parts lists for all kinds of supplies, ranging from simple DC types to highly stable regulated versions. If you need a circuit to convert a DC voltage to a higher or lower voltage, turn DC into AC, or AC to DC—then this is the book you need. With more than 400 pages, you should be able to find just the circuit you need. Without a doubt one of the best power supply source books available, compiled by the editors of 73. \$9.95.*



● **WEATHER SATELLITE HANDBOOK**—BK7370—Simple equipment and methods for getting good pictures from the weather satellite. Antennas, receivers, monitors, facsimile you can build, tracking, automatic control (you don't even have to be home). Dr. Taggart WB8DQT. \$4.95.*

● **THE NEW RTTY HANDBOOK**—BK7347—is a new edition and the only up-to-date RTTY book available. The state of the art has been changing radically and had made all previous RTTY books obsolete. It has the latest circuits, great for the newcomer and expert alike. \$5.95.*

● **PROPAGATION WIZARD'S HANDBOOK**—BK7302—by J. H. Nelson. When sunspots riddled the worldwide communications networks of the 1940's, John Henry Nelson looked to the planets for an answer. The result was a theory of propagation forecasting based upon interplanetary alignment that made the author the most reliable forecaster in America today. The book provides an enlightened look at communications past, present, and future, as well as teaching the art of propagation forecasting. \$6.95.*

● **SSB... THE MISUNDERSTOOD MODE**—BK7351—by James B. Wilson. Single Sideband Transmission... thousands of us use it every day, yet it remains one of the least understood facets of amateur radio. J. B. Wilson presents several methods of sideband generation, amply illustrated with charts and schematics, which will enable the ambitious reader to construct his own sideband generator. A must for the technically-serious hams. \$5.50.*

● **MASTER HANDBOOK OF HAM RADIO CIRCUITS**—BK1033— This is an encyclopedia of amateur radio circuits, gleaned from past issues of 73 Magazine and carefully selected according to application. You'll find many you've never seen before, some new twists on the tried and true, and several that have been long forgotten but are well worth remembering. Where your interest ranges from ragchewing to EME, from CW to slow-scan TV, from DX to county nets, this handbook will be a welcome addition to your shack. \$8.95.*



● **OWNER REPAIR OF RADIO EQUIPMENT**—BK7310—Frank Glass K6RQ shares over 40 years of operating, servicing, and design experience in this book which ranges from the elementary to the highly technical written for the top engineers in the field. It is written in narrative style on the subjects of electronic servicing, how components work, and how they are combined to provide communication equipment. This book will help you understand the concepts required to service your own station equipment. \$7.95.*

● **TOOLS & TECHNIQUES FOR ELECTRONICS**—BK7348—by A. A. Wicks is an easy-to-understand book written for the beginning kit builder as well as the experienced hobbyist. It has numerous pictures and descriptions of the safe and correct ways to use basic and specialized tools for electronic projects as well as specialized metal working tools and the chemical aids which are used in repair shops. \$4.95.*

● **THE CONTEST COOKBOOK**—BK7308—reveals the secrets of the contest winners (Domestic, DX and specialty contests), complete with photos and diagrams of equipment used by the top scorers. Find out how to make 150 contacts in one hour. \$5.95.*

*Use the order card in the back of this magazine or itemize your order on a separate piece of paper and mail to: 73 Radio Bookshop • Peterborough NH 03458. Be sure to include check or detailed credit card information. No C.O.D. orders accepted. *Add \$1.00 handling charge. Note: Prices subject to change on books not published by 73 Magazine. Questions regarding your order? Please write to Customer Service at the above address. Please allow 4-6 weeks for delivery.

FOR TOLL FREE ORDERING CALL 1-800-258-5473

Radio Bookshop

TEST EQUIPMENT

● **RF AND DIGITAL TEST EQUIPMENT YOU CAN BUILD** — BK1044 — Rf burst, function, square wave generators, variable length pulse generators — 100 kHz marker, i-f and rf sweep generators, audio osc, af/rf signal injector, 146 MHz synthesizer, digital readouts for counters, several counters, prescaler, microwave meter, etc. 252 pages. \$5.95.*

● **VOL. I COMPONENT TESTERS** — LB7359 — ... how to build transistor testers (8), diode testers (3), IC testers (3), voltmeters and VTVMs (9), ohmmeters (8 different kinds), inductance (3), capacity (9), Q measurement, crystal checking (6), temperature (2), aural meters for the blind (3) and all sorts of miscellaneous data on meters... using them, making them more versatile, making standards. Invaluable book. \$4.95.*

● **VOL. II AUDIO FREQUENCY TESTERS** — LB7360 — ... jam packed with all kinds of audio frequency test equipment. If you're into SSB, RTTY, SSTV, etc., this book is a must for you... a good book for hi-fi addicts and experimenters, too! \$4.95.*

● **VOL. IV IC TEST EQUIPMENT** — LB7362 — Become a troubleshooting wizard! In this fourth volume of the 73 TEST EQUIPMENT LIBRARY are 42 home construction projects for building test equipment to work with your ham station and in servicing digital equipment. Plus a cumulative index for all four volumes for the 73 TEST EQUIPMENT LIBRARY. \$4.95.*

● **VOL. III RADIO FREQUENCY TESTERS** — LB7361 — Radio frequency waves, the common denominator of Amateur Radio. Such items as SWR, antenna impedance, line impedance, rf output and field strength; detailed instructions on testing these items includes sections on signal generators, crystal calibrators, grid dip oscillators, noise generators, dummy loads and much more. \$4.95.*



THE WELL-EQUIPPED HAM SHACK

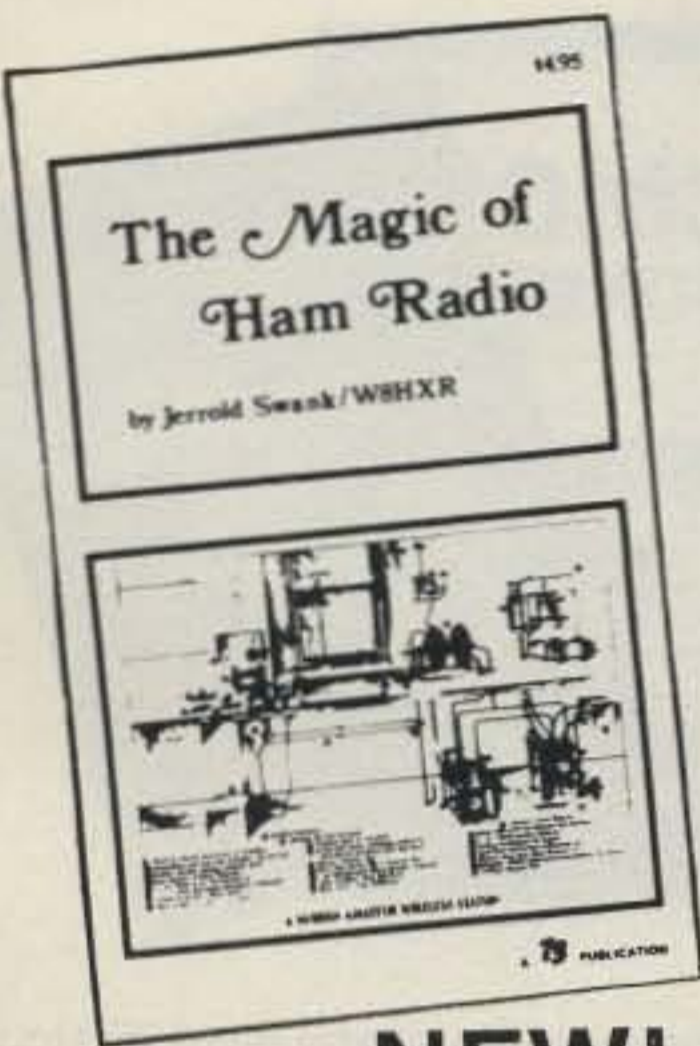

NEW!

● **THE MAGIC OF HAM RADIO** — BK7312 — by Jerrold Swank, W8HXR begins with a brief history of amateur radio and of Jerry's involvement in it. Part 2 details many of ham radio's heroic moments. Hamdom's close ties with the continent of Antarctica are the subject of Part 3. In Part 4 the strange and humorous sides of ham life get their due. And what of the future? Part 5 peers into the crystal ball. \$4.95.*

● **A GUIDE TO HAM RADIO** — BK7321 — by Larry Kahaner WB2NEL. What's Amateur Radio all about? You can learn the basics of this fascinating hobby with this excellent beginner's guide. It answers the most frequently asked questions in an easy-going manner, and it shows the best way to go about getting an FCC license. A Guide to Ham Radio is an ideal introduction to a hobby enjoyed by people around the world. \$4.95.*

● **HOW TO BUILD A MICROCOMPUTER — AND REALLY UNDERSTAND IT** — BK7325 — by Sam Creason. The electronics hobbyist who wants to build his own microcomputer system now has a practical "How-To" guidebook. This book is a combination technical manual and programming guide that takes the hobbyist step-by-step through the design, construction, testing and debugging of a complete microcomputer system. Must reading for anyone desiring a true understanding of small computer systems. \$9.95.*



● **LIBRARY SHELF BOXES** — These sturdy white, corrugated, dirt-resistant boxes each hold a full year of 73, *Kilobaud Microcomputing* or *80 Microcomputing*. With your order, request self-sticking labels for any of the following: 73, *Kilobaud Microcomputing*, *80 Microcomputing*, *CQ*, *QST*, *Ham Radio*, *Personal Computing*, *Radio Electronics*, *Interface Age*, and *Byte*. Order 1 — BX1000 — for \$2.00*; order 2-7 — BX2002 — for \$1.50 each*; order 8 or more — BX1002 — for \$1.25 each*.

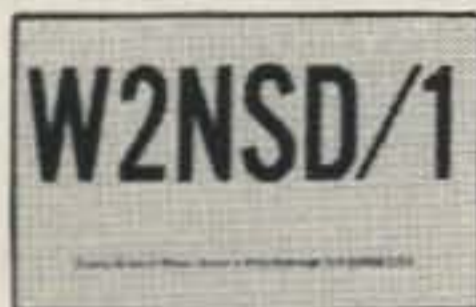

Style Y



Style W

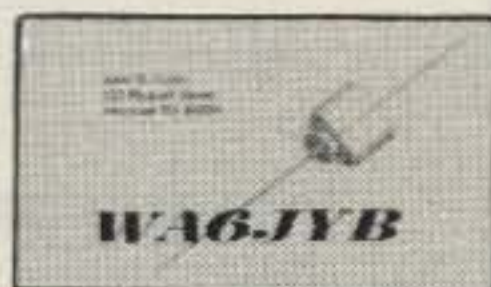

Style X

● **QSL CARDS** — 73 turns out a fantastic series of QSL cards at about half the cost of having them done elsewhere because they are run as a fill-in between printing books and other items in the 73 Print Shop. 250 Style W — QW0250 — for \$8.95*; 500 Style W — QW0500 — for \$13.95*; 250 Style X — QX0250 — for \$8.95*; 500 Style X — QX0500 — for \$13.95*; 250 Style Y — QY0250 — for \$8.95*; 500 Style Y — QY0500 — for \$13.95.* Allow 6-12 wks. for delivery.

● **BACK ISSUES** — Complete your collection; many are prime collectables now, classics in the field! A full collection is an invaluable compendium of radio and electronics knowledge!

Single back issue — ST0000 — \$3.00*;
25 our choice — ST2500 — \$12.00*;
25 your choice — ST2501 — \$25.00*;
5 your choice — ST0500 — \$8.75*;
10 your choice — ST1000 — \$14.00.*

● **FREE BACK ISSUE CATALOGS** are yours for the asking... specify 73 Magazine and/or *Kilobaud Microcomputing* back issue catalog when you send your name and address to us on a postcard.

73 MAGAZINE BINDERS

● Preserve and protect your collection for a lifetime! Order these handsome red binders with gold lettering. \$7.50 for 1, 3 for \$21.75, 6 for \$42.00. (Postpaid within USA, please add \$2.50 per order outside USA.) Check or money orders only, no phone or C.O.D. orders. 73 Binders, P.O. Box 5120, Philadelphia, PA 19141.

*Use the order card in the back of this magazine or itemize your order on a separate piece of paper and mail to: 73 Radio Bookshop • Peterborough NH 03458. Be sure to include check or detailed credit card information. No C.O.D. orders accepted. *Add \$1.00 handling charge. Note: Prices subject to change on books not published by 73 Magazine. Questions regarding your order? Please write to Customer Service at the above address. Please allow 4-6 weeks for delivery.

FOR TOLL FREE ORDERING CALL 1-800-258-5473

Radio Bookshop

● **73 DIPOLE AND LONG-WIRE ANTENNAS**—BK1016—by Edward M. Noll W3FQJ. This is the first collection of virtually every type of wire antenna used by amateurs. Includes dimensions, configurations, and detailed construction data for 73 different antenna types. Appendices describe the construction of noise bridges, line tuners, and data on measuring resonant frequency, velocity factor, and swr. \$5.50.*

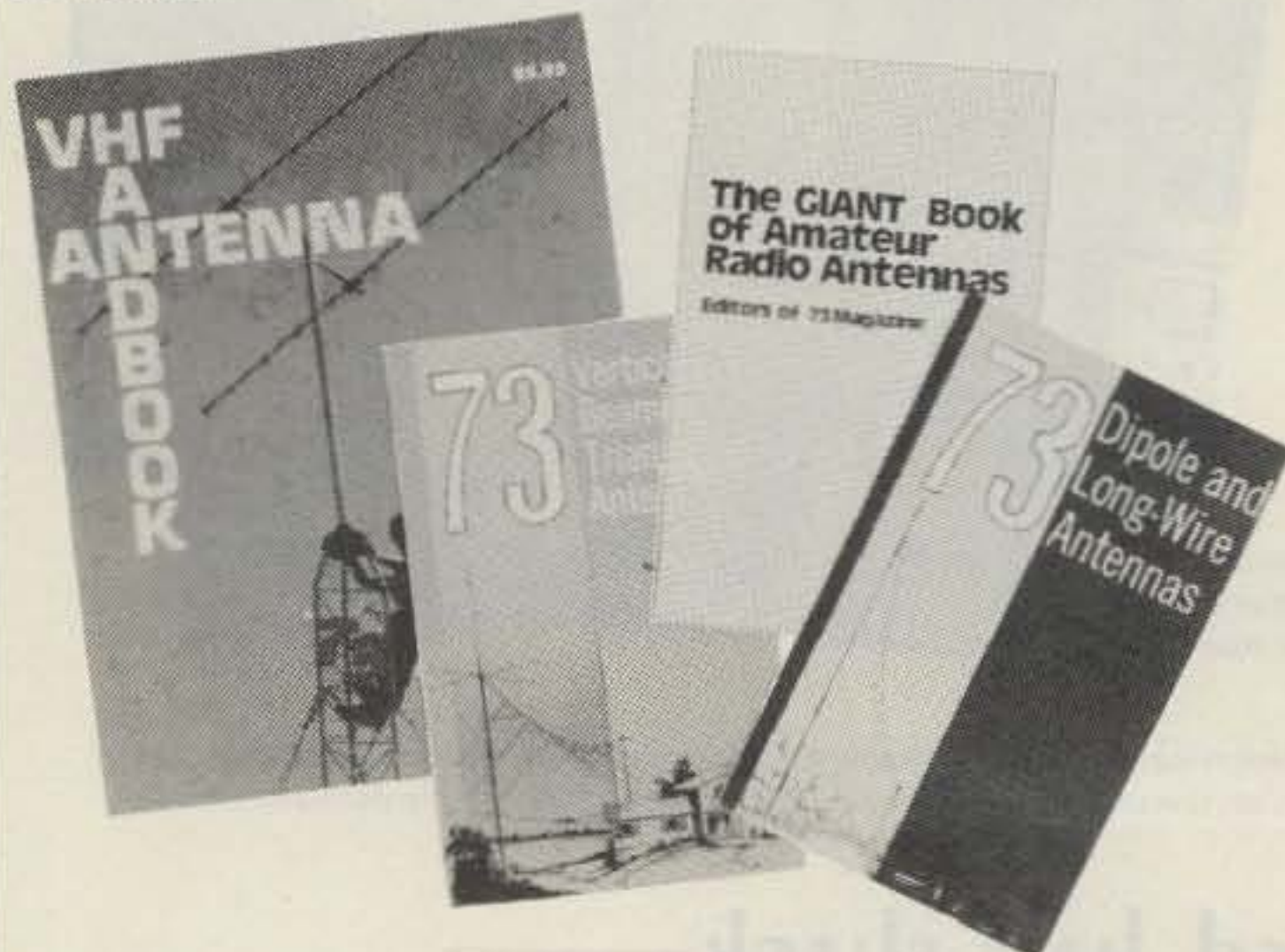

● **THE GIANT BOOK OF AMATEUR RADIO ANTENNAS**—With the **GIANT Book of Amateur Radio Antennas**—BK1104—by your side, antennas will become the least of your worries. Over 450 pages of design ideas, theory and reference data make this book live up to its title. The 7 chapters cover everything from basic antenna theory through designs for DIY accessories, as well as dozens of antenna designs. Whether planning to build or buy, design or admire, test or enjoy a ham antenna—this is the book for you. From the editors of 73; published by Tab Books. Hardcover \$12.95.*

● **73 VERTICAL, BEAM AND TRIANGLE ANTENNAS**—BK1069—by Edward M. Noll W3FQJ. Describes 73 different antennas for amateurs. Each design is the result of the author's own experiments covering the construction of noise bridges and antenna line tuners, as well as methods for measuring resonant frequency, velocity factor, and standing-wave ratios. 160 pages. \$5.50.*

● **VHF ANTENNA HANDBOOK**—BK7368—The **NEW VHF Antenna Handbook** details the theory, design and construction of hundreds of different VHF and UHF antennas... A practical book written for the average amateur who takes joy in building, not full of complex formulas for the design engineer. Packed with fabulous antenna projects you can build. \$5.95.*

● **PRACTICAL ANTENNAS FOR THE RADIO AMATEUR**—BK1015—A manual describing how to equip a ham station with a suitable antenna. A wide range of antenna topics, systems, and accessories are presented giving the reader some food for thought and practical data for construction. Designed to aid the experienced ham and novice as well. Only \$9.95.*

● **TTL COOKBOOK**—BK1063—by Donald Lancaster. Explains what TTL is, how it works, and how to use it. Discusses practical applications, such as a digital counter and display system, events counter, electronic stopwatch, digital voltmeter and a digital tachometer. \$9.50.

● **CMOS COOKBOOK**—BK1011—by Don Lancaster. Details the application of CMOS, the low power logic family suitable for most applications presently dominated by TTL. Required reading for every serious digital experimenter! \$10.50.*

● **TVT COOKBOOK**—BK1064—by Don Lancaster. Describes the use of a standard television receiver as a microprocessor CRT terminal. Explains and describes character generation, cursor control and interface information in typical, easy-to-understand Lancaster style. \$9.95.*

● **RTL COOKBOOK**—BK1059—by Donald Lancaster. Explains the how and why of RTL (Resistor-Transistor Logic) and gives design information that can be put to practical use. Gives a multitude of digital applications ranging from the basic switch to the sophisticated counter. 240 pages; \$6.50.*



SSTV

● **SLOW SCAN TELEVISION TAPE**—CT7350—Prize-winning programs from the 73 SSTV contest. Excellent for Demo! \$5.95.*



73 CODE TAPES

"GENESIS"

5 WPM—CT7305—This is the beginning tape for people who do not know the code at all. It takes them through the 26 letters, 10 numbers and necessary punctuation, complete with practice every step of the way using the newest blitz teaching techniques. It is almost miraculous! In one hour many people—including kids of ten—are able to master the code. The ease of learning gives confidence to beginners who might otherwise drop out.

"THE STICKLER"

6+ WPM—CT7306—This is the practice tape for the Novice and Technician licenses. It is made up of one solid hour of code, sent at the official FCC standard (no other tape we've heard uses these standards, so many people flunk the code when they are suddenly—under pressure—faced with characters sent at 13 wpm and spaced for 5 wpm). This tape is not memorizable, unlike the zany 5 wpm tape, since the code groups are entirely random characters sent in groups of five.

Any Four Tapes For \$15.95! *
\$4.95 Each! *



"BACK BREAKER"

13+ WPM—CT7313—Code groups again, at a brisk 13 per so you will be at ease when you sit down in front of the steely-eyed government inspector and he starts sending you plain language at only 13 per. You need this extra margin to overcome the panic which is universal in the test situations. When you've spent your money and time to take the test, you'll thank heavens you had this back-breaking tape.

"COURAGEOUS"

20+ WPM—CT7320—Code is what gets you when you go for the Extra class license. It is so embarrassing to panic out just because you didn't prepare yourself with this tape. Though this is only one word faster, the code groups are so difficult that you'll almost fall asleep copying the FCC stuff by comparison. Users report that they can't believe how easy 20 per really is with this fantastic one hour tape.

"OUTRAGEOUS"

25+ WPM—CT7325—This is the tape for that small group of overachieving hams who wouldn't be content to simply satisfy the code requirements of the Extra Class license. It's the toughest tape we've got and we keep a permanent file of hams who have mastered it. Let us know when you're up to speed and we'll inscribe your name in 73's CW "Hall of Fame."

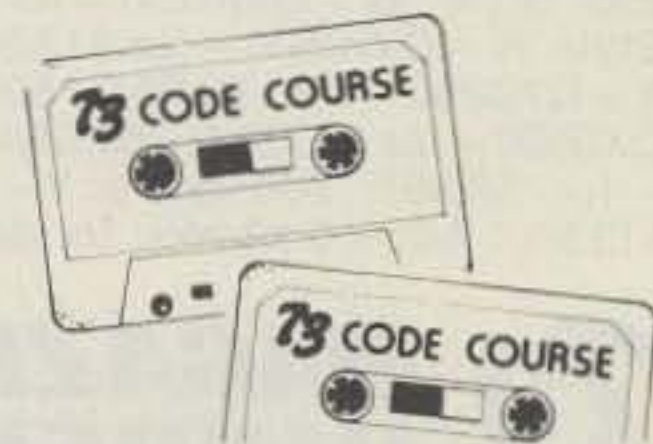

*Use the order card in the back of this magazine or itemize your order on a separate piece of paper and mail to: 73 Radio Bookshop • Peterborough NH 03458. Be sure to include check or detailed credit card information. No C.O.D. orders accepted. *Add \$1.00 handling charge. Note: Prices subject to change on books not published by 73 Magazine. Questions regarding your order? Please write to Customer Service at the above address. Please allow 4-6 weeks for delivery.

FOR TOLL FREE ORDERING CALL 1-800-258-5473

DEALER DIRECTORY

San Jose CA

Bay area's newest Amateur Radio store. New & used Amateur Radio sales & service. We feature Kenwood, ICOM, Azden, Yaesu, Ten-Tec, VHF Engineering & many more. Shaver Radio, Inc., 1378 So. Bascom Ave., San Jose CA 95128, 998-1103.

San Leandro CA

Specializing in Amateur Radio Test Guides. We publish the most accurate F.C.C. exam preparation material in the country according to letters on file from hams nationwide. General, Advanced, and Extra Class manuals available. Bash Educational Services, 519 Estudillo Avenue, P.O. Box 2115, San Leandro, CA 94577, 352-5420.

Denver CO

Experimenter's paradise! Electronic and mechanical components for computer people, audio people, hams, robot builders, experimenters. Open six days a week. Gateway Electronics Corp., 2839 W. 44th Ave., Denver CO 80211, 458-5444.

Uncasville CT

Cushcraft, Bencher, Hy-Gain, Telex, Barker & Williamson, Nye-Viking, Hustler, MFJ, Callbook, Murch, Unadilla, OK, Saxton, ARRL Books, Used equipment, Electronic parts and accessories, free catalog. Donovan Electronics, Inc., 2510 Norwich, New London Tpke, Uncasville CT 06382, 848-3434.

Columbus GA

KENWOOD—YAESU—DRAKE
The world's most fantastic amateur showroom! You gotta see it to believe it! Radio Wholesale, 2012 Auburn Avenue, Columbus GA 31906, 561-7000.

Boise ID

Adzen, Amidon, Ameco, ARRL, B&W, Callbook, Collins, Cushcraft, Dentrone, Hustler, ICOM, Jim-Pak, KDK, MFJ, NPC, Nye, Sams, SST, Swan, Ten-Tec, Wanzer, Wilson. Custom Electronics, 1209 Broadway, Boise ID 83706, Bob W7SC 344-5084.

Preston ID

Ross WB7BYZ, has the Largest Stock of Amateur Gear in the Intermountain West and the Best Prices. Call me for all your ham needs. Ross Distributing, 78 So. State, Preston ID 83263, 852-0830.

Terre Haute IN

Your ham headquarters located in the heart of the midwest. Hoosier Electronics, Inc., 43B Meadows Shopping Center, P.O. Box 2001, Terre Haute IN 47802, 238-1456.

Littleton MA

The ham store of N.E. you can rely on. Kenwood, ICOM, Wilson, Yaesu, DenTron, KLM amps, B&W switches & wattmeters, Whistler radar detectors, Bearcat, Regency, antennas by Larsen, Wilson, Hustler, GAM. TEL-COM Inc. Communications & Electronics, 675 Great Rd., Rt. 119, Littleton MA 01460, 486-3040.

Laurel MD

Kenwood, Drake, ICOM, Ten-Tec, Swan, Dentrone, Tempo and many ham accessories. Also computers by Apple and Exidy. The Comm Center, Inc., Laurel Plaza—Rt. 198, Laurel MD 20810, 792-0600.

St. Louis MO

Experimenter's paradise! Electronic and mechanical components for computer people, audio people, hams, robot builders, experimenters. Open six days a week. Gateway Electronics Corp., 8123-25 Page Blvd., St. Louis MO 63130, 427-6116.

Syracuse-Rome-Utica NY

Featuring: Kenwood, Yaesu, ICOM, Drake, Ten-Tec, Swan, DenTron, Alpha, Robot, MFJ, Tempo, Astron, KLM, Hy Gain, Mosley, Larsen, Cushcraft, Hustler, Mini Products. You won't be disappointed with equipment/service. Radio World, Oneida County Airport-Terminal Building, Oriskany NY 13424, 337-0203.

Phila. PA/Camden NJ

Waveguide & coaxial microwave components & equipment. Laboratory grade test instruments, power supplies. Buy, sell & trade all popular makes, HP, GR, FXR, ESI, Sorensen, Singer, etc. Electronic Research Labs., 1423 Ferry Ave., Camden NJ 08104, 541-4200.

Mocksville NC AMATEUR-REPAIR

Quality Service, reasonable rates, all brands. Now USA KDK repair center. Amateur Radio Repair Center of IEC, Inc., 79 Town Square, Mocksville, NC 27028, 998-2627.

Columbus OH

All major brands featured in the biggest and best ham store for miles around. Come in and twist the knobs before you buy. Universal Amateur Radio, Inc., 1280 Aida Dr., Reynoldsburg (Columbus) OH 43068, 866-4267.

Houston TX

Experimenter's paradise! Electronic and mechanical components for computer people, audio people, hams, robot builders, experimenters. Open six days a week. Gateway Electronics Inc., 8932 Clarkcrest, Houston TX 77063, 978-6575.

San Antonio TX

Complete 2 way service shop. Call Dee, W5FSP. Selling Antenna Specialists, Avanti, Azden, Bird, Hy-gain, Standard communications, Genave, Henry, Cushcraft, Dielectric, Hustler, ICOM, MFJ, Nye, Shure, Swan, Tempo, Ten-Tec and others. Appliance & Equipment Co., Inc., 2317 Vance Jackson Road, San Antonio TX 78213, 734-7793.

DEALERS

Your company name and message can contain up to 25 words for as little as \$150 yearly (prepaid), or \$15 per month (prepaid quarterly). No mention of mail-order business or area code permitted. Directory text and payment must reach us 60 days in advance of publication. For example, advertising for the March issue must be in our hands by January 1st. Mail to 73 Magazine, Peterborough NH 03458. ATTN: Nancy Ciampa.

PROPAGATION

J. H. Nelson
4 Plymouth Dr.
Whiting NJ 08759

EASTERN UNITED STATES TO:

	GMT:	00	02	04	06	08	10	12	14	16	18	20	22
ALASKA	21	7A	7	7	7	7	7	7	7A	14A	21A	21A	
ARGENTINA	14	14	7	7	7	7	14	21	21A	21A	21A	21	
AUSTRALIA	21	14	7B	7B	7B	7B	14	21	21A	21A	21A	21	
CANAL ZONE	14A	14	7	7	7	7	14	21	21A	21A	21A	21	
ENGLAND	7	7	7	7	7	7	14	21	21A	21	14	14	
HAWAII	21A	14	7B	7	7	7	7	7B	14	21	21A	21A	
INDIA	7	7	7B	7B	7B	7B	14	14A	14	7B	7B	7B	
JAPAN	14A	14	7B	7B	7B	7	7	7	7B	7B	7B	14	
MEXICO	14A	14	7	7	7	7	7	14	21A	21A	21A	21	
PHILIPPINES	21	14	7B	7B	7B	7B	7	7	7	7	7B	14	
PUERTO RICO	14	7	7	7	7	7	14	21	21A	21A	21	14A	
SOUTH AFRICA	14	7	7	7B	7B	14	14A	21A	21A	21A	21	21	
U. S. S. R.	7	7	7	7	7	7	7B	14	21A	14A	7B	7B	7
WEST COAST	21A	14	7	7	7	7	7	14	21	21A	21A	21A	

CENTRAL UNITED STATES TO:

ALASKA	21	14	7	7	7	7	7	7	14	14A	21A	21A	
ARGENTINA	21	14	7A	7	7	7	14	21	21A	21A	21A	21	
AUSTRALIA	21	14A	14	7B	7B	7B	7B	14A	21	21A	21A	21A	
CANAL ZONE	21	14	7	7	7	7	14	21	21A	21A	21A	21	
ENGLAND	7B	7	7	7	7	7	7B	14	21A	21	14	7B	
HAWAII	21A	14A	14	7	7	7	7	7	14	21	21A	21A	
INDIA	7B	14	7B	7B	7B	7B	7B	14	7B	7B	7B	7B	
JAPAN	21A	14	7B	7B	7	7	7	7	7	7B	7B	14	
MEXICO	14	14	7	7	7	7	7	14	14A	21A	21A	21	
PHILIPPINES	21A	14	7B	7B	7B	7B	7B	7	7	7	7B	14	
PUERTO RICO	21	14	7	7	7	7	14	21	21A	21A	21A	21	
SOUTH AFRICA	14	14	7	7B	7B	7B	14	14A	21A	21A	21	21	
U. S. S. R.	7	7	7	7	7	7	7B	14	14A	7B	7B	7B	

WESTERN UNITED STATES TO:

ALASKA	21	14	7	7	7	7	7	7	14	21A	21A		
ARGENTINA	21	14A	14	7	7	7	7B	14	21	21A	21A	21A	
AUSTRALIA	21A	21	14	14	7B	7B	7B	14	21	21A	21A	21A	
CANAL ZONE	21	14	14	7	7	7	7	14	21	21A	21A	21A	
ENGLAND	7B	7	7	7	7	7	7B	7A	21A	21	14	7B	
HAWAII	21A	21	14A	14	7	7	7	7	14	21	21A	21A	
INDIA	14B	14	7B	7B	7B	7B	7B	7A	7B	7B	7B	7B	
JAPAN	21A	14A	14	7B	7	7	7	7	7	7B	14	21	
MEXICO	21	14	7A	7	7	7	7	14	14A	21A	21A	21A	
PHILIPPINES	21A	14A	14	7B	7B	7B	7B	7	7	7	7B	14A	
PUERTO RICO	21	14	7A	7	7	7	7	14	21	21A	21A	21A	
SOUTH AFRICA	21	14	7	7B	7B	7B	7B	14	14A	21A	21	21	
U. S. S. R.	7B	7	7	7	7	7	7B	7B	14A	7B	7B	7B	
EAST COAST	21A	14	7	7	7	7	7	14	21	21A	21A	21A	

A = Next higher frequency may also be useful
B = Difficult circuit this period
F = Fair G = Good P = Poor
SF = Chance of solar flares

January

sun	mon	tue	wed	thu	fri	sat
				1 F	2 G	3 G
4 G	5 G	6 G	7 G	8 G	9 G	10 G
11 G	12 F/SF	13 P	14 F	15 G	16 G	17 G
18 F	19 G	20 G	21 G	22 F	23 F	24 F
25 F	26 G	27 G	28 G	29 F	30 F	31 F

List of AdvertisERS

*Please contact these advertisers directly.

To receive full information from our advertisers please complete the following postage-paid card.

R.S. No.	Page	R.S. No.	Page	R.S. No.	Page	R.S. No.	Page
* AEA/Advanced Elect. Applica., Inc.	38,47	352 Grove Enterprises	21	51 Microlog Corp.	53, 81	77 Tufts Radio Electronics	134-145
3 AED Electronics	17	392 HMR Associates	113	52 MidCom Electronics, Inc.	33	* Universal Communications	165
476 AED Electronics	37	378 HVB	165	* MidCom Electronics/AEA	162	311 Vanguard Labs	165
362 A.P. Systems	76	345 Hal Comm.	3, 19	318 National Comm. Group Co.	74	373 Van Gorden Engineering	79
* A.R.P.	161	31 Hal-Tronix	63, 74	481 Non-Linear Systems	156	90 VoCom Products Corp.	61
7 American Crystal Supply	165	30 The Ham-Key Co.	49	54 OK Machine & Tool	99	80 Western Electronics	76
* Appli. & Equip. Co., Inc.	165	32 Ham Radio Center	57	482 OK Machine & Tool	34	* Wheaton Hamfest	113
8 Apron Laboratories	113	33 Hamtronics, NY	179	* Orbit Magazine	63	* Wilson Systems, Inc.	40, 41
* Associated Radio	61	483 Heath Co.	34	57 P.C. Electronics	162	82 Xitex Corp.	164
10 Avanti Research & Develop.	162	34 Henry Radio	Covil	* Palomar Engineers	17, 156	83 Yaesu Electronics Corp.	Covill, 65
11 Barker & Williamson	103	* Henry Radio/AEA	118	60 Quest Electronics	167		
12 Bullet Electronics	184	316 Hy-Gain Div. of Telex Comm., Inc.	35, 37, 39	61 Radio Amateur Callbook, Inc.	79, 119		
391 Butternut Electronics	107	* ICOM	9	61 Radio Amateur Callbook, Inc.	79, 119		
13 Clegg	59	38 Jameco Electronics	187	381 Radio Systems Tech., Inc.	165		
89 Clutterfree Modular Consoles	81, 113	354 Jensen Tools, Inc.	161	397 Radio World	33		
14 Comm. Center, NE	77	384 Jim-Pak Electronic Comp.	75	62 Ramsey Electronics	178, 185		
382 Comm. Concepts, Inc.	164	40 KLM Electronics	21, 33, 103, 119	394 s a electronics	161		
377 Communications Electronics	186	479 KW Control Systems	35	65 S-F Amateur Radio Services	38		
15 Comm. Specialists	10, 11	* Kantronics	34, 107	477 S-F Amateur Radio Services	36		
* Conley Radio/AEA	52	* KB Microcomputing	163	374 SK Electronics	164		
* Crown Micro Products	17	* Kenwood	CovIV, 7, 24-30	376 SMP	164		
330 Debco Electronics	85	375 Herb Kreckman Co.	164	64 Semiconductors Surplus	180-182		
* Paul Davis Electronics	164	478 Herb Kreckman Co.	157	* 73 Magazine	95, 123, 161, 163, 164, 189-192, 194		
346 Data Service	165	47 MFJ Enterprises	124, 125	396 Shure Bros., Inc.	188		
365 Larry Dennison	33	48 MHz Electronics	168-177	66 Signalcrafters	107		
* Digital Research Parts	166	385 MELCO Enterprises	81	367 Slep Electronics	81		
* 80 Microcomputing	163	44 Macrotronics	103	309 Spacecoast Research	165		
* Erickson Comm.	79	45 Madison Electronics	15	* Spectronics	183		
22 Fair Radio Sales	161	46 Maggiore Electronic Lab.	113	68 Spectrum Comm.	23		
323 Fox-Tango Corp.	162	480 Benjamin Michael Ind.	34	316 Telex Comm., Inc.	35, 37, 39		
390 Galactic Software	119	49 Micro Control Specialties	118	* Ten-Tec, Inc.	13		
25 Germantown Amateur Supply	118	313 Micro Management Systems	32	76 Trac Electronics	4		
* Global Electronics	164	50 Microcraft Corp.	103	* Tropical Hamboree	122		
393 H.M. Goodwin	164	395 Microverter, Inc.	38				
		383 Micro-80, Inc.	165				

73 MAGAZINE

Books, etc.

To order, complete the following postage-paid card, or itemize your order including detailed credit card information or check and mail to:
73 Magazine/Mail Order Dept./Peterborough NH 03458.

Catalog #	Item	Price	Catalog #	Item	Price	Catalog #	Item	Price
BK1016	73 DIPOLE & LONG WIRE ANTENNAS	\$ 5.50	BK1033	MASTER HANDBOOK OF HAM RADIO CIRCUITS	\$ 8.95	SG1080	STUDY GUIDE—EXTRA CLASS	\$ 5.95
ST0000	73 BACK ISSUE	\$ 3.00	BK7340	THE NEW HOBBY COMPUTERS	\$ 4.95	SG7358	STUDY GUIDE—GENERAL CLASS	\$ 5.95
ST2500	73 BACK ISSUES—25 OUR CHOICE	\$12.00	CT7300	NOVICE THEORY TAPES	\$15.95	SG7357	STUDY GUIDE—NOVICE CLASS	\$ 4.95
ST0500	73 BACK ISSUES—5 YOUR CHOICE	\$ 8.75	BK7310	OWNER REPAIR OF RADIO EQUIPMENT	\$ 7.95	LB7359	TEST EQUIP LIB V1—COMPONENT TESTERS	\$ 4.95
ST1000	73 BACK ISSUES—10 YOUR CHOICE	\$14.00	BK7305	POWER SUPPLY HANDBOOK	\$ 7.95	LB7360	TEST EQUIP LIB V2—AUDIO TESTERS	\$ 4.95
ST2501	73 BACK ISSUES—25 YOUR CHOICE	\$25.00	BK1015	PRACTICAL ANTENNAS FOR THE RADIO AMATEUR	\$ 9.95	LB7361	TEST EQUIP LIB V3—RADIO EQUIP.	\$ 4.95
BK7307	BEHIND THE DIAL	\$ 4.95	BK7302	PROPAGATION WIZARD'S HANDBOOK	\$ 6.95	LB7362	TEST EQUIP LIB V4—IC TEST EQ.	\$ 4.95
BK7309	CHALLENGE OF 160	\$ 4.95	QW0250	QSL CARDS—STYLE W—250	\$ 8.95	BK7348	TOOLS & TECHNIQUES	\$ 4.95
CT7305	CODE TAPE—5 WPM	\$ 4.95	QW0500	QSL CARDS—STYLE W—500	\$13.95	BK1063	TTL COOKBOOK	\$ 9.50
CT7306	CODE TAPE—6 + WPM	\$ 4.95	QX0250	QSL CARDS—STYLE X—250	\$ 8.95	BK1064	TVT COOKBOOK	\$ 9.95
CT7313	CODE TAPE—13 + WPM	\$ 4.95	QX0500	QSL CARDS—STYLE X—500	\$13.95	BK7382	UNDERSTANDING & PROGRAMMING MICROCOMPUTERS	\$10.95
CT7320	CODE TAPE—20 + WPM	\$ 4.95	QY0250	QSL CARDS—STYLE Y—250	\$ 8.95	BK1069	VERTICAL BEAM & TRIANGLE ANTNS	\$ 5.50
CT7325	CODE TAPE—25 + WPM	\$ 4.95	QY0500	QSL CARDS—STYLE Y—500	\$13.95	BK7368	VHF ANTENNA HANDBOOK	\$ 5.95
CT7394	CODE TAPES (ANY FOUR ABOVE)	\$15.95	BK1044	RF & DIGITAL TEST EQUIPMENT	\$ 5.95	BK7370	WEATHER SATELLITE HANDBOOK	\$ 4.95
BK7308	THE CONTEST COOKBOOK	\$ 5.95	BK7347	RTTY HANDBOOK	\$ 5.95			
BK7381	40 COMPUTER GAMES	\$ 7.95	BK1059	RTL COOKBOOK	\$ 6.50			
BK7304	GIANT BOOK OF AMATEUR RADIO ANTENNAS	\$12.95	BX1000	SHELF BOX—1	\$ 2.00			
BK7322	HOBBY COMPUTERS ARE HERE	\$ 4.95	BX1001	SHELF BOXES—2-7	\$1.50 each			
BK7325	HOW TO BUILD A MICROCOMPUTER & REALLY UNDERSTAND IT	\$ 9.95	BX1002	SHELF BOXES—8 AND UP	\$1.25 each			
BK1028	IC OP AMP COOKBOOK	\$12.95	BK7351	SSB THE MISUNDERSTOOD MODE	\$ 5.50			
BK7312	MAGIC OF HAM RADIO	\$ 4.95	CT7350	SSTV TAPE	\$ 5.95			
			SG1081	STUDY GUIDE—ADV. CLASS	\$ 6.95			

73 magazine

peterborough, n.h. 03458

READER SERVICE

73 Magazine, P.O.B. 2739, Clinton, IA 52735

This card is valid until March 31, 1981.

Please help us to bring you a better magazine—by answering these questions:

I. What is your age?

- A. under 18
- B. 18-22
- C. 23-40
- D. 41-60
- E. over 60

II. ARRL

- 1. Love it
- 2. Don't care
- 3. Hate it

III. If you are not a subscriber please circle number 500.

1	6	11	16	21	126	131	136	141	146	251	256	261	266	271	376	381	386	391	396
2	7	12	17	22	127	132	137	142	147	252	257	262	267	272	377	382	387	392	397
3	8	13	18	23	128	133	138	143	148	253	258	263	268	273	378	383	388	393	398
4	9	14	19	24	129	134	139	144	149	254	259	264	269	274	379	384	389	394	399
5	10	15	20	25	130	135	140	145	150	255	260	265	270	275	380	385	390	395	400
26	31	36	41	46	151	156	161	166	171	276	281	286	291	296	401	406	411	416	421
27	32	37	42	47	152	157	162	167	172	277	282	287	292	297	402	407	412	417	422
28	33	38	43	48	153	158	163	168	173	278	283	288	293	298	403	408	413	418	423
29	34	39	44	49	154	159	164	169	174	279	284	289	294	299	404	409	414	419	424
30	35	40	45	50	155	160	165	170	175	280	285	290	295	300	405	410	415	420	425
51	56	61	66	71	176	181	186	191	196	301	306	311	316	321	426	431	436	441	446
52	57	62	67	72	177	182	187	192	197	302	307	312	317	322	427	432	437	442	447
53	58	63	68	73	178	183	188	193	198	303	308	313	318	323	428	433	438	443	448
54	59	64	69	74	179	184	189	194	199	304	309	314	319	324	429	434	439	444	449
55	60	65	70	75	180	185	190	195	200	305	310	315	320	325	430	435	440	445	450
76	81	86	91	96	201	206	211	216	221	326	331	336	341	346	451	456	461	466	471
77	82	87	92	97	202	207	212	217	222	327	332	337	342	347	452	457	462	467	472
78	83	88	93	98	203	208	213	218	223	328	333	338	343	348	453	458	463	468	473
79	84	89	94	99	204	209	214	219	224	329	334	339	344	349	454	459	464	469	474
80	85	90	95	100	205	210	215	220	225	330	335	340	345	350	455	460	465	470	475
101	106	111	116	121	226	231	236	241	246	351	356	361	366	371	476	481	486	491	496
102	107	112	117	122	227	232	237	242	247	352	357	362	367	372	477	482	487	492	497
103	108	113	118	123	228	233	238	243	248	353	358	363	368	373	478	483	488	493	498
104	109	114	119	124	229	234	239	244	249	354	359	364	369	374	479	484	489	494	499
105	110	115	120	125	230	235	240	245	250	355	360	365	370	375	480	485	490	495	500

Name _____

Address _____

City _____ State _____ Zip _____

73 Magazine • January 1981

BOOKS

73 Magazine, Pine Street, Peterborough, N.H. 03458

Please send me the following 73 products:

Qty.	Catalog #	Title	Unit Price	Total

Add \$1 shipping/handling _____

Total _____

Please allow 4-6 weeks for delivery.

No C.O.D. orders accepted.

Enclosed \$ _____ Check M.O.

Bill: AE MC Visa

Card # _____ Exp. date _____

Signature _____ Interbank # _____

Name _____

Address _____

City _____

State _____ Zip _____

SUBSCRIPTION

73 Magazine P.O. Box 931 Farmingdale, N.Y. 11737

**73 subscribers
save 30%
off the
newsstand price.**

New subscription

Renewal

1 year—\$25

Enclosed \$ _____

Check

M.O.

Bill: MC

Visa

AE

me

Card # _____ Exp. date _____

Signature _____ Interbank # _____

Name _____

Address _____

City _____ State _____ Zip _____

Canada—\$27, 1 year only, US funds.

Other foreign—\$35, 1 year only, US funds.

311B9

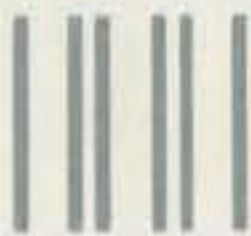

NO POSTAGE
NECESSARY
IF MAILED
IN THE
UNITED STATES

BUSINESS REPLY CARD

FIRST CLASS PERMIT NO. 73 PETERBOROUGH NH 03456

POSTAGE WILL BE PAID BY ADDRESSEE

73 MAGAZINE
Subscription Dept.
POB 931
Farmingdale NY 11737

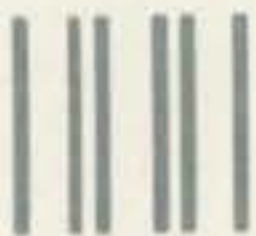

NO POSTAGE
NECESSARY
IF MAILED
IN THE
UNITED STATES

BUSINESS REPLY CARD

FIRST CLASS PERMIT NO. 73 PETERBOROUGH NH 03458

POSTAGE WILL BE PAID BY ADDRESSEE

73 MAGAZINE
Peterborough
NH 03458



BUSINESS REPLY CARD

FIRST CLASS PERMIT NO. 217 CLINTON IA 52735

POSTAGE WILL BE PAID BY ADDRESSEE

73 MAGAZINE
POB 2739
Clinton IA 52735



NO POSTAGE
NECESSARY
IF MAILED
IN THE
UNITED STATES



Att. Mail Order



THE FT-207R HANDIE CHECKLIST

- | | | | | | |
|--------------------------|----------|-------------------------|--------------------------|-------|-----------------------------------|
| <input type="checkbox"/> | TA-2 | telescopic whip antenna | <input type="checkbox"/> | NC-1A | 15-hr. desk charger |
| <input type="checkbox"/> | YM-24 | speaker microphone | <input type="checkbox"/> | NC-3 | 4-hr. quick charger |
| <input type="checkbox"/> | LCC-7 | leather case | <input type="checkbox"/> | NC-9B | wall charger |
| <input type="checkbox"/> | FSP-1 | external speaker | <input type="checkbox"/> | PA-2 | mobile battery eliminator/charger |
| <input type="checkbox"/> | MMB-10 | mobile mounting bracket | <input type="checkbox"/> | FBA-1 | battery sleeve |
| <input type="checkbox"/> | FTS-32E | CTCSS/burst encoder | <input type="checkbox"/> | NBP-9 | battery pack |
| <input type="checkbox"/> | FTS-32ED | CTCSS encoder/decoder | <input type="checkbox"/> | FEP-1 | earphone |

What more could you ask for ?

Price And Specifications Subject To
Change Without Notice Or Obligation

YAESU
The radio.



1280

YAESU ELECTRONICS CORP. 6851 Walthall Way, Paramount, CA 90723 • (213) 633-4007
Eastern Service Ctr., 9812 Princeton-Glendale Rd., Cincinnati, OH 45246 • (513) 874-3100

Small wonder.

Processor, N/W switch, IF shift, DFC option



TS-130S/V

An incredibly compact, full-featured, all solid-state HF SSB/CW transceiver for both mobile and fixed operation. It covers 3.5 to 29.7 MHz (including the three new Amateur bands!) and is loaded with optimum operating features such as digital display, IF shift, speech processor, narrow/wide filter selection (on both SSB and CW), and optional DFC-230 digital frequency

controller. The TS-130S runs high power and the TS-130V is a low-power version for QRP applications.

Ask your Authorized Kenwood Dealer about the compact, full-featured, all solid-state TS-130 Series.

NOTE: Price, specifications subject to change without notice and obligation.

 **KENWOOD**
...pacesetter in amateur radio

TRIO-KENWOOD COMMUNICATIONS INC.
1111 WEST WALNUT / COMPTON, CA 90220



Optional DFC-230 Digital Frequency Controller

Allows frequency control in 20-Hz steps with UP/DOWN microphone (supplied with DFC-230). Includes four memories (handy for split-frequency operation) and digital display. Covers 100 kHz above and below each 500-kHz band. Very compact.