

# 73 Magazine

## for Radio Amateurs

- 32 New Product: Swan's Astro 150 SSB Transceiver** ..... WB8BTH
- 38 Low-Cost Receiver for Satellite TV**  
—this modular design uses readily available technology ..... N6TX
- 44 A Simple 2m/10m Crossband Repeater System**  
—work the world with an HT! ..... K9EID
- 50 Audio Booster for Mil-Surplus Receivers**  
—a must for headphone haters ..... McClellan
- 54 Working with FETs**  
—part II: experiments with gain and supply voltage ..... WA2SUT/NNNØZVB
- 58 Build this \$50 Mini-Counter**  
—three-IC design goes to 135 MHz ..... McClellan
- 66 A Versatile, Variable Active Filter**  
—dc switching and 8-pole response make this one a winner on RTTY or CW ..... WA8HEB
- 70 Variable Tuning for WEFAX Receivers**  
—why be rockbound? ..... N6TX
- 76 Ham Radio Marriage Manual**  
—a YL and her understanding spouse ..... WB5YVE
- 80 The Space-Saving Square Vee Antenna**  
—a directional radiator for cramped quarters ..... W7DJB/6
- 84 License Upgrading—A Plan of Attack**  
—you need not fail! ..... WB2RVA
- 88 Muffin Fan Mania!**  
—a compendium of knowledge about electro-mechanical air movers ..... WA6NCX/1
- 92 Are Repeaters Ripping Us Off?**  
—some thoughts about open access to scarce frequencies ..... KB2JN
- 96  My TRS-80 Is Here . . . Now What?**  
—first steps in programming your computer ..... W3KBM
- 104  Teaching Your Micro to Count**  
—two methods for adding counter capability to your 6502 machine ..... K6EW
- 118 Operation Santa!**  
—spread holiday cheer with this super club project ..... WD8LPN
- 126 Tools and Techniques for Wire-Wrapping**  
—an excerpt from 73's new book ..... W6SWZ
- 132 Working with Transistors**  
—useful knowledge begins where gobbledygook ends ..... WA2SUT/NNNØZVB
- 138 A Digital Clock with Analog Readout**  
—this is progress? ..... W9IEA
- 144 Turn Off Repeater Windbags**  
—HT mod brings welcome relief ..... WD5HYQ
- 146 Build a \$5 Coax Switch**  
—why pay more? ..... W8HXR
- 148 Hamdom's Evangelical Crusade**  
—born-again ops, arise! ..... WB8TCC
- 150 The Memorizer Flies Inverted**  
—something Yaesu never told you ..... W1WUO
- 152 Double-Duty Decoder Project**  
—listen to SCA and tune in RTTY ..... WA1UFE/5
- 158 Build a Simple HT Charger**  
—doubles as a 12-V supply ..... W6SMJ
- 160 Do-It-Yourself Carrying Case for Wilson HTs**  
—save \$14.88 ..... K2GMZ
- 168 Come On In—The Viewing Is Fine**  
—an update on trends and developments in SSTV ..... K4TWJ
- 172 Rack 'Em Up**  
—glass jars and orange crates are "where it's at" for parts storage ..... VE2BVW
- 174 Gadzooks! A Variable 0-260 V Ac Supply!**  
—junk-box delight ..... WB8JCQ/LU1AKO
- 176 Scrounger's Special: Used Dental Tools**  
—your DDS throwaways make dandy PCB drills ..... WA7OYX
- 188 First Look at Latest Radio Laws**  
—the official work ..... KB5AO
- 192 The Induction Relay: Self-Powered Switching**  
—this unusual actuator doesn't require a separate control voltage ..... K6DZY
- 196 The Further Adventures of Keycoder**  
—simplified wiring for the toroidal cores ..... AD9K
- 200 All About Ground Rods**  
—getting connected to Mother Earth ..... Staff





# The TEMPO S-2

## ONCE AGAIN... TEMPO IS FIRST

**T**his time with a superior quality synthesized 220 MHz hand held transceiver. With an S-2 in your car or pocket you can use any 220 MHz repeater in the United States. It offers all of the advanced engineering, premium quality components and exciting features of the S-1. It is completely synthesized, offering 1000 channels in an extremely lightweight but rugged case.

If you're not on 220 it's about time you try it and this is the perfect way to get started. With the addition of a matching Tempo solid state amplifier you can use your S-2 as a powerful mobile or base station as well. It's all you really need. And if you already have a 220 MHz rig, the S-2 will add versatility you never dreamed possible.

Also...the price is right. The ni-cad battery pack, charger, and telescoping whip antenna are included. Although not a necessary option, the touch tone pad shown in the illustration adds greatly to its convenience at a low price.

The time has never been better to expand your horizons...there has never been a better little rig for 220 than the S-2.

The Tempo line also features a fine line of extremely compact UHF and VHF pocket receivers. They're low priced, dependable, and available with CTCSS and 2-tone decoders. The Tempo FMT-2 & FMT-42 (UHF) provides excellent mobile communications and features a remote control head for hide-away mounting.

The Tempo FMH-42 (UHF) and the NEW FMH-12 and FMH-15 (VHF) micro hand held transceivers provide 6 channel capability, dependability plus many worthwhile features at a low price. FCC type accepted models also available. Please call or write for complete information. Also available from Tempo dealers throughout the U.S. and abroad.

#### SPECIFICATIONS

Frequency Coverage: 220 to 225 MHz  
 Channel Spacing: Receive every 5 kHz, transmit Simplex or -1.6 MHz  
 Power Requirements: 9.6 VDC  
 Current Drain: 17 ma-standby  
 500 ma-transmit  
 Batteries: 8 pieces ni-cad battery included  
 Antenna Impedance: 50 ohms  
 Dimensions: 40 mm x 62 mm x 165 mm (1.6" x 2.5" x 6.5")  
 RF Output: Better than 1.5 watts  
 Sensitivity: Better than .5 microvolts

Price... \$349.00

With touch tone pad . . . \$399.00

#### SUPPLIED ACCESSORIES

Telescoping whip antenna, ni-cad battery pack, charger.

#### OPTIONAL ACCESSORIES

Touch tone pad (not installed): \$39 • Tone burst generator: \$29.95 • CTCSS sub-audible tone control: \$29.95 • Rubber flex antenna: \$8 • Leather holster: \$16 • Cigarette lighter plug mobile charging unit: \$6 • Matching 25 watt output 13.8 VDC power amplifier (S-25): \$89 • Matching 75 watt output power amplifier (S-75): \$169

**The TEMPO S-1.** The world's first synthesized 2 meter hand held transceiver. Its superb engineering and top quality components give it an uncommon degree of reliability...a fact now proven by the thousands of units in use worldwide.

#### TEMPO VHF & UHF SOLID STATE POWER AMPLIFIERS

Boost your signal. . . give it the range and clarity of a high powered base station. VHF (135 to 175 MHz)

Drive Power	Output	Model No.	Price
2W	130W	130A02	\$209
10W	130W	130A10	\$189
30W	130W	130A30	\$199
2W	80W	80A02	\$169
10W	80W	80A10	\$149
30W	80W	80A30	\$159
2W	50W	50A02	\$129
2W	30W	30A02	\$ 89

UHF (400 to 512 MHz) models, lower power and FCC type accepted models also available.



11240 W. Olympic Blvd., Los Angeles, Calif. 90064 213/477-6701  
 931 N. Euclid, Anaheim, Calif. 92801 714/772-9200  
 Butler, Missouri 64730 816/679-3127

**NEW TOLL FREE ORDER NUMBER: (800) 421-6631**

For all states except California.  
 Calif. residents please call collect on our regular numbers.

# Henry Radio

Prices subject to change without notice

# Wilson...

## has your needs well in hand.

Today's Amateur demands rugged, rapid and accurate communications between Hams in the know. That's why they choose the Wilson Mark Series of hand-held radios. With exceptional qualities like these . . . why not choose the most popular radio available for yourself?

### FEATURES

Advantages such as solid state circuitry, rugged Lexan® case, removable rear panel (enabling easy access to battery compartment) and compact mini-size enhance the Mark Series portable radio's versatility. In addition, Wilson carries a full line of accessories to satisfy almost any of your requirements.

### SPECIFICATIONS

The Mark radios offer: • 144-148 MHz range • 6 Channel operation • Individual trimmers on TX and RX xtals • Rugged Lexan® outer case • Current drain: RX; 15 mA, TX; Mark II: 500 mA, Mark IV: 900 mA • A power saving Hi/Lo Switch • 12 KHz ceramic filter and 10.7 monolithic filter included • 10.7 MHz and 455 KHz IF • Spurious and harmonics, more than 50 dB below quieting • Uses special rechargeable Ni-Cad battery pack • LED battery condition indicator • Rubber duck and one pair Xtals 52/52 included • Weight: 19 oz. including batteries • Size: 6" x 1.770" x 2.440".

### OPTIONS

Options available, include Touch Tone Pad, CTCSS, Leather Case, Chargers for Desk Top, Travel or Automobile, Speaker Mike and large capacity, small size batteries.

For more details and/or the name of your nearest dealer, contact: Consumer Products Division, Wilson Electronics Incorporated, 4288 So. Polaris Ave., P. O. Box 19000, Las Vegas, Nevada 89119. Phone 702/739-1931.



**Wilson Electronics  
Incorporated**

A Subsidiary of REGENCY ELECTRONICS, INC.

✓ W33

**ACTUAL  
SIZE!!!**

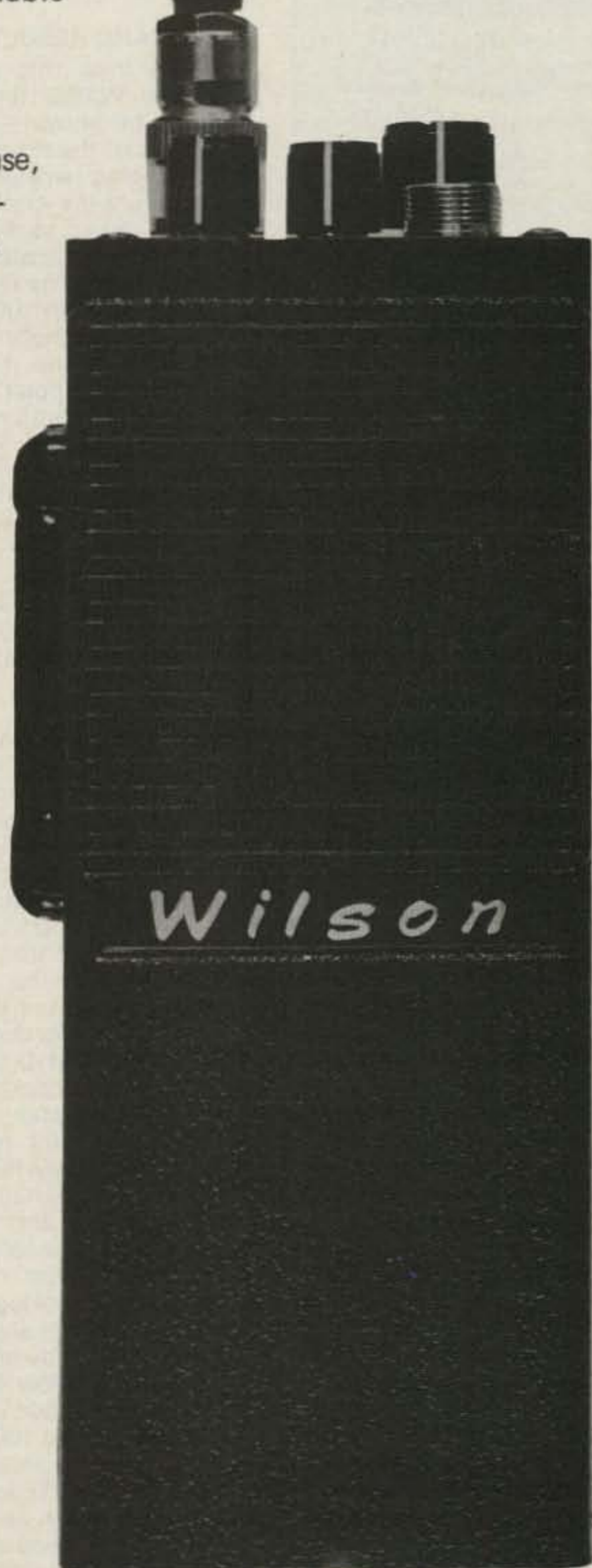

Prices and specifications subject to change without notice.

# Info

## Manuscripts

Contributions in the form of manuscripts with drawings and/or photographs are welcome and will be considered for possible publication. We can assume no responsibility for loss or damage to any material. Please enclose a stamped, self-addressed envelope with each submission. Payment for the use of any unsolicited material will be made upon acceptance. All contributions should be directed to the 73 editorial offices. "How to Write for 73" guidelines are available upon request.

## Editorial Offices:

Pine Street  
Peterborough NH 03458  
Phone: 603-924-3873, 924-3874

## Advertising Offices:

Pine Street  
Peterborough NH 03458  
Phone: 603-924-7138, 924-7139

## Circulation Offices:

Pine Street  
Peterborough NH 03458  
Phone: 603-924-7296

## Subscription Rates

In the United States and Possessions:  
One Year (12 issues) \$18.00  
Two Years (24 issues) \$30.00  
Three Years (36 issues) \$45.00  
Lifetime subscription \$240.00

## Elsewhere:

Canada—add \$2.00 per year unless paid with U.S. currency.

All other foreign—one year only—\$26.00 payable in U.S. currency through a U.S. bank. (Surface mail).

## To subscribe, renew or change an address:

Write to 73 Magazine, Subscription Department, PO Box 931, Farmingdale NY 11737. For renewals and changes of address, include the address label from your most recent issue of 73. For gift subscriptions, include your name and address as well as those of gift recipients. Postmaster: Send form #3579 to 73 Magazine, Subscription Services, P.O. Box 931, Farmingdale NY 11737.

## Subscription problem or question:

Write to 73 Magazine, Subscription Department, PO Box 931, Farmingdale NY 11737. Please include an address label.

73 Magazine (ISSN 0098-9010) is published monthly by 73, Inc., Pine Street, Peterborough NH 03458. Second class postage is paid at Peterborough NH 03458 and at additional mailing offices. Copyright (c) 1979 by 73, Inc. All rights reserved. No part of this publication may be reprinted or otherwise reproduced without written permission from the publisher. Microfilm Edition—University Microfilm, Ann Arbor MI 48106.

# W2NSD/1 NEVER SAY DIE

editorial by Wayne Green



## WARC RESULTS

By the time this gets into print, the WARC results will probably be known—such are the delays of the magazine biz. This is being written considerably before the event in order to set the record straight.

One of the questions which came up during my recent visit to the Philadelphia Area Repeater Association meeting in Valley Forge was my opinion of what would happen at WARC. My answer has not changed in the last couple of years... I have no opinion on what will happen... there are just too many unknowns involved. I know that I would feel a lot more positive about it if I had seen any significant evidence that amateur groups were doing something in preparation to meet some of the problems which were evident.

In my editorials and talks, I have given the facts on events which have happened which I think are pertinent and which could influence the WARC results. I try hard to make amateurs understand that these are facts of history and not my opinions. It is a fact that amateur radio went into the ITU conference on satellite frequencies with allocations for over 100,000 MHz above 500 MHz and came out with zero... nothing. This is not opinion, and it is verifiable in the most revered of sources: QST. The ARRL people admitted that they had not done their homework and this was the reason for this catastrophic loss. I think I am not exaggerating when I categorize the loss of virtually the entire future of amateur radio by satellite as catastrophic. Below 500 MHz, we also lost 90% of the 450-MHz band and 100% of the 220-MHz band for satellite use.

The maritime ITU conference in 1972 resulted in another terrible loss of frequencies by white nations as the African and Asian countries banded together, ignoring all technical

recommendations, to grab their "share" of the frequencies... no matter any intended use or not. This again is not opinion, it is a fact.

If the Third World countries get off this kick of getting everything they can at ITU meetings, we may come out okay, so when I'm asked for my predictions of what will happen, I can't be optimistic... nor can I say that I think we will lose 40m, etc. I do say this: If we do lose frequencies, we know where to place the blame for it... on those who had the responsibility to protect these frequencies and did so little in that line. Oh, they knew what had to be done, but they just didn't do it. They learned nothing from their debacle in 1971.

Should amateur radio come out with everything we have at present... plus a couple of extra bands, no one will cheer more loudly than I. And no one will be luckier than the League. I still won't be able to honestly give them one bit of credit because they have gambled with our future by not doing everything reasonably prudent to try to preserve it. Just hoping for a lucky break hardly constitutes providing the service we expect of them and pay them for.

## AN ACCOUNTING

Once this is over, I think the members should flatly demand an accounting of the funds spent in Geneva. The last I heard, they had \$140,000 in their wallet and were sending out more letters begging for money for the WARC "crew." Many angry members sent me copies of an August 31st letter... a bit late in the game for hat-passing, I'd say.

It may be almost time for League members to stop ignoring what is going on and start asking questions.

## MONSTER GREEN

Rather than come up with figures to show that I was

wrong in my questions about the ARRL living it up at the expense of the deluded members, they've chosen to attack me personally. "Green is anti-amateur radio," I hear. Or "Green is egotistically trying to torpedo ARRL participation at WARC 79."

I suggest that the facts be brought out. Either I am right about the \$100,000 fund for protecting amateur radio or I am not. And all anyone has to do is read the yearly ARRL report. Whitewashed as it is, the fund is right in there for anyone to see. If I am wrong about the fund, then I think a lot of members are due an explanation of why the fund is listed (and has been for years) in the annual reports.

Let's suppose that eventually they will admit to the fund. How then can they justify the hat-passing for more cash? This strongly suggests that they intend to spend more than \$100,000 at Geneva! How much can a couple of people spend in a few weeks? Sure, Geneva is expensive, but even at the finest hotel, which I am sure they have engaged, and at the most expensive restaurants, which I'll bet they are patronizing, it should be difficult to spend that much money in so short a time.

Say, I'm willing to bet \$100 cash that not one of the ARRL members will be able to get a list of the monies which have been spent from that \$100,000 fund since it was set up. It has been brought back to strength each year by the directors, and no report has ever been made that I have seen on where the money went which was spent. The first person to come up with a list of the expenditures, by whom, for what purpose, and when, gets my \$100. Boy, am I safe on that bet. I know what some of the money was spent for and I know it will never be made public.

My apologies to ARRL insiders for stirring up skeletons in closets, but when the direc-

tors go out to clubs and start trying to smear me, as a cover-up for their crimes of omission and commission, then I speak up.

Me anti-amateur, huh? And pro what? Let's put it this way... I will say flatly that there is not one official of the ARRL at any level who can even come close to my background in amateur radio. For those new readers who might get taken in by a director, let me give just a brief resumé of some of my ham activities.

In the DX field, I've got well over 300 countries confirmed... have visited almost 90 countries and operated from over 40. I've been active on OSCAR and have some 30 countries worked through the satellite. On 10 GHz, I have the world's record for states worked: seven. I was one of the pioneers of RTTY and wrote several of the early books on the subject. I also was an early experimenter with slow scan and forget how many countries I've worked on that mode. I had one of the early repeaters and pioneered multiband repeating... with my first work on repeaters being in 1949, thirty years ago.

How about contests? If you look back, you'll find that I've won my section several times in the Sweepstakes, DX, VHF, and other contests. Love 'em. The rarest countries I've worked from? Probably Afghanistan as YA1NSD, Nepal as an op at 9N1MM, Tahiti with my FO8AS call, Fiji as VR2FD, and Jordan as JY8AA. I will have been on from Korea as HL9WG and from Hong Kong, with call as yet unknown, in October.

These days I'm active mostly on 20, 15, 10, 2, 1 1/4 meters, and 10 GHz. But then, I lead a fairly busy life and haven't time for everything. Anti-ham? How many ARRL HQ people have you heard on the air? I haven't heard 'em and I drive right through Hartford every now and then operating on two meters.

#### FCC BEING PUT DOWN

Not only hams are getting sick of the FCC. I see more and more newspaper clippings from readers about the FCC, none complimentary. Having attended more hearings at the FCC than I like, I can see why the outfit is constipated. Some of my petitions for rule changes have been in the works for ten years and are still hanging around waiting for action.

We might be able to put up with this glacial speed if the results were well considered and fair. They are anything but. Politics is the rule of the day, along with temporary expediency.

One of the major problems at

the FCC is that it is being run by seven people, none of whom have the background needed to make decisions on the complex matters involved. This means that every problem has to be explained in tedious detail, written for the complete novice, and it also means that the writer of these details can sway legislation easily by biasing the position papers.

The FCC is trying to handle a wide range of regulations, each requiring a technical background which the commissioners do not have. The result is that some of the commissioners realize the futility of their jobs and just sit back, voting whichever way seems best, but not even trying to make sense of the situations. Some virtually sleep through the long boring hearings.

If the FCC is going to be able to make any intelligent decisions, they are going to have to find some way to get career people with the needed background into the job—not uninterested political appointees. No one can have all of the background needed, so some splitting up of the divisions is needed, with separate heads. The present system of endless oral hearings must be curbed in some way. It is just too much of a waste of time for too many people.

I think it was about a year or so ago that a reader (an old friend who used to work for me) wrote, suggesting that he start a movement to get me appointed to the FCC as a commissioner. I wrote back and said no way. I wouldn't last a week in that bureaucratic environment. I believe that the shortest distance between two points is a straight line, even if it bisects the White House and two other commissioners.

No rational body would have come up with the ten-meter linear ban, which doesn't make any sense. And now that CB sales have dwindled off to where there is virtually no problem with HFers or illegal CBers of any magnitude, I would expect the Commission to go right ahead with plans for dealer registration of ham equipment... the requirement of a ham license to buy, etc. The molasses speed of the FCC forces it to provide rules long after the need for them has gone away. Remember the repeater rules, if you will... totally unneeded when they arrived because amateurs had already solved the problems which had originally brought on the request for the rules years earlier.

Part of the trouble lies with hams. All too often I see petitions to the FCC intended to solve some temporary problem... and I know that years in

the future this petition may well cause great mischief. And then we have hams who are afraid to go ahead and experiment with something. They want to make sure that it is all okay with the FCC before they go ahead. The result of that is that the bureaucrats at the FCC are not about to open themselves to any possibility for criticism, so they say no. If the damned ham would just go ahead, but shut up about it, the chances are good that nothing would happen and then we could point to a year or two of operation using the experimental system with success and, at that time, get it okayed. Bureaucrats say no... they have to if they want pensions.

If I could see examples of our government providing benefits to us, I might be less critical. I suppose the police system we have is better than none at all, but, at times, I am not sure of this. I see people quitting work because they can make almost as much on welfare and not have any responsibility. After a couple years of that, who will ever hire them? And so it goes... many books have been written about this mess we've gotten ourselves into... and no one has even a hint as to how to get out of it.

About the only good thing you can say about our government is that, crummy as it is, we don't know of a better one anywhere.

#### WHICH ONES WORK?

Unless you are brand new to *73 Magazine*, it should come as no great surprise to you that I have a considerable interest in 10 GHz... and this even extends to the neighboring band of 10.5 GHz, where the police have set up a great little money-maker by zapping motorists. This nets them well over \$3 billion a year in cash for their municipalities, making it possible for a \$1,500 radar unit to pay for itself in a weekend!

The *73 Magazine* mobile office and portable laboratory has four different radar detectors mounted across the top of the front window. This is not so much because the lumbering Dodge van is operated above 55 mph as it is to test the ability of these units to detect signals of importance and reject those of insignificance.

The four units currently in test in the van are the Bearfinder, the Fuzzbuster, the

Super Snooper, and the Radio Shack Micronta unit. Up here in New Hampshire, we have no shortage of radar in the hands of police... in fact, virtually every state police car has one and many of the town cars sport them. A simple trip to Manchester, some 35 miles away, can often supply three or more tests of the detection devices.

One of the best we have tested recently has been the Radio Shack Micronta unit. It looks very much like the Super Snooper unit in the ads, but when ours arrived, we were surprised to find that though the shape was quite similar, the size was substantially smaller. The Micronta generally advises us of a lurking bear a second before the Fuzzbuster, which has come to be a good standard to use.

I'm partial to the Fuzzbuster for a couple of reasons... firstly, because it does always give the alert in time to check speed and slow down a hair, if needed. Secondly, this firm, Electrolert, has been by far the most active in fighting illegal laws put through to limit the use of these radio receivers.

As I've mentioned before, on most of the larger highways and turnpikes, the traffic tends to run from ten to fifteen miles per hour over the 55 limit, which means that the bears have a field day when they set up shop. The use of CB and an ear on channel 19 can save you a stiff fine, the hassle of coming back to some crummy place for a court hearing a week or two later, and an increase in your insurance premiums. It may also save your driving license.

I had a very good friend who used to go with me on sports car rallies. A cop. He said that his friends would give almost anything to get parkway duty, since this meant an added non-taxable income of several hundred dollars a day. The patrol cars kept track of commuters in expensive cars and stopped them about once a month for speeding. Unless the motorist was particularly dense, there would be a \$50 bill neatly folded within the driving license. The police would look at the license and hand it back, less the \$50.

The radar detectors are handy because it is all too easy to go along with the traffic and find yourself a few miles over the speed limit. You're not going fast enough to get there any sooner, but it is fast enough for

#### NBVM

Because of some late developments, we were unable to present in November the article on NBVM mentioned in "Never Say Die." Tim Daniel N8RK's report will be featured in our January, 1980, issue.

# Staff

**EDITOR/PUBLISHER**  
Wayne Green W2NSD/1

**EXECUTIVE VICE PRESIDENT**  
Sherry Smythe

**CORPORATE CONTROLLER**  
O. Alan Thulander

**ASSISTANT PUBLISHER**  
Jeffrey D. DeTray WB8BTH

**ADMINISTRATIVE ASSISTANT**  
Dotty Gibson

**MANAGING EDITOR**  
John C. Burnett

**ASSISTANT MANAGING EDITOR**  
Susan G. Philbrick

**NEWS EDITOR**  
Gene Smarte WB6TOV/1

**EDITORIAL ASSISTANTS**  
Elisabeth Blackmore  
Richard Phenix

**PRODUCTION MANAGER**  
Noel R. Self WB1ARP

**ASSISTANT PRODUCTION MANAGER**  
Robin M. Sloan

**ART DEPARTMENT**  
Steve Baldwin  
Bob Drew  
James H. Gray II  
Bruce Hedin  
Chip Jackson  
Ken Jackson  
Dion Owens  
Nancy Salmon  
Patrice Scribner  
John W. White

**BOOK PUBLICATIONS**  
Jim Perry

**BOOK PRODUCTION**  
Peter Perin  
Emily A. Gibbs  
Chris Brown

**PRINTING**  
Gary Steinbach, Mgr.  
Dean Zanga

**PHOTOGRAPHY**  
Bill Heydolph  
Tedd Cluff  
Terrie Anderson

**TYPESETTING**  
Barbara J. Latti  
Sara Bedell  
Sandie Gunseth

**BOOKKEEPER**  
Knud E. M. Keller KV4GG/1

**CIRCULATION**  
Pauline Johnstone

**DATA ENTRY**  
Cathy DeSilva

**CIRCULATION MANAGER**  
Harold L. Stephens

**ASSISTANT CIRCULATION MANAGER**  
Donna Taylor

**BULK SALES MANAGER**  
Judy Waterman

**SHIPPING**  
Mark Dendy  
Bill Barry

**RECEPTIONIST**  
Rhonda Clapper

**ASSOCIATES**  
Robert Baker WB2GFE  
W. Sanger Green  
Dave Ingram K4TWJ  
Larry Kahaner WB2NEL  
Joe Kasser G3ZCZ  
Bill Pasternak WA6ITF  
John Schultz W4FA  
Peter Stark K2OAW

**COMPUTER PROGRAMMING**  
Richard J. Dykema

**ADVERTISING**  
Aline Coutu, Mgr.  
Kevin Rushalko  
Nancy Ciampa  
Marcia Stone  
Cheryl McDaniel  
Jerry Merrifield  
Lori Mugford  
Rita Rivard

a ticket, court appearance, fine, and insurance increase. When the detector sounds off... which is a cacophony in the van, with four going at once... I have about one second to hit the brakes before the police radar units can read out my speed. Their radars have to read the incoming Doppler audio tone and change it to miles per hour. This takes a couple of seconds. If the target car is changing speed, the radar unit can't get a fix on it, so you always have time to slow down, if you are properly warned.

If it wasn't for the 55 mph speed limit, I doubt if I would even have the van. It burns gasoline ridiculously, averaging about 11 miles to the gallon. But it has a 36 gallon tank, so we have a range of nearly 400 miles with it. When someone else is driving, I can read manuscripts, answer letters, keep up with literature, and things like that... all without the constant interruption of the telephone.

For faster trips, we generally use the Mazda RX-7... which we like very much. There are only three radar detectors on it normally... a Fox, a Whistler, and a Bearfinder. The Whistler sometimes sounds off when within twenty feet of a radar transmitter and on the more severe bumps... but that's all. The Fox and Bearfinder are about even. The RX-7 burns less than one gallon of gas for every 20 miles when driven at speed (80 mph), even with air-conditioning and automatic shift.

The Fox and the Micronta are pretty close when I plug a Fox into the van system for a comparison. It is difficult to see any real difference in sensitivity... both are very good.

Like many other gadgets, once you get used to the warnings from a radar detector, you feel worried without it. Since I'm often chatting away on two meters while I'm driving, generally keeping up with traffic unless I am in a hurry for an appointment, I don't keep my eye on the speed at all times. The warning buzz is appreciated and often saves me a brush with the government.

## JAMMING—CAN ANYTHING BE DONE?

Who can fail to get angry when they hear amateurs trying to jam out an emergency net during an earthquake or hurricane? Sure enough, right in the middle of a recent extended period of critical traffic handling, there were some jammers making life miserable for everyone. I understand that the FCC was called and, using their sophisticated direction-finding equipment, quickly located the scoundrels.

Jamming is certainly nothing

new in amateur radio and perhaps it is past time to bring it out in the open and stop pretending that it isn't happening. By discussing it, we may be able to better come to grips with the problem... and also come up with some plans for dealing with it.

Though there are obviously some common causes and common remedies which apply to jamming, we may be able to tackle the phenomenon better if we break it down into categories. We have the jamming of emergency nets, probably one of the worst types of jamming. Then there is the jamming of what we term service nets... such as the Eastcars, Midcars, and Westcars nets. We also have jamming of just plain nets. We have jamming of special modes such as RTTY and SSTV, a sort of specialized breed of jammer. And most of us are familiar with the kerchunker on repeaters... and we've even heard the bad-language fan lousing up repeaters.

In addition to those jammers, we have a whole host of jammers working in our DX bands... and I'm not speaking about commercial or military stations which are intruding. I'm talking about your sanctimonious DX chaser who slams his signal into a pileup, knowing full well that it is flatly against the law to intentionally interfere with another operator. In this case, jamming is not only condoned, it is a way of life, complete with high-powered amplifiers and giant antenna arrays, all set up with the sole purpose of being able to jam the hell out of several dozen other stations who are trying to reach a choice DX station. Choice, did I say? I've heard pileups on a YV or even a DL when there is nothing rarer to fight over.

## WHY?

In some cases, there is obviously a screw loose in a ham's head. They don't give tests of sanity when they hand out ham tickets, so we have our share (and more) of loonies. I've heard more than one ham wife claim that all hams are nuts and, after forty years of this and knowing several thousand hams personally, I'm in no shape to argue the point. I know there are hordes of hams who would sign commitment papers for me if they were passed around.

But let's get down to the nitty-gritty... why this happens. I'm immediately reminded of a time when I was operating from Curacao (PJ3) and I checked the band carefully for a relatively empty spot... found one... asked twice if anyone was using it... called CQ and got into a contact. About five minutes into the QSO, a woman

from Florida broke in on the channel and demanded that I get off the frequency immediately, saying that I had one hell of a nerve operating there, since this was the YL International Phone Net channel. Without giving me a chance to say anything, she proceeded to make a ten-minute call for net members to gather... and got some. If ever I wanted to jam a net, that was it.

There is no question but that there are times when a repeater control operator is unobtrusive and considerate and the repeater still gets jammed, but in every case I've heard personally, this was not the case. I've heard dozens of jammings of repeaters, but I've also heard some of the stuff that precipitated the jamming... usually a very arrogant control op who has made someone mad. In other cases, I've heard whole groups join in to aggravate a poor situation and make it impossible.

Something happens to many (if not most) people when they get power over others, even if it is so insignificant as being a net control or a repeater control operator. They seem to immediately forget what it is like for the other chap, and they start throwing what weight they have around. This often calls for retaliation... and we have jamming. I'd be surprised if 90% or better of the jamming hasn't been instigated by an officious operator who has a severe personality problem... like a well-deserved inferiority complex... who irritates someone else beyond their capacity of acceptance. Oh, I know the feeling... for instance, when someone comes on a repeater where I've been talking for a while and says in an official voice that it is an FCC regulation that I identify my station.

## WHAT TO DO

For many amateurs, the first port in a jamming storm is a call to the FCC for help. Then they get all bent out of shape when they find that the FCC boys have better things to do than help us find some yo-yo we've irritated who is busy "getting even."

Speaking of nets, it may come as a rude shock and chilling news, but the FCC has a rule which is fairly explicit... no ham, or even net, has a claim to a frequency. The fact that a net has used the same channel daily for fifty years is not an excuse for running roughshod over any stations who are using it come net assembly time. I would suggest that one or two stations be designated to act as peaceful

Continued on page 229

# Welcome to the World of Kenwood.



7 Full pages  
of Products  
& Accessories



## TS-180S with DFC

The TS-180S with DFC (Digital Frequency Control) is Kenwood's top-of-the-line all solid-state HF SSB/CW/FSK transceiver covering 160 through 10 meters, with outstanding performance and many advanced functions, including four tunable memories to provide more operating flexibility than any other rig!

### TS-180S FEATURES:

- Digital Frequency Control (DFC), including four memories and digital up/down paddle-switch tuning. Memories are usable in transceiver or split modes, and can be tuned in 20-Hz steps up or down, slow or fast, with recall of the original stored frequency. (Also available without DFC.)
- All solid-state; 200 W PEP/160 W DC input on 160-15 meters, and 160 W PEP/140 W DC on 10 meters.
- Improved dynamic range, with improved circuit design and RF AGC ("RGC"), which activates as an automatic RF attenuator to prevent receiver overload.
- Adaptable to three new bands, and VFO covers more than 50 kHz and DFC 100 kHz above and below each band.
- Built-in microprocessor-controlled digital display. Shows actual frequency and switches to show the difference between the VFO and "M1" memory frequencies. Blinking decimal points indicate "out of band." (An analog monoscale dial is also included.)
- IF shift (passband dialing to eliminate QRM).
- Dual SSB filter system (second filter is optional) to provide very sharp receiver selectivity, improved S/N, and 30 dB compression with RF speech processor on transmit.
- Tunable noise blanker, to eliminate cross modulation from strong signals when noise blanker is on.
- Selectable wide and narrow CW bandwidth on receive (500-Hz CW filter is optional).
- SSB normal/reverse switch (proper sideband is automatically selected with band switch).
- Dual RIT (VFO and memory/fix).
- Available without DFC. Digital frequency display still included, with differential function showing difference between VFO and "digital hold" frequencies.

### OPTIONAL ACCESSORIES:

- DF-180 digital frequency control (for TS-180S without DFC).
- YK-88CW 500-Hz CW filter.
- YK-88SSB second filter for dual-filter system.



MC-50

PS-30

SP-180

TS-180S

VFO-180

AT-180



## TS-120S



(MC-35S  
MIKE  
OPTIONAL)

Truly a "big little rig," the TS-120S has created a new excitement in HF communications for highly versatile Amateur operation. The compact, all solid-state 80-10 meter transceiver, with up to 200 watts PEP input, requires no tuning and includes a large digital readout, making it ideal for mobile operation. IF shift and other important features make it a high-quality rig for the ham shack as well.

### TS-120S FEATURES:

- All solid-state with wideband amplifier stages. No final dipping or loading, no transmit drive peaking, and no receive preselector tuning.
- Transceives on 80 through all of 10 meters, and receives WWV on 15 MHz.
- 200 W PEP/160 W DC input on 160-15 meters, and 160 W PEP/140 W DC on 10 meters. LSB, USB, and CW.
- Digital frequency display (standard) shows actual frequency. Backup analog subdial also included.
- IF shift (passband tuning) to eliminate QRM.
- Advanced PLL circuit, with improved stability and spurious characteristics on transmit and receive.
- Effective noise blanker.
- Built-in cooling fan, which activates automatically when final-amplifier heatsink temperature rises to 90° C.
- Protection circuit for final transistors.
- VOX.

### OPTIONAL ACCESSORIES:

- YK-88CW 500-Hz filter.
- MB-100 mobile mount.



## AT-120

AT-120 antenna tuner with mobile mounting bracket included. Features SWR meter and matches 50-ohm input to 20-300 ohms unbalanced output. Handles 150 watts (120 watts on 80 meters).



## TS-520SE

The TS-520SE is an economical version of the TS-520S...the world's most popular 160-10 meter Amateur transceiver. Now, any Amateur can afford a high-quality HF transceiver for his ham shack.

### TS-520SE FEATURES:

- Covers 160-10 meters and receives WWV on 15 MHz.
- 200 W PEP input on SSB and 160 W DC on CW.
- CW WIDE/NARROW bandwidth switch, for use with the optional CW-520 500-Hz CW filter.
- Digital display with optional DG-5, showing actual frequency.
- Speech processor, effective in DX pileups.
- VOX and semi-break-in CW with sidetone.
- Built-in 25-kHz calibrator.

### OPTIONAL ACCESSORIES:

- CW-520 500-Hz CW filter.
- AT-200 antenna tuner.

The TS-520S is still available, with DC (mobile) operating capability (with the optional DS-1A DC-DC converter) and transverter terminals, which were eliminated from the TS-520SE.

# R-820/TS-820S



SP-820

R-820

TS-820S

## TS-820S

The TS-820S is a very popular 160-10 meter SSB/CW/RTTY transceiver, preferred by DX operators and other particular Amateurs. It employs a single-conversion PLL circuit.

### TS-820S FEATURES:

- 200 W PEP SSB/160 W DC CW/100 W DC FSK input on 160-10 meters.
- Digital frequency display, with backup monoscale analog dial.
- IF shift (receiver passband tuning) to eliminate interference.

- RF speech processor.
- Effective noise blanker.

### OPTIONAL ACCESSORIES:

- CW-820 (YG-88C) 500-Hz CW filter.
- DS-1A DC-DC converter.
- AT-200 antenna tuner.



SP-820

TS-820S

VFO-820

## R-820

The R-820 is a highly sophisticated HF receiver for the Amateur who wants the highest quality with the most operating features. A combination of the R-820 and TS-820S provides the ultimate HF operating system.

### R-820 FEATURES:

- Full transceive operation with TS-820S, providing full frequency control with either unit.
- Covers 160-10 meters, as well as WWV (15.0-15.5 MHz), and four shortwave broadcast bands (49, 31, 25, and 16 meters).
- Receives SSB, CW, AM, and RTTY modes.
- Double-tuned RF stages and improved dynamic range.
- IF shift (passband tuning).
- Variable bandwidth tuning (VBT).
- Very sharp, deep notch circuit... in 50-kHz IF.
- Provisions for extra-sharp 455-kHz IF filters.
- Noise-blanker with variable threshold level.
- Digital frequency display, with backup analog dial.

### OPTIONAL ACCESSORIES:

- YG-88C 500-Hz CW filter, for first IF.
- YG-88A 6-kHz AM filter, for first IF.
- YG-455C 500-Hz filter, for second IF.
- YG-455CN 250-Hz filter, for second IF.



TV-502S TV-506  
(not for TS-520SE)

AT-200

## ACCESSORIES FOR TS-820 AND TS-520 SERIES

AT-200 antenna tuner handles 200 W, 160-10 meters.  
TV-502S 2-meter transverter covers 144-146 MHz. (Not intended for TS-520SE.)  
TV-506 6-meter transverter covers 50-54 MHz. (Not intended for TS-520SE.)



## TL-922A

The TL-922A linear amplifier for all Kenwood HF equipment provides maximum legal power on the 160-15 meter Amateur bands, employing a pair of EIMAC 3-500Z high-performance transmitting tubes.

### TL-922A FEATURES:

- 2000 W PEP (SSB)/1000 W DC (CW, RTTY) input power on 160-15 meters, with 80 W drive.
- Excellent IMD characteristics.
- Safety protection.
- Blower with automatic delay circuit.
- Variable threshold level type ALC.



## SM-220

The SM-220 Station Monitor is capable of various monitoring functions, and performs as a wideband oscilloscope, and is expandable for pan-display operation.

### SM-220 FEATURES:

- Monitors transmitted SSB and CW waveforms from 1.8 to 150 MHz.
- High-sensitivity, wide-frequency-range (up to 10 MHz) oscilloscope.
- Monitors received signals in IF stage.
- Tests linearity of linear amplifiers (provides trapezoid pattern).
- Allows observation of RTTY tuning points (cross pattern).
- Built-in two-tone (1000-Hz and 1575-Hz) generator.
- Expandable to pan-display capability for observing the number and amplitude of stations within a switchable  $\pm 20$  kHz/ $\pm 100$  kHz bandwidth.

### OPTIONAL ACCESSORIES:

- BS-8 pan-display module for TS-180S and TS-820 series.
- BS-5 pan-display module for TS-520 series.

# R-1000



SP-100

R-1000

The R-1000 is a highly advanced communications receiver. Up-conversion, PLL circuitry and other new technology provide optimum sensitivity, selectivity, and stability from 200 kHz to 30 MHz. Featuring easy-to-operate single-knob tuning and digital frequency display, it's perfect for listening to shortwave, medium-wave, and long-wave bands. Even SSB signals are received perfectly. Included is a quartz digital clock and timer.

## R-1000 FEATURES:

- Continuous frequency coverage from 200 kHz to 30 MHz.
- 30 bands, each 1 MHz wide.
- Five-digit frequency display and illuminated analog dial.
- Quartz digital clock and ON/OFF timer.
- Multi-modes... AM (wide and narrow), SSB (USB and LSB), and CW.
- Three IF filters... 2.7 kHz for SSB and CW, 6.0 kHz for AM narrow, and 12 kHz for AM wide.
- Effective noise blanker.
- Built-in speaker.
- Three antenna terminals.
- RF step attenuator.
- Tone control.
- Recording terminal.
- Remote terminal, for access to timer relay ON/OFF circuit and muting circuit.
- SSB sensitivity of 0.5  $\mu$ V from 2 to 30 MHz.
- More than 60 dB IF image ratio.
- More than 70 dB IF rejection.



# R-300

## R-300 FEATURES:

- Continuous frequency coverage from 170 kHz to 30 MHz, in six bands.
- Multi-modes... AM, SSB, and CW.
- High sensitivity, selectivity, and image ratio.
- 500-kHz marker.
- Three-way power supply (AC/batteries/external DC), with automatic switching from AC to DC in the event of AC power failure.

The R-300 all-band communications receiver covers 170 kHz to 30 MHz in six bands. It's ideal for listening to foreign broadcasts and other exciting transmissions throughout a wide range of the radio spectrum.



## TR-7600

## TR-7625



## KPS-7

The TR-7600 and TR-7625 are Kenwood's popular synthesized 2-meter FM mobile transceivers. Combined with the RM-76 Microprocessor Control Unit, several memory and scanning capabilities are provided.

The KPS-7 is a matching AC power supply for the TR-7600 and TR-7625. Output is 13.8 VDC at 7 A ICS (50% duty cycle).



## RM-76

### TR-7600/TR-7625 FEATURES:

- One memory channel.
- Mode switch for simplex or repeater operation. Repeater mode shifts the transmit frequency + 600 kHz or - 600 kHz or to the memory frequency.
- Full 5-kHz coverage from 144.000 to 147.995 MHz.
- Adaptable to any one MARS simplex or repeater channel between 143.7 and 148.3 (with modification kit).

### ADDED FEATURES WITH RM-76:

- Six memories.
- Automatic memory scan.
- Automatic scan up the band in 5-kHz steps, with selectable upper and lower frequency limits.
- Manual scan up or down the band in single or

fast continuous 5-kHz steps.

- $\pm 1$  MHz transmitter offset as well as  $\pm 600$  kHz and memory offset for repeater operation.
- MARS operation on 143.95 MHz simplex.
- Versatile digital display of transmit and receive frequencies, and operating functions.

# TR-2400

The TR-2400 synthesized 2-meter hand-held transceiver features a large LCD frequency readout, 10 memories, scanning, and much more.

### TR-2400 FEATURES:

- Large, illuminated LCD digital frequency readout. Readable in direct sunlight, and a lamp switch makes it readable in the dark. Shows receive and transmit frequencies and memory channels, and indicates "ON AIR", memory recall, battery status, and lamp switch on.
- 10 memories, with battery backup.
  - Automatic memory scan, for "busy" or "open" channels.
  - Mode switch for simplex,  $\pm 600$  kHz transmit repeater offset, and memory-frequency ("M O") transmit repeater offset.
  - REVERSE momentary switch.
  - Built-in 16-button Touch-Tone generator.
  - Keyboard selection of 5-kHz channels from 144.00 to 147.995 MHz.



ST-1

- Up/down manual scan and repeater or simplex operation from 143.900 to 148.495 MHz in single or fast continuous 5-kHz steps.
- Two lock switches to prevent accidental frequency change and accidental transmission.
- Subtone switch (subtone module not Kenwood supplied).
- More than 1.5 W RF output.
- High-impact plastic case and zinc die-cast frame.
- BNC antenna connector.
- Standard accessories included with the TR-2400 are a flexible rubberized antenna with BNC connector, ni-cad battery pack, and AC charger.

### OPTIONAL ACCESSORIES:

- Attractive leather case.
- Model ST-1 base stand, which provides 1.5-hour quick charge, trickle charge, and base-station operation with microphone connector and impedance-conversion circuit for using MC-30S microphone.
- Model BC-5 DC quick charger.



TOP CONTROLS

## TS-700SP



SP-70

TS-700SP

VFO-700S

The TS-700SP is an all-mode (SSB, FM, CW, and AM) solid-state transceiver covering the entire 2-meter band, including repeater operation on all sub-bands. It's the perfect rig for the serious 2-meter Amateur.

### TS-700SP FEATURES:

- All modes...SSB (USB and LSB), FM, CW, and AM.
- VFO tuning from 144 to 148 MHz in four bands.
- Seven-digit readout of receive frequency, with 100-Hz resolution. (Last digit can be eliminated automatically in the FM mode.)
- Simplex and repeater operation, including all repeater subbands. Switchable to REVERSE mode.
- Built-in receiver preamplifier.
- AC/DC capability, for fixed or mobile operation.
- 44 fixed channels with 11 crystals.
- Multifunction meter...S-meter on all receive modes, zero-center meter on FM receive, and RF transmit.
- High-low power switch (10 W/1 W).
- RIT for both VFO and fixed channels.
- Effective noise blanker.

## TS-600



SP-70

TS-600 W/VOX-3

The TS-600 is an all-mode (SSB, FM, CW, and AM) solid-state transceiver covering the entire 6-meter band. It's the ideal transceiver to enjoy the many exciting propagation conditions on 6 meters.

### TS-600 FEATURES:

- All modes...SSB (USB and LSB), FM, CW, and AM.
- VFO tuning from 50 to 54 MHz in four bands. Main dial graduated at 1-kHz intervals.
- AC/DC capability, for fixed or mobile operation.
- 20 fixed channels with five crystals.
- Effective noise blanker.
- 100-kHz marker.
- Multifunction meter...S-meter on all receive modes, zero-center meter on FM receive, and RF on transmit.
- RIT for both VFO and fixed channels.
- 20 W PEP input on SSB, 10 W output on CW and FM, 5 W output on AM.

### OPTIONAL ACCESSORY:

- VOX-3, to provide VOX and semi-break-in CW operation.



## TR-8300

### TR-8300 FEATURES:

- Covers 445.0-450.0 MHz (transmit) and 442.0-447.0 MHz (receive).
- 23 channels, three supplied (446.0 MHz simplex, 446.5 MHz simplex, and 449.10 MHz transmit/444.10 MHz receive).
- Five-section helical resonator and two-pole crystal filter in receiver IF, for improved intermodulation characteristics.
- Call channel switch, for user-desired function (such as subtone).
- High-low power switch (10 W/1 W).
- Monitor circuit, to allow listening to modulation while making frequency adjustments.

The TR-8300 mobile FM transceiver operates in the 70-cm band, on 23 crystal-controlled channels (three supplied). Transmitter output is 10 watts, and a very sensitive and selective receiver is provided.

## OPTIONAL ACCESSORIES



PC-1 phone patch.



MC-50 dynamic dual-impedance (50 k $\Omega$ /500 $\Omega$ ) desk microphone.



MC-30S (500 $\Omega$ ) dynamic noise-cancelling hand microphone. Also available, MC-35S (50 k $\Omega$ ).



MC-45 Touch-Tone (with automatic transmit) microphone.



HS-5 deluxe 8 $\Omega$  headphone set.



HS-4 8 $\Omega$  headphone set.



MB-100 mobile mount for TS-120S.

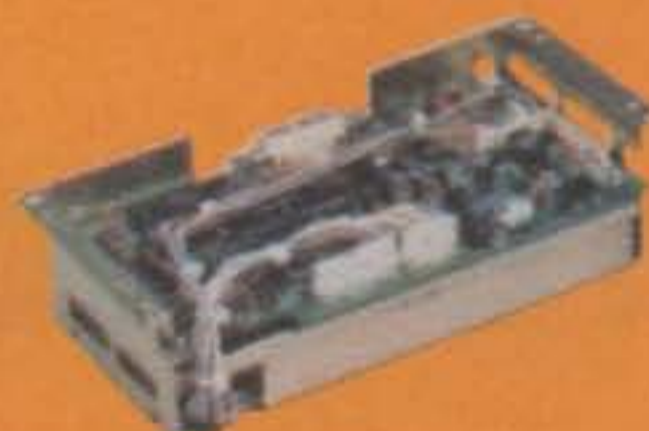

DF-180 digital frequency control for TS-180S without DFC.



DG-1A digital counter/display for TS-820.



DS-1A DC-DC (mobile) converter for TS-820S/TS-520S (not for TS-520SE).



BS-8 (for TS-180S and TS-820S) and BS-5 (for TS-520 series) SM-220 pan-display



YK-88CW 500-Hz CW filter for TS-180S/TS-120S and YK-88SSB IF SSB filter for TS-180S dual-filter system.



CW-820 (YG-88C) 500-Hz CW filter for TS-820S/R-820.  
CW-520 500-Hz CW filter for TS-520 series.



YG-88A 6-kHz AM filter, YG-455C 500-Hz CW filter and YG-455CN 250-Hz CW filter for R-820.

# MFJ ✓ M52 ANTENNA TUNERS



**\$69<sup>95</sup>**

**NEW MFJ-940 VERSA TUNER II** matches coax and random wire 1.8 to 30 MHz.

Up to 300 watts RF OUTPUT. SWR, dual range wattmeter (300 and 30 watts full scale).

Six position antenna switch on rear. Select 2 coax lines direct or thru tuner, random wire, and tuner bypass for dummy load.

New efficient airwound inductor (12 positions) gives you less losses than tapped toroid for more watts out. 8x2x6 inches. SO-239 coax connectors. 208 pf, 1000 volt capacitors.

Optional mobile mounting bracket, add \$3.00.

Beware of imitators. When you buy MFJ you buy proven MFJ quality . . . and a one year unconditional guarantee.



**\$39<sup>95</sup>**

**MFJ-900 ECONO TUNER** matches coax, random wires. Full band coverage 1.8 to 30 MHz. Up to 200 watts RF OUTPUT. Efficient airwound inductor gives more watts out than tapped toroid.

SO-239 coax connectors. 5x2x6 inches. One year unconditional guarantee.

MFJ-901 Versa Tuner available. Same as MFJ-900 but has 4:1 balun for balanced lines, \$49.95.

Beware of imitators. Some are still copying our earlier models. MFJ has made improvements.

For example, a new efficient airwound inductor gives you less losses than a tapped toroid for more watts out and plenty of inductance for full band coverage 1.8 to 30 MHz.

**\$29<sup>95</sup>**



**MFJ-16010 RANDOM WIRE TUNER** lets you operate 1.8 to 30 MHz with random wire. Up to 200 watts RF OUTPUT. Small enough to carry in your hip pocket. Ultra compact 2x3x4 inches.

Match low and high impedances by interchanging input and output. SO-239 coax connectors.

One year unconditional guarantee.

Order from MFJ and try it. If not delighted, return within 30 days for refund (less shipping).

Order yours today. Call toll free 800-647-1800. Charge VISA, MC. Or mail check, money order. Add \$3.00 each for shipping.

**CALL TOLL FREE . . . 800-647-1800**

For technical information, order/repair status, in Miss., outside continental USA, call 601-323-5869.

**MFJ ENTERPRISES, INC.**  
BOX 494, MISSISSIPPI STATE, MS 39762

# Antenna Tuner

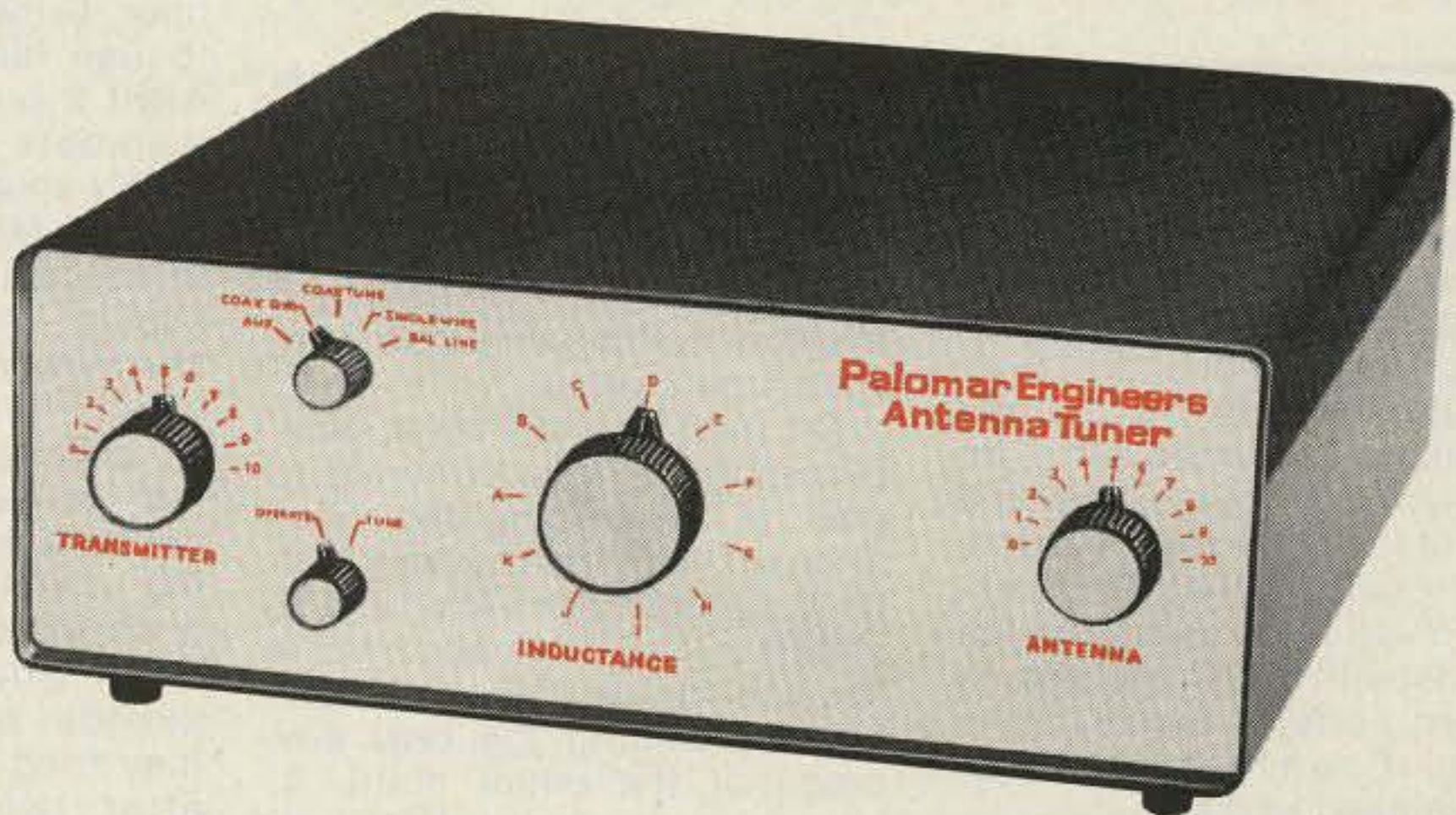

**\$299.95**

Here is a new tuner that puts more power into your antenna, works from 160 through 10 meters, handles full legal power and then some, and works with coax, single wire and balanced lines. And it lets you tune up without going on the air!

## WE INVESTIGATED

All tuners lose some rf power. We checked several popular tuners to see where the losses are. Mostly they are in the inductance coil and the balun core.

So we switched from #12 wire for the main inductor to 1/4" copper tubing. It can carry ten times the rf current. And we've moved the balun from the output, where it almost never sees its design impedance, to the input where it always does. Thus more power to your antenna.

## IMPOSSIBLE FEAT

The biggest problem with tuners is getting them tuned up. With three knobs to tune on your transceiver and three on the tuner and ten seconds to do it (see the warning in your transceiver manual) that's 1 1/2 seconds per knob.

We have a better way; a built-in 50-ohm noise bridge that lets you set the tuner controls without transmitting. And a switch that lets you tune your transmitter into a dummy load. So you can do the whole tuneup without going on the air. Saves that final; cuts QRM.

## BROCHURE AVAILABLE NOW

For further details on this exciting new high-power low-loss, easy-to-use tuner send for our new brochure. Or visit your Palomar Engineers dealer.

To order send \$10 shipping/handling. California residents add sales tax.



# Palomar Engineers

Box 455, Escondido, CA. 92025 • Phone: [714] 747-3343

ou goons don't ever proof  
lousy manuscripts from bab  
burh n' r'ok p' e' i' n  
you li' d' y' e' r' t' i' n  
I insist that you print ev  
tell Ma Bell that she shou

## GODBOUT

Recently, due to failure of one or more RAM chips in my TRS-80, which had been purchased from Godbout (Bill Godbout Electronics) 10 months previously, I returned all eight chips to Godbout under the terms of their one-year's warranty. I requested that they test these chips to determine which were defective and replace as required. I offered to pay for the testing, if necessary, as I was not equipped to do so.

I was pleasantly surprised to receive within a week a complete eight-chip RAM kit from Godbout—no charge whatsoever, and postage paid! Now, I am sure that all eight original chips were not defective and can conclude only that once again Godbout is performing in their characteristic "the-customer-must-be-pleased" manner.

This attitude will go far to ensure the future success of this outstanding supplier.

Arch Wicks W6SWZ  
Agoura CA

## DAVID

Here is some updated material regarding the emergency operation of the Florida Crown Net (Jacksonville) and the Florida Midday Traffic Net (FMTN) during hurricane David Sept. 2-5th.

Local Red Cross Director Buck Willocks of Jacksonville praised the amateurs saying, "If there was any one group who shined during the emergency, it was the amateur radio operators of this community." He was referring to the 55 operators who volunteered to link the 16 Red Cross evacuation shelters to Red Cross HQ. Personal commendation certificates are being given to each participant. In addition, stations were set up at Civil Defense HQ, the Weather Bureau, WTLV-Channel 12 studios, and the Mayor's office.

Jacksonville Mayor Jake Godbold and his staff also expressed their deep appreciation and it is reported that the Mayor will attempt to visit at least two local amateur clubs, The North Florida Amateur Radio Society (NOFARS) and the Jacksonville RANGE Assn., to express his

thanks personally. City officials monitored the transmissions on two meters to get the latest evacuation count.

Telephone lines at Red Cross were completely jammed and the only communications were via amateur radio.

On the statewide level, complimentary reports continue to pour in concerning the operation of the Florida Midday Traffic Net on 40 meters (day) and 75 meters (night). The net stayed in session for over 55 continuous hours providing the only coverage of the entire state. At least three major Weather Bureau offices in Florida were linked together by FMTN.

Ironically, the FMTN was kicked out of the ARRL last month because, after 23 years of operation, they refused to accept the SCM's wish to dissolve the net administration and have all officers appointed by him. Please see the following for additional information.

Billy Williams N4UF  
Assistant Manager, FMTN  
Jacksonville FL

## STATE ARRL OFFICIAL KICKS FLORIDA MIDDAY TRAFFIC NET OUT OF LEAGUE

On August 11th, ARRL South Florida Section Communications Manager (SCM) Woodrow "Woody" Huddleston informed Florida Midday Traffic Net (FMTN) Manager Al Suhr WB4AID that FMTN was no longer a part of the American Radio Relay League (ARRL).

In his letter, Huddleston gave no other reason for the revocation of the ARRL section of Florida's largest traffic net other than to say that the "FMTN does not qualify as either a section net or a local net in the ARRL National Traffic System. The net and its management have steadfastly refused to respond to the wishes of the ARRL Administration within this section. Therefore, I cannot justify expending ARRL funds issuing certificates to FMTN members," said Huddleston.

This last statement is considered enlightening because most FMTN members are ARRL members.

To summarize, after 22 years of operation, the FMTN was asked by Huddleston to hand over control of the net and the frequency to him last Septem-

ber. He said that he felt uncomfortable with so many nets operating in "his" section. The FMTN members voted 55 to 2 for rejecting Huddleston's demands.

Shortly thereafter, Huddleston was instrumental in establishing a new net just four kHz up in frequency at the same hour. Evidently, he was hoping to use his influence and the ARRL's prestige to lure FMTN members away since most FMTN members belong to the League. Most officials expected this to happen, but, surprisingly enough, the opposite occurred. The new net, called the Combined Florida Net (CFN), created more hard feelings by "clearing" its 7,251 kHz frequency at net time by just opening up on top of stations already in QSO. It seems that Huddleston and CFN underestimated the strength of those upon whom they tried to trample, because after two rocky ineffective months in which several sessions were cancelled, the CFN was forced to move just to survive.

Despite the move, CFN continued to falter as daytime traffic operators rallied behind FMTN and its democratic stand. FMTN has been the top net of any in Florida for the last 11 months running, based on official statistics in *Florida Skip*, in messages per session handled. The long anticipated wilting of FMTN was not to be, as many operators became incensed about losing their right to elect their own manager and not have it dictated by Huddleston. CFN went begging for traffic while people waited in line to pass messages on FMTN. A telephone campaign by some Florida ARRL officials to recruit CFN members also was a dismal failure.

When the latest *Skip* statistics showed FMTN on top again last month, it must have been more than Huddleston could take. After failing to get FMTN cut out of the national nets, he sent the letter expelling FMTN from the ARRL because they wouldn't let him take over.

For the 70 FMTN members, reaction was immediate. Included among the members are several club presidents and officers statewide. Comments ranged from "dumb" to "smacking of a dictatorship" describing Huddleston's action.

The big sting came last December when one member of the then-new CFN net was told by a North Florida ARRL official that he couldn't eat at 5 pm any more because he was needed to make the new system of nets work in conjunction with linking CFN with a later net. A lengthy shouting match occurred on the CFN frequency with the poor

soul saying he just wanted to continue eating at 5 o'clock as he had done for the last 25 years. Fortunately, it's all on tape so it can't be denied.

We have no reaction from North Florida ARRL officials on Huddleston's mass ejection, but they have backed him up in the past to the point that some have said that the statewide policies are all made by Huddleston in Largo and rubber-stamped in the rest of the state. It will be interesting to see if this holds true now.

Meanwhile, Florida Midday Traffic Net officials have declared themselves an independent net whose members operate on the legal basis of their FCC licenses and not through the sanction of the ARRL. Meanwhile, the controversy continues about the tactics involved and daytime operators continue to support FMTN in growing numbers.

This may be one case where David rises up and slaps Goliath!

From NOFARS *Balanced  
Modulator*, September, 1979

## DRIVEL

Although I have long been an admirer of you and *73 Magazine*, one who has enjoyed your growling and caustic comments, all of which put amateur radio on its toes, made us aware, and stirred amateurs into thinking for themselves, I wonder what has happened to 73 et al this past year. I am really doubting the values and goals some of your articles are exhorting. Also, it sure seems as if you are dumping the average amateur, the guy without the megabucks, for the manufacturer and big interests. Maybe you no longer need the individual ham as long as you have the big or seemingly big, the manufacturer, and the guy who calls building a ham station or minicomputer an assembly of components. It sure looks like the so-called builders merely plug in boards and equipment according to many of your articles (or build power supplies).

Another trend in 73 that is really disturbing has been Pasternak, and his trying to foist on us control of FM and amateurs by clique-appointed committees with power to have yea or nay over other hams. Let's leave California and its dubious means of operation on the earthquake side of the mountains. Also, I object to his begging support of HFers as he tries to tell us how wonderful they are.

Then we get articles on jamming police radar and the re-

Continued on page 226



# "THE INFLATION FIGHTER"

## Top Performance For The Budget-Minded Amateur

### Analog Model FT-101Z



If economy is an important consideration, and you don't need the frequency counter and digital display, then choose the FT-101Z. The precision VFO gear mechanism is coupled to an easy-to-read analog display, providing resolution to greater than 1 kHz. All other features—the variable IF

bandwidth, RF speech processor, superb noise blanker, VOX—are identical to the FT-101ZD. Yaesu gives you greater choice, so that you don't have to pay for what you don't need! The counter and digital display can be added to your FT-101Z at a later date, if you wish.

## Specifications : FT-101Z

### GENERAL

**Frequency coverage:** Amateur bands from 1.8–29.9 MHz + WWV/JJY (receive)

**Emission types:** LSB, USB, CW

**Power requirements:** AC 100/110/117/200/220/234 volts, 50/60 Hz, DC 13.5 volts, negative ground (with optional DC-DC converter installed)

**Power consumption:** AC 85 VA receive (73 VA HEATER OFF) 330 VA transmit, DC 5.5 amps receive (1.1 amps HEATER OFF) 21 amps transmit

**Case size:** 345(W) x 157(H) x 326(D) mm

**Weight:** Approx. 15 kg.

### RECEIVER

**Sensitivity:** 0.25  $\mu$ V for S/N 10 dB

**Selectivity:** SSB 2.4 kHz at -6 dB, 4.0 kHz at -60 dB. CW (with optional CW filter: 600 Hz at -6 dB, 1.2 kHz at -60 dB)

**Image rejection:** Better than 60 dB (160–15 m), better than

50 dB (40 m)

**IF Bandwidth:** Continuously variable from 2.4 kHz to 300 Hz, using two 8-pole IF filters

**Audio output:** 3 watts at 10% THD into 4 ohms.

### TRANSMITTER

**Power input:** 180 watts DC

**Carrier suppression:** Better than 40 dB

**Unwanted sideband suppression:** Better than 40 dB (14 MHz, 1 kHz modulation)

**Other spurious radiation:** Better than 40 dB down

**Third order distortion products:** Better than 31 dB down

**Transmitter frequency response:** 300 – 2700 Hz (-6 dB)

**Antenna output impedance:** 50–75 ohms, unbalanced.

**Microphone input impedance:** 500–600 ohms (low impedance)

**Note:** FT-101Z (analog) cannot be used with the FV-901DM, as there is no frequency display.

Price And Specifications Subject To Change Without Notice Or Obligation



✓Y1

**YAESU**  
**The radio.**

YAESU ELECTRONICS CORP., 15954 Downey Ave., Paramount, CA 90723 • (213) 633-4007  
YAESU ELECTRONICS Eastern Service Ctr., 9812 Princeton-Glendale Rd., Cincinnati OH 45246

# Looking West

Bill Pasternak WA6ITF  
24854-C Newhall Ave.  
Newhall CA 91321

On Saturday, September 22, 1979, it was announced that the nation's second oldest repeater, currently operating under the callsign WA6KOS/RPT on Mt. Wilson, would be permanently terminating operation on or about October 13. The announcement came in the form of a letter from system equipment owner/sponsor Burt Weiner K6OQK, in which it was stated that after 18 years of continuous operation, he had proven to himself that he could make a system function and do so at the extreme limits of the state of the art available. Further, that due to the increasing amount of willful and malicious interference, with him as a prime target of it on a personal level, he had reached the decision that it was time to terminate the operation and proceed in other directions.

The system now known as WA6KOS/RPT started life as WA6TDD in 1962. It was put into service as an open repeater and has remained such ever since. Docket 18803 caused a call-sign change in 1972 and WA6TDD became known as WR6ABE. In 1976, Burt Weiner bowed out of the responsibility of licensee of the repeater, turning that obligation over to Bob Thornburg WB6JPI. At that time, the system became known as WR6AMD. Some 10 months ago, Bob bowed out of the position of licensee and the reins went to David Faraone WA6KOS whose callsign now appears on the system. Throughout these latter years, Burt Weiner has remained as equipment owner and has maintained the system's high technical standards for the licensees who followed him.

In his letter to Faraone and the repeater's users (about 450), he stated that though he has tried to remain a disinterested party in the operation of the system, he could not, and with the increasing amount of personal abuse being hurled at him, he realized that the only way to solve the problem was for him to take the system out of service and disappear from the scene entirely. He hopes that, in time, those now abusing both him and his equipment will forget that he ever existed.

In commenting on the demise of WA6KOS, Faraone also stated his intention to establish a new repeater and to commence operation when Burt removes his system from service. The

new repeater, again under the callsign WA6KOS/RPT, is to be located atop Santiago Peak in South Orange County at 5800' MSL. However, it is rumored, though not confirmed, that opposition to the new system from politically powerful remote-base owners who want no part of an open two-meter repeater on that hill is mounting. WA6KOS operates with a transmit frequency of 146.40 MHz. With 146.46 MHz being the recognized national remote-base intertie frequency, the remote owners fear that the overall ambient noise factor of the band will be raised by the new device and impede communications on .46. It should be mentioned that not all remote owners seem to feel this way. At least three have offered Faraone help in establishing the new system and technical assistance in clearing up any interference problems that might ensue.

Also unconfirmed are rumors that a number of major southern California repeaters, fearful that the same type of abuse that has caused the demise of KOS will descend on them, are planning to "private out" and turn toward selective usership operation. The political climate is viewed as being that should two or three major systems make this move, it would initiate a domino effect that would write an end to open repeater communication in the southwest in short order. More next month.

## THE GOOD GUYS WEAR WHITE HATS DEPARTMENT

In the old western movies, the ones made in black and white and prior to the advent of television, it was easy to tell the hero from the villain. Heroes always wore white hats and rode white horses. Your friendly local neighborhood villain usually wore black clothing, a black hat, and rode a black horse. Maybe these were not the actual colors, but who could tell? You went to a flick to cheer the hero and hiss the villain. Wasn't it easy in those days?

Villains are not supposed to be good guys and vice versa. Unfortunately, something has run amok in our society that, at times, causes the tables to be turned. Suddenly, a villain appears to be a hero and is able to build support for a position that appears totally wrong to the majority. In a nutshell, this describes a situation now running rampant on many Los Angeles two-meter repeaters. A small but highly-vocal group of people have come to demand their "right" to utilize any form of

language they may desire, regardless of how offensive such utterances might be to the rest of the area amateur community. They defy anyone, including the FCC, to stop them, claiming that any action in that direction would be a direct violation of their First Amendment rights. There even appear to be a few in this group who are not even amateurs, but who have amateur equipment and use it on the air. Their claim seems to be that since the "airwaves" belong to the "people," they have a right to operate a radio without subjecting themselves to the will of any government or agency thereof.

This group believes that anything goes, anything said is "right," and anyone they wish to abuse on the air is fair game. It is quite interesting that they only seem to inhabit busy wide-coverage open repeaters, where there exists a vast audience for their rhetoric. They rarely bother the smaller local systems, and I have yet to hear a report of them "taking on" a private repeater's usership, though many super-wide-coverage "privates" do abound. Two things are evident. First, to exist, they require a large audience to fulfill their egos, and second, they probably live in fear of the reprisals they might endure if they assailed a private system. It's no secret that the history of this area in relation to protecting one's domain, especially in regard to the sanctity of private repeaters, is one of retaliation for any such attack. So, they continue to feed their egos on the "average" amateur who operates on the "average" open repeater.

For many years, I have wondered how a situation such as this could possibly develop. Many theories have come forth, but few were very conclusive, and, until now, none offered any real solution. Recently, I had the opportunity to meet and speak with Russ Andrews K6BMG. Russ is not new to the amateur fraternity. He holds a General class license and has been a ham for over 25 years. Like myself, he has witnessed the move toward lawless operation and disrespect for the will of the majority by the aforementioned minority. He has taken the time to develop a short thesis on the subject that we now present for your approval and commentary.

## LAWLESSNESS ON THE HAM BANDS

What follows is one man's opinion. It is based on over 25 years as a licensed ham and on my observations and understanding of human nature and foibles. In part, it takes the form of a scenario. Its purpose is to

possibly give a wider view of the problems on the ham bands and stimulate thought, discussion, and, ultimately, a solution.

## How Did We Get Where We Are?

1. There is, in society today, a general disrespect for government, bureaucracy, and authority.

2. The creation of the CB band resulted in such an explosion of personal radio activity that the FCC resources were overwhelmed. This inability to provide needed policing resulted in the "lawless" nature of CB the FCC is now struggling to overcome.

3. This CB lawlessness soon spread to the creation of HFers, operating on non-CB frequencies.

4. Many of these CBers and HFers found out about ham radio and moved up (either legally or by various illegal methods).

5. Other hams simply became corrupted, or fearless, and allowed their negative sides greater rein.

## Why Has the Traditional Self-Policing of Ham Radio Failed?

Self-policing is based on three things:

1. Respect for the privileges and for others who have earned similar privileges. This factor has been weakened in several ways:

- Eased entry requirements.
- Examinations "given" by other hams — and falsified.
- Bootleggers.

2. Peer pressure. The new breed of offender is immune to peer pressure from the general ham fraternity.

- They have a different set of values.
- There are enough of them now to form their own sub-culture, or peer group, that supports them in their lawlessness.

3. Fear of exposure. They have built a rationalization which convinces them that they are in the right and the rest of the fraternity is wrong. So, why should they be afraid of being exposed, if they believe they are right? In addition, the prevailing opinion is that even if exposed to the FCC, the FCC will do *absolutely nothing*; therefore, why should they fear being "turned in" by other hams?

## Where Are We Now?

We have a growing group of antisocial, lawless individuals whose governing force is an ego-driven desire to have power through the use of radio technology. This group is self-stimulating, that is, it encourages within itself increased technical competence toward jamming

Continued on page 224

The following are excerpts from unsolicited letters and registration cards received from owners of the new TEN-TEC OMNI transceiver.

- "I sold a Yaesu to buy this and am very impressed" —WB5ULA  
 "My first QSO with OMNI-A was LA1SV on CW and second was EA8SK on SSB." —N2CC  
 "Excellent rig, just as advertised." —WB5TMD  
 "Very pleased with performance. QSK feature very slick." —WB0ELM  
 "This is my 5th TEN-TEC transceiver in less than 2 years. I loved them all and still have 3." —WB0VCA  
 "Through the years I have had complete Drake and Collins stations. I tried a 544 Digital and liked it the best so decided to purchase the 546 OMNI-D Digital." —WA4NFM  
 "Your OMNI is the best rig I have had in 20 years of hamming." —K4IHI  
 "As a owner of Collins rig, your OMNI-D is the best." —K9JLJ  
 "I already have an OMNI-A, 544 and a TRITON IV. You may ask why I own so many TEN-TEC rigs. In case there is a great RF famine, I want to be ready!" —WD4HCS  
 "You guys really know how to turn on an old timer!" —K8ELS  
 "Best operating & most conveniences of any transceiver I've ever used." —W6LZI  
 "I like CW. Compared OMNI against IC701 (rcvr) and OMNI won hands down. XYL WD6GSB really enjoys rig on SSB. Finds rig is very stable and digital readout accurate." —AC6B  
 "Have checked it out on both modes from "top band" (160) all the way to 29 MHz. Terrific!!!!" —W4DN  
 "Works well, parts layout and design much better for any possible servicing than other ham gear. The Japanese hybrid sets can't compare to TEN-TEC for audio. Audio reports excellent without special speech processors, etc., to distort the signal." —AG8K  
 "I have been using the S-Line over 15 yrs and never thought anything could outperform it. I got the biggest surprise and THRILLED with this OMNI-D even though I have been a ham since 1936." —KV4GD

- "This must be the greatest. I've spent enough money on final tubes to almost pay for this." —KA4BIH  
 "This transceiver was recommended to me by old time hams (Xtras) whom I have known for 40 yrs. Has excellent break-in." —N6AVQ  
 "Best package job I've ever seen! First licensed 6AAV in 1926. Now in operation—a sweetheart!" —W7LUP  
 "From a 32V2/SX115 to an OMNI is a big step!" —K6YD  
 "Receiver prominent—transmitter likewise—working comfortable—pleasing design." —OE1FAA  
 "First new rig for me in 10 years but seems to be very good." —W5GBY  
 "The best transceiver I ever used or owned." —W3TS  
 "I wouldn't swap my OMNI for anything on the market, regardless of price." —WD0HTE

#### OMNI/SERIES B FEATURES

All solid-state; 160-10 meters; Broadband design; Standard 8-Pole 2.4 kHz Crystal Ladder I-F Filter + Optional 1.8 kHz SSB Filter & 0.5 kHz 8-Pole CW Filter; 3-Bandwidth Active Audio Filter; Choice of readout — OMNI-A (analog dial), OMNI-D (digital); Built-in VOX and PTT, Selectable Break-in, Dual-Range Receiver Offset Tuning, Wide Overload Capabilities, Phone Patch Interface Jacks; Adjustable ALC; Adjustable Sidetone; Exceptional Sensitivity; 200 Watts INPUT; 100% Duty Cycle, Front Panel Microphone and Key Jacks; Zero-Beat Switch; "S"/SWR Meter; Dual Speakers; Plug-In Circuit Boards; Complete Shielding; Easier-to-use size: 5¾" h x 14¼" w x 14" d; Full Options: Model 645 Keyer \$85; Model 243 Remote VFO \$139; Model 252MO matching AC power supply \$139; Model 248 Noise Blanker \$49; Model 217 500 Hz 8-Pole Crystal Ladder CW Filter \$55; Model 218 1.8 kHz 8-Pole Crystal Ladder SSB Filter \$55.

Model 545 Series B OMNI-A... \$949  
 Model 546 Series B OMNI-D... \$1119

To add your name to the fast-growing list of OMNI owners, see your TEN-TEC dealer, or write for full details.

**TEN-TEC, INC.**  
 SEVIERVILLE, TENNESSEE 37862  
 EXPORT: 5715 LINCOLN AVE., CHICAGO, ILL. 60646

# OMNI OWNERS SAY:



# RTTY Loop

Marc I. Leavey, M.D. WA3AJR  
4006 Winlee Road  
Randallstown MD 21133

I made a mistake. Now, now, don't try to talk me out of it or minimize it. I made a mistake! Let's call it an error of omission. You see, a few months ago I listed articles on "silent RTTY," grouped by system types. I said that the list was complete. Well, I was only partially right; I inadvertently left out reference to articles appearing in 73's sister magazine, *Kilobaud MICROCOMPUTING*.

Fig. 1 is an attempt to correct this error. As you can see, several types of articles have been published in *Kilobaud MICROCOMPUTING*, encompassing many computer families. Rather than list them strictly by type, the figure includes a brief statement on each article's content so that you may guide your search accordingly.

Interest in microcomputer-assisted RTTY is running quite high and clearly constitutes the majority topic in mail received. One correspondent, Victor C. Johnson from Minneapolis, Minnesota, is interested in the Heath H-8 RTTY program. I hope the program printed in the June, 1978, issue of *Kilobaud MICROCOMPUTING* is of use to him.

Victor also is looking for a Teletype™ Model 28, receive only, and is apparently having a hard time finding one in the Minneapolis - St. Paul area. Anyone in that region who might help him is asked to drop a line to him, in care of this column; I will forward it along to him. As far as

commercial sources go, Victor, we have covered several sources in the past, but, as always, checking with local hams for reliable sources is the best way to go.

I have been quite upset over the number of complaints received about several of the known firms dealing with Teletype equipment. While most of the complaints center around unanswered inquiries (several of which I have also suffered) or prolonged shipment times (ditto), there is also the occasional, as pointed out over the past few months, paid-for order which is never heard from again. Incidentally, no work yet on the problem source noted last month.

Dave Phillips W7GZ writes that he will be coming up on the air soon with a Kleinschmidt machine and home-brew TU. This is to be replaced in short order by a 6800 microprocessor system and CRT terminal. Quite an order of magnitude difference! Dave is in need of wiring diagrams or maintenance manuals for his Kleinschmidt model TT-99. He notes that he has Teletype Model 28 ASR/KSR data available for the costs of postage and reproduction. If anyone is interested, contact Dave at 802 S. Eli Drive, Tucson, Arizona 85710.

A letter received from Wayland Osborn W0RRG poses a "big question." Wayland asks, "Are you aware of any RTTY gear, other than the Microlog system, which can be used to key the Kenwood TS-820 in transmit utilizing its built-in FSK feature?" My first inclina-

tion is to suggest using one of my favorite devices, a reed relay, in the loop to key the transmitter. It occurs to me, however, that you may be using only a CRT setup, without a conventional loop. In that case, you would have to adapt some form of on-off switching to the system, and I can appreciate your problem. Readers with similar systems are invited to drop a line and tell Wayland, and all of us, how you solved it!

Wayland also touches on the reported rf sensitivity of the Microlog system and my note last year that information promised me was yet to be seen. Well, as of this writing, one year has passed, and I still have received zip. This is not unique to Microlog, however. In fact, several companies, visible and well advertised, have promised to send various data sheets and literature in the past; not one

has followed up on the offer. I don't know why—oh, well!

The final letter this month comes from Jim New WA4DHD, a newcomer to RTTY, as he puts it. Jim is using the TRS-80 with a Model 19 for hard copy and is having great fun on the air. He wants to know where most RTTYers hang out. Well, starting on 80 meters, you might try 3620 kHz, and 14080 kHz on 20. Forty-meter RTTY is an iffy thing, and other bands frequently depend on conditions. Twenty and 80 are pretty well populated, and a QSO is almost always available.

Yes, I do have a station, for those of you who have asked, but I have not been on the air much. I promise to try, so that those of you who think that I am but a pseudonym for Wayne Green will learn better. I know that I exist, and I hope to be more visible.

March, 1977—"Using The '\$50' Terminal," James Brown. The author presents, in flowchart fashion, ASCII-to-Murray conversion. No particular microprocessor is mentioned.

November, 1977—"SC/MP Goes Baudot," Benjamin Blish. An SC/MP microcomputer is used to interface a Murray machine to an SWTPC 6800. Both software and hardware are presented.

June, 1978—"Baudot . . . er . . . Murray, Meet The H8," Howard L. Nurse. Interfacing to the Heath H8 is covered with full source listing and hardware needed. A solid article.

June, 1978—"ASCII to Baudot . . . er . . . Murray (the Hard Way)," John A. Lehman and Ray Graham. A tale of an experience with one supplier's conversion board.

September, 1978—"Baudot Interface Cookbook," J. R. Haglund and W. B. Reed. A scheme for interfacing to an 8080 based microprocessor. A note states that the program has been tried on and runs well on a Z-80 system.

August, 1979—"Teleprinter Output for TRS-80," David G. Morr. A hardware and software scheme for using a Murray-encoded printer as an output device. Full listings and hardware are covered for this Z-80 system.

September, 1979—"Make PET Hard Copy Easy," Dr. James M. Downey. Interfacing both ASCII and Murray-encoded machines to the PET IEEE bus through use of a UART and specially encoded ROM. This is a hardware modification with no software requirements. The machine is used strictly as a printer.

Fig. 1. Articles from *Kilobaud MICROCOMPUTING* on computerized RTTY.

# Corrections

In my article, "Dual-Band Smokey Detector," which was published in the May issue, two errors in the drawing dimensions slipped by me when I reviewed the proofs.

On page 49 of that issue, the last paragraph calls for the circular waveguide to be made from 1/2-inch water pipe. It should be 3/4-inch water pipe.

The dimensions shown on the rectangular waveguide E plane view on page 51 should show the hole for the circular waveguide as 7/8 of an inch in diameter (or the outside diameter of a piece of 3/4-inch copper water pipe). The horn mounting hole is also shown as 1/2-inch; this discrepancy can be easily rectified by making the tab cuts deeper so that they can be bent to fit the o.d. of the

circular waveguide. All hole cuts into the circular waveguide retain the same dimensions. One thing not described in the article, however, is the fact that the WR42 guide must be trimmed on the inside of the circular guide to be flush with the inside wall of the pipe.

I have also received many calls regarding the omission of the value of the series resistor shown where the 12-volt feed is located; this resistor is rated at 10 Ohms. It connects to the junction point where it feeds the main dc into the two 741 ICs and a 390-Ohm resistor. The point marked +12 volts on IC5 should also tie to the same junction point since that resistor serves as part of the filter from the source.

I have found a supplier for

waveguide and other microwave components where amateurs can get small quantities. This supplier has an excellent catalog and offers it to the public for the asking—no microwave experimenter should miss

it. The company is Lectronic Research Laboratories, Atlantic and Ferry Avenues, Camden NJ 08104. Ask for Sales Bulletin 107.

**Stirling Olberg W1SNN  
Waltham MA**

# Ham Help

I was an amateur, but lost my license because I could not construct my own transmitter and operate. I am trying to again get my license, but also I am badly in need of some equipment to continue with my other experiments. Unfortunately, this equipment is not available in India.

If anyone can send me construction details, along with circuit diagrams, etc., of a Van de Graaff electrostatic generator,

a Wimshurst electrostatic generator, and biofeedback machines, I would be most grateful.

Any names of books and their publishers, from whom I can buy those books, also would be appreciated. Thank you very much.

**Hemant K. Patel  
1008 Nilanjana, 10th Floor  
Marve Road  
Malad-West  
Bombay 400064, India**

# WHEN OUR CUSTOMERS TALK... WE LISTEN.



Jim Clouse, K5JN  
Oklahoma City, OK



Phil Litchfield, WA1OFF  
New Canaan, CT



Colin Richards, 9M2CR  
Singapore



Ed Trego, W9WKC  
Hoopeston, IL



Reinhard Richter, DJ1KM  
Hannover

## From around the world their RTTY messages read loud and clear.

At HAL we *want* to hear what our customers have to say about RTTY practices, problems, and possibilities. So when they talk . . . we listen . . . and respond.

The result is that HAL Communications equipment

stays at the leading edge of RTTY design with . . . features that open up new capabilities for greater enjoyment of RTTY operation. And with performance reliability so certain, we offer a full one-year warranty.

**Write or give us a call. We'll be glad to send you our new RTTY catalog.**



**HAL COMMUNICATIONS CORP.**  
Box 365  
Urbana, Illinois 61801  
217-367-7373

For our European Customers Contact:  
Richter & Co., D3000 Hannover 1  
I.E.C. Interelco, 6816 Bissone/Lugano

# Awards

Bill Gosney WB7BFBK  
2665 North 1250 East  
Whidbey Island  
Oak Harbor WA 98277

This past fall we announced for the first time our new amateur radio awards program. Featured in a two-part series in the September and October issues, we outlined a total of eight 73 Magazine achievement awards available to amateurs the world over. Since then, letters of support have been received from all parts of the globe, each showing dedicated interest in pursuing the challenges our awards program has to offer.

This month, we offer two new awards, each of which is very unique in its own right.

## THE Q-5 AWARD OF EXCELLENCE

This award, sponsored by the editors of 73 Magazine, is available to amateurs throughout the world possessing any class license who operate periodically in the American Novice band.

To be valid, all contacts must be made on or after January 1, 1980. Likewise, all contacts must be made using only the CW mode on those frequencies assigned to the American Novice. Maximum power allowed will be limited to 250 Watts input. There are no band restrictions for this award.

To qualify, the applicant must work all ten US call districts and receive no less than a Q-5 report. A qualifying RST might be, for example, 559, 539, 579, etc., while an RST of 449, 349, 479, would not qualify the applicant for the award.

This award is not meant to be an overnight accomplishment. Stations meeting the challenge of these requirements will be proud to display this unique award depicting the excellence and superiority of their station's transmitted signal.

To apply for this award, the applicant must prepare a list of all claimed contacts, logging each contact in order of the US call district. Indicate the station worked, the date and time in GMT, the frequency utilized, and, most important, the RST report as noted on your confirmation card. Also required is a brief description of the station equipment and antenna system used to complete this award.

Do not send QSL cards! Have your list verified by two amateurs, a local radio club secretary, or a notary public. Enclose your verified list along with the award fee of \$3.00 or 8

IRCs to: Bill Gosney WB7BFBK, 73 Awards Editor, 2665 North 1250 East, Oak Harbor, Whidbey Island WA 98277 USA.

A significant number of amateurs throughout the world find their primary interest in the operation and development of specialty-type communications. It is the efforts of these many pioneers in their field which have created many state-of-the-art improvements which we know today. The editors of 73 wish to recognize those amateurs who make positive steps toward expanding the use of their respective mode or type of amateur operation. As a result, in the paragraphs to follow, you will learn of our latest communications award dedicated to "communicator specialists."

## SPECIALTY COMMUNICATIONS ACHIEVEMENT AWARD

Sponsored by the editors of 73, this award is dedicated to amateurs worldwide who take pride in active participation in the field of specialty communications.

To be eligible for this award, some very rigid requirements must be met. First of all, contacts must be made on or after January 1, 1980. In addition, only communications via SSTV, RTTY, EME (Earth-moon-Earth), and/or OSCAR will be recognized for this award. Contacts between stations on OSCAR or EME may be made using any mode authorized in your country. Applicants must be cautioned, however, that mixed-mode contacts will not be valid.

This award will be offered in two levels of operating achievement, each a worthy award in itself:

**Class A** requires applicant to work all 50 US states.

**Class A-1** requires applicant to work a minimum of 10 DX countries from the WTW DX Countries List.

To apply, the applicant must prepare a list of claimed contacts. For the Class A award, this list must be arranged in alphabetical order by US state; for the Class A-1 award, prepare the list of contacts in order by callsign prefix. Either list must also include the date and time in GMT, the band and mode of operation, and a signed declaration of the type and description of equipment and antenna systems used to make your contacts.

Do not send QSL cards! Have your list verified by two amateurs, a local radio club secretary, or a notary public. Enclose each list with an award

fee of \$3.00 or 8 IRCs to: Bill Gosney WB7BFBK, 73 Awards Editor, 2665 North 1250 East, Oak Harbor, Whidbey Island WA 98277 USA.

Should any readers of this column care to possess our new awards program booklet, you are urged to send for your free copy now while the supply lasts. The only requirement is that you send a large business-size SASE when making your request. At the same time, I would like to encourage you to write any comments you may have about this column or our awards program being offered.

Traveling abroad as we do every month, I wish to share a very unique series of awards being offered by the Swedish Amateur Radio Society (SSA - Sveriges Sandareamatorer).

Karl Friden SM6ID wrote to inform us about the WASM II achievement award and sent along this very attractive diploma which is issued upon successful completion of the award requirements.

## WORKED ALL SM LAENS WASM II

The WASM II, awarded by SSA, is available to amateurs throughout the world. Class A is for amateurs located in those countries with prefixes LA, OH, OZ, and SM. The Class B award is for amateurs in the rest of the world.

To be valid, all contacts must be made January 1, 1953, or after. Any one of the amateur bands is allowed and contacts made in CW or phone or any combination of both are allowed, providing it is not cross-mode.

Amateurs in Class A areas must submit proof of having established two-way communications with each of the 25 laens (counties) on two different bands (50 QSLs). Amateurs in Class B areas must submit proof of having established contact with each of the 25 laens without any band restrictions.

Sweden is divided into 25 laens or counties:

- A - City of Stockholm (SM5 and SM0)
- B - Stockholm laen (SM5 and SM0)
- C - Uppsala laen (SM5)
- D - Södermanland laen (SM5)
- E - Östergötland laen (SM5)
- F - Jönköping laen (SM7)
- G - Kronoberg laen (SM7)
- H - Kalmar laen (SM7)
- I - Gotland laen (SM1)
- K - Blekinge laen (SM7)
- L - Kristianstad laen (SM7)
- M - Malmöhus laen (SM7)
- N - Halland laen (SM6)
- O - Göteborg och Bohus laen (SM6)
- P - Älvsborg laen (SM6)
- R - Skaraborg laen (SM6)
- S - Värmland laen (SM4)
- T - Örebro laen (SM4)
- U - Västmanland laen (SM5)
- W - Kopparberg laen (SM4)
- X - Gävleborg laen (SM3)
- Y - Västernorrland laen (SM3)
- Z - Jämtland laen (SM3)
- AC - Västerbotten laen (SM2)
- BD - Norrbotten laen (SM2)

Application for the WASM II must be accompanied by a verified list of claimed contacts. This list may be verified by two amateurs, a local club secretary, or a notary public. Enclose this list with 7 IRCs or US stamps of equivalent value and send to the attention of: Karl O. Friden SM6ID, Awards Manager SSA, PI. 1084, Morup, 310 56 Langas, Sweden.

And, while speaking of the Swedish Amateur Radio Society, I received a very nice letter from Kjell Edvardsson SM0CCE who is awards manager for the WASM I award being offered by this national organization. It is very unfortunate that a sample of this award is not available for reproduction. This is due to the fact that the award is a very large cloth depicting scenic highlights of this beautiful and picturesque country and personalized to display the identity

Continued on page 228



# When quality counts

Do not be fooled by the low prices, these brand new lab quality frequency counters have important advantages over instruments costing much more. The models 7010 and 8010 are not old counters repackaged but 100% new designs using the latest LSI state-of-the-art circuitry. With only 4 IC's, our new 7010 offers a host of features including 10 Hz to 600 MHz operation, 9 digit display, 3 gate times and more. This outperforms units using 10-15 IC's at several times the size and power consumption. The older designs using many more parts increase the possibility of failure and complexity of troubleshooting. Look closely at our impressive specifications and note you can buy these lab quality counters for similar or less money than hobby quality units with TV xtal time bases and plastic cases!

Both the new 7010 and 8010 have new amplifier circuits with amazingly flat frequency response and improved dynamic range. Sensitivity is excellent and charted below for all frequencies covered by the instruments.

Both counters use a modern, no warm up, 10 MHz TCXO [temperature compensated xtal oscillator] time base with external clock capability - no economical 3.579545 MHz TV xtal.

Quality metal cases with machine screws and heavy guage black anodized aluminum provide RF shielding, light weight and are rugged and attractive - not economical plastic.

For improved resolution there are 3 gate times on the 7010 and 8 gate times on the 8010 with rapid display update. For example, the 10 second gate time on either model will update the continuous display every 10.2 seconds. Some competitive counters offering a 10 second gate time may require 20 seconds between display updates.

The 7010 and 8010 carry a 100% parts and labor guarantee for a full year. No "limited" guarantee here! Fast service when you need it too, 90% of all serviced instruments are on the way back to the user within two business days.

We have earned a reputation for state-of-the-art designs, quality products, fast service and honest advertising. All of our products are manufactured and shipped from our modern 13,000 square foot facility in Ft. Lauderdale, Florida.

When quality counts...count on Optoelectronics.

MODEL 8010 1 GHz

MODEL 7010 600 MHz



- 100% U.S.A. FACTORY ASSEMBLED
  - 100% PARTS & LABOR YEAR GUARANTEE
  - CERTIFIED NBS TRACEABLE CALIBRATION
  - EXTERNAL CLOCK INPUT
  - DISPLAY HOLD FUNCTION
  - 9 RED LED DIGITS 4" HIGH
  - .1 HZ RESOLUTION
  - 0.1 PPM 10 MHz TCXO TIME BASE
  - LAB/PORTABLE-AC ADAPTER INCLUDED
  - 1 MEGOHM & 50 OHM INPUTS
  - STATE-OF-THE-ART LSI DESIGNS
  - COMPREHENSIVE USER MANUAL PROVIDED
- COMPACT SIZES—7010- 1-1/2" Hx4-1/4" Wx5-1/4" D 8010- 3" Hx7-1/2" Wx6-1/2" D

MODEL	\$ PRICE	RANGE 10Hz to	LED DIGITS	SENSITIVITY			HI-Z INPUT 10Hz - 60 MHz	GATE TIMES	RESOLUTION			TCXO TIME BASE		EXT CLOCK INPUT	NI-CAD BATT PACK
				25-250 MHz	250-450 MHz	450 MHz-1GHz			12 MHz	60 MHz	MAX. FREQ.	20-40°C	FREQ.		
7010 *7010.1	145.00 225.00	600 MHz	9	5-20 mV	10-30 mV	20-40 mV to 600 MHz	1-10 mV	{3} .1, 1, 10 SEC	.1 Hz	1 Hz	10 Hz 600 MHz	1 PPM 0.1 PPM	10 MHz	YES OPTION \$25.	YES OPTION \$15.
8010 *8010.1	325.00 405.00	1 GHz	9	1-10 mV	5-20 mV	10-25 mV	1-10 mV	{8} .01-20 SEC	.1 Hz	1 Hz	10 Hz 1 GHz	1 PPM 0.1 PPM	10 MHz	YES STD	YES OPTION \$39.

\* Has precision 0.1 PPM TCXO time base.

**MODEL 7010**  
#7010 600 MHz Counter - 1 PPM TCXO \$145.00  
#7010.1 600 MHz Counter - 0.1 PPM TCXO \$225.00

**OPTIONS**  
#NI-Cad-701 Ni-Cad Battery Pack & charging circuitry  
Installs inside unit \$ 15.00  
#EC-70 External Clock Input, 10 MHz \$ 25.00  
#CC-70 Carry Case, Padded Black Vinyl \$ 8.95

**MODEL 8010**  
#8010 1 GHz Counter - 1 PPM TCXO \$325.00  
#8010.1 1 GHz Counter - 0.1 PPM TCXO \$405.00  
#8010.1-13 1.3 GHz Counter - 0.1 PPM TCXO \$495.00

**OPTIONS**  
#NI-Cad-801 Ni-Cad Battery Pack & charging circuitry  
Installs inside unit \$ 39.00  
#CC-80 Carry Case, Padded Black Vinyl \$ 9.95

**ACCESSORIES**  
#TA-100 Telescope Ant with Right Angle BNC \$ 9.95  
#P-100 Probe, 50 ohm, 1x \$13.95  
#P-101 Probe, Lo-Pass, Audio Usage \$16.95  
#P-102 Probe, Hi-Z, General Purpose \$16.95



ORDER FACTORY DIRECT • CALL TOLL FREE



**Optoelectronics inc**

5821 N.E. 14th Avenue, Fort Lauderdale, Florida 33334

**1-800-327-5912**

FROM FLORIDA (305) 771-2051/2

TERMS: Orders to U.S. and Canada, add 5% for shipping, handling and insurance to a maximum of \$10.00. All other orders add 10%. C.O.D. collection fee \$1.00. Orders under \$15.00 add extra \$1.00 handling. Regular checks must clear before order is shipped. Florida residents add 4% sales tax.

# Leaky Lines

Dave Mann K2AGZ  
3 Daniel Lane  
Kinnelon NJ 07405

Some irritations are of great importance; others are of relatively less concern. Since it is in the very nature of the incorrigible malcontent to nitpick, I decided a long time ago to leave significant questions for others to discuss. I deal with those niggling little matters that produce heartburn rather than peptic ulcers. If you seek the earth-shattering exposé, the juicy scandal, or the noble crusade, move on; you will not find it here. Let others pursue man-eating sharks and tigers . . . I swat flies and mosquitoes.

A case in point: Here, I think, is one of those small insanities that's right up my alley. It calls for some protest, however slight. I would have hoped that Newington, Connecticut, would have registered some opposition, but none was forthcoming. There are times, I suppose, when the lamb will willingly lie down with the lion.

The present system of call-sign allocations is an abomination. It more closely resembles some sort of random selection than a structured plan which could clarify grade of license, seniority, or geographical location. The unfortunate inclusion of a great number of garbled prefixes has botched up the whole thing but good.

There is no longer any dependable way, short of asking directly (which somehow goes against the grain), to know whom you are working or whether your contact has been licensed for sixty years or for sixty days. It is claimed that this arrangement will tend to democratize the ham bands, but it will not. It will merely produce an element of uncertainty in an area once highly organized. One used to know beyond peradventure that the KA he hooked up with was a member of the U.S. military stationed in Japan; now he may be some guy right around the corner . . . there's no way to tell just from the prefix.

I'm not disturbed merely by the confusion. I simply dislike the idea of creating equality where it really has no place. Don't misunderstand me. I am one hundred percent in favor of political, racial, sexual, and social equality . . . a true advocate and champion of democracy. But it has no more place in ham radio than it has in any other such avocation . . . photography, stamp collecting, gardening, woodworking, astronomy, or Sunday painting. What is

this sudden impulse to create equality everywhere? I believe that those who have been around for a very long time deserve to flaunt the distinction to some extent. No human endeavor in which skill is a factor should be subjected to some artificial leveling process. I speak not of reward, but of simple recognition. And if this should happen to consist of a distinctive callsign, as it used to, what's so terribly wrong with that?

The simple truth is that, in the words of an old adage "When everybody is somebody, nobody is anybody."

By all means, reward diligence, talent, and industry. But not by taking something away from somebody else. They've now removed the distinction of the preferred callsign, the only thing that differentiated the old-timer from the Johnny-come-lately. I rise to my hind legs and bay loudly at the moon. The new callsigns are lousy!

But things might have been far worse. I read a proposal that would have utilized the 3-letter, 3-digit system presently employed in the assignment of some state's auto license plates. If our present callsign system is bad, that one would have been infinitely worse. Some other joker got the brilliant idea that because Social Security numbers, like snowflakes and fingerprints, are unique . . . no two alike . . . they should be used to replace the standard callsigns. Don't expect me to analyze the logic that prompts such suggestions; I'm no expert in abnormal psychology.

It may be that the present revision of the callsign structure was designed for the convenience of the FCC monitoring stations, so that they could more easily determine who may be operating illegally in the restricted subbands.

This notion presupposes that these monitors are doing a conscientious job of policing in the first place . . . staying on top of the situation and nailing violators with swift efficiency. But they are not. A recent incident confirms the very opposite. The monitor at Anchorage, Alaska, issued notices of violation to a number of amateurs who had contacted Thailand stations. Obviously, the monitor labored under the mistaken impression that there still exists a banned countries list.

We have not had such a list for a very long time. This misadventure reminds me of the great flap that occurred when police

were issuing summonses to hams who were transmitting while driving, despite a change in the law. This took place some fifteen years ago, and notwithstanding the repeal of the measure which had formerly prohibited such transmissions, these misguided minions of the law were highly reluctant to accept the change. Hams were advised to carry copies of the new regulation so they could show them to arresting officers. Despite all this, there are still some cops who attempt to hand out tickets to this day! To be sure, such cases are thrown out of court. But those who receive the summonses must answer them . . . a needless inconvenience. In like manner, those who have received these notices of violation from the FCC are being penalized. They have been informed that they "must respond to the citation in the manner outlined in 97.137, and the reply must be sent via registered or certified mail." (See QST, August, 1979.)

What would happen if one of these cited amateurs were to fail to reply to the notice? Bureaucratic conceit and self-conferred omnipotence being what they are, it would not be at all strange if they were to face actual revocation of license. Such is the nature of bureaucracy . . . agencies of the government are known to foul up from time to time.

Not only do these erroneous citations demonstrate that a bureaucracy can be wrong, but they also confirm a persistent conviction held by many that even when they are wrong, they pretend that they are right, and they insist upon having everyone else take part in the pretense, too.

Would it have been so embarrassing for the FCC to have issued a simple statement to the effect that all persons who had received the citation should simply ignore it? Why couldn't they acknowledge that there had been an inadvertent human error? Would this have been such a terrible humiliation?

It appears that the Commis-

sion is committed to the perpetuation of a grand illusion; it must maintain an aura of infallibility. Perhaps even more important, licensees must constantly be made aware of the awesome power of Big Brother. Phooey and double phooey!

If the FCC were one-tenth as capable as it would have us believe, it would long since have succeeded in cleaning up the horrendous mess on CB . . . it would have been able to do something significant about the "woodpecker" that has plagued and bedeviled operations on the DX bands . . . it would have been able to nail all the CW intruders on fishing trawlers who constantly appear on unauthorized frequencies within our allegedly sequestered portions of the amateur spectrum. It would have been able to deal with the problem of unauthorized linear amplifiers on 27 MHz without having to eliminate 10-meter capability from amplifiers intended for use among legitimately licensed amateurs . . . it would have been capable of devising some nationally applicable regulation which would, once and for all, take uncompromising precedence over community zoning restrictions on radio tower installations. It would also have been able to force manufacturers of home entertainment devices to install adequate filtering so that TVI and BCI would be minimized, if not eliminated altogether, thus lifting the burden of ostracism and public condemnation from the shoulders of thousands of blameless amateurs and placing it where it rightfully belongs.

The fact is that there's nothing perfect in this all-too-imperfect world. But this has its compensations. It's great for the likes of me . . . a guy who derives personal satisfaction in pointing out foibles and flaws. How could I function if this were a world without faults? Yet, somehow I have the feeling that even if it were perfect, we grumblers and groaners would still manage to find something to gripe about.

## Ham Help

I need a parts list and assembly and tuning instructions for a Telrex TC-99 triband beam antenna. Will copy and return.

**A. McGinnis WA2DTQ**  
55 Patton St.  
Iselin NJ 08830

I am in desperate need of a schematic and alignment instructions for a National NC-300. I would really appreciate

any help.

**Bob Amos**  
607 N. Madden  
Shamrock TX 79079

I would like some help in studying for the General exam. Any person or group in the Bronx area interested in helping me?

**Smideth Shuler**  
60 Clason Pt. Lane  
Bronx NY 10473



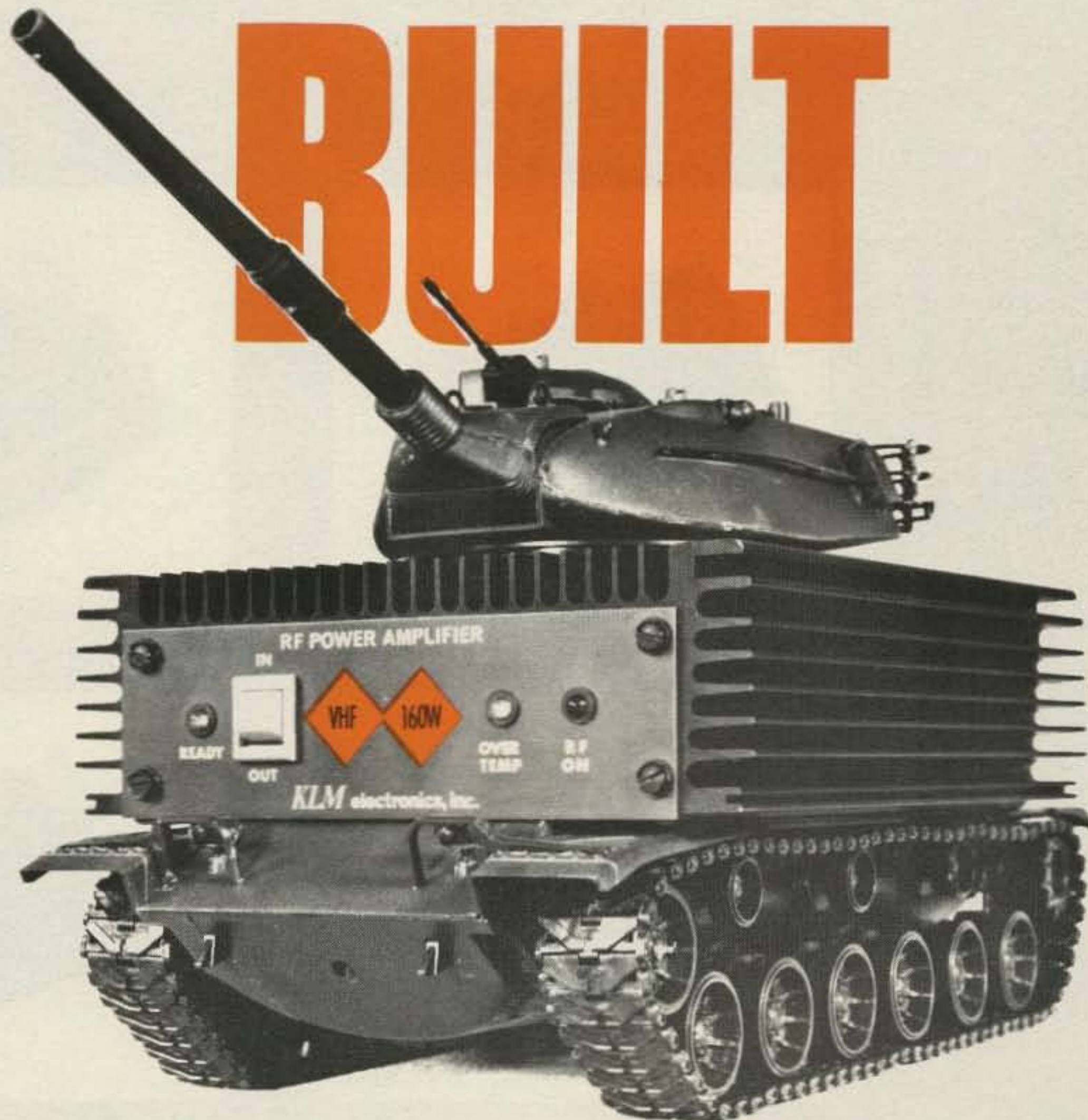

## LIKE A TANK TO "TAKE IT" & STILL DELIVER THE FIREPOWER...

Everyone knows RF amplifiers take a real beating in day-to-day operations — in overheated repeater stations, knocking around under dashes and in trunks, quick rigged for contests and field days. That's why we've designed our new series of amplifiers to take all kinds of punishment and still keep on delivering:

### OUTSIDE

- A brutally rugged heatsink with fins on top and sides, 30% more dissipation than previous models.

### INSIDE

- Over-temp sensor monitors the board and bypasses the amplifier when safe operating temperatures are exceeded. The yellow "over-temp" L.E.D. on the front panel lets you know what's happening.
- Tough emitter ballasted transistors resist damage from high VSWR, short and open circuits.
- All amps have reverse D.C. polarity protection.

### PLUS KLM'S STANDARD HASSLE-FREE FEATURES

- No tuning; KLM microstrip designs are broadbanded.
- Automatic R.F. sensing (and remote hard-keying).
- No mode-switching. All 420-450 MHz and 2 meter models (except the PA2-25B) are "linear" for straight ahead operation on FM, CW, AM, and SSB (delay adjustable).

NOW, see your KLM dealer  
SEE WHY WE'RE KNOWN AS THE "GOOF-PROOF" AMP CHAMPS!

### POWER AMPLIFIER SPECIFICATIONS

MODEL NUMBER	USEABLE	POWER (watts)			MODEL NUMBER	USEABLE	POWER (watts)		
		IN (max)	OUT (min)	AMPS @ 13.5 VDC			IN (max)	OUT (min)	AMPS @ 13.5 VDC
<b>"B" Series 144-148 MHz</b>				<b>"BC" Series 220-225 MHz</b>					
2-25B	1-4	4	25	4	4-70BC	1-4	4	70	10
4-80BL	1-4	4	80	10	15-60BC	5-15	15	60	8
4-160BL	1-4	4	160	20	15-120BC	5-15	15	120	25
15-40 BL	5-15	15	40	5	45-120BC	15-45	45	120	15
15-80BL	5-15	15	80	10	<b>"C" Series 420-450 MHz</b>				
15-160BL	5-15	15	160	22	4-40CL	1-4	4	40	10
45-160BL	15-45	45	160	18	15-40CL	5-15	15	40	5
					15-110CL	5-15	15	110	20

"L" suffix indicates LINEAR models suitable for FM, CW, SSB, and AM.  
All models meet and exceed FCC 20777 specs.

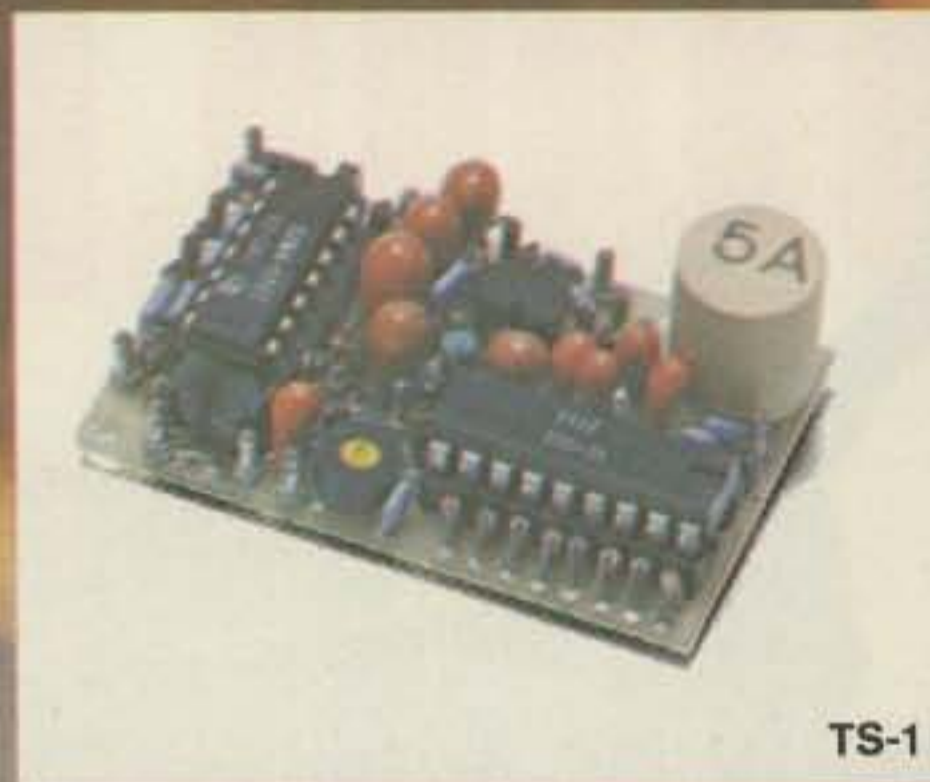

TS-1



TS-1JR



PE-2



SD-1

# THE DAWNING

The age of tone control has come to Amateur Radio. What better way to utilize our ever diminishing resource of frequency spectrum? Sub-audible tone control allows several repeaters to share the same channel with minimal geographic separation. It allows protection from intermod and interference for repeaters, remote base stations, and autopatches. It even allows silent monitoring of our crowded simplex channels.

We make the most reliable and complete line of tone products available. All are totally immune to RF, use plug-in, field replaceable, frequency determining elements for low cost and the most accurate and stable frequency control possible. Our impeccable 1 day delivery is unmatched in the industry and you are protected by a full 1 year warranty when our products are returned to the factory for repair. Isn't it time for you to get into the New Age of tone control?



ME-3



TE-8



TE-12



ST-1

# OF A NEW AGE.

**TS-1** Sub-Audible Encoder-Decoder • Microminiature in size, 1.25" x 2.0" x .65" • Encodes and decodes simultaneously • **\$59.95** complete with K-1 element.

**TS-1JR** Sub-Audible Encoder-Decoder • Microminiature version of the TS-1 measuring just 1.0" x 1.25" x .65", for hand-held units • **\$79.95** complete with K-1 element.

**ME-3** Sub-Audible Encoder • Microminiature in size, measures .45" x 1.1" x .6" • Instant start-up • **\$29.95** complete with K-1 element.

**TE-8** Eight-Tone Sub-Audible Encoder • Measures 2.6" x 2.0" x .7" • Frequency selection made by either a pull to ground or to supply • **\$69.95** with 8 K-1 elements.

**PE-2** Two-Tone Sequential Encoder for paging • Two call unit • Measures 1.25" x 2.0" x .65" • **\$49.95** with 2K-2 elements.

**SD-1** Two-Tone Sequential Decoder • Frequency range is 268.5 - 2109.4 Hz • Measures 1.2" x 1.67" x .65" • Momentary output for horn relay, latched output for call light and receiver muting built-in • **\$59.95** with 2 K-2 elements.

**TE-12** Twelve-Tone Sub-Audible or Burst-Tone Encoder • Frequency range is 67.0 - 263.0 Hz sub-audible or 1650 - 4200 Hz burst-tone • Measures 4.25" x 2.5" x 1.5" • **\$79.95** with 12 K-1 elements.

**ST-1** Burst-Tone Encoder • Measures .95" x .5" x .5" plus K-1 measurements • Frequency range is 1650 - 4200 Hz • **\$29.95** with K-1 element.



**COMMUNICATIONS SPECIALISTS**

426 West Taft Avenue, Orange, CA 92667  
(800) 854-0547, California residents use: (714) 998-3021



# Microcomputer Interfacing

David G. Larsen  
Peter R. Rony  
Jonathan A. Titus  
Christopher A. Titus

The characteristics of the Intel 8253 programmable interval timer were introduced in our October column. This 24-pin chip is very useful in counting and timing operations. This section will discuss two test programs for the 8253. One is a demonstration program that illustrates the various modes of operation of the timer, and the other is a program that demonstrates the reading of counter data "on the fly."

The counter is wired to an 8080A-based microcomputer, as shown in our October column. The details of the test circuit are provided in Fig. 1. Although the use of an oscilloscope is handy to monitor output signal OUT0 from counter #0, it has been found just as useful to provide a single 7490 decade counter chip to detect negative-edge transitions at OUT0. The 25-kHz input clock frequency, which has a period T of 40  $\mu$ s, is input at CLK0.

Before the 8253 chip is used, the nature of output signal OUT0 must be understood as a function of the six different modes of operation, MODE 0 through MODE 5. We have found the manufacturer's literature to be somewhat confusing, so their diagrams have been simplified by omitting all signals other than OUT0. This permits all six modes to be compared simultaneously, as shown in Fig. 2. Note that MODES 0 and 1 provide a negative monostable clock pulse of duration NT; MODE 2 provides a series of negative clock pulses of pulsewidth T and period NT; MODE 3 provides essentially a square wave of period NT; and MODES 4 and 5 provide a single strobe pulse of pulsewidth T at a time NT after a trigger pulse has been applied to counter #0. The quantity N is a 16-bit timing byte initially loaded into counter #0. In our program, the timing byte is 000 000, which corresponds to the decimal number 65,536.

At this point, it is appropriate to comment on the two possible actions of the GATE0 input:

1. GATE0 functions as a gating input; when at logic 0, pulses input at CLK0 do not reach counter #0 and no counting occurs. This type of behavior occurs with MODE 0, MODE 2, MODE 3, and MODE 4.

2. GATE0 functions as a trigger/reset input; a positive-edge transition at GATE0 resets counter #0 and initiates counting. Each time there is a positive edge at GATE0, counter #0 is reset. This type of behavior occurs with MODE 1, MODE 2, MODE 3, and MODE 5.

These different actions can best be observed with the aid of a counter and a value of NT in the range of 3-10 seconds. In our case, N is 65,536 and T is 40  $\mu$ s, so  $NT = (65,536)(40 \times 10^{-6}) = 2.62$  seconds.

The program used to test the 8253 chip is provided in Table 1. Note that we have employed memory-mapped I/O, in which the control register has an address of 200 003 and counter #0 has an address of 200 000. The program is quite simple. First the control word 060 (MODE 0) is output into the control register. Next, we successively load the LO and HI counter bytes, both of which are 000, into counter #0. Finally, we enter a wait loop. Table 2 in the October issue shows that a control word of 060 means that counter #0 is chosen; the least-significant byte is loaded first, then the most-significant byte. Observe

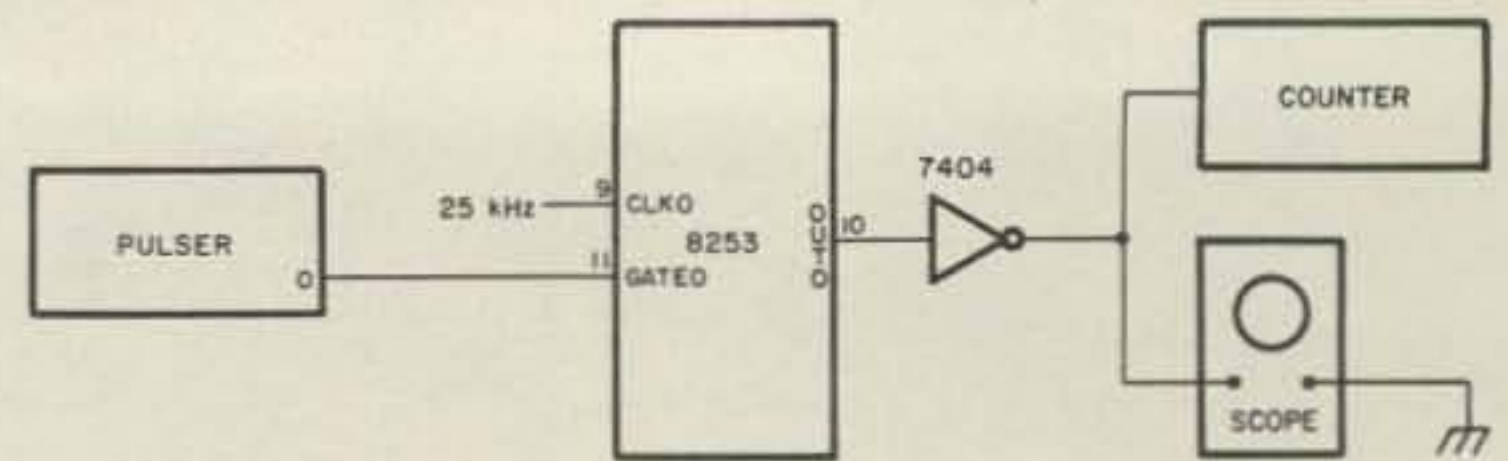

Fig. 1. Circuit for counter #0 on the 8253 timer to be used with the demonstration program given in Table 1. It is assumed that the counter counts negative-edge transitions.

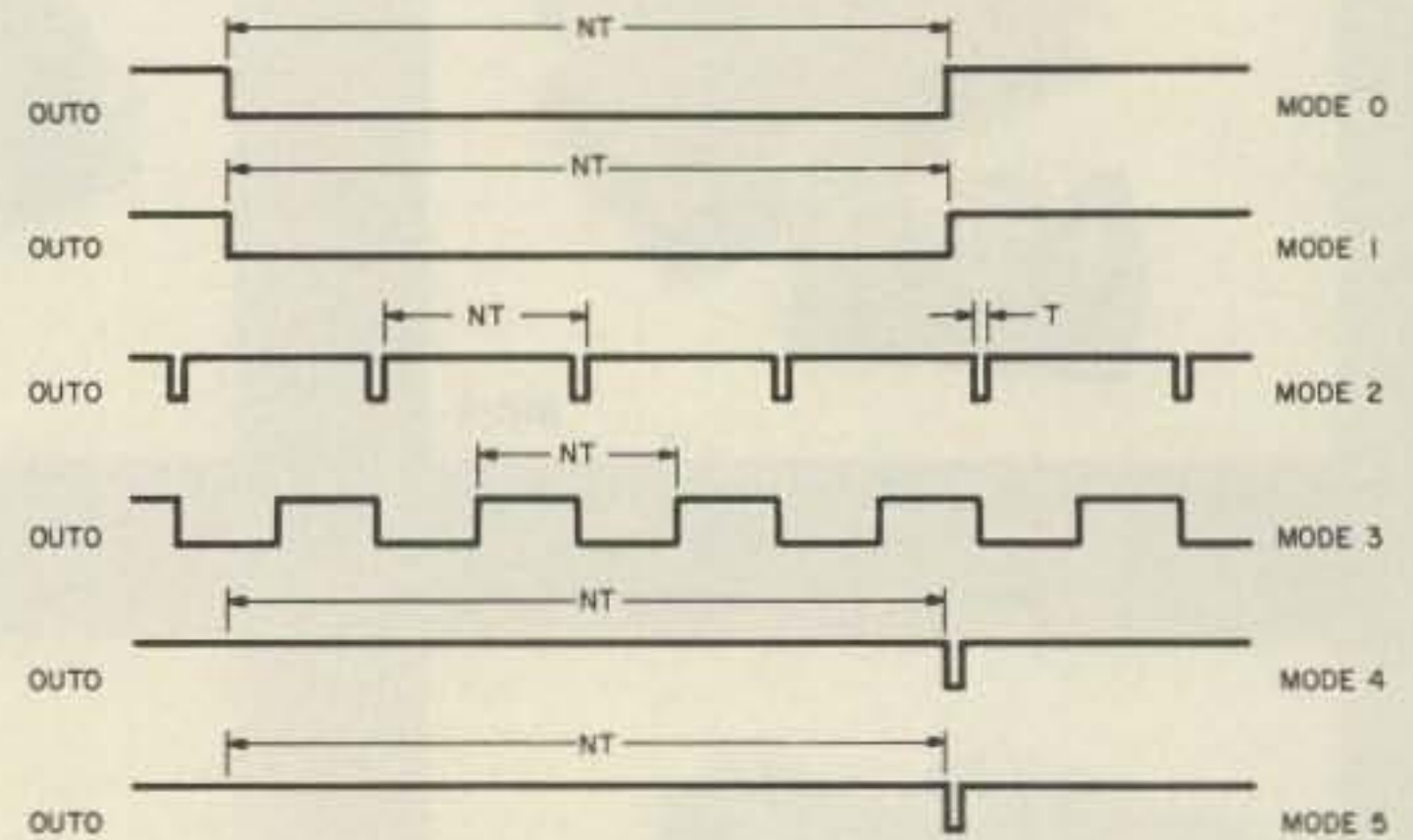

Fig. 2. Timing diagrams for the OUT0 output signal for each of the six operating modes of the 8253 timer.

the MODE 0 operation of the counter and count down in binary.

When executing this program, observe that OUT0 goes immediately to logic 0 and remains at this logic state for NT seconds, after which it returns to logic 1. This behavior can be

repeated only by executing the program a second time, starting at memory address 003 000.

If the control word is changed at location 003 001 to 062 (MODE 1), the execution of the program begun, and the pulser

Continued on page 225

003 000 076	TIMER,	MVIA	/Move control word into accumulator
003 001 <sup>a</sup> 060		060	/Mode control word
003 002 062		STA	/Store it within control register
003 003 003		003	/in 8253 interval timer chip
003 004 200		200	
003 005 076		MVIA	/Move LO counter byte into accumulator
003 006 000		000	/LO counter byte
003 007 062		STA	/Store LO byte in counter #0
003 010 000		000	
003 011 200		200	
003 012 076		MVIA	/Move LO counter byte into accumulator
003 013 000		000	/HI counter byte
003 014 062		STA	/Store HI byte in counter #0
003 015 000		000	
003 016 200		200	
003 017 303		JMP	/Wait
003 020 017		017	
003 021 003		003	
If you wish to observe the counting process on a pair of output ports, replace the last program instruction by the following sequence of instructions:			
003 017 076		MVIA	/Move new control word into accumulator
003 020 000		000	/Move control word to read counter #0
003 021 062		STA	/Store it within control register
003 022 003		003	
003 023 200		200	
003 024 072	RPT,	LDA	/Read LO counter byte into accumulator
003 025 000		000	
003 026 200		200	
003 027 323		OUT	/Output LO counter byte to Port #2
003 030 002		002	
003 031 072		LDA	/Read HI counter byte into accumulator
003 032 000		000	
003 033 200		200	
003 034 323		OUT	/Output HI counter byte to Port #0
003 035 000		000	
003 036 303		JMP	/Continue to output the counter bytes
003 037 024		RPT	
003 040 003		0	

<sup>a</sup>The control word at address 003 001 is changed to demonstrate the behavior of the different modes of operation.

Table 1. Demonstration program for the 8253 interval timer.

# ATR-6800

A NEW DIMENSION IN DIGITAL COMMUNICATION

FEATURING THE FULLY AUTOMATIC ATR-6800 SPLIT SCREEN VIDEO  
TERMINAL FOR CW & RTTY

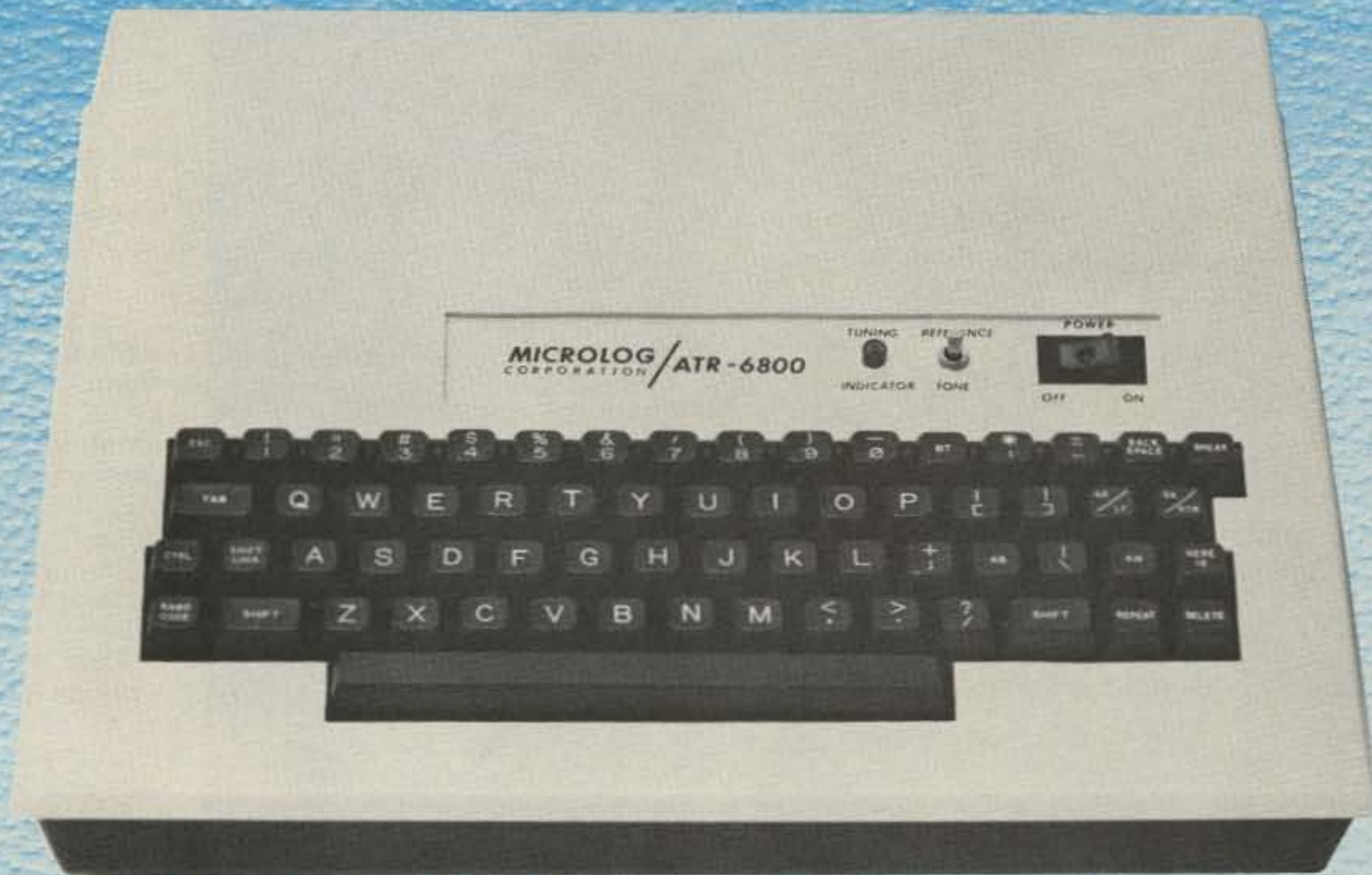

ATR-6800 comes "FULLY LOADED" with all options  
Direct hook-up to your Transceiver    Nothing else to buy

- AFSK Generator with programmable MARK/SPACE
- Computer enhanced dual tone demodulator
- Audio-visual tuning aids plus scope output
- Automatic Response (WRU)
- 10 programmable message memories
- 4 programmable SELCAL memories
- Non-volatile (battery backup) memory
- 2000 character text buffer
- Split Screen - Type & Edit while receiving
- Black or white; Normal or Zoom display
- Real time clock
- Auto Ident for CW/RTTY
- Morse 1-199 WPM
- Baudot 60, 66, 75, 100, 130 WPM
- ASCII 110-4800 baud; Upper & lower case
- Printer-Speed Converter output
- Cassette "Brag Tape" record/play interface
- Computer mode (M6802) 4K byte RAM
- Full/half Duplex Computer Terminal Mode
- 16 I/O lines for external control



*Plus much, much more . . .*

ATR-6800 video terminal with built-in AFSK modem  
and nine inch video monitor.    Amateur net \$1895.

Ask your dealer or call for additional information.

Prices subject to change.



M55

**MICROLOG**  
CORPORATION

4 Professional Drive - Suite 119  
Gaithersburg, Maryland 20760  
Telephone (301) 948-5307

## DXPEDITION TO MT. ATHOS BY SV1DC, SV1IW, AND SV1JG

This expedition to Mt. Athos was the outcome of long discussions with the community of the Holy Mountain and great efforts on the part of all concerned. The operators were notified on July 20, 1979, that

they would be permitted to transmit from Mt. Athos; they departed Athens on Monday, August 6.

SV1DC drove twelve straight hours, and the group was on the air at 1430 UTC, August 7. Since getting to the operating spot involved walking and hand-

carrying, only a 12AVQ Hy-Gain vertical was taken; no antennas were available for other than 20, 15, and 10 meters. A Kenwood TS-520 with external remote vfo and a Honda E300 generator rounded out this field operation.

In 70 hours, over 8000 contacts were logged, including a thousand on CW by SV1IW. Most operation was on 20 and 15, with 10 meters being its usual obstinate summer self. In general, conditions were OK ex-

cept toward Asia—only a few stations from Asia got through.

The Mt. Athos operation shut down at 0200 UTC on August 11; SV1IW and SV1JG along with SV1KP (Ms. SV1IW) proceeded to the island of Crete for a "vacation-style" expedition. In ten days, the three made 6000 more contacts, including many by Natasha, who signed SV9YL. During this period, propagation reversed itself, with conditions being better toward Asia than to North America.

The operators of this Mt. Athos and Crete expedition express their appreciation to all who called in and made their trip a successful one. We, in turn, thank them for putting two new countries in so many logs around the world.

### NOVICE CORNER

Let's talk about the perennial Novice, the one who never seems to learn. This is a rare case, actually, as most amateurs advance to being reasonably competent operators as they gain experience. Today's topic is how to work through a pileup on CW while causing minimal interference to others.

This morning, VQ9MR was working the US on the long path at 14,036 kHz, using relatively high-speed CW. The stations he was working were all about one kHz higher in frequency. That is, VQ9MR was "listening up one" without saying so, enabling those who grasped the pattern to easily have a quick QSO. One poor K4 station insisted on calling exactly on VQ9MR's frequency, which was bad enough; that same K4 also seemed inclined to transmit at the worst possible times, like when VQ9MR was also sending. What boggles the mind is that our K4 friend has been a ham for over twenty years! It was 8:00 am, so maybe he was asleep at the key?

First, our K4 person slowed down the whole operation by causing many to miss their report from VQ9MR; indeed, often one could not hear the Chagos come back through those still calling. This is not an uncommon problem. But if one particular K4 caller had had his act together, with the strong signal he had, he surely could have worked the DX on one or two calls, and he would have been gone, instead of fouling up the works for a long period of time.

The procedure for handling a situation such as this is simple and the rewards are great, especially with an excellent CW operator like VQ9MR handling the pileup. The goal, of course, is to transmit to the DX off fre-



On Crete (l-r), SV1IW, SV1KP, and SV1JG.



SV1IW works SSB from Mt. Athos, while SV1DC observes.

Continued on page 223

# Buy One Of These Transceivers From Ham Radio Center & Be Guaranteed That You Will Get The Best Price!



## Ham Radio Center's Best Price Guarantee

1. Shop any or all the ham dealers with a TOLL-FREE (WATS) Line.
2. Then call HAM RADIO CENTER.
3. HAM RADIO CENTER guarantees to meet or beat any legitimate price\* quoted by a factory authorized ham dealer with a TOLL-FREE (WATS) Line on the following equipment:

DRAKE	KENWOOD	TEN-TEC	SWAN	YAESU
TR-7/DR-7 R-7/DR-7	TS-120S TS-180S/DFC TS-520SE TR-7600	509 (Argonaut) 570 (Century/21) 545B (Omni-A) 546B (Omni-D)	100-MX Astro-150	FT-101Z FT-101ZD FT-901DM FT-227RB CPU-2500RK

4. This guarantee on the above transceivers expires December 31, 1979.

\*NOTE: HAM RADIO CENTER *limits* legitimate price to current dealer cost plus mark-up!

CALL TOLL-FREE

# 1-800-325-3636

FOR BEST PRICE GUARANTEE

## HAM RADIO CENTER

8340-42 Olive Blvd. • P.O. Box 28271 • St. Louis, MO 63132



(Cut on dotted line and keep next to your radio equipment)

(Cut on dotted line and keep next to your radio equipment)

# New Products

## SWAN ASTRO 150 SSB TRANSCEIVER

Swan is back! After a several year hiatus, during which little was heard from the company, Swan has returned to amateur radio with an impressive array of all-new, state-of-the-art equipment.

Swan, for those who have short memories, was a dominant force in amateur gear in the late '60s and early '70s. I was one of thousands of young hams of that era who yearned to own a Swan rig, but my high school and college finances never gave me that opportunity. That's one reason I jumped at the chance to put one of Swan's new breed, the Astro 150 SSB Transceiver, through its paces.

The Astro 150 bears scant resemblance to the transceivers of that earlier time. If you haven't shopped for an allband rig in the last five or ten years, you'll be amazed at just how compact and convenient they are.

## General Description

The Astro 150 is a five-band SSB and CW rig covering 10-80 meters. A sister model, the Astro 151, covers 15-160 meters. The frequency coverage on each band extends well beyond the upper and lower limits of the amateur allocations, making the 150 a fine choice for MARS operation. With the bandswitch in the 20-meter position, for example, the transceiver tunes from 13.8 to 16.0 MHz. The other bands offer a similar overlap.

While the 150 is designed for SSB and CW operation, the owner's manual advises that SSTV and RTTY operation is possible if you take precautions. It recommends providing a small cooling fan for the heat sinks of both the transceiver and its power supply. In addition, the mike gain control should be used to reduce output to 50 Watts or less. A rear panel RCA jack is provided for inputting AFSK or SSTV signals.

## Inside the 150

This transceiver is a ruggedly

built modular rig. Virtually all components, including most of the front-panel controls, mount on printed circuit boards. Connections between the boards are mostly of the plug-in variety, so removing a board for service should not be difficult. A profusion of heavy metal brackets and plates provides rf shielding as well as mechanical rigidity. My lone reservation about the construction of the 150 is that a few of the metal brackets inside the rig have sharp edges which *might* erode the insulation on nearby wires. Admittedly, this is a minor point, as an enormous amount of abuse and vibration would be necessary for such damage to occur. A couple of well-placed pieces of plastic tape would set my mind completely at ease. Unless you plan extensive mobile and portable operation with your Astro 150, it is not cause for concern. This rig will last.

Despite its small size (3.75" H x 9.75" W x 11.75" D), the 150 weighs in at a hefty 13 pounds. The companion PSU-5 Power Supply/Speaker is of similar size. Both the transceiver and its power supply have their own on-off switches, a nice feature for those who don't like to connect a "hot" lead to any piece of equipment.

With few exceptions, there is no shared circuitry between the receiver and transmitter. The receiver is a single-conversion design with a 9-MHz i-f. The claimed sensitivity is .35  $\mu$ V for 10 dB (S + N)/N. For CW operation, a 300-Hz i-f filter can be selected, or you can opt to use the SSB filters.

The transmitter is of a broad-banded design with an output power of 100 Watts PEP. As with most "no tune-up" transmitters, a low swr is important. The 150 will perform up to specifications only if it is operated into an swr of 2:1 or better. At higher ratios, the transceiver protects itself by automatically reducing output power so that the final transistors do not overheat. For this reason, Swan recommends using an antenna tuner to keep the swr, as seen by the transceiver, as low as possible.

The 150 offers full break-in (QSK) on CW, something found on few rigs at any price these days. Break-in is accomplished by leaving the final amplifier always connected to the antenna through the low-pass filters. In the receive mode, the final power transistors are biased off, effectively creating an open circuit on the transmitter output transformer. The receiver input is coupled to the secondary of this transformer via a high-speed reed relay.

Perhaps the most unique technical feature of the Astro 150 is its method of frequency

selection and tuning. This transceiver is one of a small handful of amateur HF rigs incorporating true digital frequency synthesis. Much of our 2-meter equipment (and even some CB gear) has used synthesizers for several years, but only recently has it become available in multi-band HF radios.

Incidentally, just because a transceiver has a digital display, this does not necessarily mean that it's synthesized. In many rigs, the operating frequency is determined by conventional vfo circuitry, and a frequency counter is used to produce the digital display. The principle of synthesized frequency control is completely different, as we shall see.

Swan's design uses a pair of phase-locked loops (PLLs) to provide precise crystal-controlled reference frequencies to six voltage-controlled oscillators (vco's). Five of these are designated as "band" vco's. The outputs from the band vco's are divided by a diode-programmed divider so that band vco frequencies are variable in steps of 500 kHz. The transceiver's bandswitch selects the proper vco and diode program for each band. The 7-32-MHz output of the selected band vco is summed with the 5-7-MHz output of the sixth or "tuning" vco to produce a local oscillator frequency in the 12-39-MHz range. The local oscillator is thus always about 9 MHz above the operating frequency, and indeed, the Astro 150 uses a 9.0165-MHz i-f.

Directing traffic inside the synthesizer is an 8048 microprocessor chip, a device from the same family as the popular 8080 chip found in thousands of microcomputer systems. A small amount of read-only memory stores a program containing the instructions which allow the 8048 to control this complex radio.

The microprocessor accepts as inputs the band and mode you have selected, along with signals from the tuning controls. It uses this data to produce signals which determine the frequency of the tuning vco. The 8048 also sends the proper information to the readout board to enable it to display the correct frequency. The microprocessor and its program also carry out other functions which would otherwise require much additional logic. For example, as long as power to the 150 is not interrupted, the microprocessor will remember the last frequency used on each band. If you want pileups on five different bands simultaneously, the Astro 150 can do it!

With this high-technology frequency-determining scheme, you wouldn't expect the 150 to



Swan's Astro 150 SSB Transceiver.



# Discover the unrivaled ASTRO 102BX with Dual PTO's

Plus IF Passband Tuning/Full Band Coverage, Speech Processing, 235 Watts PEP All Bands and Much More.

**4-Function Meter**  
reads "S" units in receive, and selects forward power, reflected power, or ALC in transmit.

**Visual Display of Passband Tuning**  
A series of 8 LED's indicate the equivalent band width and position of the passband from 0.6 to 2.7 KHz as the passband tuning knob is rotated.

**300Hz Crystal CW Filter**  
Cascaded with the passband filters and tunable through the passband. Combined with notch filter yields unrivaled CW performance.

**Full or Semi CW Break-in**  
A must for the avid CW operator!

**2 Position CW Wave Shaping**  
Your choice of soft or hard CW rise and decay time!



**Variable AGC Decay**  
Continuously variable to suit your preference.

**Passband Tuning with 16 Pole Filters**  
Two 8-pole crystal filters in cascade provides a 1.4:1 shape factor at -100dB! The ultimate in selectivity.

**Tunable Notch Filter**  
Provides the ability to "notch out" QRM. When used in conjunction with the passband tuning, provides the ultimate in removing interference.

**Dual PTO's**  
Two independent high stability PTO's provide true split band operation. The digital counter reads the PTO selected, or in split band reads the PTO used for receive, then switches to the transmit frequency selected when the mic is keyed.

**All Band Coverage using PLL and Synthesizer for Band Selection**  
Full coverage of 160 meters through all of 10 meters in 9 ranges . . . diode matrix programmed for now — or for the future!



The ASTRO 102BX with it's companion PSU-6 Power Supply, 1500Z Linear Amplifier and ST-2A Antenna Tuner provides a matched and highly efficient 1500 watt PEP or 1000 watt CW complete station to be complemented by a great Swan antenna.

All Solid State Quality American Construction

# ASTRO 102BX

**SWAN**  
ELECTRONICS

A member of the Cubic Corporation family of companies

305 Airport Road / Oceanside, CA 92054 / 714-757-7525

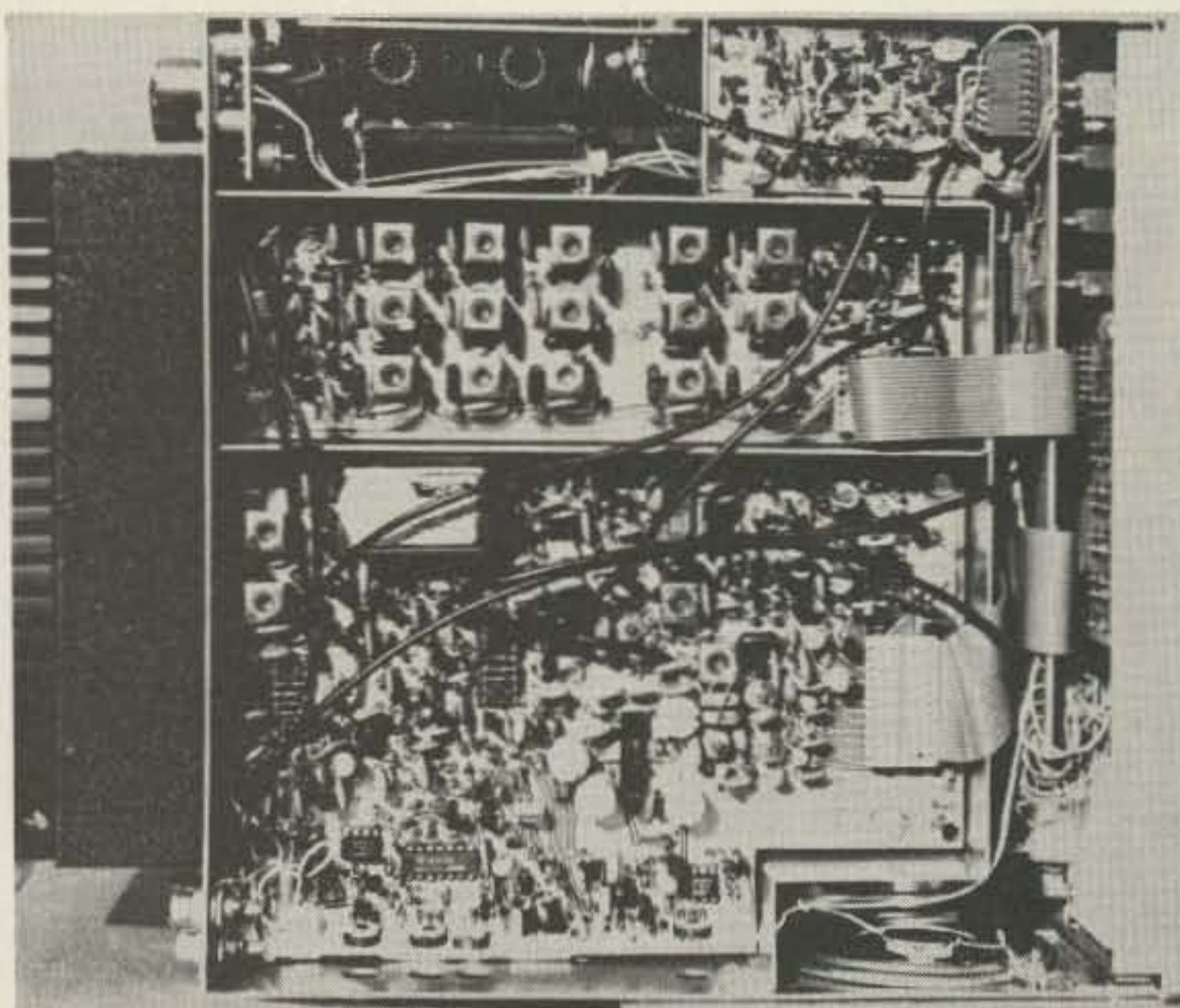

Top view of Astro 150 chassis.

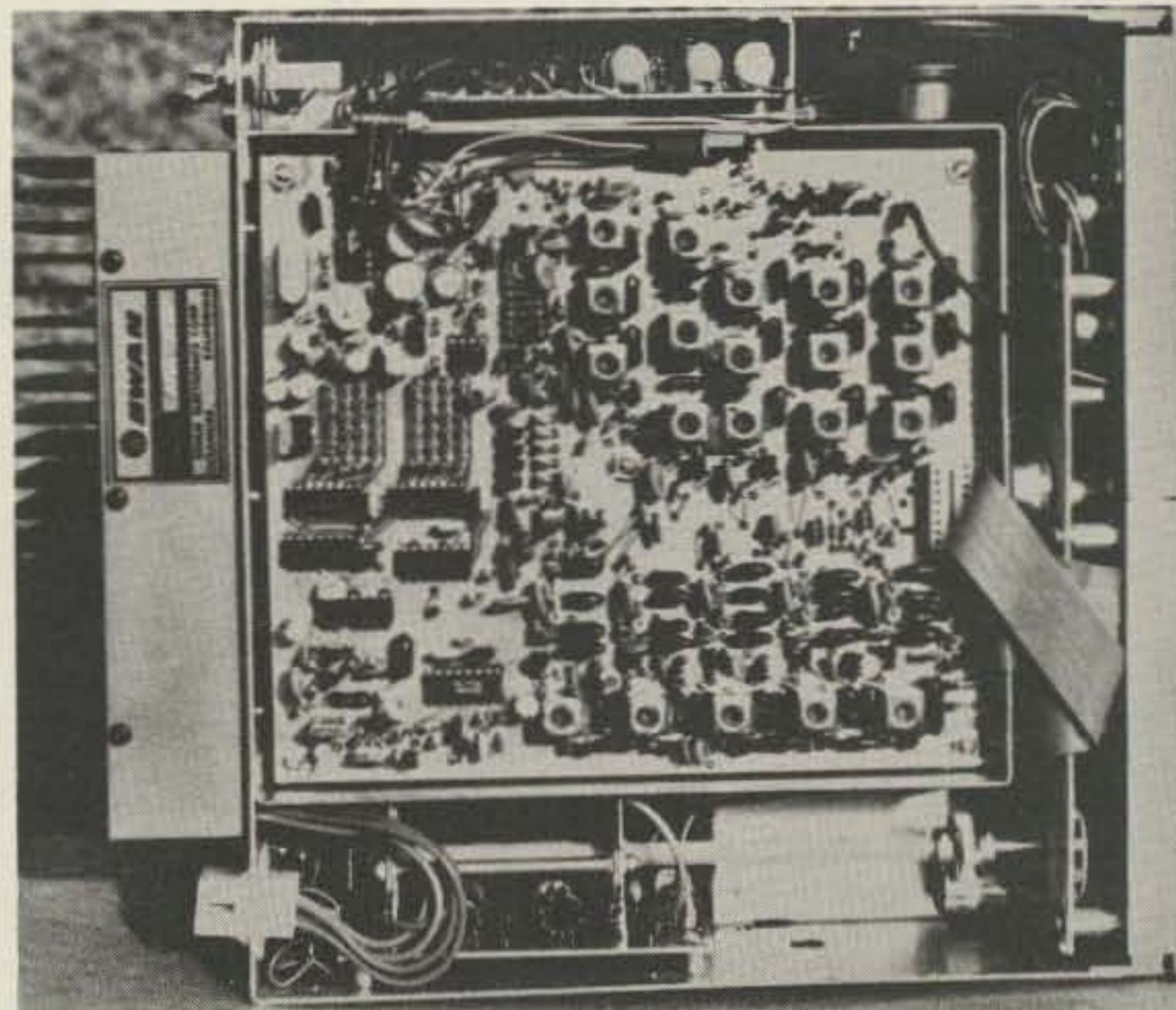

Bottom view of the Astro 150 (with metal shield removed).

have a conventional tuning knob... and it doesn't. The main tuning control is called the VRS (variable rate scanning) knob. The shaft of this knob is attached to a cam which actuates either of two microswitches, depending on which way the knob is turned. When actuated, these microswitches send signals to the 8048 microprocessor. For example,

when the VRS knob is rotated clockwise from its neutral 12 o'clock position, the left-hand microswitch is tripped, sending a signal to the 8048, which then issues commands causing the transceiver to begin scanning upward in 100-Hz steps. If the VRS control is turned counterclockwise, the right-hand microswitch is tripped, and the transceiver begins tuning downward

in frequency. A potentiometer attached to the VRS knob shaft determines the scanning rate. The further the knob is rotated from the neutral 12 o'clock position, the faster the frequency changes. Once the desired frequency is reached, the VRS knob is returned to the neutral position, and the scanning stops. Scanning control is also available via up/down push-but-

tons on the included hand-held microphone, making mobile operation safer and more convenient.

Other front-panel controls include both RIT and Fine Tuning. RIT changes only the received frequency (up to  $\pm 300$  Hz), while the Fine Tuning control alters both transmit and receive

*Continued on page 218*

## INTERNATIONAL 160 METER

### PHONE CONTEST

- SPONSORS**..... 73 Magazine, Peterborough, New Hampshire 03458.
- DATES & TIMES**..... 0000Z 19 January 1980 to 2400Z 20 January 1980.
- OBJECT**..... To work as many stations as possible on 160 meter phone in a maximum of 30 hours of allowable contest operation. Multi-operator stations may operate the full 48-hour period.
- ENTRY CATEGORIES**...
- (1) Single operator, single transmitter, phone only; (2) Multi-operator, single transmitter, phone only.
- EXCHANGE**..... Stations within the continental 48 US states transmit RS report and US state; all others transmit RS report and DX country.
- POINTS**..... All contacts score FIVE (5) POINTS each. The same station can only be worked once for contest points.
- MULTIPLIERS**..... ONE (1) multiplier point is earned for each US state worked within the continental US; THREE (3) multiplier points are earned for each DX country worked outside the continental US.
- FINAL SCORE**..... Total QSO points times total multiplier points equals claimed score.

- CONTEST ENTRIES**..... Each entry must include logsheets, dupe sheet for 100 or more contacts, a summary sheet, and a multiplier checklist.
- ENTRY DEADLINE**..... All entries must be postmarked no later than 20 February 1980.
- DX WINDOW**..... All stations are expected to observe the DX window from 1.825-1.830 MHz as mutually agreed upon by top-band operators.
- DISQUALIFICATIONS**...
- Contest disqualification may result if contestant omits any required entry forms upon submission of results: operates in excess of legal power limitations or frequency allocations within his given area; manipulates operating times to achieve a score advantage; or fails to omit duplicate contacts which would reduce the overall score more than 2 per cent.
- AWARDS**..... Contest awards will be issued in each operator category in each of the continental US states and DX countries.
- CONTEST ADDRESS**.... Those wishing contest information or entry forms or who desire to submit a contest entry should enclose an SASE and write to:

**Dan Murphy WA2GZB**  
Post Office Box 195  
Andover NJ 07821 USA

# Contests

Robert Baker WB2GFE  
15 Windsor Dr.  
Atco NJ 08004

## TOPS CW CONTEST

**Starts: 1800 GMT December 1**  
**Ends: 1800 GMT December 2**

General call is "CQ QMF" and entry classes include single- or multi-operator. Use 3.5 to 3.6 MHz, USA Novices between 3.7 and 3.75; all contacts must be on 80 meters, CW only.

### EXCHANGE:

RST and QSO number from 001.

### SCORING:

Contacts with own country score 1 point. Each call area in A/K/N/W, VE/VO, VK, and UA, etc., counts as a separate country. Contacts with stations in the same continent are 2 points, other continents are 5 points. Contacts with HQ station, GW8WJ or GW6AQ, score 25 points. It is hoped to have a special station, perhaps GB2TAC, for another 25 points. Total score is total QSO points times number of prefixes worked (prefixes as per WPX award).

### ENTRIES:

Send logs to: Peter Lumb G3IRM, 14 Linton Gardens, Bury Saint Edmunds, Suffolk IP33 2DZ, United Kingdom. Logs should be sent no later than January 31st. Contest results will be sent to all stations except eastern Europeans, which will be sent via the bureau. Due to postage costs, stations are asked to help by enclosing IRCs.

## NORTH CAROLINA QSO PARTY

**Starts: 1900 GMT December 1**  
**Ends: 0100 GMT December 3**

This contest is sponsored by the Alamance Amateur Radio Club. Suggested frequencies are plus/minus 10 kHz:

CW — 3560, 7060, 14060, 21060, 28060.

Novice — 3720, 7120, 21120, 28120.

SSB — 3900, 7270, 14290, 28590.

### EXCHANGE:

Out-of-state stations send RS(T) and state, province, or country. NC stations send RS(T) and NC county.

### SCORING:

Out-of-state stations count 1 point per NC contact. The same station may be worked on different bands, modes, or in different NC counties. Multiply QSO points by number of different NC counties worked for final score. NC stations count 1 point per QSO and multiply by total number of states, provinces, or countries for final score. NC mobiles use the number of counties operated from for an additional multiplier.

### ENTRIES AND AWARDS:

Your log must be signed; none will be returned. Logs must show RS(T)s, bands/modes, time (GMT), state, province, country, or NC county. On a separate sheet, please show name, call, and mailing address plus your total score and where operated from. In the case of multi-operator stations, this sheet must also list the call of the operators. Awards will be issued as usual. Logs must be postmarked no later than January 10th and sent to: Alamance ARC, Inc., 2822 Westchester Drive, Burlington NC 27215.

## CONNECTICUT QSO PARTY

**Starts: 2000 GMT December 1**  
**Ends: 0200 GMT December 3**  
**Rest period from 0500 to 1200 GMT December 2**

The Candlewood ARCA invites all amateurs to participate in this year's contest. Phone and CW are the same contest. Stations may be worked once on each band and mode including OSCAR (and RS) as a separate mode. Novices will please identify themselves by ?n. W1QI, the club station, will operate CW on odd hours and SSB on even hours. Connecticut mobiles working in other than

their home counties will receive special certificates provided they make at least 20 out-of-state QSOs. Mobiles count as a separate station in each county.

### EXCHANGE:

Send QSO number, RS(T), ARRL section for out-of-state stations, and Connecticut county for Connecticut stations.

### FREQUENCIES:

Suggested frequencies are 40 kHz up from the bottom of the CQ bands plus 3927, 7250, 14295, 21370, and 28540 for SSB. Watch for Novices on 3725, 7125, 21125, and 28125.

### SCORING:

Each completed QSO counts 1 point, 2 points if with a Novice, and 3 points if via OSCAR. Also, contacts with W1QI count 5 points. Only one DX multiplier is allowed although all DX QSOs count for QSO points. Out-of-state stations multiply QSO points by the number of Connecticut counties worked (8

max.). Connecticut stations multiply the number of QSO points by the number of ARRL sections worked plus a maximum of 1 DX multiplier.

### ENTRIES AND AWARDS:

Certificates for the top station in each ARRL section and each Connecticut county if the winner has at least 5 QSOs. Certificate to top-scoring station in each DX country. A Worked All Connecticut Counties certificate will be awarded to each station working all 8 counties during the contest. Logs must show all QSO info plus band, mode, and single- or multi-operator class. Entries must also show QSO points and claimed score. Enclose a large SASE for results. Logs must be postmarked no later than January 2nd and sent to: Skip Paulsen W1PV, 2 Ryders Lane, Danbury CT 06810.

Continued on page 228

# Results

## RESULTS OF 1979 NEW JERSEY QSO PARTY NEW JERSEY

Atlantic	K2NJ/2	50
Bergen	N2CR	1584
Burlington	W2XQ	11352
Camden	WA2MNO	9540
Cape May	K4FFM/2	176
Cumberland	K2OG	2599
Essex	WA2LWT	1060
Gloucester	AB2E	4011
Hudson	K2NJ/2	70
Hunterdon	KA2EGO	490
Mercer	W2ZQ*	14202
Middlesex	WA2NPP*	94599
Monmouth	AF2L	24939
Morris	WB2POG	8621
Ocean	K2NJ/2	78
Passaic	WA2OVE	27264
Salem	WA2RAN	18232
Somerset	K2PF	114
Sussex	W2RQ	26400
Union	WB2RMI	15288
Warren	K2NJ/2	84

## OUT-OF-STATE

Maine	N1PL/1	846
Conn.	WA1TZY	585
N.H.	K1KA**	1470
E NY	WB2THN	1380
W NY	N2ARG	496
Del.	K3UEI/3	25
E Pa.	K3NB**	3591
W Pa.	AD8J	63
Ga.	A14X	18
Tenn.	WB4WHE	30
La.	W5WG	1445
East Bay	WB6IYS	64
Los Ang.	N6HE	16
Wash.	WB7QEL	60
Ohio	WA8ZNC	704
W Va.	W8UI	1660
Ill.	W9QWM	240
Wisc.	K9GDF	9
Kans.	WD0HAP	120
Ont.	VE3DAP**	2268

\* = multi-operator

\*\* = worked all 21 counties

# Calendar

Dec 1-2	ARRL 160 Meter Contest TOPS CW Contest
Dec 1-3	North Carolina QSO Party Connecticut QSO Party
Dec 8-9	ARRL 10 Meter Contest Garden City Contest
Dec 22-23	Teenage Radio Sprint
Jan 5-6	QSL Exchange Contest
Jan 12-13	International Island DX Contest
Jan 19-20	North and South America RTTY Flash
Feb 2-3	South Carolina QSO Party
Mar 9-10	Europe and Africa RTTY Giant Flash

## For Your New Repeater System,

## Or to Replace Your Old "Klunker"

H. Paul Shuch N6TX  
Microcomm  
14908 Sandy Lane  
San Jose CA 95124

# Low-Cost Receiver for Satellite TV

— this modular design uses  
readily available technology

**Author's Note:** This article was originally presented by the author as part of the professional program, "Satellite TV and the Private User," at WESCON/79 in San Francisco CA on September 20, 1979. WESCON, the annual Western Electronics Show and Convention, is a large-scale trade show which features films, exhibits, and professional sessions related to all facets of the electronics industry.

The technological revolution which is making possible the distribution of television programming via satellite has been discussed in both popular and tech-

nical publications and at conferences and seminars.<sup>1</sup> In this article, I will explore the trade-offs involved in designing a wideband, tunable FM video receiver for processing and displaying DOMSAT (Domestic Communications Satellite) signals.

It should be recognized that there are at least as many conflicting receiver design philosophies as there are microwave engineers, and no claim is made that the concepts presented here are necessarily superior to any other approach. Nevertheless, this receiver does provide adequate performance at low cost, and the trade-offs encountered are typical of those with

mystique of microwave receiver design.

### Signal Characteristics

Unlike the vestigial-sideband AM video standard used for terrestrial TV broadcast, DOMSAT video incorporates a wideband FM format, with audio multiplexed onto a subcarrier prior to modulating the composite. The resulting wideband channel (see Table 1) affords considerable "FM advantage" (signal-to-noise enhancement for a given carrier-to-noise ratio); however, the bandwidth and format tend to complicate the receiver design task.

Were a signal consisting

### Video Carrier

Channels	24
Adjacent channel spacing	40 MHz
Orthogonal channel spacing	20 MHz
Frequency band	3.7-4.2 MHz
Peak deviation	10.25 MHz
Max. video frequency	4.2 MHz
Pre-emphasis curve	CCIR 405-1

### Audio Subcarrier

Frequency	6.8 MHz
Peak deviation	75 kHz
Max. audio frequency	15 kHz
Pre-emphasis time const.	75 usec

### Energy Dispersal

Waveform	Triangular
Frequency	30 Hz
Peak deviation	750 kHz

### Composite

EIRP	+65 dBm
------	---------

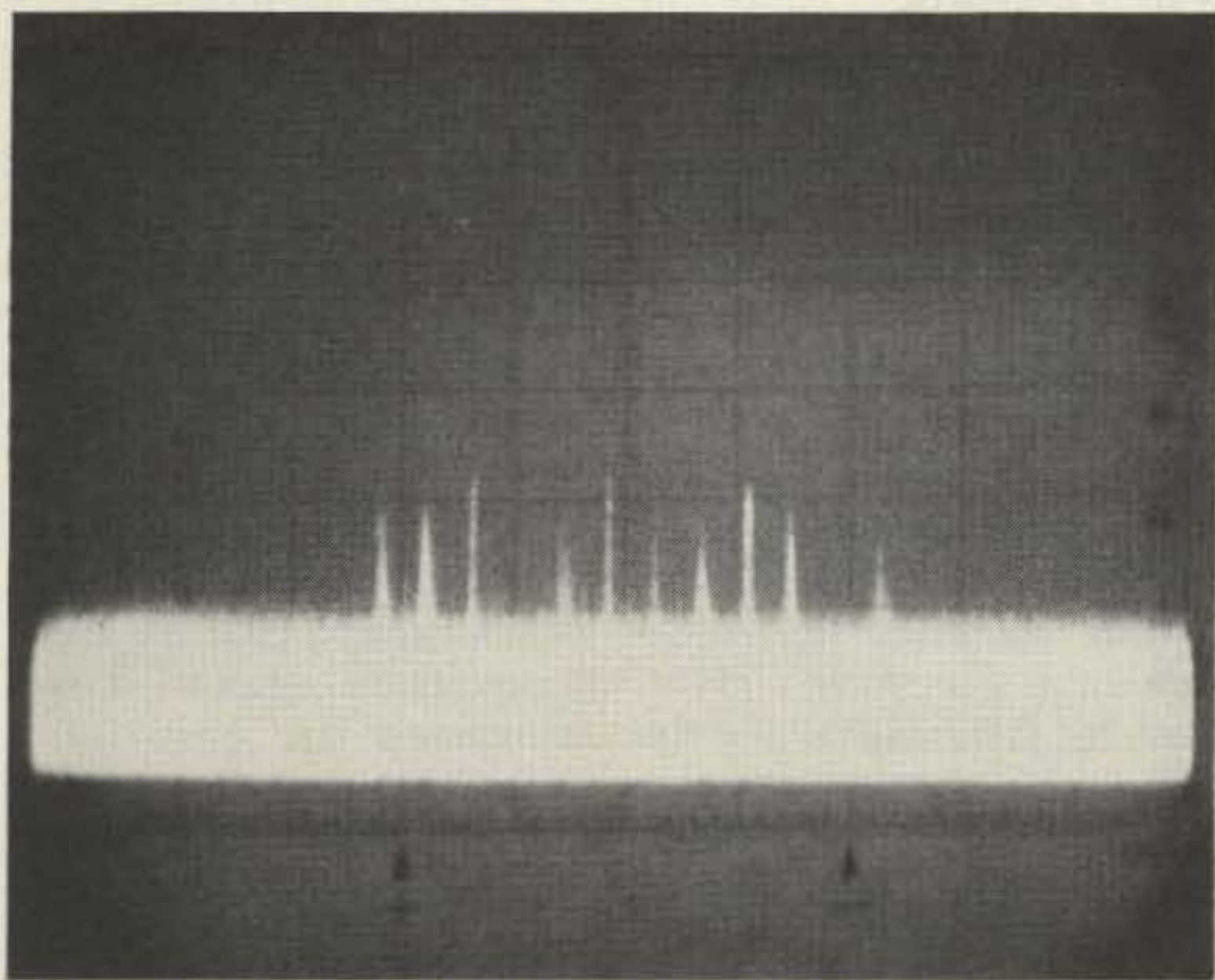

Fig. 1. Spectral display of a 4-GHz DOMSAT downlink recovered on a 4.7-meter antenna and amplified by a GaAs FET Low-Noise Amplifier (LNA). Horizontal deflection is 100 MHz/div, and vertical sensitivity is 10 dB/div. Eleven video carriers, along with their associated FM sidebands, are visible. Note that the fourth channel above the bottom of the band is vacant. Otherwise, channel spacing is 40 MHz and carrier-to-noise ratio appears to be on the order of 10 dB.

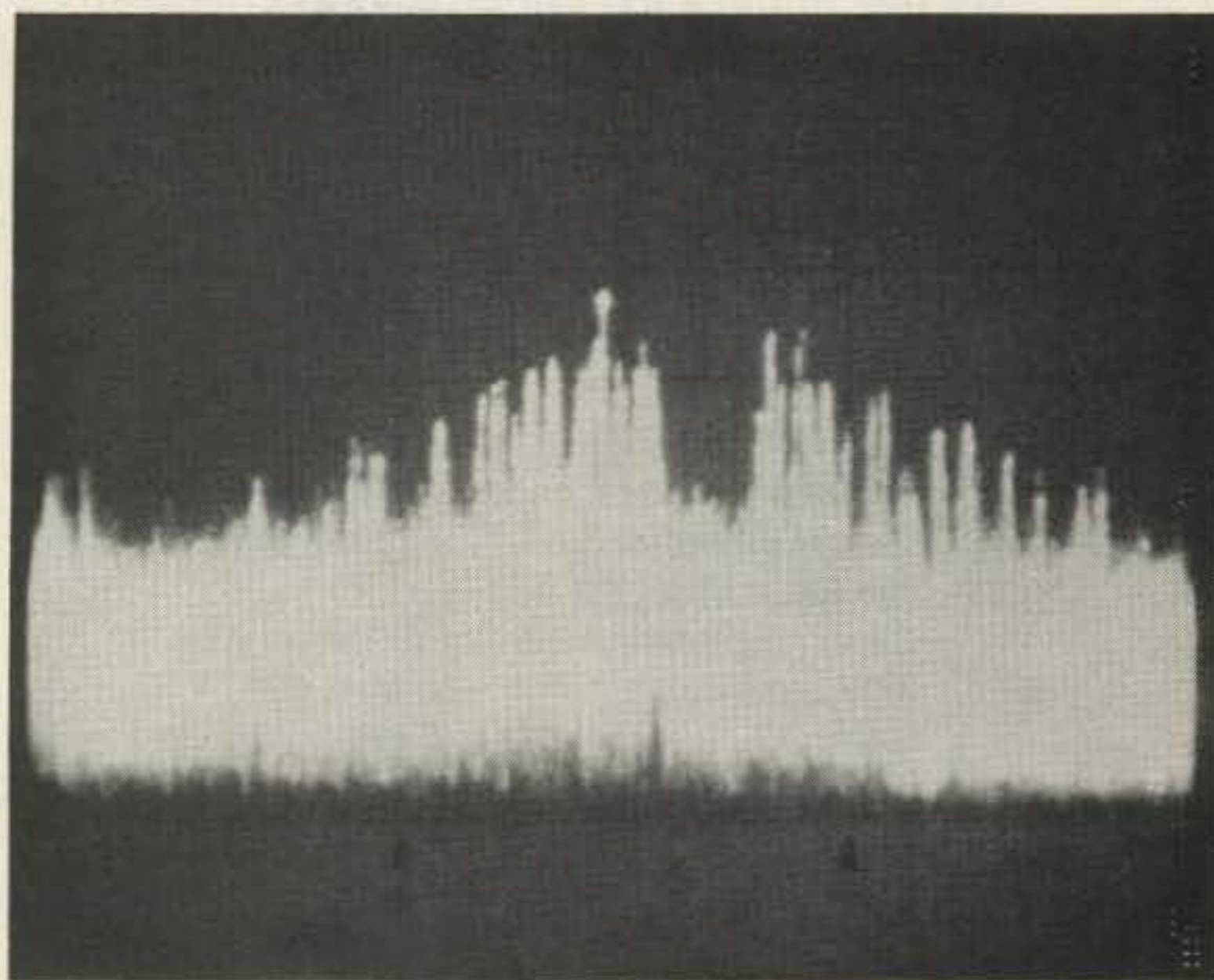

Fig. 2. Spectral display of a single wideband FM video channel after dual-downconversion to a 70-MHz second i-f. Horizontal deflection is 3 MHz/div, and vertical sensitivity is 10 dB/div. This is the composite FM signal from which video and audio are to be demodulated.

would involve merely heterodyning the selected channel in the 4-GHz transmission band against a stable microwave local oscillator (LO), and applying the VHF difference signal directly into the tuner of a conventional TV set. Unfortunately, with DOMSAT signals as they are currently formatted, such a down-conversion process would merely spread unintelligible sidebands across six adjacent TV channels.<sup>2</sup> Thus, it becomes necessary to design a complete receiver, including heterodyne conversion stages, demodulators, and video and audio processing circuitry, to recover and display satellite TV.

#### Frequency Agility

It will be noted from Table 1 that the downlink band used by most North American DOMSATs is 500 MHz wide, and that for a given antenna polarization there will be present up to twelve video carriers, spaced 40 MHz apart (see Fig. 1). That these signals

are of extremely low amplitude complicates the design of the Earth station's antenna<sup>3</sup> and low noise pre-amplifier,<sup>4</sup> but we will assume for the moment that an adequate signal-to-noise ratio exists at the input of the receiver to permit signal recovery. The problem at hand, then, is to select a particular 40-MHz wide channel from among 12 such signals in a 500-MHz wide band, while adequately attenuating the adjacent channels.

A Tuned Radio Frequency (TRF) approach, with detection occurring directly at the downlink frequency, would require readily-tunable bandpass filters of high Q (to accommodate the 1% or so channel bandwidth) and skirts steep enough to reject adjacent channels. Tuning requirements rule out both LC and resonant cavity filters, suggesting the use of Yttrium-Iron-Garnet (YIG) sphere resonators for channel selection.

Although YIG filters can readily be bias-tuned, their

cost and the complexity of the required driving circuitry tend to rule them out for private terminal applications. Furthermore, it is far easier to tune a single oscillator than a bank of filters. This suggests heterodyne-downconverting a selected channel into a fixed intermediate frequency, at which demodulation may take place.

#### I-f Selection

The selection of intermediate frequencies for superheterodyne receivers involves careful attention to the required and realizable mixer bandwidths, image rejection criteria, demodulator circuit capabilities, and tuning constraints. These various considerations tend to be mutually exclusive, but it has been shown<sup>5</sup> that for narrowband systems, a reasonable compromise is achieved by selecting an intermediate frequency approximately one-tenth the frequency of the incoming signal. Although DOMSAT video hardly qualifies as a narrowband service, we can use the one-tenth rule of thumb to establish a starting point. For a 4-GHz

input signal, this suggests a UHF i-f. However, the various demodulator circuits compatible with wideband FM video (quadrature detector, ratio detector, Foster-Seely discriminator, phase-locked loop and the like) are all most readily realized in the lower portion of the VHF spectrum. An obvious solution is to utilize dual downconversion, with first and second i-fs near 400 and 40 MHz, respectively.

In fact, numerous experimental DOMSAT video terminals have adopted the above frequency scheme, many employing UHF TV tuners for the second downconversion. The drawbacks to such an approach include the typical UHF tuner's restricted channel bandwidth, relatively high noise figure, and poor local oscillator stability. Nevertheless, when cost is the primary design constraint, these problems can be circumvented.

Not so readily resolved is the input filtering requirement which such a frequency scheme imposes. Assuming low-side first LO injection and top-channel reception, the first conver-

**MX-4200 DOUBLE-BALANCED MIXER**

Input frequency	3.7–4.2 GHz
LO frequency	2.5–3.0 GHz
Intermediate frequency	1.2 GHz
Isolation	20 dB
Conversion loss	7 dB

**LO-3000 VOLTAGE CONTROLLED OSC**

Output frequency	2.5–3 GHz
Output power	+7 dBm
Spurious rejection	20 dB
Tuning voltage range	3–10 V dc
Supply potential	+13.5 V dc

**RF-1200 AMPLI-FILTER**

Center frequency	1.2 GHz
3-dB bandwidth	50 MHz
Gain	15 dB
Noise figure	2 dB
Supply potential	+13.5 V dc

**LO-1270 LOCAL OSCILLATOR**

Output frequency	1270 MHz
Stability	±0.001%
Power out	+7 dBm
Spurious rejection	40 dB
Supply potential	+13.5 V dc

**MA-1200 MIXER-AMPLIFIER**

Input frequency	1200 MHz
LO frequency	1270 MHz
Intermediate frequency	70 MHz
Conversion gain	20 dB
3-dB bandwidth	40 MHz
Supply potential	+13.5 V dc
Isolation	20 dB

Table 2. Typical parameters for conversion modules.

sion will generate an image frequency which falls a mere 300 MHz below the bottom edge of the downlink passband. An input filter capable of providing adequate passband flatness and minimal insertion loss over the 3.7- to 4.2-GHz band is unlikely to provide adequate image rejection if a 400-MHz first i-f is utilized. One may wish to raise the first i-f high enough to

separate the image frequency band well away from the downlink passband, thus simplifying input filtering.

In fact, if the Low-Noise Amplifier (LNA) which precedes the receiver utilizes a waveguide input, then an image filter already exists. Rectangular waveguide is a high-pass transmission line. If low-side first LO injection is used and the first i-f is carefully selected, the

LNA's waveguide input will itself reject the image frequency.

Most commercial LNAs utilize an EIA standard WR-229 waveguide input. This guide has a lower  $TE_{1,0}$  cutoff frequency near 2.5 GHz. This cutoff frequency is about 1.2 GHz below the bottom edge of the receiver's required passband, so input losses will be minimal. But a first i-f of, say, 1.2 GHz, will place the image frequency as far below cutoff as the input passband is above cutoff. The image thus ends up quite far down the waveguide high-pass filter's skirts, and may effectively be ignored.

True, the fixed 1.2-GHz first i-f requires that the first LO be tunable, but we mentioned earlier that it's far easier to tune a single oscillator for channel selection than a bank of filters. And even at the top of the downlink passband, where the first LO must be tuned up to 3 GHz, the image at 1.8 GHz is sufficiently far below cutoff so that a 12-cm long input waveguide will afford on the order of 60 dB of image rejection.<sup>6</sup>

Another signpost pointing to the selection of 1.2 GHz as a first i-f is realizable amplifier Q. The 3-dB bandwidth of the i-f amplifier string must be greater than or equal to the

20-dB channel bandwidth in order to avoid unduly attenuating significant sidebands. Assuming a channel bandwidth of 40 MHz and an i-f of 1.2 GHz, this dictates an effective first i-f Q of 30. This value is readily realized with microstripline circuitry.

Despite the obvious economic advantages of the modified UHF TV tuner conversion scheme, it was decided to employ a 1.2-GHz first i-f in the Microcomm DOMSAT video receiver. But what of the second i-f—is it similarly constrained by the wide downlink passband? Actually not. With channel selection occurring in the first downconversion, the second i-f need only be wide enough to accommodate a single video channel. Downconverting the 1.2-GHz first i-f to any desired VHF frequency will allow ample second-conversion image rejection with simple i-f filtering while providing adequate bandwidth to pass the 40-MHz composite.

Since the communications industry has long utilized 70 MHz as a standard i-f for microwave links, it was decided to employ a 70-MHz second i-f in the DOMSAT video receiver. This makes it possible to utilize any of the readily available 70-MHz wide-band FM i-f strips to demodulate the video information.

**Gain Distribution**

Gain partitioning for the DOMSAT video receiver depends upon the available power from the satellite, the threshold sensitivity of the demodulator circuitry selected, and the gain of the receive antenna utilized. It has been shown that for the illumination contours typical of most North American DOMSATs, an optimum private-terminal antenna will exhibit on the order of +41-dBi gain.<sup>7</sup>

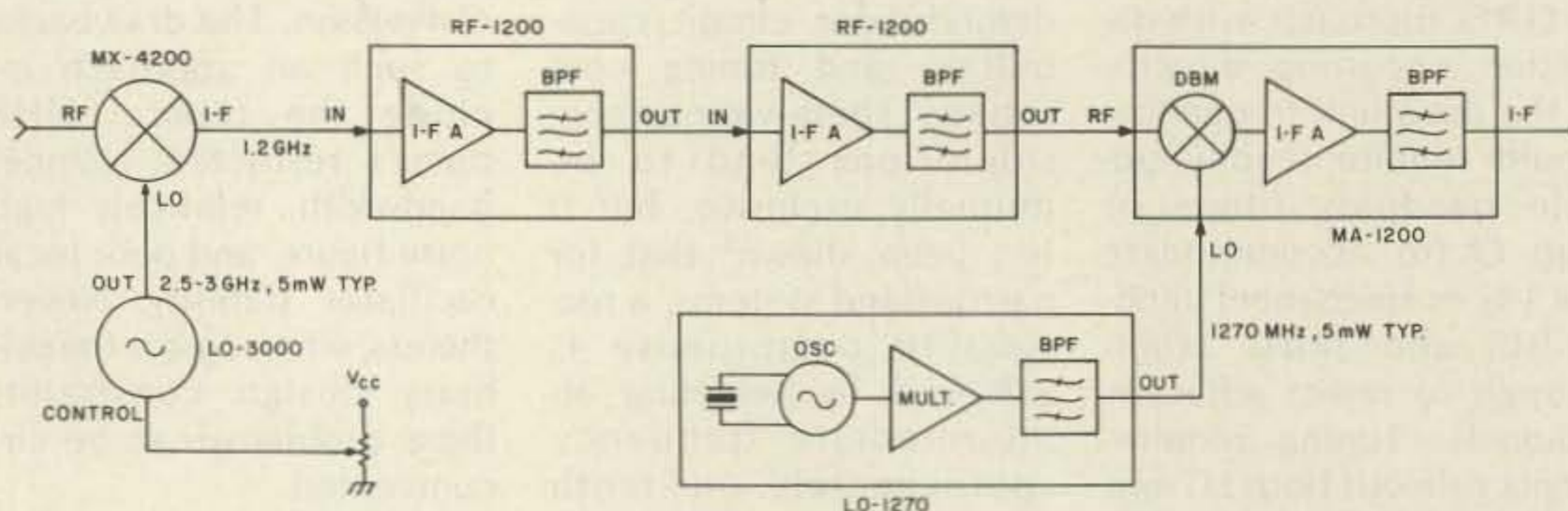

Fig. 3. Block diagram of the heterodyne downconversion portion of the DOMSAT video receiver. Shown at left is the 3.7- to 4.2-GHz input terminal from the LNA and feedline. The 70-MHz i-f output at right feeds the baseband demodulator and processing circuitry (see Fig. 7). The potentiometer shown at the lower left represents the resistive voltage divider which tunes the first LO for channel selection. Gain partitioning of the various blocks is discussed in the text.

Given the EIRP and path loss numbers listed in Table 1, it appears that the signal level available to the LNA will be on the order of  $-90$  dBm.

The input threshold for a typical phase-locked loop (PLL) integrated circuit operating as an FM demodulator at 70 MHz is on the order of  $-20$  dBm. This suggests that between the antenna and the demodulator, roughly 70 dB of conversion gain is required.

There are three sources of gain available between the antenna and the PLL. These include the LNA and first and second i-f amplifiers. There are, similarly, three sources of loss in the system: the insertion loss of the transmission line which connects the LNA to the receiver, and the conversion loss of the first and second mixers. For a typical home installation, the feedline insertion loss may be on the order of 6 dB, and if double-balanced diode mixers are used for the two frequency conversions, it is safe to assume that the conversion loss of each will be on the order of 7 dB. This suggests that the overall gain of the LNA, first, and second i-f amplifiers will need to total 90 dB for adequate DOM-

SAT video reception.

In the interest of maximizing system stability and dynamic range, it is desirable to distribute the required 90 dB of gain uniformly between the rf and two i-f frequencies. A 30-dB gain LNA is clearly feasible at 4 GHz and would require three stages of GaAs FET amplification. This amount of LNA gain is sufficient to adequately mask the noise temperature contribution of the feedline and receiver, allowing the low-noise temperature of the FETs to predominate.<sup>4</sup> Similarly, it is practical to achieve the desired 30 dB of 1.2-GHz gain by cascading two stages of ion-implanted silicon bipolar transistor amplification. At 70 MHz, the required gain is readily available from thin-film wideband gain blocks produced by a number of different vendors.

A block diagram for the dual downconversion portion of the DOMSAT video receiver, partitioned in accordance with the foregoing discussion, is shown in Fig. 3.

#### Construction of Conversion Circuitry

During the initial system-development phase of any

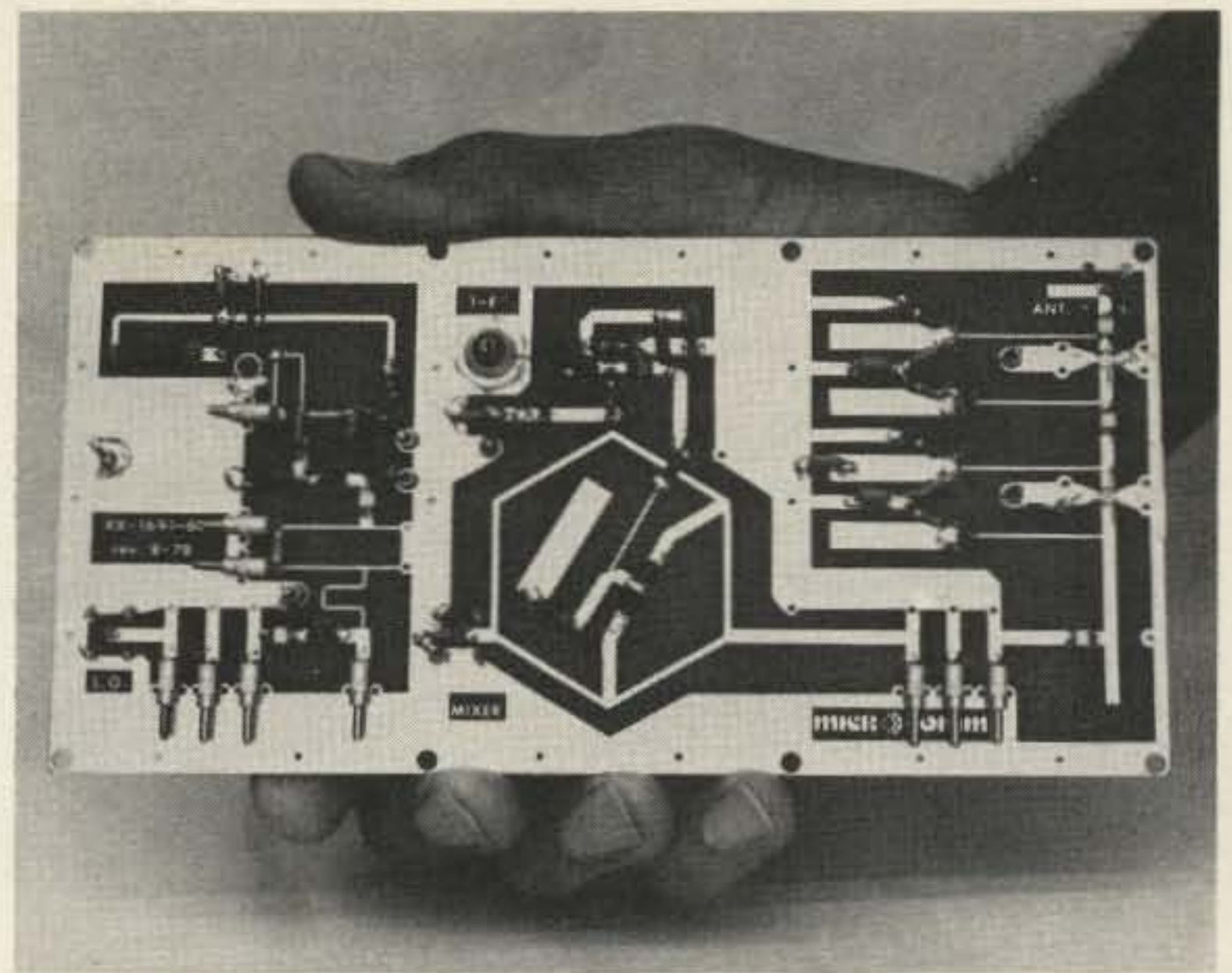

Fig. 4. Typical microstripline circuit module used for satellite video downconversion. Each module in the receive system is mounted in its own shielded enclosure, and all are interconnected via coaxial cable as discussed in the text.

new product, it is common practice to build a number of different amplifier, mixer, filter, and oscillator circuits, each connectorized for coaxial input and output and with each circuit separately boxed and shielded. A modular developmental system provides the engineer with the flexibility of changing one or more circuits without having to disrupt the rest of the system. Microcomm's earlier efforts at modular receiver development have been documented pre-

viously.<sup>8</sup>

But modularization has advantages for a production system as well. If every function represented by a block in Fig. 3 is implemented in a separate, shielded module, then isolation between stages is maximized and the crosstalk and stability problems associated with stray rf coupling can be eliminated entirely. Further advantages are realized in the area of maintainability. Should a receiver fail, fault isolation by module sub-

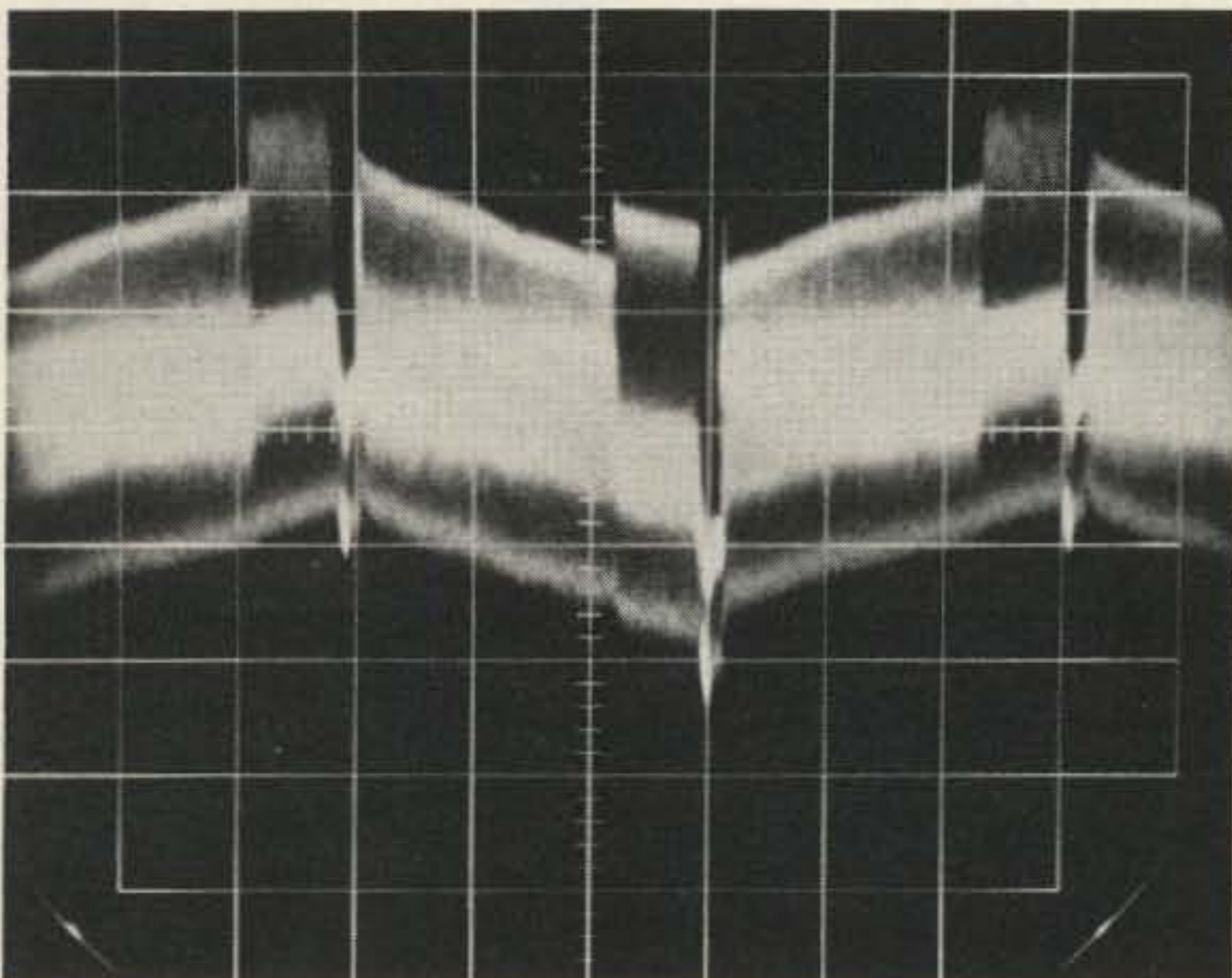

Fig. 5. Baseband output of the PLL demodulator. Presence of the energy dispersal waveform on the video composite is evident.

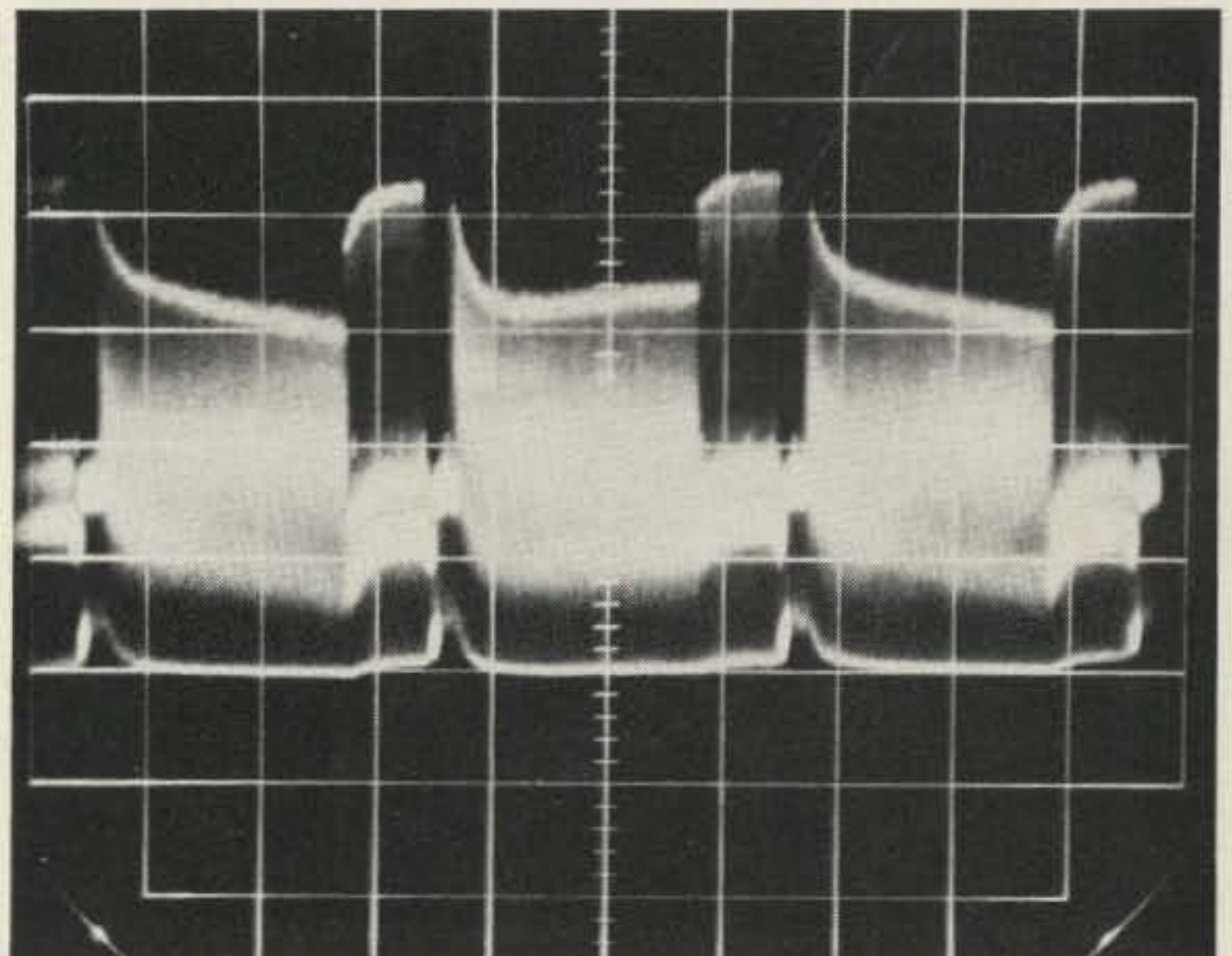

Fig. 6. The dc restorer is simply a diode clamp circuit which removes from the video waveform any vestiges of the energy dispersal waveform seen in Fig. 5.

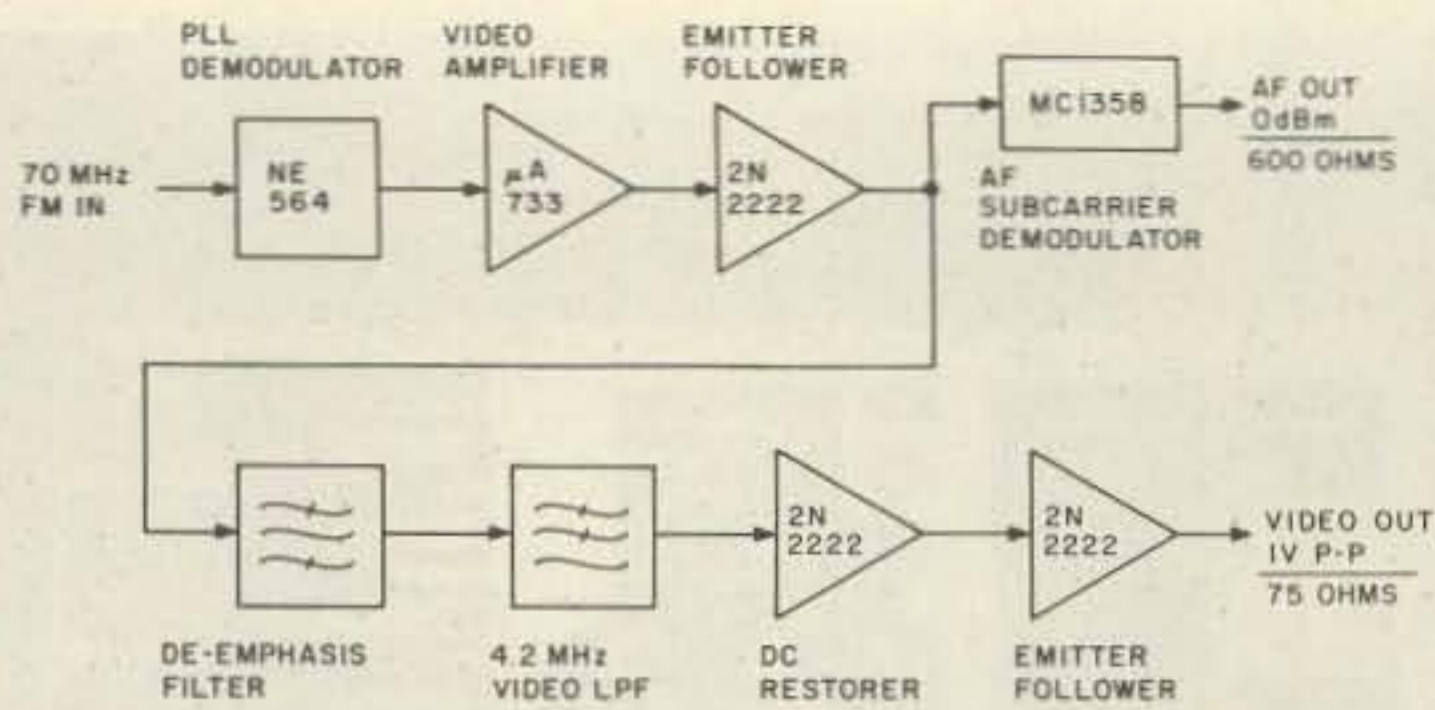

Fig. 7. Block diagram of the complete baseband processing portion of the DOMSAT video receiver. The above circuitry is driven by the output of the downconversion module set (see Fig. 3), and provides standard 1-volt video and 0-dBm audio outputs to an external modulator, studio monitor, or video tape deck.

stitution becomes a viable troubleshooting technique. And, of course, a modular system maximizes user flexibility by allowing customers to assemble from standard modules a custom system designed to meet their precise needs.

The specifications of the modules developed to implement Fig. 3 appear here as Table 2. Each of these modules employs microstripline construction, as shown in Fig. 4, to minimize component count and assure duplicability.<sup>9</sup>

#### Baseband Processing

Before the wideband FM composite shown in Fig. 2

can be displayed, several processing steps are necessary. The 70-MHz i-f signal will, of course, be demodulated first, and this may be accomplished readily by using a monolithic PLL in a standard circuit.<sup>10</sup> The output waveform from the PLL will contain both the video waveform and the modulated audio subcarrier, but superimposed on these will be found the 30-Hz triangular energy dispersal waveform added to all DOMSAT downlink signals as an interference reduction technique. This waveform is evident in the oscilloscope display in Fig. 5.

Prior to attempting to re-

move the energy dispersal waveform, it is desirable to amplify the rather feeble video level available from the PLL demodulator, and this may be accomplished using a single monolithic TV video-amplifier IC. Next, an emitter-follower permits splitting off the 6.8-MHz audio subcarrier for demodulation in a standard TV sound i-f microcircuit, whose associated circuitry is modified slightly for compatibility with the higher carrier frequency and peak deviation used on satellite audio.

After passing through a de-emphasis filter and passive video low-pass filter, the video waveform may finally be applied to a diode clamp circuit which will remove the energy dispersal waveform (see Fig. 6). An emitter-follower then establishes the desired 75-Ohm video output impedance to drive recording or display circuitry, as required.

A block diagram for a complete baseband processing subsystem is shown in Fig. 7. This circuit can be constructed on a single printed circuit board and incorporated into a complete DOMSAT video receiver by simply interfacing it to the downconversion circuitry shown in Fig. 3.

#### Display Options

An ideal DOMSAT video receiver for the home Earth-station market would provide an intercarrier audio, vestigial sideband rf output for direct interface to the user's VHF TV receiver. Such an rf output may readily be realized by using any of the available video modulator microcircuits developed for the TV game and home computer industries. In fact, the video and audio levels available from the baseband unit shown here are entirely compatible with such modulators.

Unfortunately, incorp-

orating an rf modulator in a commercial DOMSAT video receiver would subject the entire receiver to FCC type acceptance in the United States. As more than one home computer manufacturer has discovered, the type-acceptance procedure is burdensome in the extreme, with bureaucratic delays often precluding a timely market entry. In addition, the resolution and clarity of most of the available low-cost video modulators leave quite a bit to be desired, and rf modulation would tend to degrade overall video quality noticeably.

A possible solution would be to provide the user with simply a video and audio output from the DOMSAT receiver and allow him to display the receiver's output on a studio-quality TV monitor. However, few videophiles possess such a monitor, and the cost is prohibitive.

Fortunately, most videophiles do possess a videotape recorder (in fact, the owner of a home satellite Earth station would most likely find it impossible to function without one!) and the average video recorder contains an extremely high quality rf modulator. Allowing the user to interface his DOMSAT receiver to the TV via a video recorder provides an ideal solution to the type-acceptance dilemma. And those users who have no recorder are, of course, free to add an external rf modulator, any number of which are available in kit or assembled forms.

#### Equipment Availability

Once priced in the tens of thousands of dollars, DOMSAT video receivers are now being brought within the reach of the American consumer. The conversion modules shown in Fig. 3, for example, have, since late 1978, been available to the ex-



Fig. 8. The video output of the baseband unit, displayed on a TV set with the aid of the rf modulator in a video cassette recorder. Most DOMSAT viewers find the clarity and resolution of satellite video clearly superior to network video which is distributed by multiple terrestrial microwave hops.



perimeter at \$1000 complete, and to the OEM at significantly lower prices in production quantities.

It is expected that by the end of 1979, a complete, fully tunable DOMSAT video receiver, utilizing the above conversion modules and a baseband unit such as that blocked out in Fig. 7, will be available to the consumer for under \$2000. This receiver will be fully packaged and assembled, including power supply, tuner, control circuitry, and inter-connecting cables. Such a receiver promises to make possible for the first time a complete, consumer-grade Earth station, including antenna and LNA, for under \$4000. We can only begin to guess at the price breakthroughs which may follow! ■

#### References

1. John C. Bacon, "Those Great Repeaters in the Sky," WES-

CON/79.

2. H. Paul Shuch, "A Vidiot's Guide to Microwave TV Links," *MicroWaves*, June, 1979.

3. John Kinik, "Antennas and Feeds for DOMSAT Video Reception," WESCON/79.

4. Mike Fornaciari and George Vendelin, "Low-Noise Communications Amplifiers," WESCON/79.

5. H. Paul Shuch, "Rat-race Balanced Mixer for 1296 MHz," *Ham Radio*, July, 1977.

6. *Reference Data for Radio Engineers*, Fifth Edition, Howard Sams & Co. Inc., p. 23-6, "Attenuation in a Waveguide Beyond Cutoff."

7. H. Paul Shuch, "Antenna/LNA Tradeoff Analysis for C-Band Video Terminals," *Microcomm Application Note #4*, April, 1979.

8. H. Paul Shuch, "A Cost-Effective Modular Downconverter for S-Band WEFAX Reception," *IEEE Trans. MTT*, December, 1977.

9. H. Paul Shuch, "Microstrip—Magical PC Technique Explained," *73*, October, 1978.

10. "Signetics Phase Locked Loop NE564," *Signetics Corp. Applications Note*, March, 1978.

"CALL FOR QUOTE"

## KENWOOD TS-520SE



**MADISON ELECTRONICS  
SUPPLY, INC.** ✓ M35

1508 McKinney • Houston, TX 77002

(713) 658-0268

MASTERCARD • VISA

## MY COMPETITION KNOWS ME, YOU SHOULD TOO.



**COMPLETE KITS:** CONSISTING OF EVERY ESSENTIAL PART NEEDED TO MAKE YOUR COUNTER COMPLETE. **HAL-600A** 7-DIGIT COUNTER WITH FREQUENCY RANGE OF ZERO TO 600 MHz. FEATURES TWO INPUTS: ONE FOR LOW FREQUENCY AND ONE FOR HIGH FREQUENCY; AUTOMATIC ZERO SUPPRESSION. TIME BASE IS 1.0 SEC OR .1 SEC GATE WITH OPTIONAL 10 SEC GATE AVAILABLE. ACCURACY  $\pm .001\%$ . UTILIZES 10-MHz CRYSTAL 5 PPM.

**COMPLETE KIT.....\$129**

**HAL-300A** 7-DIGIT COUNTER WITH FREQUENCY RANGE OF ZERO TO 300 MHz. FEATURES TWO INPUTS: ONE FOR LOW FREQUENCY AND ONE FOR HIGH FREQUENCY; AUTOMATIC ZERO SUPPRESSION. TIME BASE IS 1.0 SEC OR .1 SEC GATE WITH OPTIONAL 10 SEC GATE AVAILABLE. ACCURACY  $\pm .001\%$ . UTILIZES 10-MHz CRYSTAL 5 PPM.

**COMPLETE KIT.....\$109**

**HAL-50A** 8-DIGIT COUNTER WITH FREQUENCY RANGE OF ZERO TO 50 MHz OR BETTER. AUTOMATIC DECIMAL POINT, ZERO SUPPRESSION UPON DEMAND. FEATURES TWO INPUTS: ONE FOR LOW FREQUENCY INPUT, AND ONE ON PANEL FOR USE WITH ANY INTERNALLY MOUNTED HALTRONIX PRE-SCALER FOR WHICH PROVISIONS HAVE ALREADY BEEN MADE. 1.0 SEC AND .1 SEC TIME GATES. ACCURACY  $\pm .001\%$ . UTILIZES 10-MHz CRYSTAL 5 PPM.

**COMPLETE KIT.....\$109**

#### PRE-SCALER KITS

**HAL 300 PRE.....\$19.95**  
(Pre-drilled G10 board and all components)

**HAL 300 A/PRE.....\$24.95**  
(Same as above with preamp)

**HAL 600 PRE.....\$34.95**  
(Pre-drilled G10 board and all components)

**HAL 600 A/PRE.....\$39.95**  
(Same as above but with preamp)

#### TOUCH TONE DECODER KIT

HIGHLY STABLE DECODER KIT. COMES WITH 2 SIDED, PLATED THRU AND SOLDER FLOWED G-10 PC BOARD, 7-567's, 2-7402, AND ALL ELECTRONIC COMPONENTS. BOARD MEASURES 3 1/2 x 5 1/2 INCHES. HAS 12 LINES OUT. ONLY \$39.95

**DELUXE 12-BUTTON TOUCHTONE ENCODER KIT** utilizing the new ICM 7206 chip. Provides both VISUAL AND AUDIO indications! Comes with its own two-tone anodized aluminum cabinet. Measures only 2 3/4 x 3 3/4". Complete with Touch-Tone pad, board, crystal, chip and all necessary components to finish the kit.

**PRICED AT.....\$29.95**

For those who wish to mount the encoder in a hand-held unit, the PC board measures only 9/16" x 1 3/4". This partial kit with PC board, crystal, chip and components.

**PRICED AT.....\$14.95**

**ACCUKEYER—MEMORY OPTION KIT** THIS ACCUKEYER MEMORY KIT PROVIDES A SIMPLE, LOW COST METHOD OF ADDING MEMORY CAPABILITY TO THE WB4VVF ACCUKEYER. WHILE DESIGNED FOR DIRECT ATTACHMENT TO THE ABOVE ACCUKEYER, IT CAN ALSO BE ATTACHED TO ANY STANDARD ACCUKEYER BOARD WITH LITTLE DIFFICULTY. \$16.95

**ACCUKEYER (KIT)** THIS ACCUKEYER IS A REVISED VERSION OF THE VERY POPULAR WB4VVF ACCUKEYER ORIGINALLY DESCRIBED BY JAMES GARRETT, IN QST MAGAZINE AND THE 1975 RADIO AMATEURS HANDBOOK. \$16.95

**ACCUKEYER—MEMORY OPTION KIT—TOGETHER ONLY \$32.00**

#### 6-DIGIT CLOCK • 12/24 HOUR

COMPLETE KIT CONSISTING OF 2 PC G10 PRE-DRILLED PC BOARDS, 1 CLOCK CHIP, 6 FND 359 READOUTS, 13 TRANSISTORS, 3 CAPS, 9 RESISTORS, 5 DIODES, 3 PUSH-BUTTON SWITCHES, POWER TRANSFORMER AND INSTRUCTIONS.

DON'T BE FOOLED BY PARTIAL KITS WHERE YOU HAVE TO BUY EVERYTHING EXTRA.

**PRICED AT.....\$12.95**

**CLOCK CASE** Available and will fit any one of the above clocks. Regular Price ... \$6.50 **But Only \$4.50 when bought with clock**

**SIX-DIGIT ALARM CLOCK KIT** for home, camper, RV, or field-day use. Operates on 12-volt AC or DC, and has its own 60-Hz time base on the board. Complete with all electronic components and two-piece, pre-drilled PC boards. Board size 4" x 3". Complete with speaker and switches. If operated on DC, there is nothing more to buy.

**PRICED AT.....\$16.95**

Twelve-volt AC line cord for those who wish to operate the clock from 110-volt AC. \$2.95

#### SHIPPING INFORMATION

ORDERS OVER \$15.00 WILL BE SHIPPED POSTPAID EXCEPT ON ITEMS WHERE ADDITIONAL CHARGES ARE REQUESTED. ON ORDERS LESS THAN \$15.00 PLEASE INCLUDE ADDITIONAL \$1.00 FOR HANDLING AND MAILING CHARGES. SEND SASE FOR FREE FLYER.



"HAL" HAROLD C. NOWLAND  
W8ZXH

**HAL-TRONIX** ✓ H24

P. O. BOX 1101  
SOUTHGATE, MICH. 48195  
PHONE (313) 285-1782

# A Simple 2m/10m Crossband Repeater System

— work the world with an HT!

Bob Heil K9EID  
PO Box 26  
Marissa IL 62257

With the rules relaxation concerning the crossband repeater operation and the clearance of the Technician license holder to be retransmitted on an HF frequency (tnx to the OSCAR program), we have a terrific opportunity to use HF links on our two-meter repeater systems with not too much effort and one heck of a lot of fun. A whole new world can be opened up to those

who really haven't gotten a taste of the HF bands as well as those of us who are out just to experiment and enjoy all the benefits from such a hookup.

## MARC Does It!

The Marissa Amateur Radio Club, Inc., in southwestern Illinois, has a three-site, two-meter repeater which has three receivers, a quarter-kW transmitter, 50 voice-ID tapes, a time machine, and an open autopatch and gives a good 100-mile coverage on two meters with rubber duckies! The idea was generated when I listened to Carlos TI2CF with his ten-meter

auxiliary link. The interface to do this with WD9GOE/RPT was begun. A Pace 1000M CB SSB rig was converted to 10 meters with the American Crystal Company kit. This worked out fine and gave us a good little 15-Watt rig tied to a TA 33 antenna. Next, we needed to build a COR (carrier operated relay) that would be activated by the Pace squelch, to key the two-meter transmitter. At the same time, a spare keying line had to be pulled off the two-meter repeater COR so that when the two-meter signal was received, it would key up both the two-meter repeater transmitter

and the ten-meter transmitter. Simple. Really! (See Fig. 1.)

## Not a Ten-Meter Repeater

One point that should be noticed is that this system is not a ten-meter repeater. That is to say that the ten-meter signals received are *not* retransmitted on another ten-meter frequency. The ten-meter signals are repeated *only* on two meters at the same time that the normal two-meter signals are repeated on two meters, so, in actuality, we have a simple ten-meter auxiliary link between two-meter and ten-meter receivers and transmitters.

## 220 Link

The MARC group had a special problem that may not be relevant to most systems. This section may not really apply to your group, therefore, but it will show that this system is capable of a lot more, should your group want to carry it out further. The main receiver site for the 81/21 system is located 5 miles southwest of Marissa on a 250' coal silo. The two-meter signals are relayed back to the 250-Watt transmitter, located in Marissa, over a 220-MHz link system using the Midland 13-509 equipment. The actual ten-meter link of WD9GOE/RPT is located at the home of K9EID. The

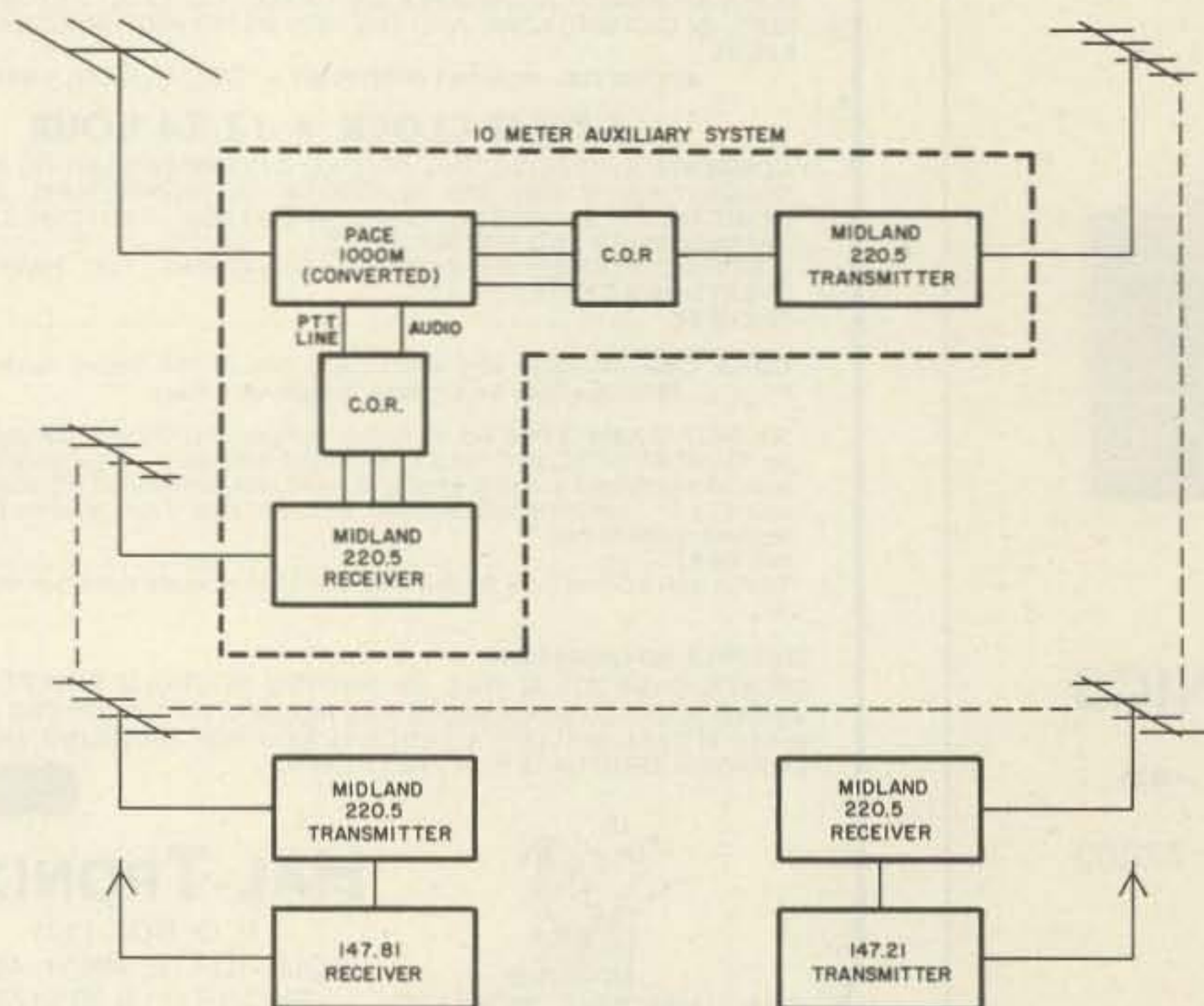

Fig. 1. Block diagram.

reason for this was two-fold. The ten-meter system should be at the transmitter site, not at the receiver site, due to desense, etc., and the MARC group felt that very close tabs should be kept on the ten-meter link so that it was not abused. A Midland 13-509 transceiver was taken apart for link use, therefore (a great piece of gear for this service!), and used ahead of and behind the Pace 1000M so that all signals would pass from ten to 220 then to the two-meter repeater, and reverse. It sounds complicated, but it was very easy to do. Follow the block diagram and you can see how simple it really is.

If your group has a repeater system using cavities and duplexing, you can skip all the 220-link activities and wire the Pace straight through (see Fig. 4). One thought about the 220 link is that it also gives WD9GOE/RPT a 220-MHz link that 220 operators can get in and out of just as the ten meter operators are able to do, so we really got a lot of mileage from doing the extra link thing. It is not unusual to dial up the Marissa system and hear a QSO going on: one station operating on 147.81/21, another on 220.5, while another can be 1000 miles away talking to both of them on 29.590! That's communication! What is interesting is that some club members have only a 220 rig, some have only ten-meter equipment, and some have only two-meter equipment. All three of these can communicate very readily with no problem, and should you listen on any of the three frequencies, 99% of the time you would not be able to tell who was operating where or what mode they were operating. One thing that is interesting is that the SSB signals from ten meters

come through the 220 and two-meter FM system, and you are hard-pressed to tell that that signal is not FM! Likewise on ten meters, it is impossible to detect that the SSB signal you are listening to is an actual FM signal except for one thing—the squelch tail! That sounds crazy on ten-meter SSB! (We recently modified the Motran receiver so that that blasted squelch tail is GONE!) The ten-meter link is no longer disturbed by the crashes!

### Audio Coupling

The audio coupling has been done passively. An active limiter could be used here, but it was decided to try the passive route just for simplicity; so far, it has worked without any inherent problems. You perhaps will have to make minor adjustments of values to achieve linear audio response between the two outputs. Care also was taken at the audio inputs of both transmitters so that rf would not enter and cause undue problems. Bypass these audio leads with very small, .001 capacitors and, of course, use good shielded wire throughout.

### COR Operation

The really good point about the Pace 1000M when used in this application is that it has a squelch circuit that works with the agc line and, therefore, will operate on SSB signals; this is something that most of the CB rigs will not do. Since the squelch does work on SSB signals, it makes it very simple to pull off a reference voltage, drive a simple COR, and use that to key up the two-meter transmitter. An interesting side effect of the Pace squelch is that since it does get activated via the agc line, a slight delay is noticed with the squelch, and that becomes our

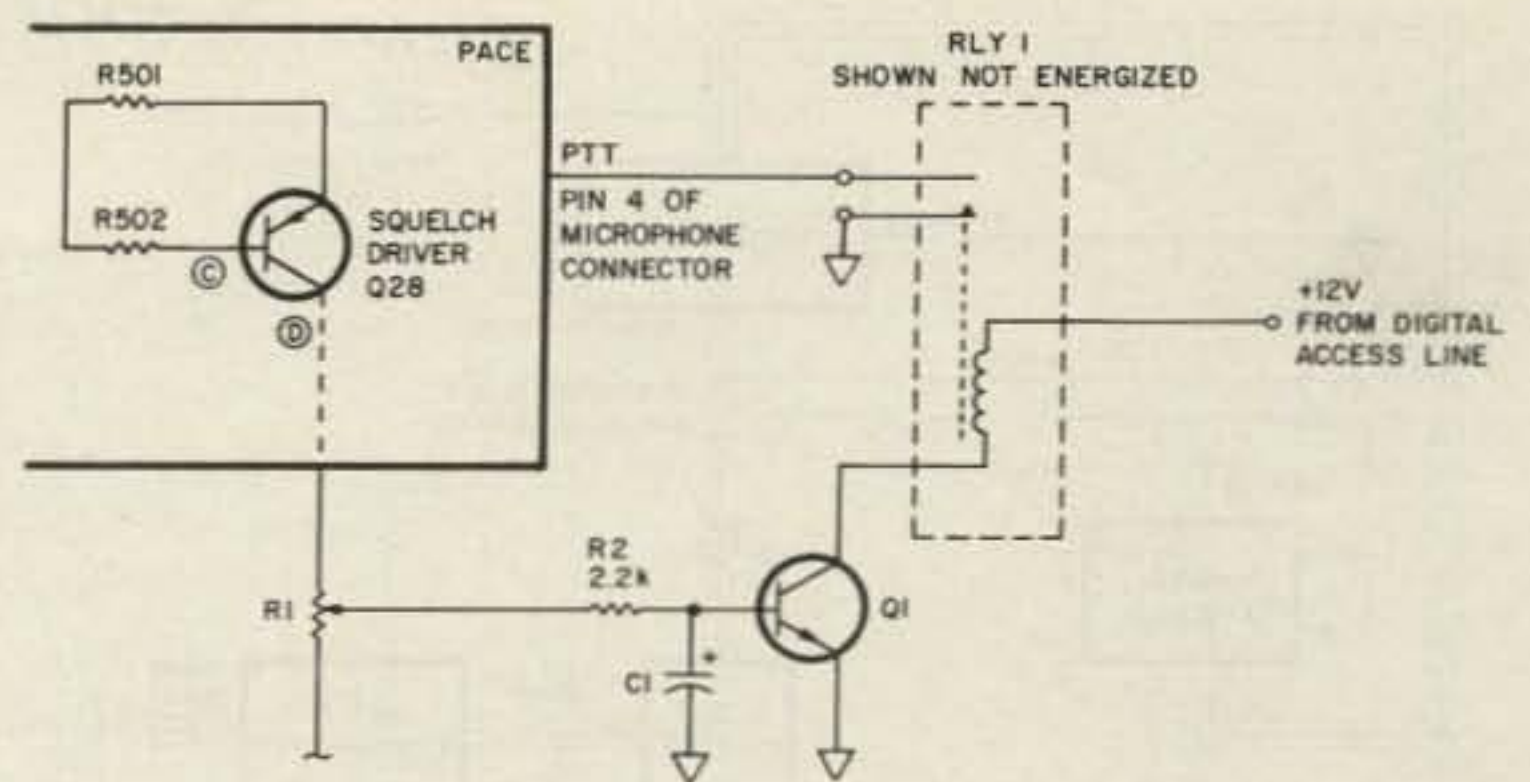

Fig. 2. COR for the ten-meter Pace.

2-second delay tail. It works well and was found to be adequate; delay circuits were not required to achieve the necessary hang time to allow things to switch over. (See Fig. 2.)

A worthwhile project for the two-meter repeater is a timer-reset beep. Without it, it is difficult for the two-meter operator to tell when the ten-meter signal dropped out (or turned the transmission over). With a reset timer "beep tone," the two-meter system is aware when the COR of the ten-meter receiver has been dropped. Because of the slight delay that the agc introduces, the timing is such that the COR does not drop out when the ten-meter SSB operator pauses for a breath between words. Pace certainly made things easy for us!

### Choose Your Mode

As you can see quite easily, you can select the frequency and mode the ten-meter link will operate on simply by adjusting the Pace to those requirements. The MARC group at Marissa has chosen USB on 29.590. After spending much time and effort in checking with groups such as the 10-10 club, etc., 590 seemed out of everyone's way and has worked out well. The unit has, on occasion, been used on ten-meter AM further up the band. It would be an easy task to remote this procedure should you desire. With the great increase of

CB conversion to ten-meter 29.6 FM, it might even work out for your group to use this mode if you have lots of ten-meter FM activity.

One of the interesting facets of the SSB mode is the absolute clarity when listening on two-meter FM. At first, one might ask, "How do you tune the ten-meter receiver?" The answer is that the repeater never is adjusted. It transceives (hopefully!) on the exact same frequency. The two-meter FM signals are patched to the Pace microphone input and are, of course, transmitted on ten-meter upper sideband. The ten-meter operator simply will tune in this USB signal as he normally would and, when it is his turn, merely transmits on the same frequency which the Pace receives and patches back through the two-meter FM transmitter. Easy.

### CB-to-Ten Conversion

The first thing that you will have to do is get the Pace, or similar rig, working where you want it on ten meters. MARC used the American Crystal (American Crystal Supply, PO Box 638, W. Yarmouth MA 02673) conversion, and it

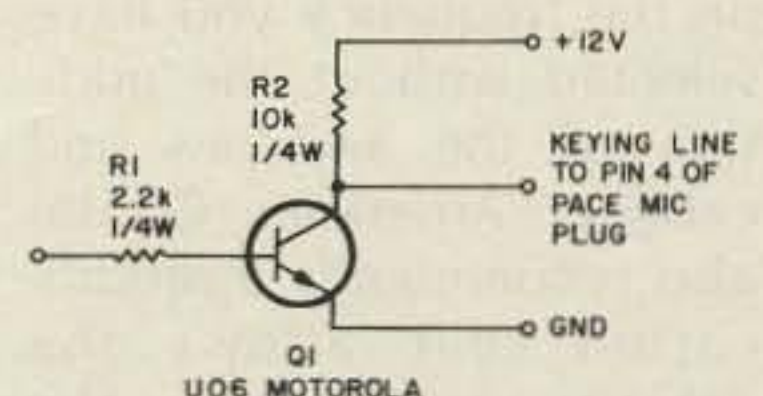

Fig. 3. Electronic keying.

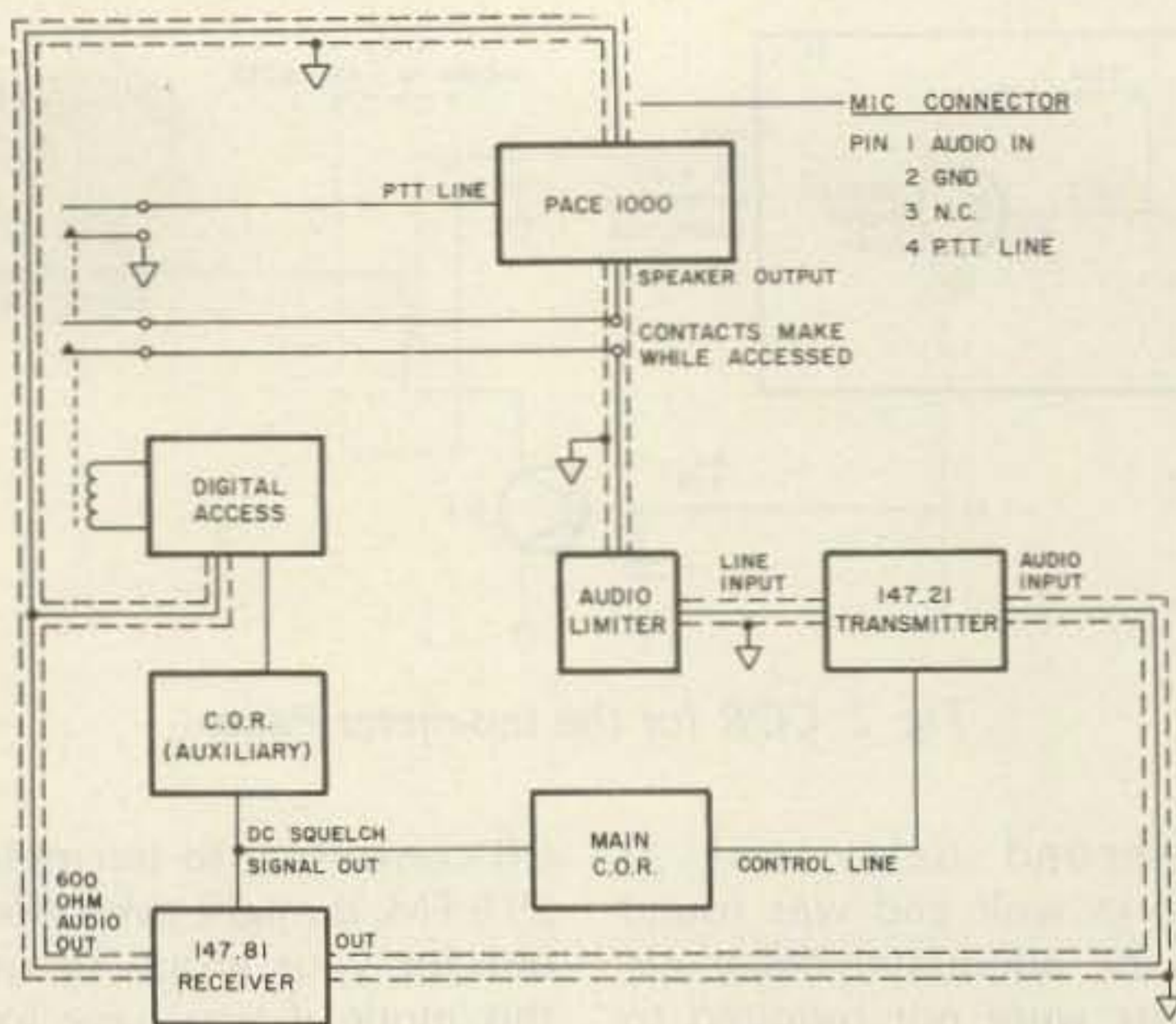

Fig. 4. Audio patching access control.

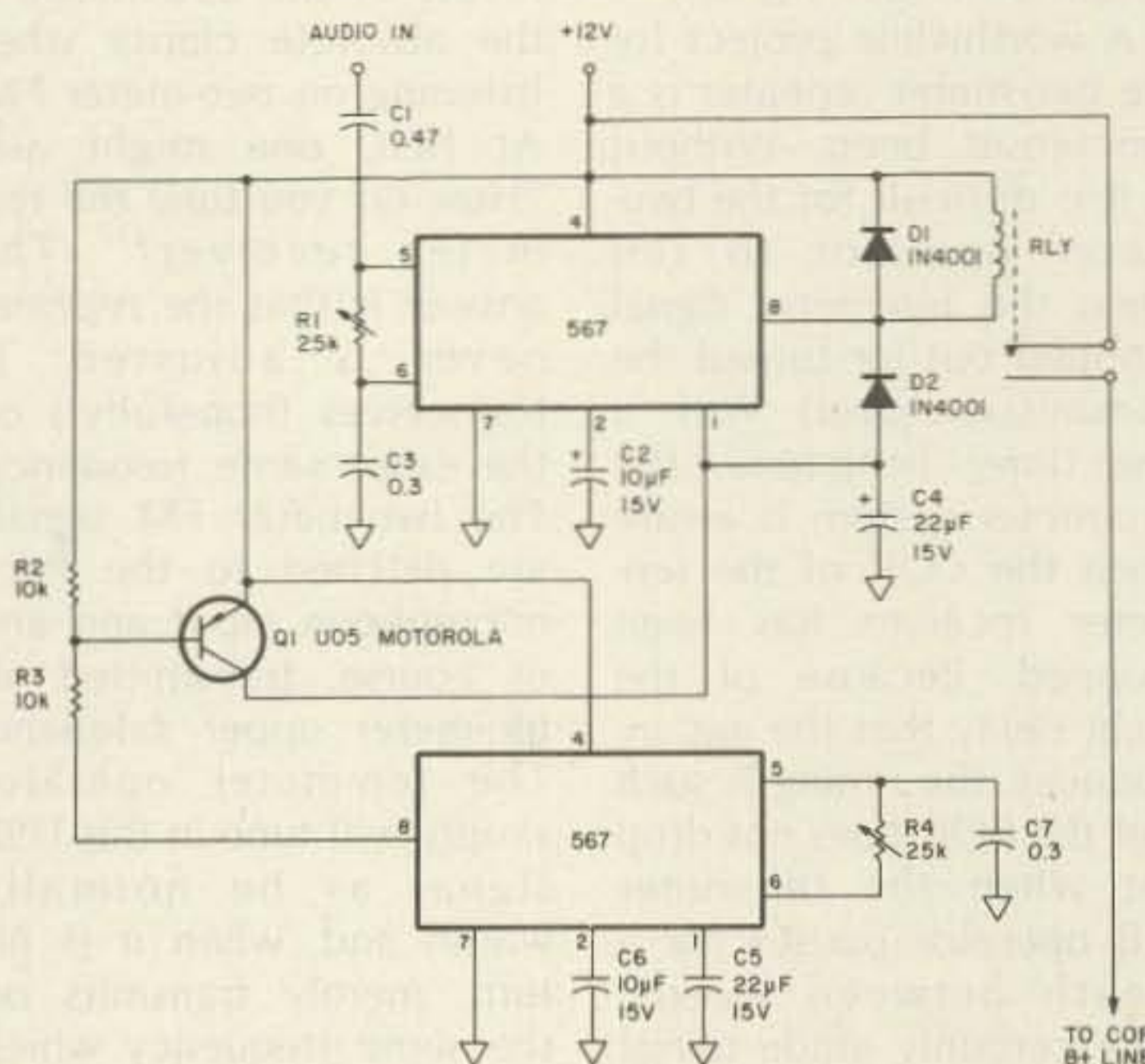

Fig. 5. Digital access.

took less than one hour to make the conversion and get the ten-meter rig on frequency.

A few modifications are available in the conversion kit that can be left out—mainly, the frequency expansion switches that allow a full one-megacycle coverage. By selecting the correct set of crystals in the kit, the Pace can be put on the frequency you have selected without the addition of the switches and cabling. American Crystal also recommends a modification that allows the "clarifier" to move the transmitter as well as the

receiver. As long as you check the two frequencies very carefully and do not plan to move the ten-meter frequency, this modification also can be left out.

The COR pick-off point is taken from Q28. Fig. 2 shows the very simple, but very effective, COR circuit used to key up the two-meter transmitter. Spare contacts on this relay can be used for various other applications which may suit your particular needs. This one connection is the *only* connection that has to be made inside the Pace. Everything else is done from the speaker jack and

microphone jack. Should you desire local audio from the Pace, you may want to install a switch (or wire the speaker jack permanently) to keep the speaker operational with a plug inserted into the speaker jack. Normally, the speaker wire is disconnected when a jack is plugged in. Since we will pull the ten-meter audio from this jack, you will not have any local speaker audio unless you make this change.

### Two-Meter COR

The Pace will need only a ground to transmit for the PTT circuit, which will be tapped off at the microphone front-panel plug. If you do not have any spare contacts on your two-meter COR, parallel another relay across the main COR and away you go. You also could use electronic switching here to save you the problems of installing a separate relay. Look over this auxiliary circuit in Fig. 3. Fig. 4 shows the actual audio patching in and out of the two-meter repeater. It is very important to use good shielded cable with proper rf bypassing to keep the audio lines free of any stray rf that may occur when installing the additional equipment.

### Access Equipment

Access to the ten-meter link can be accomplished in many ways. The simplest method is to use a telephone line with proper equipment to allow a control operator (or operators) to dial up the proper codes to complete the access link in the two COR circuits. (See Fig. 4.)

With digital circuitry today, it is very simple to come up with an easy access system for the ten-meter link. The only thing that the access equipment has to do is connect the 12-volt dc line to the COR

circuits. With the 12 volts removed, power can be left on the Pace continuously, and even though there may be signals received on the ten-meter frequency, the COR will not bring up the two-meter system, or vice versa. By allowing the access equipment to connect the 12 volts to the COR, the ten-meter link then becomes active. Fig. 5 will give you a simple digital access to the system. We really don't need to go into great detail here because almost all of the repeater systems have some kind of access control for other functions and it should be easy to tie in the ten-meter access to this existing logic.

The only problem that your group may encounter, should you use ten-meter access, is that there is no really good foolproof access through ten meters. The MARC ten-meter group feels that the *only* access should be on two meters; a great many problems are eliminated while a tighter control can be kept on the system.

### An Alternate Control System

Carlos TI2CF has an Icom 701 linked to a Spectrum two-meter repeater via a regular phone patch system, like the Data Signal RAP 200. This system controls the audio of the 701 just as it would the telephone line. To use this system, a member of the group accesses just as he would if it were a phone patch, only when this occurs, the ten-meter link will come up. When the two-meter station transmits, the patch circuitry keys the PTT line of the ten-meter transmitter. When the two-meter station listens, the ten-meter receiver audio is patched to the two-meter transmitter. The only problem with this system is that the two-meter transmitter would be keyed up con-

stantly (as it would when any patch logic is accessed). Should someone access the ten-meter link and *not* bring it down, the two-meter repeater stays on until someone brings it down. This system does allow the two-meter operator to switch the ten-meter link audio by simply pushing his or her mic PTT button. The ten-meter station received would not control any relays or controls. The system would work just like a phone patch but, of course, without the phone lines and actually substituting a ten-meter (or 20-, or 40-meter!) transceiver for the phone lines.

This system has some advantages but also needs additional equipment that groups may not have, nor could round up the finances to obtain. It also has some disadvantages for control, so your group

will have to select the method that best suits its needs.

The Marissa system at WD9GOE/R has been in use since March, and many excellent contacts have been made by many members of the group as well as by dozens of interested newcomers that the system has attracted. It becomes very exciting to work Venezuela from southern Illinois on a Tempo S-1 HT with the rubber ducky! It is also very exciting to foreign stations when they discover what they are working! The system has brought the entire St. Louis area to its feet, and, again, attention to amateur radio is gained through simple technology, some imagination, and a few hours of hard work. This is only the beginning. Let's all get to work and see where we can go from here. It's all for amateur radio! ■

# NOTE TO 73 Subscribers

From time to time 73 Magazine makes its subscriber lists available to carefully-screened companies and organizations whose products, services or information may be of interest to you. In every case, we must approve all organizations wishing to mail to our subscribers. In every case they receive a list of names and addresses only—no other information we may have is divulged. Each organization may use the list only once and agrees never to make any personal or telephone solicitations from it.

The overwhelming majority of our subscribers appreciate this controlled use of our mailing lists—it helps them shop conveniently by mail for products and services they need, often at substantial savings. A few people prefer their names not be used. It is to them we address this message.

If you do *not* wish to be a part of this service, please complete the form below... your name will not be used in this manner for any reason.

(If you asked us in the past to remove your name from our lists, there is no need to repeat the request.) Please allow about six weeks for your request to take effect.

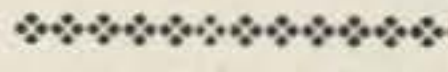

I wish to have my name removed from the list of subscribers receiving mail other than the regular subscription to 73 Magazine.

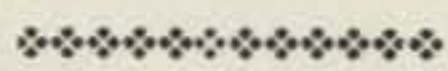

Mr. \_\_\_\_\_  
Mrs. \_\_\_\_\_  
Ms. \_\_\_\_\_  
Please Print

Address \_\_\_\_\_  
City \_\_\_\_\_ State \_\_\_\_\_ Zip \_\_\_\_\_

Mail this form with your mailing label from the latest issue (or fill out the information as it appears on the label) to:

**73 Magazine**  
**Subscription Services Dept.**  
**P.O. Box 931**  
**Farmingdale NY 11737**

## NEW MFJ-624 Deluxe Hybrid Phone Patch

**Feature Packed: VU meter for line level and null. Has receiver gain, transmitter gain, null controls, bypass switch. Beautiful hum-free audio. RF filtered. VOX or push-to-talk. Works with any rig. Simple patch-in-patch-out installation.**



***Crisp, clear hum-free audio is what phone patching is all about and MFJ has it.***

✓ M52

**\$59<sup>95</sup>**



This new MFJ-624 Telepatch II hybrid phone patch gives you a combination of performance, features, and quality that you won't find in other phone patches.

**PERFORMANCE:** Gives you crisp clear, hum-free audio which is what phone patching is all about. Use automatic VOX or push-to-talk. RF pi-filters and PC board construction eliminates RF feedback. Works with any rig.

**FEATURES:** VU meter monitors telephone line level to prevent crosstalk between telephone channels. Also lets you adjust null depth for maximum isolation between receiver and transmitter.

Separate transmitter and receiver gain controls eliminate readjusting rig's controls after patching. Null control for maximum isolation.

**Function switch:** OFF for normal operation. ON connects your rig to phone line for patching. NULL switches VU meter to let you adjust for maximum null.

**Simple 2 cable installation** (plus phone line) when rig has patch-in-patch-out jacks. Connects easily to any rig.

**Phono jacks** for patch-in-patch-out, speaker, microphone. Screw terminals for phone lines.

**Eggshell white, walnut sides.** 8x2x6 inches.

**QUALITY:** Every single unit is tested for performance and inspected for quality. Solid American construction, quality components.

**MFJ-620 TELEPATCH HYBRID PHONE PATCH.** Same as MFJ-624 but less VU meter. 6x2x6

inches. \$49.95 plus \$3.00 shipping and handling.

**One year unconditional guarantee.** Order from MFJ and try it — no obligation. If not delighted, return it within 30 days for refund (less shipping).

**Order today.** Call toll free 800-647-1800. Charge VISA, MC or mail check, money order for \$59.95 plus \$3.00 shipping for MFJ-624 and \$49.95 plus \$3.00 shipping for MFJ-620.

**CALL TOLL FREE ... 800-647-1800**

For technical information, order/repair status, in Miss., outside continental USA, call 601-323-5869.

**MFJ ENTERPRISES, INC.**  
BOX 494, MISSISSIPPI STATE, MS 39762





# INEXPENSIVELY SUPERIOR

## The DS2000 KSR is the lowest priced RTTY terminal available with these advanced features:

- TX/RX operation on Baudot and ASCII RTTY plus Morse Code (Morse RX optional)
- Integrated keyboard and video generator allows editing of transmit text
- Full 24 line by 72 characters per line display
- Bright/dim display of characters differentiates between TX and RX display
- Morse receive option may be added at any time
- Separate CW identification key for RTTY operation
- Status line on top of screen shows terminal operating conditions
- Pretype transmit message into 255 character buffer; edit before transmitting
- 2 programmable "Here Is" messages
- Word-wrap-around prevents word splitting at end of display line
- Word mode allows editing of text to be transmitted
- Quick Brown Fox and RYRY test message keys
- Small size metal cabinet gives effective RFI shielding from transmitters
- Loop compatible RTTY connections and plus or minus CW key connections
- 110 and 300 baud ASCII
- 45,50,57,74,100 baud Baudot
- 1-175 wpm Morse transmit
- 1-175 wpm optional Morse receive
- 120/240 v, 50/60 Hz power
- Internal CW side-tone
- UnShift On Space for Baudot
- Keyboard Operated Switch
- SYNC idle for RTTY
- One year warranty

*Write or give us a call. We'll be glad to send you our new RTTY catalog.*



**HAL COMMUNICATIONS CORP.**  
 Box 365  
 Urbana, Illinois 61801  
 217-367-7373

For our European Customers Contact:  
 Richter & Co., D3000 Hannover 1  
 I.E.C. Interelco, 6816 Bissone/Lugano

DS2000 KSR.....	\$449.00
ESM-914 Video Monitor...	\$150.00
MR2000	
Morse receive option....	\$149.00

# UNSURPASSED RTTY

No other RTTY terminal made gives you ALL the features of our new DS3100 ASR:



- TX/RX operation with 3 codes: Baudot RTTY, Morse Code, ASCII RTTY
- Storage buffers for 150 lines of RX storage and 50 lines of TX storage
- The HAL "original" split screen shows both RX and TX buffers or whole screen for RX
- Ten programmable "Here Is" messages can be chained from one to next
- The EAROM allows power-off storage of 2 "Here Is" messages and terminal operating conditions
- Programmable WRU answer-back and selective-call features
- Separate CW identification key for RTTY operations
- Automatic TX/RX control with KOS plus 4 keyboard controlled accessory switches
- Internal real time clock keeps 24 hour time plus date
- Newly developed CW receive circuitry and programs give superior CW reception
- New green, P31 phosphor display screen gives clear, eye-easing viewing
- On-screen status indicators give continuous display of terminal operating conditions
- Word-Wrap-Around prevents splitting of words at end of display line
- Continuous, line, and word modes offer flexibility in editing transmit text
- Attractive streamlined metal cabinet gives effective RFI shielding from transmitters

*Here Are More DS3100 ASR Specifications that Give You State-of-the-Art RTTY Operation:*

QBF and RY test messages ■ Loop and RS 232 RTTY I/O ■ Plus or minus CW key output ■ 25 pin EIA modem connector ■ Half or full duplex ■ Upper-lower case ASCII ■ All ASCII control codes ■ Optional line printer for all codes ■ Selectable ASCII parity ■ 110 to 9600 baud ASCII ■ 45 to 100 baud Baudot ■ 1 to 175 WPM Morse receive and transmit ■ UnShift on space for Baudot ■ SYNC idle for RTTY and Morse ■ Break key for RTTY ■ Tune key for Morse ■ Automatic CR-LF ■ 120/240 v, 50/60 Hz power ■ Custom labeled key tops show control operation ■ Copy receive text into transmit buffer ■ TX flags allow segmenting of TX buffer ■ One year warranty

**PRICE: \$1995.00**



**HAL COMMUNICATIONS CORP.**  
Box 365  
Urbana, Illinois 61801  
217-367-7373

For our European Customers Contact:  
Richter & Co., D3000 Hannover 1  
I.E.C. Intereico, 6816 Bissone/Lugano

*Write or give us a call.  
We'll be glad to send you our  
new RTTY catalog.*

# Audio Booster for Mil-Surplus Receivers

— a must for headphone haters

One of my biggest pet peeves with military surplus radio equipment is the low audio output of some sets. And that is the

one big problem with the R-648/ARR-41 radio receiver that I converted recently. (See "Another Surplus Treasure," *73 Magazine*,

November, 1978.) This receiver worked fine with headphones, but not when the output transformer was changed for a speaker. If you have done much work at all with surplus radio equipment, you know what

I am talking about!

After studying the schematic of the audio stages, I saw that the best route would be to change the 5686 output tube to something heftier—like a 6AQ5. You could do it but for one



Photo A. Plug-in audio amp with rig.

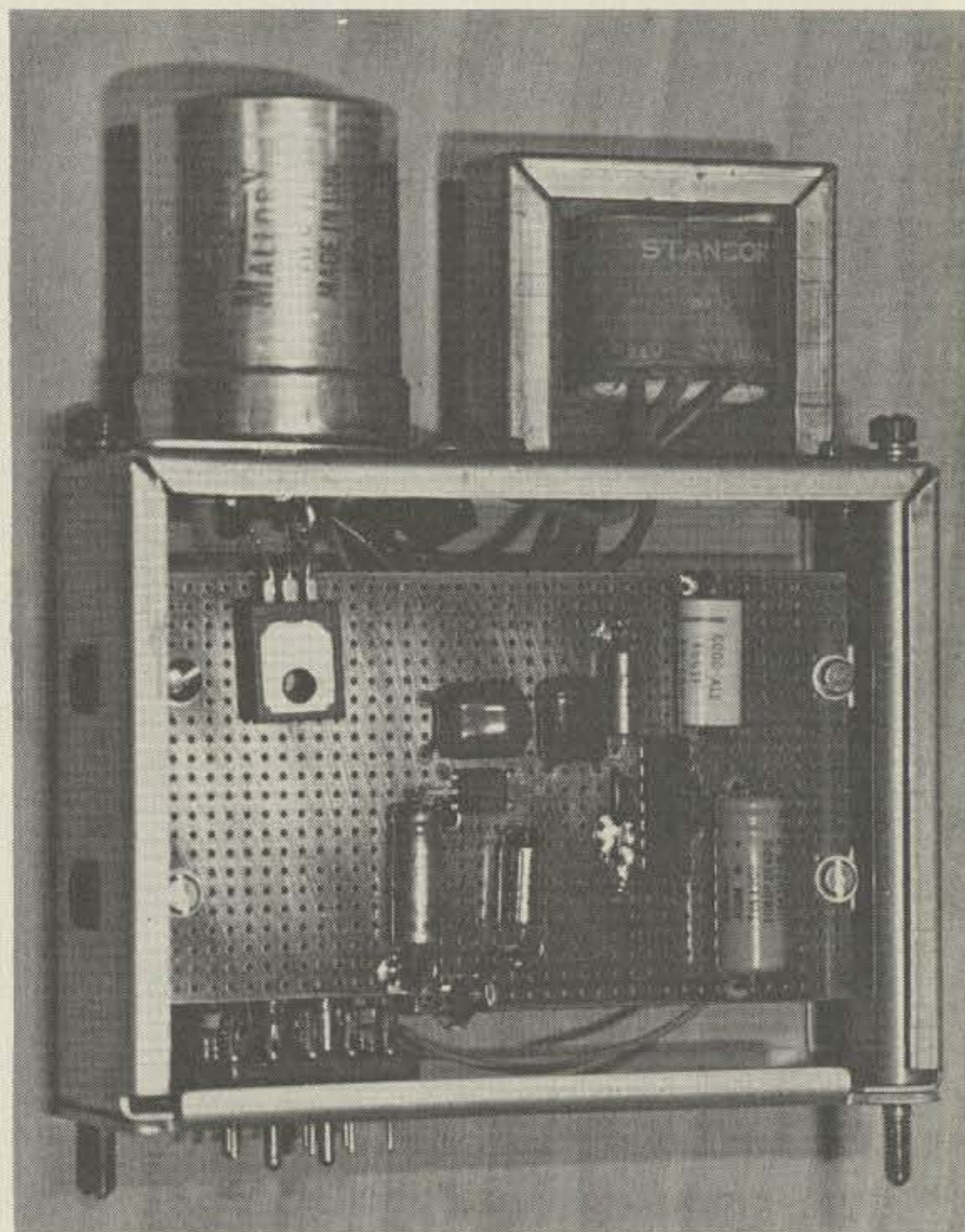

Photo B. Interior view of amplifier.



thing: Mounting the tube could create a height problem with the case. Also, you would upset the filament string in this series string set. So that was out.

The next best thing turned out to be a whole new audio amplifier, built from the ground up. This turned out to be a fairly easy job; an IC "building block" amplifier was pressed into service. It was possible to mount all parts in the module case, too, and the whole thing makes up a neat plug-in package. Oh yes, there is plenty of volume with a speaker now!

If you are working with other surplus sets and need an audio boost, this amplifier may do it for you. It is cheap to build, takes little room, produces little heat and creates a heck of a lot of volume. You are welcome to try it in your own unit; in this article, however, I will concentrate on the R-648 receiver conversion.

Before getting started with the actual wiring, let's take a look at what is being modified in the R-648. If you check out Fig. 1, you will see a simplified diagram of the receiver's audio section. Basically, you have two stages of gain (5814) and a stage of power (5686). The 5686 tube is the bottleneck here. The tube just won't draw enough plate current for any real power output, and is a poor choice for an audio output, especially since it sits there and draws 300 mA at 6.3 volts. It's a better heater-dropping resistor than output tube!

Note particularly the cathode connection of the first audio stage. Resistor R1305 is in series with the tube cathode and a pot on the front panel. This is the volume control. It is unique in that no audio signals pass down it, pre-

venting hum pickup, yet making shielded cable from the volume control unnecessary. This is called a "dc volume control" and is used widely in IC-generation TV sets today. It is important to us because we are going to use it in our modification.

The schematic shows what goes in place of the two tubes: two low-cost ICs. One IC you are probably familiar with—the National LM-380. This is the 2½-Watt power amplifier job. It is a natural for this job. The other one is a little less known, and that's too bad, because it is very useful. This IC is the Motorola MFC-6040 or Motorola HEPC6009. It is an electronic attenuator. It attenuates a signal when

either a resistor to ground or voltage is applied to a control pin. There is no gain added, just attenuation. A simple 12-volt power supply rounds out the modification.

Construction is easy. I would suggest, however, that if your R-648 still has the tube filaments wired for 24 volts, leave the tube filaments in the audio module wired up. This will make sure that the other tubes get the proper voltages. One good advantage, besides the fact you eliminate several power resistors, is that the tubes can be bad. Just the filaments have to be good.

The photos and the schematic tell the construction story pretty well. I must

add that I rewired the filaments in my receiver for 6.3 volts, so I was able to mount all parts in the schematic on the original module. This made a neat package. If you leave in the tubes, as required for the old 24-volt filament string, you will have to mount the power transformer elsewhere. I might add, at this point, that I tried a half-wave rectifier and filter directly from the 24-volt filament supply, but I had to supply a huge amount of filtering, and I had to drop the voltage to IC3 (voltage regulator) because it exceeded the chip's ratings. In the long run, a separate transformer for the audio amp power supply takes up less space, reduces construction frus-

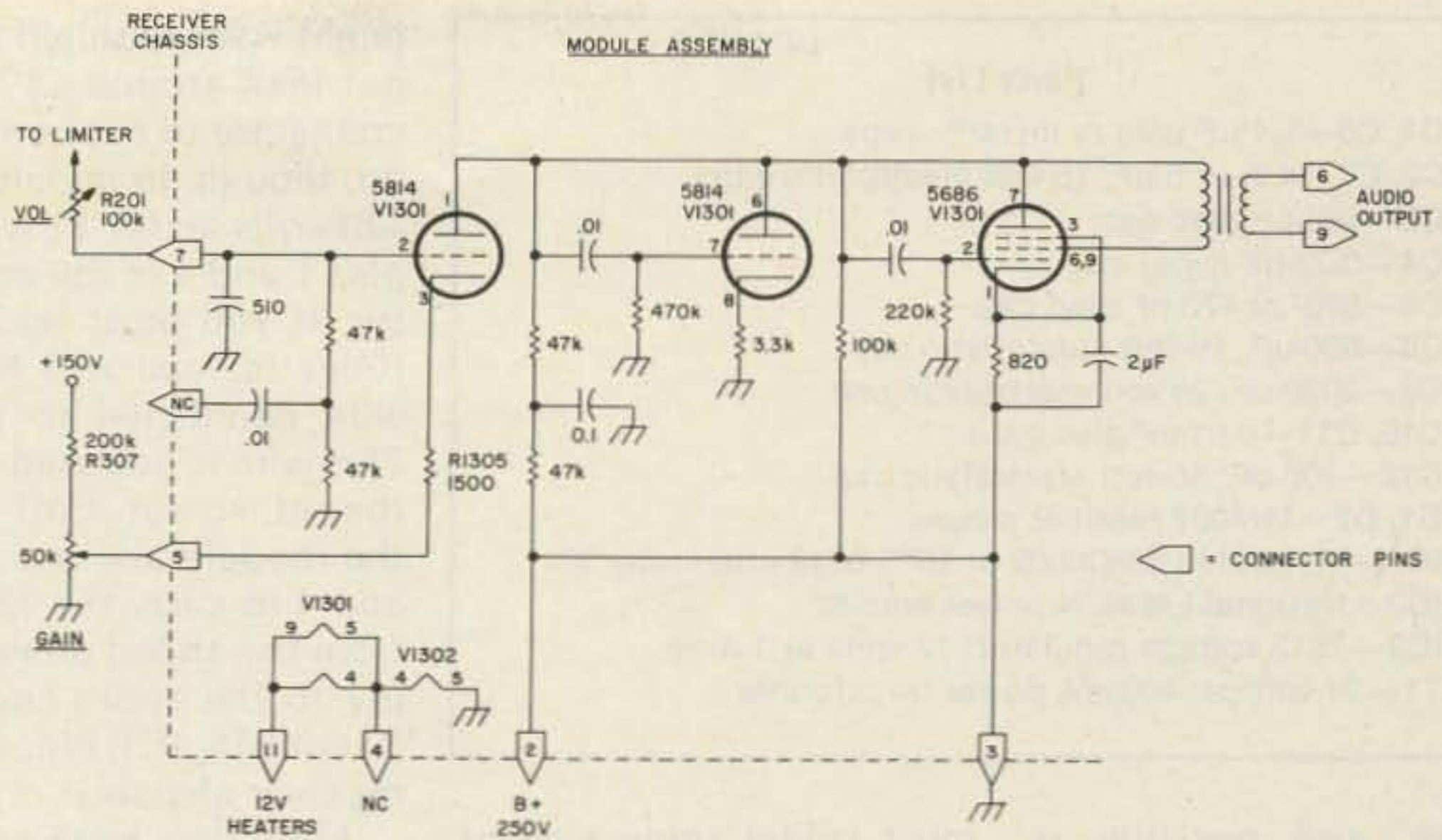

Fig. 1. Existing audio section of R-648.

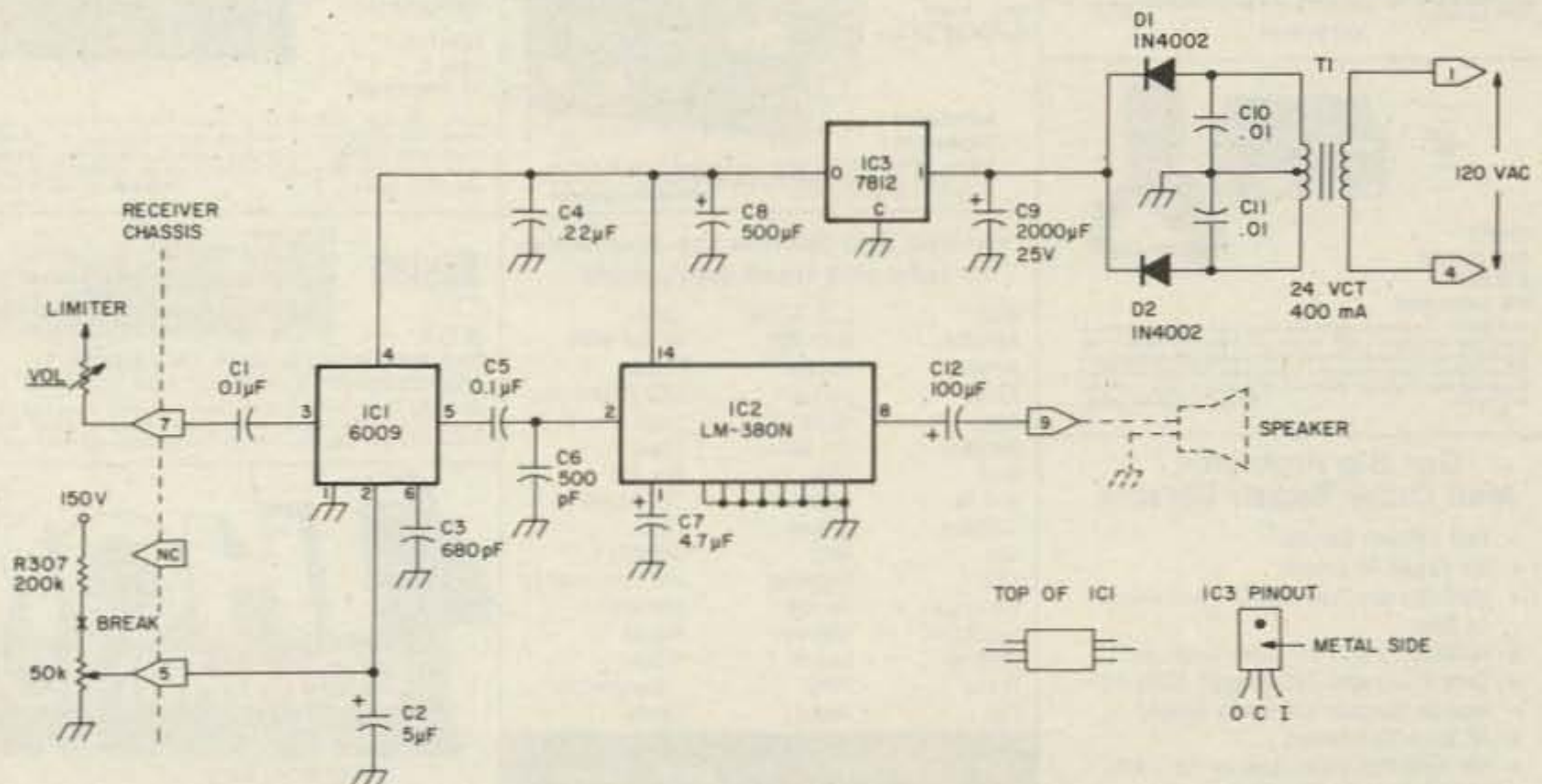

Fig. 2. Schematic diagram.

### Parts List

- C1, C5—0.1-uF disc or mylar® caps
- C2, C7—4.7- or 5-uF, 16-volt electrolytic caps
- C3—680-pF disc cap
- C4—0.22-uF mylar cap
- C6—500- or 470-pF disc cap
- C8—500-uF, 16-volt electrolytic cap
- C9—2000-uF, 25-volt electrolytic cap
- C10, C11—0.01-uF disc caps
- C12—100-uF, 16-volt electrolytic cap
- D1, D2—1N4002 rectifier diodes
- IC1—Motorola HEPC6009 or MFC-6040 attenuator IC
- IC2—National LM380N power amp IC
- IC3—7812 voltage regulator; 12 volts at 1 Amp
- T1—24 volt c-t, 400-mA power transformer

tration, and possibly is cheaper.

I started construction by removing all components from the audio module, save the connector. Inside, I mounted a piece of copperclad "ground plane" perfboard, which serves as shielding and a heat sink for IC2. You don't have to duplicate this method of construction—copperclad perfboard is rather expensive—but at the least you

must solder some kind of heat sink to the *grounded* leads of IC2. Two pieces of shim brass cut to size will do fine.

IC3 does not have to be heat-sinked, as its power dissipation is very low. You can see this IC in my unit mounted upside down under the filter capacitor.

The rest of the construction is noncritical and needs little comment. You

might want to shield the input lead around C1 to the connector to cut hum pick-up, though. In my unit, the 120 volts ac for T1 went to pins 1 and 4 of the connector. If you must leave the tubes in, you will have a wire connected to pin 4. This wire is not used inside the set, so cut it off inside the module and use pins 1 and 4 to carry the 12 volts from the added power supply to the audio circuitry. (Mount T1, IC3, etc., on the receiver chassis.)

After you have rewired the module, you will have to make a few additions on the main chassis. In my case, I ran 120 volts ac to pins 1 and 4 of the audio module chassis socket. If you kept the tubes in as ballast resistors, you will have to build the 12-volt power supply externally, and feed in the regulated voltage through the proper pins. After that is done, you must make one more

change. Resistor R307 on the front panel must be disconnected or the attenuator IC will receive B+ through the gain control. This should be very easy. Unlatch the front panel and look at the rear section of the gain control. In my receiver, there was a yellow wire tied to the CW or far left-hand lug on the control. I cut it and I was home free.

After these modifications were complete, the receiver worked fine, and with room-filling volume! I haven't tried this modification on other surplus sets, but it should work if the proper power-supply voltages are available. And, oh yes! This conversion has other benefits, too. Besides a dramatic increase in volume, and less heat, the dc volume control can be switched and used as part of a squelch or noise blanker scheme. Or, how about a Selcal system? ■

**THOMAS LOVES YAESU SPECIALS!**

**YAESU FT-207R**  
144 148 MHz FM Synthesized Hand-Held. Four memories plus offset, Auto Scan, Keyboard entry, 3 watts output, automatic battery saver, LED Display, BNC Antenna Connector, condenser mike, and MUCH MORE!  
List \$399 • Call for Quote!



**YAESU FT-101ZD High performance HF Transceiver**  
Covers 160 thru 10 meters plus WWV, modes: LSB, USB, and CW, built-in power supply, input power: 180 WDC, digital and analog frequency readout, 6146 final tubes, RF speech processor, variable IF bandwidth (300 Hz to 2.4 KHz), noise blanker, VOX, attenuator 10 dB or 20 dB, 100-234V operation, TX/RX freq. offset.  
\$585 list. Call for Quote



**YAESU CPU 2500RK 2 Meter FM Transceiver**  
With 800 PLL channels, automatic scan over entire 2m band, 4 memories, toneburst, 25W HiQSW Lo., 13.8 VDC at 8A continuous. Freq. coverage: 144-148 MHz. Comes with a key-board mic that allows remote input of memory or dial freqs., up/down scanning, aux. repeater selection to 4 MHz, 2 tone input for autopatch.  
\$585.00 list. Call for quote.



**Got Big Problems? Mail Order Repair Service**

- Fast Efficient Service
- We Repair All Brands
- Most Repairs Done and Shipped Within 14 Days
- Amateur Extra/First Class Licenses
- Send Equipment UPS Prepaid Shipping
- Include Manuals and Power Supply
- All Work Guaranteed
- Our Fine Reputation Speaks For Itself
- ALSO . . . Warranty Work On All Major Brands.

**THOMAS LOVES DENTRON SPECIALS! Dentron**

**MT-2000 3KW Antenna Tuner 1.8 — 30 MHz SUPER DEAL**  
Closeout Price \$155 . . . Reg. \$199



**Dentron GLA-1000 LINEAR AMPLIFIER**  
Freq. 80 to 15 meters, covers most Mars frequencies, RF drive: max. 125, power consumption: 117 VAC 50/60 Hz 12.5 Amps, factory fused at 15 Amps, 234 VAC 50/60 Hz 7 Amps, DC input: 1 KW CW and 1200W PEP SSB. Final tubes: 4 D-50A tubes (6L06).  
\$379.50 Call for Quote



**DENTRON Clipperton L**  
160 thru 15 meters, 200 watts PEP on SSB, 1000 watts CW on CW, RTTY, or SSTV, covers most MARS frequencies just outside Ham bands, and easily changed 117V or 234V AC 50-60 Hz.  
\$599.00 Call for Quote.



**We Sell and Service the Following New and Used Equipment**

Aida	ETO Alpha	Rohn
Alliance	Ham Key	Saxton Wire
Ameco	Hustler	Shure
ARRL	Hy-Gain	SST Electronics
Atlas	ICOM	Swan
Bencher	JW Miller	Telex
Bird	KDK	Ten Tec
B & W	KLM	TET Antennas
Callbook	Larsen	Trac
CDE	MFJ	Unadilla
CES	Microlog	VHF Engineering
Covercraft	Mirage	Vibroplex
Cushcraft	Mosley	Wilson
Dentron	Murch	Wilson
Drake	PIPO	Commercial
DSI	Robot	Yaesu

**GET A SUPER DEAL AND GREAT SERVICE CALL (203) 667-0811**

**SPECIALS! ICOM**

**ICOM IC-701 All Mode HF Transceiver**  
All solid state, 100W continuous duty on all bands, all modes, 160 thru 10 meters, dual built-in digital VFO's for split freq. operation, VOX, semi-break-in CW, RT, AGC, noise blanker and built-in speech processor. IC-701PS needed for AC operation. Power supply requirements: DC 13.6V negative ground.  
\$1,332 LIST—Call for quote!



**DRAKE TR7/DR7 Solid State synthesized HF transceiver**  
Covers 160 thru 10 meters, reception from 1.5-30 continuous, 6-30 MHz with optional AUX-7, modes: USB, LSB, CW, RTTY, AM. True passband tuning, RT, built-in RF wattmeter/SWR bridge, SSB 250 watts PEP, CW 250 watts, AM 80 watts. Power supply required for AC operation: PS-7 120/240V power supply available.  
\$1395.00 List. Call for quote.



**TEN-TEC Omni D HF Transceiver**  
Totally solid state, 200W all bands. Covers 160 thru 10 meters: digital readout, built-in VOX and PTI, adjustable squelch, 4 position CW/SSB filter, 8 pole crystal SSB filter, 2 range offset tuning, crystal calibrator, zero beat switch, SWR bridge and more. 12 VDC for mobile use, external power supply needed for fixed use.  
\$1069.00 List. Call for quote.



**KDK THE NEW KDK FM2016A TWO METER TRANSCEIVER (AT \$299) IS FOR YOU!**  
1000 channels, Built-in Mars, cap frequency coverage, big bright 3/8" LED digital readout display, 4 channel Ram memory, any offset, any split, 16 Watts output and much more.



**\* CHECK THESE PRICES \* ALLIANCE**

- HD-73 Heavy duty rotor . . . \$119.95

**ATLAS**

- TX-110H Transmitter . . . \$199
- TX-110L Transmitter . . . \$129
- RX-110 Receiver . . . \$199
- RX-110S Receiver . . . \$209

**TEN TEC**

- KR-20A Keyer/Paddle . . . \$55

**CDE**

- CDE-44 Rotor . . . \$95

**DENTRON**

- Big Dummy-1kw . . . \$27.50

**KDK**

- AWE-800UP Scan Converter . . . \$88
- CES 800KK Scan Converter . . . \$88
- CES 800YS Scan Converter . . . \$88

**KLM**

- 15-160BL 2M Amplifier (15 watts in, 160 watts out) linear . . . \$229

**TELEX**

- HTC-2 Twin Lightweight Headphones \$23
- SWL-610 Earphones, 2000 ohms . . \$11.50

**SWAN**

- FS-1 Field Strength Meter . . . \$15.50
- FS-2 Field Strength Meter . . . \$16.50
- SWR-3 SWR Meter . . . \$15.50

**YAESU**

- FV-901 VFO . . . \$339
- SP-101 Speaker . . . \$22
- FT-101DC Converter . . . \$42
- YC-601B Digital Display . . . \$185
- YC-500S Frequency Counter . . . \$265
- FT-101 Speech Processor . . . \$62
- YC-221 Digital Display . . . \$99
- YC-150 Dummyload/Wattmeter . . \$75
- YC-500J Freq. Counter . . . \$195
- YO-101 Monitor Scope . . . \$259

**THOMAS COMMUNICATIONS**

95 KITTS LANE • NEWINGTON, Connecticut 06111  
OPEN: 10:00-5:30 MON.-FRI. • THURS. til 8:00 p.m. • SAT. 10:00-4:00  
Easy Directions: Rt. 15 South • 2 Blocks Past MacDonalds (Berlin Tpke.)

master charge  
VISA  
COD

✓ T34

# RTTY Demodulator

# Computer RTTY

NO COMPROMISE PERFORMANCE

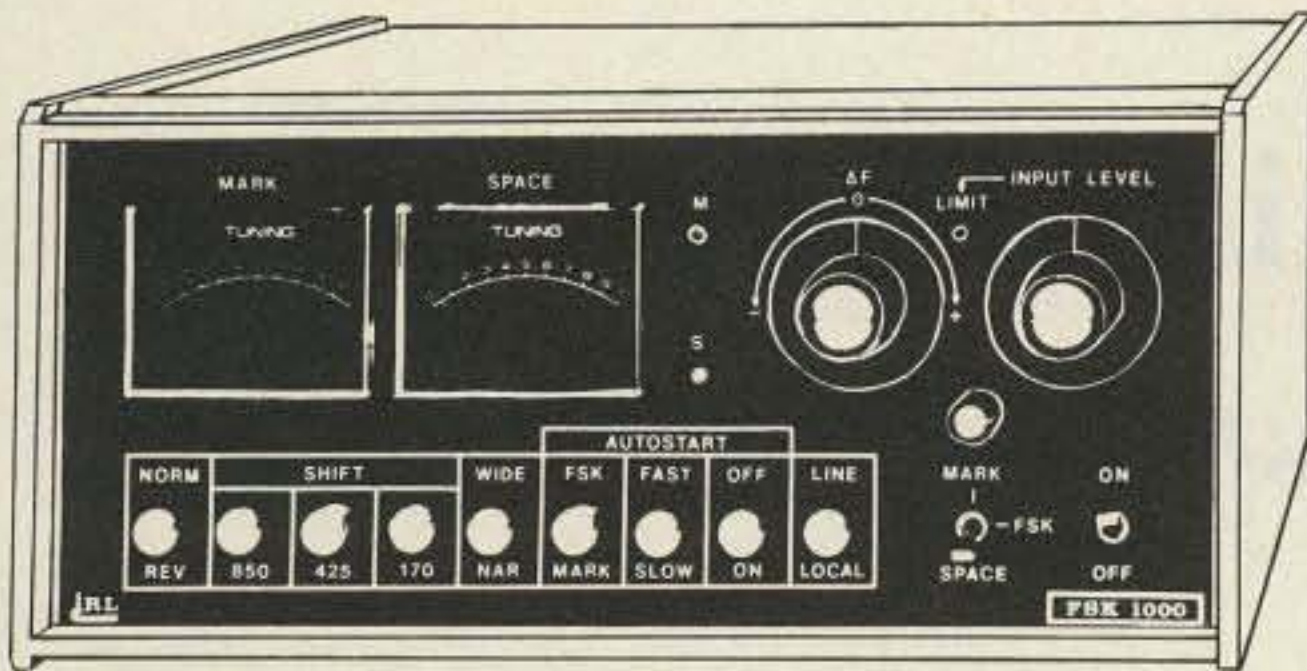

## FSK-1000™

iRL has built the FSK-1000 to combine the rugged, high quality construction of yesterday with the technology of tomorrow to offer you the finest RTTY demodulator today. Below are the features that mean real American made value in a unit built and ready to operate when you receive it.

48 op amps with all IC's in sockets

Fights QRM with panel selectable 55 or 100 Hz active filters in each tone channel

Two tone, limiterless operation, or Full limiter operation with

Positive indication of limiting on panel

Decision level correction circuits to reduce effects of selective fading

Dual meters to tune mark and space

Adjustable 20 to 60 Ma high voltage loop

Continuously tunable shift from 100 to 1000 Hz

RS-232 compatible or TTL in/outputs for computer use

Mark hold with an adjustable threshold to set copy level above noise

Functions as stand alone demodulator directly into printer or will feed your microcomputer for video/printer use

Scope outputs and keyboard activated switch for push to talk operation

Multimode autostart with motor plug

Ham Net **\$449.00** at local dealers or direct

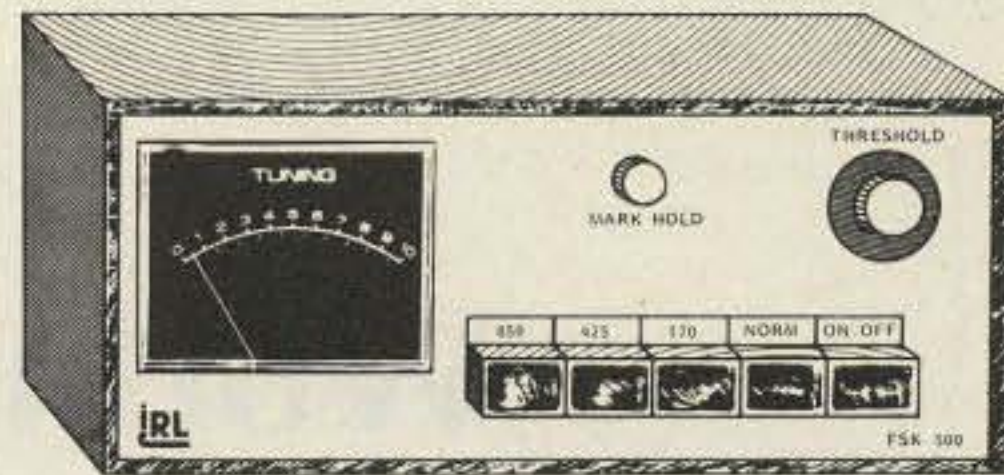

## FSK-500™

In January, 1980, iRL will offer a new, low cost RTTY demodulator. The FSK-500 is designed specifically for interface with the many microcomputers available today.

Designed for interface with TRS-80, PET, Apple, Heath

Includes bandpass preselector to fight ham band QRM

Fully active filters in each channel

Receives 170, 425, and 850 Hz shifts

3 shift AFSK keyer is included

Mark hold to prevent running open

RS-232 compatible or TTL mark high in and outputs

Auto start built in Normal or Reverse switch to copy reversed shifts

117 volt, 60 Hz AC or battery supply

American made to give you the most value at the least cost of anything else now available

Ham Net **\$197.00** Available January, 1980

## TRS-80 Software

This software replaces the expensive video drivers and code converters to allow all TRS-80 microcomputers to copy RTTY.

- Requires only 4K, Level One memory
- Receives and transmits Baudot (5 level) code at 60 or 100 words per minute
- Receives and transmits ASCII (8 level) code at 110 baud
- Supplied on cassette for easy loading
- Order now for January, 1980 delivery

\$46.00 or just \$20.00 with the purchase of either iRL demodulator above.

700 TAYLOR ROAD  
COLUMBUS,  
OHIO 43230

**iRL**  
T.M.

Now at these dealers

Amateur Electronic Supply  
Ham Radio Outlet  
Universal Amateur Radio

# Working with FETs

## — part II: experiments with gain and supply voltage

In part I of this article, I began a discussion of audio amplifiers which use the FET, the transistor that thinks it's a tube. Let's continue by examining more of the functions these devices can be made to perform.

The triode FET small-signal voltage amplifiers are probably the all-time easiest circuits for a tube person to work with. This is one place where your tube-thinking will fit right in almost without change, and yet you will be working with solid state.

The circuits are straightforward, easy to duplicate, and the testing is nothing out of the ordinary. For basics, as with some of the other articles in this solid-state series, a microphone, audio signal generator,

VOM, and scope are what you need.

It will help if you have a good junk box of small parts or a resistance sub box. Part of the fun on this one is watching what really happens when you play around with the values.

Here goes. Fig. 1 shows a basic triode tube voltage-amplifier stage. Notice that there is no cathode resistor. This stage would be a common first stage for a mike amplifier in an SSB rig. There are other uses for such a stage, too, but the important thing to note is the absence of the cathode resistor.

In theory, it looks as though the stage is running without any grid bias. There is a tiny smidgen, however; it is caused by

"contact potential." The stage is able to get away with it because the input signal is assumed to be so small that the stage is still operating on a linear portion of its tube curve. The amplified signal is sent to the next stage, which is very similar but usually has the cathode resistor.

Our tube stage has a few other points about it. It is high impedance. (A tube is voltage-operated, that is, high impedance.) Notice that the grid resistor is 1 megohm. The load resistance of such a stage is often in the 100k to 220k range. A high signal output voltage is developed across the output resistance, but this is at very low power. The current may be on the order of a few mils or so.

Fig. 2 shows the same amplifier with an FET as the triode. This test circuit uses the Motorola HEP801. This

is an "N" channel FET. That means it is roughly the same as the NPN bipolar transistor, as far as bias polarity goes. In fact, you hook up the voltage the same as for the tube; you just use less of it and only one supply.

The specs say a maximum of 20 volts between any of the elements. The maximum drain current is 15 mA. That's not much in the way of power, but it's not meant for power. While it can go to 20 volts at the drain, this series is geared to 12 volts, so we have some built-in safety margin.

There is one other mechanical oddity with the 801 which should be mentioned. There is a fourth pin which connects to the case. This is for shielding. For test use you can ignore it. If you want to be fancy, ground it or connect it to the source pin. You will do this anyway if you use it in an IC matrix board as I did.

Here's where the fun starts. Usually with solid state you have to fuss about the parts' values. This is the gizmo that thinks it's a tube. Let it think that. Use the same 1-meg resistor at the gate, since this is not critical at all. As with a tube circuit,

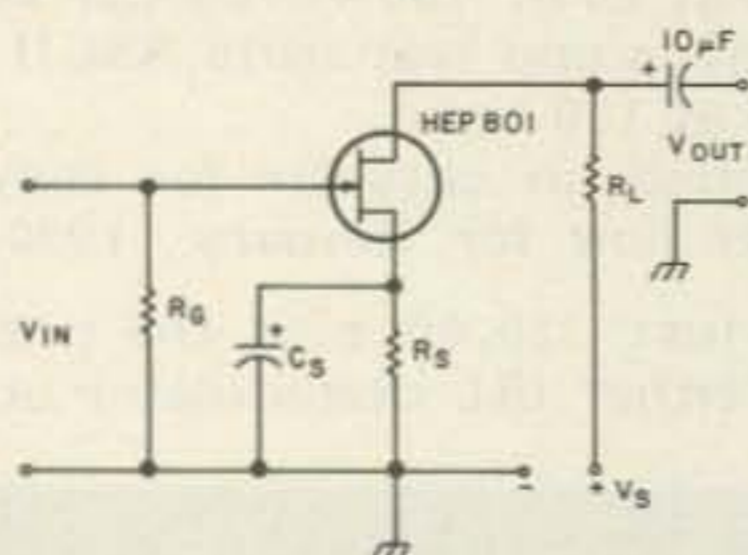

	$R_G$	$R_S$	$R_L$	$C_S$	$V_S$	$V_{IN}$	$V_{OUT}$	GAIN	Db
A	1M	NONE	2.2K	NONE	12VDC	1.5 P-P	6V P-P	4	12
B	1M	2.2K	15K	NONE	12VDC	<1.5 P-P	6V P-P	4.6	13.2
C	1M	2.2K	15K	10 $\mu$ F	12VDC	0.4 P-P	6V P-P	15	23.5
D	1M	2.2K	15K	10 $\mu$ F	20VDC	0.2 P-P	6V P-P	30	29.5

Table 1. Circuit performance test results.

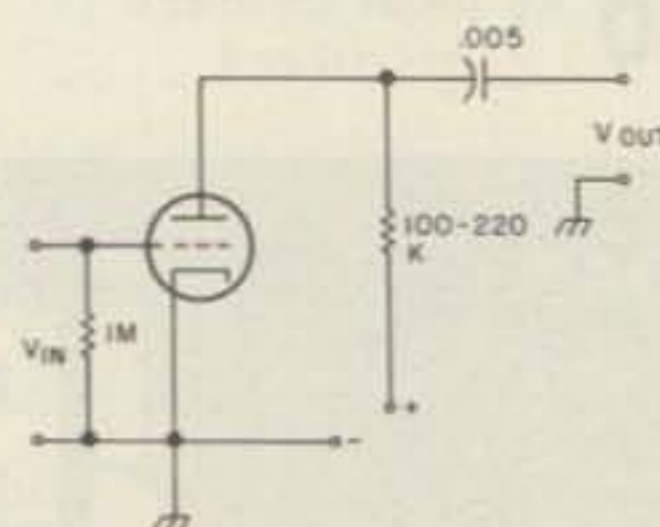

Fig. 1. Triode tube voltage amplifier stage.

250k on up would be common, and the circuit will work with much more and much less.

The next thing to fuss with is the drain load resistor. Use your substitution box and click your way down. With the mike input, at some point you will begin to get it to work. Then watch the scope and prune for best results. You might put your VOM in the drain circuit to watch the current; it's educational. The circuit should only draw a few mils. By the time you start to draw much current, you can see the performance fall off on the scope.

The drain resistance is not that critical, and a wide range of values will work. This is a wide-range circuit. When it was tested above and below 12 volts, it worked from 5-20 volts. It might work at even less, although my supply would go down only to 5.

If you work at it, you may be able to get clipping with the mike, but here is a nice time to try adding an audio signal of some sort, and it would be nice if it was adjustable—or you can add a standard tube-type volume control as in Fig. 3. Just keep the input signal to less than 20 volts p-p.

I started with the theory that the operation would be quite similar to the tube version, but there was quite a surprise when I started comparing the data. With the simple circuit, your only variable is the load resistor. This gets adjusted for most output voltage. This may not be clipped. Once you get the most output, adjust the input signal until the output is undistorted. That will be your best value. Check a few resistance values on either side to make sure, though.

With my HEP801, this worked out to a 2.2k-Ohm

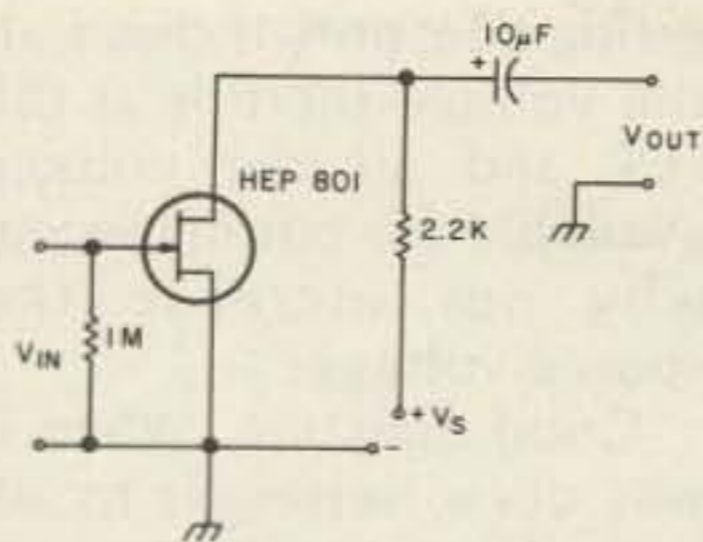

Fig. 2. FET triode circuit.

load resistance at a 12-volt source voltage. It gave a 6-volt p-p output. Then I added the source resistor. I had to go back and re-adjust the drain load. The values are not critical, but I settled on a source value of 2.2k and a drain value of 15k (Fig. 4).

This also got me an output of about 6 volts p-p. I had hoped for a clearer parallel to tube operation, but I don't really see it on the scope. With the tube, a cathode resistor would allow for more input voltage swing before distortion, but I really saw little difference between the two FET circuits. The scope values were about the same. The input distortion point was about the same, and I could get the same general output. So much for theory.

The oddest effect was when I added the bypass capacitor (Fig. 5). With a tube, this would have increased the bias and the output. It did increase the output to about 10 volts p-p, but it was clipped. All I could get was about 6 volts peak-to-peak from the circuit, but the resistor-capacitor circuit had more gain. What it did was lower the input distortion point. In other words, I could not have as high an input signal,

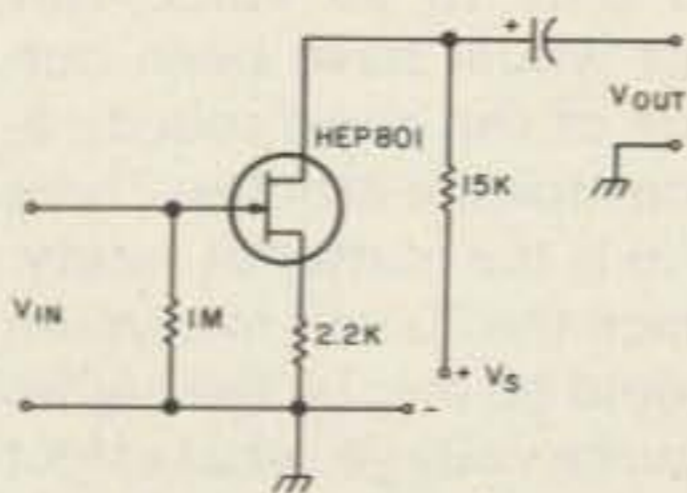

Fig. 4. Source resistor added.

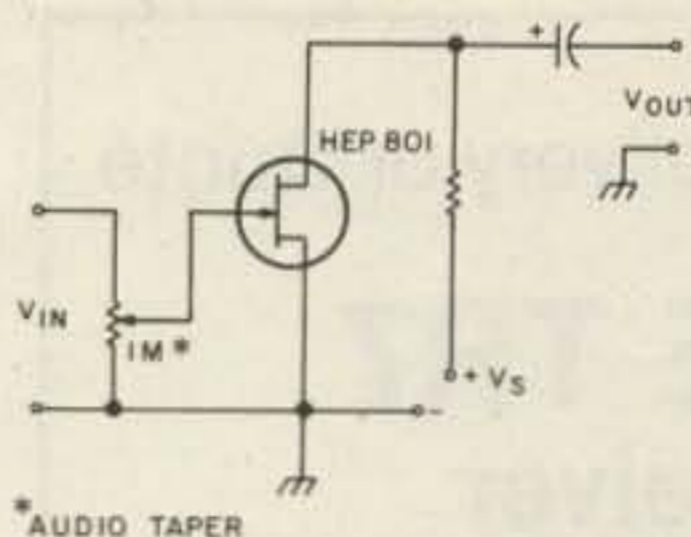

Fig. 3. FET volume-control circuit.

but the circuit would give me the same output with less input.

Rough scope measurements placed it at over 9 dB gain over the other two circuits. Thus, it is far more sensitive, but easier to overload. I used a 10-uF capacitor, but a higher value would be better, something from 20 to 100 uF.

The statistics of these circuits are somewhat alarming. They don't behave quite the way I would have expected. Table 1 shows a chart of various operating conditions. The first three have an operating voltage of 12 volts at the source; the last is 20 volts at the source. For this test, the input voltage was adjusted for an output of 6 volts peak-to-peak, and then the input voltage was measured p-p.

The output was divided by the input and the gain figured and converted into dB. In each case, the circuit was optimized for output in each configuration, with the circuit values shown being chosen. The no-resistor circuit would take a higher input, but needed a high input to get the 6 volts out. Its gain was

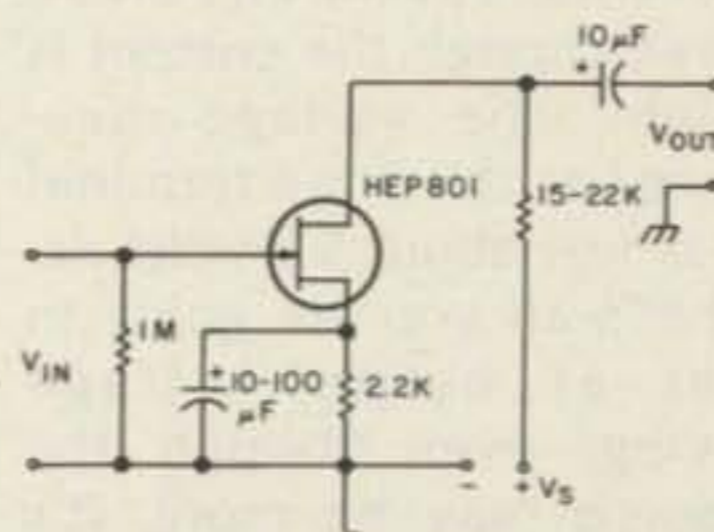

Fig. 5. Highest sensitivity and gain circuit.

only four.

The unbypassed resistor circuit was only slightly better. The bypassed resistor circuit not only had the best sensitivity to a weak signal, but also had much better gain. When the voltage was raised, the output voltage could have been more, but even holding to our present value, the actual gain of the circuit increased even at the lower levels. I was surprised at the difference in gain figures between the no-resistor and bypassed-resistor circuits. The other tests, such as for total output and distortion from overload, did not show up such a wide difference in actual circuit performance.

The low-gain high-input circuits would be the choice where you had gain to spare and needed high input capability. For most uses, you will probably want the bypassed circuit so you get some actual gain in signal and the ability to be sensitive. It was also unexpected that the gain of the circuit would increase with the increase in voltage to it. It was not just a matter of more possible output; the circuit worked better at the higher voltage when it was optimized for it. Still, I would have to recommend staying at the 12-volt or so level so as not to throw away your safety margin.

In actual fact, these circuits are not really optimum circuits as far as gain goes. They are useful when you want the FET capabilities, but other transistors can perform the gain function better.

These rough tests may not show the whole story. After all, it was a high-level input signal I was using, but these were intended to be rough-and-ready circuits to work with. There might be reason to use the source resistor even if the

Call or Write for Delivery or Quote

## DRAKE TR7 Transceiver



LEAVE A MESSAGE & WE'LL CALL YOU BACK!



**MADISON** M35  
Electronics Supply, Inc.

1508 McKinney • Houston, Texas 77002 • (713) 658-0268

capacitor was not required. This would not be the highest gain, but would be the most stable. Besides being the best as far as input overload, you also have the stabilizing effect of the extra resistor. It will prevent any problem with the drain circuit trying to draw too much current. It's unlikely, but it will give protection. It also may help stabilize the stage and even out operating variations as a tube does—but it just doesn't show on the scope.

I chose the 801 because it is commonly available. There are plenty of other audio FETs which should work with these circuits, and you may want to, or have to, prune values for best results. The same techniques will work with any FET. You should keep in mind that there is a built-in brick wall. After a certain point, you cannot have any more output voltage.

In theory, you would run out of supply voltage to provide output, but you don't even get the full supply voltage swing, anyway. Past a certain point you are going to clip the peaks off because there is no additional voltage available to become output voltage swing.

The fact is, a lot of what you think ought to be available voltage just isn't there. Your output voltage swing is only what you have at the drain itself. These circuits are centered on 12-volt source voltage. That's at the power input, not what's at the FET drain. Even though the current is slight, the voltage measured at the drain terminal was just about 5.5 volts dc. That's all you are going to get as output voltage swing; even though the source may be more, it's what's at the FET that counts.

This brings up an inter-

esting question. If that's all the voltage there is at the FET and all the voltage available for output swing, why not increase the source voltage?

Good question. When it was done, setting it to 20, the circuit worked even better, but the FET drain voltage was still only about 12 volts, which means an output voltage swing of even less than that.

What about increasing the source voltage until the drain voltage as measured reaches 20 volts, the maximum allowable?

Here, you face several design decisions. As a practical matter, if you wanted to try it, you would start with this circuit and increase the source voltage while measuring the drain voltage and current. When it reached the desired value, you would probably want to go back and try some different values at the load resistor. You would have to get a new best value for the higher voltage. This would mean some resetting of the resistor and the voltage, back and forth. You would arrive at the best values for your 20-volt drain voltage, though, if you use the method described here. It is likely that you would get increased performance, too, but there are drawbacks.

The first is the higher source voltage. You would need somewhere around forty volts. This series was geared to 12, since most equipment these days wants to use batteries if possible.

It also might be mentioned that my supply goes up only to 20 volts. This test would have been outside of the given specifications for the articles. There also is the matter of safety. Since the 20-volt maximum would be met by the higher source voltage, what effect would this have when you really started pushing out a

20-volt peak-to-peak audio signal? You would be running close to the ratings, which is not the best way to design.

Still, if the test setup is available and you are willing to risk a bargain FET or so, go ahead and try it. The basic monitoring procedure should tell you what is going on, and the test will give you an even more complete picture of the full capability of the FET. As to applying it in a circuit, that would depend on how you were going to power the final circuit.

Trouble with small-voltage amplifiers accounts for a great deal of the distortion problem in equipment. Input overload is common. Depending upon the type of amplifier, it may be biased to accept a certain input level and start to clip a peak because the bias is wrong for a higher level. That's why you find some circuits designed to handle a high-level input, even though it is intended for a lower-level use.

Musical instrument amps often have that feature. A guitar might work fine, but one with a built-in preamp would distort if the amplifier input circuit couldn't handle it. After that, it's a question of your output voltage swing. You may have lots of gain, but how much can you use before you get up to all the output voltage you can have and start clipping?

If you are looking for distortion, you can see these effects with your scope in a circuit. If you are building, you can build to take care of some of them.

Still, without even trying, we have opened the door to further developments of this simple circuit. They are easy to implement and have their own place in practical usage. We'll discuss them in part III of this article. ■

## QUASAR VIDEO TAPE RECORDER SALE!

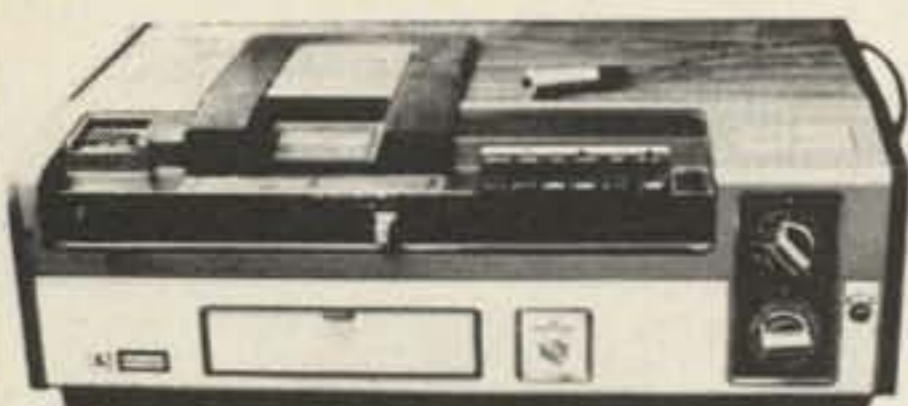

- ★ Records to two hours, color or black & white
- ★ Records off the air—record one program while watching another
- ★ Camera input to make your own tapes
- ★ Can be used with optional timer while you are out
- ★ Pause control for editing
- ★ Limited supply—these \$1,000 VTRs were demonstrators & come with new warranty . . . \$499
- \$100 worth of new blank tape will be included at no extra charge!

Send for our new catalog!  
\$3 Shipping charge per order • NO C.O.D.s!

Bill:  MC  Visa

Credit card # \_\_\_\_\_

Exp. date \_\_\_\_\_

Signature \_\_\_\_\_

Name \_\_\_\_\_

Address \_\_\_\_\_

City \_\_\_\_\_ State \_\_\_\_\_ Zip \_\_\_\_\_

**TUFTS**  
Radio Electronics

209 S. Mystic Ave  
Medford MA 02155  
1(800) 225-4428  
(617) 395-8280

✓ T3

# COMPACT BRIN

## TU-170

\$159.95 buys a terminal unit kit with capabilities beyond your expectations for the price. And

the Flesher Corp TU-170 won't devour your precious space. Wired units are available at \$234.95. Call or write today for our free 1980 catalog of affordable kits, wired units and accessories.



### FLESHER CORP

P.O. Box 976 • Topeka, Kansas 66601 • 913 • 234 • 0198

✓ F5

## The Only Automatic Dialing Touch Tone MIC

The CES Model 235A Automatic Micro-dialer has a 10 number memory that can store even 11 digit numbers. Just dial \* and one digit to bring up auto-patch, pause and dial phone number automatically. Program Dialing speed for virtually any repeater auto-patch, then dial number at fastest speed. Automatic PTT with manual or automatic dialing. All dialing and programming done from Keyboard. LED indicator for programming or PTT and . . .



79.95

ALL CONTAINED IN A SMALL MIC.

At your Ham Radio Dealer  
For more information write

**CES** COMMUNICATIONS  
ELECTRONICS  
SPECIALTIES, inc.

P.O. Box 507, Winter Park, Fla. 32790

✓ C115 305/645-0474

## Directional RF wattmeters from Dielectric



The new 1000-A Wattmeter from Dielectric accepts plug-in elements that permit RF measurements from 100 mW to 5000 watts full-scale and from 2 MHz to 1 GHz. The large 4½" meter face is easy to read and has ± 5% full scale accuracy and great resolution.

The 1000-A is available in a convenient all-purpose kit that includes a SNIFFER adjustable RF signal sampler, spare UHF connector and patch cable. All contained in a durable carrying case.

## RF Instruments for Professionals

For the name of your local distributor, call Toll Free 800-341-9678.

A limited number of distributor locations are currently available; inquiries welcomed.

**Gs**

**DIELECTRIC COMMUNICATIONS** ✓ D29

A UNIT OF GENERAL SIGNAL  
RAYMOND, MAINE 04071 • TEL. 207-655-4555 • 800-341-9678

# Build this \$50 Mini-Counter

— three-IC design goes to 135 MHz

Sooner or later, anyone who does much work with communications equipment discovers the need for an accurate frequency counter. Let's face it, crowded communica-

tions channels make knowing your frequency more important than ever. This is where this counter project comes in.

Would you like to have a counter that measures fre-

quency up to 135 MHz and beyond—one that is pocket-portable with battery power to make accurate measurements simple anywhere? Of course you would! The Model 304

Communications Counter has these features and much, much more: a low price tag of about \$50, easy, one- or two-evening construction, and a superior sensitivity from 4-mV rms at 27 MHz to 12-mV rms at 135 MHz with input protection.

The 304's battery drain is low enough (130 mA) that you get long hours of operation on a set of charged nicads. You get a frequency range of below 1 MHz to over 135 MHz, covering ham, CB, commercial, radio control, and TV frequencies. And, best of all, you can measure the frequency to within 100 Hertz of what the transmitter is putting out. If you are in a hurry, you can select a reading to within 1 kHz, and get five readings per second versus one reading per 2 seconds on the 100 Hz range. Accuracy can be up to  $\pm 0.002\% \pm 1$  count if the counter is calibrated on a frequency standard. Now that you know what this counter can do, go out and look at units selling from twice to three times as much as this one. One wonders why no one has thought of this design before.

Construction of this project will be a pleasant surprise because it is very

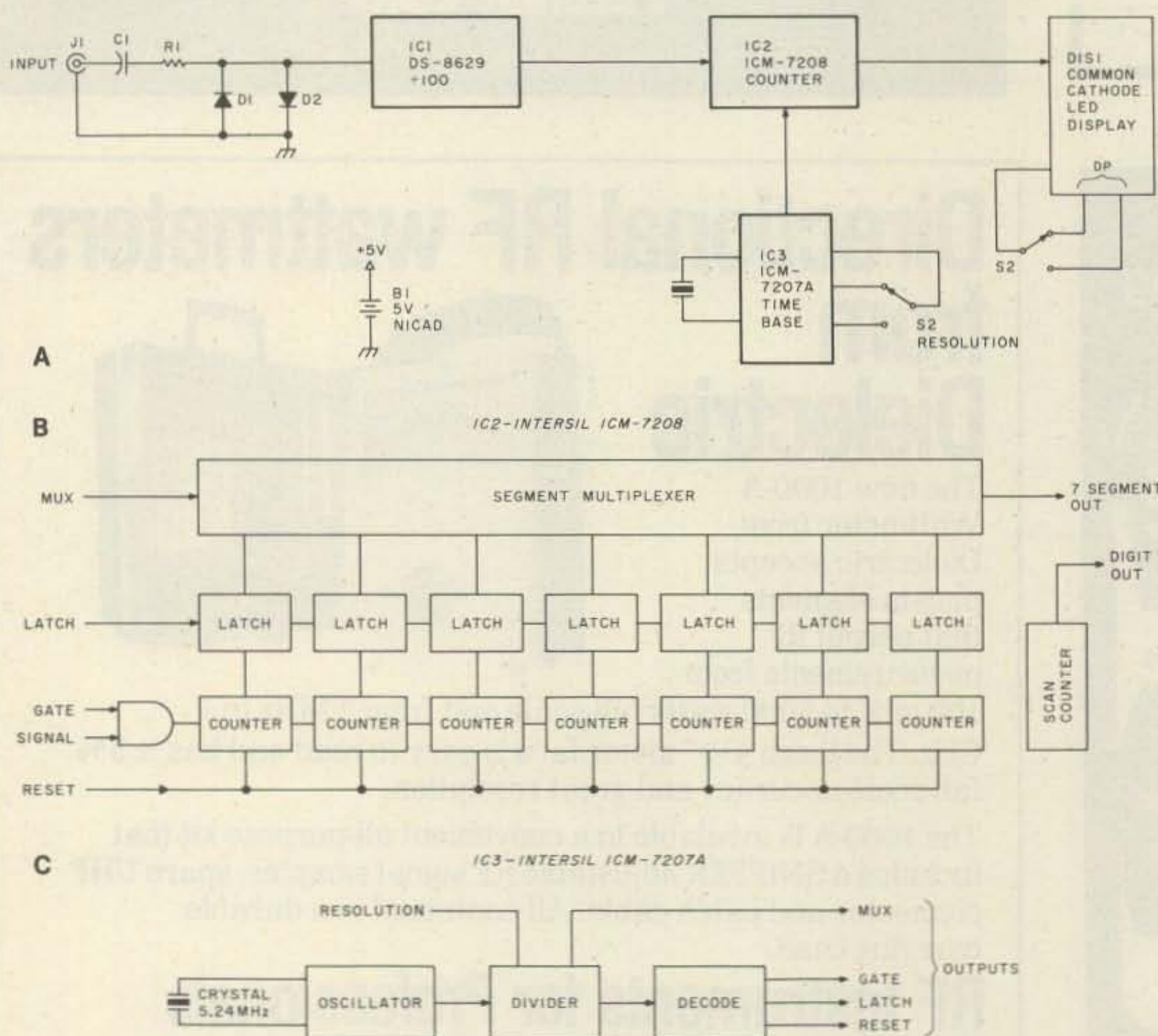

Fig. 1. (a) Block diagram of the model 304 counter. It features a 6-digit display, a 135-MHz counting range, and only three ICs. Power is supplied by a 5-volt nicad battery pack. Switch S2 selects either 1-kHz or 100-Hz resolution of the input signal. (b) Inside the ICM-7208 (IC2) counter array. (c) Inside the ICM-7207A timebase controller. An input connected to the divider section controls the gate time, and thus the resolution of the signal being counted by IC2.



Fig. 2. Component side of the board. Be sure to get all jumpers installed before the sockets go in.

easy. Thanks to a clever PC board layout, this project uses only a single-sided PC board, making duplication from the pages of this magazine a snap. There are only six wire jumpers in the board—for those of you who hate to install jumpers. There are sockets for all ICs and a minimum number of components. Since there are only three ICs and one transistor, your construction time for the board should be about four hours of casual work. Add another evening for the cabinet work and you are all set.

The parts in this counter should be easy to get. The two main CMOS chips have been on the market for nearly three years, and the prescaler chip has been used for well over one year. The rest of the parts are not too critical. All parts are available from the surplus houses. To assist you, however, I am including addresses of typical suppliers of the key parts, plus the addresses of the manufacturers who make the ICs. If necessary, you can write for a local dealer's name and address.

### How It Works

This counter project is based on three ICs: One amplifies and divides the signal by 100, another counts it up and displays 7 digits of information, and the third generates precise timing signals to control the second chip. Check Fig. 1 for details as you read.

Input signals applied to J1 first encounter a protection network composed of C1 (which blocks dc), R1 (which limits input current) and D1-D2 (which limits input signal). The purpose of this network is to protect the counter from "real world" overloads such as an accidental dose of ex-

cessive dc voltage, 120 volts ac, and excessive rf signal. This keeps IC1, the preamp/prescaler chip, safe.

Next, the protected signal goes to IC1. Although this IC was designed by National Semiconductor for synthesized FM stereo radios, it works great in a counter. It has a preamp stage for high gain which has sensitivity of up to 4 mV at 27 MHz, then a series of ECL (Emitter Coupled Logic) and low-power Schottky TTL dividers. It divides the input signal by 100, so 100 MHz in equals 1 MHz out. This is necessary because the counter-display chip to be described won't count a TTL signal much beyond 2 MHz.

The divided signal enters IC2, a CMOS/LSI chip that counts it and displays the results on an LED display. Fig. 1 shows a general overview of this chip. The signal from IC1 passes through seven decade counters. They count up the signal. After it is counted, the data is passed on to the display via the latches (one per decade counter), through the multiplexing circuitry, and on to the display. Actually, the multiplexing circuitry consists of a big data selector at the output of the latches, squeezing 7 digits (at least 4 lines each) into a single set of 7-segment lines. The latches hold the signal while the decade counters are reset to zero and count up the signal again. The latches are then opened allowing the new reading to pass through to the display. This prevents the rapidly changing decade-counter outputs from reaching the display and causing a blur of numbers. The sequence in which the count-latch-dis-

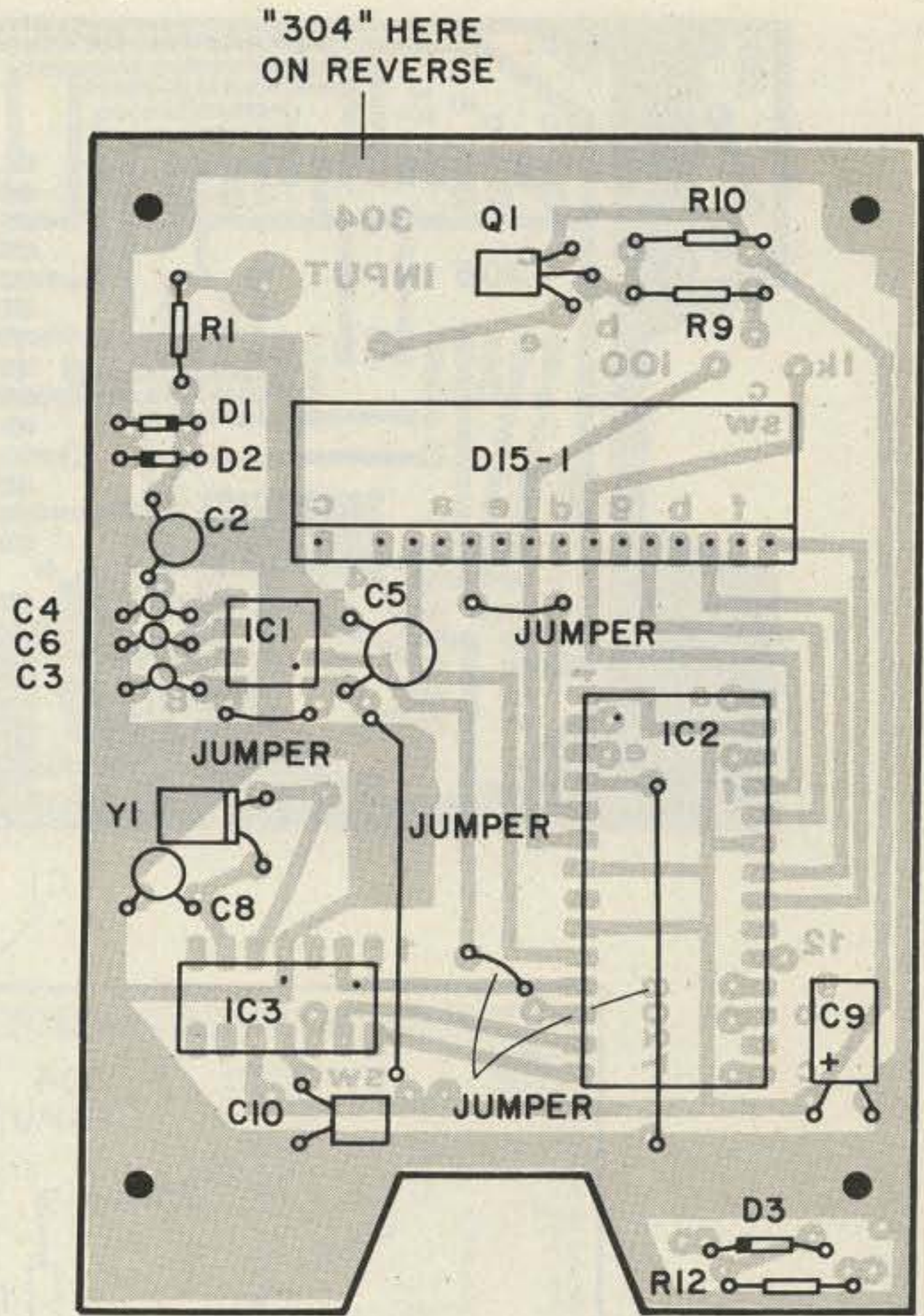

*the indispensable*  
**BIRD 43**  
THRULINE® WATTMETER

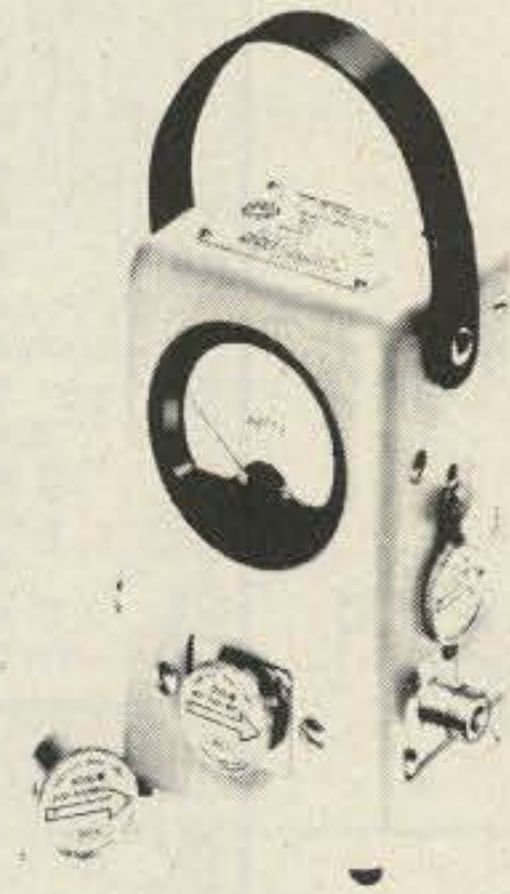

**Read RF Watts Directly.**  
0.45-2300 MHz, 1-10,000 watts ± 5%, Low Insertion VSWR - 1.05.

Unequaled economy and flexibility: Buy only the element(s) covering your present frequency and power needs, add extra ranges later if your requirements expand.

**THRULINE Model 43 RF Directional Wattmeter and Elements in Stock.**



MADISON

Electronics Supply, Inc.

1508 McKinney • Houston, Texas 77002 • (713) 658-0268 ✓ M35

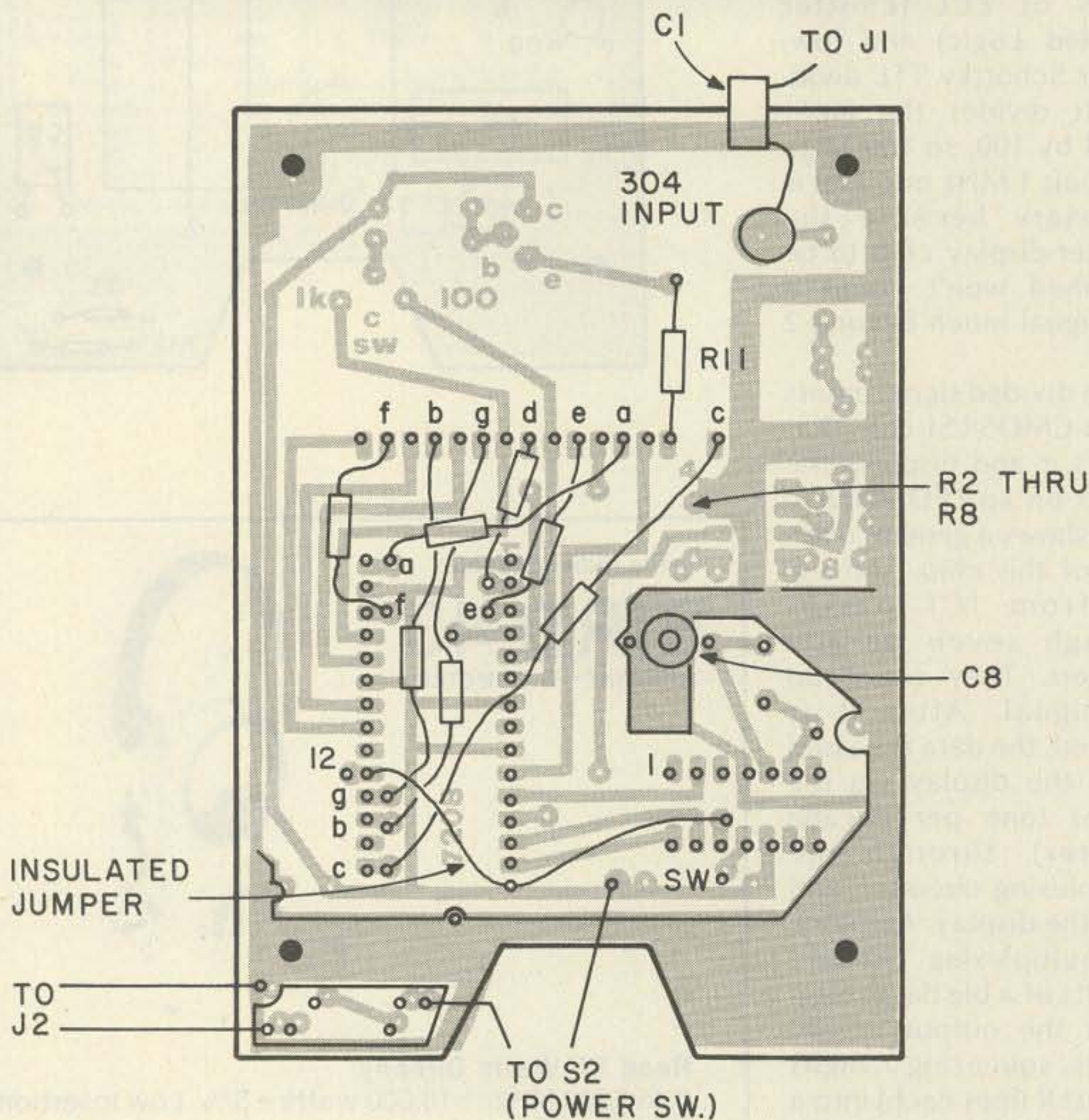
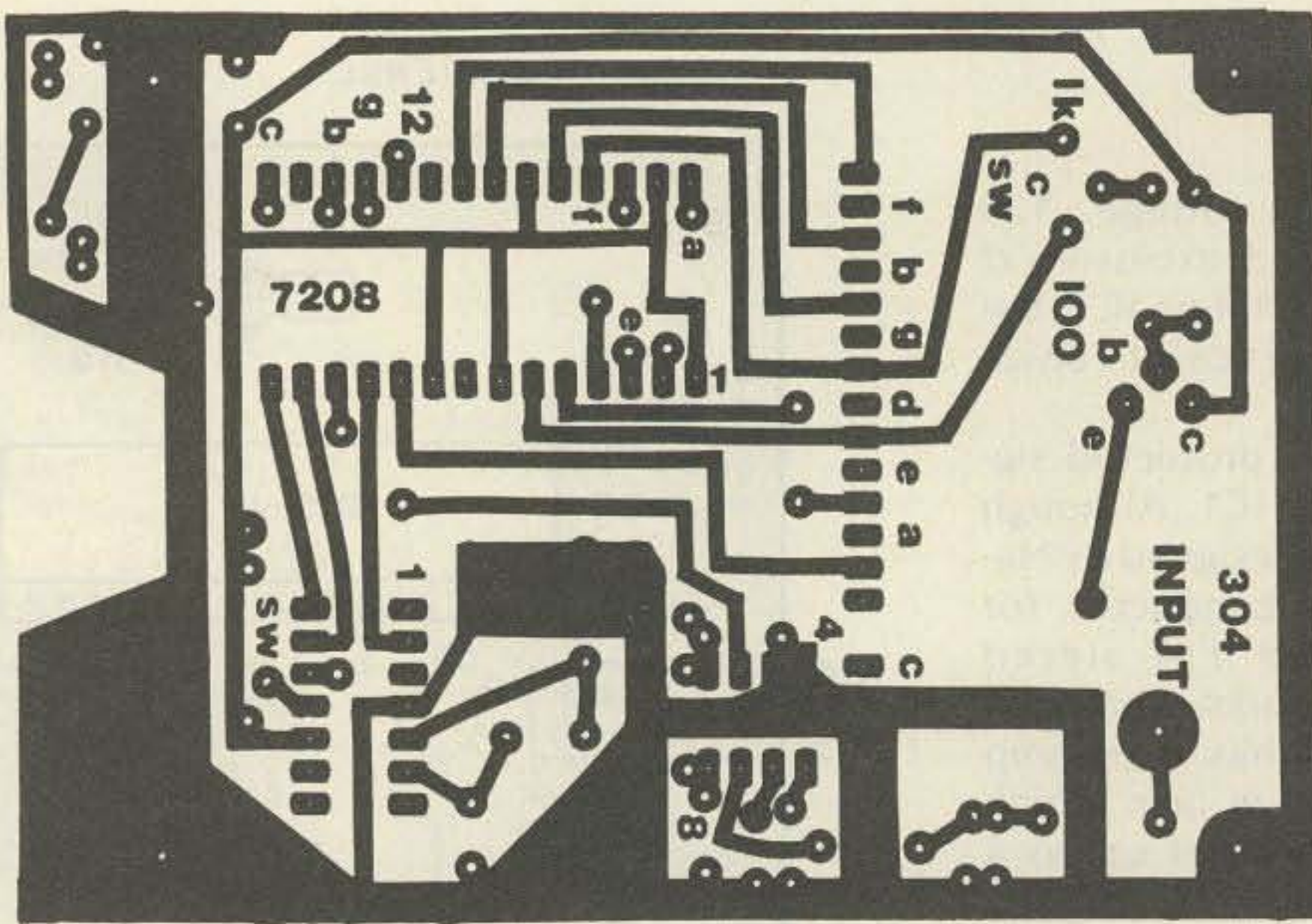

Fig. 3. Foil side of the board. Take your time and install those resistors correctly!

play-reset cycles occur is determined by the third IC.

The third IC generates the key signals necessary for IC2 to count the input signal properly. Fig. 1 shows a block diagram of this chip. A 5.24-MHz crystal connected to IC3 is the source of the proper frequency. It drives a Pierce-type oscillator inside the

chip, which has the advantage of very high stability. (The circuit isn't much like the old 6AG7 tube Pierce oscillators of days gone by, but it accomplishes the same result.) The output drives a divider chain composed mostly of binary devices, and then the output drives a series of gates generating the precisely-

timed gate, latch, and reset pulses needed by IC2. Also, an input connected to the divider chain controls its length—or number of stages—and selects a 1-second gate time or a 100-ms gate time. An output from IC3's divider chain also carries the multiplex signal for IC2. This signal determines when a digit will be

scanned by IC2's multiplexer, and is just as important as the other signals.

### Construction Guide

The first step is to round up the parts. If you are lucky, you can probably scrounge most of them from your junk box, but more likely you will have to buy at least the ICs. All of them have been available to the industry for nearly three years, and they are starting to pop up in the ads.

The LED display is commonly used in low-cost calculators, and can be almost any such unit; the pinouts have been pretty much standardized by various manufacturers. We have used National NSB-188, Litronix DL-94 displays, and others with success. The HP unit specified is recommended because of its superior appearance, but its \$12 price tag may drive you to scrounging a junk calculator instead. Order any parts you need, plus the crystal. If my own experience is any indicator, you should order the crystal first. They are custom made, and take time to get.

The next step is to obtain or make the PC board. Luckily, this one is a single-sided type, and can be made at home using the G-C "Lift It" kit, or the newer printed circuit transfer films such as PCP type A, which is carried by Tri-Tek, Inc. (See distributor list for address.) It might be wise to silver-plate the finished board to improve high frequency performance, but that is up to you. While the improvement will be slight, the appearance will be considerably better. Drill all holes with a number 64 drill, and then drill out the four corner holes with a 1/8" drill. Now let's start the wiring.

You should install the jumpers and IC sockets before doing anything else. Refer to Fig. 2, which shows

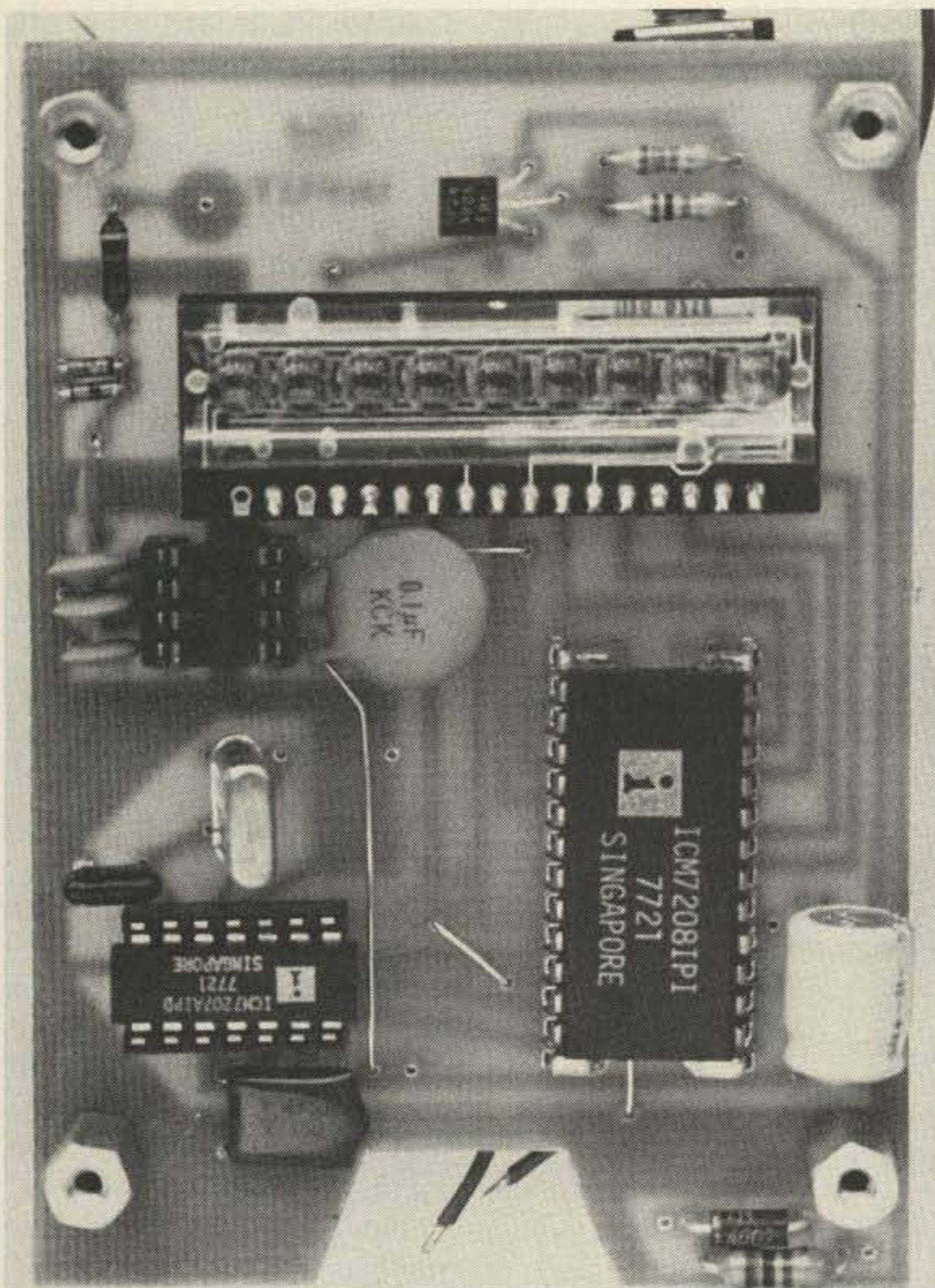

Fig. 4. Completed component side of the circuit board. Your finished board will look like this.

the component side of the board. Cut up three 1" pieces of no. 28 solid wire or resistor leads. Then cut two 2" pieces of wire. Install one 2" wire between the two holes near the right center of the board, as shown in Fig. 2. Install the other 2" jumper between the two holes near the left center of the board. Install a 1" jumper near the bottom of the board at the cut-out. Move up to the center of the board, and install the remaining two 1" jumpers. Be sure to get the jumper nearest the left center of the board in the proper holes. An 8-pin IC installs next to it. When done, check to be sure all connections are soldered. Also, trim away the PC board at the bottom to form the trapezoid-shaped cutout, if you haven't already done so.

Next, install the 8-pin

low-profile IC socket in the top left corner, next to that small jumper. Move down from it and install a 14-pin low-profile socket near the bottom edge. Finally, install the 28-pin socket next to the right edge of the board. I recommend the use of low profile sockets because they make later installation in the cabinet easier. Molex® pins will suffice, however. Check for solder bridges, fix, and flip the board over. Cut a 1 3/4" piece of insulated hookup wire, strip, and solder one end to pin 12 on the 14-pin socket, and the other end to pin 19 on the 28-pin socket. This wire shows up on Fig. 3. (Note that there is a "1" to identify pin 1 on each socket.)

The next step is to install the eight segment resistors on the foil side of the board. About 1/4" of each resistor lead appears on

the other side of the board so that the lead comes for mounting the display, so don't trim the leads off from the row of wires in the center of the board. Start with the A segment resistor, R2. Lay the resistor against the board between the A on the socket (28-pin) and the A pad in the center of the board. Pass the resistor end through the A pad,

so that the lead comes through the hole in the center of the board. Remember that this is for the display, so don't trim it. Solder to the pad. Bend the resistor body so that the other lead won't touch any other foil but the A pad on the 28-pin socket.

This process is identical for the other resistors, and

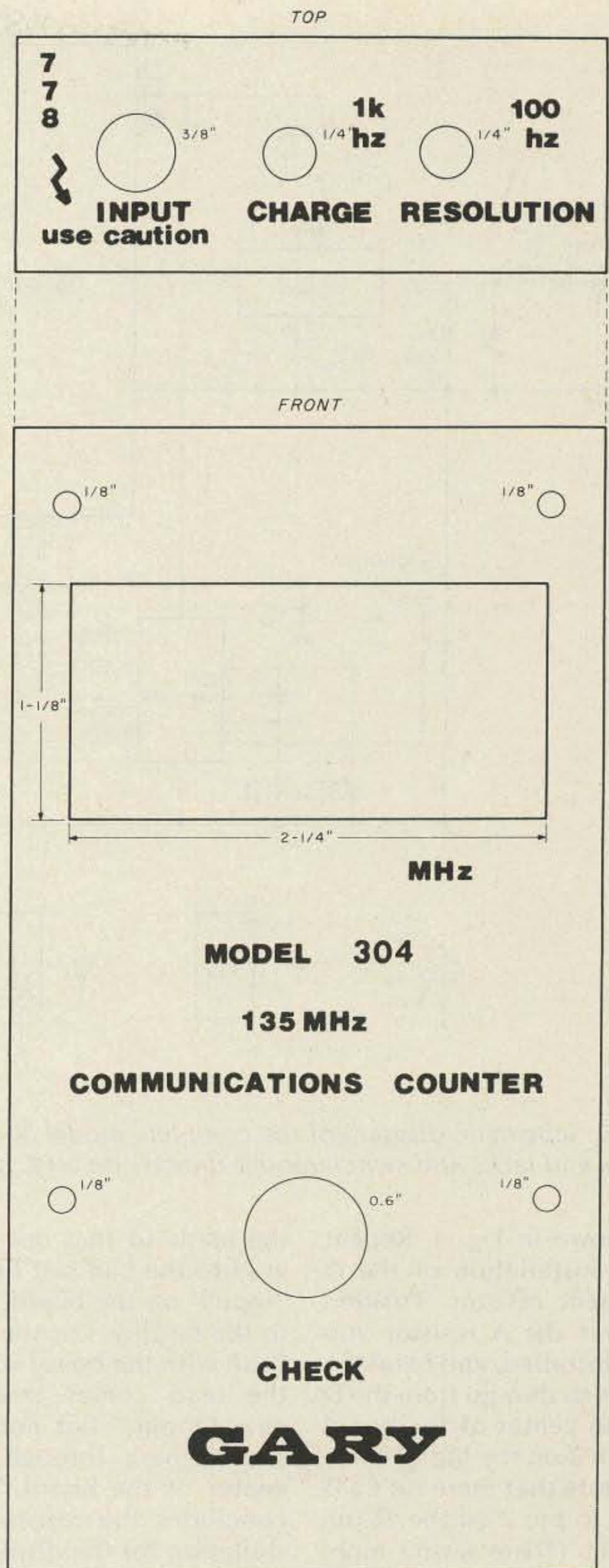

Fig. 5. Cabinet drilling template.

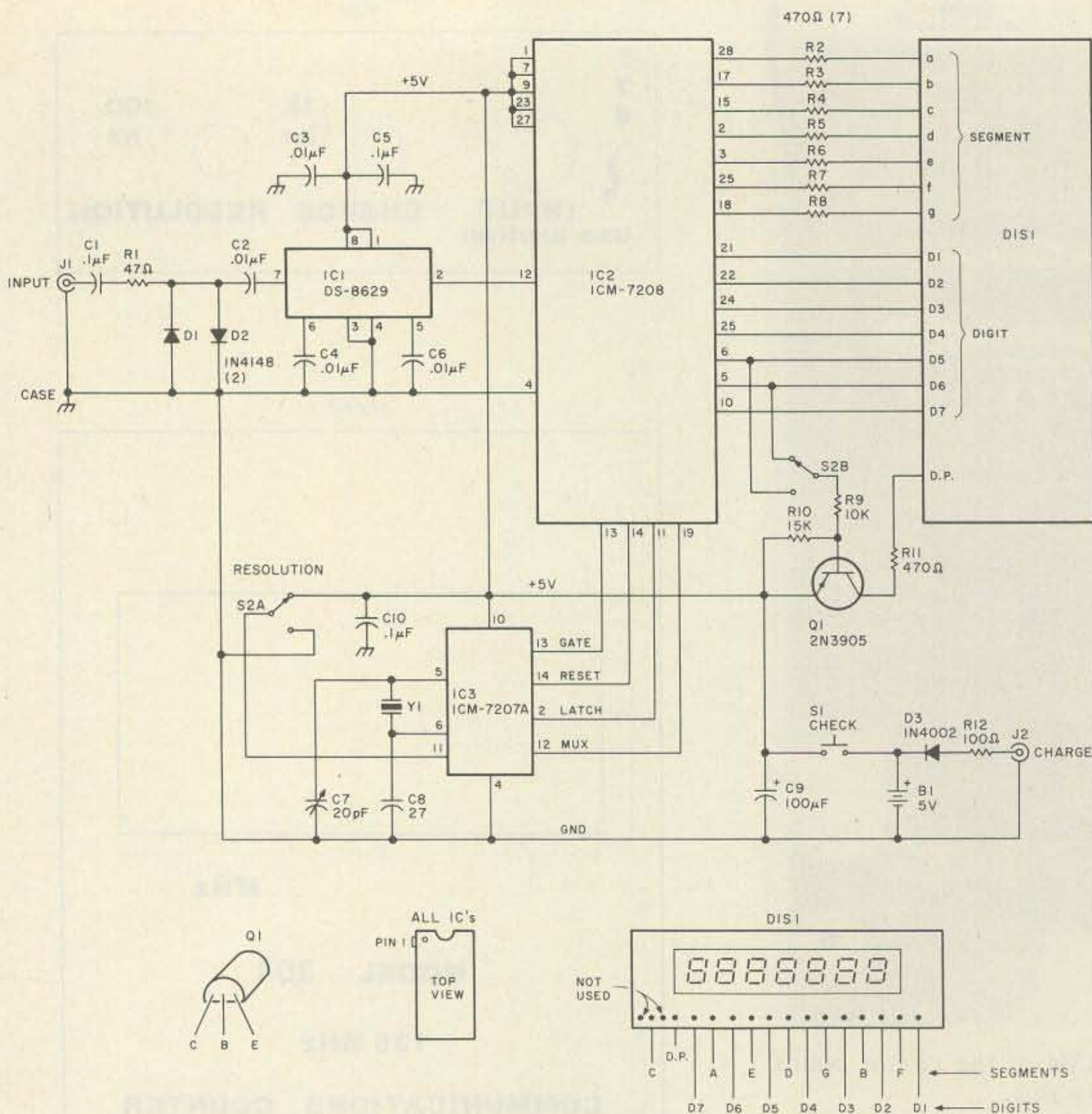

Fig. 6. Schematic diagram of the complete model 304 counter. All parts except the batteries and jacks and switch mount directly on a PC board.

is shown in Fig. 3. Repeat with installation of the D segment resistor. Position it over the A resistor you just installed, and bend the leads so they go from the D in the center of the board to pin 2 on the big IC socket. (There wasn't room for it.) Continue by installing the E segment resistor in the same manner, leaving at least 1/4" of lead sticking through the center of the board to mount the display. Continue with the F, G, B, and one end of the C resistors. Attach a piece of bare wire to the other end of the C resistor, slip a piece of insulating tubing over it, and solder the wire to the C pad on the big IC socket. Pick up another 470-Ohm resistor and bend

the leads so that one end goes to the pad just below "Input" on the board, and to the display. Cut the end flush with the board where the lead comes through near "Input," but not the one coming through the center of the board. That concludes the resistor installation for the display. Continue by cutting up seven 1" wires for use as jumpers. These jumpers tie the digit leads from IC2 to the cathodes on the display. Heavy wire, just large enough to fit the display holes, might work better here, but the wire size you use is up to you. Bend one end of each wire into a small right angle, so that the wire looks like the letter L. Pass a wire through the foil side of the board, and place the short arm

against the foil pad. Solder carefully. Put a wire in each pad that doesn't have a resistor. Use patience and care to prevent the wires from touching the adjacent resistored pads. This concludes the hardest part of the project. Turn the board over to the component side and very carefully clip the 15 wires down to about 1/4" above the board. Place the display over the wires, being sure to leave the hole on the the far left side of the display open. All holes on the right side must be used. Do not leave a hole open here or the counter won't read right. Press the display down flush against the board, and solder quickly. Use a minimum of heat to avoid loosening the wires soldered to the

counter PC board. Clip off the excess wire.  
 The rest of the wiring needs no comment; refer to Fig. 4 for details. Install resistors R9 and R10 at the top of the board and R1 along the left side. Move to the bottom right and install R12. Now you have installed all resistors.  
 The semiconductors go in next. Install Q1 at the top center of the board, as shown in Fig. 4. For your convenience, the E, B, and C were marked on the reverse side of the board. Move over to the top left side of the board and install D1/D2 in the spaces near R1. Note that the bands on these diodes point in opposite directions. Move to the bottom right corner of the board, and install D3. That completes the semiconductor installation. The IC installation will follow later.  
 Now let's install the capacitors on the front of the board. Refer to Fig. 4, then turn to the top left side of the board. Install C2-C3-C4-C6 as close as possible to the board. Jump over the 8-pin socket and install C5 as close as possible to the board. Bend it flush with the board before soldering. Move down the left side next to the 14-pin socket and install C8 near it. Then jump over the socket and install C10 as shown. Bend it flush with the board before soldering. Skip over to the bottom right side of the board and install C9. Be sure the negative terminal faces the outside edge of the board. That completes capacitor installation on the front of the board.  
 While you are working with the front, dig out Y1 and install it next to C8. Also, bend the crystal over against the board edge before soldering. The photo shows it standing up, but this is not normal practice.  
 Flip the board over to the foil side so that you can install the remaining ca-

capacitors. Install C1, standing on end, at the input pad. Leave the other end free. Install C7 in the spot near the center of the board. Note that on most trimmers there are three leads. The two closest together go to the heavy ground foil on this counter, while the third goes to the crystal and IC3. That completes capacitor installation.

Next, the switch and mounting hardware are installed. Attach six 3" wires to the terminals of S2. Then wire up this switch as shown in the schematic and Fig. 4, cutting the wires to size as you go along. Install four spacers in the corners with 4-40 hardware and lockwashers. Note that the spacers are on the front side.

That just about wraps things up on the module. Finish by installing the ICs. Be careful about pin 1 orientation. Remember, pin 1 is identified on the PC board if you get confused. Then cut two 1" pieces of hookup wire, strip both ends, and install at the bottom of the board near the cutout. See Fig. 3. Also, cut a 5" piece of the same wire and attach near the end in the bottom left corner of the board. That completes the module assembly. It can be tested by applying 5-volts dc to the wire off the bottom center of the board.

Now you get to work the case. Fig. 5 shows a drilling template for the front of the box. Drill out the box and nibble the display hole. Clean up the box, label it with press-on transfers, and spray it with clear acrylic spray to preserve the finish.

Complete the assembly by installing the module in the box and wiring it up. First, install J1 and J2 in the top of the box. Then slip the module into the box and secure it to the front with screws and lockwash-

ers. Mount S2 on the top of the box, too. Snap in S1 and wire it up. Install the battery pack and wire it up to the other side of S2 and ground. Finish up the job by wiring up J2 and C1 to

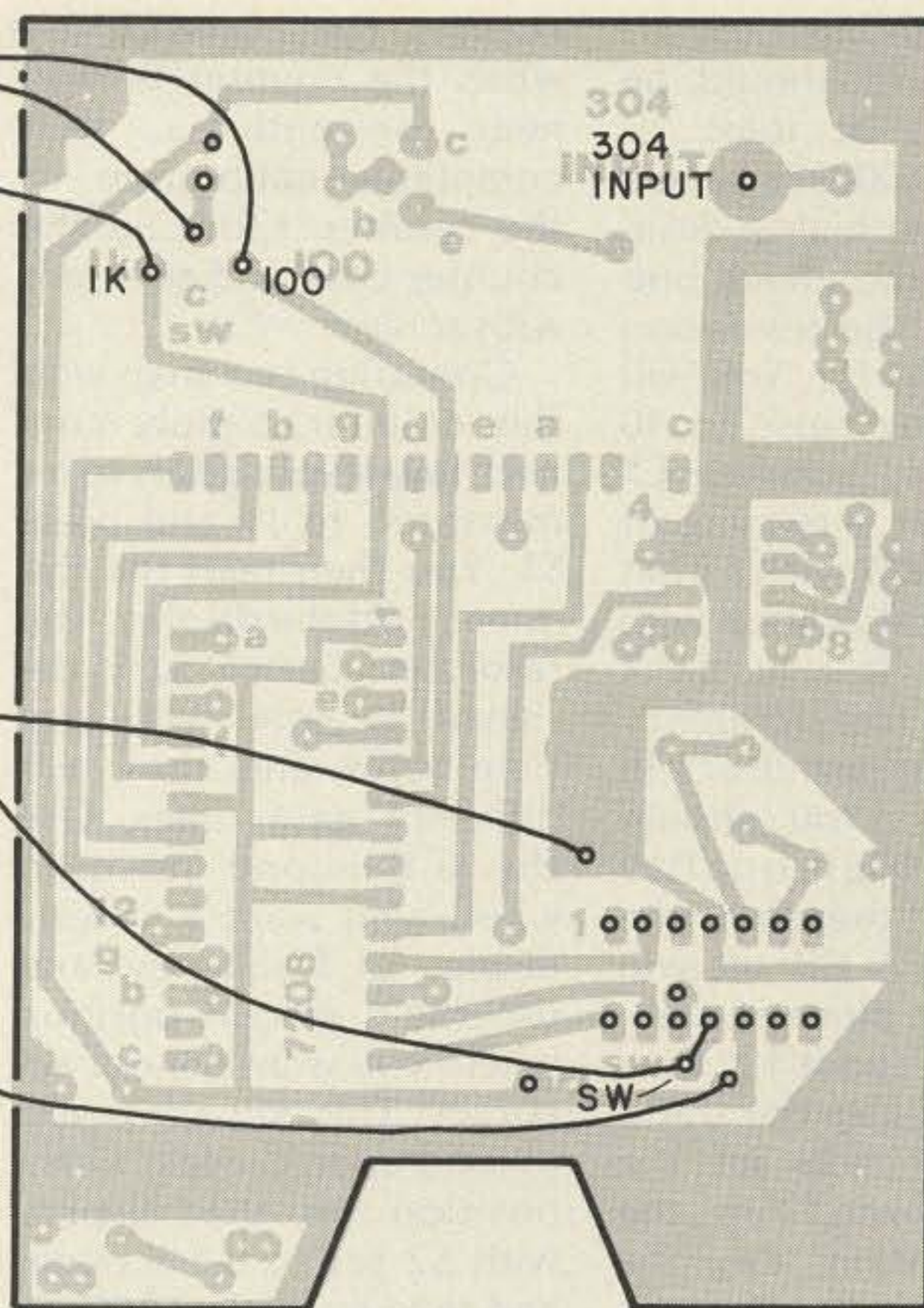

Fig. 7. Rear view of PC board showing switch wiring.

J1. Don't close up the box until you finish calibration. Charge up the batteries and you are all set!

### Calibration and Operation

There are several ways

to calibrate your counter, with the simplest being to measure a known frequency. This is how I calibrated the model 304 counter. Connect a signal of 50 mV or so at 10 MHz from a fre-

### Supplier List

Item	Factory	Distributor
IC1-National DS-8629	National Semiconductor 2900 Semiconductor Dr. Santa Clara CA 95051	Tri-Tek, Inc. 7808 North 27th Ave. Phoenix AZ 85021 (602)-995-9352
IC2-IC3 Intersil ICM-7208IPI and ICM-7207AIPD. Note: These parts come as a set	Intersil, Inc. 10900 Tantau Ave. Santa Clara CA 95014	Poly Paks, Inc. PO Box 942 S. Lynnfield MA 01940 Stock #92CU4079 (617)-245-3828
Y1—5.24288 MHz crystal	JAN Crystals 2400 Crystal Dr. Ft. Meyers FL 33901 (813)-936-2397	JAN Crystals
DIS1—H-P display	Hewlett-Packard, Inc. Optoelectronics Div. 1501 Page Mill Rd. Palo Alto CA 94304	Poly Paks, Inc.
C7—20 pF trimmer cap	Sprague, Erie, etc.	Tri-Tek, Inc. Stock# CAP9308
Case—LMB-CR-531	Heeger, Inc. 725 Ceres St. Los Angeles CA 90021	

Note on the "Factory" column: These people should be contacted *only* for a local distributor; only JAN Crystals will sell small quantities of parts to individual users.

quency standard to J1. Your standard should be accurate to at least  $\pm 0.001\%$ ;  $\pm 0.0005\%$  or better would be highly desirable. Press the check button and set the resolution switch to 100 Hz. You will get a reading close to 10 MHz. Adjust trimmer C7 until you get a reading of exactly 10.000 MHz. That completes calibration with a standard. If you don't have access to a frequency standard, a transmitter will do as well. You should have a high-quality counter to measure the transmitter. A CB set will do. Attach a piece of coat-hanger wire about 12" long to J1. Then key the transmitter after you set the resolution switch to the 100-Hz position. Key the transmitter in brief steps and do not modulate it. A walkie-talkie is ideal for this since little power is necessary. Adjust C7 until the counter reads the exact

transmitter frequency when the counter is held near the antenna. That completes calibration of the counter. Close up the counter case and secure it with screws.

Operation is a snap with this counter. Simply connect low-level signals to be measured to J1 and press S1. You then read the frequency off the display. The resolution switch, S2, is designed to offer you two time bases, and, thus, two different gate times. Use the 0.1-second position where you want a speedy display of frequency, and use the 1-second position where you want greater accuracy. This will allow you to read up to the last 1 kHz position on the display with S2 set to 0.1 second, and read to the last 100 Hz position with S2 set to 1 second. As you can see, each has advantages.

A few tips on using this counter: You might want to

fabricate a 12" whip antenna out of a male BNC connector and a piece of coat-hanger wire. Epoxy the wire inside the plug. With this setup, you should be able to measure a 100-mW CB walkie-talkie at least 15 feet away. If you performance-select IC1, this

counter will cover the 2 meter ham band. Finally, whenever you measure a transmitter or signal generator, be sure to operate it in the unmodulated mode, or SSB units in the CW mode. This will give you maximum accuracy in your measurements. ■

#### Model 304 Counter Specifications

1. Accuracy: Adjustable to up to  $\pm 0.0002\%$  or better, short term. Also  $\pm 1$  count error on all measurements.
2. Frequency Range: From below 1 MHz to over 135 MHz.
3. Gate Times: Switched 1 second or 0.1 second. Display correspondingly updated 2 seconds or 0.2 seconds respectively.
4. Input: About 500 Ohms at low signal levels (below 0.5 volt).
5. Power requirements: 5 V dc at 130 mA, no signal. Power supplied by nicad batteries.
6. Resolution: 100 Hz and 1 kHz of the measured frequency.
7. Sensitivity: Typical rms sine wave sensitivity for stable count is 55 mV at 1 MHz, 4 mV at 27 MHz, 5 mV at 50 MHz and 12 mV at 135 MHz.
8. Special Features: Hand-held portable unit. Diode-protected input, easy construction, long battery life, etc.
9. Display: 0.105" LED calculator-type with 7 digits.

#### PC Boards

The PC board (stock #STGM-279) for this project is available for \$5.60 (drilled) or \$4.00 (undrilled) from O. C. Stafford Electronic Development, 427 South Benbow Rd., Greensboro NC 27401. Add \$1.00 for shipping.

#### Parts List

- B1—4 "AA" Nicad batteries in square holder  
 C1—0.1-uF, 200-volt Mylar capacitor  
 C2, C3, C4, C6—0.01-uF, 50-volt disc capacitors  
 C5, C10—0.1-uF, 25-volt disc capacitors  
 C7—6-to-20-pF trimmer  
 C8—27-pF mica capacitor  
 C9—100-uF, 6.3-volt electrolytic  
 D1, D2—1N4148 diodes  
 D3—1N4002 rectifier diode  
 IC1—National DS-8629N VHF prescaler  
 IC2—Intersil ICM-7208IPI counter chip\*  
 IC3—Intersil ICM-7207AIPD timebase controller chip\*  
 J1—BNC connector, UG-1094, Amphenol 31-221  
 J2—RCA jack  
 Q1—2N3905 PNP silicon transistor
- Resistors: All resistors 1/4-Watt film except for R12.
- R1—47-Ohm resistor  
 R2 through R8, R11—470-Ohm resistors  
 R9—10k resistor  
 R10—15k resistor  
 R12—100-Ohm, 1/2-Watt resistor  
 S1—SPST Push-button switch  
 S2—DPDT miniature toggle switch  
 DIS-1—Hewlett-Packard 5082-7441 9-digit LED display, "Industry Standard" calculator LED display, Poly Paks 92CU2954, or similar.  
 Y1—5.24288 MHz crystal in HC-18/U holder with wire leads. Loading capacitance is 12 pF, accuracy is  $\pm 0.005\%$  at room temperature.  
 Misc.—9-volt ac/dc battery charger with RCA plug, PC board, Bezel, 3/8" spacers (4 each), LMB CR-531 case, 4-40 screws, wire, etc.
- \*Available from Poly Paks as a set. Stock #92CU4079.

## MADISON DOUBLE YOUR WARRANTY POLICY

Any large piece of gear we sell you (average \$300 or up) we will **double** your warranty period!

FOR EXAMPLE: A 3 month warranty = 6 months from date of purchase. 1 year = 2 years from date of purchase.

*(OUR RELIABLE SERVICE DEPARTMENT REPAIRS NON-WARRANTY GEAR, TOO!)*

Simply send your rig in a good shipping carton, postage prepaid, with a copy of your receipt showing date of purchase. We will repair promptly and return by best way.

NOTE: Manufacturers do not cover final in most cases, but we will try!

### Try Our Competitive Prices, Too!

You, the customer, can only benefit from the **Madison Double Your Warranty Policy**.

Call **Don - K5AAD** or **Mike - W5VVM** for specific warranty claim questions.

POLICY SUBJECT TO CHANGE WITHOUT NOTICE  
DOES NOT COVER SPECIALS OR CLOSEOUTS.



**MADISON**  
Electronics Supply, Inc.

1508 McKinney, Houston, TX 77002, 713/658-0268

✓ M35



S-f Amateur Radio Services

(213) 837-4870

4384 KEYSTONE AVE.,  
CULVER CITY, CA. 90230

### the W6TOG

RECEIVER MODIFICATION KITS

INCREASE SELECTIVITY

IMPROVE SENSITIVITY

LOWER INTERNAL NOISE

COMBAT BLOCKING  
FROM LOCAL SIGNALS

TS-520 KIT	\$27.50
TS-520S KIT	32.50
TS-820 & 820S KIT	34.50
TS-820 MIXER KIT	27.50
TS-120S KIT	32.50
R-820 KIT	34.50
FRG-7000 KIT	32.50
FT-101 SERIES KIT	32.50
FT-101ZD KIT	34.50
FR-101 SERIES KIT	34.50
FT-301 SERIES KIT	34.50
FT-901 SERIES KIT	34.50
ATLAS-210 OR 215X KIT	34.50
ALDA-103 OR 105 KIT	32.50

\*

### MAGICOM PROCESSOR MODIFICATION KIT

INCREASES AUDIO PUNCH

IMPROVES

PROCESSED SPEECH QUALITY

TS-520/S	42.50
TS-820/S	27.50

NEW

TS-120/S	42.50
DRAKE T4XC	52.50
DRAKE TR7	42.50

The "MAGICOM" provides up to 6dB increase in output with smooth, clean, non-distorted audio and more penetration for those pile-ups. Easy installation. (No front panel alteration)

\*

### HI POWER KITS

INCREASE OUTPUT POWER BY 30%

Set of (2) 6146-W final tubes  
Plate rating 40W per tube

GET MORE DRIVE FOR  
THOSE HI POWER AMPLIFIERS!!!

TS-520 / 520S QRO KIT	\$39.50
TS-820 / 820S QRO KIT	39.50

10% OFF ON KIT ORDERS  
TOTALING \$75.00 OR MORE

\*

SEND FOR PRICING  
AND INFORMATION ✓ S33

ALL PRICES POSTPAID  
IN CALIF. ADD 6% SALES TAX  
MASTERCARD & VISA ACCEPTED  
SATISFACTION GUARANTEED  
OR MONEY REFUNDED

# WHY ARE ANTENNA MAKERS ANGRY ABOUT THE NEW AEA ISOPOLE™?

Introductory Price:  
Isopole 144 - \$49.95  
Isopole 220 - \$44.95

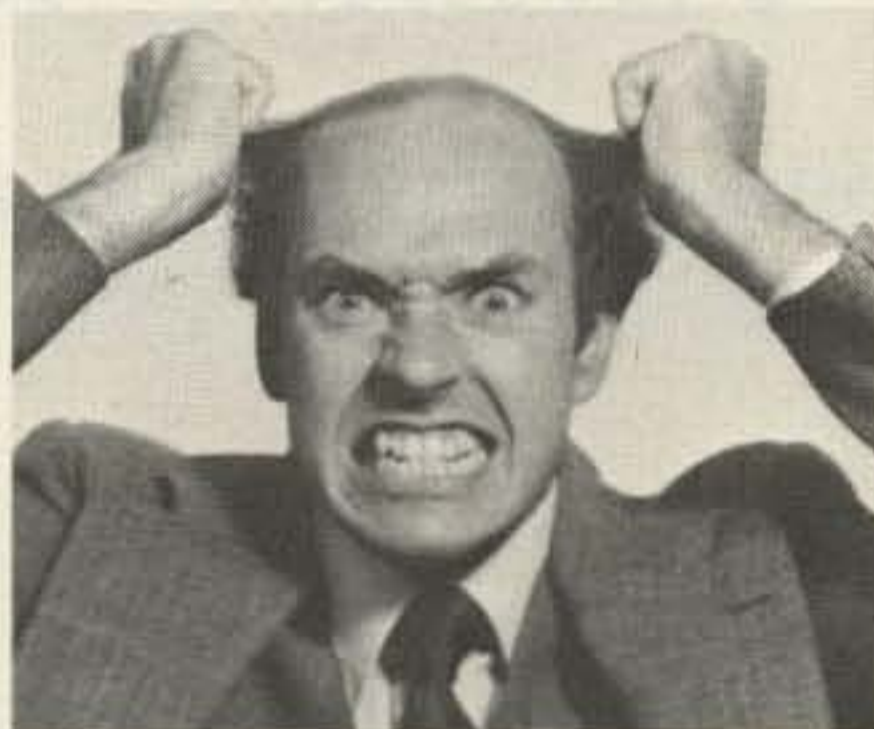

For the first time, ham operators are finding out just how poorly designed most vertical, omnidirectional VHF antennas really are.

AEA university level research has proven that most antennas now being offered create unwanted coupling of RF currents onto the antenna support structure and coaxial feedline shield from the transceiver.

Proper design and decoupling on the new AEA ISOPOLE™ virtually eliminates the RF spillover problem and can help you achieve the maximum attainable gain for the size of the antenna—equivalent to doubling your power in all directions on the horizon relative to an ideal half-wave dipole, or 6 db gain over a typical one quarter wavelength groundplane antenna. The most popular 2 meter omnidirectional "gain" antennas are unable to achieve the gain figures for an ideal half-wave dipole, resulting from poor feedline decoupling.

### Plus! The new AEA ISOPOLE™:

- requires no tuning.
- is easy to assemble.
- covers a bandwidth nearly double the two meter ham band.

- has less than 2:1 SWR over the entire 2 meter band.
- has a beam pattern independent of feedline length.
- requires no ground plane.
- features completely weather protected RF connections.
- is designed for maximum legal power.
- mounts easily on a standard TV mast. (TV mast NOT supplied by AEA)

### Prove it to yourself.

Let us send you a design for a simple tester you can use to see just how much RF spillover is coming off your own equipment.

The design is included in a copy of our free booklet: **FACTS ABOUT PROPER VHF VERTICAL ANTENNA DESIGN**. To get your copy, or information about ordering an AEA ISOPOLE™, write or call Advanced Electronic Applications, Inc., P.O. Box 2160, Lynnwood, Washington 98036. Call 206/775-7373.



✓ A94

# AEA

Brings you the  
breakthrough!

# A Versatile, Variable Active Filter

— dc switching and 8-pole response make this one a winner on RTTY or CW

Eric J. Grabowski WA8HEB  
30312 Arnold Road  
Willowick OH 44094

Recently, my interest in RTTY operation was rekindled. The thought of using the existing tube-type terminal unit, however, was not a pleasant one. A rework of the terminal unit seemed appropriate.

A good place to start was replacing the bulky LC filters with active filters. Although many active filter circuits have been described in previous articles,

none was exactly what I needed. Consequently, the circuit presented here was developed. The application is not limited to RTTY; with some value changes it can be used for CW reception or other uses where it is desired to pass a single frequency while rejecting all others.

## Design Goals

After some initial brainstorming, the following list of objectives was prepared:

1. Ultimate selectivity should be less than 100

Hertz, but some intermediate choices should be available.

2. Minimize power consumption. Single supply operation. Operation consistent over a wide range of supply voltage.

3. Some type of dc-switching technique should be used for selectivity selection to simplify wiring and provide for future control by microprocessor.

4. Capability to bypass the filter altogether.

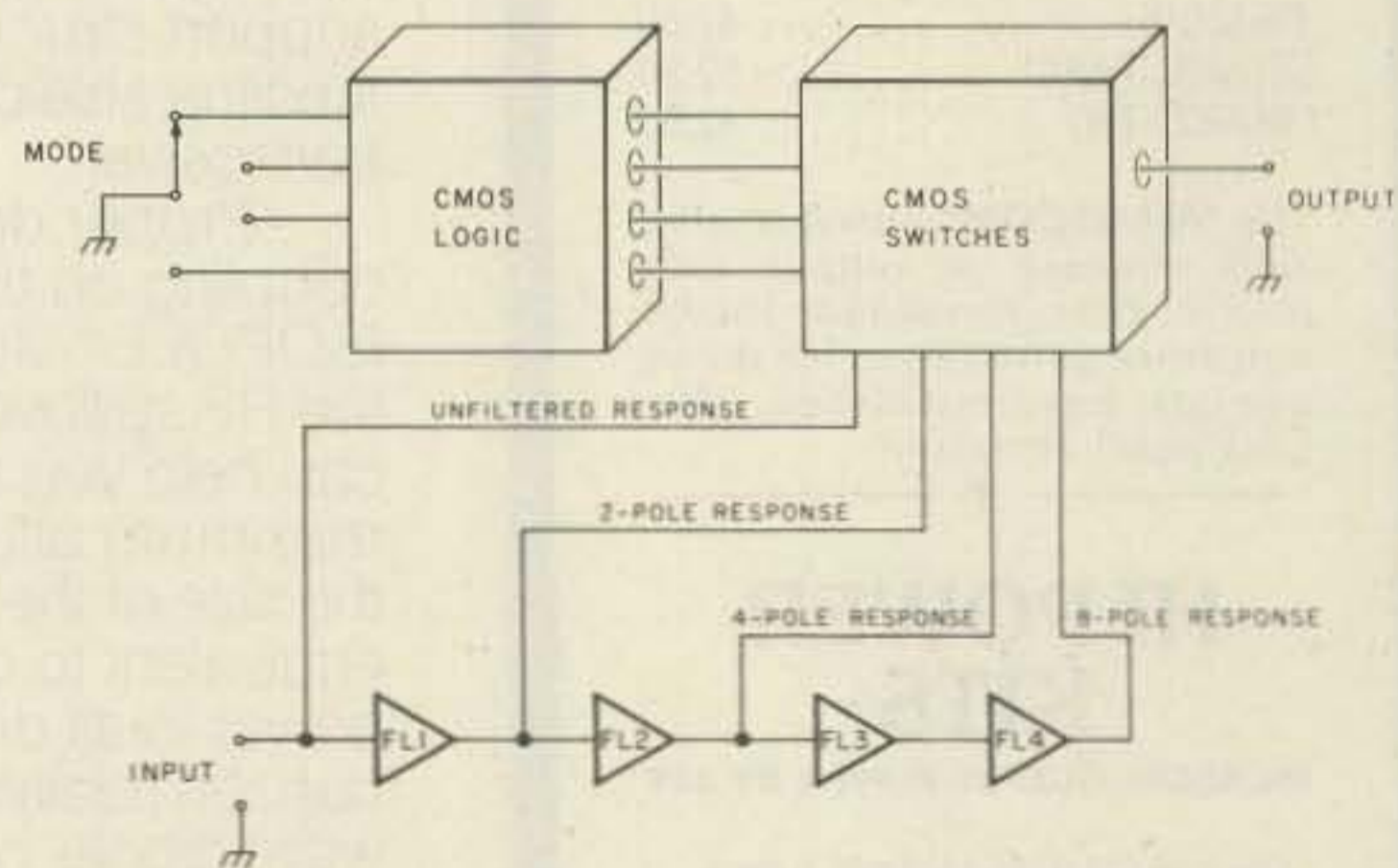
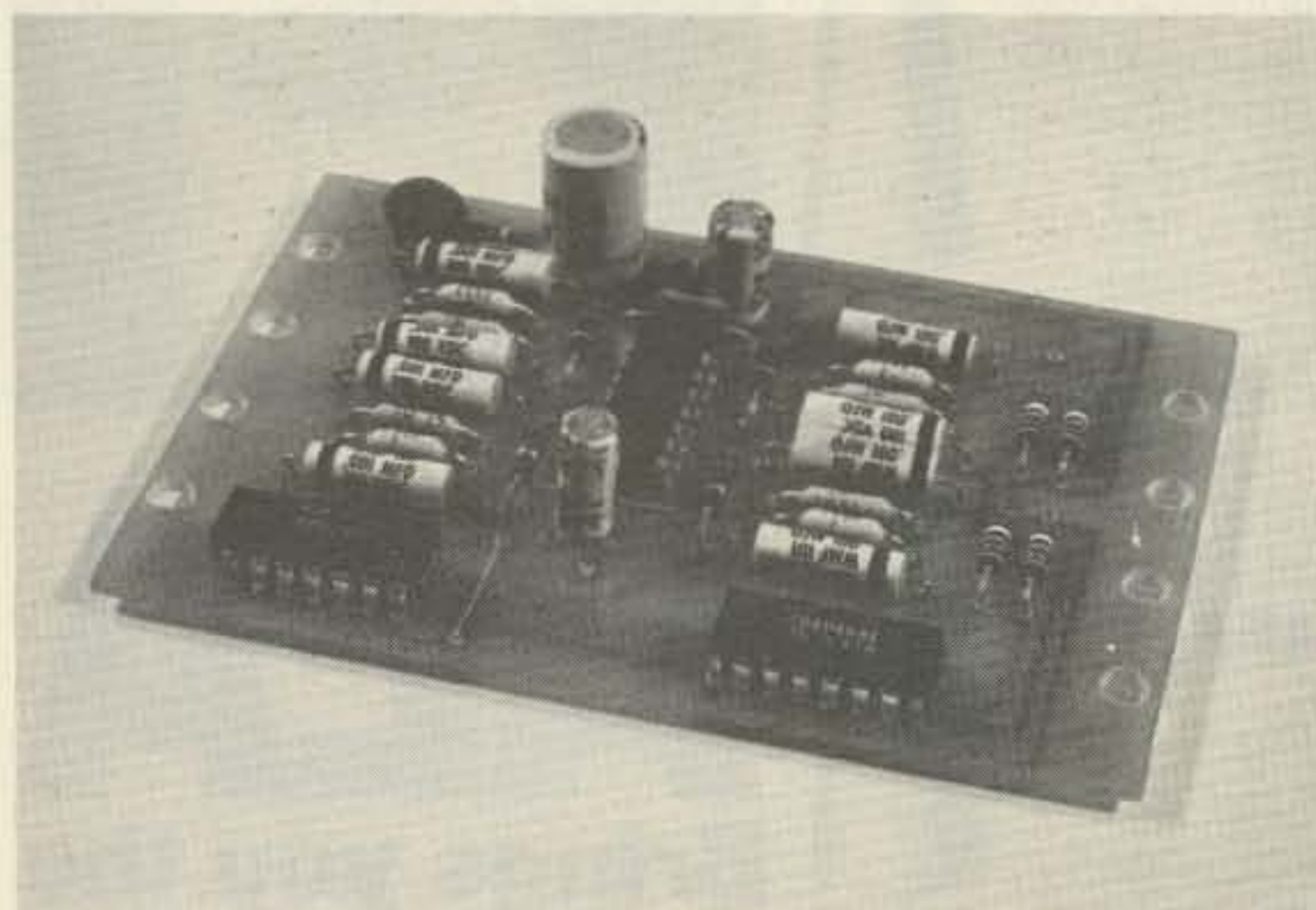

Fig. 1. Block diagram illustrating the concept of dc switching. Wires to the remote mounted switch carry dc levels only. Stray currents induced into these wires will not degrade the filter performance.



Active filter.

Center Frequency	R1—R4	R5—R8	R9—R12	Comment
2975 Hz	220k	430k	6.8k	RTTY Space (850 Hz shift)
2295 Hz	270k	560k	9.1k	RTTY Space (170 Hz shift)
2125 Hz	300k	620k	10k	RTTY Mark
750 Hz	820k	1.8 Meg	27k	CW

Table 1. Active filter resistor values.



## Filter Circuit

The LM324 quad operational amplifier was selected for the filter circuit. Each of the op amps is configured as a two-pole active filter and cascaded in a daisy chain fashion. Each stage has a Q of about 4, unity ac gain, and a center frequency determined by the R and C values chosen. The outputs of all op amps except the third are applied to the switching circuitry. The decision not to use the third output was arrived at experimentally, and experience has proved this to be a wise choice.

Table 1 identifies the values of resistors used for the RTTY mark and space frequencies. Values are also shown for a CW filter centered at about 750 Hertz. (C1 - C8 = 0.001uF)

For best results, the frequency-determining capacitors should be a high-stability type. Cornell-Dubilier series WMF is a good choice, and they are readily available.

If you want to use the filter on some other frequency, the R and C values will have to be calculated from formulas. Since there are more standard resistor values than capacitor values to choose from, it is usually more convenient to arbitrarily select a capacitor value and then use the nearest standard value resistors.

## Dc Switching Circuit

Two complementary MOS integrated circuits comprise the dc switching circuit. A CD4049 hex inverter is used to drive the control inputs of the CD4016 quad analog switch.

A pull-up resistor normally holds each hex inverter input at the positive supply voltage. This forces the inverter output and the associated control input to ground potential. As long as the control input is grounded, the switch ap-

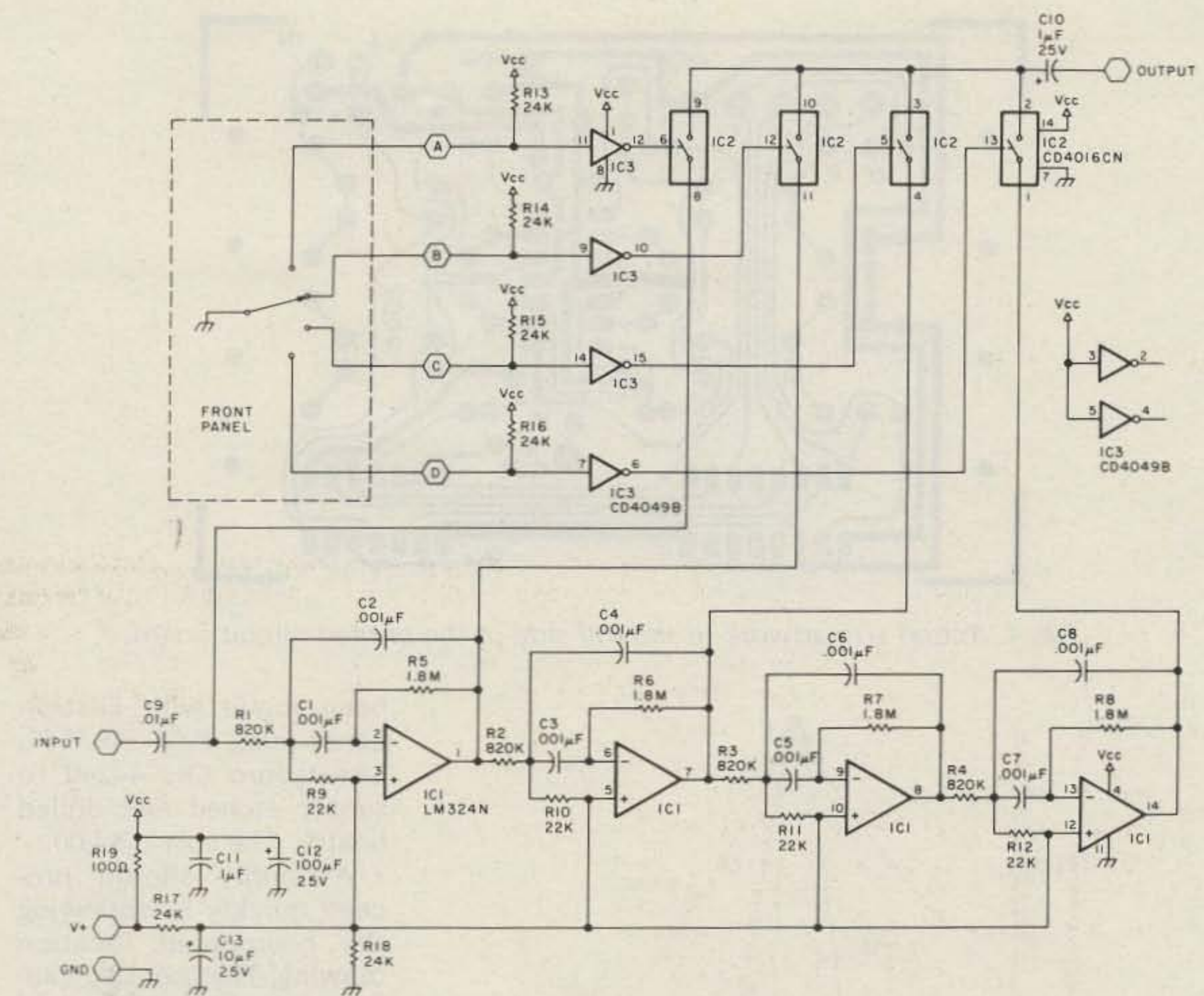

Fig. 2. Schematic of the active bandpass filter using dc switching for bandwidth selection. See table for values of frequency determining components.

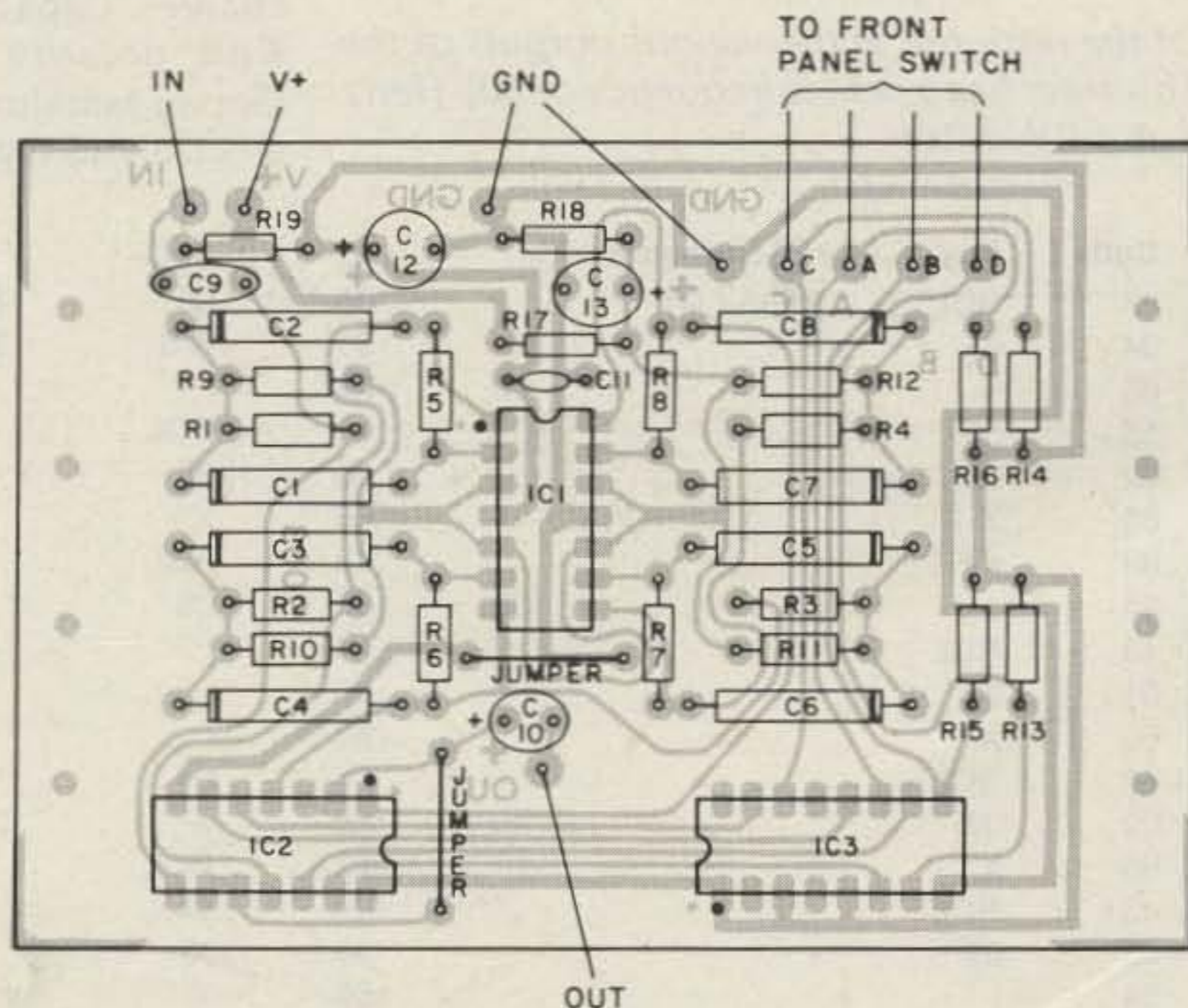

Fig. 3. Component placement drawing. A dot is placed near pin 1 of all integrated circuits for identification.

pears open. A four-position rotary switch is used to select which switch is closed by grounding the appropriate pull-up resistor.

Since there are only four switches in the IC package,

and the unfiltered input uses one of them, one of the filter outputs had to be sacrificed. The output of the third filter seemed to be the least useful; consequently, it was deleted

## Construction

The circuit was built on a printed circuit board 3-5/8 by 2-1/2 inches from the artwork shown. For those of you unable to roll your own, arrangements have

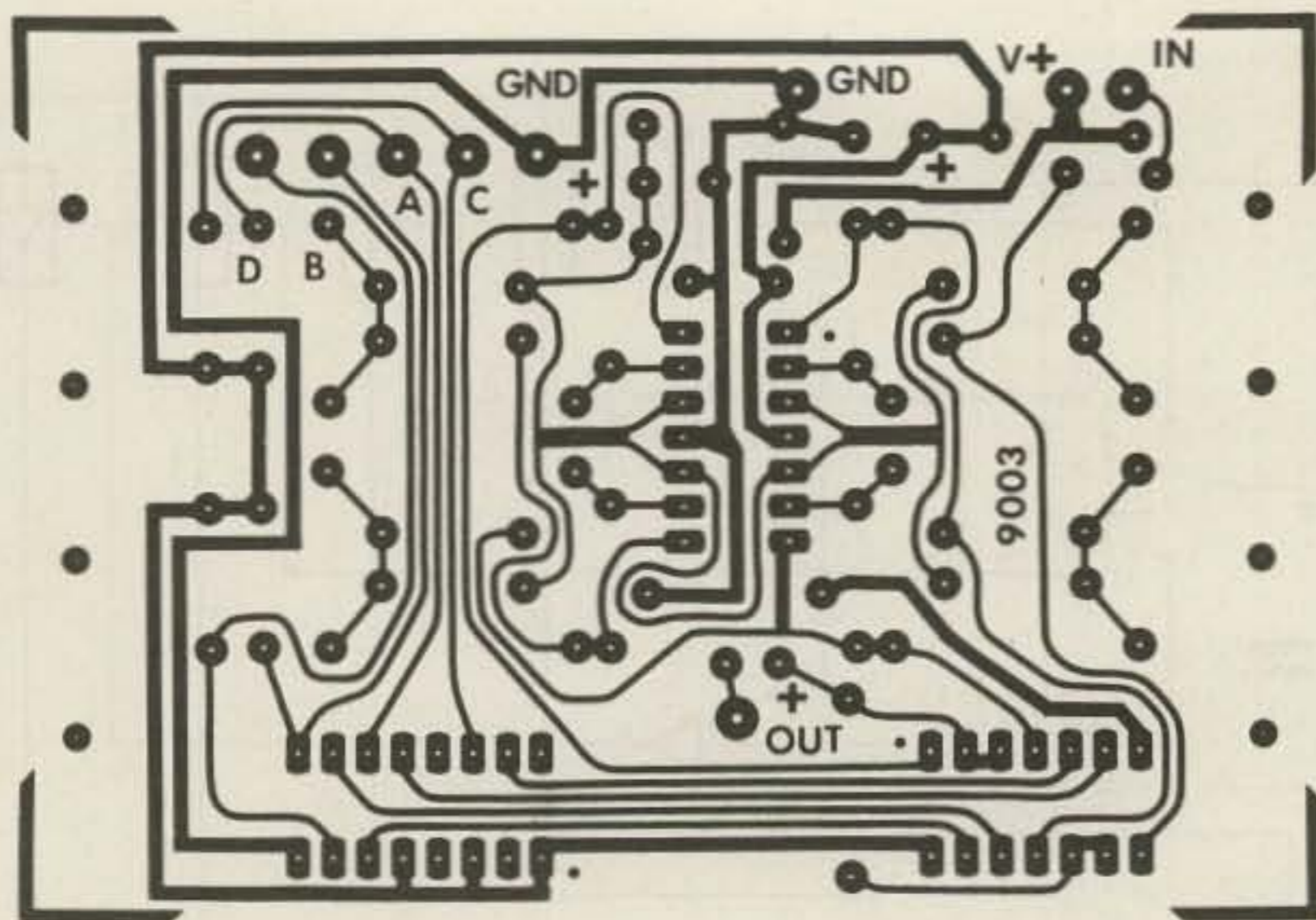

Fig. 4. Actual size artwork of the foil side of the printed circuit board.

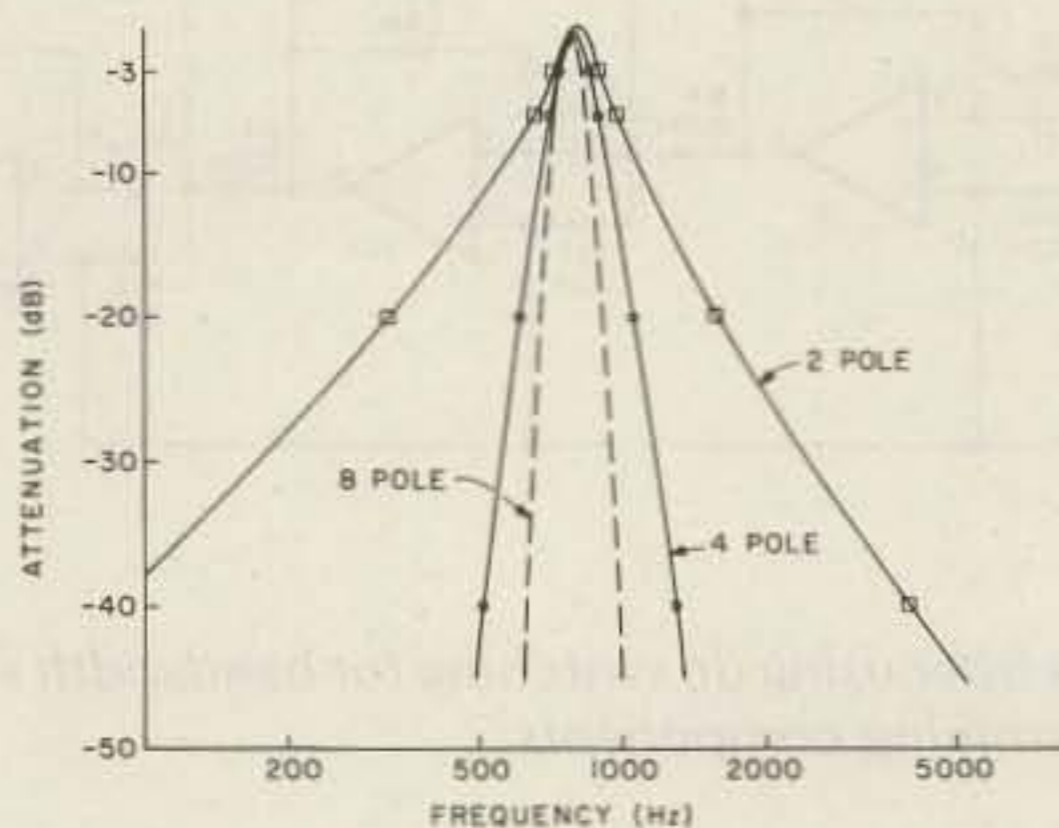

Fig 5. Graph of the response at the various outputs of the active filter. This filter has a center frequency of 800 Hertz and was used as a CW filter.

Loc	Code	Key	Comments			
0	43	RCL	Find R1	42	STO	
	04	04		06	06	R3
	55	+	30	91	R/S	Find R2
	53	(		53	(	
5	02	02		43	RCL	
	65	X		05	05	
	89	$\pi$		65	X	
	65	X	35	43	RCL	
	43	RCL		06	06	
	01	01		54	)	
10	65	X		55	+	
	43	RCL		53	(	
	02	02	40	04	04	
	65	X		65	X	
	43	RCL		43	RCL	
15	03	03		04	04	
	54	)		33	X <sup>2</sup>	
	95	=	45	65	X	
	42	STO		43	RCL	
	05	05	R1	05	05	
20	91	R/S	Find R3	75	-	
	65	X		43	RCL	
	02	02	50	06	06	
	65	X		54	)	
	43	RCL		95	=	
25	02	02		42	STO	
	95	=		07	07	R2
				91	R/S	END

Fig. 6. TI-58/59 program coding for determining the frequency dependent components.

When the assembly phase is over, double-check the polarity of polarized capacitors and make sure there are no solder bridges across adjacent foils.

### Operation

The dc power supply voltage is not critical. Any voltage between 3 and 15 volts will suffice. With power applied, check the voltage on pin 3 of the LM324. It should be very close to half of the supply voltage. If it is not, the output waveform will be clipped, causing distortion.

Both the input and output of the filter are ac-coupled, so there is no need to worry about disturbing the bias voltages of the preceding and succeeding stages of the equipment the filter is used with. In order to maintain a linear response though, the level of the input signal must be less than the dc supply voltage. For example, if a 12-volt supply is used, the peak-to-peak input voltage must be less than 12 volts.

For RTTY operation, two circuit boards are required. One for the mark frequency and another for the space frequency. If desired, a ganged rotary switch can be used to select the bandwidths of both channels simultaneously.

### Conclusion

The graph illustrates the

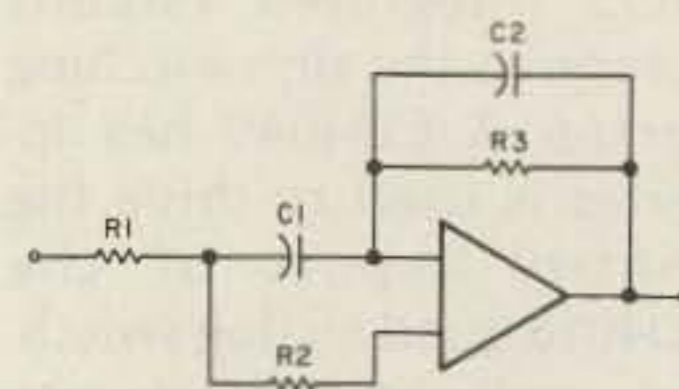

Fig. 7. Program description. Given center frequency ( $f$ ), gain ( $A$ ), desired  $Q$  ( $Q$ ), and capacitance ( $C1$ ), find values for  $R1$ , then  $R3$ , then  $R2$ . Equations:  $C1 = C2$ ;  $R1 = Q/2\pi f A C1$ ;  $R3 = 2AR1$ ; and  $R2 = R1R3/4Q^2R1 - R3$ .

Step	Procedure	Enter	Press	Display	
0	Initialize				0 Not used
1	Load program				1 f
2	Enter center freq in Hertz	f	STO 01	f	2 A
3	Enter gain in units	A	STO 02	A	3 C1
4	Enter capacitor value in uF	C1	STO 03	C1	4 Q
5	Enter value for Q in units	Q	STO 04	Q	5 R1
6	Find R1; STO-05		RST R/S	R1 megohms	6 R3
7	Find R3; STO-06		R/S	R3 megohms	7 R2
8	Find R2; STO-07		R/S	R2 megohms	

Fig. 8. User instructions.

bandwidths obtained and the selectivity achieved. Ultimate bandwidth is

about 80 Hertz, which satisfied the design goal. All the other goals were met as

well. Current draw is about 2 milliamperes. Since all audio signals are con-

tained on the board, long, unshielded hookup wire can be used between the board and the switch without degrading the performance. ■

Fig. 9. Data registers.



There's a new, eighth OSCAR satellite in orbit, and the AMSAT team helped put it there!

Your help is needed for future satellites. Join AMSAT and support the new, advanced Phase III series of OSCARs, engineered to provide communications over transcontinental distances for hours at a time.

Send \$10 membership dues to AMSAT, P.O. Box 27, Washington, D.C. 20044. Life membership is available for a tax-deductible donation of \$100 or more, payable in quarterly installments if you wish.

Phase III satellite solar cells may be sponsored for \$10 each, and we'll send you a certificate specifying the cells you are sponsoring.

For a tax-deductible contribution of \$1,000 or more, we'll even inscribe your name on a plaque to be placed in orbit aboard the Phase III spacecraft for posterity, and we'll send you a replica honoring your contribution.

Dues and contributions may be charged to VISA or Master Charge. Phone us at (202) 488-8649.

Radio Amateur Satellite Corporation  
P.O. BOX 27, WASHINGTON, D.C. 20044

**AMSAT**

AMSAT MEMBER

## The Iambic Keyer Paddle.

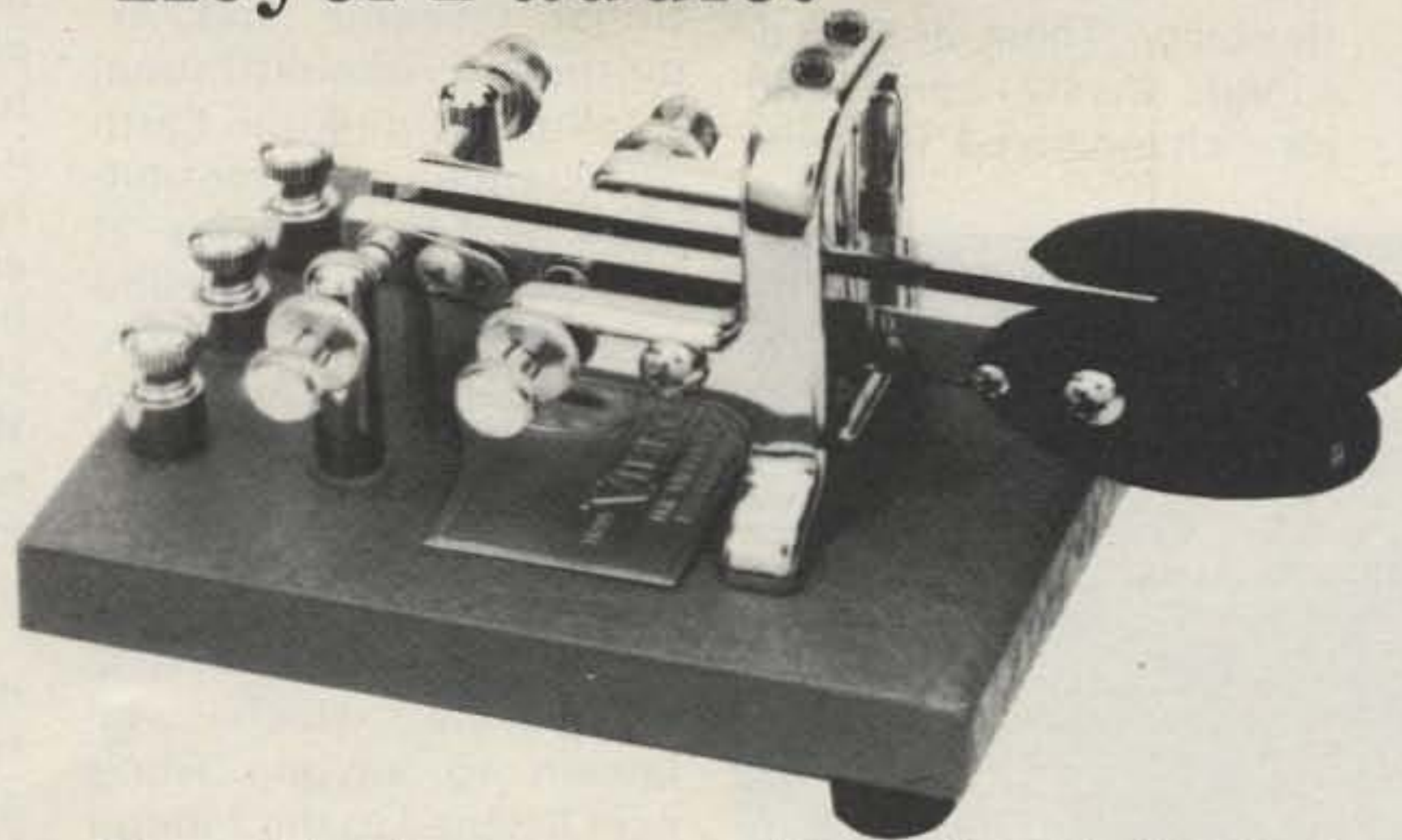

Our newest keyer paddle was designed in response to your request for an iambic paddle with the famous Vibroplex quality and features built right in.

Features include:

- Adjustable jeweled bearings
- Tension and contact spacing fully adjustable
- Large, solid, coin silver contact points
- 2½ lb. chrome plated steel base rests on non-skid feet
- Lifetime guarantee against manufacturing defects.

"Standard" model with textured gray base available for \$49.50, "Deluxe" \$65.00. Available at your dealers or through the factory. Send check or money order, or use your VISA or Master Charge. We pay all shipping charges except on orders outside the continental U.S.



P.O. Box 7230  
476 Fore Street  
Portland, Maine 04112  
Telephone: (207) 775-7710

✓ V24

# Variable Tuning for WEFAX Receivers

## — why be rockbound?

In recent years, literally thousands of radio amateurs have discovered the thrill of recovering weather facsimile (WEFAX) images from orbiting satellites. Their efforts and accomplishments have been well-documented in numerous articles—some are listed below as references nos. 1-9—and in at least one excellent book.<sup>10</sup>

Until recently, the majority of weather satellites transmitted VHF-FM images in the 137-MHz region, and enterprising hams have employed their characteristic ingenuity to recover these signals at

minimum expense. Receivers which have been successfully modified for WEFAX reception include various Motorola and GE high-band commercial receiver strips, police scanners from Bearcat, Regency, Realistic, and others, monitor receivers such as those sold by Vanguard, Heathkit, Hamtronics, VHF Engineering, and others, and a limitless variety of 2 meter FM receivers.

One characteristic which all of the above receivers share is the lack of tuning flexibility. These are fixed-tuned, crystal-controlled (or "channelized") receivers

which, when crystallized and tweaked for WEFAX reception, allow no fine-tuning adjustments. In satellite work, however, manual tuning often spells the difference between marginal and exceptional images (see the accompanying photographs). The purpose of this article, then, is to outline a method of adding frequency tuning to VHF-FM receivers used for weather satellite work.

### Why a Tunable Receiver?

Consider an NOAA (National Oceanic and Atmospheric Administration) satellite orbiting the Earth at 900 miles and transmitting weather pictures at 137.5 MHz. As the satellite appears on the horizon, races overhead, and then drops off beyond the opposite horizon, its frequency, as received on the ground, is forever changing. This characteristic Doppler shift, which is well known to anyone who's ever listened to the 2-meter downlink signal from OSCAR VII (Mode B), may amount to several kHz during an overhead pass.

One way to keep the satellite's signal within the receiver's passband is to widen the receiver's i-f bandwidth by the amount of anticipated Doppler shift. But the signal-to-

noise ratio (SNR) of the recovered signal is in part a function of the i-f bandwidth. That is, widening the passband response of the receiver admits additional noise, which degrades signal quality.

A costly, though effective, alternative is to keep the receiver narrow, but add an automatic frequency control (afc) loop. The receiver will then lock on to the incoming signal and track it across the spectrum—that is, assuming the receiver is able to acquire the signal in the first place. One disadvantage to afc is that if the receiver loses the signal momentarily due to fading, interference, or whatever, it may be unable to reacquire the signal quickly enough. While searching for a signal to lock on, the system may lose a substantial portion of the transmission.

If an operator is present during reception, manual tuning overcomes the above problem. An operator's search-and-acquire time is minimal (just notice how quickly the pileup materializes when a rare DX station shows up on frequency!), and the operator need only tune to keep the discriminator meter centered once the satellite is acquired.

Consider now the case of receiving signals from



A weather satellite image received with the incoming signal at the edge of the receiver's passband (some 15 kHz off the frequency).

the new generation of geostationary weather satellites.<sup>11,12</sup> Here the satellites are in an eastward orbit above the equator, completing one orbit every 24 hours. Thus, to an observer on the ground, the satellite appears to hover motionless in space. This orbit not only minimizes tracking difficulties, but also eliminates relative motion between the satellite and the observer, thus eliminating the Doppler shift problem.<sup>13</sup>

On-frequency reception of the new geostationary satellites (the United States' GOES E and GOES W, Japan's GMS, and the European Space Agency's METEOSAT) presents other difficulties, however. These satellites transmit WEFAX in the microwave spectrum, at 1,691 MHz. Since image format and modulation characteristics are similar to the transmissions from the earlier, polar-orbiting VHF satellites, reception of these new birds is generally accomplished by placing a heterodyne downconverter in front of an existing VHF satellite receiver.<sup>14,15</sup> And it is in the downconversion process that frequency problems crop up.

#### Converter Calibration

A crystal-controlled converter for reception of the microwave WEFAX transmissions might employ a local oscillator in the 1.5-GHz region, derived by multiplying up a stable crystal oscillator in the 130-MHz region (see Fig. 1).<sup>17</sup> A high quality overtone crystal will exhibit a room-temperature tolerance on the order of  $\pm 0.001\%$ , which is about five times better than the average ham-rig crystal. This sounds like high precision, but when applied to the 1.5-GHz LO injection frequency, represents a calibration ambiguity of 15 kHz! Since the typical

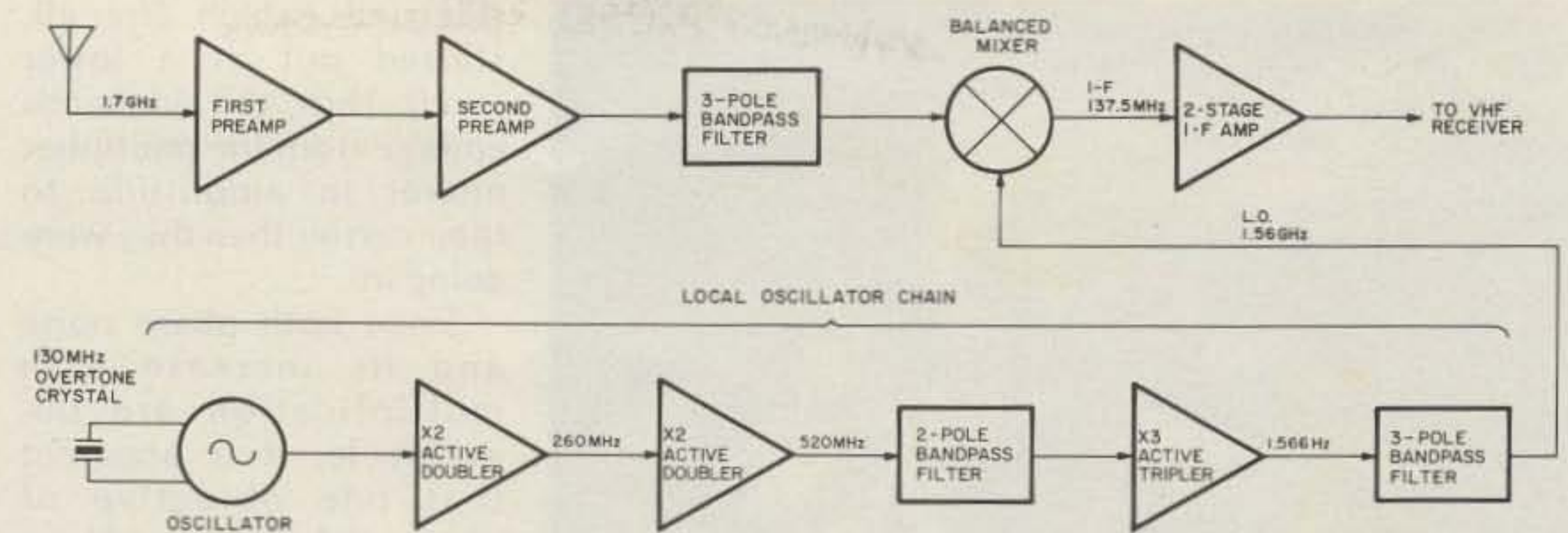

Fig. 1. Block diagram of the Microcomm Model RX-1691 integral WEFAX downconverter. The oscillator/multiplier string is typical of modern microwave receivers. For more information on this downconverter, send an SASE to Microcomm, 14908 Sandy Lane, San Jose CA 95124.

bandwidth of a VHF-FM receiver used as a weather satellite i-f would be on the order of 30 kHz, you can see that even a relatively well-calibrated crystal can easily result in the received signal being on the very edge of the receiver's passband.

Unless the converter's crystal oscillator is installed in a thermostatically-controlled oven, however, the problem doesn't stop there. Over the temperature range of  $-10^{\circ}\text{C}$  to  $+60^{\circ}\text{C}$ , the thermal tolerance of even a high-grade crystal will be on the order of  $\pm 0.002\%$ . Applied to the 1.5-GHz LO frequency required to downconvert microwave WEFAX to VHF, the frequency drift over temperature may be as much as 30 kHz, placing the received signal completely out of the receiver's passband.

Obviously, keeping the receiver "on frequency" with respect to the satellite is going to require some kind of tuning, either to the downconverter's LO or the VHF receiver. I maintain that the appropriate place to introduce tuning is in the VHF receiver. To understand why, it's first necessary to know a little about phase noise.

#### Phase Noise

An unavoidable characteristic of any crystal

oscillator, no matter how well engineered or fabricated, is that it will

always exhibit some degree of instability. This is evidenced by incidental

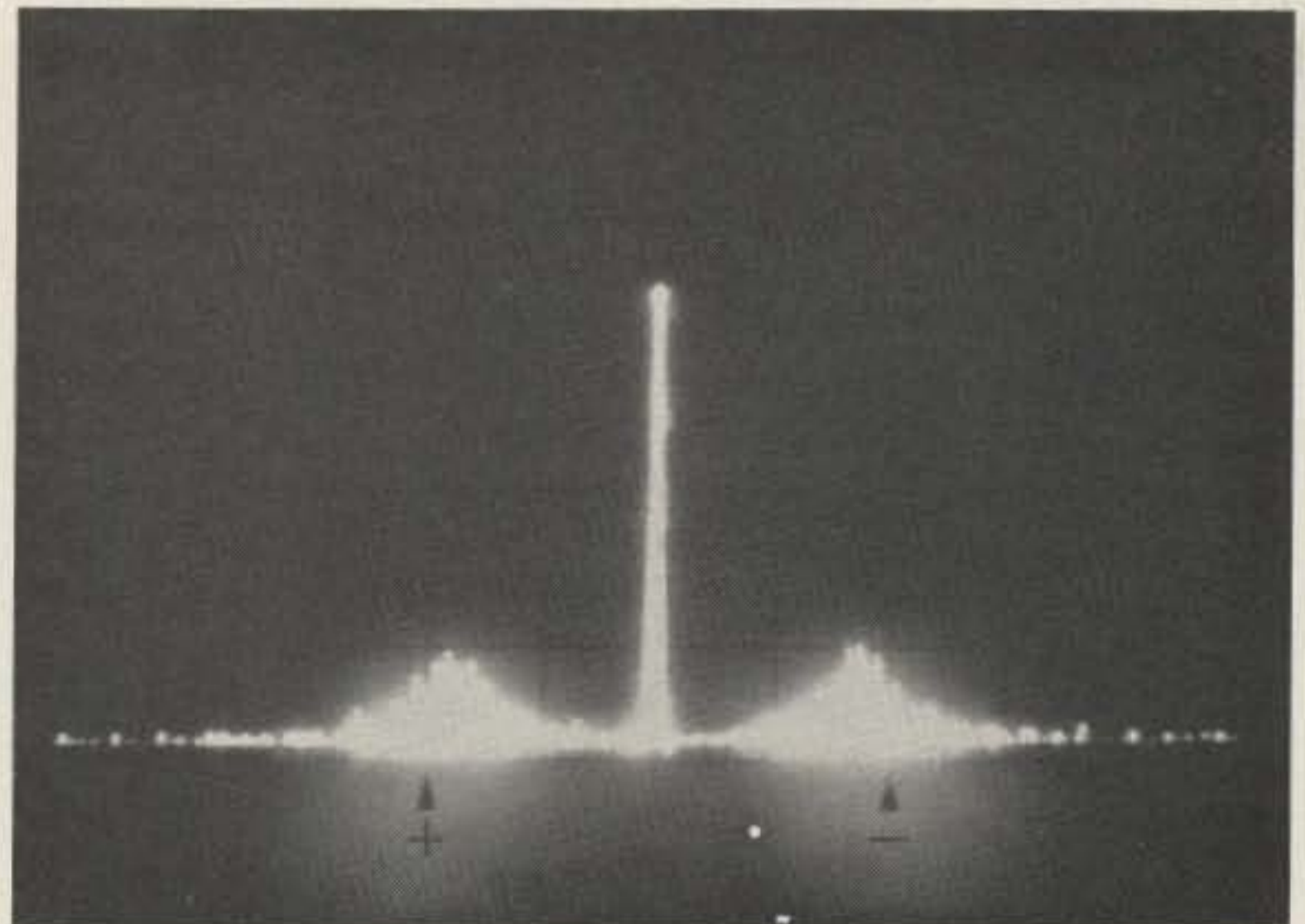

Fig. 2. A spectrum analyzer photo of a microwave local oscillator exhibiting excessive phase noise sidebands. This incidental FM results from excessive pulling of the crystal's frequency of oscillation, as discussed in the text.

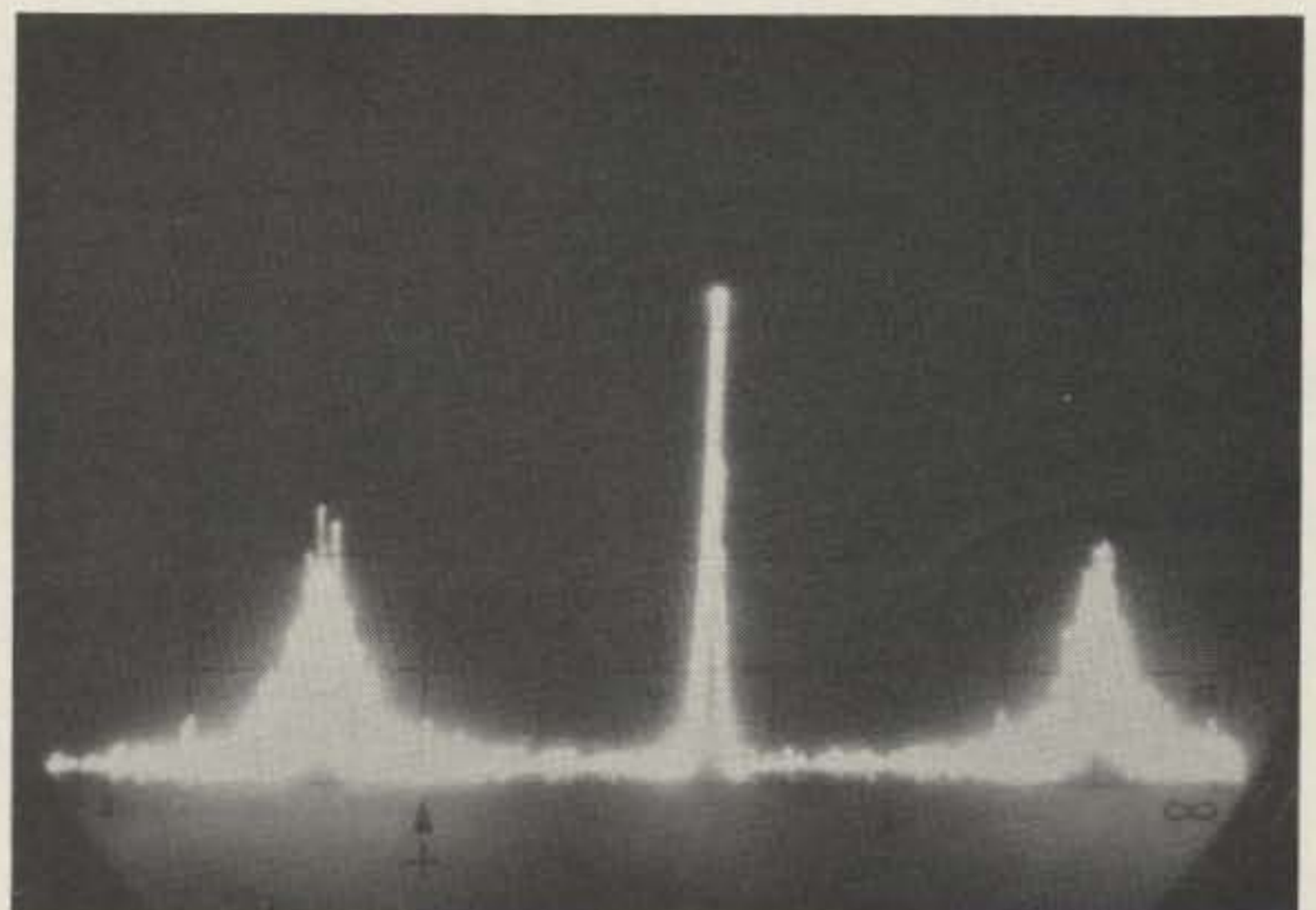

Fig. 3. This is the same LO chain shown in Fig. 2, after having been multiplied in an active doubler stage. Note that both sideband amplitude and deviation are increased, as discussed in the text.



A weather satellite image received with the signal centered in the receiver's passband. All other conditions were identical to those prevailing in the photo where the signal was some 15 kHz off frequency.

FM sidebands visible above and below the primary output frequency, when viewed on a spectrum analyzer (see Fig. 2). In achieving reception which is reasonably free from spurious responses, it is desirable to keep these sidebands (also known as phase noise) to a minimum.

Unfortunately, any time an oscillator's output is multiplied to a higher frequency (such as occurs in the microwave downconverter of Fig. 1), both the amplitude and the band-

width of phase noise will tend to increase. As illustrated by Fig. 3, phase noise bandwidth increases because, as a signal is multiplied in frequency, the spacing between sidebands is multiplied by the same amount. The increase in phase noise amplitude with multiplication relates to multipliers being non-linear (generally class C) devices. Think of a multiplier as an amplifier being driven into saturation. The primary signal will be gain-compressed to a greater degree than its

sidebands (which, after all, started out at a lower level). Thus, the sidebands emerge from the multiplier nearer in amplitude to their carrier than they were going in.

Since both phase noise and its increase with multiplication are unavoidable, it is apparent that one objective of receiver design should be to minimize incidental FM on local oscillators to the greatest possible extent.

### Which Oscillator to Tune?

Any crystal-controlled oscillator can be made to vary somewhat in frequency by placing a small reactance (either capacitive or inductive) either in series with or in parallel with the crystal. The circuit configuration used, amount of tuning achieved, and reactance values chosen are a function of several variables which are, as the textbooks say, beyond the scope of this course. The technique of varying or "warping" the crystal's resonant frequency by the addition of an external reactance, however, is used in most commercial variable crystal oscillators (vxo's) and CB "sliders." The only problem which this technique presents is that "rubbering" a crystal's operating frequency always degrades its stability

somewhat, and this instability shows up as incidental FM, or phase noise.

Fig. 4. is a simplified block diagram of a microwave downconverter (such as that shown in Fig. 1), operating into a typical VHF-FM receiver. It illustrates the frequency schemes used in the various conversions. You will notice that there are three separate crystal-controlled oscillators involved. Vxoing any one of the three will result in varying the frequency response of the receiver, but which oscillator should be tuned?

Since tuning any oscillator introduces instability, and since instability compounds when frequency is multiplied, it should be evident that we can rule out vxoing the microwave local oscillator chain. This is unfortunate, because the high-order multiplication scheme used would have made it very easy to achieve a considerable amount of frequency flexibility, were phase noise not a factor. That is, the x12 multiplication of the 130-MHz crystal oscillator would have made it possible to achieve  $\pm 24$  kHz of tuning range just by pulling the crystal up or down 2 kHz. Lest you be tempted to pull the 130-MHz crystal, even this small amount, look again at Fig. 2, which is a spectrum-analyzer photo of the instability which will result.

In the interest of minimizing phase noise sidebands, it always is best to let oscillators driving multiplier chains oscillate where they want to, and do your tuning downstream. Since the output of the 10-MHz oscillator is not multiplied at all, one might be tempted to make it variable, in order to tune the receiver shown in Fig. 4. However, notice that the last conversion stage occurs after the 10.7-MHz bandpass filter which sets

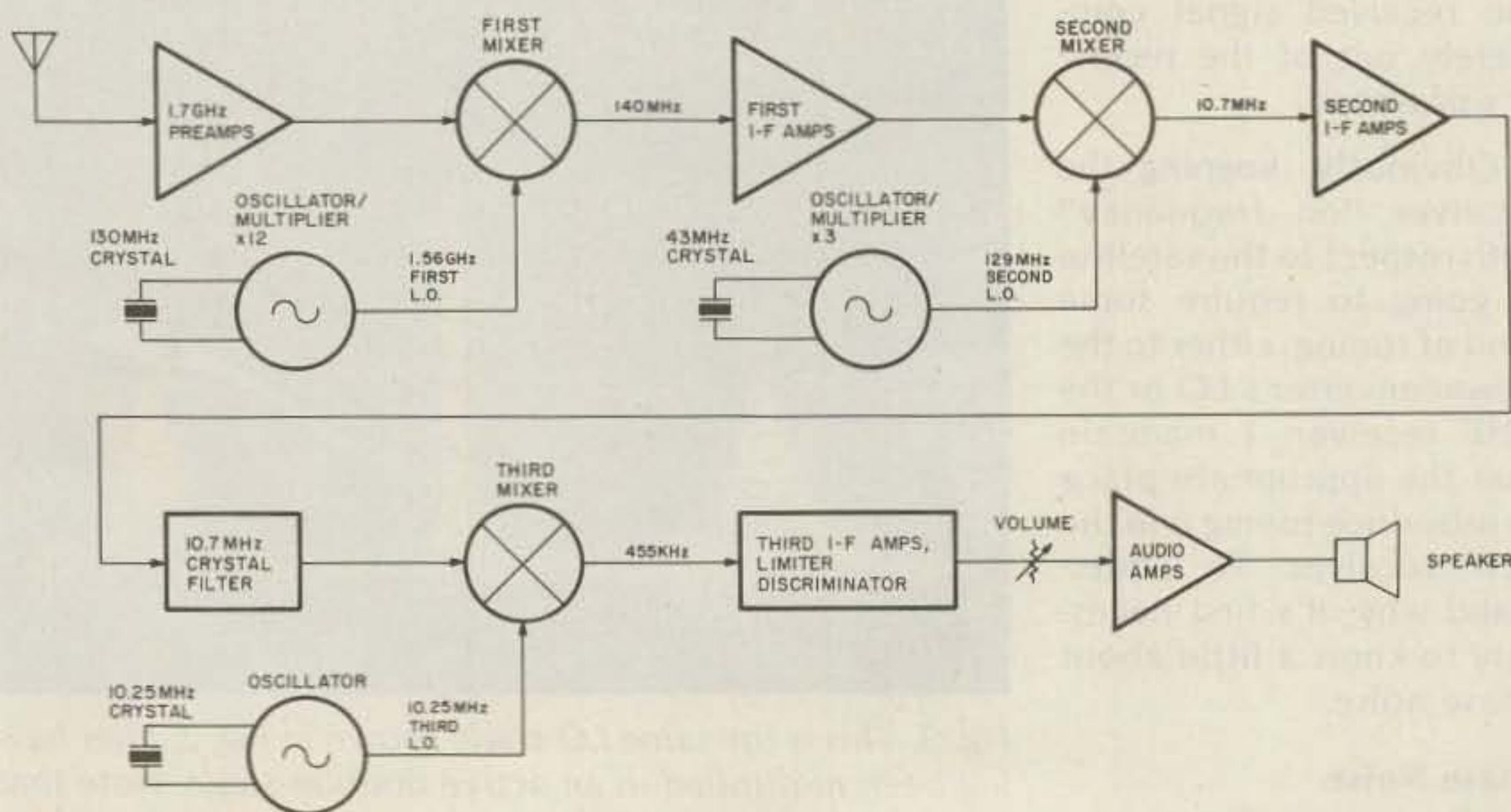

Fig. 4. A simplified block diagram of the microwave receiving system.

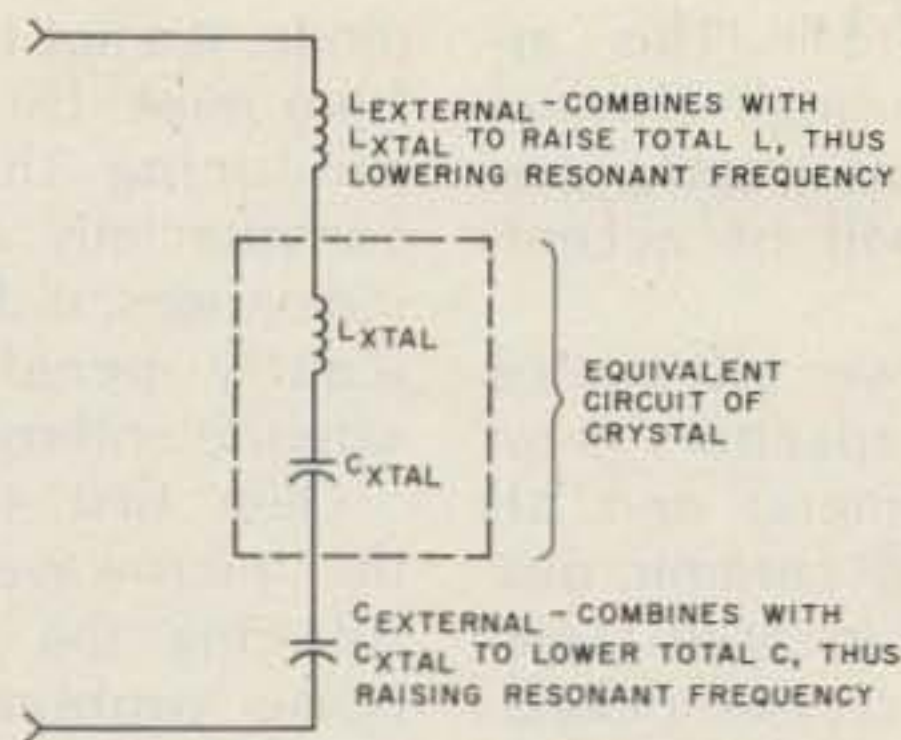

Fig. 5. Varying the operating frequency of a series-mode crystal.

the receiver's overall response. Since it does little good to do your tuning downstream from the major selectivity portion of the receiver, this leaves only the 42-MHz crystal in the second conversion as a likely candidate for achieving frequency agility.

It is true that the output of the 42-MHz crystal is multiplied to 126 MHz, and true that that multiplication will tend to aggravate the phase noise problem, but a times-three multiplication is less horrendous than a times-twelve jump, as far as instability is concerned. My experience indicates that it's possible to pull the frequency of oscillation of the 42-MHz crystal as much as  $\pm 10$  kHz (yielding  $\pm 30$  kHz of overall tuning range) with no ill effects.

### Vxo Circuit Description

I said before that reactances can be added in series or in parallel with a crystal, and that they can be capacitive or inductive to achieve tuning. In the case of a crystal operating in its series-resonant mode, the addition of series-inductance will tend to lower the operating frequency, while series-capacitance will tend to raise it. This is illustrated in Fig. 5. Series-inductance will combine with the equivalent inductance of the crystal itself, lowering the resonant frequency. On the other hand, a capacitor in series with the

crystal's equivalent capacitance will decrease the overall capacitance, raising the resonant frequency. Where both series inductance and capacitance are used, one effect or the other will predominate, depending on which reactance is of the greater magnitude. If the added inductive and capacitive reactances are equal, they will cancel each other (resonate), and the crystal will oscillate on its original frequency.

Fig. 6 is a schematic diagram of the oscillator section of a Vanguard receiver, which is typical of many of the receivers mentioned in the introduction. The crystals are third-overtone units in the vicinity of 42 MHz, operating in their series mode. Notice the 5-to-30-pF trimmer capacitor, shunted by a 10-pF fixed capacitor, in series with each crystal. These capacitors are used for "netting" or zeroing the receive frequency, and provide a total tuning range of about 2 kHz, upward. To make the receiver come out on

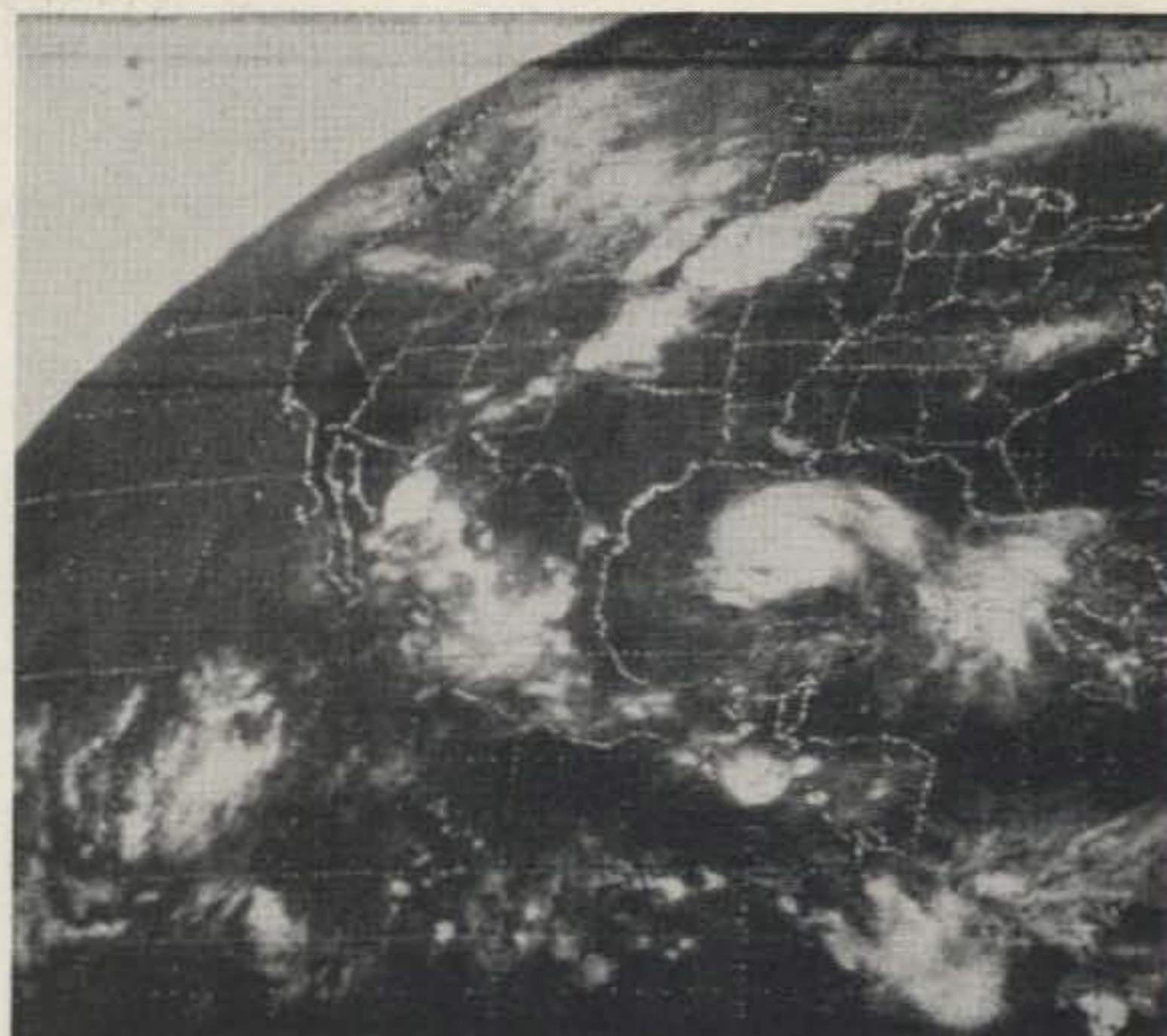

This is a weather satellite image taken with the signal centered in the receiver's passband. Notice the slight blur at the top, caused by tuning the receiver during reception.

frequency, the manufacturer specifies crystals cut for 1 kHz lower than the expected frequency.

Since the 2-kHz total tuning range ( $\pm 1$  kHz) is hardly sufficient to compensate for Doppler shift or thermal drift, it is necessary to significantly increase the tuning range of this circuit. In my WEFAX receiver, I wanted to be able to tune 137.5 MHz  $\pm 30$  kHz (a total tuning range of 60 kHz). Since the output of the 42-MHz oscillator is tripled to 126 MHz, it was necessary to make the oscillator tune a total of 20 kHz. I found, however, that no matter how small I made the series capacitance, the circuit dropped out of oscillation before it reached 20 kHz of

frequency change. Similarly, a series inductor raised the frequency of oscillation, but the circuit died before a 20-kHz change had been achieved.

I was able, however, to make the oscillator move either up or down about 10 kHz by applying about 300 Ohms of inductive or capacitive reactance in series with the crystal. It thus became clear that my vxo circuit was going to have to incorporate both inductance and capacitance to achieve the desired tuning range.

The values which I ultimately selected are shown in Fig. 7. This circuit gave me the desired 60 kHz of total receiver tuning range, but for reasons which I do not fully under-

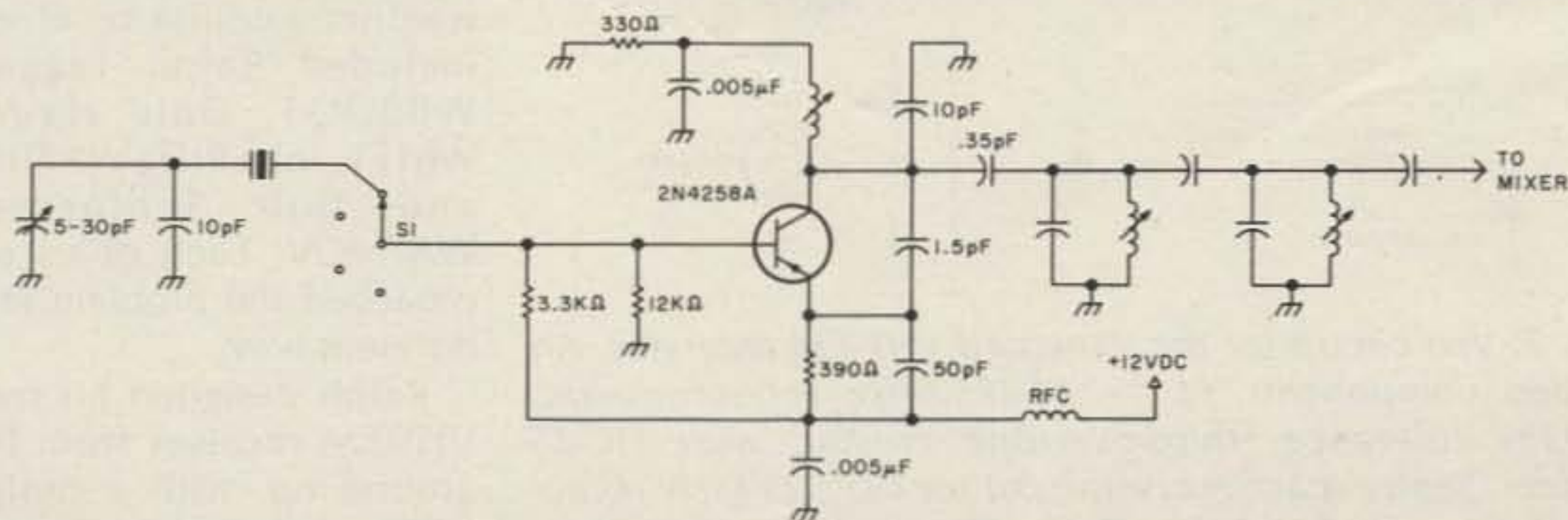

Fig. 6. VHF local oscillator section of the Vanguard FMR-250-11 and FMR-150A FM receivers.



The blur at the top of this picture is a dramatic indication of the effects of tuning. At the start of the transmissions, the receiver was not tuned on the incoming signal. The noise disappears abruptly when the receiver is tuned. This is especially evident in the grey-to-white transition at the upper right.

stand, the tuning range of the crystal was "skewed" downward somewhat. (I suspect this may have been due in part to the crystal's holder capacitance, which I overlooked in my simplistic analysis in Fig. 6.) By purchasing a crystal cut to receive 25 kHz high in the band, this circuit gave me accurate center-frequency calibration, and plus-and-minus 30-kHz tuning.

Since this vxo circuit worked for a Vanguard receiver, I later tried it in a Drake 2 meter transceiver. With a single crystal for 146.55-MHz reception, I am now able to tune the

three popular simplex frequencies of 146.49, .52, and .55.

#### Modification Procedures

The following procedure applies specifically to the Vanguard Model FMR-250-11 receiver. Of all low-cost receivers, this is perhaps the one most widely used for weather satellite work. The procedure will no doubt be similar for other receivers, although the layout will differ. Those readers modifying Vanguard receivers will be aided by the accompanying photographs.

(1) Remove crystal selec-

tor switch S1. (This assumes that single-channel plus-and-minus-tuning performance will be acceptable.)

(2) Remove all twelve "netting" capacitors (5-to-30-pF trimmers) and all twelve 10-pF ceramic disc capacitors located adjacent to the crystal sockets.

(3) Cut away the front of the printed circuit board behind S1 to accommodate the tuning capacitor. Note that two power traces at the very front of the circuit board are eliminated in the process.

(4) Using insulated stranded wire, reconnect the power by jumpering around the traces just cut. Leave the wires long enough to be routed around the tuning capacitor, well behind the front panel.

(5) Install the 3-to-30-pF tuning capacitor in the hole formerly occupied by S1.

(6) Wire from the base of the oscillator transistor directly to one of the remaining crystal sockets. Install the two miniature rf chokes between the other pin of the crystal socket and the stator of the tuning capacitor. (See Fig. 7.)

(7) Order a 42.275-MHz third-overtone crystal in an HC-25 package, specifying series resonance and  $\pm .003\%$  tolerance. Plug in the crystal, and enjoy 137.5 MHz ( $\pm 30$  kHz) tuning!

#### Acknowledgment

Amateurs helping me to evaluate the requirement for tuning flexibility on weather satellite receivers included Ralph Taggart WB8DQT, Dale Hauck W6YFT, John Prigg WA7JIO, and Bob Schloeman WA7MOV. Each of us approached the problem in a different way.

Ralph designed his own VHF-FM receiver from the ground up, with a design which included frequency tuning. Although his circuit employs a tuning varactor

diode, it's not too different from mine. He is currently producing the receiver commercially, and from all indications, it should significantly benefit weather satellite enthusiasts.<sup>16</sup>

Dale first tried tuning the microwave LO chain, suffering the very phase noise problems I mentioned earlier. He has since ordered one of Ralph's tunable receivers.

John ordered a synthesizer to go with his existing VHF receiver. The synthesizer gives him fixed-tuned coverage in 5-kHz steps, which is adequate for keeping the received signal rather close to the center of the receiver's passband.

Bob has been using ice cubes, blankets, and lots of luck to try to keep the temperature constant on his microwave downconverter! Though this is certainly the least costly solution of the temperature stability problem, he admits that it does have its weaknesses. By the time this appears in print, the chances are that he will have modified his Vanguard receiver for variable tuning. ■

#### References

1. Wendell G. Anderson K2RNF, "Amateur Reception of Weather Satellite Picture Transmissions," *QST*, November, 1965, p. 11.
2. Jack Spillane W7UGV, "Cathode-Ray Tube Display Unit for Satellite Weather Pictures," *QST*, June, 1969, p. 18.
3. Aubrey Burton W4TNT, "Reception of Nimbus III Infrared Pictures," *QST*, February, 1970, p. 51.
4. Katashi Nose KH6IJ, "Using the ATS-1 Weather Satellite for Communications," *QST*, December, 1971, p. 48.
5. Charles H. McKnight W4MKM, "Evolution of an Amateur Weather-Satellite Picture Station," *QST*, April, 1968, p. 28.
6. Lindsay R. Winkler W6WMI, "Facsimile Transceiver for Weather-Satellite Picture Station," *QST*, May, 1974, p. 59.
7. Ralph Taggart WB8DQT, "A

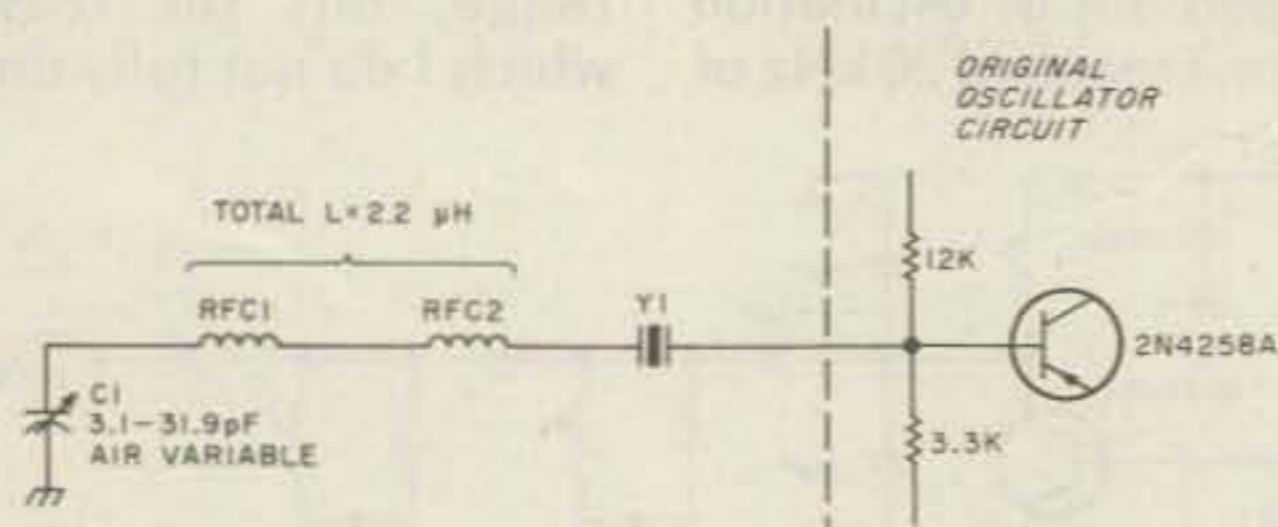
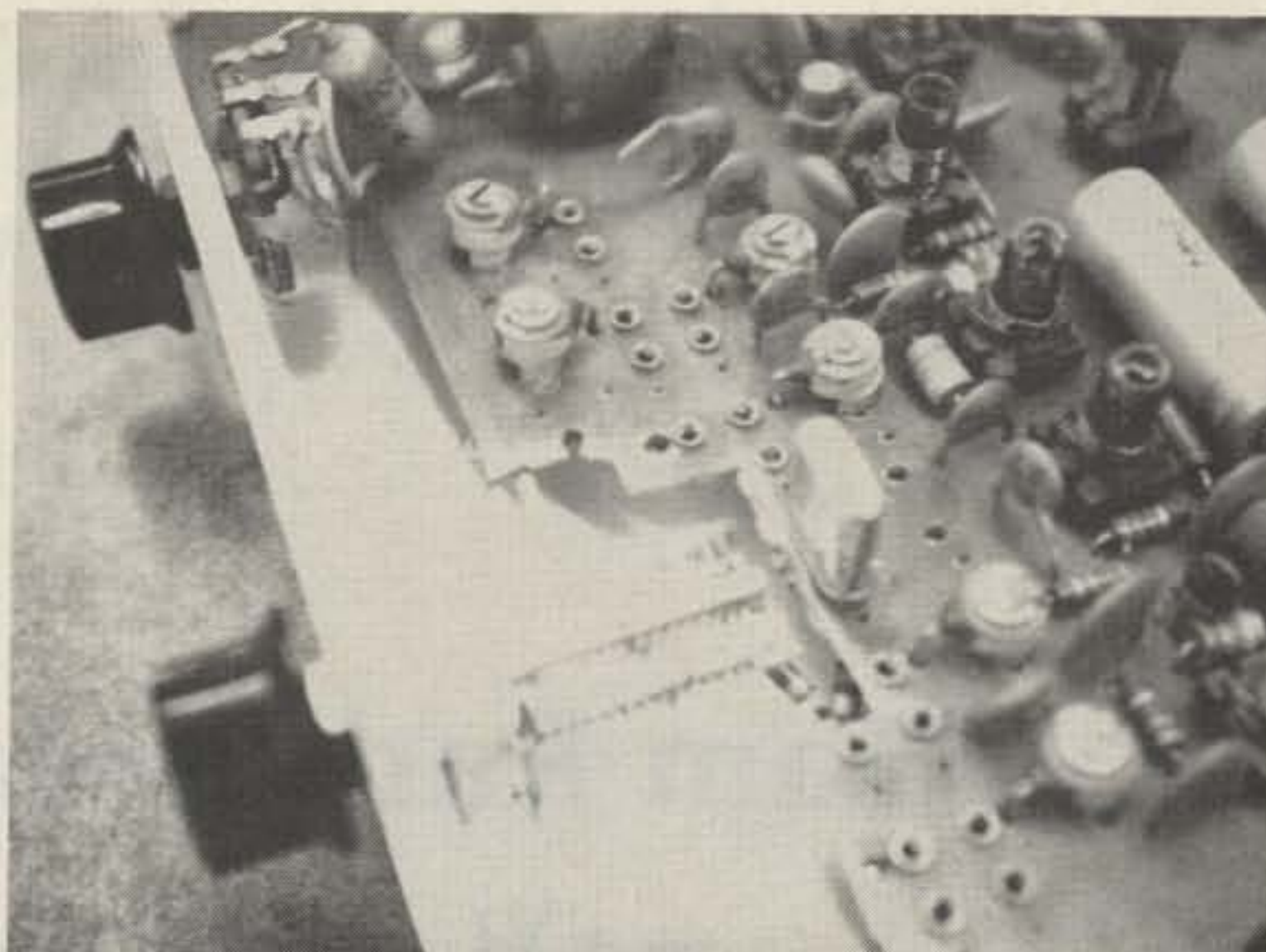
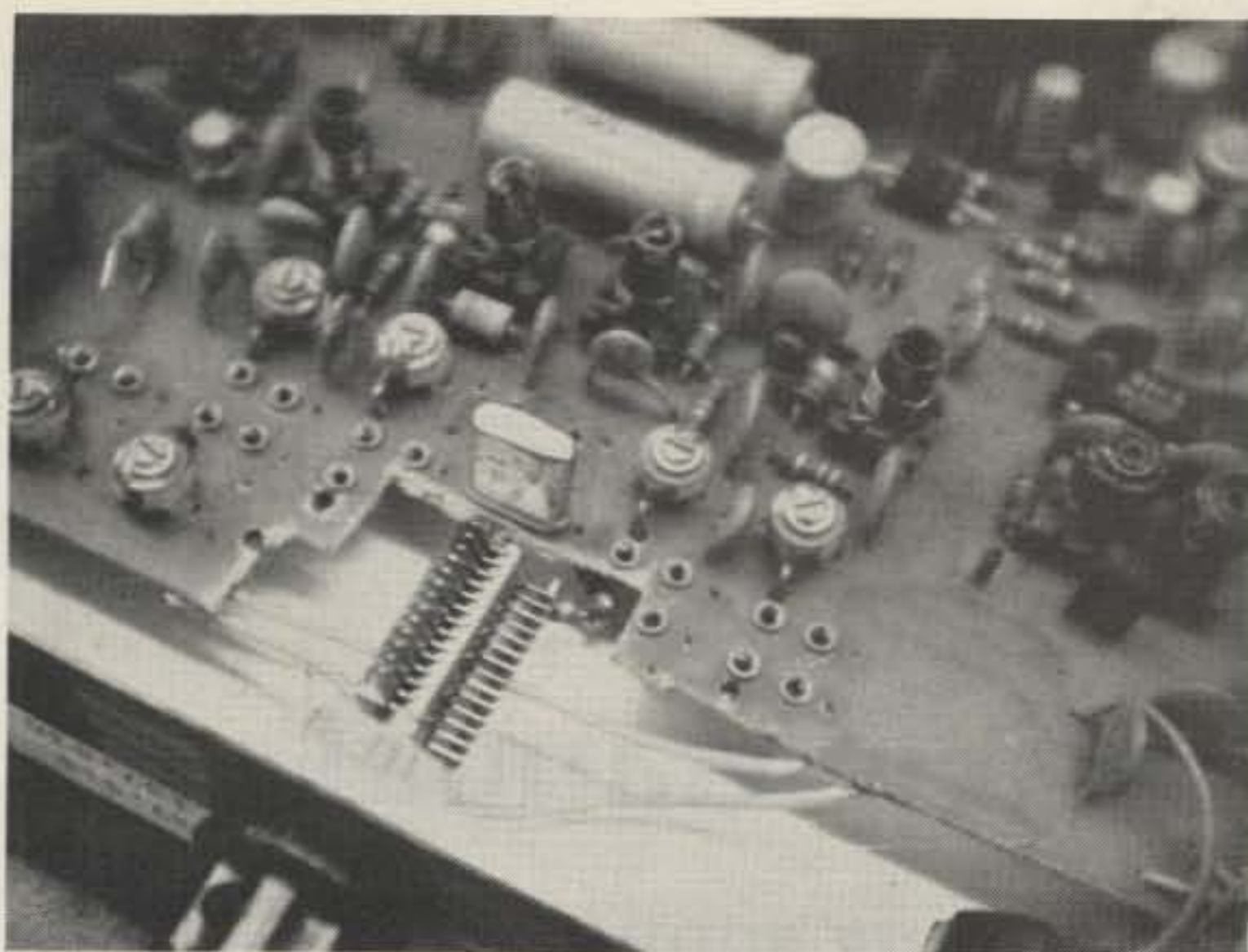

Fig. 7. Vxo circuit for the Vanguard VHF-FM receivers. An added component:  $Y_1 = 42.275$ -MHz series-resonant, .003% tolerance, third-overtone crystal, with HC-25 holder (Sentry scanner crystal, cut for 137.525 MHz reception).  $C_1 = E. F. Johnson$  1-60-130 air-variable capacitor, 3.1 to 31.9 pF.  $r_{fc1} = 1.2$ -uH miniature inductor;  $r_{fc2} = 1.0$ -uH miniature inductor.





These two pictures show the component side of the modified Vanguard receiver. Note the surgery mercilessly performed on the PC board, to allow for the mounting of the tuning capacitor. The rf chokes are visible behind and below the air-variable capacitor.

Satellite Fax System You Can Build," *73 Magazine*, September and October, 1975.

8. Eugene F. Ruperto W3HK, "Weather Satellite Pix Printer," *73 Magazine*, January, 1978, p. 82.

9. Eugene R. Ruperto W3HK, "A Satellite Receiver in the Home," *Scientific American*, January, 1974.

10. Ralph Taggart WB8DQT,

*Weather Satellite Handbook*, 73, Inc., Peterborough NH, 1976.

11. Ralph P. Corbell et al, *GOES/SMS User's Guide*, US Department of Commerce, National Oceanic and Atmospheric Administration, National Environmental Satellite Service, 1977.

12. Ralph Taggart WB8DQT, "Be A Weather Genius," *73 Magazine*, November, 1978, p. 198.

13. H. Paul Shuch N6TX, "Calculating Antenna Bearings for Geostationary Satellites," *Ham Radio*, May, 1978, p. 67.

14. John J. Nagle, "A Method of Converting the SMS/GOES WEFAX Frequency (1691 MHz) to the Existing APT/WEFAX Frequency (137 MHz)," Technical Memorandum NESS 54, National Oceanic and Atmospheric Administration, April, 1974.

15. H. Paul Shuch N6TX, "A Cost-Effective Modular Down-converter for S-Band WEFAX Reception," *IEEE Transactions on Microwave Theory and Technique*, December, 1977, p. 1127.

16. Model GR1-IF; available from Metsat Products, Box 142, Mason MI 48854.

17. Model RX-1691; available from Microcomm, 14908 Sandy Lane, San Jose CA 95124.

## ALL-MODE VHF amplifiers

FOR BASE STATION & REPEATER USE

MODEL: V350



- ☆ Built-in 115/230 VAC Supply
- ☆ AM-FM-CW-SSB-RTTY
- ☆ 60dB Harmonics
- ☆ 60dB Spurious
- ☆ Heavy Duty Design

MODEL: V180



- ☆ Illuminated Panel Meter
- ☆ Automatic T/R Switching
- ☆ VSWR Protected
- ☆ +13V/3A Accessory Socket
- ☆ U.S. Manufactured

All Solid-State!

MODEL	FREQUENCY	INPUT	OUTPUT	SIZE WxDxH	WEIGHT	FAN KIT REQUIRED	PRICE
V76	50-54MHz	8-15W	100-120W	216x330x178mm	11.7 kg (26 lbs)	No	\$339.00
V360	50-54MHz	2-10W	400-450W	432x330x178mm	23.4 kg (52 lbs)	Yes	\$895.00
V70	144-148MHz	10-15W	75-90W	216x330x178mm	11.7 kg (26 lbs)	No	\$315.00
V71	144-148MHz	1-3W	75-90W	216x330x178mm	11.7 kg (26 lbs)	No	\$349.00
V180	144-148MHz	5-15W	170-200W	216x330x178mm	13.5 kg (30 lbs)	CW & FM	\$539.00
V350	144-148MHz	10-20W	350-400W	432x330x178mm	23.4 kg (52 lbs)	Yes	\$895.00
V130B	220-225MHz	10-15W	70-85W	216x330x178mm	11.7 kg (26 lbs)	No	\$329.00
V135B	220-225MHz	25-35W	140-160W	216x330x178mm	11.7 kg (26 lbs)	CW & FM	\$469.00
F110		Fan Kit, 115VAC		135x135x50mm	1 kg (2.2 lbs)	-	\$ 33.00
F220		Fan Kit, 230VAC		135x135x50mm	1 kg (2.2 lbs)	-	\$ 33.00
*F135		Fan Kit, 115VAC		381x140x89mm	3.2 kg ( 7 lbs)	-	\$ 59.00
*F235		Fan Kit, 230VAC		381x140x89mm	3.2 kg ( 7 lbs)	-	\$ 59.00
RM-1		19 Inch Rack Adaptor		483x3x178mm	1 kg (2.2 lbs)	-	\$ 25.00
*RM-2		19 Inch Rack Adaptor		197x32x28mm	.5 kg (1.1 lbs)	-	\$ 12.00

\*Used with the V360 & V350 Amplifiers

Other Frequencies Available on Request

Dealer Inquiries Invited

Meeting all applicable FCC Requirements.

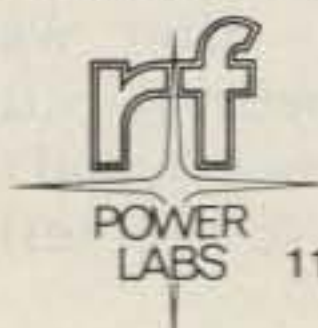

RF POWER LABS, INC.

✓ R27



11013-118th Place N.E. • Kirkland, Washington 98033 Telephone: (206) 822-1251 • TELEX No. 32-1042

# Ham Radio Marriage Manual

— a YL and her understanding spouse

**M**y reason for writing this article is the tone of surprise or, in some cases, absolute amazement in the voices of my contacts when they learn that I am married to a non-ham.

Not only is the OM not a ham, he doesn't seem to have any desire to be. Since a ham ticket has to be earned at the expense of the individual who wants it, I can not and will not try to push him. He returns this respect by not trying to force on me the— to me, questionable—joys of fishing. The result is that we view each other's hobbies with a kind of head-shaking fascination.

Upon learning that Roger is not a ham, my contacts always ask the obvious question: "How in the world did *you* ever get interested in radio?" The answer usually goes something like this.

There has been a streak of ham in me for years—more years, in fact, than I care to count. It tickles me to remember back to my first year in high school, when my mother and the guidance counselor had to threaten me to get me to

take my first speech course. I have silently thanked both of them many, many times since. That first involvement with speech led to what developed into a real love—communicating with people. By the time I finished high school, I was hooked, and it came as no great surprise to my parents that I chose to major in Radio and Television Communication Arts. It was my intention, at that time, to make broadcasting history and revolutionize the communications industry.

Before I finished college, however, and certainly before I had time to gift the broadcast industry with my presence, I married my high school sweetheart. In the years that followed, we traveled around the country at the request of Uncle Sam. Roger was in the Army at the time, and when Uncle Sam invited, it was not an invitation that one could refuse. Of course, our beautiful daughter, who is now nine years old, came along. I never lost my love of people and the enjoyment of exchanging ideas and thoughts.

In 1971, I met Marie

WB5OKV, who later became my "Elmira." She was not a ham, but her OM, at the time, was. A few years after we became friends, she began studying for her license. By this time, we were close friends, and I wanted to help her if I could. About the only way I could help was to read her the questions from the license manual. I had no idea what I was reading, but after a while managed to be able to gather whether or not she was right. Most of the time, she would know if she was right or not when I would say, "It says here . . ." At any rate, she told me it was a help to her—maybe she was just being nice.

At this point, I still had not been bitten by the bug. Naturally, after getting her ticket, that's all she talked about. She suggested that I might enjoy ham radio and offered to help me study. At first, of course, I thought I'd never be able to understand all that theory and the code, but after a few months, it finally dawned on me that an amateur radio license was my passage to anywhere I wanted to go. With the cost

of living index going up faster than my weight (a phenomenon in itself) and no end to inflation in sight, the only way I could ever see all the places I wanted was through the eyes of the people living there.

So I took Marie up on her offer of help, borrowed her study material, and set out upon what would become a long journey.

I told Roger what I wanted to do, and he said he thought it was a fine idea. The code was the worst thing I had ever tried in my whole life, and theory was about as clear as mud. After a while I became very discouraged, which I have learned since is quite natural. All of you who have ever been in that position will remember. First, you think to yourself, it's not that important, anyway. After all, you've gotten this far in life without it. Right? Then we all realize that we do want it, and the deep-down want-to takes over again and we decide that we will get it no matter how long it takes.

After weeks of study, worry, code practice, sweat, and tears, I took the Novice test, administered

# A Breakthrough In Technology!

## THE YAESU FT-207R

### MICROPROCESSOR CONTROLLED SYNTHESIZED HANDIE

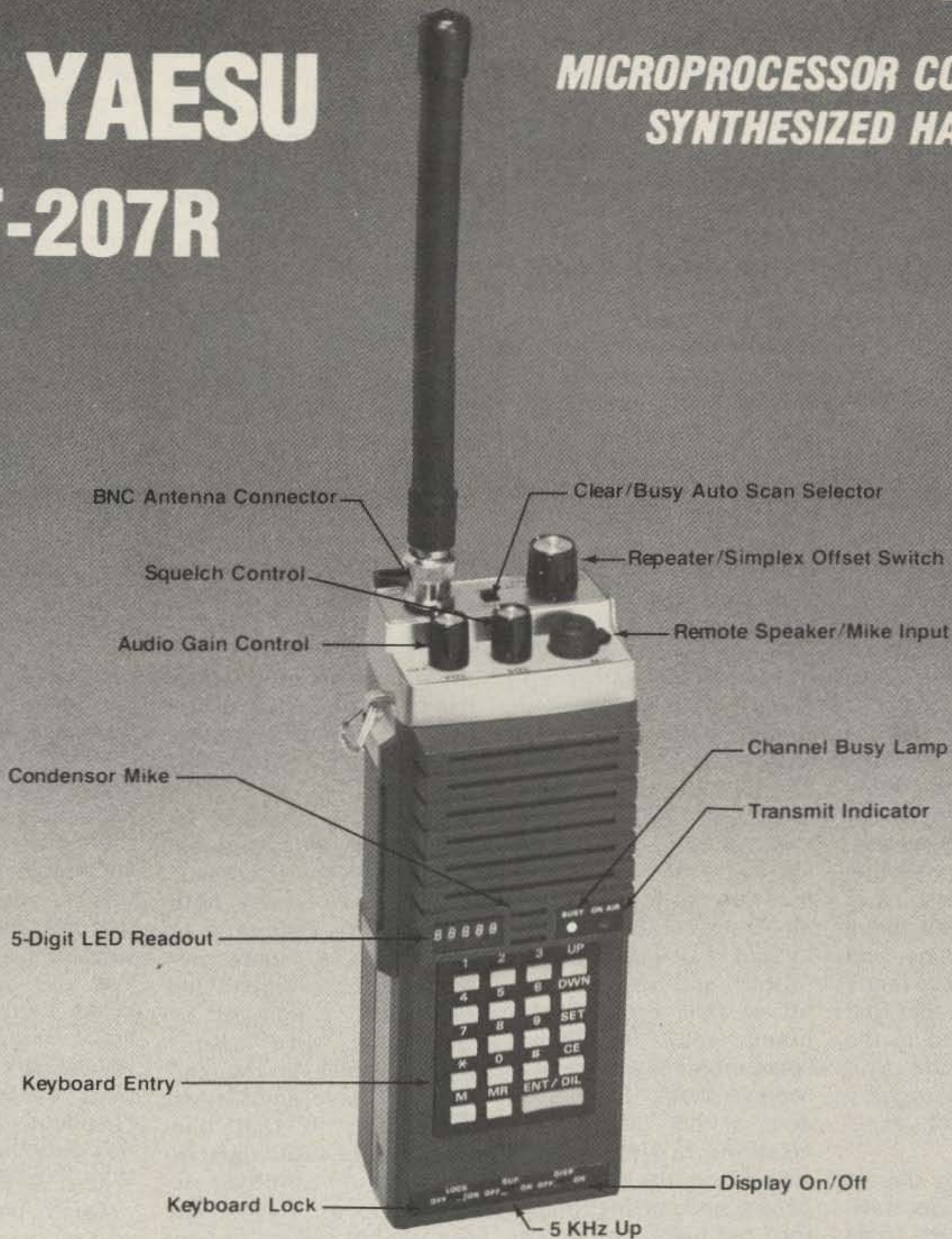

**The Yaesu FT-207R Synthesized Handie  
has all the features you could want in a very compact package**

- 144-148 MHz Range
- 10 KHz Steps
- 3 Watts Output
- 4 Memories plus Programmable Offset
- Priority Channel
- Memory and Band Auto Scan
- Optional Equipment:
  - Tone Squelch, Speaker/Mike, Nicads, Battery Charger
- Keyboard Encoded Frequency Entry
- 2 Tone (Touchtone®) Input from Keyboard
- Keyboard Lock guards against accidental frequency change
- Odd Splits Can Be Programmed from Keyboard
- Automatic Battery Saver Feature for LED Display
- Rubber Flex Antenna



Price And Specifications Subject To  
Change Without Notice Or Obligation

Y1  
**YAESU**  
**The radio.**



1279X

YAESU ELECTRONICS CORP., 15954 Downey Ave., Paramount, CA 90723 ● (213) 633-4007  
YAESU ELECTRONICS Eastern Service Ctr., 9812 Princeton-Glendale Rd., Cincinnati, OH 45246

by none other than my Elmira, of course. I felt that I had passed, but was nonetheless amazed and overjoyed a few weeks later when the license came in the mail. Marie understood my excitement, and Roger was happy that I was happy.

After that, I studied with a new dedication for that coveted General ticket. During this time, Roger was patient and tried to be cooperative, but he simply didn't understand how important it had become to me. Marie gave me great moral support, listened to my code, and went over theory points with me whenever I asked her to.

In spite of where my mind was, the usual domestic chores had to be kept up with. So, in order to keep pace with both, I would prop the license manual in the window above the sink while doing dishes, and I listened to a tape recording of me asking theory questions while I ironed. There was a list of formulas on the wall above the washing machine, and Roger's patience was really put to the test the first morning he looked in the bathroom mirror and found himself looking at a block diagram of a receiver.

Finally, the big day in February of 1977 was drawing near. I was going to go to San Antonio for the test since the FCC did not come to Laredo. Plans were made for Marie to help watch my daughter while I made the overnight trip. Test time was 8 am, and I knew better than to think I could get up at 3 am, drive 150 miles, and still have an even chance of passing. So I went the evening before and spent a restless, almost sleepless, night. Every time I closed my eyes, I saw swr rushing at me, and when I tried to run, I kept falling over the formula for inductive reactance. Ul-

timately, I was taken prisoner by an army of capacitors in series.

The next morning, bleary-eyed and battle-weary, I went to the test. The next couple of hours are a blur in my memory, but I left the examination room clutching a form, signed by the examiner, saying that I had passed the required elements for a General license. Believe me, the tires of my car did not touch pavement all the way back to Laredo!

When I pulled up in Marie's driveway, she was seated in front of her radio. (Her shack was in the garage.) Her blank stare of questioning anticipation was transformed into a smile that went from ear to ear when I gave the thumbs-up signal. I still wonder what her neighbors thought as we yelled at the top of our lungs and jumped around like kids on Christmas morning.

Roger was pleased for me and a few weeks later made me a gift of a 2 meter rig for my car. By this time, he had realized that I was serious and was not surprised that for the next many weeks my every spare moment was spent in Marie's shack listening to and, at her gracious invitation, talking to, her friends on the air. These people became my friends, too, and helped me locate a used Swan 500C that was in good shape at a reasonable price.

Of course, even a reasonable price presented a problem for me. Since the household budget was strained to the breaking point, the \$300 I needed sounded like the national debt. The only answer was a part-time job. That was no easy task, either, since I had not worked in years. I was able to find one, however, and being aware of my dilemma, the ham from whom I bought Charlie (the name I gave the rig) offered

to let me use it while I paid him for it. Heaven doesn't have a corner on the angel market!

We put up my 40/80 meter doublet well in advance of Charlie's arrival, and I spent the rest of the waiting period fixing up the closet of the guest room, which was to be my ham shack. I had decided that the garage was too hot in the summer and too cold in the winter. Besides that, the closet location would allow me to close the door and keep the rig out of sight of small children who might come to visit.

On the evening of October 3, 1977, Marie and I met Charlie at the bus station and rushed home to get him on the air. Ever since then amateur radio has been a big part of my life and has brought me many, many hours of pleasure.

Thanks to amateur radio, I have met and made friends with some fantastic people. I've spent hour upon hour listening to other people, sometimes not even breaking in. One can learn a lot just by listening (and about theory, too). Even though I may not have anything to contribute to that particular QSO, I still find it interesting to hear others exchange ideas. I have felt the thrill of talking to people in some of those places I may never see and have known the warmth of helping people find out about loved ones.

Do you have any idea how large a child's eyes can get when he talks to Santa Claus on the radio? (Thanks, J.R.) Some of the people I've met on the air I have had the pleasure of eyeballing and some I have not, and there are others whom I have met that I will never see again because they have become silent keys. I will always cherish their memory.

To me, there is a very real sense of accomplishment in being a ham. Everyone needs to feel the satisfaction that comes from achieving, regardless of age. For me, amateur radio has offered me an avenue of accomplishment, achievement, and pure enjoyment that I have not found anywhere else. I have only regret—and that is that I did not find it sooner.

When I came home after finally passing my Advanced test (suffice it to say that I did not pass it the first time I took it), Roger asked me if I was finished yet. He isn't usually given to such foolish questions!

The bottom line to all this is that if you want a ham ticket, hang in there. For some, the code and theory come more easily than for others. But there is one thing true of every ham in the world—none of them was born with a knowledge of electronic theory, and I assure you that not one of them ever said his first word in CW. We all had to learn it. When I first began studying, I thought ac was the brand name for a spark plug, dc was where the President lived, and CQ was duty that the OM used to pull in the Army!

Don't be dissuaded if you're living in a home without a ham. When you do get your ticket, you will be able to count yourself special because you had more obstacles than most. In any case, don't be scared off by thinking amateur radio is no place for a woman. There are hundreds of us girls on the air. Of course, there are a few guys around who still think that amateur radio is a man's world, but they are few and far between. Ninety-nine point nine percent of the time you'll be welcomed with open arms, as I was. ■



143.800 — 148.200 MHz Mobile Transceiver

**Power to the mobile operators!** This one is brand new, and it carries a powerhouse punch wherever you're going. ICOM unveils a full 25 watts of mobile power with the introduction of the new **IC-255A**. When you want increased mobile QSO range, ICOM delivers; and **nobody does it better.**

The microprocessor controlled **IC-255A** is a deceptively compact unit which packs more big, multifeature flexibility than any other ICOM mobile to date. This one offers a 5 channel memory, complete with memory scan, adjustable scanning speed, and auto-stop. The 5 channels can easily be written from any inband frequencies; and the scan function can be programmed to scan all 5 or only 2, stopping on any signal.

Like the other new ICOM transceivers, the IC-255A comes with 2 VFO's built-in at no extra cost. The radio is programmed to come up to power operating at 600Khz splits,

but it can be reprogrammed to any split of your choice. The dual VFO's and single tuning knob provide you with smooth, easy tuning in 15KHz or 5KHz steps.

The use of new low-noise, dynamic range junction FET's (for the RF amplifier and the first mixer) and helical cavity filters (for the antenna and RF circuits) provides excellent sensitivity and intermodulation distortion characteristics. A pair of high quality monolithic crystal filters and ceramic filters facilitates interference free reception reliability.

The new **IC-255A's** power is selectable 25W high or 1W low, yet it draws only 5.5 amps when transmitting in the high power mode. A directly amplified VCO output, without the use of multipliers or mixers, and a power module in the PA unit produce a very clean transmitted signal, with low spurious radiation. When you're in an RF trap, the **IC-255A** can get out the signal. To give your mobile FM operations big features with a power punch, give yourself the **IC-255A**.

HF/VHF/UHF AMATEUR AND MARINE COMMUNICATION EQUIPMENT



**ICOM**

**ICOM AMERICA, INCORPORATED**

Sales Service Centers located at:

2112 116th Avenue NE  
Bellevue, WA 98004  
Phone (206) 454-8155

3331 Towerwood Dr., Suite 307  
Dallas, TX 75234  
Phone (214) 620-2780

**ICOM INFORMATION SERVICE**

2112 116th Ave., N.E.  
Bellevue, WA 98004

S

Please send me:  IC-255A specifications sheet;  full color ICOM Product Line Catalog;  List of Authorized ICOM Dealers.

NAME \_\_\_\_\_ CALL \_\_\_\_\_

ADDRESS \_\_\_\_\_

CITY \_\_\_\_\_ STATE \_\_\_\_\_ ZIP \_\_\_\_\_

You may send a machine copy of this form

# The Space-Saving Square Vee Antenna

— a directional radiator for cramped quarters



Photo A. The 10-meter square vee supporting a nine-year-old helper.

**W**ant an electronically rotatable array, but can't afford the vertical height required for a sloper system<sup>1</sup> or a perverted double vee?<sup>2</sup> Don't have an extra acre or two for a good radial system on your phased verticals? Maybe the DJB Square Vee is for you.

Here's an antenna only a quarter-wavelength high, supported by a single mast, that doesn't depend on a good ground system for efficient radiation. It is electronically rotatable, doesn't require an antenna tuner, doesn't require retuning as the pattern is rotated, and has both high- and low-angle lobes useful for both local and DX work. This is an antenna that could be tacked to the side of an apartment house or, on the high frequencies, easily could be made collapsible for portable or field day

operation. Interested? Read on!

## Design

The heart of the system is the  $3/8$ -wavelength dipole.<sup>3</sup> A diagram of this dipole, which is 25% shorter than a normal half-wave antenna, is shown in Fig. 1.

The dipole is formed from two  $3\lambda/8$  sections of 300-Ohm twinlead. The first section is connected to the second with a 1.5-inch-long piece of twinlead, twisted as shown. The ends of the dipole are at a voltage maximum and must be separated by cutting the  $1/2$ -inch space shown in Fig. 1. The feedline, a  $\lambda/4$  coaxial matching section discussed later, is attached directly to the antenna feedpoint.

The  $3\lambda/8$  dipole has not been used widely in the past by amateurs. In part,

this is due to its odd radiation resistance (about 200 Ohms) and to its physical complexity. The square vee takes advantage of both of these apparent drawbacks.

In the square vee, two  $3\lambda/8$  dipoles, each bent in the shape of a vee, are mounted vertically with the feedpoints spaced a quarter-wavelength apart. For high frequencies, the antenna can be mounted on a wooden cross, as shown in the schematic of Fig. 2. At lower frequencies, a mast can be used for vertical support with guy wires pulling the feedpoints apart.<sup>2</sup>

The two dipoles are connected in parallel at the phasing control box, which is located in the station operating room. This device is used to adjust the relative rf phase between the dipoles by changing the length of their feedlines. The pattern control box, therefore, allows the pattern of the antenna to be rotated in the same manner as an array of phased verticals.<sup>4,5</sup>

### Construction

An example of a ten-meter square vee supported by a wooden cross is shown in Photo A. Each crosspiece is cut slightly longer

than a quarter wavelength. The two pieces are joined at the center, and the feedpoints of the two dipoles are connected near the ends of the horizontal crosspiece, as shown in Fig. 2.

Of course, it doesn't really matter whether you use a cross-type support or a simple mast with guy wires. Remember, though, for all types of vertical directional arrays, use a non-conducting support such as a wooden mast. A metal mast in the plane of the radiating elements can strongly influence the electrical behavior of the antenna, and may result in disappointing performance. The square vee has a real advantage over the sloper array or the perverted vee in this regard, as it requires only a quarter-wavelength mast rather than a half wavelength or so. On 40 meters, this means the difference between a 34-foot mast, required for the square vee, and the 50- or 60-foot masts required for the other systems.

Using 300-Ohm twinlead makes construction of the  $3\lambda/8$  dipole simple. Two sections of 300-Ohm twinlead are cut to  $3\lambda/8$ . The wires, but not the insula-

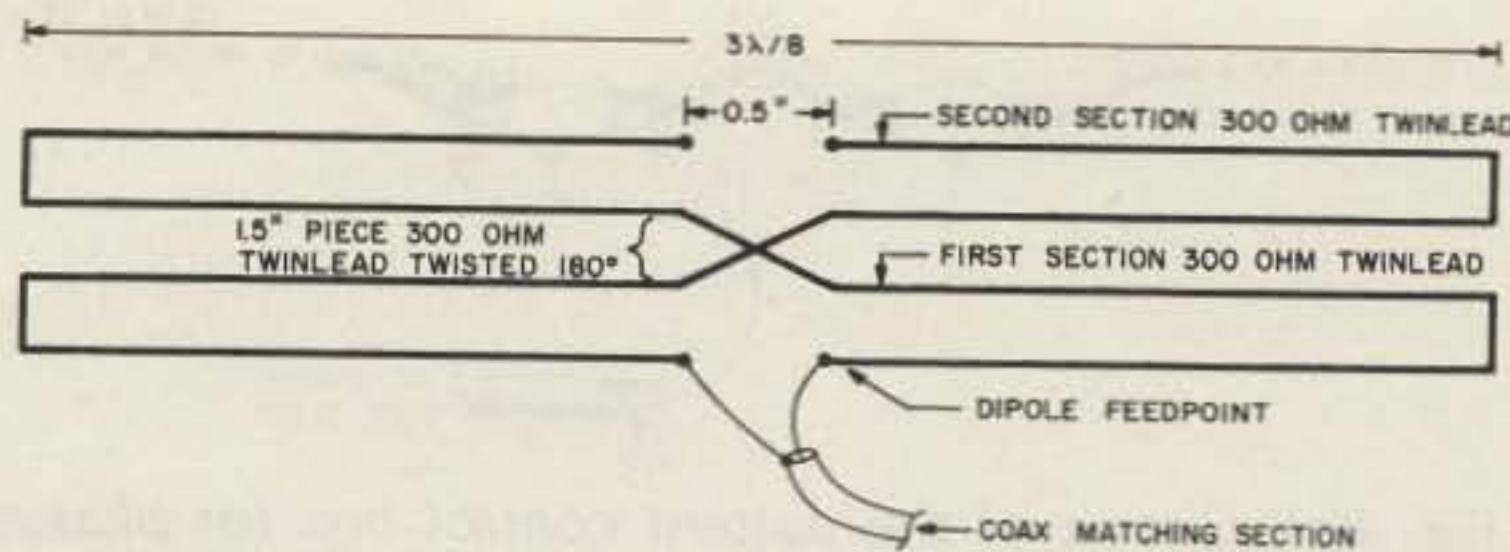

Fig. 1. Schematic drawing of the  $3/8$ -wavelength dipole.

tion, are cut at the centers to form the interconnections, as shown in Fig 1. A 1.5-inch piece of twinlead is used to connect the first section to the second. Be certain to separate the wires at the ends of the dipole, and leave about half an inch of space between the ends of the wires (see Fig. 1).

For each dipole, the first section of twinlead is mounted on one side of the horizontal crosspiece, and the second section is mounted on the other side. The 1.5-inch connection at the center (see Fig. 1) feeds through the horizontal support as shown in Photo B. This method of mounting keeps the wires of the dipole properly spaced. The ends of the twinlead can then be attached to the top and bottom of the vertical mast. I used small wire

brads tacked through the center of the twinlead near the end. Before the ends are permanently attached, however, it is best to secure them temporarily with tape and check the antenna tuning.

### Tuning

For maximum performance, it's very important that the two dipoles be electrically equivalent. Beg, borrow, steal, or perhaps even buy a grid-dip meter or similar instrument and trim the lengths of the dipoles to resonance at the desired frequency. I found that the length had to be slightly shorter than three-fourths of the length predicted by the traditional formula  $L(\lambda/2) = 468/f$  (MHz), where  $L(\lambda/2)$  is the length of a half wave in feet. Two factors probably accounted for this. First,

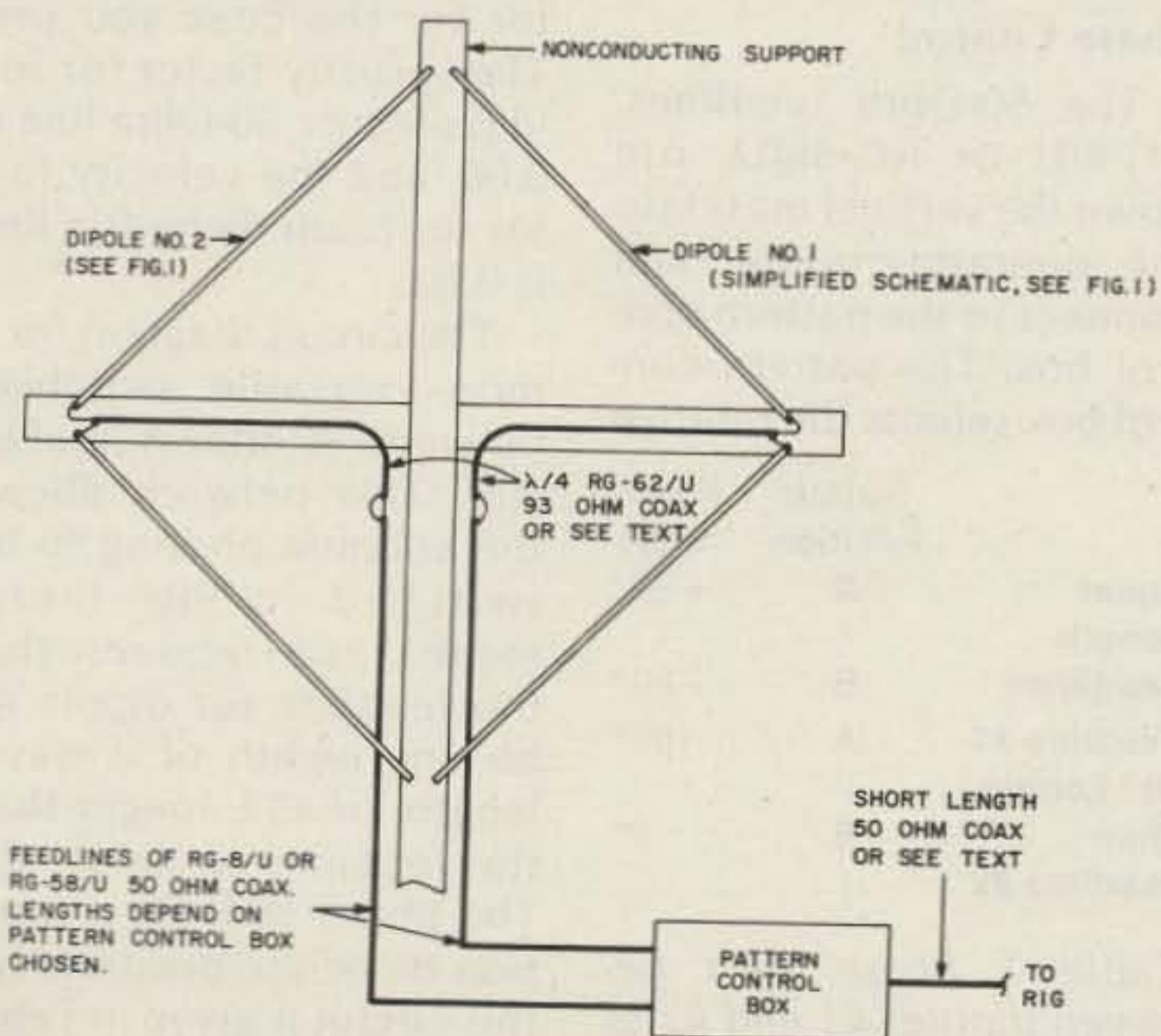

Fig. 2. The square vee antenna supported by a mast and crosspiece. The pattern control box is located inside the operating room near the station.

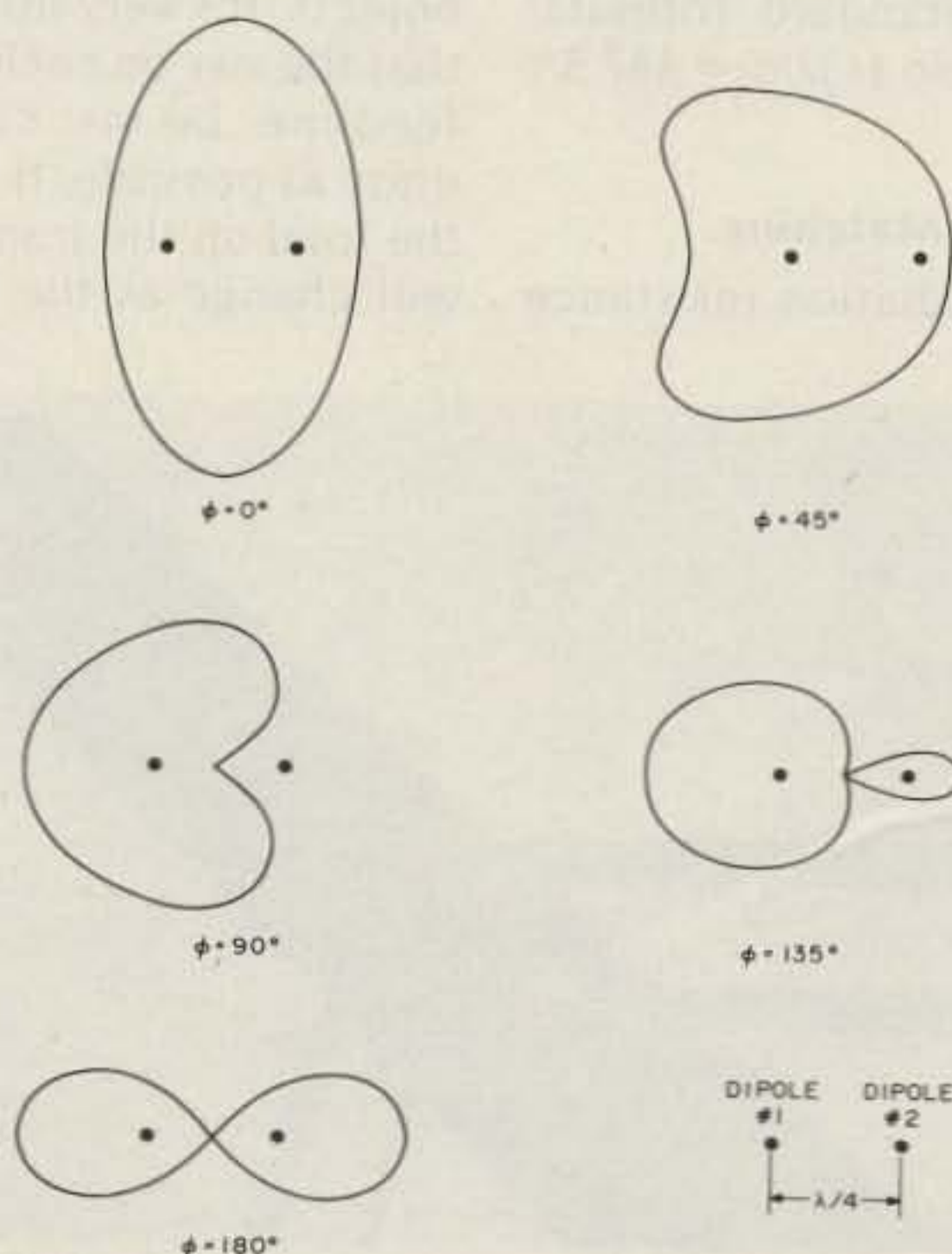

Fig. 3. Antenna radiation patterns in the horizontal plane for two vertical dipoles spaced a quarter wavelength apart.

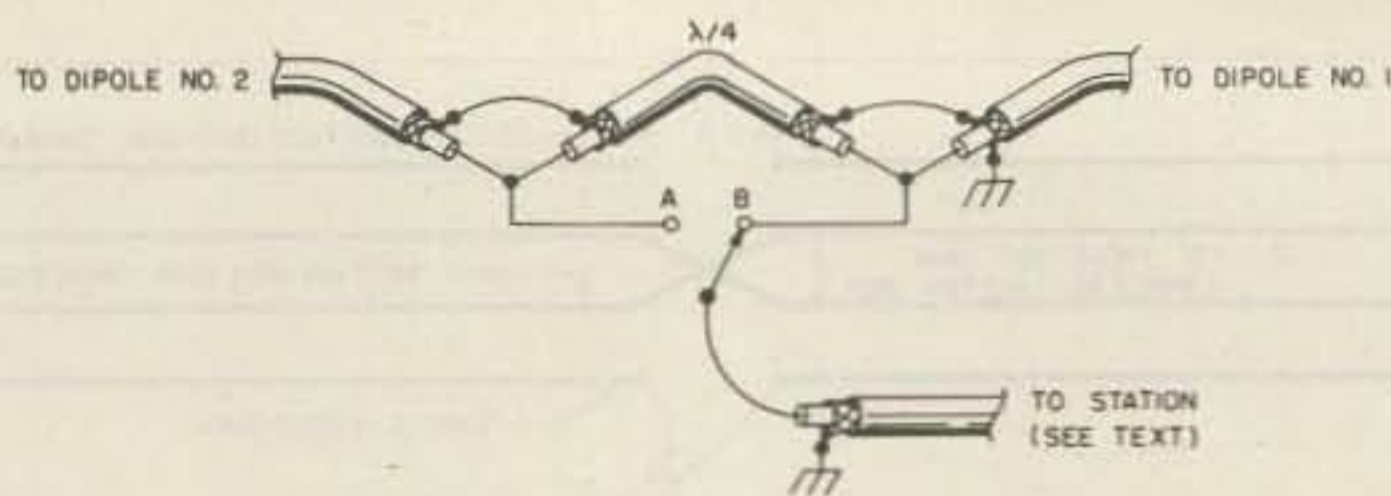

Fig. 4(a). Circuit of the pattern control box for phasing steps of 180°.

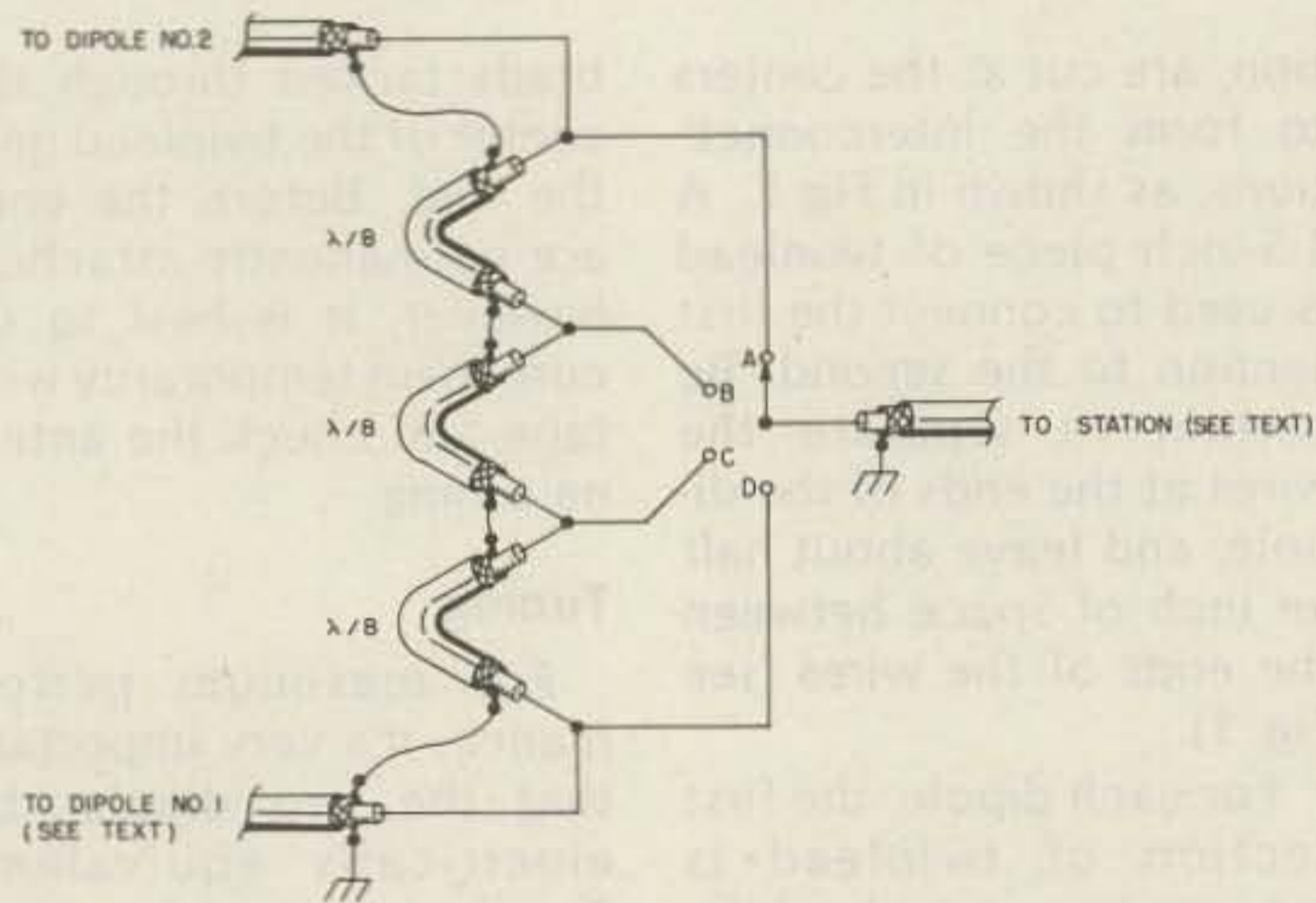

Fig. 4(b). Circuit of the pattern control box for phasing steps of 90°.

the formula doesn't include the one-inch interconnection between the two twin-lead portions of the dipole, Fig. 1, and, second, the formula is good for a linear dipole and not a dipole in the shape of a vee. You probably won't go too far wrong if you cut the dipole length 1% shorter than that given by the standard formula; that is, use  $L(3\lambda/8) = 347.5/f$  (MHz).

### Antenna Matching

The radiation resistance

of a linear  $3/8\lambda$  dipole, measured high above a perfect ground, is about 225 Ohms.<sup>3</sup> In the configuration shown here, I found the radiation resistance to be closer to 175 Ohms. The radiation resistance of the antenna was lowered both by its vee shape and by its proximity to surrounding objects. It's very important that the swr on each dipole feedline be as close to unity as possible. If it's not, the load on the transmitter will change as the pattern

is rotated, and the transmitter will have to be retuned for every direction. What's more, a mismatch here will probably require a matching network between the transmitter and the antenna for proper operation.

A quarter-wave matching section of 93-Ohm coax, such as RG-62/U, makes a good match between the 175-Ohm antenna resistance and 50-Ohm coax feedline. We calculate this from the formula  $Z_1 = Z_0^2/Z_r = (93)^2/175 = 49.4$  Ohms,<sup>6</sup> where  $Z_0$  is the impedance of the quarter-wave matching section,  $Z_r$  is the radiation resistance of the antenna, and  $Z_1$  is the impedance at the feedpoint of the quarter-wave matching line.

Instead of the quarter-wave coaxial matching network shown in Fig. 2, a 4:1 balun transformer (Amidon Associates kit) could also be used.<sup>7</sup> The balanced, high impedance side of the balun would be connected to the antenna feedpoint, and the low impedance side to the 50-Ohm coax feedline. This should work especially well in installations where the radiation resistance of the dipoles appears closer to 200 Ohms than to 175 Ohms.

### Phase Control

The 50-Ohm feedlines, RG-8/U or RG-58/U, run down the vertical mast into the operating room, and connect to the pattern control box. The pattern control box selects the relative

	Switch Position	Phase Shift
Equal Length Feedlines	A	+90°
Feedline #1 90° Longer Than Feedline #2	B	-90°
	A	180°
	B	0°

Table 1. Phase shift between dipoles #1 and #2 as a function of switch position for the pattern control box of Fig. 4(a).

rf phasing between the two dipoles and allows the directivity of the antenna to be changed. Fig. 3 shows the horizontal antenna patterns that can be expected from two dipoles a quarter wavelength apart, as  $\theta$ , the rf phase angle between them, is changed. Of course, the shape of these patterns depends upon the incident angle of the incoming radiation, and the expected performance is modified further by the vee shape of the individual dipoles.

Fig. 4(a) shows an elementary switching network that can be used to select between the 0° and 180° patterns, or between the +90° and -90° patterns. (The -90° pattern is the reverse of the +90° pattern.) For the 0° and 180° patterns, the feedline of dipole #1 must be a quarter wavelength, or 90°, longer than that of dipole #2. For the ±90° patterns, the feedlines must be equal length. Table 1 shows phase shift versus switch position for the difficult feedline lengths.

In calculating the electrical length of the feedlines, be sure to measure the physical length very carefully, and include the effect of the velocity factor for the coax you use. The velocity factor for solid dielectric 50-Ohm line is 0.66, and the velocity factor for foam dielectric line is 0.80.

The circuit diagram for a more versatile switching network is shown in Fig. 4(b). This network allows the antenna phasing to be switched in 90° increments, and requires that the feedline for dipole #1 be one eighth of a wavelength, or 45°, longer than the feedline of dipole #2. The phase shift (as a function of switch position) for this circuit is given in Table 2.

If desired, a more complex network employing an

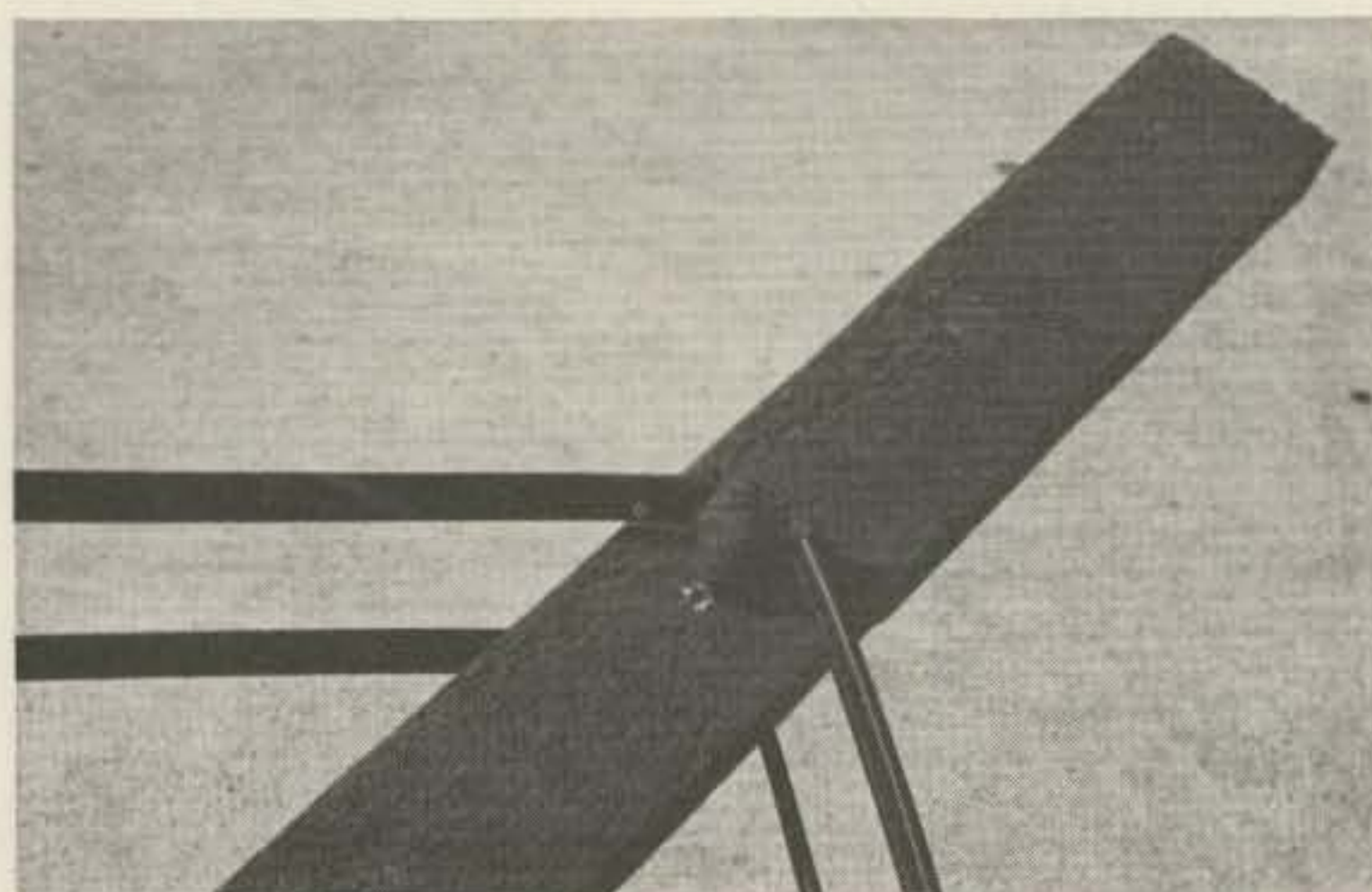

Photo B. Closeup of the dipole feedpoint near the end of the crosspiece. The coaxial line feeds through the wooden crosspiece to connect to the dipole.



eight-position switch could be used to select antenna patterns at 45° intervals. This would require that the feedline of dipole #1 be 22.5° longer than that of dipole #2, and would require one sixteenth of a wavelength of coax (22.5°) between each switch position.

### Station Matching

If the dipoles have been carefully matched to the line, the termination impedance at the end of each feedline will be very close to 50 Ohms. When the two dipoles are connected in parallel at the pattern control box, the feedpoint impedance at that point will be 25 Ohms. There probably are a number of ways to match this 25-Ohm resistive load to your transmitter. If the output circuit is capable of matching a 25-Ohm resistive load, you can couple it directly to the pattern control box through a *short* (compared to a quarter wavelength) piece of 50-Ohm coax. Or, you can connect the pattern control box and the transmitter with a half-wavelength of 50-Ohm coax. The latter solution is better at the high frequencies; even though the swr on the line is about two, its short length prevents significant losses.

The technique I used was to connect a quarter wavelength of 73-Ohm RG-59/U from the pattern control box to the transmitter through a balun step-down network. The quarter-wavelength of 73-Ohm line transforms the 25-Ohm feedpoint at the pattern control box into a 213-Ohm load. We see this from the equation used previously,  $Z_1 = Z_0^2/Z_r = (73)^2/25 = 213$  Ohms. At the transmitter end of the quarter wavelength, I used a 4:1 balun with the low impedance side connected to the transmitter to transform this in-

to a 53-Ohm resistive load. This is a little bit more trouble, but provides an excellent match to pi networks designed to operate on 50- to 75-Ohm resistive loads.

### Performance

I built my first square vee for the 10-meter band and used the pattern switching arrangement shown in Fig. 4(b), i.e., phasing steps of 90°. I mounted it on the roof approximately 20 feet off the ground, underneath a 40-meter inverted vee. The antenna required only minor retuning of the transmitter as the pattern was rotated, and I found that with about 100-Watts output, I could work almost anyone I could hear. A large number of European, East Asian, and Oceanic stations were contacted on both SSB and CW with a call-per-contact ratio for DX of about 80%. In other words, it works.

The big advantage of the antenna, however, lies in its directional performance. A large number of tests were performed on both receiving and transmitting, and it was found that the front-to-side ratio between the 0° and 180° phasing positions was about four S-units. As the patterns are not symmetric, the front-to-side ratio between the 180° and 0° patterns is different—and this was found to be about two S-units. The front-to-back ratio between the +90° and -90° phasing positions also was found to be about two S-units.

As an example of the directional performance, let

Switch Position	Phase Shift
A	180°
B	90°
C	0°
D	-90°

Table 2. Phase shift between dipoles #1 and #2 as a function of switch position for the pattern control box of Fig. 4(b).

me describe an actual contact with this antenna. With the 0° phasing pattern, I had maximum gain to the northeast, and was listening to a W8 station at S6. In between pauses, I heard a weak station, at about S3, calling CQ. Rotating the pattern to 180° phasing knocked the W8 down to S2 and brought in the other station at S5. It was an RAØ, and one call to him made the contact. Play with this for a couple of hours and you'll never go back to an omnidirectional antenna.

### Summary

Here's an electronically rotatable antenna that's 44% smaller in area than a single quad loop, stands only a quarter-wavelength high, and doesn't require retuning as the pattern is rotated. Of course, this antenna won't outperform a full-sized yagi/tower combination on the high frequencies, or an array of

phased verticals with an extensive ground system in an open field on the low frequencies. And, like all electronically rotatable arrays, the shape of the pattern changes with the direction chosen. But at moderate heights, and with no special ground preparation at all, it appears to do a first-class job. ■

### References

1. *The ARRL Antenna Book*, 1974, p. 200.
2. Massa, A. J., "The Perverted Double Vee Antenna," 73, June, 1978, p. 66.
3. Kraus, J. D., *Antennas*, McGraw-Hill, New York, 1950, p. 417.
4. Desjardins, B., "Phased Verticals for Easy DX," 73, June, 1978, p. 82.
5. Swank, J., "Novice Guide to Phased Verticals—Part 1," 73, June, 1978, p. 136.
6. *The ARRL Radio Amateur's Handbook*, 1976, p. 576.
7. Amidon Associates, 12033 Otsego Street, North Hollywood CA 91607.

Call or Write for Delivery or Quote

## RF POWER LABS

### V-350



Other Models in stock  
2 Meter Base Amplifier  
15W In — 400W Out

LEAVE A MESSAGE & WE'LL CALL YOU BACK!

**MADISON**  
**ELECTRONICS SUPPLY, INC.**

1508 MCKINNEY • HOUSTON, TEXAS 77002

713/658-0268

✓ M35

AG5K, W5VVM, WD5EDE, K5ZD, WA5TGU, WB5AYF, K5RC, K5BGB, W5GJ, W5MBB, K5AAD, N5JJ, WB5USV.

MASTERCARD • VISA

which might be covered on the exam. I have heard them saying they arose at 5 am to practice their code. This is nonsense.

The best asset to bring to your FCC examination is a relaxed mind. The best way to assure this is to go to bed early the night before and to do nothing of a technical nature upon awakening. No code practice, no last-minute peek into a textbook, no checking out of cram slips. Instead, have a relaxing shower, a good breakfast, a look at the morning newspaper—anything but ham radio. In this way, you arrive at the examination site with a mind that is capable of leisurely comprehending the code that will be sent to you.

### The Written Exam

Let's say that you've taken the code examination, you've been told that you passed, and now you can take your written examination. This is all there is between you and your higher class license. What tips can I offer to help you pass this portion of the exam?

Here are a number of things to keep in mind as you prepare for—and take—the written examination. Follow them and your success is virtually guaranteed.

1. Know your stuff. Very few people get through the exam if they don't know the material. You should get the necessary textbooks and study the material. Become as expert as you can with the technical side, operating procedures, and regulations.

2. Get as much practice as possible working on multiple-choice questions. Most textbooks offer sample questions and answers to give you experience in answering FCC-type questions. Study as many of these questions as possible *after* you've studied the material. Don't use the

questions as a method of studying; use them to help you check on your understanding of the material studied.

If you've done steps 1 and 2, you're ready for all those that follow.

3. You now arrive at the FCC office. If you follow the advice given above for passing the CW portion of the exam, you'll be refreshed and relaxed. This condition is as important for passing the theory portion as it is for the CW portion. No last-minute cramming, no peeking into the text to look up that formula one more time, no carrying of sheaves of paper to refresh your memory at the very last minute. Shut off the studying before supper the night before. Let your mind relax.

4. Bring a calculator. This saves mental wear and tear and helps ensure correct answers to mathematical problems.

5. When you are entering the examination room, you will be given the printed test, the answer sheet, and a blank piece of paper for calculations and scribbles. As you sit down, take out the two pencils you've brought along, and for the moment put aside the test booklet and answer sheet. Now, while your mind is still relaxed, write on the piece of paper every formula you feel you may have to use. Write down every item that may be a little shaky in your mind. As long as these formulas and items come from your mind, everything is perfectly proper and legal. Why do this? Because your mind is relaxed and it's easier to recall, say, what the formula is for capacitors in parallel than it is to recall the formula when faced with an actual question. That's how the mind works. Ohm's Law can take on some interesting variations in the mind of a ham who is wading feverishly through

an exam.

6. Once you've put on paper all your necessary formulas, open up the test booklet and see what the number of the first question is. Why do this, you ask? Don't all tests start with number 1? Not at the FCC, they don't! This test may start with 1, but it may start with 51, or 101. As soon as you see which number it starts with, take the answer sheet and mark the corresponding number with your pencil. This is where you start to answer questions on the sheet. Basic, you say? Obvious, you think? Yes, but we don't know how many aspiring hams (who knew their theory cold) failed the FCC exam because they gave beautiful answers to questions 51 through 100 in the spaces on the answer sheet marked 1 through 50. In short: Answer the question asked in the booklet at the exact spot on the answer sheet where the answer will be graded.

7. You're now ready to attack the first question. Here's the technique to follow: Read the first part of the question, the part before the multiple choices, but *do not* look at the five answers offered. See if you can mentally determine what the correct answer is before looking at the five choices. For example, if the question says, "The 'Q' signal for 'I am being interfered with' is . . .," your mind should pause and mentally seek the correct answer—QRM. Once thought, write it down on the sheet of scrap paper. If you don't do this, you are now faced with a confusing array of Q signals from which you must make a choice: QRS, QSK, QRQ, QRM, and QNX. In the pressure of an examination, you might make the wrong choice when faced with this selection. So, for each question, don't look at the answers first. Men-

tally determine what the correct answer should be, write it down on your scrap paper, and then check the answers supplied to see if your answer matches one of the exam's answers.

8. Having picked out the right answer, indicate it on the answer sheet, and be sure that you put the answer in the right spot (a, b, c, d, or e) and at the right answer number. Don't put a "b" answer in the "c" slot, and don't answer number 73 in the space for number 74. Be alert.

9. Continue this process with each question. At some point, you'll come across a question which you can't answer in your mind. Now what do you do? At this point, look at the "a" answer *only*. Does it seem to be the right one? If so, write "a" on the scrap sheet. And then go on to b, c, d, and e, seeing if a "better" answer appears. If it doesn't, write "a" on the answer sheet in the appropriate spot. If another answer appears that seems to be just as correct, you have to make a judgment as to which is more correct. Once you've done this, write the answer in the appropriate spot. Continue on through the exam.

10. Let's say you come across a question that you can't answer. You review the five answers and none seems appropriate. At this point, write the number of the question on your scrap sheet and go on to the next question. Don't fret. Don't worry. The FCC gives you quite a margin for error in the exam. One question doesn't make much difference. The main thing is to keep your mind at ease, relaxed, and happy. Go on to the next question and let your subconscious mind take over. While your conscious mind is scanning the next question, your subconscious mind will be poring over the question you just passed. At some mo-

ment, the answer just might pop out.

11. Continue with this procedure. Answer the questions you're able to answer. Pass the questions you want to do something about later, after noting their numbers on the scrap sheet. If your mind suddenly gives you the answer to a skipped question, stop in your tracks and return to the question. Immediately write down the correct answer in the appropriate spot.

12. When you have gone through the list of questions the first time, return to the ones you could not answer. Read each question carefully and see if you see something which you didn't see the first time. Many times, a second reading of the question gives you a new slant on what is being asked or on what is being offered as an answer. See if you can pick

out the correct answer for each skipped question.

13. If you cannot pick out one answer of the five offered, try to *eliminate* the incorrect answers in an effort to reduce your choices to two or three. When you have done this, pick the best-looking answer and write this on the answer sheet. Having made your decision, go on to the next question.

14. When all else fails, *guess*. Leave no question unanswered. You get no credit for an unanswered question. You may be lucky and guess the correct response.

15. After you have answered every question and have written the answers on the sheet, go back and check each answer on the sheet. Be sure it agrees with the answer you feel is correct. If the answer to 63 is "b", be sure "b" is indicated after 63 on the an-

swer sheet. In the pressure of an examination, most people will incorrectly list one or two answers. By reviewing each answer, you can just about guarantee yourself one or two "extra" points which may be critical in passing the exam.

16. To reduce the tension, consider taking the code on your first visit to the FCC office and the written examination on your second visit. In this way, you can concentrate your mental energy on the task at hand: copying the code at the necessary speed or choosing the proper number of correct answers to questions on theory and regulations. (This splitting of parts of the test is more easily accomplished in cities where the examinations are held weekly or monthly.)

There are only three reasons why anyone will fail an FCC examination:

1. *Lack of preparation.* If you haven't studied your material and if you can't copy code at the required speed (or a little higher), don't waste your time taking the exam. Miracles are not commonplace these days.

2. *Poor testmanship.* Unfortunately, a number of people who do know their stuff and who can copy code at the required speed will fail an FCC examination. This article is designed for this group. By following the principles outlined, any upgrading candidate should find his or her chances of success improved immeasurably.

3. *Nerves.* If you prepare sufficiently and do what this article suggests, you may be pleasantly surprised to find that your "nerves" have disappeared.

Good luck on your next exam! ■



Model 250-0046-001

## NYE VIKING Automatic Phone Patch FCC approved!

Type acceptance registration under Part 68 of the FCC Regulations allows direct connection to telephone lines!\*

The new Nye Viking Models 250-0046-001 and 003 furnish hams with the very finest of interface connections with telephone lines\* available! Each comes complete with 7' connector cord and quick connector plug and has new, telephone company approved circuitry to protect company equipment and telephone lines. This eliminates the need (and cost) of a telephone company-supplied coupling device.

The Nye Viking Model -001, without speaker, provides connection to your own external speaker. Model -003 has built-in speaker, and is designed for use with most transceiver installations.

Model 250-0046-001 \$45.50

Model 250-0046-003 \$55.50

\*Phone Patches may not legally be connected to party, or pay phone, lines. Certification applies only to lines in U.S.A.



Available at leading dealers throughout the U.S.A. or Call 1-800-426-2742.

WM. M. NYE COMPANY, INC.  
1614 - 130th Avenue N.E., Bellevue, WA 98005

✓ N4

# FM-88 & FM-88S



FM-88 #345



FM-88S; WITH 800 CHANNEL SCANNER #439

## NEW FROM CLEGG

### SETTING NEW STANDARDS IN 2 METER FM FOR THE 80's!

In the tradition of the famous FM-DX and the popular FM-28 Clegg proudly announces the 2 Meter FM Transceiver of the next decade.

Thousands of owners of our earlier FM-28 have discovered that the clean 25 watts output gets them through on SIMPLEX or full quieting into repeaters where their earlier 10 watt rigs couldn't make it. And the super sensitive, selective receiver typically outperforms most of the others. Of course, the full 144-148 MHz coverage in 5 KHz synthesized steps made operating an FM-28 a real pleasure.

By popular demand we have added a number of desirable features to the FM-28. Like continuously adjustable power output. And coverage of MARS and CAP frequencies. And improved Touch Tone performance. And even better frequency stability.

Then we tightened up on our general performance specifications. And we instituted a long time "burn in procedure" to catch those few cases of "infant mortality". And each radio is completely tested three times to assure that our customer not only gets a radio that meets our specs but will have highest assurance that it will continue to do so for many years.

The standard FM-88 provides complete coverage from 143.0 to 148.995 MHz in 5 KHz steps and is internally equipped to accommodate  $\pm 600$  KHz standard repeater splits as well as SIMPLEX. It is capable of accommodating two additional "odd ball" repeater splits for those areas having one or more non-standard repeater pairs and for CAP or MARS applications.

The FM-88S retains all the features of the FM-88 but provides the owner SCANNING flexibility exceeding that of transceivers costing hundreds of dollars more. Virtually unlimited number of memorized channels can be stored and scanned. Or the entire 2 meter band can be scanned. Or a selected segment can be scanned. And it can be programmed to hold on a received signal. Or to just pause a few seconds on each active channel. Of course the digital display always displays just what's happening. Perhaps best of all—the SCANNER option can be added to your standard FM-88 at any future date should you later elect this option.

So—if you like the FM-28 you'll love the FM-88 and FM-88S. And if you are one of the underprivileged who doesn't have an FM-28, now is your opportunity to join the thousands who "know what good is" as they say in Lancasterese.

#### SPECIFICATIONS

##### TRANSMITTER

Frequency Control	: Hetrodyne generated by product of Phase locked VCO and OFFSET Crystal
Transmit Frequency Offset	: Panel selectable for 600 KHz; SIMPLEX and 2 optional non-standard Repeater Offsets
Modulation	: Direct FM; Adjustable 3 to 15 KHz deviation (Factory set at 5 KHz)
Audio Input	: 600 ohms
Microphone	: 600 ohm dynamic with push to talk switch
Power Output	: Continuously controllable from 1 to 25 watts
Spurious Outputs	: Down 66 dB (typical) 60 dB (min.)

##### GENERAL

Frequency Coverage	: 143.00 to 148.995 MHz in 5 KHz steps
Frequency Control	: Digitally synthesized PLL system
Frequency Stability	: Temperature: Less than 30 Hz/°C Voltage: Less than 100 Hz for $\pm 15\%$ change
Modulation Type	: 16F3
Supply Voltage	: 13.8V DC $\pm 15\%$ , Negative ground
Current Drain	: Transmit: HI (7A) max. LO (2A) Receive: .8A Average
Antenna Impedance	: 50 ohms nominal
Size	: 2-5/8(H) x 6-5/8(W) x 10-3/4(D) (exclusive of controls)
Weight	: Approx. 7 lbs. net; 9 lbs. shipping
Accessories Supplied	: Microphone, mobile bracket, 2 power cables, desk stand
Accessory Provisions	: Rear panel provisions included for Tone Pad and P/L, Remote PTT, External Speaker, Discriminator meter, Keyed DC.

##### RECEIVER

Frequency Scheme	: Dual conversion superhetrodyne with 16.9 MHz and .455 MHz IF
Sensitivity	: .30 uv (max.) for 12dB SINAD (.25 uv typical) .20 uv squelch threshold (.15 uv typical)
Spurious Response	: -65 dB (min.)
Selectivity	: $\pm 7$ KHz at -3 dB $\pm 12.5$ KHz at -70dB
Audio Output Power	: 1.5 watts (min.) at 10% THD
Audio Output Impedance	: 8 ohms
Internal Speaker	: 3-1/2", High efficiency 8 ohm

The scanner assumes full control of the synthesizer, making it unnecessary to use the frequency controls on the transceiver once the scanner is programmed. An internal battery holds the memory when power is turned off.

#### SPECIFICATIONS:

Scan capability—144.000 to 147.995, 5 KHz spacing (800 channels)  
Memory capability—800 channels  
Scan time—Approximately .5 seconds per channel  
Channel time-out—5-10 seconds with manual override  
Program in just seconds from front panel controls

The FM-88 purchased without the SCANNER option can be factory updated to "88S" status at any future date.

#### CALL OR WRITE FOR BROCHURE:

**Clegg** Communications Corp.  
1911 Old Homestead Lane  
Greenfield Industrial Park East  
Lancaster, PA 17601  
(717) 299-7221 ✓ C3

**ALL THESE FEATURES PLUS 1 YEAR WARRANTY**

# Muffin Fan Mania!

— a compendium of knowledge about electromechanical air movers

*Rick Ferranti WA6NCX/1  
215 Herrick Road  
Newton Centre MA 02159*

The increasing price and rarity of vacuum tubes and other components in your ham rig make it imperative that it run as cool as possible. Have you ever wondered when those poor, hot components in the rig will finally melt into oblivion? The heat generated by the power-handling parts of the transmitter

should be directed well away from the rig, preventing a possibly expensive episode in radio self-annihilation. Fortunately, there's an easy way to alleviate the woes of an overheated goodie in your station.

An electromechanical air mover, commonly called a fan, can be employed to keep things cool when thermal overload becomes imminent. In fact, the electronics industry is utilizing these gems in a variety of

configurations more and more frequently as component densities escalate and enclosures shrink. One estimate puts the number of miniature air movers at the all-time high of 80-million dollars worth just last year.<sup>1</sup> With all this expensive hot air blowing around, there must be some good reasons for you to consider installing an auxiliary cooling device in your station.

There are indeed several

good reasons for helping your rig stay cool: Components and tubes last much longer, frequency stability is improved with less thermal expansion of coils and coil forms, and smoked capacitors and resistors due to simple overheating just don't occur.

The fans I'll be discussing in this article are the so-called tubeaxial fans, normally known as Muffin™ fans (EG & G Rotron trademark). These things usually



Photo A. A typical collection of fans available at flea markets for under \$10. Visible are Pamotors, a Feather, Centaur, Caravel, and Boxer fans.

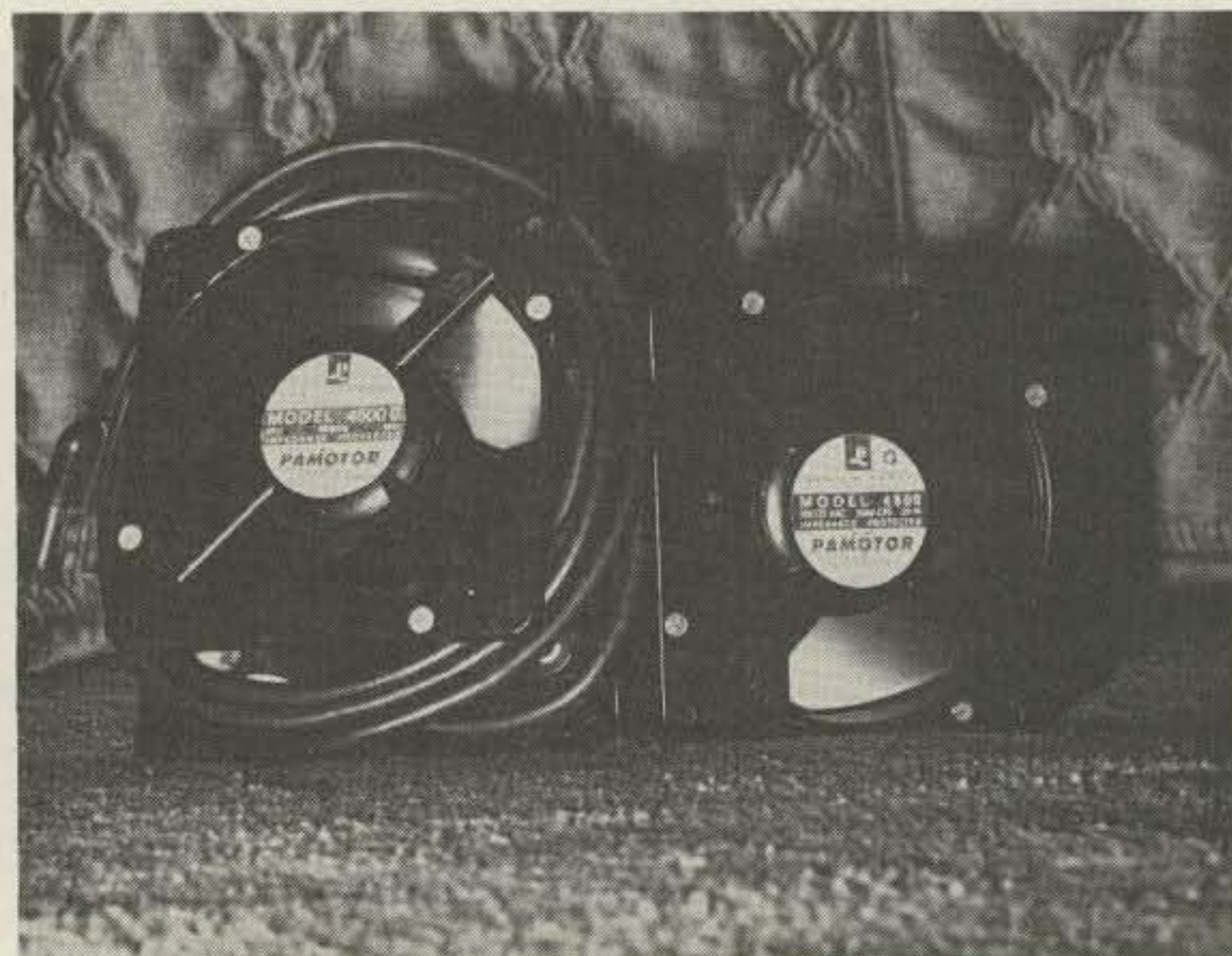

Photo B. A couple of fine-running Pamotor fans from Germany.

have square or circular housings with an "inside-out" motor—the shaft part of the motor is the fan hub with the moving blades attached. They're by far the most popular and useful fans available to the radio amateur.

Almost all ham rigs today have a well-designed natural air ventilation system called "convection cooling." This simply means that the warm components in the rig heat up the air nearby, causing it to rise and draw cool air in from the bottom of the case. This works great, but the idea (and cooling effect) is tremendously enhanced by placing a fan in the right spot on or by the rig. The result is a much cooler running operation.

### Choosing a Fan

I've compiled a list of the most common fans you'll find at a swapfest or surplus store in Table 1. These are the Rotron trademark names, listing the amount of air moved (in cubic feet per minute, or cfm), and some very dated 1970 prices so that you can get an idea of their original market value. Other fine fans are made by Pamotor, of West Germany, and the Boxer fan from IMC Magnetics. Be sure to inspect

Trademark Name	Cfm	Comments	Price
Sentinel	100	Stainless steel ball bearings	\$25.00
Centaur CT3A2	100	Sleeve bearings, 15 Watts	16.90
Mark IV Muffin	100	Very popular	12.05
Whisper	65	Super quiet, 6 Watts	12.05
Sprite	35	3½"-square, 11 Watts	14.95
Spartan	110	Military, stainless steel BB	45.50
Feather	270	SS BB	36.85
Saucer	280	SS BB	70.40
Caravel	575	BB	29.70
Tarzan	350	BB	46.65

Table 1. EG & G Rotron fans, with 1970 prices.

your purchase for dented or bent blades, and also spin the blades a bit to make sure they turn very freely.

Let me emphasize at the outset that you don't need much in the way of cfm to cool an already well-designed rig. The important operating factor to consider is the noise generated by the mechanical beast. The key to quiet success is a slow motor speed. For example, I put a little 50-cfm Pamotor 4800A (very quiet) on top of a normally frying-hot 17-tube Polycomm 2-meter rig, and the transceiver ran ice-cool thereafter.

So, pick a fan which doesn't take much power (therefore, it will be running slower) and which doesn't have more than about 75 cfm or so of cooling power. However, flea markets and surplus stores often don't have fans

which meet such stringent requirements. If you do get a fast, noisy fan, there are easy ways to slow it down, as I'll mention later.

By the way, 220-V fans are ideal for ham applications—they run beautifully on 120 V, retaining 60% of their original air-moving power with only 20% of their original noise, and they're cheaper, too. Surplus companies often offer these at reduced prices because they were not originally specified for the 120-V line. Best buys here are the 220-V Feather, Saucer, and Sentinel, or equivalents.

### Mounting a Muffin

The easiest way to determine what part of your rig gets hottest is simply to turn it on, let it warm up, and feel the top of the case for hot spots. Obviously, the area on top of the finals will be warmer than the

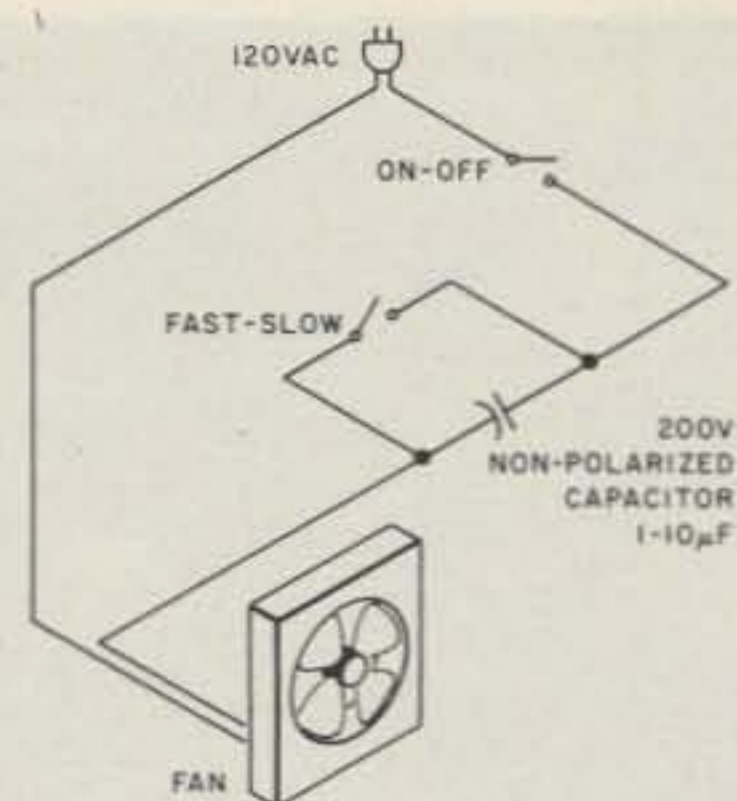

Fig. 1. Schematic of method to slow down a fan with a series non-polarized capacitor, 1 to 10 uF, at 200 WV minimum.

rest of the radio, so that should be your priority target. If there are other heat-producing components in the rig, you can place the fan so it pulls the most air past the finals and gets the rest of the rig with somewhat reduced air-flow. A larger-diameter fan, properly slowed and quieted, is better for application in all-tube transmitters, while smaller fans do nicely in "all solid-state except the finals" rigs.

I don't recommend putting fans on receivers. They aren't necessary in a decent rig because there just isn't enough heat generated by its low-power components to warrant auxiliary cooling. If you want to cut down heat in an old-



Photo C. This Muffin fan sits over the finals and is mechanically damped by four felt feet.



Photo D. A friend's setup with the fan bouncing merrily on four pads of foam rubber.



Photo E. The unclassy method of slowing down a fast, noisy fan, with power resistors. These two units need to be mounted in a well-insulated box, or be replaced by a much more elegant capacitor.

er tube-receiver, replace the rectifier tube with its solid-state equivalent (with suitable dropping resistors), and put in an LM-380 audio IC instead of those push-pull 6V6s.

When you mount the fan on your transmitter or transceiver, it's always best

to place it on top of the rig so that it aids the natural tendency of hot air to move up and out. Don't try to blow air through the rig—just pull the hot stuff up and away. This makes it imperative that you keep the radio elevated on its mounting feet (don't take

them off to save space), and that the area beneath the rig is kept as dust-free as possible. A too-powerful fan will suck dust and debris into your transmitter's innards, and a mild airflow is really all you need to keep the radio cool and clean.

You can kill potential mechanical vibration problems by sticking some foam rubber tape or thick felt under the fan. There's no need for an airtight connection between fan and case; just put something between them as a mechanical damper. The Pamotor I use has four felt pads glued to its underside, one in each corner, which work fine.

### Quieting All That Coolness

As I mentioned above, the number one requirement for your fan is that it run quietly. In fact, plenty of air will circulate at the minimum noise level when the fan is running just a little faster than the rpms necessary to keep it going. How do you accomplish this with an ordinary Muffin?

There are two ways. First, you can put a 350-Ohm power resistor in series with the fan, experimenting with the values until it runs the way you like. This, however, generates heat—an advantage only if you have a cold basement shack and need a footwarmer! You should be very careful to thoroughly insulate the resistor from the outside world lest a shock hazard be created. Put it in a bakelite box with vent holes—and no, you don't need another fan to cool the resistor.

The second way is slightly more elegant, generating no heat. Simply put a 1-to-10-uF (again, experimenting with the values) non-polarized capacitor in series with the fan. Those old Pyranol non-polarized metal-cased capacitors

clunking around in your junk box will work fine; you need at least a 200-V rating here. Don't use electrolytics—they aren't made for pure ac work. If you like to play with numbers and simple math, it's an easy matter to calculate how much capacitance you'll want. You need to know Ohm's law, the formula for capacitive reactance, how much power your fan draws, and how much voltage you want it to run on. For me, however, it's easier to slap in a few microfarads and see how fast she goes.

Fig. 1 shows a simple schematic of the fan and capacitor; I've added a switch across the capacitor so that you can zoom to full speed when you want to cool yourself off after a hot day's work at the rig. Again, be sure to put the capacitor and switches in a well-insulated box so that there's no chance of a shock. Be careful when you're experimenting with values—there's 120 V floating around on your connections.

Of course, if you have a 220-V fan, chances are it'll run slow and quiet by simply plugging it into 120 V. Just add some felt or foam padding to its mount, plopping it on top of the rig, and be amazed how coolly the station runs.

The accompanying photos show evidence of a friend's mania for collecting these wonderful fans. Oddly, he never replaces tubes or other components in his well-used equipment. You'll have the same fantastic results when you simply and easily cool off the overheated parts in your own rig. ■

### References

1. *Electronic Buyer's News*, February 27, 1978, pp. 26ff. Other articles on the topic of Muffin fans have appeared in *Ham Radio*, November, 1972, and *CQ Magazine*, May, 1966.

**DADE RADIO CLUB presents**  
**1980**  
**Southeastern Division Convention**  
**& 20th Annual**  
**TROPICAL HAMBOREE**



**Flagler Dog Track**  
**Miami, Florida**

**January 26-27, 1980**





REGISTRATION:  
 ADVANCE - \$3.00  
 DOOR - \$4.00

FREE PARKING  
 INCLUDING OVERNIGHT SPACE  
 FOR COMPLETELY SELF-CONTAINED RV'S  
 ADVANCE RV SPACE RESERVATION IS RECOMMENDED

For Additional Information Write:  
 DADE RADIO CLUB, INC.  
 P.O. Box 350045 - Riverside Station  
 Miami, Florida 33135

# HOLIDAY SPECIALS!

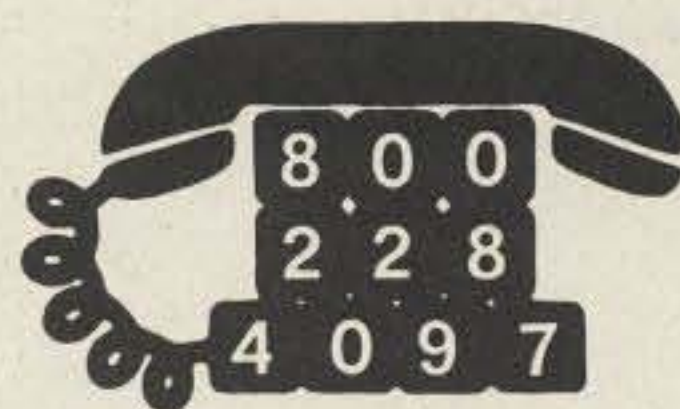
Call  
Toll-Free



Punch thru the QRM with E.T.O.



Model 374  
"No tune up"



Model 76A  
2+kw

Call for low price quotes on ETO amplifiers.

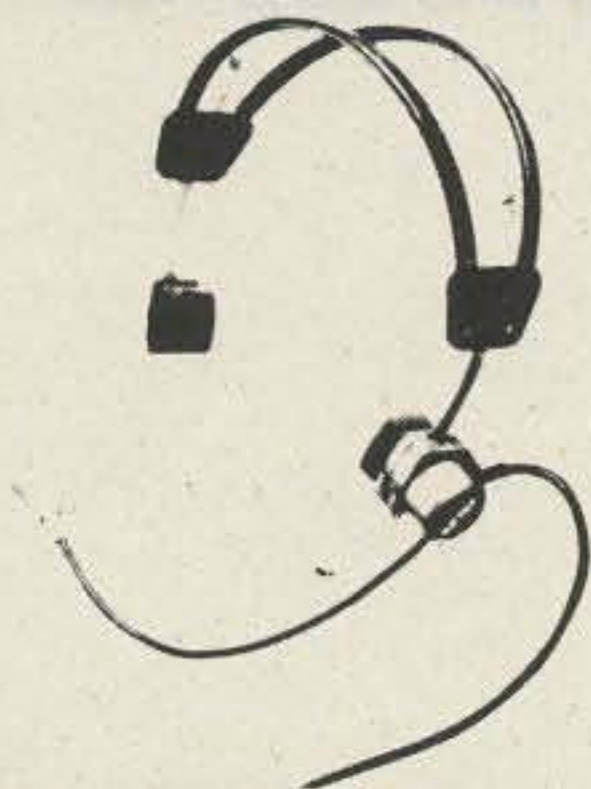

Telex Model 88  
Headset only \$49.95



Dentron GLA-1000 Amplifier  
List -\$379.50 Only \$299.95

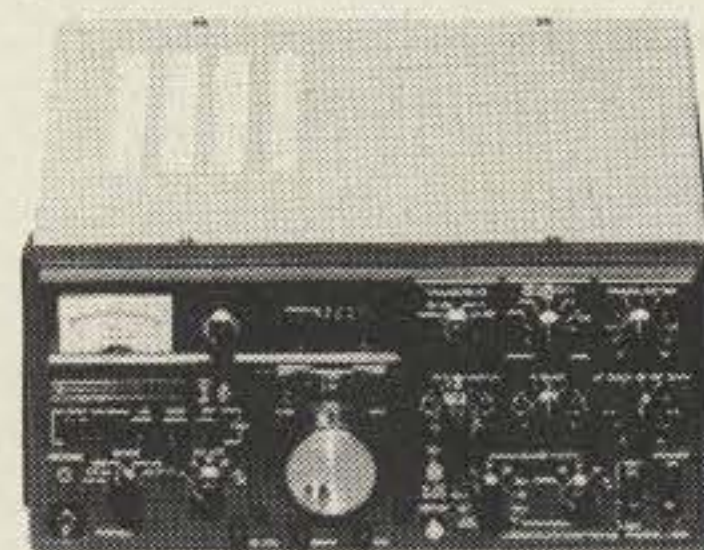

Kenwood R-820 Receiver  
List \$1099.00  
Special \$899.00



NEW Kenwood R-1000  
Receiver  
List \$499.95  
Call for discount price



Panasonic RF-4900  
General Coverage Receiver  
List \$549.95  
Ours - \$399.95

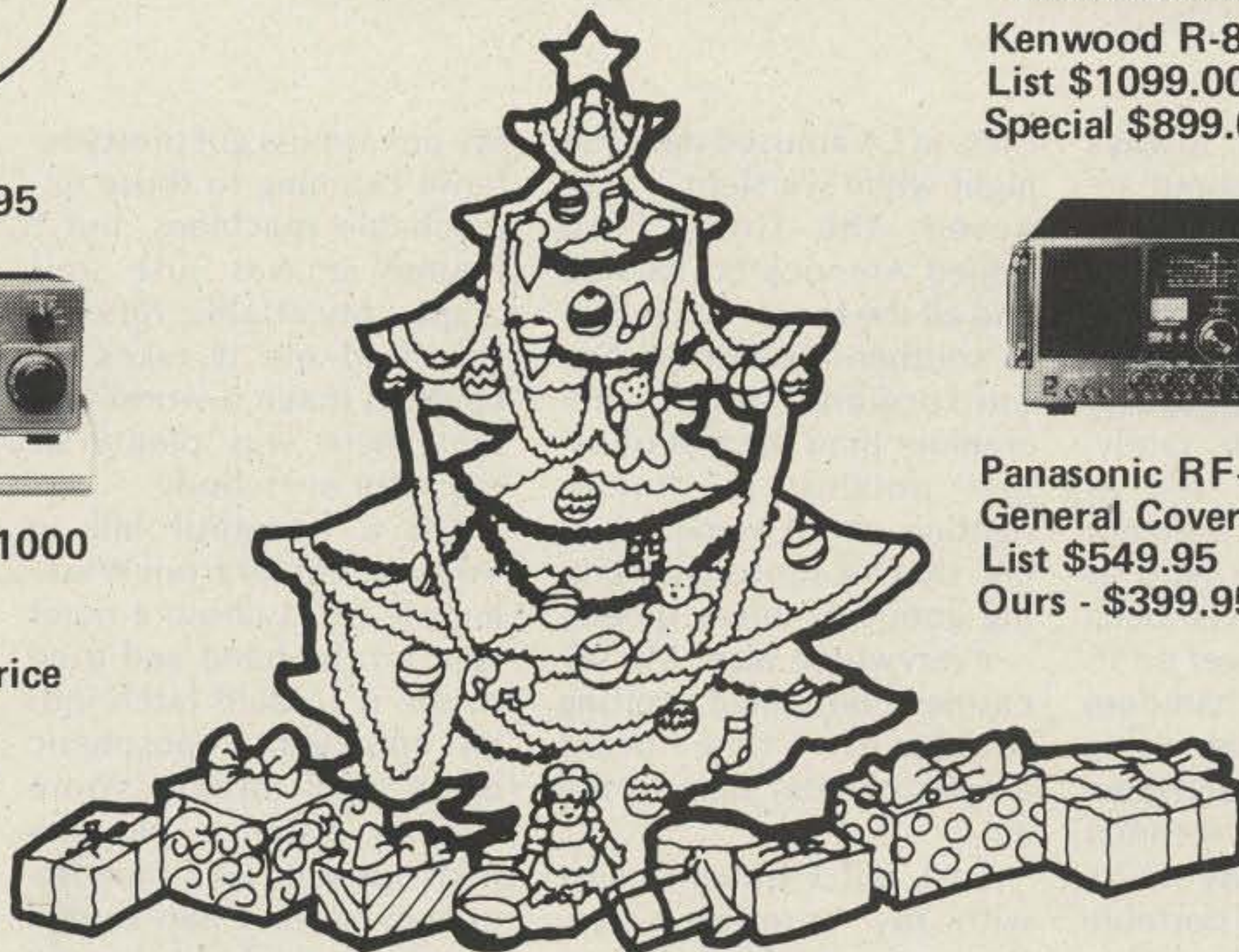

REGULAR SPECIAL

		REGULAR	SPECIAL		Regular	Special
Swan WM6200	VHF Wattmeter	\$ 69.95	\$ 54.95	KenwoodTV-502	2 Meter Transverter	299.00 259.95
Ten-Tec Model 544	H.F. Transceiver	869.00	729.00	Yaesu FT-901DM	H.F. Transceiver	1459.00 1199.95
Say SPS-20	Power Supply 20Amp	159.95	109.95	Yaesu FRG-7000	General Coverage Receiver	655.00 519.95
Drake MN-4C	Antenna Tuner	165.00	129.95	Tempo S-1	Synthesized hand held	349.00 309.95
Drake 34PNB	Noise Blanker	100.00	69.95	Bencher BY-1	Paddle	39.95 36.95
Drake 4NB	Noise Blanker	74.00	59.95	Drake TR7/DR7	H.F. Transceiver	1395.00 1219.95
Drake 1525Em	Encoding Mic.	49.95	39.95	ICOM IC-255A	2 Meter Mobile	449.00 359.00
Swan MKII	2KW Linear Amp.	995.00	799.00	Midland 13-510A	2 Meter Mobile	439.95 359.95
Dentron	Jr. Tuner	79.95	59.95	Shure 444	Microphone	70.75 39.95
Avanti AH151.3	Thru the Glass Antenna	34.95	29.95	Yaesu CDU-2500RK	FM Mobile	585.00 499.95
Dentron MT-2000	Antenna Tuner	199.95	149.95	Kenwood TR-7600	FM Mobile	375.00 299.95
Kenwood SP-820	Speaker with Audio Filters	65.00	59.95	Kenwood TS-700SP	2 Meter Radio	799.95 629.95

✓ C58



## Communications Center

443 N. 48th, Lincoln, Nebraska 68504

In Nebraska Call (402)466-8402





# Are Repeaters Ripping Us Off?

## — some thoughts about open access to scarce frequencies

Something has always bothered me about repeaters. It's never been anything like hatred or even a serious gripe. I've only felt a vague uneasiness when reading about them, thinking about them, or, lately, when using one. It's as though something were not quite right, and as hard as I've tried, I've never been able to put my finger on it.

I came up in hamdom from the Novice ranks using junky eighteenth-hand gear, and it was not until recently that all those classy multi-hundred-dollar FM portable transceivers fell within reach. So it still strikes me as odd that people will earnestly ask, "QRZed the frequency?" when no living soul is calling them on any frequency. Each new country has its own language, I guess, and I decided my uneasiness was only the acclimatization lag time of a stranger in a strange land.

The tales of repeater wars and users'-rights con-

flicts in LA amused me. One night while we slept, I supposed, the Good Lord tipped America on its side and all the loose nuts fell into southern California. No, Californians aren't any crankier than the rest of us, just noisier. If they're fighting about something in LA, they're probably fighting about it—more quietly—everywhere else. My uneasiness remained, getting stronger every time I heard a new repeater take to the air.

Last fall I traveled east with my brand-new synthesized portable, clicking my way across the band on those marvelous magic thumbwheels. Repeaters were everywhere, and I talked on quite a few. There were many more which just didn't seem to hear me, regardless of how close I was. By the additional magic of PL<sup>TM</sup>, they had shut themselves off in a world of their own, occupied by a few dozen calls and no more.

My uneasiness got pretty intense listening to those unreachable machines, but I figured it was just sour grapes. My affable, rational side told me it takes all kinds to make a world and that there was plenty of room for everybody.

On a beautiful hill in Virginia, not far from Washington DC, I chose a quiet spot on the band and tried to see if I could latch into an apparent tropospheric duct and make some 2-meter distance. No one had spoken on that frequency since I had turned on the rig (about twenty minutes before), so I did the unthinkable and called "CQ 2 meters." A "good ol' boy" voice came back immediately and told me to kindly get off his private repeater input.

I'm used to 20 meters, perhaps a little more than I should be. When somebody says, "This frequency is in use," I apologize and scram. So, standing on my

beautiful Virginia hilltop, I apologized and scrambled. It didn't hit me until late that night, while in the shower with a cold spray on my face, that my hilltop frequency had *not* been in use for at least twenty minutes. "Cool off, Chief," I told myself. "After all, it was his frequency." *His* frequency?

Like hell!

Suddenly, everything which had ever bothered me about repeaters became as clear as cocktail ice. I laid hands on a license manual and thumbed frantically until I found the paragraph in the rules which had eluded my thinking:

97.63. Selection and Use of Frequencies. (a) An amateur station may transmit on any frequency within any authorized amateur frequency band.

That seems pretty plain to me. Every ham who sweats his way into pos-

session of a license shares all frequencies permitted his license class. Nobody can stake out a point on the radio dial and defend it against all comers. 'Tain't legal, friends.

One outcome of Repeater Appreciation Day in LA was the demonstration of the fact that a repeater is an extension of the repeater licensee's home station. The only user with any rights is the repeater owner. Everybody else is a guest in the man's shack, and the owner may set any rules for guests which he desires. This seems to include limiting guests to whichever group the owner desires to have use the machine. That seems to make sense. After all, he paid for the repeater, and he keeps it running.

So much for the machine itself. But what about the frequency? A great many repeaters in urban areas now operate twenty-four hours a day. That means that, in effect, one man's ham station is sitting on a pair of frequencies for what may turn out to be years, with breaks for maintenance only. If I did that on 20 meters, they'd lock me up and throw away the key.

Of course, a repeater's carrier is not on at all times. But every ten minutes, like clockwork, comes the little announcement of call sign, location, local time, temperature, and God knows what else. In the wee hours of the morning, the repeater may not be keyed up for hours on end. But you can bet that, should a friend and I attempt to work simplex on the repeater's input frequency on any regular basis, a gang of DF-loaded station wagons would descend on us, loop antennas twirling, threatening to beat the both of us to marshmallow cream. The ham bands belong to all hams—says so right on the label.

This problem hasn't arisen until recently because, until recently, repeaters were something of a novelty. They were the new kids on the band, one here, one there, with lots of room in between and no objections from any of them to the ham who just wanted to jump in and say hello. Then the baby-boom babies grew up, bought Icoms, and started planting repeaters across the band like so many Johnny Appleseeds. We now have wall-to-wall repeaters, with more hams than all of them can handle. Hams, I've found, are incredibly courteous. If they find they're interfering with someone, they'll gladly slide up or down the band. But these days you can't take one step on 2 meters without stubbing your toe on somebody-or-other's repeater. Even more commonly, those repeaters are closed to the general hamming public. Do we have a problem? We sure do!

I now see the LA users'-rights crazies in an entirely new light. Out in the State of Excess, with more of everything per square inch than anywhere else, free space on the 2-meter band is probably pretty scarce. I have a hunch that the screamers are motivated by a feeling, just beneath the surface of rational expression, that the people who operate repeaters owe them something for the airspace that the repeaters take up.

In this new world of scarcity, nobody gets anything for nothing. We hams occupy our little sliver of God's good frequency spectrum because we provide free communication in times of national and international need. Have you forgotten that already? You shouldn't, because it's the only card we hold among the high rollers at WARC. A repeater cannot slide around the bands at will,

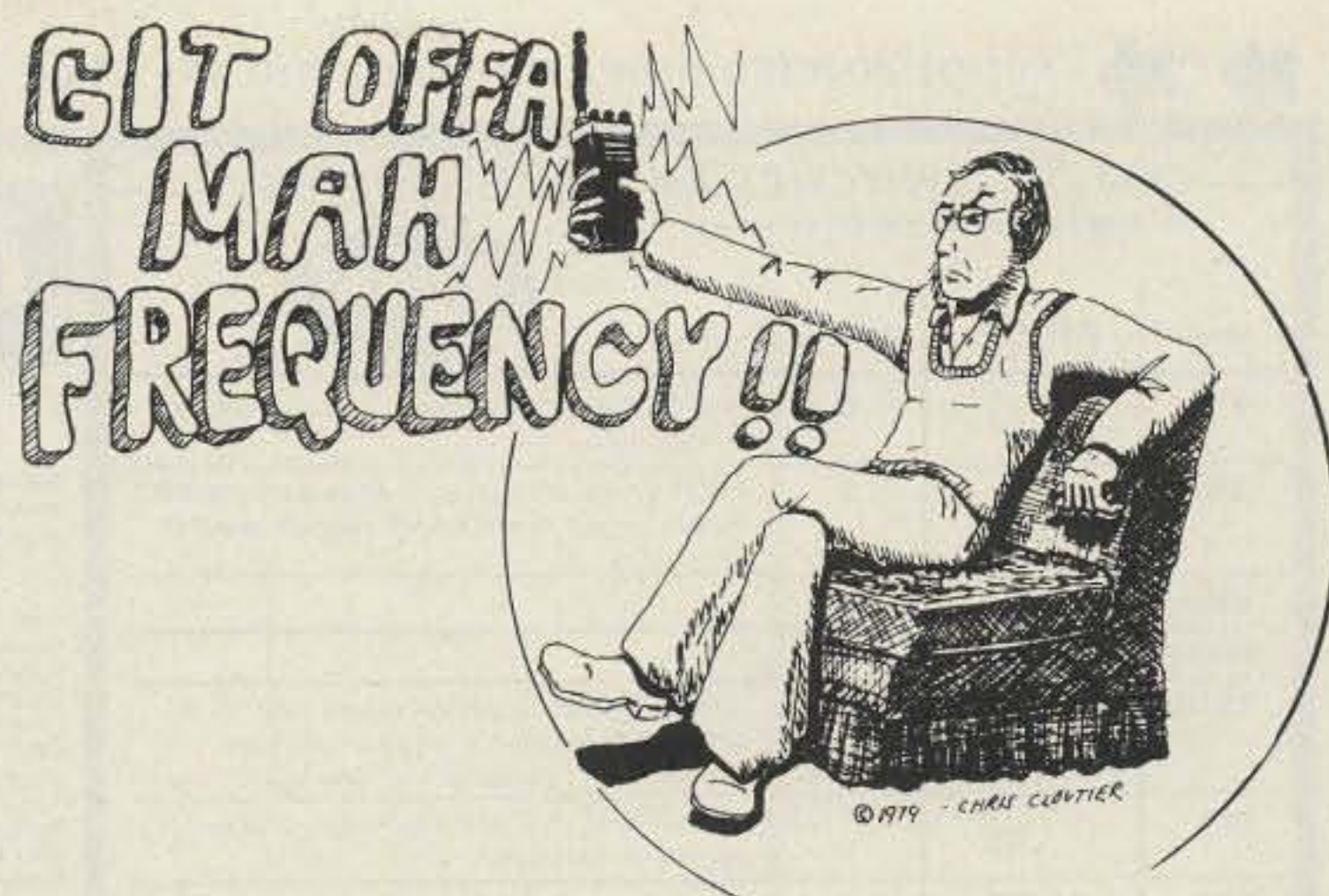

the way that a man with a transceiver can. If a repeater effectively monopolizes a pair of frequencies, where's the justification?

At the present time, there isn't any. A repeater is an extension of a ham's private station, to do with as he pleases. My reading of the rules is pretty plain: A frequency pair is no man's own. If repeaters are to continue to sit on increasingly scarce frequencies, they must do what all the rest of us do for our country and our world—provide a service.

If a visiting ham slides into town and gets lost, he can key up a repeater and ask directions, right? Maybe, maybe not. If some drunk plows into him, he can key his HT and summon an ambulance on a repeater, right? Well, maybe... if he has the right PL. Otherwise, he'll just have to listen to the locals jaw about how soon they'll reach the work QTH while the drunk bleeds to death.

Rendering a worthwhile service may be no more complicated than keeping a repeater open to all incoming carriers, regardless of whether the incoming station is a club member, financial contributor, or somebody nobody has ever heard of.

I can already hear the gnashing teeth of repeater operators wondering how

they'll support their machines if people aren't required to support them. Well, when I decided I wanted a transceiver, I saved my nickels and dimes until I got one. I did it because I *wanted* to. If a repeater club can't rake in enough voluntary support to keep its repeater running, maybe that repeater should be run in a less expensive location, or with reduced power, or without autopatch. Or maybe not at all. Does anyone else get the impression that there may be a few too many repeaters floating around?

Certainly, I see no justification at all for closed repeaters. They provide a service to only those few who are required to pay financial support, and still deny use of the frequency to licensed hams who do *not* want to use the repeater. This is a double violation of the rules that really ought to be looked at a little more closely. The users of repeaters have no rights to the machine, but they do have a right to an equal crack at the airspace. Or, perhaps, on the other hand, if the repeater keeps all rights to the frequency, then all hams deserve an equal crack at the machine. Does anyone agree? It's something we should talk about before we all become strangers on 2 meters, shouting vainly at repeaters which choose to hear only their favored few. ■

Tempo, Ten-Tec, Texas RF, Tonna Antennas, TPL, Tri-EX, Van Gorden, Vibroplex, Vidaire, Vista, VHF Engineering, VOMAX, Wilson, YAESU?

COAXIAL SWITCHES AND ACCESSORIES  
for antenna selection and RF switching



Model	PRICE	Outputs	Remarks
375	19.75	6	PROTAX switch. Grounds all except selected output circuit.
376	19.75	5	PROTAX switch. Grounds all except selected output circuit. Sixth switch position grounds all outputs.
550A	16.95	5	
550A-2	13.75	2	
551A	17.95	2	Special 2-pole, 2-position switch used to switch any RF device in or out of series connection in a coaxial line. See figure (over).
556	.95	-	Bracket only, for wall mounting of radial connector switches.
590	18.50	5	
590G	18.50	5	Grounds all except selected output circuit.
592	17.25	2	
595	19.75	6	Grounds all except selected output circuit.

COAXIAL SWITCHES AND ACCESSORIES for antenna selection and RF switching. These high-quality switches have set the standard for the industry for years. Ceramic switches with silver alloy contacts and silver-plated conductors give unmatched performance and reliability from audio frequencies to 150 MHz. B&W coaxial switches are de-

signed for use with 52- to 75-ohm non-reactive loads, and are power rated at 1000 watts AM, 2000 watts SSB. Connectors are UHF type. Insertion loss is negligible, and VSWR is less than 1.2:1 up to 150 MHz. Crosstalk (measured at 30 MHz) is 45 dB between adjacent outlets and -60 dB between alternate outlets.

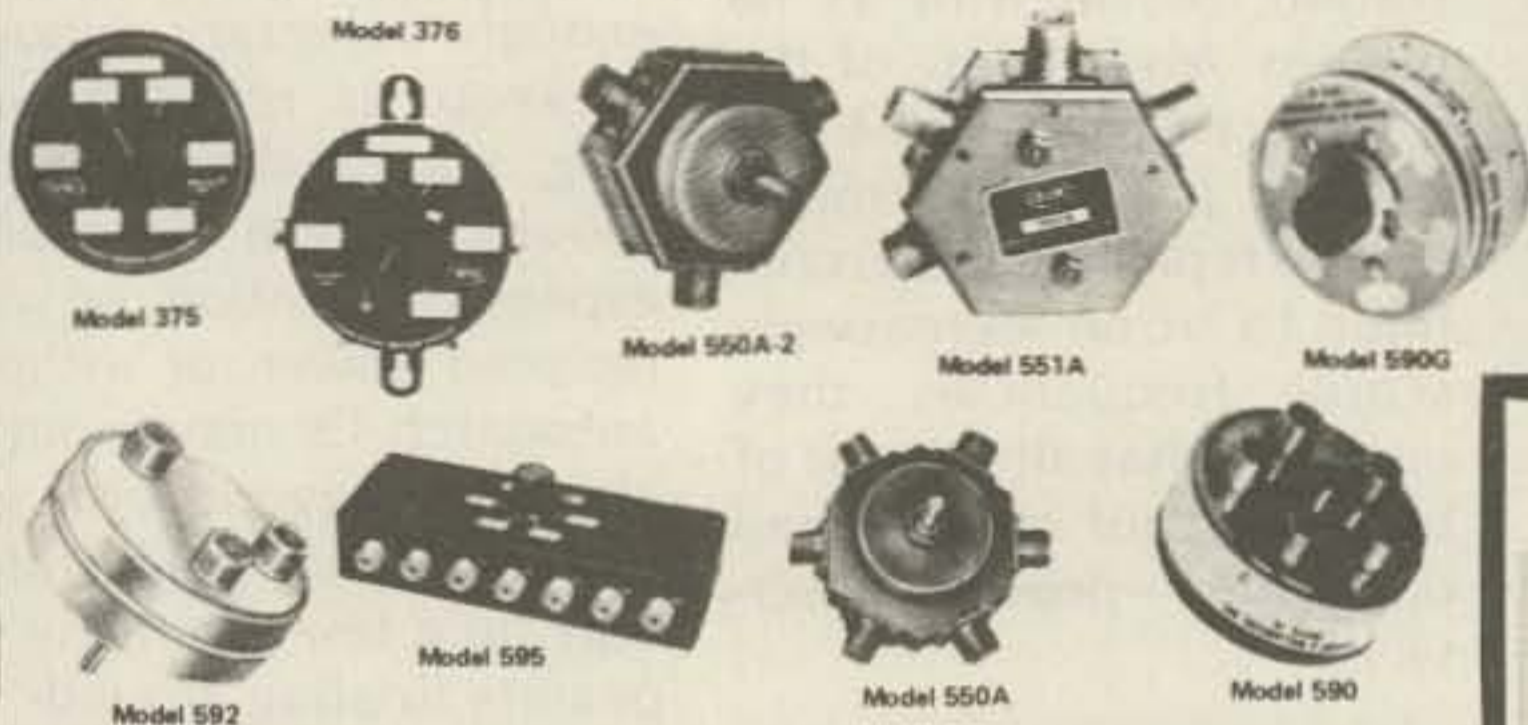

PRODUCTS OF SOUND RESEARCH  
**TELEX**  
COMMUNICATIONS, INC.

PROFESSIONAL HEADPHONES & HEADSETS

BOOM MIC HEADSETS

For the ultimate in communications convenience and efficiency select a boom mic headset. Long-time favorites of professional communications, boom mic headsets allow more personal mobility while always keeping the mic properly positioned for clear voice transmission. Boom microphones are completely adjustable to allow perfect positioning. And, boom mic headsets leave both hands free to perform other tasks.

All models are supplied with "close talking" microphones to limit ambient noise pick up and provide superior intelligibility. Each model has a convenient, volume push-to-talk switch, which can be wired for either push-to-talk control or mic circuit interrupt for voice operated transmitters. The switch may be used as a momentary push-button or it can be locked in the down position. All models have tough, flexible 8 foot cords which are striped and taped, unintermitted. Communication gray with black trim.

MODEL	C 610	SWL 610	C 1210	C 1320	CM 610	CM 1210	CM 1320	CM 1320S
Headphone Sensitivity Ref. 0002 Dynes/cm <sup>2</sup> @ 1mW input, 1kHz	103dB SPL ±5dB	103dB SPL ±5dB	103dB SPL ±3dB	105dB SPL ±5dB	103dB SPL ±5dB	103dB SPL ±3dB	105dB SPL ±5dB	105dB SPL ±5dB
Headphone Impedance	32 20 ohms	2000 ohms	32 20 ohms	32 20 ohms	32 20 ohms	32 20 ohms	32 20 ohms	32 20 ohms
Microphone Frequency Response				50 8000 Hz	50 8000 Hz	50 8000 Hz	50 8000 Hz	50 8000 Hz
Microphone Impedance				High	High	High	High	High
Microphone Sensitivity Below 1 volt/microbar at 1kHz				-51dB ±5dB	-51dB ±5dB	-51dB ±5dB	-51dB ±5dB	-51dB ±5dB
Price:	\$10.45	\$12.25	\$29.70	\$41.80	\$47.20	\$62.75	\$75.25	\$59.95

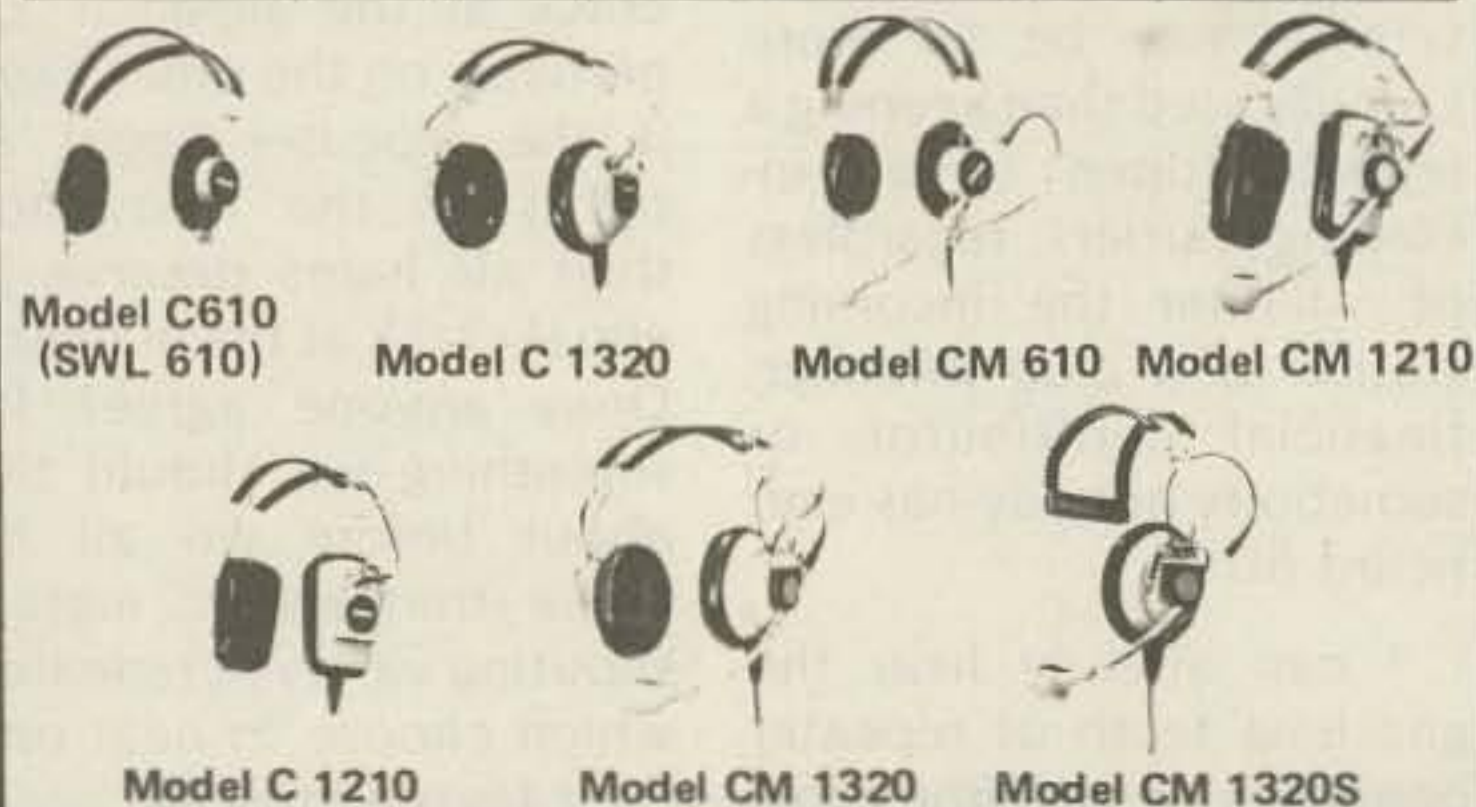

BE PREPARED FOR CYCLE 21 GET HY-GAIN'S NEW LONG-JOHN'S THE STACKABLES

Specifications:

Order Number	377 2058A	376 1158A	375 1058A
Model Number			
	\$289.95	\$169.95	\$119.95
SWR lat resonance	Less than 1.5:1	Less than 1.5:1	Less than 1.5:1
Impedance	50 ohms	50 ohms	50 ohms
Power rating	Maximum Legal	Maximum Legal	Maximum Legal
2:1 VSWR Bandwidth	400 KHz	500 KHz	1.5 MHz
Longest Element	36 1/2"	24 1/2"	18 1/2"
Boom Length	34"	26"	24"
Boom Diameter	2"	2"	2"
Turning Radius	25"	17 1/2"	15"
Surface Area	8.0 sq. ft.	5.2 sq. ft.	3.9 sq. ft.
Wind Load at 80 mph	230 lbs	133 lbs	100 lbs
Maximum Wind Survival	80 mph	100 mph	100 mph
Max DIA Accepted	1 1/4" to 2 1/2"	1 1/4" to 2 1/2"	1 1/4" to 2 1/2"

With sunspot cycle 21 now in the upswing, you should be prepared for the DX available on the 3 top HF bands, if not, our new "Long-Johns" are for you. The new 5 element "Long-John" monobanders are ideal for the serious DX'er. Each utilizes Hy-Gain's unique Beta-match for optimum power transfer. Also each antenna uses tapered tubing for minimum wind load and maximum strength. For maximum durability each "Long-John" uses Hy-Gain's rugged boom-to-mast clamp.

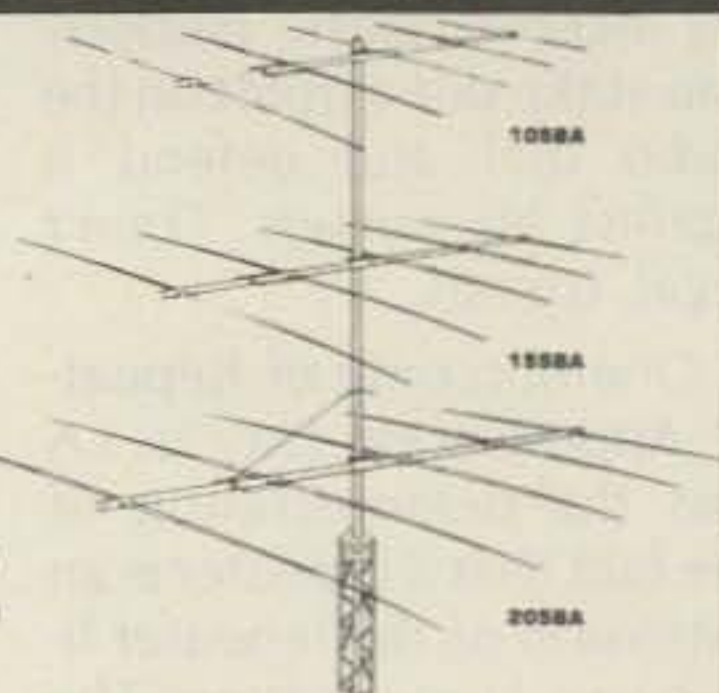

5 Element Maximum Performance Monoband Beams for 10, 15, and 20 meters

Larsen Kølrod Antennas

- Handle full 200 watts • low-low V.S.W.R.
- Deliver 3 dB gain and more!
- Pick the one that best fits your needs:

MAGNETIC MOUNT stays put even at 100 mph!

MM-JM-150 for 144 MHz use } Only \$38.50  
MM-JM-220 for 220 MHz use } complete  
MM-JM-440 for 440 MHz use }

TRUNK LID MOUNT

No holes and low silhouette too!  
TLM-JM-150 for 144 MHz use } Only \$38.50  
TLM-JM-220 for 220 MHz use } complete  
TLM-JM-440 for 440 MHz use }

ROOF or FENDER MOUNT

Goes on quick and easy in 3/8" or 3/4" with fewest parts.  
JM-150-K for 144 MHz use } Only \$31.50  
JM-220-K for 220 MHz use } complete  
JM-440-K for 440 MHz use }

Communications Essentials From DAIWA CORPORATION

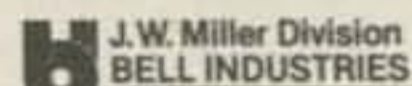

SWR & Power Meter / Model CN-720 \$166.95

Simultaneous direct reading SWR, Forward Power and Reflected Power.  
Frequency Range: 1.8-150 MHz  
SWR Detection Sensitivity: 5 W Min  
Power: 3 Ranges (FWD 20/200/1000 W) (REF 4/40/200 W)  
Input/Output Impedance: 50 Ohm  
Dimensions: 180 x 120 x 130 mm, 6 x 4 x 4.5 in.  
Tolerance: ± 10% full scale



RF Speech Processor/Model RF-440 \$135.95

Increases talk power with splatter free operation. RF clipping assures low distortion. Simply install between microphone and transmitter.  
Talk Power: Better than 6 dB  
Clipping Threshold: Less than 2 mV at 1 KHz  
Bandwidth: 2200 Hz at 6 dB down  
Frequency Response: 300-3000 Hz at 12 dB down  
Distortion: Less than 3% at 1 KHz, 20 dB clipping  
Output Level: More than 50 mV at 1 KHz  
Power Requirement: 115 VAC, 60 Hz, 1.4 W; or 13.5 VDC, 55 mA  
Dimensions: 150 x 70 x 150 mm, 5 x 2.5 x 5 in.

Interference Filters From J.W. Miller

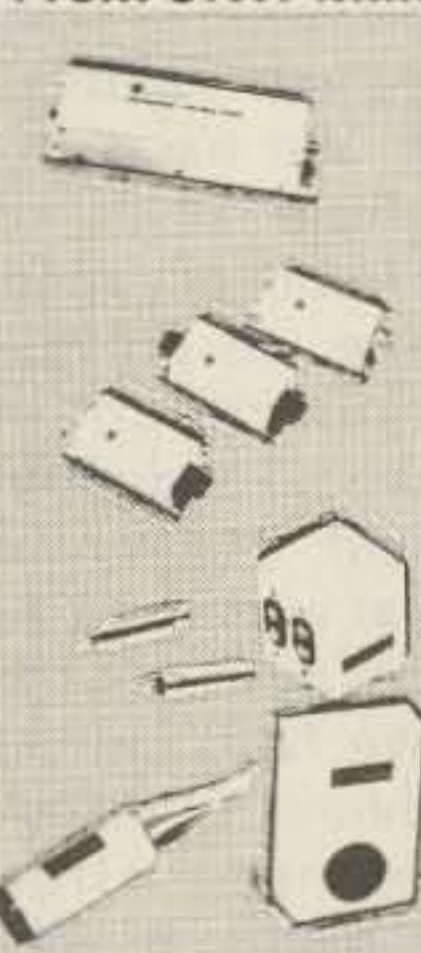

LOW PASS FILTERS  
Input/output impedance 50 ohms. Insertion loss .3 dB max.; VSWR 3:1; Attenuation greater than 75 dB above 41 MHz.  
C-511-T — \$19.50  
25 W AM 50 W PEP SSB  
C-514-T — \$26.80  
1000 W AM 2000 W PEP SSB.  
HIGH PASS FILTERS  
Filter attenuates signals below 40 MHz by a power factor greater than 1,000,000:1.  
C-513-T1 — \$10.18; 75/300 ohm  
C-513-T2 — \$10.18; 75/ 75 ohm  
C-513-T3 — \$10.18  
300/300 ohm  
AUDIO INTERFERENCE FILTERS  
C-505-R — \$5.07  
Installs in the input lines of audio equipment. Consists of 1 pair.  
C-506-R — \$6.07  
Installs in speaker lines. Unit will take care of stereo speaker systems.  
AC POWER LINE FILTERS  
An easy way to prevent radio signals from entering power line.  
C-508-L — \$8.33  
3-section LC filter, 3 A max.  
C-509-L — \$18.35  
5-section LC filter (for more severe interference). 5 A max.

Coaxial Switches

2 Position/Model CS-201  
4 Position/Model CS-401



Professional engineer party Construction: High intensity Power Rating: 75 W PEP 1 kW CW Impedance: 50 Ohm Insertion Loss: Less than 2 dB VSWR: 1:1.2 Maximum Frequency: 300 MHz Isolation: Better than 30 dB at 300 MHz Series: thru 45 dB at 450 MHz Attenuation: terminal Connector: SO 239

**QUESTION:** Who has Advanced Electronics, Alpha, AMECO, Amphenol, Antenna Specialists, Astatic,

☆☆☆☆☆☆ **PALOMAR ENGINEERS** ☆☆☆☆☆

**R-X NOISE BRIDGE \$49.95**



- Learn the truth about your antenna.
- Find its resonant frequency.
- Find R and X off-resonance.
- Broadband 1-100 MHz.
- Simple to use. — Self contained.

**VLF CONVERTER \$55.00**



- New device opens up the world of VLF radio.
- Converts VLF to 80 meters. For use with any shortwave receiver covering 3.5-4 MHz.
- Advanced design for simple operation, high performance.
- Gives reception of the 1750 meter band.
- Also covers navigation radiobeacons, WWVB, ship-to-shore, and LF broadcast band.

**LOOP ANTENNA**  
Loop Amplifier \$67.50  
Plug-in loops \$47.50 ea.

- Plug-in loops available for:  
1600-5000 KHz (160/80 meter amateur bands)  
550-1600 KHz (Broadcast Band)  
150-550 KHz (VLF, 1750 meter band)  
40-150 KHz (WWVB, Loran)  
10-40 KHz (Omega)
- Nulls out interference



**ALL BANDS PREAMPLIFIER \$89.50**



- Tunes 1.8 to 54 MHz. Covers ALL amateur bands 160 to 6 meters. ALL shortwave broadcast bands.
- For receivers AND transceivers.
- Up to 20 db gain.
- Peps up that tired receiver.
- Reduces image and spurious response.



**Model MB II \$295**  
(with Balun) \$325

**MB II provides:**

- Constant SWR monitoring.
- Precision tuning of final amp.
- Harmonic suppression.
- Receiver input impedance-matching.
- Maximum power transfer to antenna.
- Continuous frequency coverage 1.6 to 30 MHz.
- Precision tuning of any wire 1/4 wavelength or longer, with SWR of 1:1.

**MB II features:**

- Finest quality, made-in-USA components.
- Large, precision, easy-to-read dials with 360° readout.
- Optional 3000 watt Balun for twin lead antennas.

**BIRD**  
Electronic Corporation

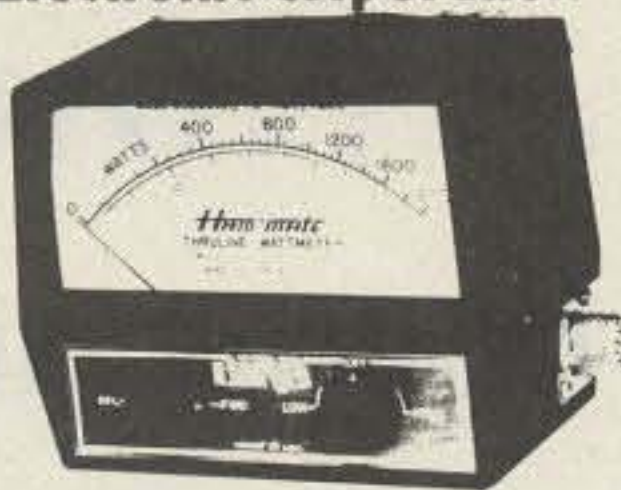

**\$94 VHF model 4362 (140-180 MHz)**  
**\$94 HF model 4360 (18-30 MHz)**

The 4360, 4362 HAM-MATE Directional Wattmeters are insertion type instruments for measuring forward or reflected power in 50-ohm coaxial transmission lines. They are direct descendants of the model 43 THRULINE® Wattmeter—the professional standard of the industry—and will accurately measure RF power flow under any load condition. Each wattmeter is made up of a precisely machined section of 50-ohm line, a rotatable sensing element and meter calibrated in watts, all mounted in a high-impact plastic housing. It is this type of solid construction and the directional THRULINE coupling circuit, without toroids, that account for the superiority of the HAM-MATE Wattmeters.

the indispensable  
**BIRD 43**  
THRULINE  
WATTMETER



Power Range	Frequency Bands (MHz)				
	2-30	25-60	100-250	200-500	400-1000
5 watts	—	5A	5C	5D	5E
10 watts	—	10A	10C	10D	10E
25 watts	—	25A	25C	25D	25E
50 watts	50H	50A	50C	50D	50E
100 watts	100H	100A	100C	100D	100E
250 watts	250H	250A	250C	250D	250E
500 watts	500H	500A	500C	500D	500E
1000 watts	1000H	1000A	1000C	1000D	1000E
2500 watts	2500H	—	—	—	—
5000 watts	5000H	—	—	—	—

**MODEL 43** \$125.00  
Elements (Table 1) 2-30 MHz 45.00  
Elements (Table 1) 25-1000 MHz 38.00  
Carrying case for Model 43 & 6 elements 27.50  
Carrying case for 12 elements 17.00

**READ RF WATTS DIRECTLY!** (Specify Type N or SO239 connectors) 0.45 – 2300 MHz, 1-10,000 Watts ±5%, low insertion VSWR – 1.05. Unequaled economy and flexibility. Buy only the element(s) covering your present frequency and power needs, add extra ranges later if your requirements expand.

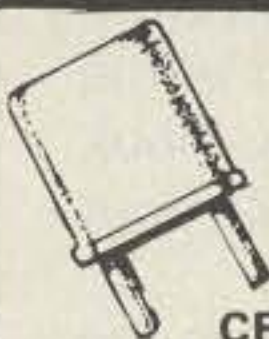

**TWO METER**  
CRYSTALS IN STOCK

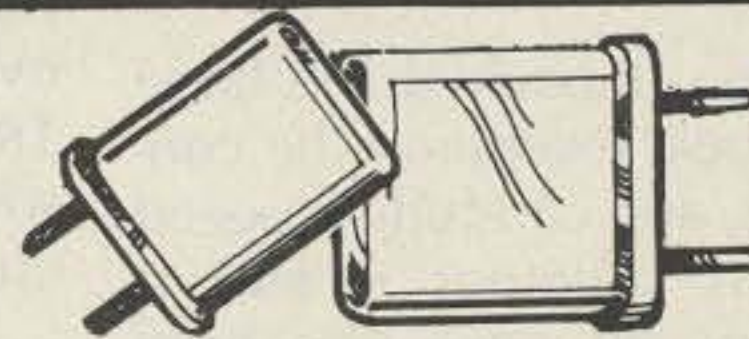

Standard • Icom • Heathkit • Ken • Clegg • Regency • Wilson • VHF Eng • Drake • And Others! **Lifetime Guarantee! Now only \$9/pair.**



**5-BAND TRAP DIPOLE**  
(80 thru 10 Meters)

**Barker & Williamson**

**Power rated 2k WPEP, approx. 110 ft. span**

Complete with: wire, traps, end insulators, 50 ft. RG-8/U, PL-259 connector, heavy-duty cast aluminum and steatite center connector. 4-Band (40 thru 10M) 55 ft.



**Pre-assembled:**  
Model 370-11 — \$64.95  
**Kit (illustrated):**  
Model 370-12 — \$54.95

**Hy-Gain REEL TAPE PORTABLE DIPOLE**  
for 10 thru 80 Meters Model 18TD

The most portable high performance dipole ever...

The Model 18TD is unquestionably the most foolproof high performance portable doublet antenna system ever developed. It has proven invaluable in providing reliable communications in vital military and commercial applications throughout the world. Two stainless steel tapes, calibrated in meters, extend from either side of the main housing up to a total distance of 132 feet for 3.5 mc operation. 25 ft. lengths of polypropylene rope attached to each tape permits installation to poles, trees, buildings... whatever is available for forming a doublet antenna system. Integrated in the high impact housing is a frequency to length conversion chart calibrated to meter measurements on the tapes... makes installation foolproof. Feeds with 52 ohm coax. Delivers outstanding performance as a portable or permanent installation. Measures 10x5 1/2 x 2 inches retracted. Wt., 4.1 lbs. Order No. 228 Price: \$94.95

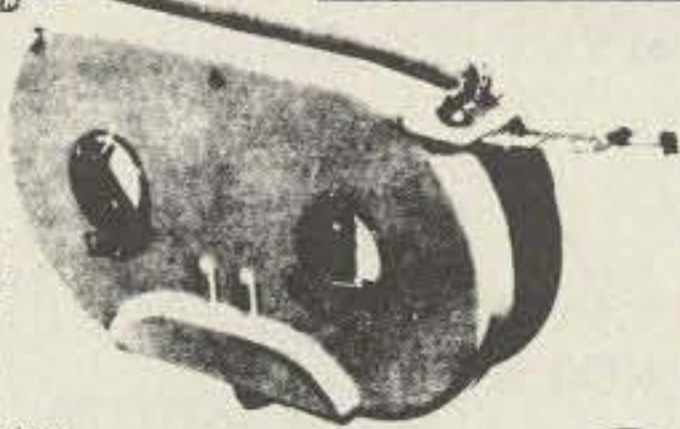

**hy-gain**

**BANDPASS-REJECT DUPLEXER**  
DPLA-144 FOR 144-174 MHz  
Also available for 54, 220, 450 MHz.

THESE BAND PASS-BAND REJECT CIRCUIT DUPLEXERS include the use of an exclusive circuit developed for VHF ENG which provides superior suppression of spurious sideband noise between and adjacent to the duplex frequencies. When used with a high Q filter, the Band Pass Band Reject Circuit provides frequency response curves with bandpass cavity characteristics at the frequency to be passed and band-reject cavity characteristics at the frequency to be attenuated. Performance characteristics improve as the frequency separation is increased. Frequency stability of the Band Pass Band Reject Circuit duplexers is excellent — an important factor at close frequency spacing. Each model will handle transmitter powers up to 150 watts and all models are supplied with complete cable harness and mounting frame.



\$409.95

VISA  master charge  
 Name \_\_\_\_\_ Call \_\_\_\_\_  
 Address \_\_\_\_\_  
 City \_\_\_\_\_ State \_\_\_\_\_ Zip \_\_\_\_\_  
 Order: \_\_\_\_\_  
 Check Enclosed  Visa  Master Charge  Send for Free Catalog  
**PRICES SUBJECT TO CHANGE WITHOUT NOTICE**  
 Card no. \_\_\_\_\_ Card exp. date \_\_\_\_\_  
 Signature \_\_\_\_\_

**TUFTS**  
Radio Electronics  
OPEN DAILY 9-9  
SATURDAY 9-6

206 Mystic Avenue, Medford, Mass. 02155 1-617-395-8280 T3

Atlas, Bencher, Bird, Bomar, B&W, CDE, CES, CSC, Cushcraft, Daiwa, Datong, DGM, Drake, ETO, F9FT, Finco, Ham Key, Henry Hustler, Hygain,

JMR, KLM, Kenwood, Larsen, MFJ, Microwave Filter, Morgan, Mosley, Newtronics, NPC, Nye Viking,

# My TRS-80 Is Here ... Now What?

— first steps in programming your computer

Allan S. Joffe W3KBM  
1005 Twining Road  
Dresher PA 19025

You unpacked the large box, examined the contents, and carefully plugged it all together... and it works. By now, you have read the excellent book that comes with the TRS-80 or, if you are lucky enough to have Level II BASIC, then you had two books to read... and digest.

The nicest thing for any beginning programmer is no different from the nicest thing for the beginning ham: a starting point to get from the superregenerative receiver to the superheterodyne. Both problems relate in this fashion. A complex radio is really nothing more than a collection of properly associated simple circuits which make up the whole. A whipper-doo-dingbust-golly-gee computer program is more of

the same. The trick is to grab a firm hold of the elements from a simple starting point.

For purposes of illustration, I have chosen to work over a nice program in the TRS-80 level I BASIC book which sets forth a 24-hour clock program.

Taken verbatim from the book:

```
10 CLS
20 PRINT AT 407, " H M S "
30 FOR H = 0 TO 23
40 FOR M = 0 TO 59
50 FOR S = 0 TO 59
60 PRINT AT 470, H; ":" ;M; ":" ;S
70 FOR N= 1 TO 500: NEXT N
80 NEXT S
90 NEXT M
100 NEXT H
```

When entering this program and running it, you see the hours, minutes, and seconds start to count from 0:0:0.

With this much as our starting point, we can operate upon the basic program a bit at a time, so we do not byte off so much that we eschew it.

Like any sensible person, if you bought a timepiece at the local emporium, got it home and found you had no way to set the time, you could rightly work up a bit of indignation. Well, this clock so far is in that fix, but you can program it into practicality with the following few steps. Remember, we are listing new or revised lines to the fundamental program as we go.

```
52 X=X +1
54 IF X = 1 THEN 110
72 CLS
105 GOTO 30
110 INPUT H,M,S
120 GOTO 60
```

Now if you enter the program and run it, a header will appear as before, but this time there will be a "?" showing along with the header. The computer is saying, tell me what time you want me to start counting from. You enter the requested information by typing 3,0,0, which could be

three am or three pm, depending on your life-style. Now when you hit ENTER, the clock starts keeping time from the entered data. You have added a knob to "set the hands."

What the whole process really amounts to is educational self-help. Working a bit at a time to alter programs means you will master the skill of programming. After all, you did not buy the machine to use someone's canned programs for the sheer thrill of getting typing practice.

So much for the philosophy. How about another small change? This time, let's humanize the program by changing it from a 24-hour clock to the usual 12-hour variety. This takes one more change to the program. Line 30 now becomes:

```
30 FOR H = 1 TO 12
```

You probably are not too happy with that vertical string of zeroes in the original program or any stray

# NOW... YOU SAVE THREE WAYS AT HENRY RADIO

**1.** CALL FOR OUR LOW, LOW CASH OR CREDIT CARD PRICES ON ALL MAJOR EQUIPMENT.

**2.** TAKE ADVANTAGE OF OUR FANTASTIC MONTHLY SPECIALS ON SELECTED FINE EQUIPMENT.

**TEMPO FMH-2** 2 METER HANDHELD  
*Special*  
**KENWOOD TR-7625** 2 METER TRANSCEIVER  
*Special*  
**DRAKE TR-7** H.F. TRANSCEIVER  
**KENWOOD TS-520SE** H.F. TRANSCEIVER  
**SWAN ASTRO 150** H.F. TRANSCEIVER  
**YAESU FT-101Z** H.F. TRANSCEIVER  
*Special*  
**KENWOOD TS-700SP** 2 METER TRANSCEIVER  
**ICOM IC-701** H.F. TRANSCEIVER  
**SWAN 100-MX** H.F. TRANSCEIVER  
**KENWOOD TR-7600** 2 METER TRANSCEIVER  
**RM-76** REMOTE MODULE  
*Special*  
**YAESU FT-101ZD** H.F. TRANSCEIVER  
**DRAKE UV-3** VHF/UHF TRANSCEIVER 6 METER TRANSCEIVER (AVAILABLE IN DECEMBER)  
**ICOM IC-551** 6 METER TRANSCEIVER  
*Special*  
**YAESU FT-901DM** H.F. TRANSCEIVER  
*Special*

**3.** ENJOY THE WORLD FAMOUS HENRY RADIO SERVICE. NO ONE ELSE CAN OFFER YOU THE BACKGROUND OF EXPERIENCE AND THE VALUE OF RESPONSIBLE MARKETING LIKE HENRY RADIO.

Henry Radio also offers a broad line of commercial and FCC type accepted amplifiers covering the range of 3 MHz to 500 MHz. Henry amplifiers are in use all around the world. Commercial and export inquiries are invited. Tempo solid state amplifiers are available at Tempo dealers throughout the U.S.



NEW TOLL FREE ORDER NUMBER: (800) 421-6631  
 For all states except California.  
 Calif. residents please call collect on our regular numbers.

11240 W. Olympic Blvd., Los Angeles, Calif. 90064 213/477-6701  
 931 N. Euclid, Anaheim, Calif. 92801 714/772-9200  
 Butler, Missouri 64730 816/679-3127

**Henry Radio**

zero on the left side of the screen. We can de-zero the display by changing the contents of two lines in the program, namely lines 20 and 60. They now become:

20 PRINT "H M S"

60 PRINT H ; " " ; M ; " " ; S

Now that we have de-zeroed the display, just a word about clock accuracy. The book suggests the number 500 in the timing loop in line 70. With the particular machine I had before me, 300 seemed to give a country-fair minute.

So far, we have a rather conventional clock which, without too much effort, can be turned into a conventional down-counting timer. With these changes, you have a timer that starts from a predetermined starting time of your choice, starts counting at the push of a button, and stops counting when it reaches zero.

These are the program

changes to make the timer:  
 30 FOR H = 11 TO 0 STEP -1  
 40 FOR M = 59 TO 0 STEP -1  
 50 FOR S = 59 TO 0 STEP -1  
 105 END

The first three lines shown here reverse the order of counting from up, as needed for the regular clock, to down as desired for the advertised down-counter. The final change (line 105) makes the counter stop when the count has wound down to zero.

Small programs like this may not have the oomph of Lunar Lander or Star Trek but they lend themselves to piece-by-piece manipulation on a somewhat intuitive basis. (Reading the books that came with your computer also helps.) This is one way to achieve familiarity with the programming language that you must master if your computer is going to be more than a large, expensive paperweight. ■

Call or Write for Delivery or Quote

## ICOM IC701 with AC/MIC



LEAVE A MESSAGE & WE'LL CALL YOU BACK!

All prices fob Houston, except where indicated. Prices subject to change without notice, all items guaranteed. Some items subject prior sale. Send letterhead for Dealer price list . . . Texas residents add 6% tax . . . please add postage estimate, \$1.00 minimum. W5GJ, W5MBB, K5AAD, N5JJ, AG5K, W5VVM, WD5EDE, K5ZD, WA5TGU, WB5AYF, K5RC, K5BGB, WB5USV.

MASTERCHARGE • VISA

### MADISON ELECTRONICS SUPPLY, INC.

1508 MCKINNEY • HOUSTON, TEXAS 77002

713/658-0268 ✓ M35

### THOMAS LOVES YAESU SPECIALS!

**YAESU FT-207R**  
 144 148 MHz FM Synthesized Hand-Held. Four memories plus offset, Auto Scan, Keyboard entry, 3 watts output, automatic battery saver, LED Display, BNC Antenna Connector, condenser mike, and MUCH MORE!

List \$399 • Call for Quote!



### THOMAS LOVES DENTRON SPECIALS! Dentron

**MT-2000 3KW**  
 Antenna Tuner 1.8 — 30 MHz  
**SUPER DEAL**  
 Closeout Price \$155 . . . Reg. \$199

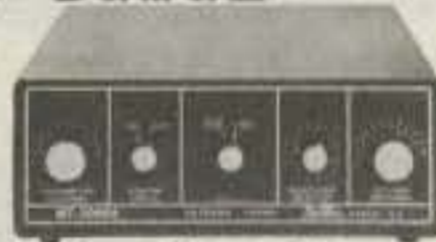

### SPECIALS!

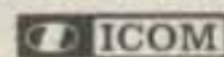

**ICOM IC-701**  
 All Mode HF Transceiver

All solid state, 100W continuous duty on all bands, all modes, 160 thru 10 meters, dual built-in digital VFO's for split freq. operation, VOX, semi-break-in CW, RT, AGC, noise blanker and built-speech processor. IC-701PS needed for AC operation. Power supply requirements: DC 13.6V negative ground. **\$1,332 LIST—Call for quote!**



**YAESU FT-101ZD High performance HF Transceiver**

Covers 160 thru 10 meters plus WWV, modes: LSB, USB, and CW, built-in power supply, input power: 180 WDC, digital and analog frequency readout, 6148 final tubes, RF speech processor, variable IF bandwidth (300 Hz to 2.4 KHz), noise blanker, VOX, attenuator 10 dB or 20 dB, 100-234V operation, TX/RX freq. offset.

Call for Quote



**Dentron GLA-1000 LINEAR AMPLIFIER**

Freq. 80 to 15 meters, covers most Mars frequencies, RF drive max. 125, power consumption: 117 VAC 50/60 Hz 12.5 Amps, factory fused at 15 Amps, 23A VAC 50/60 Hz 7 Amps, DC input: 1 KW CW and 1200W PEP SSB, Final tubes: 4 D-50A tubes (BL0E) **\$379.50 Call for Quote**



**DRAKE TR7/DR7 Solid State synthesized HF transceiver**

Covers 160 thru 10 meters, reception from 1.5-30 continuous, 6-30 MHz with optional ALX-7, modes: USB, LSB, CW, RTTY, AM True parallel tuning, RT built-in RF wattmeter/DWR bridge, SSB 250 watts PEP, CW 250 watts, AM 80 watts. Power supply required for AC operation. PS-7 120/240V power supply available. **\$1,385.00 List. Call for quote.**



**YAESU CPU 2500RK 2 Meter FM Transceiver**

With 800 PLL channels, automatic scan over entire 2m band, 4 memories, toneburst, 25W Hi-Z/F Lo, 13.8 VDC at 5A continuous, Freq. coverage: 144-148 MHz. Comes with a key-board mic that allows remote input of memory or dial freqs., up/down scanning, aux. repeater selection to 4 MHz, 2 tone input for autopatch. **\$85.00 list. Call for quote.**



**DENTRON Clipperton L**

160 thru 15 meters: 200 watts PEP on SSB, 1000 watts DC on CW, RTTY, or SSTV, covers most MARS frequencies just outside Ham bands, and easily changed 117V or 234V AC 50-60 Hz. **\$699.00 Call for Quote.**



**TEN-TEC Omni D HF Transceiver**

Totally solid state, 200W all bands. Covers 160 thru 10 meters, digital readout, built-in VOX and PTT, adjustable squelch, 4 position CW/SSB filter, 8 pole crystal SSB filter, 2 range offset tuning, crystal calibrator, zero beat switch, SWR bridge and more. 12 VDC for mobile use, external power supply needed for fixed use. **\$1069.00 list. Call for quote.**

### Got Big Problems? Mail Order Repair Service

- Fast Efficient Service
- We Repair All Brands
- Most Repairs Done and Shipped Within 14 Days
- Amateur Extra/First Class Licenses
- Send Equipment UPS Prepaid Shipping
- Include Manuals and Power Supply
- All Work Guaranteed
- Our Fine Reputation Speaks For Itself
- ALSO . . . Warranty Work On All Major Brands

### We Sell and Service the Following New and Used Equipment

Alda	ETO Alpha	Rohn
Alliance	Ham Key	Saxton Wire
Ameco	Hustler	Shure
ARRL	Hy-Gain	SST Electronics
Atlas	ICOM	Swan
Bencher	JW Miller	Telex
Bird	KDK	Ten Tec
B & W	KLM	TET Antennas
Calbook	Larsen	Trac
CDE	MFJ	Unadilla
CES	Microlog	VHF Engineering
Covercraft	Mirage	Vibroplex
Cushcraft	Mosley	Wilson
Dentron	Murch	Wilson
Drake	PIPO	Commercial
DSI	Robot	Yaesu

GET A SUPER DEAL AND GREAT SERVICE  
**CALL (203) 667-0811**

### \* CHECK THESE PRICES \* ALLIANCE

HD-73 Heavy duty rotor . . . . . \$119.95

#### ATLAS

TX-110H Transmitter . . . . . \$199

TX-110L Transmitter . . . . . \$129

RX-110 Receiver . . . . . \$199

RX-110S Receiver . . . . . \$209

#### TEN TEC

KR-20A Keyer/Paddle . . . . . \$55

#### CDE

CDE-44 Rotor . . . . . \$95

#### DENTRON

Big Dummy-1kw . . . . . \$27.50

#### KDK

AWE-800UP Scan Converter . . . . . \$88

CES 800KK Scan Converter . . . . . \$88

CES 800YS Scan Converter . . . . . \$88

#### KLM

15-160BL 2M Amplifier (15 watts in, 160 watts out) linear . . . . . \$229

#### TELEX

HTC-2 Twin Lightweight Headphones \$23

SWL-610 Earphones, 2000 ohms . . \$11.50

#### SWAN

FS-1 Field Strength Meter . . . . . \$15.50

FS-2 Field Strength Meter . . . . . \$16.50

SWR-3 SWR Meter . . . . . \$15.50

#### YAESU

FV-901 VFO . . . . . \$339

SP-101 Speaker . . . . . \$22

FT-101DC Converter . . . . . \$42

YC-601B Digital Display . . . . . \$185

YC-500S Frequency Counter . . . . . \$265

FT-101 Speech Processor . . . . . \$62

YC-221 Digital Display . . . . . \$99

YC-150 Dummyload/Wattmeter . . . . . \$75

YC-500J Freq. Counter . . . . . \$195

YO-101 Monitor Scope . . . . . \$259

# THOMAS COMMUNICATIONS

✓ T34

95 KITTS LANE • NEWINGTON, Connecticut 06111  
 OPEN: 10:00-5:30 MON.-FRI. • THURS. til 8:00 p.m. • SAT. 10:00-4:00  
 Easy Directions: Rt. 15 South • 2 Blocks Past MacDonalds (Berlin Tpke.)



# 15 ISSUES FOR \$15

## KILOBAUD MICROCOMPUTING SUPER OFFER!

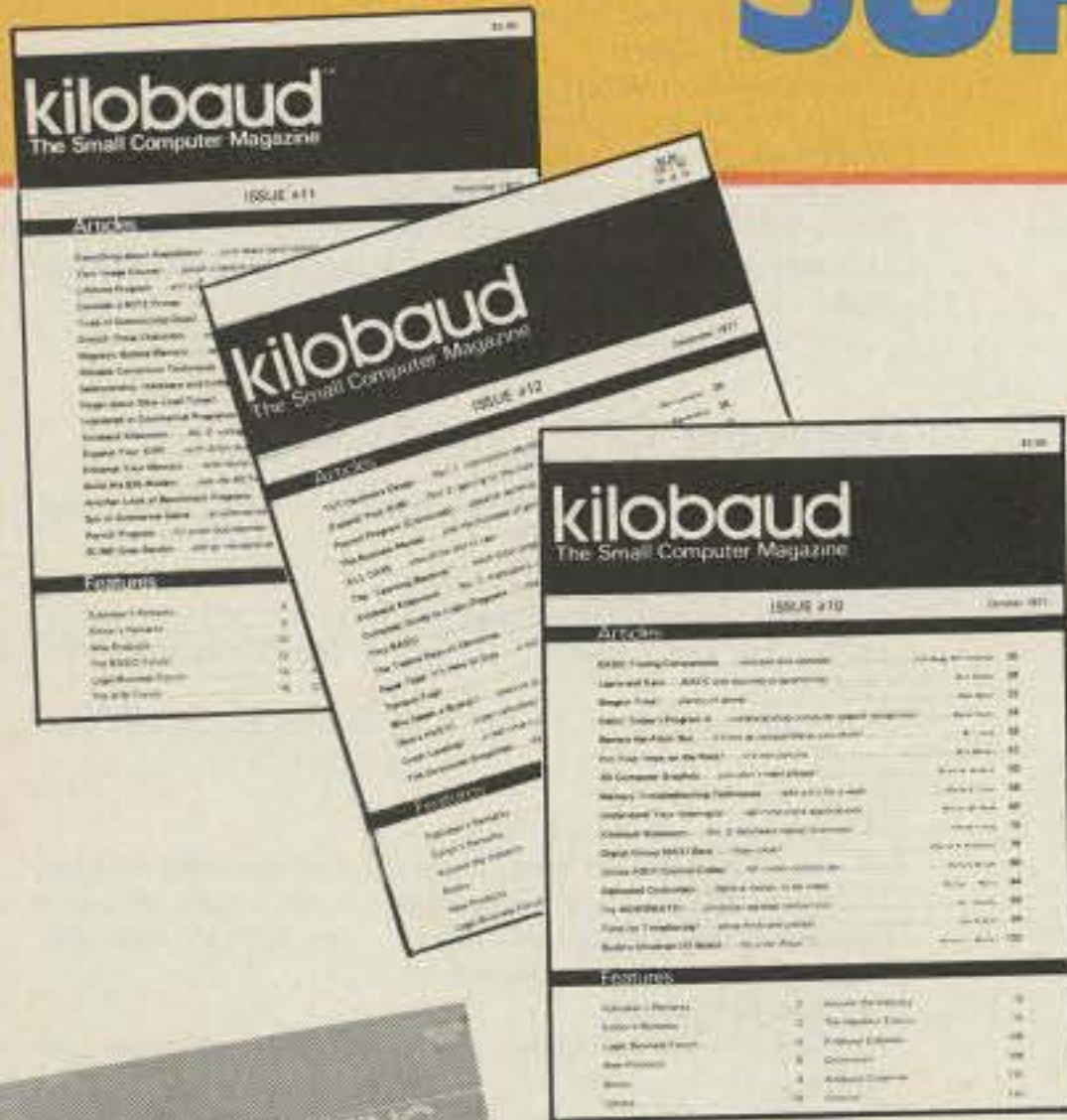

Start your own encyclopedia of *Microcomputing* by taking advantage of this super offer. Hurry though; this offer is limited.

If you've been thinking about subscribing to *Kilobaud Microcomputing*, this is the time to do it. Subscribe today at the already low subscription price of \$15 (you save \$15 off the newsstand cost for one year) and get your choice of three issues from these pages, **FREE!** Each issue is full of information on software, new products, books, and packed with articles on every possible subject in microcomputing. If you already subscribe to *KB Microcomputing*, you know what a fine magazine it is. You'll want to take advantage of this super offer by renewing for 12 months and take your choice of these great issues, **FREE!**

Look over the wealth of information included in these issues. There's little or no information that goes stale. And by subscribing now, you can choose three issues and start your encyclopedia of *Microcomputing* right away. Simply indicate on the attached postage-paid card the issues you wish to receive. Please include two alternate choices as these issues are limited and they're going fast. Allow 4-6 weeks for delivery. (Your subscription will start with the next published issue.)

*Look over these great issues on the following pages...*





# kilobaud microcomputing

## articles you may have missed during 1977

### January 1977

- Is the Z80 the Wave of the Present?
- Tiny BASIC
- How a Memory Works
- Software Exchange
- Practical Microcomputer Programming ... Part 1: Logical Instructions
- Well, Your Micro's Built ... where do you grow from here
- Computer Control of the World! ... turning ac powered devices on and off with your computer
- Wire Wrapping
- The Hobbyist's Operating System ... Part 1: Introduction and Master Plan
- Solving Some of the Software Interchange Problems
- Welcome to Assembly Language Programming Programming? It's Simple!
- Structured Programming
- Computers in Golf ... help for the handicapped
- Computer Widow
- What's that Digital Group Really Doing?
- How to Use the New PR-40 Printer
- Fire! ... let your micro call for help
- A Teletype Alternative
- Nobody Knows the Troubles I've Seen
- Structured BASIC ... A negative view by Dr. Kemeny, the author of BASIC
- Six Games on a Chip

### February 1977

- ZAP!
- Chasing Those Naughty Bits
- Why So Many Computer Languages?
- The Remarkable Apple Computer
- Beware the Wumpus
- Chase!
- Will the Z-80 Crush All Competitors?
- Practical Microcomputer Programming ... Part 2: Operating Systems
- The Trouble with Mass Storage Systems
- A Useful Loan Payment Program
- Submarine! ... a game for the SR-52
- The Hobbyist's Operating System ... Part 2: Interfacing with the Monitor
- Found: A Use for Your Computer! ... a clock program for the KIM
- Sophisticating a Surplus Keyboard
- At the Races
- RCA Tries Again ... with the 1802
- 8080 vs. 370
- Cut 6800 Programming Time with this Extraordinary Program
- $7 \times 9 = 56$
- Learning Computerese
- How to WIN the Surplus Game
- Making Money Is Nice
- The 8080 You May Have Missed
- The "Kill a Byte" Standard
- A 6800 Single Stepper
- Computerized Statments

### March 1977

- Practical Microcomputer Programming ... Part 3: Software Tools
- The Motorola Way! ... review of the MEK6800D1
- Lets Hear It for the 680b!
- The Paper Tape Caper
- Computers for Free!
- A New Approach to the 6800 ... the Astral 2000
- Journey into the CPU
- Only Five Senses
- Floppy Disks
- The Jupiter II
- How to Win \$25,000 of Your Own Money ... Keno game program
- Using the "\$50" Terminal
- External Mass Storage ... Part 2: Digital and Audio Cassette Systems
- Make Your 680b Smarter ... a cheap memory expander
- Stop Bugs Now!
- Clocked Logic ... Part 1: The D Type and JK Flip-Flops
- The Gory Details of Cassette Storage
- The Fun of Learning BASIC
- Super-Tube ... jazzing up the Digital Group TVT

### April 1977

- Interrupts Exposed ... using microprocessor interrupt capability effectively
- Clocked Logic ... Part 2: Some Basic Applications
- Build an Eight Channel Multiplexer for Your Scope
- Sorting Routines
- Number Rounding Program
- Meet the Tarbell/KC Interface
- Super-Tester ... a digital design aid
- The Hobbyist's Operating System ... Part 3: Command Language Processing
- The Slow-Stepping Debugger
- BASIC - The Easy Way
- Now You Can Use Software Timing Loops

- KIM-1 Memory Expansion
- Heavy Duty Power Supply
- Digital Audio
- HI-LO
- Interfacing the Analog World
- Everything about Semiconductor Memory
- Three-State Logic ... explanation of a key microprocessor element
- Automatic Memory Dumper ... utility dump program for 6800 users
- Hangmath! ... a new puzzle/game
- Now - BASIC for the 8008 - Even!
- Microprogramming ... an insight into microprocessor design
- Computerized Babysitter

### May 1977

- Clocked Logic ... Part 3: Data Converters and Special Functions
- Cure Those End-of-Month Blues ... with a sales analysis program
- Make Your Investment Count ... the inside view of a custom MP-68
- Speed Up Your 6800
- Who's Afraid of RS-232 ... data communications explained!
- Is it High? - or Low? ... understanding logic design conventions
- Know Thyself! ... confessions of a kit-builder
- Prototyping Systems Exposed! ... a revealing look at the Intercept Jr.
- Interrupts Exposed ... Part 2: Implementing an Interrupt-driven System
- Digital Audio ... Part 2: Generating that Weird Music
- Now It's Imsai BASIC!
- Bridging the Gap ... tips on turning an application into a program
- Adding "Plop" to Your System ... a noisemaker for computer games
- Lunar Lander
- Silence Noisy Teletype Motors ... Part 1: Getting the Ball Rolling
- A Home Computer Pioneer ... profile of Don Tarbell

### June 1977

- Build Your Own Interface
- Computer Club Promotional Techniques
- Artillery Practice
- Put a Micro in Your School
- Torpedoes Away!
- Build a Pulse Generator
- A TVT For Your KIM
- THE BYTEDESTROYER ... review of an EPROM eraser
- BASIC Timing Comparisons
- Solving Keyboard Interface Problems
- A Clean Cassette
- Try a Design Console ... for practical hardware prototyping
- Try Solar Energy
- Simplified Billing System ... in BASIC for the small business
- Kilobaud Classroom ... No. 2: Gates and Flip-flops Explained
- Computerized Typesetting ... an introduction to word processing
- Introducing! The World's Cheapest Computer ... a \$60 SC/MP
- My Friend is a Computer Junkie

### July 1977

- Inside the Sphere Microcontroller
- The Great TV to CRT Monitor Conversion
- Computer Turns Director ... an interview with filmmaker John Whitney
- The Random Number Game
- Cassette Interface First Aid ... use your processor to set timing
- Understand Your Computer's Language
- Kilobaud Classroom ... No. 3: JK Flip-Flops and Clock Logic
- Digital Audio ... Part 3: Signal Expansion and Compression
- It Was Great! ... reviewing The First West Coast Computer Faire
- Pass the Buck ... computer decision-maker program
- Inside the Amazing ASR 33 ... checking out the most popular terminal
- Try Computer Composition

### August 1977

- Cassette I/O Format
- Expand Your SWTP 6800 ... with a new 8K board
- Trigger Your Oscilloscope
- Sobriety Tester Program
- Random Integer Program
- Test ICs With Your Micro
- Heavy Duty Altair Power Supply
- Is the KIM-1 For Every-1?

- Electronic Design by Computer
- Understand Your Computer's Language ... Part 2: Instruction Sets
- Enter the Audible Computer!
- Time Bomb Game
- Try a Do-All Program!
- Sooo, You Want to be an Author!
- SWTP 4K BASIC Notes ... implementing it on the 680b
- Hexdec ... hexadecimal to decimal conversion
- Start a One-Man Computer Club
- Troubleshoot Your Software ... a trace program for the 6502
- Cure that Hot Power Supply

### September 1977

- Build Your Own ASCII Keyboard ... with serial and parallel output
- The Ultimate Personal Computer
- Talk Your Computer's Language!
- A PET For Every Home ... a look at the Commodore PET 2001
- Kilobaud Classroom ... No. 4: PC boards and power supplies
- Seals Electronics
- Try an 8080 Simulator
- Build a \$20 EPROM Programmer ... for the 5402 4K chip
- Faster MIKBUG Load Technique ... uses binary format
- Decoding Device Control Codes ... uses a UART, naturally
- Tarbell Asynchronous Format
- Baseball in BASIC
- Using an Invisible PROM ... how to relocate monitor programs
- Klingon Capture Game
- Starting a Business?

### October 1977

- BASIC Timing Comparisons
- Learn and Earn ... BASIC and business programming
- Bargain Time!
- Hello! Today's Program Is ... understanding computer speech recognition
- Beware the Altair Bus
- Put Your Imsai on the Rack!
- 3D Computer Graphics
- Memory Troubleshooting Techniques
- Understand Your Interrupts! ... real time clock applications
- Kilobaud Classroom ... No. 5: hardware logical functions
- Digital Group MAXI-Basic
- Utilize ASCII Control Codes!
- Dedicated Controllers
- Try WORDMATH!
- Time for Timesharing?
- Build a Universal I/O Board ... for your Altair

### November 1977

- Everything about Assemblers! ... sure beats hand-coding
- Your Image Counts!
- Lifetime Program
- Consider a MITE Printer ... alternative to the ASR-33
- Tired of Substituting Chips?
- Stretch Those Characters ... mods for the SWTP PR-40
- Magnetic Bubble Memory
- Reliable Conversion Techniques
- Salesmanship, Hardware and Coffee
- Hyper about Slow Load Times? ... KIM Hypertape is an alternative
- Interested in Commercial Programming?
- Kilobaud Classroom ... No. 6: voltage, current and power supplies
- Expand Your KIM! ... with Altair bus devices
- Enhance Your Memory ... with home information retrieval
- Build the \$35 Modem ... uses the MC14412 and a UART
- Another Look at Benchmark Program
- Son of Submarine Game
- Payroll Program ... for small businessmen
- SC/MP Goes Baudot ... add an inexpensive TTY

### December 1977

- TVT Hardware Design ... Part 1: instruction decoder and scan
- Expand Your KIM! ... Part 2: getting to the nuts and bolts
- Payroll Program (Continued) ... cassette techniques
- The Business Market
- ALL CAPS
- The "Learning Machine" ... math tutor program
- Kilobaud Classroom ... No. 7: transistors, diodes and op amps
- Compleat Guide to Logic Diagrams
- Tiny BASIC
- The Twelve Days of Christmas
- Paper Tape: It's Here to Stay ... a look at the OP-80A
- Tempus Fugit
- Who Needs a Broker?
- Here's HUEY! ... super calculator for the 6502
- Crash Landing! ... a real-time Lunar Lander game
- File Structures Simplified

# kilobaud microcomputing

## articles you may have missed during '78 & '79

### January 1978\*

### February 1978

- Biorhythms with Your KIM
- Vandenberg Data Products 16K Board Reviewed
- Inventory, Accounts and Reports
- Small Business Software... Part 1: accounts receivable
- The Music Man
- STAR WARS
- Hot-Rod Mods for Your SWTP System
- Ticked by Fickled... a charting and diagramming aid
- Ready on the Firing Line?
- Expand Your KIM!... Part 3: bus control board and memory
- Interfacing Tips
- Kilobaud Classroom... No. 9: Counters and Registers
- Teaching Preschoolers Letter Discrimination
- Why Structured Programming?
- Source Listing the Hard Way
- How Good Is Tarbell's Floppy Interface?
- Manipulating ASCII Data
- Read any Good Books Lately?... a program to test readability
- George Morrow's Versatile Front-Panel Board
- Deflection!... a video game for the quick and agile
- How Much Memory for a KIM?

### March 1978

- Build the "Simple Computer"... a home-brew 8080
- Hardware Program Relocation, Part 2
- State Capitals
- Customized MIKBUG
- TV Typewriter Update
- Foolproof Cassette Operation
- Number-Crunching Time
- Super Terminal!... interfacing the Burroughs 9350-2
- Consumer Computer, Inc.
- Programmed Instruction Made Easy: Tiny PILOT, Part 1
- Protect Your Memory Against Power Failure
- Backup Techniques... how fail-safe is your system?
- Small Business Software, Part 2
- Expand Your KIM!... Part 4: a TTY substitute
- Faster Erase Times... build a quicker EPROM eraser
- I/O Programming for the Altair Disks
- The Axiom EX-800
- Tiger Trouble!... TI programmable-calculator safari
- Temperature Sensing
- A Different Approach to HI-LO

### April 1978\*

### May 1978\*

### June 1978

- Taming the I/O Selectric... Part 1: hardware interface
- Home-Brew Z-80 System... Part 1: front-panel construction
- A Strategy for Healthy Living... computerized exercise/fitness program
- A Tour of the Faire, Part 1
- Tiny BASIC Shortcuts
- Baudot... er... Murray, Meet the H8
- 8080, Z-80 or 8085
- One Keyboard: Hex and ASCII
- Is the Malibu Model 160 the Printer for Your Business System?
- The Great Computer Conspiracy
- Personal Computer Shows
- Cross-Country Balloon Trip
- Transfer Vectors vs Absolute Addressing
- Error Correcting Codes
- ASCII to Baudot... er... Murray (the Hard Way)
- Bowling Scores for Dollars
- Machine Language for the TRS-80... Radio Shack's T-BUG
- Two Systems Sharing the Same Bus
- Computers in Classrooms: Teaching the Teachers

### July 1978\*

### August 1978

- DOCUFORM: A Word-Processing System for Everyone!
- Kilobaud Classroom... No. 11: Data and Address Buses
- Software Debugging for Beginners
- Mits vs North Star
- Kansas City Standard... at 1200 baud
- Swords and Sorcery!
- Two Hobbies: Model Railroading and Computing, Part 2
- Update: Lunar Lander
- The Do-It-Yourself System... Heath's H8 is a winner!
- KIM + Chess = Microchess
- Is There Intelligent Life in Your Computer Room?
- From Base to Base... with your HP 25
- FINANC: A Home/Small-Business Financial Package
- Computer-Generated Signs
- Copying Computer Cassettes

- Something Extra With Radio Shack's BASIC
- The Amazing 1802
- Who Needs a UART?
- Can't Find It?... an index for your SWTP BASIC manual

### September 1978

- (Con)text Editor
- At Last: A Client Timekeeping System
- Troubleshooters' Guide
- Metric-American Conversion Program
- The Heath/DEC Connection... Part 1: overview
- Home System Demo Program
- Do-It-All Expansion Board for KIM
- Tally Ho!... fox and hounds game
- Baudot Interface Cookbook
- Error-Correcting Techniques
- KIM Organ
- Kilobaud Classroom... No. 12: ROM and RAM memories
- Motorola's Latest: The MC6802
- TRS-80 Update: Level II BASIC
- Super Cheap 2708 Programmer
- Something Extra in Mass Storage... Meca's Alpha-1
- From Big BASIC to Tiny BASIC

### October 1978

- Budget System... KIM, keyboard, TV, TVT-6L and AKIM
- The Heath/DEC Connection... Part 2: H11 system peripherals
- Depreciation Calculations
- Looping in Tiny BASIC
- Kilobaud Classroom... No. 13: I/O Circuitry
- Let Your Computer Wear a Watch
- Randomness is Wonderful
- Dazzler and BASIC
- The Latest in Operating Systems for the 6800: FLEX
- Action on the Enterprise
- Will DEC and IBM Be the Final Winners?
- Little Bits
- View from the Far East
- Use That Parity Line!
- The Software Patchcord
- A Useful Address List Program
- Ready for the Nuthouse?

### November 1978\*

### December 1978

- Dura/Intel Selectric for Low-Cost Hard Copy
- A "Gift" That Keeps on Giving
- The Art of Generating Expense Reports
- Deep, Dark Secrets of the TRS-80 (Level I)
- Interfacing the Elf II
- The Care and Feeding of Cassette Tapes, Part 1
- Kilobaud Classroom... No. 15: computer I/O III
- Raster Scan Graphics for the 6800... Part 2: the software
- SWTP 4K RAM Write Protect Option
- TSC Text Editor
- Spelling Bee
- Two Interface Boards from Teletek
- Attention, Chess Buffs!
- The Ups and Downs of Business
- BASIC Control of Servomechanisms
- There Is a Better MIKBUG!
- How to Write Good Application Programs
- Sharing Scheme for RS-232 Channels

### January 1979

- An Editor for 6800 BASIC Programs
- u-Panel for KIM
- Rolling Dice
- Pseudo Graphics
- The BCS and Its President
- Address List Editor
- Display Your PET!
- TRS-80 Tape Controller
- SHHH—People Are Sleeping
- Say It with a Banner
- Open House
- Cassette Interfacing
- PET Techniques Explained
- A Service Bureau for Hobbyists
- Little Bits
- Keeping Ma Bell Happy

### February 1979

- Block-Structured Language for Microcomputers
- Kilobaud Classroom, No. 16: I/O IV
- Computerized Climate Control
- Music, Maestro!
- Madam Dupre's House of the Zodiac
- Disk Power!
- Inventory Control with the TRS-80
- Onward with the COSMAC Elf!
- Build a \$50 TVT!
- Percom's LFD-400 Floppy Disk System
- DOTS
- The Apple Speaks—Softly

- Super Mastermind
- TRS-80 Level II Reference Manual Index
- Care and Feeding of Cassette Tapes (Part 2)
- Text/Document Preparation Made Easy
- Simpler Interest
- Learn BASIC—with BASIC
- Use Flowcharts to Communicate
- Joystick Interface for Your Altair
- Attack on the Pack!

### March 1979

- Cheap Video for Your Heathkit H8
- Analog and Digital Interfaces
- The "El Cheapo" EPROM Programmer
- Is Your Video Monitor Dangerous?
- Thoughts on the SWTP Computer System
- PET User Port Cookbook
- Chess Pawn
- Home Computer Exterior Ballistics
- Heath H9 Page Erase
- The SKIP II Microcomputer
- Ultra Banner
- Teletype's KSR-43
- The One Percent Forecasting Method
- Too Many Variables?
- Kilobaud Classroom No. 17: I/O V
- The Electric Pencil
- How to Talk to Your 8080
- Programming the 1802
- Keyboard Interrupt for the TRS-80
- The OSI Model 500
- Sleep Better with a Microcomputer
- Telpar Thermal Printer

### April 1979

- A Look at TRS-80 Peripherals
- Heath H8 Disk System
- DOTS (Part 2)
- Truly Random Numbers
- SWTP CT-1024 Mod
- Who Sells Software?
- How Important Is Proper Termination?
- How to Talk to Your 8080 (Part 2)
- Parallel Port to RS-232—Inexpensively
- Free Speech Lessons for the TRS-80
- Let's Go Flying
- Floppy Disk System from Tarbell
- The Wait State Explained
- Depreciation Analysis
- Twin Cassettes for Your TRS-80
- Bar-Graph Generator
- Let's Have Some Order
- Quicksort!
- Put Something Super in Your Life
- Starship Attack
- Terminate Your Troubles
- Testing PET Search Algorithms
- Two Diamonds
- How about a Printer?
- A Look inside the TRS-80

### May 1979

- A Text Formatter in BASIC
- KIMCTR
- High-Speed Cassette Interface
- How to Talk to Your 8080 (Part 3)
- Data Base Management
- Analog and Digital Interfaces (Part 2)
- COSMAC Double Play
- COSMAC Double Play (cont.)
- From Microcomputer to Micro-Piano
- A Game of Darts
- Prettyprinting with Microsoft BASIC
- Kilobaud Classroom No. 18
- MDOS
- A TRS-80 Cross-Index
- Graphing with the TRS-80
- An All-in-One Interface

### June 1979

- "Monitor"
- TRS-80/Selectric Word Processor
- Thoughts on the SWTP Computer System (2)
- New Life for Our Altair
- TVBUG
- Creative Tabulation
- A Handle on Programming
- Keepbook
- Vector Graphing Techniques
- Putting the 1802 on the S-100 Bus
- A Personal Finance System (Part 1)
- Building a New Horizon
- Microcomputers and TVI
- Translating Between TTL and RS-232 Levels
- Data Files for Processor Tech 5K BASIC
- Little Bits
- What's so Magic about the Sorcerer?

(Back Issues Catalog continues on following page.)

\*issues not available.

**June 1979, continued:**

- A Telephone Data Coupler for the TRS-80
- The Cromemco Z-2D
- Personal Computing, Meet Photography
- Peripheral Interfacing

**July 1979**

- IC Logic Tester and Parallel I/O Expander
- Whip file Wipeouts in the TRS-80
- HUH Electronics' Model 8100 Motherboard
- Data File Creation Program
- Computer Careers in Carolina
- Personal Finance System (Part 2)
- Sargon Meets TRS-80
- Safe I/O Ports with a Bidirectional Buffer
- Projecting Future Profits
- Randomness Is More Than It Seems
- OSI's Superboard II
- Teach an old PET New Tricks
- A Circular Handle on Graphics
- 1802 PILOT
- Red-Handed Credit Grabber
- Troubleshooting Tips and Techniques
- Super Starter Kit from Technico
- Thoughts on the SWTP Computer System
- CONOPS: an H8 Monitor
- Getting the Most out of Your TRS-80
- Reading Computer Jargon
- An Introduction to Microfilming
- The 6502 and Its Little Brothers
- Another Hexadecimal Keyboard

**August 1979**

- Cover Up: PET Home-Decorating Program
- Teleprinter Output for TRS-80
- Murphy's Laws and Other Observations
- Thoughts on the SWTP Computer System
- MUSKBD: Music Program for the 6800
- E-x-t-e-n-d Your Micro with the Mullen Extender Board
- The BASIC BASIC Renumberer for H8
- Shavasan Meditation Program
- Personal Finance System (Part 3)
- Percom CI-812 Mod
- Report: Financial Reports Program
- Haiku Composer: Poetry on the TRS-80
- The Sorcerer Connection: Sorcerer to Teletype
- Apple Ciphers: An Apple II Billing System
- The PAIA 8700
- Don't Throw Away That Monitor—Yet!

- Nerves: A Fast Game
- Taking AIM with Rockwell International's AIM 65
- How to Silence a Noisy Computer
- PET Wrap-up
- Machine-Language Monitors for TRS-80
- Visit to OSI

**September 1979**

- A Look at Terminals
- Inventory: Nine-operation Inventory Program
- Metric, English Equivalents Program
- A Look at Core Memory in Micros
- The MM57109 Number Cruncher
- Gas-Monitoring Program
- The Fourth Faire
- Output for the SWTP Editor-Assembler
- Interfacing SQL with a Vista Disk
- The Failure of a Micro in Business
- Thoughts on the SWTP System
- 2708 EPROM for the S-100
- Review of Lear Siegler's ADM-3A
- Off-the-Shelf Word-Processing System
- Catching Bugs with Lights
- Make PET Hard Copy Easy
- Apple II High-Resolution Graphics
- Beat the Computer: Blackjack Strategy
- Put Your PET on the Betsi Bus
- Build Your Own TTL Diagnostic Aid
- Using and Expanding the Heath ET-3400
- Another KIM-1 Expansion
- Adult Caloric Requirements
- TRS-80 Speed-up

**October 1979**

- Thoughts on the SWTP Computer System
- PAIA 8700 Revisited
- Inexpensive TRS-80 Printer Interface
- Eyes for the AC-30
- Expanded TRS-80 Disk Operations
- Anatomy of a Scam
- Business Software Made Easy
- KIMCTR Measures Capacitance
- More TRS-80 Horsepower
- Probos V: An Inexpensive Logic Probe
- PET's Keyboard Grows Up
- Hurricane! Track Hurricanes with This Program
- Video DMA Interface for SWTP Systems
- Ultimate Consumer Computer
- The Exatron Stringy Floppy
- Calendar Program
- Four More Commands for SSB DOS

- Arena: Go into Battle with Your Computer
- File Directory Analysis for North Star DOS
- Report on the Centronics 779 Printer
- Beefing Up PET
- AMI's EVK Series
- Ulysses in Computerland
- The Apple II Programmer's Aid ROM
- Caps Lock, Not Shift Lock
- Hardware Random Number Generator
- Bit Rate Clocks for Your Serial Interface
- Exploring the Inequality of Bus Buffers
- Speed Up Your Elf's Input-Output
- Load Programs the SIMPL Way
- Pig Latin
- Touch: This Icebreaker Could be a Jawbreaker
- Program Debugging
- Build an Inexpensive Logic Analyzer
- Increasing the Bytesaver's Usefulness

**November 1979**

- Lowercase for Your Apple II (Part 1)
- What's New in Memory?
- Stringy Floppy Encore
- The Electronic Librarian
- Text Editing for the TRS-80
- The Apple Goes to Market
- Let's Look at NEWDOS+ from Apparat
- AMI's EVK Series
- Thoughts on the SWTP Computer System
- Payroll Program for Business Systems
- Thinker Toys' Discus I Disk System
- Expanded TRS-80 Disk Operations
- An SSM/Jade Video Board for Less Than \$120
- Wave the Flag
- Real Property Profit Guide
- The TRS-80 Dial-a-Phone
- Wari: A Challenging Game
- A-Mazing: Maze-Generating Algorithm
- Sound for the Elf II
- Sherlock Holmes and the Computer
- ASCII-to-Selectric Software Driver
- Introduction to TI's TMS-9900
- Have a Ball with Bally
- The Output Buffer/Driver
- Micropolis Disk Drives
- Weight-Watching Special
- \$10 PET-to-Centronics Interface
- A BASIC Dollar Edit Subroutine
- How to Build a Word Processor
- Wire-Wrap Pin Locating

**BACK ISSUE CATALOG: ENCYCLOPEDIA OF MICROCOMPUTING**

Indicate with an "X" which issues you would like:

	1977		1978		1979	
January	(\$5.00)		NOT AVAILABLE		(\$5.00)	
February	(\$3.00)		(\$5.00)	—	(\$3.50)	
March	(\$3.00)		(\$3.00)		(\$3.50)	
April	(\$3.00)		NOT AVAILABLE	—	(\$3.50)	
May	(\$3.00)		NOT AVAILABLE	—	(\$3.50)	
June	(\$3.00)		(\$5.00)		(\$3.50)	
July	(\$3.00)		NOT AVAILABLE		(\$3.50)	
August	(\$3.00)		(\$3.00)		(\$3.50)	
September	(\$3.00)		(\$3.00)		(\$3.50)	
October	(\$3.00)		(\$3.00)		(\$3.50)	
November	(\$3.00)		NOT AVAILABLE		(\$3.50)	
December	(\$3.00)		(\$3.00)			

TOTAL \_\_\_\_\_ TOTAL \_\_\_\_\_ TOTAL \_\_\_\_\_ Grand Total: \_\_\_\_\_  
 Add \$1.00 shipping/handling \_\_\_\_\_

Enclosed \$ \_\_\_\_\_

Check     Money Order    Bill my:  American Express     Visa     Master Charge

Credit Card Number \_\_\_\_\_

Expiration Date \_\_\_\_\_ Signature \_\_\_\_\_

Name (please print) \_\_\_\_\_

Address \_\_\_\_\_

City \_\_\_\_\_ State \_\_\_\_\_ Zip \_\_\_\_\_

ITEM NO.  
WK-7

CMOS SAFE

# IC INSERTION/EXTRACTION KIT

**KIT INCLUDES**

- MOS-1416 14-16 CMOS SAFE INSERTER
- MOS-2428 24-28 CMOS SAFE INSERTER
- MOS-40 36-40 CMOS SAFE INSERTER
- EX-1 14-16 EXTRACTOR
- EX-2 24-40 CMOS SAFE EXTRACTOR



**OK MACHINE & TOOL CORPORATION**  
3455 CONNER ST., BRONX, N.Y. 10475 U.S.A.  
PHONE (212) 994-6600 TELEX NO 125091



PRINTED IN U.S.A.

PATENT PENDING

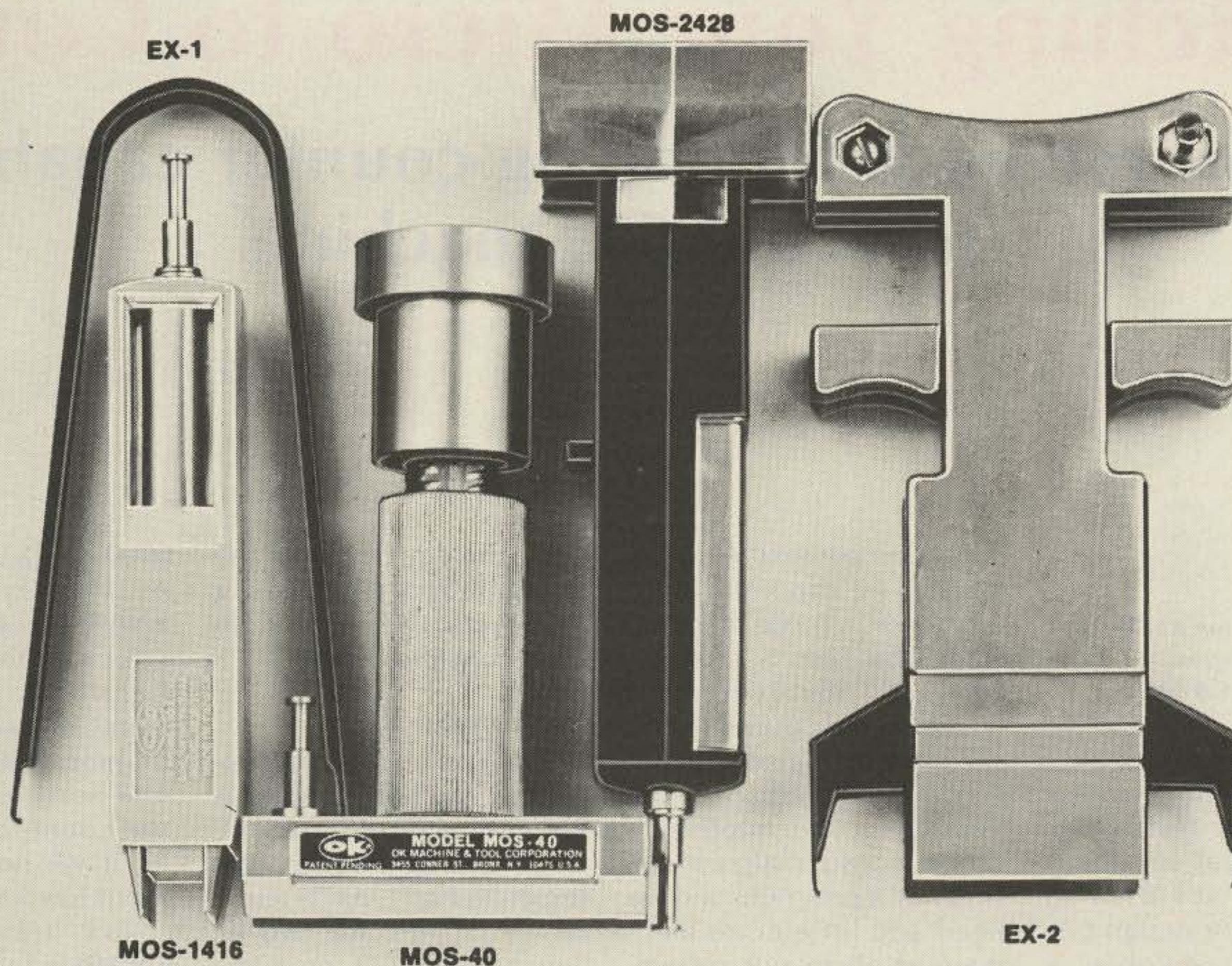

WK-7	COMPLETE IC INSERTER/EXTRACTOR KIT	\$29.95
------	------------------------------------	---------

### INDIVIDUAL COMPONENTS

MOS-1416	14-16 PIN MOS CMOS SAFE INSERTER	\$ 7.95
MOS-2428	24-28 PIN MOS CMOS SAFE INSERTER	\$ 7.95
MOS-40	36-40 PIN MOS CMOS SAFE INSERTER	\$ 7.95
EX-1	14-16 PIN EXTRACTOR TOOL	\$ 1.49
EX-2	24-40 PIN CMOS SAFE EXTRACTOR TOOL	\$ 7.95

MINIMUM BILLING \$25.00. ADD SHIPPING CHARGE \$2.00. NEW YORK RESIDENTS ADD APPLICABLE TAX.

✓ 05

OK MACHINE & TOOL CORPORATION 3455 CONNER ST., BRONX, N.Y. 10475 (212) 994-6600/TELEX 125091

# Teaching Your Micro to Count

## — two methods for adding counter capability to your 6502 machine

Sam Creason K6EW  
2940 Arlington Ave.  
Fullerton CA 92635

One of the handier pieces of test equipment for digital circuits is a counter. If it's used to troubleshoot or design systems which involve a microprocessor ( $\mu\text{P}$ ), it need not be expensive, since it need not count at a rate faster than a few MHz. Then, too, if it's used with an already-existing  $\mu\text{P}$  system, it is simple to construct, since the  $\mu\text{P}$  system can replace some of the hard-wired logic that is normally required.

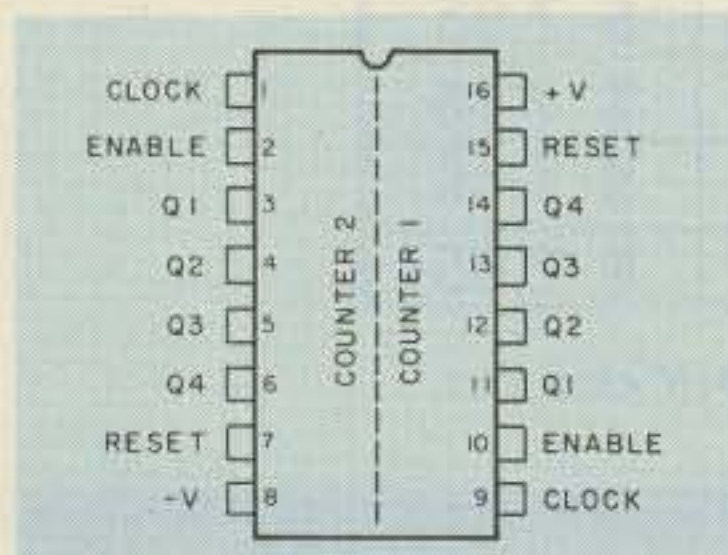

Fig. 1. Pin connections of 4518 dual BCD counter.

In the context of a  $\mu\text{P}$  system, we can implement a counter in more than one way. The first is straightforward, involving ICs which do the counting. The second way is also straightforward, but rather unconventional. The implementation consists almost entirely of a program, and we need add little or no hardware at all to our system. By comparing the two implementations, we can learn a little about replacing hardware with software and see what trade-off is involved. Our primary goal, though, is simply to add a useful piece of equipment to our system. As we'll see

	Q <sub>4</sub>	Q <sub>3</sub>	Q <sub>2</sub>	Q <sub>1</sub>
0	0	0	0	0
1	0	0	0	1
2	0	0	1	0
3	0	0	1	1
4	0	1	0	0
5	0	1	0	1
6	0	1	1	0
7	0	1	1	1
8	1	0	0	0
9	1	0	0	1

Fig. 2. Response of counter to square wave.

later, the conventional implementation produces a more versatile counter, so we'll consider it first.

### The Counter IC

The principal component of our first counter is the 4518 dual BCD counter. Its pin connections are shown in Fig. 1. As its name implies, there are two independent BCD counters within the IC. There is no particular significance to the designations "1" and "2" in the figure.

Each counter has a RESET input. Applying a high level to this input forces outputs Q<sub>1</sub>, Q<sub>2</sub>, Q<sub>3</sub>, and Q<sub>4</sub> to 0. Applying a high level to the ENABLE input and a low-to-high transition to the CLOCK input then advances the count from Q<sub>4</sub>Q<sub>3</sub>Q<sub>2</sub>Q<sub>1</sub> =

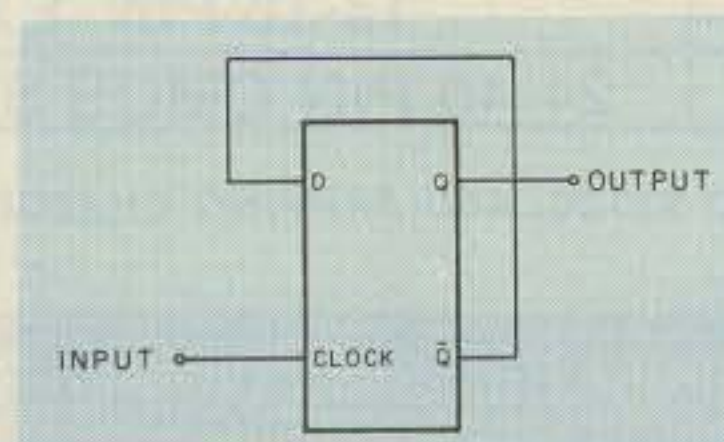

Fig. 3. Conditioning circuit.

0000 to Q<sub>4</sub>Q<sub>3</sub>Q<sub>2</sub>Q<sub>1</sub> = 0001. As long as we hold the ENABLE input high, each successive low-to-high transition advances the count by one until a count of nine (1001) is reached. The next transition returns the count to 0000. Similarly, if we hold the CLOCK input low and apply a high-to-low transition to the ENABLE input, the count will advance.

If we want to determine the fundamental frequency of a square wave, and we know that it's between one and nine Hz, we can make at least an approximate measurement by applying the square wave to the ENABLE input and carrying out the following sequence of operations:

1. Take CLOCK input high.
  2. Reset counter.
  3. Take CLOCK input low for one second.
  4. Take CLOCK input high.
- At the end of this sequence, the count is numerically equal to the frequency of the square wave in Hz, give or take a Hz.

Alternatively, we could accomplish the same thing by applying the square wave to the CLOCK input, taking the ENABLE input low, resetting the counters, and taking the ENABLE input high for one second.

### A Multi-Digit Counter

To make useful measurements, we very often need a counter which can count beyond nine. For this, we can use the output of one counter to drive an input of a second counter, and so on. Since the digital display of my system has six digits, I used a total of six counters (three 4518s).

Although the waveform which we want to measure can be applied to either the CLOCK or the ENABLE input of the first counter, we have to be careful about the way in which we interconnect the remaining counters. As successive cycles of the waveform toggle the first counter, the outputs of that counter change as shown in Fig. 2. Each time the count changes from 9 to 0, the next counter should be toggled once. That is, as the count in a particular counter goes from 9 to 0, that counter should generate a carry for the next counter. For this purpose, we can use the  $Q_4$  output of the counter. As the count goes from 9 to 0, that output makes a high-to-low transition. Thus, we need only tie the  $Q_4$  output of the first counter to the ENABLE input of the second counter, and tie the CLOCK input of the second counter permanently low. We can add as many more counters as we like, in a similar way.

### Measuring a Frequency—The Timebase

At this point we have a multi-digit counter, but we need a way to enable or

disable counters so that we know how much time was spent accumulating a particular count. That is, we need a timebase. A  $\frac{1}{2}$ -Hz square wave is a reasonable choice, since it's high for one second, low for one second, and so on. If we apply such a square wave to the CLOCK input of the first counter and apply the waveform which we want to measure to the ENABLE input, the first counter will count for one second, stop counting for one second, and so on. Since the first counter won't generate carries when it's not counting, the five remaining counters will count and stop also. To make a measurement, we let the counters count for one second and then process and display the count during the next second.

If we use a  $\frac{1}{2}$ -Hz square wave as a timebase, the count which is accumulated during one counting period is numerically equal to the frequency in Hz of the unknown waveform. Since our counter has six digits, 999,999 Hz is the highest frequency which it can measure under these conditions. We can extend that range by a factor of

ten if we use a 5-Hz square wave as a timebase, since such a square wave is low for only a tenth of a second at a time. During that time, a 9.99999-MHz waveform will produce a count of 999999, which our display can accommodate. In this case, the count is numerically equal to the frequency in Hz/10.

Since the CMOS counters which we'll use can't be toggled faster than about 2-3 MHz (when a 5-volt power supply is used), we have no immediate need for a timebase which is higher in frequency than 5 Hz.

At this point, then, we have in hand the necessary ingredients to make measurements of frequency. Before we turn our attention to the hardware itself, however, let's consider one additional topic.

### Measuring a Period

We've seen that measuring a relatively high-frequency waveform isn't all that difficult, but what if

the unknown waveform has a frequency of, say, 10 Hz? If we use a  $\frac{1}{2}$ -Hz square wave as the timebase, then 10 counts will be accumulated at a time, and our measurement will be accurate to only one part in ten. For many purposes, that's adequate. However, if we want to count long enough to take full advantage of our counter, we'll have to use a 1/20000-Hz square wave as the timebase. Of course, that means that the counter will count for about five and one-half hours at a time!

There is a better way, and it involves using the unknown waveform as the timebase while the counter counts cycles of a waveform for which the frequency is known. For example, if the known frequency is 1 MHz, and a count of, say, 97,350 accumulates during one "on period" while using the unknown waveform as the timebase, then the "on period" is 97,350 micro-

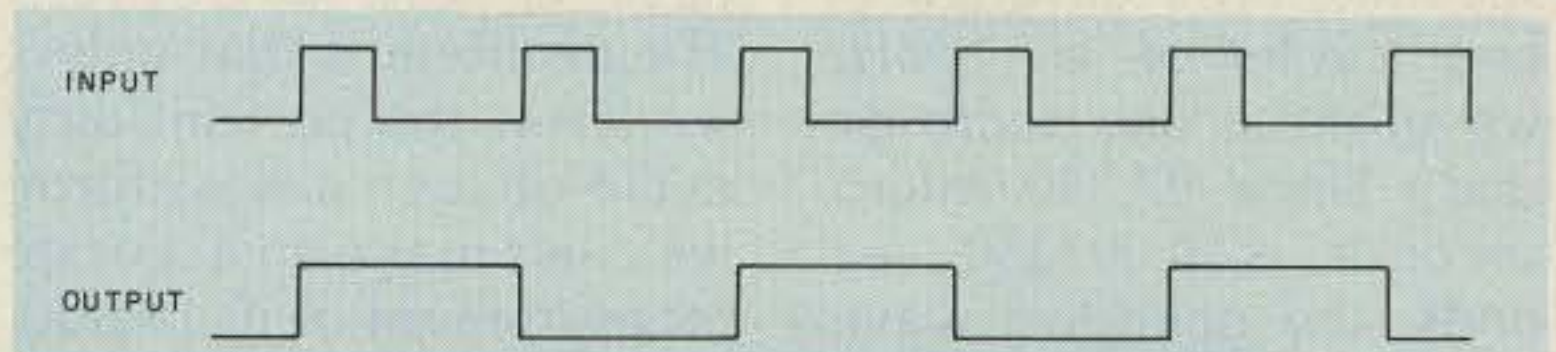

Fig. 4. Effect of conditioning circuit.

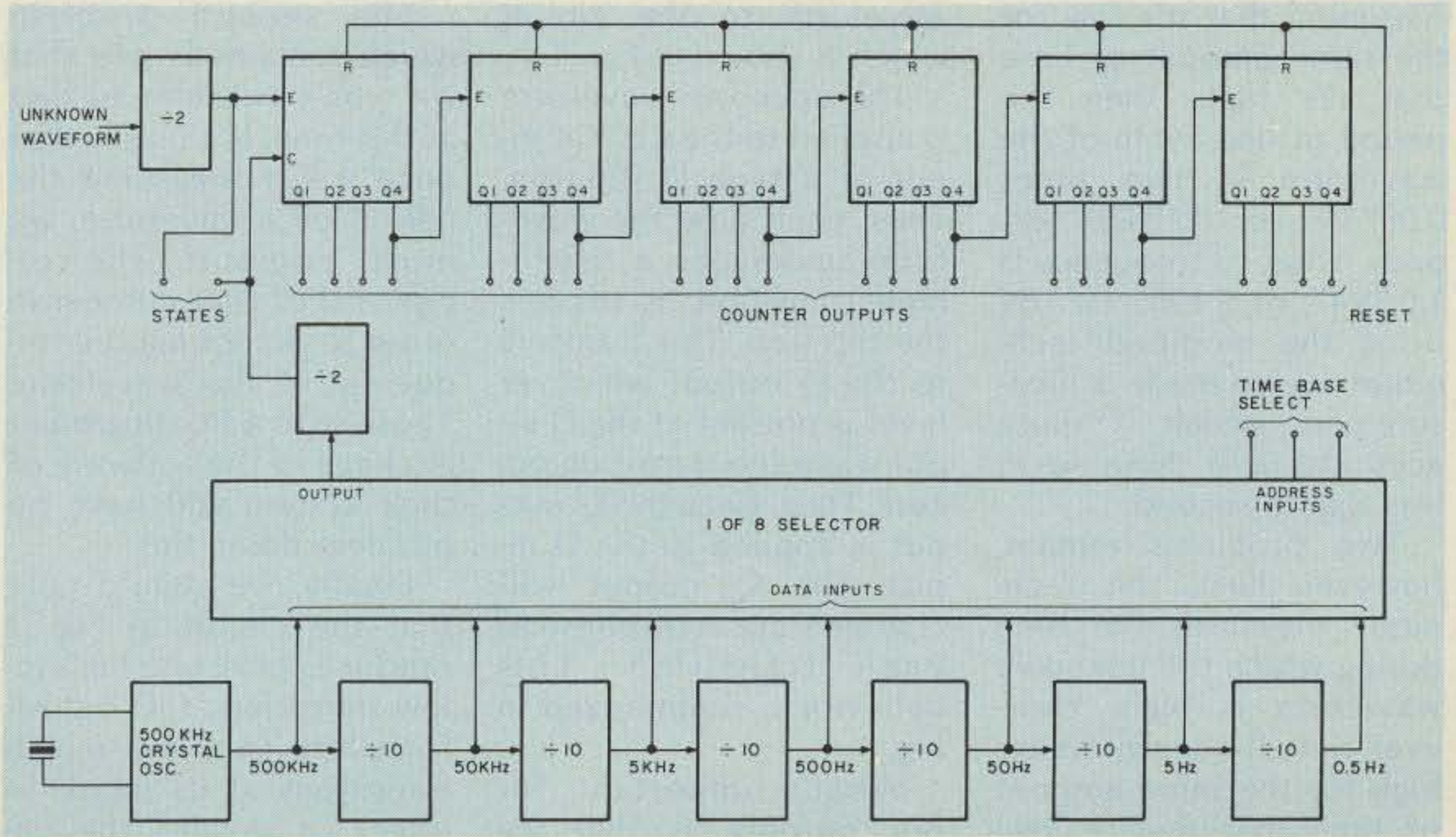

Fig. 5. Block diagram of counter.

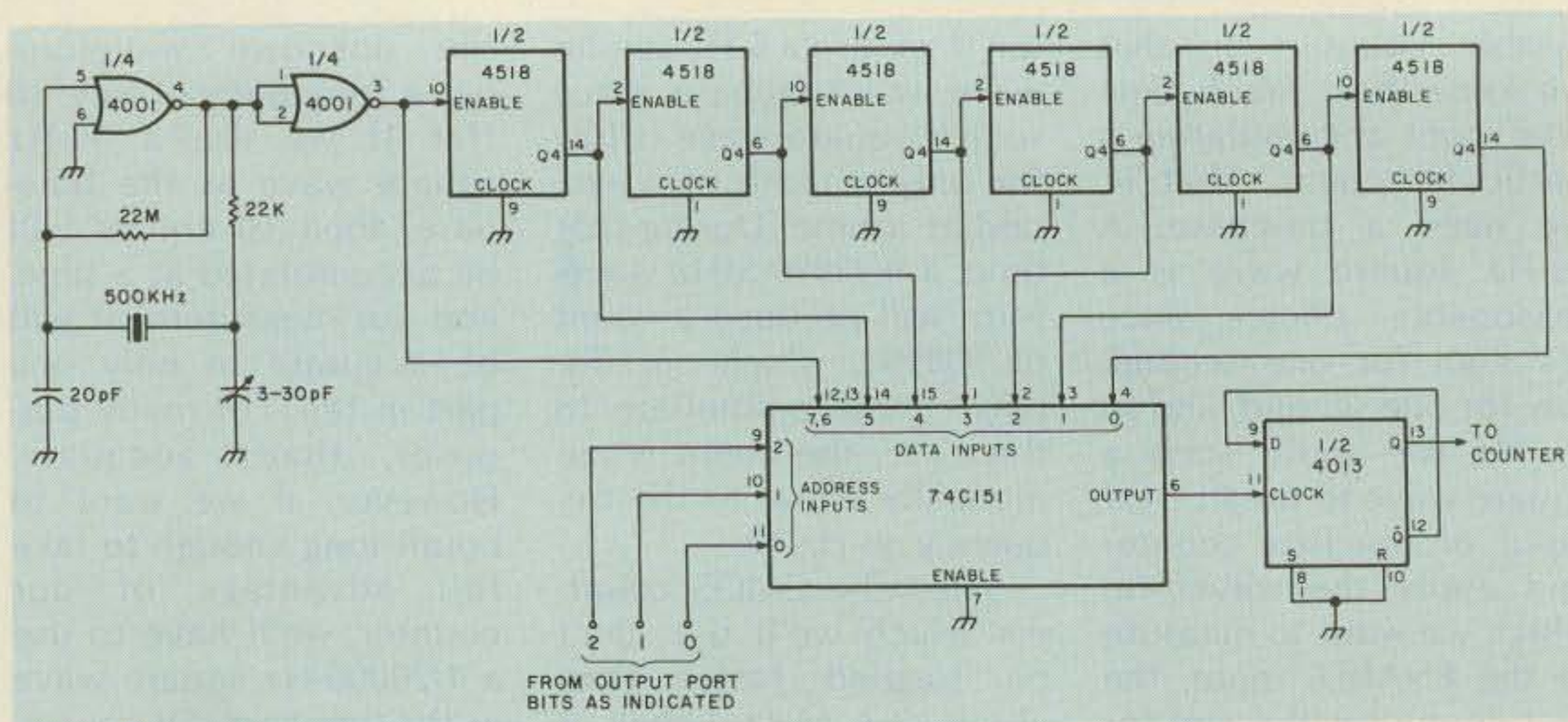

Fig. 6. Timebase for counter. Note: Ground reset terminals of 4518s (pins 7 and 15).

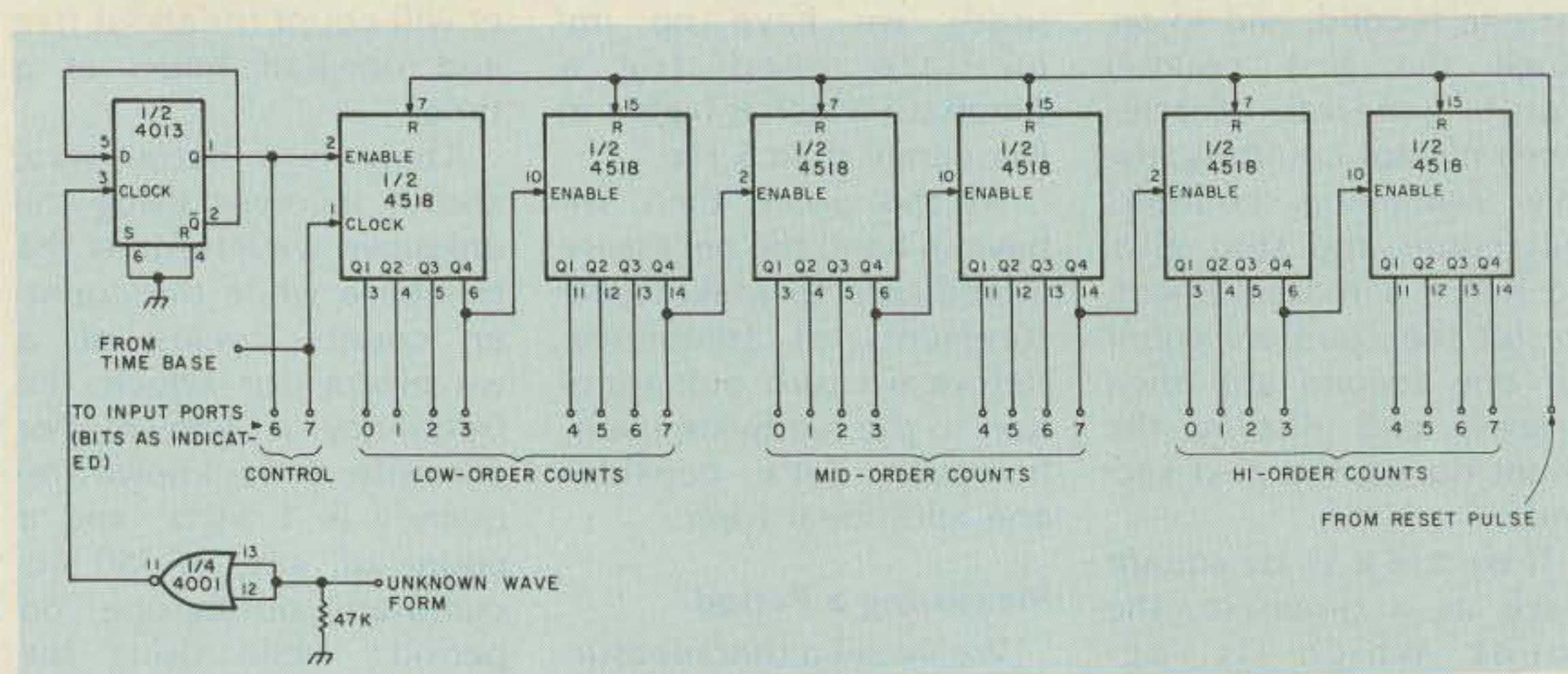

Fig. 7. The counters. Note: Unless otherwise specified, ground clock terminals of 4518s (pins 1 and 9).

seconds. (The duration of one cycle of a 1-MHz waveform is one microsecond.) Since 97,350 microseconds is 0.097350 seconds, the unknown waveform must have been high for 0.097350 seconds. Assuming that it's low for the same amount of time that it's high, then the period of one cycle of the waveform is two times 0.097350, or 0.19470 seconds. Thus, its frequency is  $1/0.1947$ , or 5.1361 Hz. By using the modified technique, we've made a measurement which is quite accurate, and done so in less than a second.

Two problems remain, however. First, this technique measures the time during which the unknown waveform is high. However, not all waveforms are high for the same amount of time that they're low. That is, not all waveforms

have a 50% duty cycle. The problem is that unless we know the percent duty cycle of such a waveform, we can't make an accurate measurement of its period. A solution to the problem is to apply the unknown waveform to the circuit which is shown in Fig. 3.

The unknown waveform is applied to the CLOCK input of a type D flip-flop. Thus, each time the waveform undergoes a low-to-high transition, it triggers the flip-flop. This transfers to the  $\bar{Q}$  output whatever level is present at the D input when the transition occurs. Thus, since the  $\bar{Q}$  output is applied to the D input, the Q output will change state in response to each transition. This behavior is summarized in Fig. 4.

What's important for our purpose is that we have a waveform which is

high for one period of the unknown waveform, low for the same amount of time, and so on. That is, the derived waveform has a 50% duty cycle and we can measure its period easily.

The second problem which remains is one that we won't consider further at this time. It's simply that once we've measured the period of a waveform, we must compute the reciprocal of that number in order to determine the frequency of the waveform. Those with a floating-point package in the software of their system will have no problem doing this.

Finally, we should note that the circuit in Fig. 3 produces only one high-to-low transition at its output for every two low-to-high transitions at its input. In effect, it divides the unknown frequency by two.

Thus, if we make the circuit a permanent part of our counter, we must take this into account. An easy way to do this is to halve the frequency of the conventional timebase so that the timebase is high for two (or 0.2) seconds and low for the same amount of time.

### A Block Diagram

At this point, we can rough out a block diagram of at least part of our counter, as shown in Fig. 5.

The unknown waveform is applied to a divide-by-two circuit which, in turn, drives the first of six BCD counters (each is half of a 4018). A 500-kHz crystal oscillator generates the timebase. It drives the first of six BCD counters (each is half of a 4018). Since each counter counts to nine and generates a carry, we can view each as a divide-by-ten circuit as well as a counter.

The lowest available frequency which is available from the timebase is 0.5 Hz. A little arithmetic will show that, in this case, that value will produce a count which is numerically equal to half the frequency in Hz of the waveform—but we'll soon remedy that. A one-of-eight selector passes the selected timebase on to the input of a divide-by-two circuit. In turn, that circuit drives the CLOCK input of the first counter, and our problem is remedied.

We could use a 250-kHz crystal and dispense with the divide-by-two circuit, but 500-kHz crystals are less expensive, and the flip-flop IC which we'll use (4013) contains two flip-flops.

### The Interface

To interface the counter to a  $\mu$ P system, we need four input ports and an output port. In addition, we need a pulse which is similar to a

WRITE pulse, to reset the counters. Such a pulse can be generated by using one line of a second output port. Writing 0-1-0 onto the line produces a positive-going pulse.

Three of the input ports are used to read the contents of the counters. The fourth is used to monitor the states of the CLOCK and ENABLE inputs of the first counter. Depending on which counting technique is used (frequency or period), the state of one or the other of the inputs indicates whether or not the counters are counting.

The output port is used to apply a number to the address inputs of the one-of-eight selector, to choose the timebase.

### The Timebase

The circuit of the timebase is shown in Fig. 6.

Two gates from a 4001 quad two-input NOR IC, a 500-kHz crystal, and a few passive components make up the timebase generator. The output of the oscillator drives a chain of three 4518 dual BCD counter ICs. The outputs of the six counters are applied to the DATA inputs of a 74C151 one-of-eight selector. Depending on the number which is applied to the ADDRESS inputs of the 74C151, a particular timebase is passed on to the counters via a divide-by-two circuit.

### The Counter

The circuit of the counters is shown in Fig. 7. The unknown waveform is applied to the input of a 4001 NOR gate which acts as a buffer. (Good practice dictates that lines which originate off the board should not be connected directly to the CLOCK input of a flip-flop, in the interest of immunity to noise.) The NOR gate drives half of a 4013 type-D flip-flop IC which is configured as a divide-by-two

circuit. The output of that circuit drives the ENABLE input of the first of a chain of three 4518 dual BCD counters.

### Using the Counter With the BMPS

The counter was originally designed for use with a beginner's microprocessor system based on the 6502  $\mu$ P. That system is described in detail elsewhere.<sup>1</sup> Those who have built such a system may use the counter by adding the interface which is shown in Fig. 8. (Of course, the interface is not needed if the builder has expanded the basic BMPS to provide additional I/O parts.) Those who will use the counter with other than the basic BMPS should ignore the next two paragraphs.

A circuit which provides the necessary control signals is shown in Fig. 8(a). It consists of a 4514 decoder, a 4011 quad two-input NAND gate, and a 4081 quad two-input AND gate. Address lines  $A_0$ ,  $A_1$ ,  $A_2$ ,  $A_{14}$ , and  $A_{15}$  are applied to the inputs of the 4514. Four READ signals are generated by ANDing the R/W line with outputs of the 4514. Two pulses are generated by NANDing the  $\phi_2$  line with other outputs of the 4514. One of these is a WRITE pulse of the sort which we've used before.

The remaining pulse is complemented and used to reset the counters. When we want to reset the counters, we use a STA, STX, or STY instruction in the program. No port exists which will accept the operand of the instruction, but the pulse is generated. The address of each READ and WRITE signal is as shown in Fig. 8(a).

A circuit which provides the I/O ports is shown in Fig. 8(b). A latch (4042) and solid-state switches (4016) are used as described in Reference 1.

### Construction

The foil side of the PC board and the component layout are shown in Figs. 9 and 10, respectively. Those who will not use the counter with the basic BMPS may prefer a more compact layout which does not include the unnecessary portion of the I/O circuit.

The timebase should be checked out first. If the oscillator does not start reliably when power is applied, the values of one or more passive components should be varied slightly. With the oscillator working, we then check the 74C151 selector. Writing a number from 000 through 111 to its address inputs should tie the output of the selector to the designated one of its seven inputs. We then add the 4518s to complete the timebase. When that's done, writing a 000 to the address inputs should produce a 0.25-Hz square wave at the output of the 4013. That frequency is low enough to be observed with a logic probe.

When the timebase is working properly, we can use it to check the counter ICs. To do this, we temporarily remove the 4013 from its socket. We then

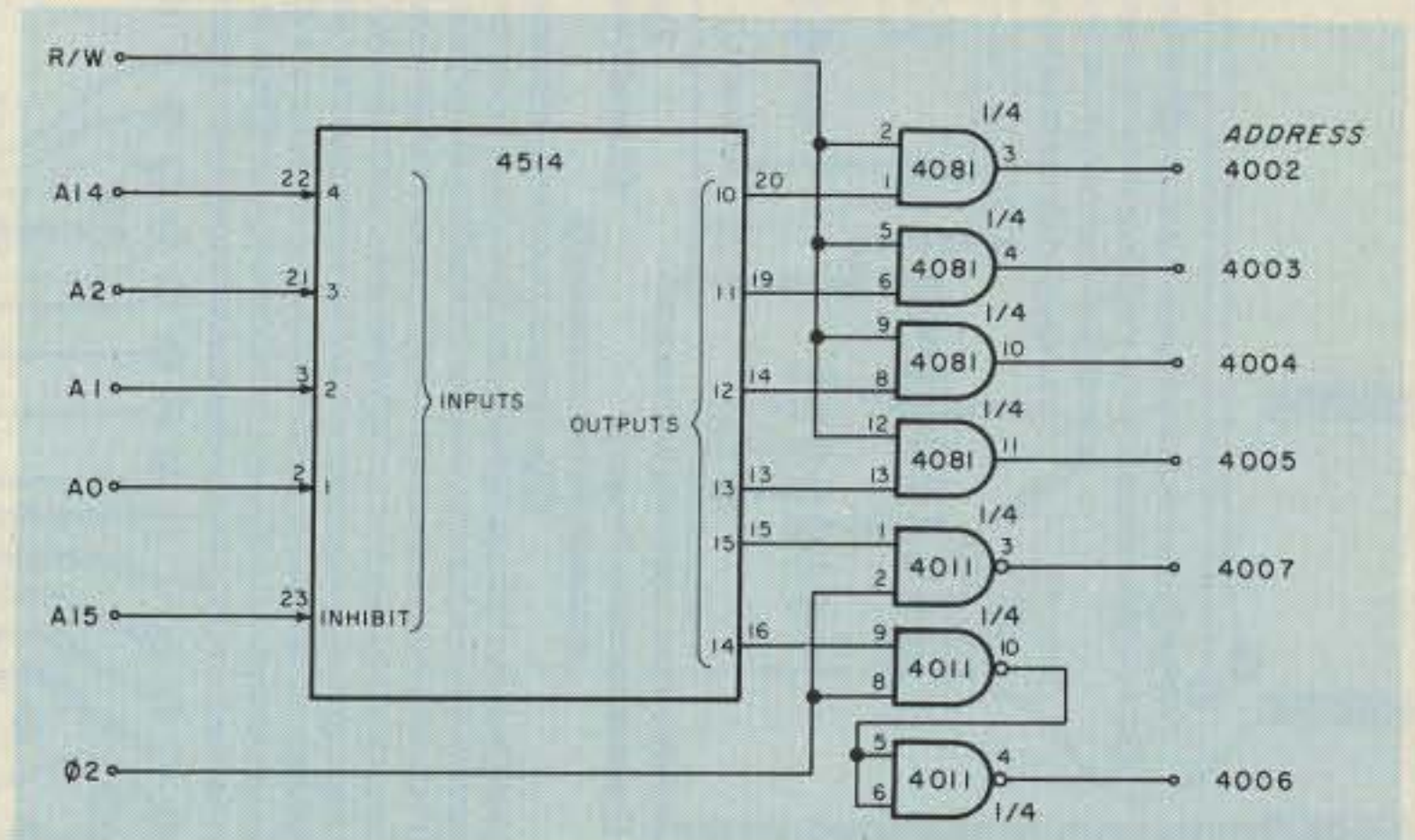

Fig. 8(a). Partial schematic of interface to BMPS.

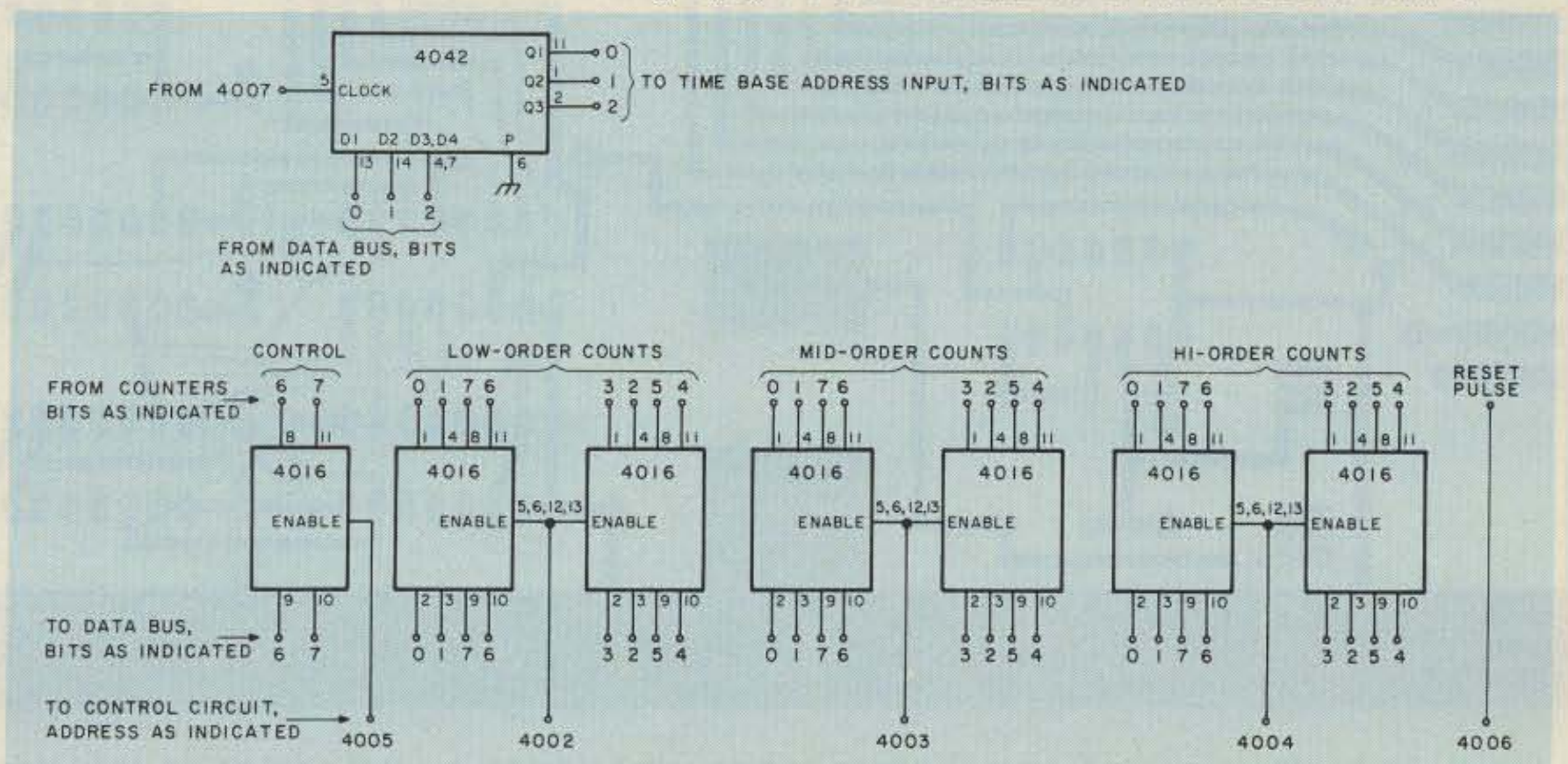

Fig. 8(b). Partial schematic of interface to BMPS.



connect the output of the timebase to the ENABLE

input of the first counter and ground the CLOCK in-

put of that same counter. The net result is that the

timebase toggles the chain of six counters. Those using

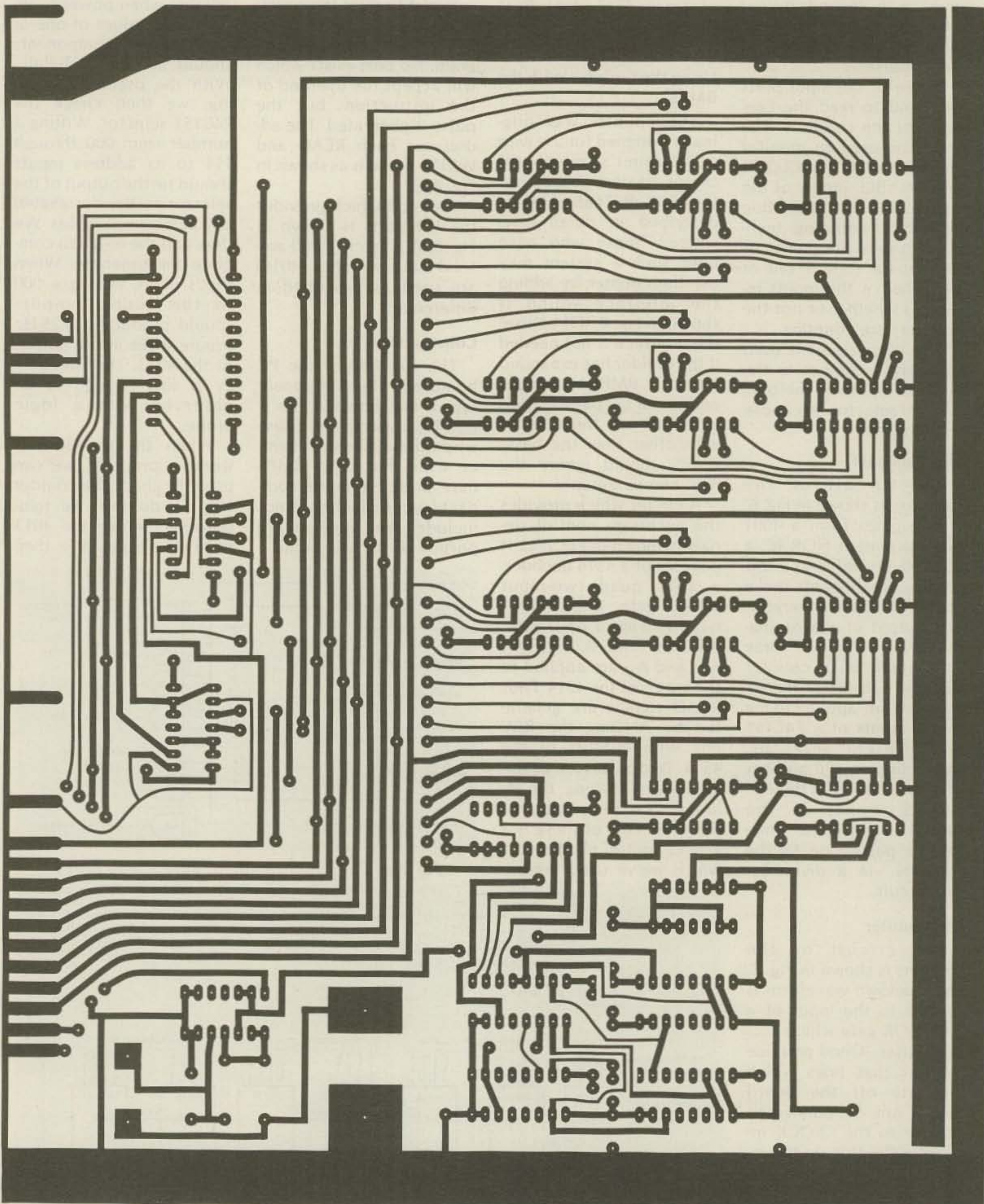

Fig. 9. Foil side of printed circuit board for counter. Install crystal socket on this side. Install a 0.1  $\mu$ F disc ceramic capacitor across power pins of each 45189 and 4013.

the basic BMPS should load the program which is shown in Fig. 11 and moni-

tor output port 8200. In this way, the outputs of any one of the pairs of counters

can be observed. Others can check the outputs of the counters with a logic

probe. Finally, we restore the 4013 and disconnect all temporary connections.

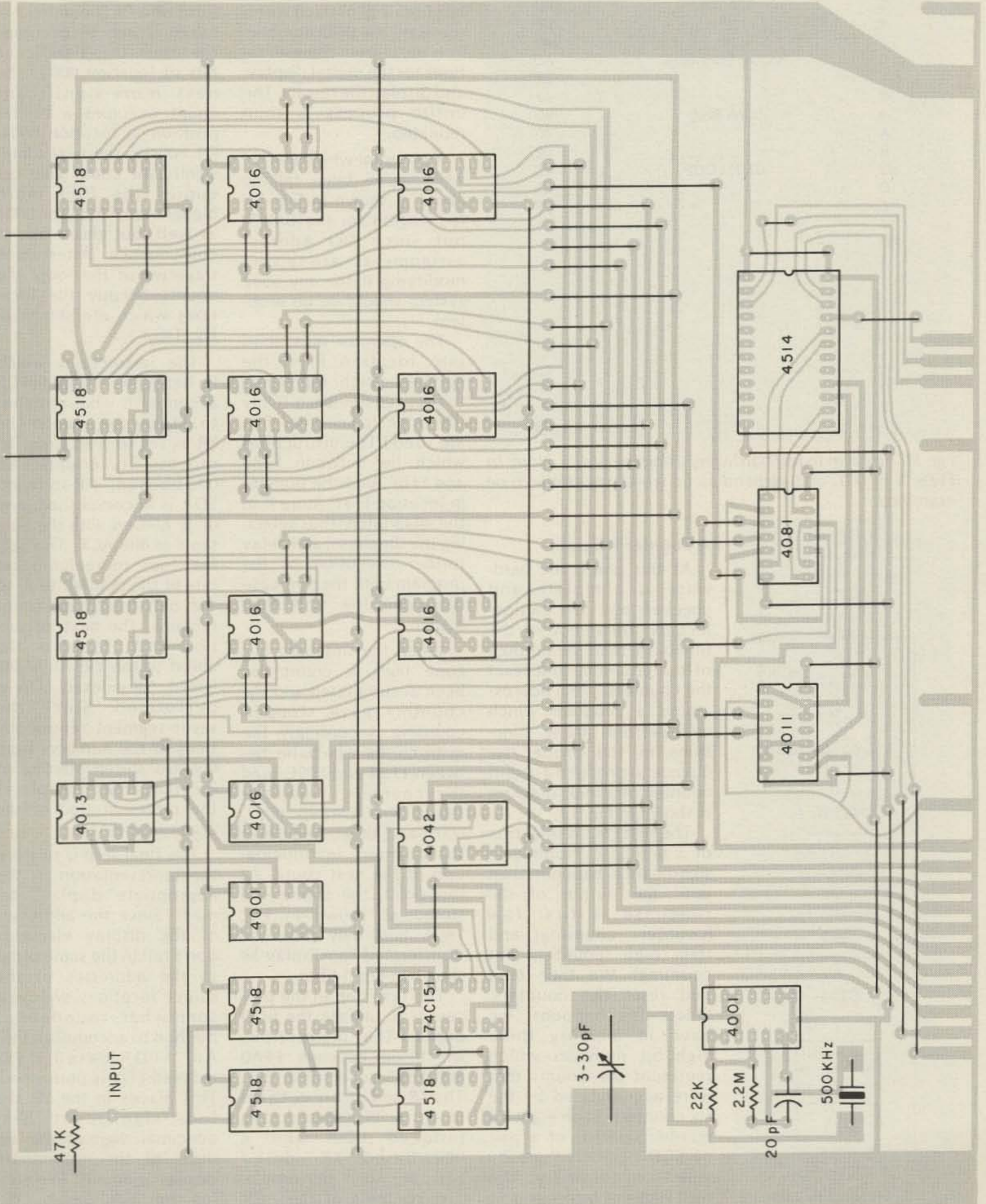

Fig. 10. Component side of printed circuit board.

Location	Instruction	Contents
FFE0	LDA TBASE	AD
1		FF
2		FF
3	STA 4007	8D
4		07
5		40
6	LOOP LDA 400X	AD
7		0X
8		40
9	STA 8200	8D
A		00
B		82
C	JMP LOOP	4C
D		E6
E		FF
F		--
FO		--
1		--
.		.
.		.
.		.
.		.
C		F0
D		FF
E		--
F		F8

Fig. 11. Program to test hardware, using the BMPS. Note: In FFE6, X = 0, 1, or 2, depending on which register is to be examined.

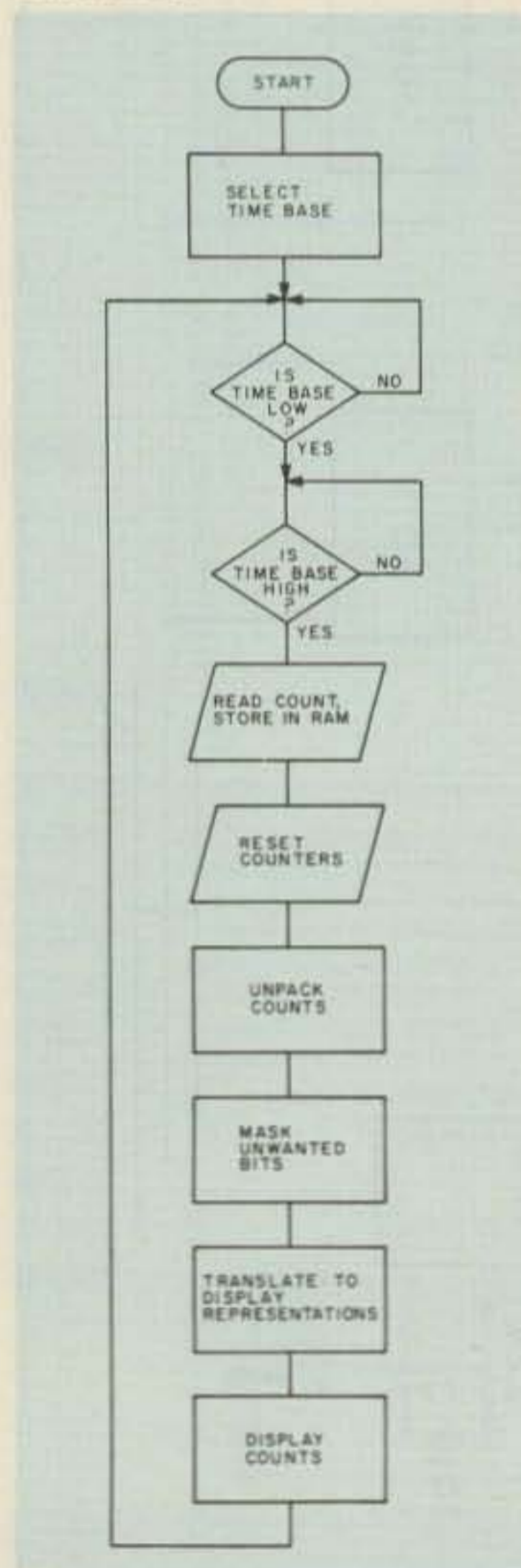

Fig. 12. Method to capture, process, and display counts.

### A Counter Program

At this point, the hardware is complete and checked out. We can select the frequency of the timebase, read the outputs of the counters, and reset the counters. We'll now examine a program which will perform these functions in the proper sequence to produce a useful counter. A block diagram is shown in Fig. 12.

The first step is selection of a timebase. Nothing of significance happens then until the output of the timebase is first low (counters counting) and then high (counters not counting). We then read and reset the counters. Once this happens, we have in memory three eight-bit numbers which represent the counts that were accumulated by the six counters. Each eight-bit number consists of a pair of BCD numbers "side by side." Accordingly, the next order of business is to "unpack" the numbers so that each BCD number is in

the four lower-order bits of its own individual location in memory. We then reset to 0 the four higher-order bits (unused) of each word, translate the BCD numbers into the correct representations for the digital display, and display the results. The entire process is then repeated.

A program which will do what we've been talking about is shown in Fig. 13. It's written for the BMPS, but since I/O address assignments are given, modifying it for any 6502 system should be no problem.

The operator must load into location FFFF the number which represents the desired timebase. (Only the three lower-order bits are used.) The instructions which lie between FF80 and FF8F read the number in location FFFF, store it in the 4042 latch (thus selecting the timebase) and delay further execution of the program until the timebase has gone low and then high.

When the timebase has gone high, a count has been accumulated and the counters have stopped counting. Accordingly, the instructions which lie between FF90 and FF9C read the counters, store the results in locations 0002, 0001 and 0000, and reset the counters in anticipation of the next count. At this point, the counts are stored as shown in Fig. 14(a), and they must be transformed for display as shown in Fig. 14(b).

The first step in the process is to unpack the BCD digits. The instructions which lie between FFA0 and FFB5 accomplish this. The XR and YR are each set to 0. A 0000-based, YR-indexed LDA and a 0003-based, XR-indexed STA are then performed. The contents of the ACR are shifted right four places, the XR is increment-

ed, and a 0003-based, XR-indexed STA is performed. At this point, the least-significant count (in the form of a BCD number between 0 and 9) occupies the four less-significant bits of location 0003. The next more-significant count occupies a similar position in location 0004. Of course, the next more-significant count also occupies the four more higher bits of location 0003 as well, but this is of no consequence. After three traverses of the loop, the counts occupy the locations which are shown in Fig. 14(c).

The instructions which lie between FFB9 and FFCE accomplish what remains: to display the counts. The XR is set to 5 in order to process six counts. An 0003-based, XR-indexed LDA is accomplished, and 0F is ANDed with the contents of the ACR. This sets the four more-significant bits of the number to 0, so that only the desired count remains. The next instruction, TAY, transfers the count to the YR. An FFD0-based, YR-indexed LDA is performed. Since the seven-segment representations of the numbers from 0-9 are stored starting at location FFD0, this places the representation of the count in the ACR.

The final step is to store the representation in the appropriate display element. Since the addresses of the display elements don't fall in the same order as the addresses of the source locations, we use a somewhat roundabout method to accomplish this. An FFDA-based, XR-indexed LDY is performed. This places in the YR the least-significant hexadecimal digit of the address of the appropriate display element. Performing an 8000-based, YR-indexed STA then accomplishes what we desire.

Fig. 13. Program to implement counter. Note: In FFF0, X = 3, 4, 5, 6, 7, or 8, depending on which register is to be examined. In FFFF, X = 1, 2, 3, 4, 5, 6, or 7, depending on which timebase is to be used.

Location	Instruction	Contents
FF80	LDA FFFF	AD
1		FF
2		FF
3	STA 4007	8D
4		07
5		40
6	LOOK1 LDA 4005	AD
7		05
8		40
9	BMI LOOK1	30
A		FB
B	LOOK2 LDA 4005	AD
C		05
D		40
E	BPL LOOK2	10
F		FB
90	LDX #2	A2
1		02
2	FETCH LDA 4002,X	BD
3		02
4		40
5	STA 0000,X	95
6		00
7	DEX	CA
8	BPL FETCH	10
9		F8
A	STA 4006	8D
B		06
C		40
D	NOP	EA
E	NOP	EA
F	NOP	EA
A0	LDY #0	A0
1		00
2	LDX #0	A2
3		00
4	LOOP1 LDA 0000,Y	B9
5		00
6		00
7	STA 0003,X	95
8		03
9	INX	E8
A	LSR	4A
B	LSR	4A
C	LSR	4A
D	LSR	4A
E	STA 0003, X	95
F		03
B0	INX	E8
1	INY	C8
2	CPY #3	C0
3		03
4	BNE LOOP1	D0
5		EE
6	NOP	EA
7	NOP	EA
8	NOP	EA
9	LDX #5	A2
A		05
B	LOOP2 LDA 0003,X	B5
C		03
D	AND #F	29
E		0F
F	TAY	A8
C0	LDA REPS,Y	B9

1		D0
2		FF
3	LDY DISPS,X	BC
4		DA
5		FF
6	STA 8000,Y	99
7		00
8		80
9	DEX	CA
A	BPL LOOP2	10
B		EF
C	SEC	38
D	BCS LOOK1	B0
E		B7
F		--
D0	REPS	24
1		77
2		1C
3		15
4		47
5		85
6		84
7		37
8		04
9		07
A	DISPS	06
B		05
C		01
D		02
E		03
F		04
FFF0	LDA 000X	AD
1		0X
2		00
3	STA 8200	8D
4		00
5		82
6	JMP FF86	4C
7		86
8		FF
9		--
A		--
B		--
C		80
D		FF
E		--
F		FX

Location	Type	Contents
0000	memory	counts 1,2
0001	memory	counts 3,4
0002	memory	counts 5,6
0003	memory	count 1
0004	memory	count 2
0005	memory	count 3
0006	memory	count 4
0007	memory	count 5
0008	memory	count 6
4002	input port	counts 1,2
4003	input port	counts 3,4
4004	input port	counts 5,6
4005	input port	control bits
4006	output port	reset
4007	output port	timebase
8001	output port (display)	count 3
8002	output port (display)	count 4
8003	output port (display)	count 5
8004	output port (display)	count 6
8005	output port (display)	count 1
8006	output port (display)	count 2

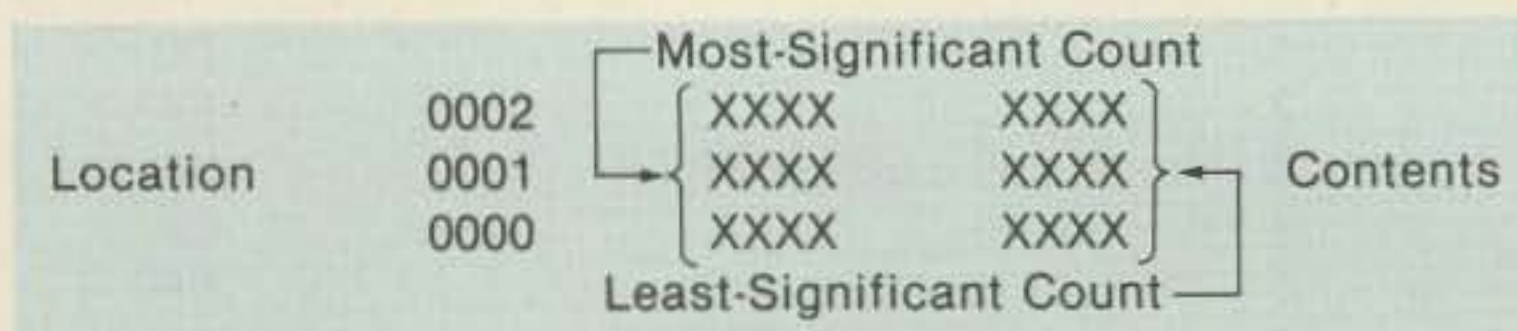

Fig. 14(a). Location of counts in memory.

Location	Contents
8004	Most-Significant Count
8003	.
8002	.
8001	.
8006	.
8005	Least-Significant Count

Fig. 14(b). Destination of counts.

Traversing the loop six times stores all six counts.

The remaining instructions (CLC, BCC) cause the program to branch to location FF86, and the process starts again. To change the timebase requires a reset.

The NOP instructions which are located in FF9D-FF9F and FFB6-FFB8 serve no useful purpose and may be omitted. (Change the operand of the BRANCH instruction at FFCD, if done.) However, if either set is replaced with JMP FFF0, the short program which starts at FFF0 will store a selected pair of counts into the output port which is located at 8200. This is convenient when checking out the program.

Finally, if measurements of period rather than frequency are to be made, ASL instructions should be inserted between LOOK1 LDA 4005 and BMI LOOK1, and between LOOK2 LDA 4005 and BPL LOOK2, so that the proper bit is examined. Then, too, BMI LOOK1 should be changed to BPL LOOK1, changed to BMI LOOK2, to take into account the difference in the way the bits must be interpreted.

### Doing It the Easy Way

The counter which we've just discussed is a useful and versatile addition to almost any system. However, if we can tolerate a

Location	Counts
0008	- 6
0007	6 5
0006	- 4
0005	4 3
0004	- 2
0003	2 1

Fig. 14(c). Location of counts after unpacking.

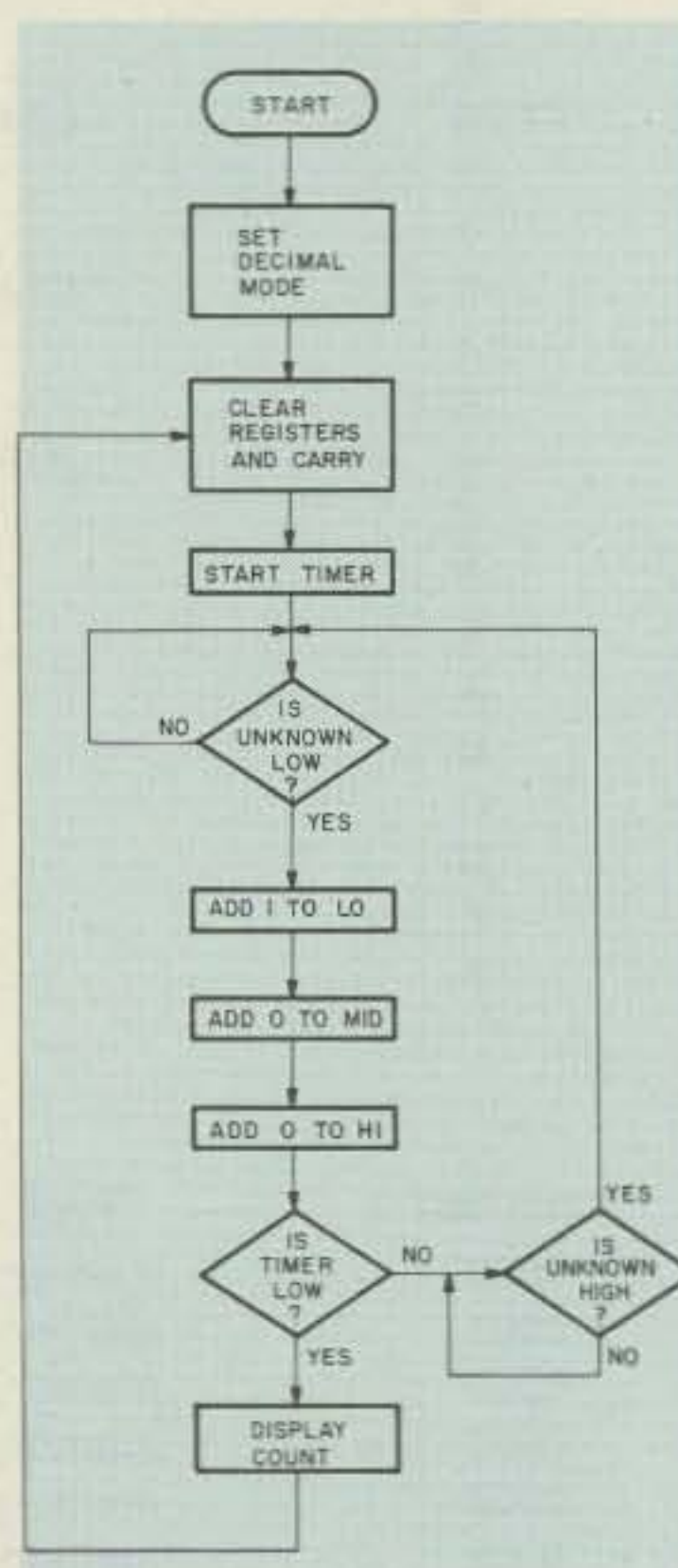

Fig. 15. Software implementation of counter function.

limitation in speed, then we can have a counter just by using the system itself, provided it has a timer and a digital display. We can write a program to simulate the action of a counter. The basic principle involves using the timer as a timebase and counting

Location	Instruction	Contents
FF80	SED	F8
1	START CLC	18
2	LDX #2	A2
3		02
4	LDA #0	A9
5		00
6	LOOP1 STA 0000,X	95
7		00
8	DEX	CA
9	BPL LOOP1	10
A		FB
B	STA 8100	8D
C		00
D		81
E	LOOP2 LDA 9000	AD
F		00
90		90
1	BMI LOOP2	30
2		FB
3	LDA #1	A9
4		01
5	ADC 0000	65
6		00
7	STA 0000	85
8		00
9	LDA #0	A9
A		00
B	ADC 0001	65
C		01
D	STA 0001	85
E		01
F	LDA #0	A9
A0		00
1	ADC 0002	65
2		02
3	STA 0002	85
4		02
5	LDA A000	AD
6		00
7		A0
8	BPL AHEAD	10
9		08
A	LOOP3 LDA 9000	AD
B		00
C	BPL LOOP3	10
D		FB
E	JMP LOOP2	4C
F		4C
FFB0		8E
1		FF
2	AHEAD LDA 000X	A5
3		02
4	STA 8200	8D
5		00
6		82
7	JMP START	4C
8		81
9		FF

Fig. 16. Program to implement a counter in software. Note: In FFB2, X = 0, 1, or 2, depending on which register is to be examined.

the number of high-to-low (or low-to-high) transitions which the unknown waveform makes while the timer is "on." What's involved in the context of the BMPS is shown in Fig. 15. Using the

technique with other systems should be straightforward.

The first step is to set the 6502  $\mu$ P to the decimal mode. This means that in any operation which in-

volves an ADC or SBC instruction, the  $\mu$ P treats the eight-bit numbers which are involved as pairs of BCD digits. The next step is to clear the carry bit and three locations (registers) in the RAM. We designate the locations as LO, MID, and HI to indicate which pair of counts each holds.

We begin counting by starting the timer. We then check to see if the unknown waveform is low. If so, we add 1 to LO, 0 to MID, and 0 to HI. (Adding 0 to a number adds the carry, if any, from the next less-significant count.) If the output of the timer is still high by this time, we wait until the unknown waveform goes high and then low, and again modify the registers as appropriate. The process is repeated again and again until the output of the timer goes low. At that time, we process the counts in exactly

the same way as if they had come from the counter board.

Only a few connections to the BMPS are necessary in order to implement the counter. The WRITE pulse for the output port at location 8100 is used to start the timer, while the most-significant bit of the input port at location A000 is used to monitor the output of the timer. The unknown waveform is tied to the most-significant bit of the input port at location 9000.

A program which will provide the function of a counter is shown in Fig. 16. Little comment is necessary, since it closely follows the flowchart.

The instructions which lie between FF80 and FFB1 in this program perform essentially the same function as the instructions which lie between FF86 and FF9C in the previous program. In each case, the

counts are stored in locations 0000, 0001, and 0002. Thus, the portion of the previous program which processes and displays the counts clearly should be usable with this program, although I've not tried it. The instructions which lie between FFB2 and FFB9 in the present program provide a simple way to examine the contents of any of the registers. All that's necessary is to monitor the output port at location 8200.

Once we've implemented the counter in this way, all we need do further is to adjust the period of the timer until it's some convenient value, such as 1 second.

The price we pay for doing it the easy way—substituting software for hardware—is a loss of speed. In this case, the time between low-to-high transitions of the unknown

waveform must be longer than the time which is required for the  $\mu$ P to traverse the inner loop of the program. This means that the frequency of the unknown waveform must be less than a few kilohertz.

### A Preamplifier

Either counter is directly usable as is on CMOS-compatible signals. Those who will use the counter on other types of signals should add a signal-conditioning preamplifier of the sort shown in Reference 2 (substitute a 4049 CMOS hex inverter for the 7404, for example). There is room at the upper left corner of the PC board to do this. ■

### References

1. Creason, *How to Build a Microcomputer*, 73, Inc., 1979.
2. Moraller, "Latest K2OAW Counter Update, 73 Magazine, May, 1975.

# DEALER DIRECTORY

## Fontana CA

We carry the following: ICOM, Midland, Amcom, DenTron, KLM, Swan, Drake, Ten-Tec, Wilson, SST, MFJ, Hy-Gain, Lunar, Nye-Viking, B&W, Redi-kilowatt, CushCraft, Mosley, Big Signal, Pipo, etc. Full Service Store **Fontana Electronics, 8628 Sierra Ave., Fontana CA 92335, 822-7710.**

## San Jose CA

Bay area's newest Amateur Radio store. New & used Amateur Radio sales & service. We feature Kenwood, ICOM, Wilson, Yaesu, Atlas, Ten-Tec, VHF Engineering & many more. **Hobby-Tronics, 1378 So. Bascom Ave., San Jose CA 95128, 293-6268.**

## Denver CO

Experimenter's paradise! Electronic and mechanical components for computer people, audio people, hams, robot builders, experimenters. Open six days a week. **Gateway Electronics Corp., 2839 W. 44th Ave., Denver CO 80211, 458-5444.**

## New Castle DE

ICOM, Ten-Tec, Swan, KDK, NDI, Tempo, Wilson; Authorized dealer: 1 mile off I-95. No sales tax. **Delaware Amateur Supply, 71 Meadow Rd., New Castle DE 19720, 328-7728.**

## Columbus GA

### KENWOOD—YAESU—DRAKE

The world's most fantastic amateur showroom! You gotta see it to believe it! **Radio Wholesale, 2012 Auburn Avenue, Columbus GA 31906, 561-7000.**

## Preston ID

Ross WB7BYZ, has the Largest Stock of Amateur Gear in the Intermountain West and the Best Prices. Call me for all your ham needs. **Ross Distributing, 78 So. State, Preston ID 83263, 852-0830.**

## Terre Haute IN

Your ham headquarters located in the heart of the Midwest. **Hoosier Electronics, Inc., 43B Meadows Shopping Center, P.O. Box 2001, Terre Haute IN 47802, 238-1456.**

## Littleton MA

The ham store of N.E. you can rely on. Kenwood, ICOM, Wilson, Yaesu, DenTron, KLM amps, B&W switches & wattmeters, Whistler radar detectors, Bearcat, Regency, antennas by Larsen, Wilson, Hustler, GAM. **TEL-COM Inc. Communications & Electronics, 675 Great Rd., Rt. 119, Littleton MA 01460, 486-3040.**

## Laurel MD

We stock Drake, Icom, Ten-Tec, Swan, Tempo, Dentron, DSI, KDK, Wilson, Midland and others. Call toll free 800-638-4486. **The Comm Center, Inc., Laurel Plaza, Rte. 198, Laurel MD 20810.**

## St. Louis MO

Experimenter's paradise! Electronic and mechanical components for computer people, audio people, hams, robot builders, experimenters. Open six days a week. **Gateway Electronics Corp., 8123-25 Page Blvd., St. Louis MO 63130, 427-6116.**

## Camden NJ

X-Band (& other frequencies) Microwave Components & Equipment. Laboratory Grade Test Instruments, Power Supplies, 1000's in stock at all times, BUY & SELL all popular makes—HP, GR, FXR, ESI, Sorensen, Singer, etc. **Lectronic Research Labs, 1423 Ferry Ave., Camden NJ 08104, 541-4200.**

## North Arlington NJ

Collins, General Radio, Tektronix, Hewlett Packard. Radio sales/service. Cash or trade for tubes or gear. **Ted W2KUW, DCO, INC., 10 Schuyler Avenue, No. Arlington NJ 07032 998-4246.**

## Syracuse—Central NY

We deal, we trade, we discount, we please! Yaesu, Ten-Tec, Cushcraft, Drake, Dentron, KLM, Midland, B&W, ICOM, Hygain, Swan, Amcom, Telco, Mirage, DSI etc. Complete 2-way service shop! **Ham-Bone Radio (Div. Stereo Repair Shop) 3206 Erie Blvd. East, Syracuse NY 13214, 446-2266.**

## Syracuse-Rome-Utica NY

Featuring: Yaesu, ICOM, Drake, Atlas, DenTron, Ten-Tec, Swan, Tempo, KLM, Hy-Gain, Mosley, Wilson, Larsen, Midland Southwest Technical Products. You won't be disappointed with equipment/service. **Radio World, Oneida County Airport-Terminal Building, Oriskany NY 13424, 337-2622.**

## Phila. PA/Camden NJ

Waveguide & coaxial microwave components & equipment. Laboratory grade test instruments, power supplies. Buy, sell & trade all popular makes, HP, GR, FXR, ESI, Sorensen, Singer, etc. **Lectronic Research Labs., 1423 Ferry Ave., Camden NJ 08104, 541-4200.**

## Scranton PA

ICOM, Bird, CushCraft, VHF Engineering, Antenna Specialists, Barker & Williamson, CDE Rotators, Ham-Keys, Belden, W2AU/W2VS, Shure, Regency, CES Touch-Tone pads, Radio Amateur Callbooks. **LaRue Electronics, 1112 Grandview St., Scranton PA 18509, 343-2124.**

## Houston TX

Experimenter's paradise! Electronic and mechanical components for computer people, audio people, hams, robot builders, experimenters. Open six days a week. **Gateway Electronics Inc., 8932 Clarkcrest, Houston TX 77063, 978-6575.**

## San Antonio TX

Complete 2 way service shop. Call Dee, W5FSP. Selling Atlas, Avanti, Bird, Black Cat, Cushcraft, Hustler, ICOM, KDK, Kenwood, MFJ, Nye, Palomar, Shure, Swan, Tempo, Yaesu and others. **Appliance & Equipment Co., Inc., 2317 Vance Jackson Road, San Antonio TX 78213, 734-7793.**

## Port Angeles WA

Mobile RFI shielding for elimination of ignition and alternator noises. Bonding straps. Components for "do-it-yourself" projects. Plenty of free advice. **Estes Engineering, 930 Marine Drive, Port Angeles WA 98362, 457-0904.**

## DEALERS

*Your company name and message can contain up to 25 words for as little as \$150 yearly (prepaid), or \$15 per month (prepaid quarterly). No mention of mail-order business or area code permitted. Directory text and payment must reach us 45 days in advance of publication. For example, advertising for the February issue must be in our hands by December 15th. Mail to 73 Magazine, Peterborough NH 03458. ATTN: Aline Coutu.*

## DELUXE MESSAGE MEMORY KEYS

**"BRAND NEW"**  
**\$89.95**



### Features: Model TE-284

- State-of-the-Art CMOS Circuitry
- Three choices of Message Storage
  - A. Two (50 character each) message storage
  - B. Four (25 character each) message storage
  - C. One 50 character and two 25 character message storage
- Records at any speed—plays at any speed
- Memory operating LED
- Use for daily QSO or contests

### PLUS:

- Self-completing dots and dashes
- Both dot and dash memory
- Iambic Keying with any squeeze paddle
- 5-50 w.p.m.
- Speed, volume, tone, tune and weight controls
- Sidetone and speaker
- Low current drain CMOS battery operation—portable
- Deluxe quarter-inch jacks for keying and output
- Keys grid block and solid state rigs
- WIRED AND TESTED FULLY GUARANTEED—LESS BATTERY

## MESSAGE MEMORY KEYS



### Features:

- Advanced CMOS message memory
- Two (50 char. each) message storage
- Repeat function
- Records at any speed—plays back at any speed
- Longer message capacity  
Example: send CQ CQ CQ DX de WB2YJM WB2YJM K—then play second message on contact—de WB2YJM QSL NY NY 579 579 Paul Paul K
- Use for daily QSOs or contests

### Model # TE201

**\$69.95**

### PLUS:

- State-of-the-art CMOS keyer
- Self completing dots and dashes
- Both dot and dash memory
- Iambic keying with any squeeze paddle
- 5-50 wpm
- Speed, volume, tone, tune and weight controls
- Sidetone and speaker
- Low current drain CMOS battery operation—portable
- Deluxe quarter-inch jacks for keying and output
- Keys grid block and solid state rigs
- WIRED AND TESTED FULLY GUARANTEED—LESS BATTERY

**"BRAND NEW"**



**Model # TE144**  
**59.95**

### Features: Deluxe CMOS Electronic Keyer

- State-of-the-art CMOS circuitry
- Self completing dots and dashes
- Both dot and dash memory
- IAMBIC keying with any squeeze paddle
- 5-50 wpm

- Speed, weight, tone, volume tune controls & sidetone and speaker
- Semi-automatic "bug" operation & straight keying—rear panel switch
- Low current drain CMOS battery operation—portable
- Deluxe quarter inch jacks for keying and output
- Keys grid block and solid state rigs
- Wired and tested—fully guaranteed—less battery



### Model # TE133

**\$49.95**

### Features CMOS ELECTRONIC KEYS

- State-of-the-art-CMOS circuitry
- Self completing dots and dashes
- Dot and dash memory
- Iambic keying with any squeeze paddle
- 5-50 WPM
- Speed, volume, tone, weight & tune controls, sidetone and speaker
- Low current drain CMOS battery operation
- Deluxe quarter inch jacks for keying and output
- Handsome eggshell white base—woodgrain top
- Compact and portable 1-7/8 x 4-1/4 x 6-1/4
- Grid block & solid state keying
- Wired and tested—fully guaranteed—less battery

MODEL TE122—same as TE133 less wgt, tune, solid state keying \$36.50

AT YOUR DEALER OR SEND CHECK OR MONEY ORDER.

(plus \$2.00 s/h NY res add tax)

**TRAC**

**ELECTRONICS, INC**  
**1106 RAND BLDG.**  
**BUFFALO NY 14203**

✓ T18

# CLOSE OUT KIM BUS 8K RAM

The famous HDE 8K RAM now on sale at the incredible price of \$155.00—quantity one. Two or more—\$150.00. Hurry while supply lasts.

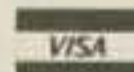

P.O. Box 1712, Auburn AL 36830

Call Toll Free 1-800-633-8724

regular phone number (205) 745-7735

✓ L25

## AMCT-80

Automatic Morse Code Teacher for the TRS-80

This is the only morse code program available that will automatically speed up or slow down depending on your proficiency to receive code. Will send in single or group character mode. Written in machine language. Specify Level 1 or Level 2 and memory size.

AMCT-80 on cassette \$14.95

Send for TRS-80 catalog.

**COST EFFECTIVE  
COMPUTER SERVICES**

728 S. 10th St., Suite #2  
Grand Junction, CO 81501

(303) 243-3629 ✓ C124

New **SATELLITE**  
For the TV home.



Supersharp Reception—Color Like Never Before

Get over 50 channels of television directly from the satellite! HBO, Showtime, the Superstations, and sports from around the world!

Works Anywhere!

Buy complete or build and save. Our book tells everything! Send \$7.95 today or call our 24 hr. C.O.D. Hotline!

(305) 869-4283

SPACECOAST RESEARCH ✓ S117

P.O. Box 442, Dept. G, Altamonte Springs, FL 32701

# YOURS FREE!!

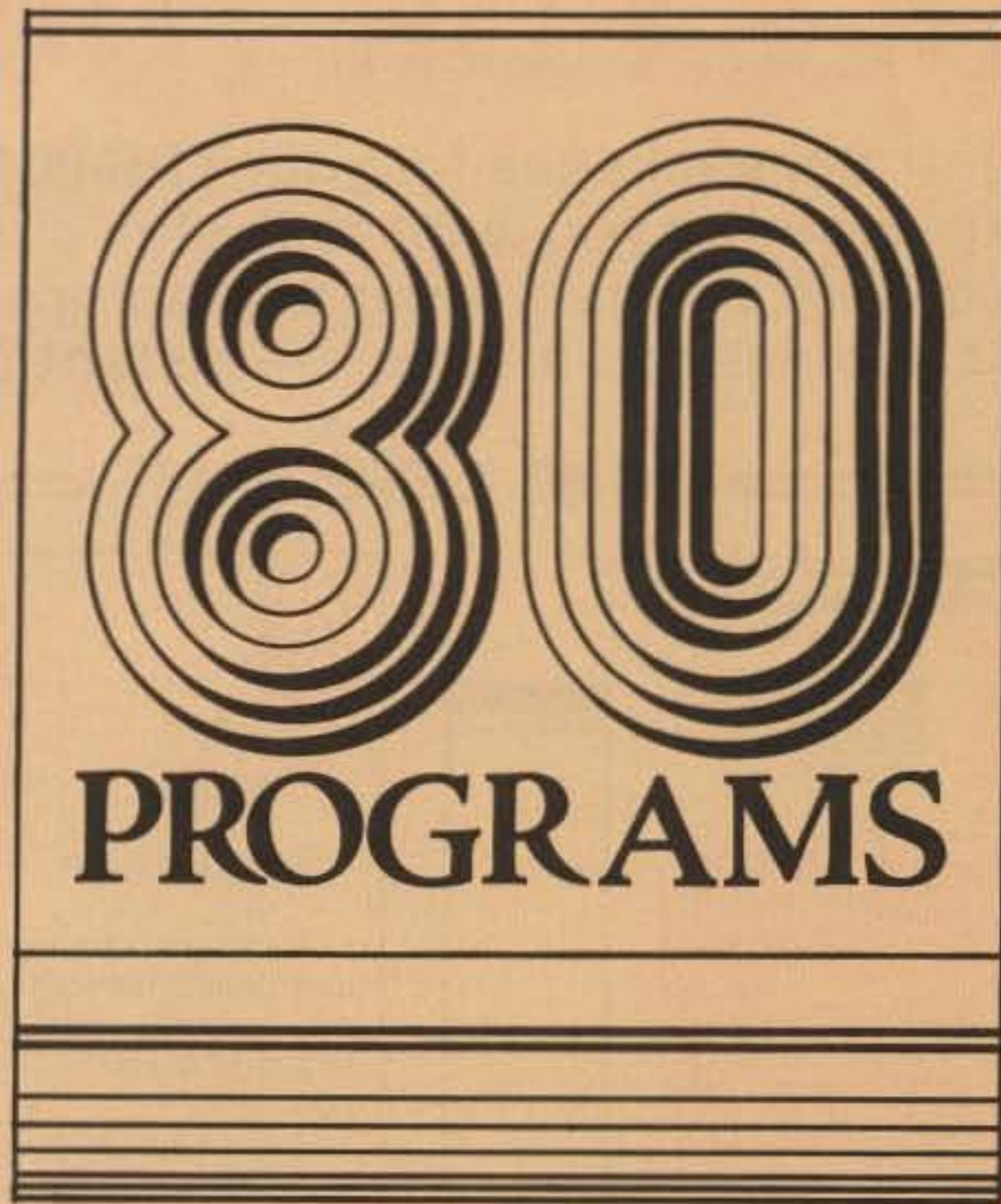

## A GIANT BOOK OF 80 PROGRAMS FOR THE TRS-80\* AS A FREE GIFT WITH YOUR CHARTER SUBSCRIPTION TO 80 MICROCOMPUTING, AN ALL NEW MICROCOMPUTER MAGAZINE FOR THE TRS-80 OWNER AND USER

That's right. You can receive a giant book of programs for your TRS-80 and have the distinction of being a charter subscriber to the largest magazine published on the TRS-80.

80 MICROCOMPUTING contains a wealth of information on business, personal and educational software. New product reviews are featured each month, along with new applications for everything from text editing to music.

Subscribe today and take advantage of this super charter subscription offer . . . 12 months of 80 MICROCOMPUTING for \$12 . . . (that's half the newsstand price)! Plus, if you subscribe now, we will send you FREE OF CHARGE a giant book of 80 PROGRAMS for your TRS-80.

\*(TRS-80 is a trademark of the Tandy Corporation.)

**YES! SIGN ME UP AS A  
CHARTER SUBSCRIBER TO  
80 MICROCOMPUTING FOR  
JUST \$1.00 PER COPY, AND  
SEND MY FREE COPY OF 80  
PROGRAMS WHEN YOU  
RECEIVE MY PAYMENT.**

12 issues—\$12 (save \$12)     36 issues—\$36 (save \$36)

Payment enclosed     Please bill me

Bill my  Visa     Master Charge     American Express

Card # \_\_\_\_\_ Exp. date \_\_\_\_\_

Name \_\_\_\_\_ Signature \_\_\_\_\_

Street \_\_\_\_\_

City \_\_\_\_\_ State \_\_\_\_\_ Zip \_\_\_\_\_

Mail to:  
80 MICROCOMPUTING  
POB 981  
Farmingdale NY 11737

59DK33

Canada: \$12 per year US funds. Add \$2 per year for Canadian dollars. All other foreign subscriptions: \$20 one year only, payable in US currency.



# TOOLS FOR YOUR WORKBENCH

That's right! Six packages for your TRS-80\* which will do something. Whether you want to design circuits, program more effectively, create computer graphics, or provide for your other hobbies and interests—Instant Software has it all.

## TRX-80\* LEVEL II 16K



### Ham Package I

Ham Package I—We had to call it something, but this package is not only for hams. It's great for any experimenter or technician in need of a dynamic reference of popular electronics formulas:

- Ohm's Law**—Easily performs calculations involving voltage, current, resistance, and power.
- Series and Parallel Calculations**—Find the value for capacitors or resistors in parallel or series circuits.
- Voltage Dropping and Voltage Dividing**—This will give you the value of a dropping resistor and the effective resistance of the load.
- R/C Time Constants**—This section will calculate the resistance, capacitance, or the time delay of an R/C circuit.
- Dipole Antennas and Yagi Antennas**—These two programs will compute the dimensions of an antenna to your exact frequency and give you an on-screen display—complete with all measurements! Order No. 0007R \$7.95.

### Electronics I

If you're still designing circuits the old-fashioned way, let the Electronics I package introduce the latest way to go:

- Tuned Circuits & Coil Winding**—Design tuned circuits for audio and radio frequencies. This two-part program will find the two missing values from any two of the following: frequency, capacitance, inductance, or reactance. The coil-winding section will calculate the number of turns and wire gauge required for a close-wound, air-, or slug-tuned coil from the inductance, diameter, length, and permeability of the coil.
- 555 Timer Circuits**—Timers, both monostable (one-shot) and astable (oscillator), can be easily designed with this two-part program. The program will also draw a complete schematic on the screen of your TRS-80.
- LM 381 Pre-Amp Design**—You too can quickly design an IC preamp. With this program all you need to do is enter the parameters of the performance you want, and the program does the rest—right down to drawing a detailed schematic of your circuit on the screen! Order No. 0008R \$7.95.

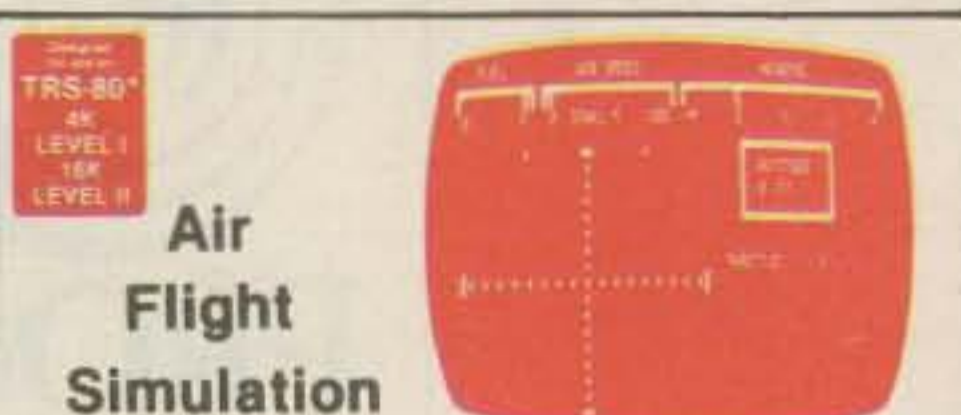

Air Flight Simulation might be more like it! Instrument takeoffs and landings are no picnic—ask any pilot—and this computer simulation is certain to keep you on the edge of your seat.

You begin with a full tank of gas and a flight plan that calls for a simple takeoff and landing—at least until you get the hang of it. Pay close attention to your instrument panel, especially the angle of ascent/bank indicator and air speed indicator—too steep a bank and your air speed will drop like a stone... and so will your plane.

It's about as close to the real thing as you can get this side of a runway; and once you get some flight time under your belt, the sky's the limit. You can use the program to fly a course against a map—even try your hand at acrobatic maneuvers! Fun for the whole family. Order No. 0017R \$7.95.



### TRS-80 Utility II

The second in a series of programs designed to help the programmer, Utility II will add unprecedented flexibility to your BASIC programs, by allowing you to combine them with other BASIC programs or with machine-language programs or routines.

- CFETCH**—After you have renumbered your programs using RENUM (see Utility I), you can use the CFETCH program to merge your consecutively numbered BASIC programs. CFETCH also allows you to search a program for its file name without merging it with the resident BASIC program.
- CWRITE**—This powerful program allows you to merge one or more machine-language programs with other machine-language programs or with a BASIC program. Merged programs can then be loaded with a single command. CWRITE also makes it possible for you to obtain a general checksum (impossible to do when CLOADing a BASIC program) and allows you to load programs in non-consecutive locations within the memory. Order No. 0076R \$7.95.

### Doodles and Displays II

- Doodle Pad**—The keyboard of your TRS-80 becomes a palette that lets you create your own masterpieces on the screen and store them on cassette for future unveiling.
- Math Curves**—Your computer will put more life into your child's geometry lessons as it plots and displays curves produced by six commonly used geometric formulas.
- Random Pattern Display**—Here's a program that lets your TRS-80 do the drawing all on its own. Those with itchy fingers can tamper with the program to produce a variety of visual effects.
- Symmetrics**—Remember the kaleidoscope you played with as a child? Symmetrics brings those same hypnotic patterns to the screen of your TRS-80.
- Drawing**—With almost 40 user commands that give you virtually limitless control over the display, Drawing is about the finest program for computer art available today. The program also provides for storing up to five drawings in memory or on cassette for future revision or use.
- Rug Patterns**—Whether you're a craftsman looking for some unusual patterns for rugs, afghans, tablecloths, or blankets—or just the sort who likes to sit back and be entertained—this never-ending stream of unusual patterns is sure to spark your imagination. Order No. 0042R \$7.95.



### Model Rocket Analyzer and Pre-Flight Check

Man does not live by computing alone. Maybe that's why adventuresome people everywhere are making model rocketry one of America's fastest-growing hobbies. If you're into model rocketry, check out this list of features, and see how Instant Software and your computer can put a little more zip into your other hobby.

- Model Rocket Flight History Prediction**—This handy program will compute the flight characteristics and performance for virtually any model rocket. Preprogrammed engine and body tube data covers Estes, Centuri, Flight Systems, A.V.I., Astroport, C.M.R., and Kopter products. If you prefer to build and fly rockets of your own design, the program will also utilize information supplied by you to estimate the performance of your individual creation.
- Weather Forecaster**—Before you launch your rocket, you'll need an accurate, up-to-the-minute forecast of weather conditions in your area. With Weather Forecaster, just enter your present location, your region's average temperatures for the months of July and January, and the current barometric pressure. Your TRS-80 will then compute the weather conditions for your area. Order No. 0024R \$7.95.



## Operation Santa!

— spread holiday cheer with this  
super club project

Photos by K8ZIS and W8WN



Photo A. Even without the red suit and long, white beard, Dave W8IFK looks and sounds like Santa.

"Santa's on television and wants to talk to you!"

How could that be? Well, once again old Santa made an appearance for the kids at McLaren Hospital in Flint, Michigan, to try to cheer up those who would be confined to the hospital over the holidays. Nothing unusual about that? This electronic Santa came to them via radio, color television, and (it is reported, perhaps with some imagination) via a multiple relay of stations all the way from the North Pole.

Santa has been coming to hospitals for many, many years, and amateurs have been able to let the kids in other hospitals talk to Santa "way off at the North Pole" via amateur radio for more years than most of us can remember. But a year ago, McLaren Hospital, in Flint, apparently was one of the first hospitals in the nation to go one step further. It initiated the practice of having Santa also appear on the in-house color TV system so that the kids (and

anyone else in the hospital who wished to tune in) could not only hear the old gent, but also could see him in living color as he replied to their questions and requests.

"Operation Santa" for 1978 began as WD8KQI (Dr. Dan Bonbrisco, D.O.) and a couple of other members of the Genesee County Amateur Radio Emergency Service let the kids at the Flint Osteopathic Hospital talk with Santa via the 147.87/.27 Flint Hainer repeater. Meanwhile, Santa, also known as W8IFK, was across the street at McLaren Hospital trying to talk with the kids and get into his Santa suit at the same time.

After everyone in the pediatric ward at FOH had talked with the resident of the North Pole, the telephone operator at McLaren announced over the PA system that Santa would be on a certain TV channel in a few minutes to talk to the children there. Color bars were punched up, amateurs and hospital technicians made sure the TV sets in the pediatric sections were

tuned and working properly, and all the children who could walk or be moved were taken to the sun rooms.

When all was ready, W8UPV put out a call over the Hainer repeater for Santa Claus. He didn't get him, but he did get another amateur "near Greenland" who said he could relay the traffic. Two more relays, including one "from an amateur at a DEW line radar post," got them close to the North Pole, but Santa didn't seem to be available. An auto-patch, though, brought an answer from Santa's private secretary, who said that Santa was in his workshop but would be arriving momentarily. Meanwhile, slides of various operators at their shacks, the OSCAR satellites, etc., were being shown on the TV screen.

The screen suddenly went to color bars again (to allow the camera to be pivoted 180° in a very crowded photographic studio there in the hospital), and then came alive and focused on a large chair in front of a deep blue background just as a jolly, white-haired fellow, carrying a TR-22 and an extra mike, came in and sat down. Santa had arrived, and he said he wanted to talk with boys and girls in the hospital there in Flint, Michigan!

After a few minutes of getting himself composed, while describing the work he had been doing in the workshop, Santa asked to talk to the first little boy. But before the first one had even said anything over the mike of the HT down in the sun room, Santa had already called him by name and said he was sorry he had to be in the hospital; he even named the exact illness the boy had!

This was very mystifying—how could Santa

know who was going to talk first? The same thing happened with all the other children—Santa knew names, illnesses, ages, and sometimes other facts about each one of them. One little boy became very excited. It seems that he had talked with "Santa" in one of the stores a couple of weeks earlier and had given him his name. "He remembered me!" the boy shouted, causing a great deal of merriment among the hams and nurses.

Since the children were busy watching the child who was talking and watching the TV screen to see Santa as he replied, most did not notice the other amateurs in the back of the room getting advance information on the next child and relaying it via .52 simplex to the photographic studio upstairs. Neither could they see the large chalkboard, just behind the TV camera, where names, ages, and illnesses were being written down (next to a permanent list of Santa's reindeer team, without which old Santa seemed to experience his one memory lapse).

Did you ever wonder just how Santa can listen to the requests kids make and give an answer that satisfies them without putting too much pressure on parents? This is a talent in itself. The requests run from the simplest, a doll, to the more expensive and elaborate, such as a real racing car or a diamond ring. Santa would laugh and compliment the child on his wanting reasonable things (if that were the case), or on how big his ideas were (for some of the more unreasonable ones). He would admonish them to be good, tell them that he would see what he could do, and that he thought he could find



Photo B. "Santa" (W8IFK) talks to the kids via his TR-22 and the in-house color TV system while WA8IUS mans the camera. Note the second mike cord going under Santa's beard.

something that they would like (while never saying that he would give them what they actually asked for).

Many children, of course, just wanted to get out of the hospital in time for Christmas. For these, Santa had especially kind words, also reminding them to follow the doctor's instructions. One teenage boy was especially depressed—he had just broken both legs while skiing. While his injuries were not really serious, it was a bleak holiday season for

that young fellow.

After talking with all the children in each of the sun rooms, the operators visited the rooms of the children who could not join the group. Invariably, they came upon nurses who were watching the TV screen but could not leave to see what was actually happening. Often they surprised the nurses with the opportunity to talk with Santa (much to the delight of Santa!), and he would then proceed to identify them and talk with them, also to the delight of the



Photo C. This is how Santa looked on the TV screen during a newscast which gave a little extra PR for amateur radio.

children, doctors, nurses and all who were watching.

After talking with all the children (and some of the nurses) in McLaren, as the TV operation was being closed down, Santa talked with the grandchildren of several amateurs who had been monitoring. A news photographer from one of the local TV stations had arrived and filmed the scene in one of the sun rooms, so "Santa" had to get set again while a little newsreel footage was filmed.

"Operation Santa" had been done several times in Flint in the past, but in 1977, K8ZIS, medical photographer at McLaren Hospital, suggested that it be put on the newly-installed in-house TV system. Apparently, two other hospitals in other parts of the country also had the same idea at about the same time, and this has

provided much pleasure for the children in those hospitals. But not only for the children—it has been noted that the adult patients, nurses, and doctors seem to enjoy watching the show as much as the kids themselves. It was not unusual to find sun rooms and wards all over the hospital crowded with patients, nurses, and interns watching their local "Operation Santa" on their own TV channel.

The Genesee County ARES provides emergency communications for the seven area hospitals as well as for a number of other groups. "Operation Santa" is hardly an emergency, but it is one of those little public service events that brings pleasure to someone else while improving our public relations. With the closed-circuit TV system, amateur radio is even more visible



Photo D. Santa's "memory" of the names of children was updated on this off-camera blackboard.

than ever.

Operators who took part in the 1978 "Operation Santa" in Flint were W8IFK (who makes a magnificent Santa, even without the bright red suit), K8ZIS (medical photographer at McLaren who originated the TV idea locally),

W8UPV, WD8JCN, WD8KQI, WA8IUS, K8XN, W8YCN, WD8LMP, WD8CCG, and WA8ZQM. The operation was sponsored by the Genesee County Amateur Radio Emergency Service, Inc., the Hainer Repeater Association, and McLaren Hospital. ■

X3

**MONITOR \$149, 12" B&W**

**Offer expires January 1st.**

**COMPLETE KEYBOARD TERMINAL \$375**  
Full Kit \$325 (includes SCT-100)

## Stand Alone Video Terminal

αβγδϵθϋμνπσφψωζηιθρσ τφχψ ωζηιθρσ τφχψ ωζηιθρσ τφχψ  
!"#\$%&'()\*+,-./012456789:;<=>?  
@ABCDEFGHIJKLMN OPQRSTUVWXYZ[\]^\_`  
~`abcdefghijklmnopqrstuvwxyz{|}~

### SCT-100 VIDEO BOARD FEATURES

- 64x16 line format with 128 displayable characters
- Serial ASCII or BAUDOT with multiple Baud rates
- \$197 Assembled or \$167 Kit (Partial Kit \$89)
- Full cursor control with scrolling and paging
- On board power supply
- Serial interface RS232 or current loop
- Purchase SCT-100 alone or complete terminal

**XITEX CORP** 8861 Charwell Drive  
Dallas, Texas 75242 (214) 949-2490

ORDER BY PHONE/Overseas orders & dealers welcome

### MRS100 FEATURES:

- Connects directly with any ASCII or Baudot Teletype®/Terminal
- Operates from 1 to 150 WPM with Auto-Sync.
- Displays WPM rate of copied signal plus FIFO buffer status.
- Contains a built-in 80 Hz bandpass filter and sidetone oscillator.

\$295 Assembled & Tested • \$225 Complete Kit • \$45 Partial Kit

### Xmas Special

Full Kit \$179.  
Assembled \$236.

### NEW FROM XITEX...ABM-100

**Universal Converter ASCII • Baudot • Morse**  
The ABM-100 is a universal code converter for translating between ASCII and Baudot, or between Morse and ASCII (or Baudot). Also used as a TTY® speed converter. Assembled and tested the ABM will operate from a single +5V supply and sells for \$129. Write for complete details .....

# WILSON SYSTEMS, INC. presents the SYSTEM 36

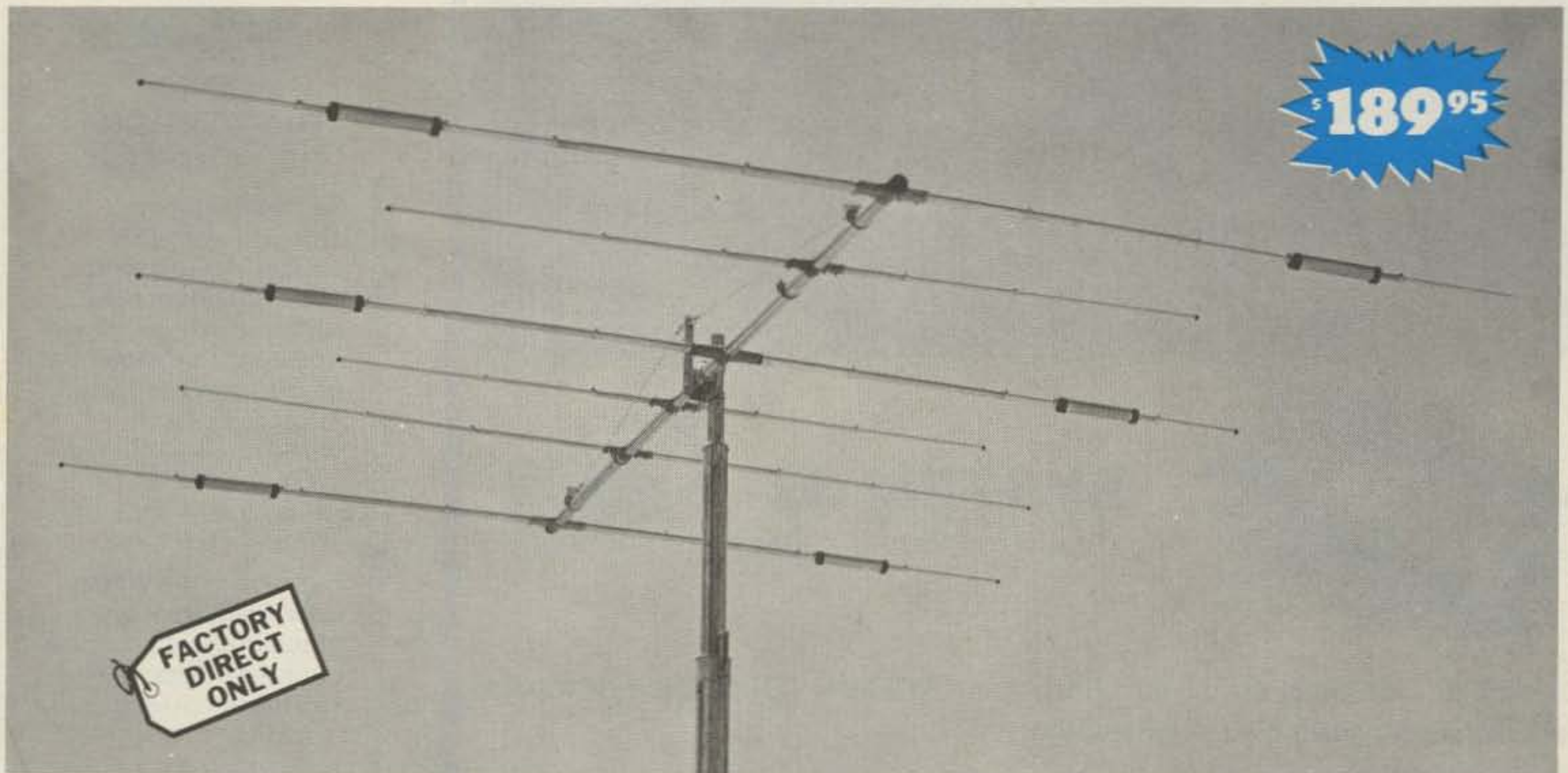

A trap loaded antenna that performs like a monobander! That's the characteristic of this six element three band beam. Through the use of wide spacing and interlacing of elements, the following is possible: three active elements on 20, three active elements on 15, and four active elements on 10 meters. No need to run separate coax feed lines for each band,

as the bandswitching is automatically made via the High-Q Wilson traps. Designed to handle the maximum legal power, the traps are capped at each end to provide a weather-proof seal against rain and dust. The special High-Q traps are the strongest available in the industry today.

## SPECIFICATIONS

Band MHz . . . . . 14-21-28  
Maximum power input, Legal limit  
Gain (dBd) . . . . . Up to 9 dB  
VSWR @ resonance . . . 1.3:1  
Impedance . . . . . 50  $\Omega$   
F/B ratio . . . . . 20 dB or better

Boom (O.D. x Length) . . 2" x 24'2 1/2"  
No. of elements . . . . . 6  
Longest element . . . . . 28'2 1/2"  
Turning radius . . . . . 18'6"  
Maximum mast diameter, 2"  
Surface area . . . . . 8.6 sq. ft.

Wind loading @ 80 mph . . 215 lbs.  
Maximum wind survival . . 100 mph  
Feed method . . . . . Coaxial Balun  
Assembled weight (approx.) 53 lbs.  
Shipping weight (approx.) . 62 lbs.

## Compare the SY-36 with others . . .

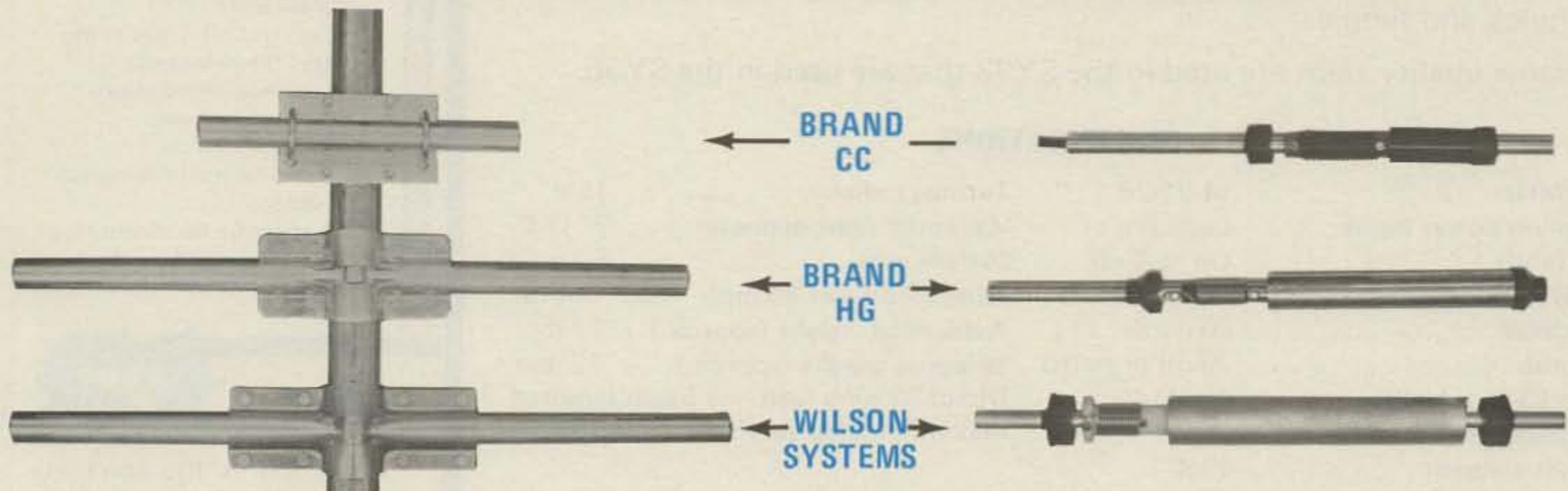

Compare the size and strength of the boom to element clamps. See who offers the largest and heaviest duty. Which would you prefer?

Wilson Systems traps offer a larger diameter trap coil and a larger outside housing, giving excellent Q and power capabilities.

**CALL  
FACTORY DIRECT  
1-800-634-6898**

**W S I WILSON SYSTEMS, INC.** W33

4286 S. Polaris Ave., Las Vegas, Nevada 89103

Prices and specifications subject to change without notice.

# WILSON SYSTEMS INC. MULTI-BAND ANTENNAS

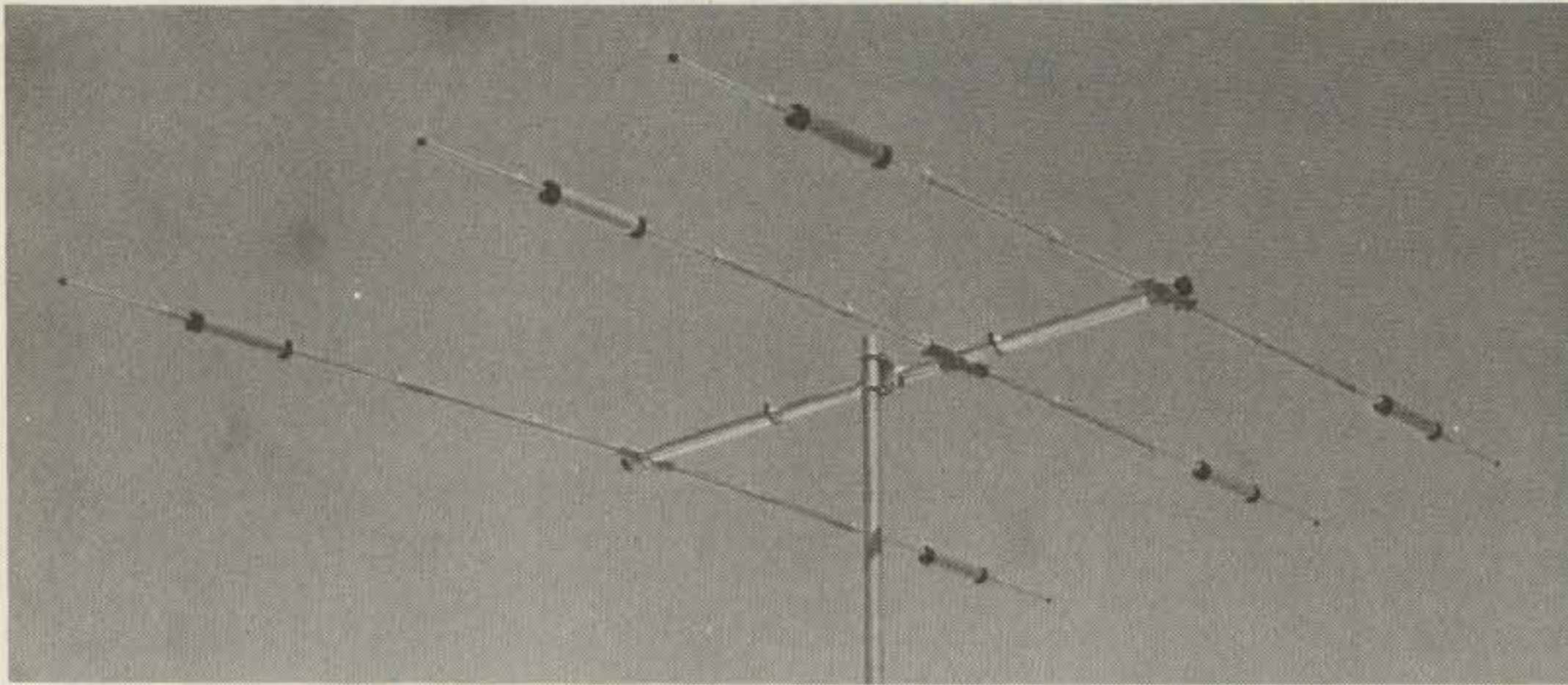

**\$139<sup>95</sup>**

## SYSTEM 33 (FORMERLY SYSTEM THREE)

FACTORY  
DIRECT  
ONLY

Capable of handling the Legal Limit, the "SYSTEM 33" is the finest compact tri-bander available to the amateur.

Designed and produced by one of the world's largest antenna manufacturers, the traditional quality of workmanship and materials excels with the "SYSTEM 33".

New boom-to-element mount consists of two 1/8" thick formed aluminum plates that will provide more clamping and holding strength to prevent element misalignment.

Superior clamping power is obtained with the use of a rugged 1/4" thick aluminum plate for boom to mast mounting.

The use of large diameter High-Q traps in the "SYSTEM 33" makes it a high performing tri-bander and at a very economical price.

A complete step-by-step illustrated instruction manual guides you to easy assembly and the lightweight antenna makes installation of the "SYSTEM 33" quick and simple.

The same quality traps are used in the SY33 that are used in the SY36.

### SPECIFICATIONS

Band MHz . . . . .	14-21-28	Turning radius . . . . .	15'9"
Maximum power input . . . . .	Legal limit	Maximum mast diameter . . . . .	2" O.D.
Gain (dbd) . . . . .	Up to 8 dB	Surface area . . . . .	5.7 sq. ft.
VSWR at resonance . . . . .	1.3:1	Wind loading at 80 mph . . . . .	114 lbs.
Impedance . . . . .	50 ohms	Assembled weight (approx.) . . . . .	37 lbs.
F/B ratio . . . . .	20 dB or better	Shipping weight (approx.) . . . . .	42 lbs.
Boom (O.D. x length) . . . . .	2" x 14'4"	Direct 52 ohm feed—no balun required	
No. elements . . . . .	3	maximum wind survival . . . . .	100 mph
Longest element . . . . .	27'4"		

CALL  
FACTORY DIRECT  
1-800-634-6898

**W S I WILSON  
SYSTEMS, INC.**

4286 S. Polaris Ave., Las Vegas, Nevada 89103

Prices and specifications subject to change without notice.

**\$44<sup>95</sup>**

## WV-1A

4 BAND  
TRAP VERTICAL  
(10 - 40 METERS)

No bandswitching necessary with this vertical. An excellent low cost DX antenna with an electrical quarter wavelength on each band and low angle radiation. Advanced design provides low SWR and exceptionally flat response across the full width of each band.

Featured is the Wilson large diameter High-Q traps which will maintain resonant points with varying temperatures and humidity.

Easily assembled, the WV-1A is supplied with a hot dipped galvanized base mount bracket to attach to vent pipe or to a mast driven in the ground.

#### Note:

Radials are required for peak operation.  
(See GR-1 below).

#### SPECIFICATIONS:

- Self supporting—no guys required.
- Input Impedance: 50  $\Omega$
- Powerhandling capability: Legal Limit
- Two High-Q Traps with large diameter coils
- Low Angle Radiation
- Omnidirectional performance
- Taper Swaged Aluminum Tubing
- Automatic Bandswitching
- Mast Bracket furnished
- SWR: 1.1:1 or less on all Bands

## GR-1

**\$9<sup>95</sup>**

The GR-1 is the complete ground radial kit for the WV-1A. It consists of: 150' of 7/14 stranded copper wire and heavy duty egg insulators, instructions. The GR-1 will increase the efficiency of the WV-1A by providing the correct counterpoise.

# WILSON MONO-BAND BEAMS

**\$209<sup>95</sup>**

**FACTORY DIRECT ONLY**

THE ALL NEW  
5 ELEMENT 20 METER BEAM  
M520A

At last, the antennas that you have been waiting for are here! The top quality, optimum spaced, and newest designed mono-banders. The Wilson Systems' new Monoband beams are the latest in modern design and incorporate the latest in design principles utilizing some of the strongest materials available. Through the select use of the current production of aluminum and the new boom to element plates, the Wilson Systems' antennas will stay up when others are falling down due to heavy ice loading or strong winds. Note the following features:

1. **Taper Swaged Elements** – The taper swaged elements provide strength where it counts and lowers the wind loading more efficiently than the conventional method of telescoping elements of different sizes.
2. **Mounting Plates – Element to Boom** – The new formed aluminum plates provide the strongest method of mounting the elements to the boom that is available in the entire market today. No longer will the elements tilt out of line if a bird should land on one end of the element.
3. **Mounting Plates – Boom to Mast** – Rugged 1/4" thick aluminum plates are used in combination with sturdy U-bolts and saddles for superior clamping power.
4. **Holes** – There are no holes drilled in the elements of the Wilson HF Monobanders. The careful attention given to the design has made it possible to eliminate this requirement as the use of holes adds an unnecessary weak point to the antenna boom.

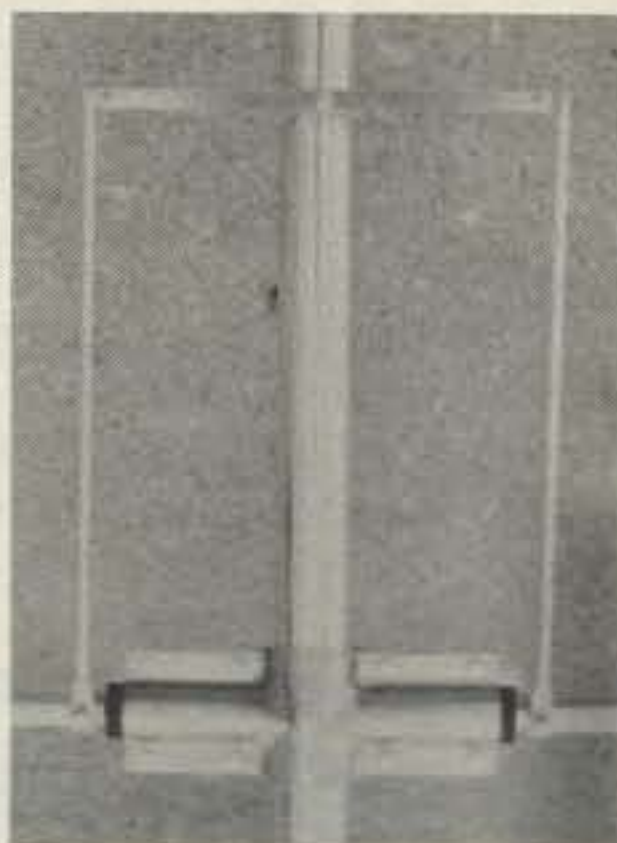

Wilson's Beta match offers maximum power transfer.

With the Wilson Beta-match method, it is a "set it and forget it" process. You can now assemble the antenna on the ground, and using the guidelines from the detailed instruction manual, adjust the tuning of the Beta-match so that it will remain set when raised to the top of the tower.

The Wilson Beta-match offers the ability to adjust the terminating impedance that is far superior to the other matching methods including the Gamma match and other Beta-matches. As this method of matching requires a balanced line it will be necessary to use a 1:1 balun, or RF choke, for the most efficient use of the HF Monobanders.

The Wilson Monobanders are the perfect answer to the Ham who wants to stack antennas for maximum utilization of space and gain. They offer the most economical method to have more antenna for less money with better gain and maximum strength. Order yours today and see why the serious DXers are running up that impressive score in contests and number of countries worked.

## SPECIFICATIONS

Model	Band Mtrs	Gain dBd	F/B Ratio	Bandwidth @ Resonance 2:1 VSWR Limits	VSWR @ Resonance	Impedance	Matching	Elements	Longest Element	Boom O.D.	Boom Length	Turning Radius	Surface Area (Sq.Ft.)	Windload @ 80 mph (Lbs.)	Maximum Mast	Assembled Weight (Lbs.)
M520A	20	11.5	25 dB	500 KHz	1.1:1	50 Ω	Beta	5	36'6"	2"	34'2½"	25'1"	8.9	227	2"	68
M420A	20	10.0	25 dB	500 KHz	1.1:1	50 Ω	Beta	4	36'6"	2"	26'0"	22'6"	7.6	189	2"	50
M515A	15	12.0	25 dB	400 KHz	1.1:1	50 Ω	Beta	5	25'3"	2"	26'0"	17'6"	4.2	107	2"	41
M415A	15	10.0	25 dB	400 KHz	1.1:1	50 Ω	Beta	4	24'2½"	2"	17'0"	14'11"	3.1	54	2"	25
M510A	10	12.0	25 dB	1.5 MHz	1.1:1	50 Ω	Beta	5	18'6"	2"	26'0"	16'0"	2.8	72	2"	36
M410A	10	10.0	25 dB	1.5 MHz	1.1:1	50 Ω	Beta	4	18'3"	2"	12'11"	11'3"	1.4	36	2"	20

CALL  
FACTORY DIRECT  
1-800-634-6898

**W S I WILSON SYSTEMS, INC.**

4286 S. Polaris Ave., Las Vegas, Nevada 89103

Prices and specifications subject to change without notice.



# 6 METER BEAMS

## Model M68

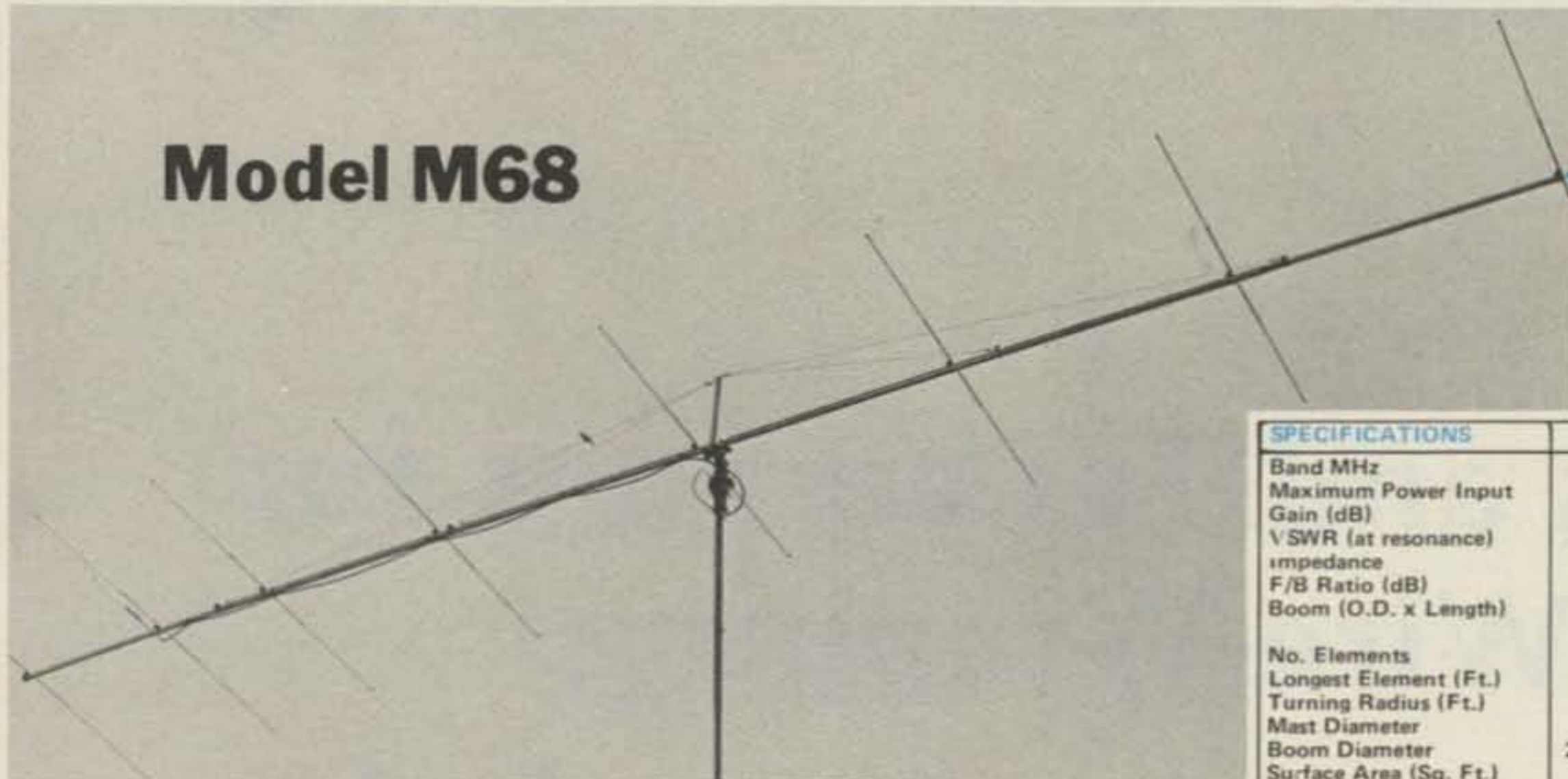

As low as  
**\$27.95**

8 elements W - I - D - E spaced on a L - O - N - G 37' boom . . . for those long hauls to JA and VK land! Choose 4, 6 or 8 elements to put you in the action on six meters.

SPECIFICATIONS	MODEL M68	MODEL M66	MODEL M64
Band MHz	50	50	50
Maximum Power Input	4 Kw	4 Kw	4 Kw
Gain (dB)	13.5	13.0	10.0
VSWR (at resonance)	1.1:1	1.1:1	1.1:1
impedance	50 ohms	50 ohms	50 ohms
F/B Ratio (dB)	26	26	25
Boom (O.D. x Length)	2" to 1 1/2" x 36'10"	2" x 25'8"	1 1/2" x 11'6"
No. Elements	8	6	4
Longest Element (Ft.)	9'8"	9'8"	9'8"
Turning Radius (Ft.)	19'0"	13'10"	7'6"
Mast Diameter	2" O.D.	2" O.D.	1 1/2" O.D.
Boom Diameter	2" to 1 1/2" O.D.	2" O.D.	1 1/2" O.D.
Surface Area (Sq. Ft.)	5.8	4.5	1.5
Wind Loading @ 80 mph	145	112	37
Assembled wght. Approx.	34 lbs.	26 lbs.	11 lbs.
Shipping wght. Approx.	39 lbs.	31 lbs.	13 lbs.
Matching Method	Gamma	Gamma	Gamma
PRICE	\$84.95	\$54.95	\$27.95

Starting at  
**\$19.95**

# 2 METER BEAMS

Wilson's new 2 meter series combines the ultimate in design and quality materials. These top performing beams feature 7, 9 or 11 aluminum elements held to the heavy walled boom with the exclusive molded Lexan® boom to element mounting. The four driven elements use Log Periodic design for broad band characteristics providing full 144-148 MHz coverage with less than 1.2 to 1 VSWR across the band. Universal mounting is provided for vertical or horizontal polarization.

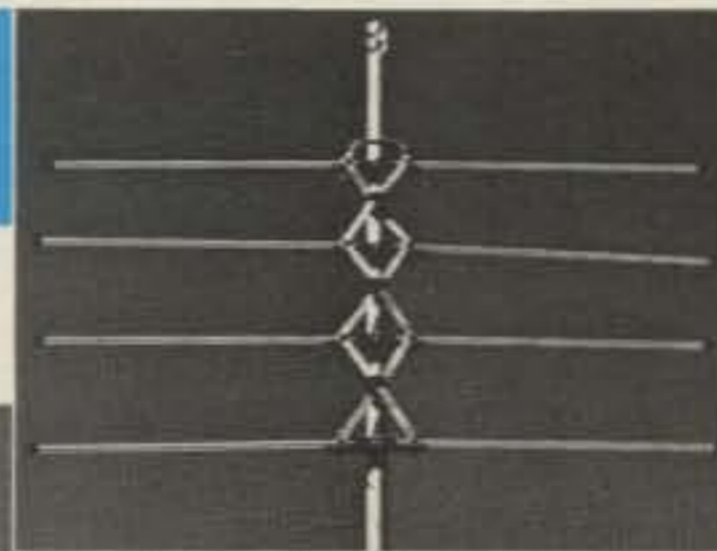

SPECIFICATIONS	M27	M29	M211
Band MHz	144-148 MHz	144-148 MHz	144-148 MHz
Gain (dB)	11 dB	13.7 dB	14.5 dB
VSWR	Less than 1.2:1 across band	Less than 1.2:1 across band	Less than 1.2:1 across band
Impedance	50 ohms balanced	50 ohms balanced	50 ohms balanced
Number of Elements	7	9	11
Boom (O.D. x Length)	1" O.D. x 5'4"L.	1" O.D. x 10'0"L.	1 1/2" O.D. x 12'6"
Longest Element	40"	40"	40"
Surface Area (Sq. Ft.)	.8	1.5	2.8
Assembled wght Approx.	3.5 lbs.	5 lbs.	6 lbs.
Shipping wght. Approx.	6.5 lbs.	8 lbs.	9 lbs.
Turning Radius	38"	64"	78"
PRICE	\$19.95	\$24.95	\$29.95

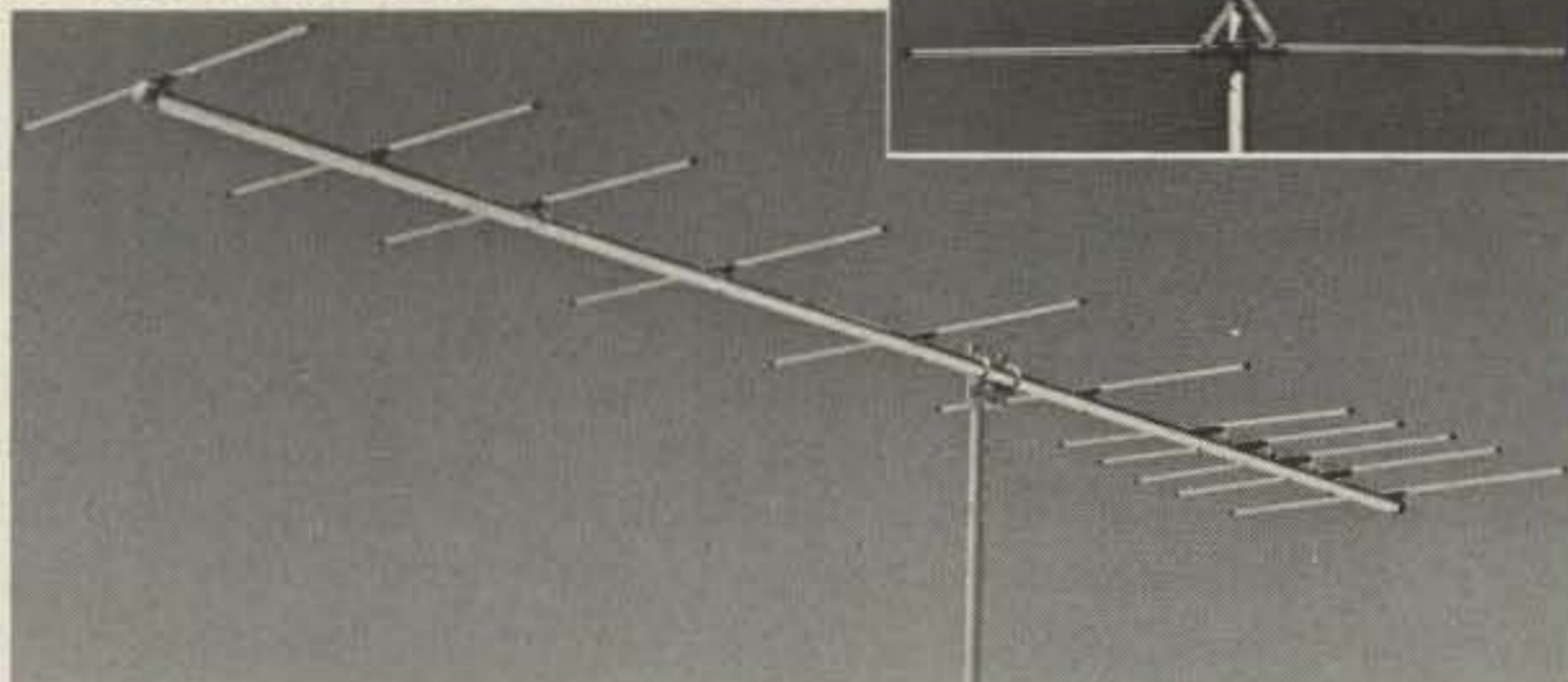

WILSON SYSTEMS, INC. - 4286 S. Polaris  
Las Vegas, NV 89103 - (702) 739-7401

**FACTORY DIRECT  
ORDER BLANK**

Toll-Free Order Number  
**1-800-634-6898**

### WILSON SYSTEMS ANTENNAS

### WILSON SYSTEMS TOWERS

Qty	Model	Description	Shipping	Price
	SY33	3 Ele. Tribander for 10, 15, 20 Mtrs.	UPS	\$139.95
	SY36	6 Ele. Tribander for 10, 15, 20 Mtrs.	UPS	189.95
	WV-1A	Trap Vertical for 10, 15, 20, 40 Mtrs.	UPS	44.95
	GR-1	Ground Radials for WV-1A	UPS	9.95
	M-520A	5 Elements on 20 Mtrs.	TRUCK	209.95
	M-420A	4 Elements on 20 Mtrs.	UPS	139.95
	M-515A	5 Elements on 15 Mtrs.	UPS	119.95
	M-415A	4 Elements on 15 Mtrs.	UPS	79.95
	M-510A	5 Elements on 10 Mtrs.	UPS	84.95
	M-410A	4 Elements on 10 Mtrs.	UPS	64.95
	WM-62A	Mobile Antenna: 5/8 λ on 2, 1/4 λ on 6	UPS	19.95
	M-86	8 Elements on 6 Mtrs.	UPS	84.95
	M-66A	6 Elements on 6 Mtrs.	UPS	54.95
	M-46	4 Elements on 6 Mtrs.	UPS	27.95
	M-112	11 Elements on 2 Mtrs.	UPS	29.95
	M-92	9 Elements on 2 Mtrs.	UPS	24.95
	M-72	7 Elements on 2 Mtrs.	UPS	19.95
	<b>ACCESSORIES</b>			
	HD-73	Alliance Heavy Duty Rotor	UPS	109.95
	RC-8C	8/C Rotor Cable	UPS	.12/ft.
	RG-8U	RG-8U Foam-Ultra Flexible Coaxial Cable. 38 strand center conductor, 11 gauge	UPS	.21/ft.

Qty.	Model	Description	Shipping	Price
	TT-45A	Freestanding 45' Tubular Tower	TRUCK	\$249.95
	RB-45A	Rotating Base for TT-45A w/tilt over feature	TRUCK	139.95
	FB-45A	Fixed Base for TT-45A w/tilt over feature	TRUCK	99.95
	MT-61A	Freestanding 61' Tubular Tower	TRUCK	449.95
	RB-61A	Rotating Base for MT-61A w/tilt over feature	TRUCK	199.95
	FB-61A	Fixed Base for MT-61A w/tilt over feature	TRUCK	129.95

**NOTE:**

On Coaxial and Rotor Cable, minimum order is 100 ft. and in 50' multiples. Prices and specifications subject to change without notice. Ninety Day Limited Warranty, All Products FOB Las Vegas, Nevada  
**PRICES EFFECTIVE NOV. 1, 1979**

Nevada Residents Add Sales Tax

Ship C.O.D.  Check enclosed  Charge to Visa  M/C

Card # \_\_\_\_\_ Expires \_\_\_\_\_

Bank # \_\_\_\_\_ Signature \_\_\_\_\_

Please Print

Name \_\_\_\_\_ Phone \_\_\_\_\_

Street \_\_\_\_\_

City \_\_\_\_\_ State \_\_\_\_\_ Zip \_\_\_\_\_

Prices and specifications subject to change without notice.

# Tools and Techniques for Wire-Wrapping

— an excerpt from 73's new book

**Editor's note:** This article is an excerpt from 73's new book, *Tools and Techniques for Electronics*, by A. A. Wicks W6SWZ. The book is a comprehensive guide to construction practices, from soldering to PC boards to metalworking. It's available from 73's Radio Bookshop, Peterborough NH 03458. The price is \$4.95 (plus \$1.00 for shipping and handling).

As experimenters and hobbyists become more and more involved in integrated circuitry and equipment that utilizes these and other miniature devices, a technique that has been used in industry for many years becomes attractive to use. Although originally developed in the

early 1950s, a solderless interconnection technique known as wire-wrapping did not immediately gain popularity within industry until automatic and semi-automatic wire-wrapping equipment, for the most part using programmed tape equipment, provided a low-cost, rapid method of

making thousands of these solderless connections on the "back panel" of component boards.

A wire-wrapped connection is shown in Fig. 1. It is exactly that—a wire, "wrapped" around a terminal post several turns, which provides an absolute metal-to-metal, gastight connection. At first, these connections were made by using a hand-operated tool. Then, speed was gained by driving this tool with an electric motor in the form of a "gun" in which the tool was inserted and locked. This technique continued to be used industrially, even with the advent of programmed machinery which, point-by-point, moved the electric tool over a back panel, at which point a human operator inserted a pre-cut and pre-stripped length

of wire in the tool, lowered it over the wire terminal post, made the wrap, then allowed the tool to move to its next location. This technique continues to be used today, but in more sophisticated applications of mass production, the whole operation is programmed and automatic.

While this was going on, the engineering laboratories were involved in prototype production, but, as is obvious, prototypes do not warrant the expense of specialized programmed equipment worth tens of thousands of dollars.

Therefore, back in the lab, engineers and technicians continue to use hand wire-wrapping tools, both manual and electric. And it is to this level, the prototype level, that we, as experimenters and hobby work-

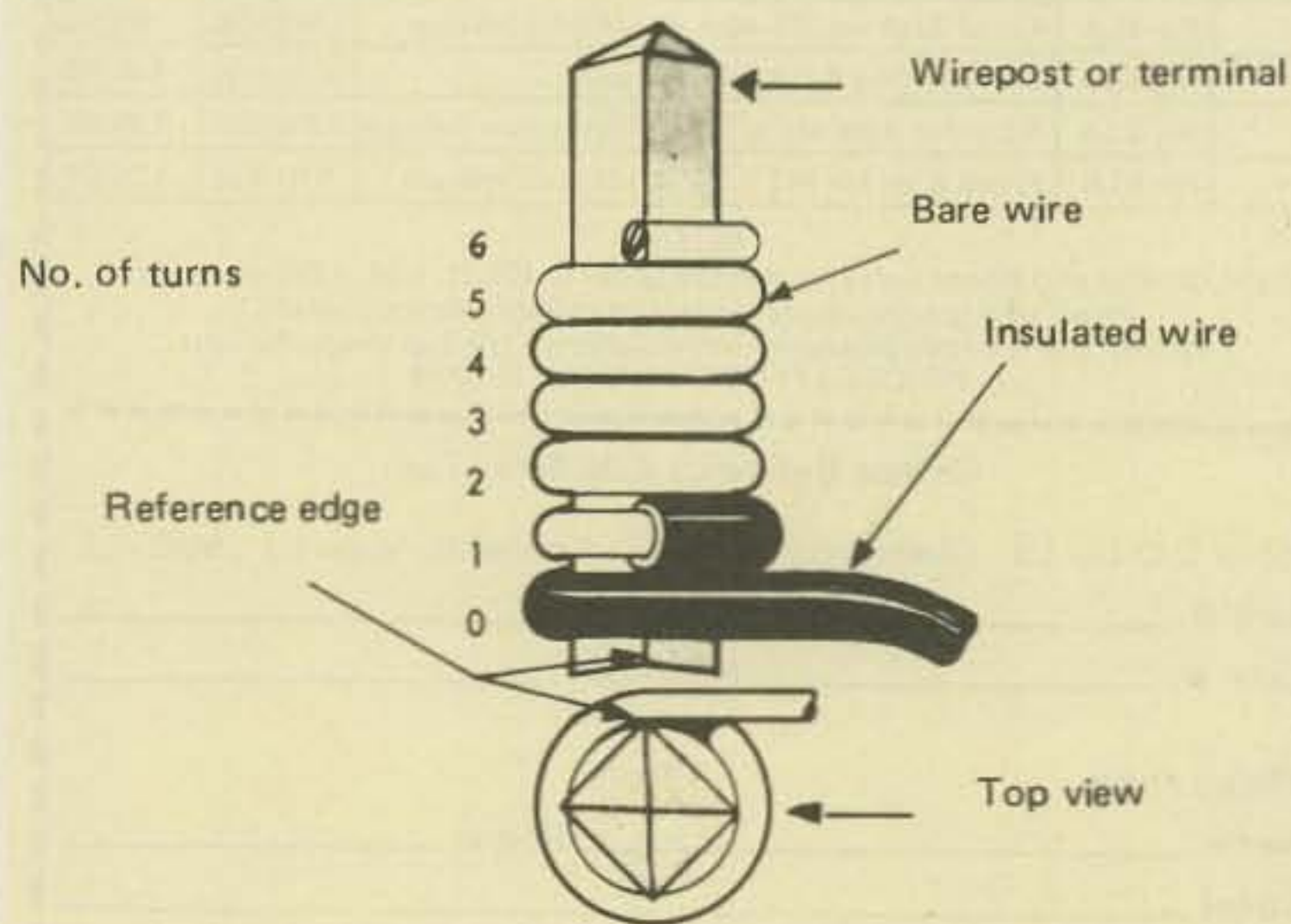

Fig. 1. Wire-wrapped terminal and references.

ers, direct our interest.

The techniques of wire-wrapping are especially desirable in place of printed circuit boards (frequently called "cards"), when only one unit is to be produced. Printed circuit layout and preparation for one assembly, although creative fun and very effective, is more work than enjoyment in many instances, especially for the person anxious to have a circuit completed and ready for operation quickly. (A combination of printed circuit and wire-wrapping will be discussed later in this section.)

The information provided here is directed for the most part to those who have never performed wire-wrapping. A person already involved in this type of construction is usually extremely enthusiastic about its time-saving and "second-chance" possibilities (a printed circuit is very difficult to change, once etched). Before proceeding, we should mention some of the terms of wire-wrapping and what they mean, so that you may discuss the equipment and tools with your supplier.

First of all, there are two styles of wire-wrapping in use, as far as serially-connected terminals are concerned. One "daisy chain" is shown in Fig. 2(a). "Level-ordered" is shown in Fig. 2(b). Daisy-chain wiring is not recommended, as a moment of study will show that if you wish to change the wiring on two terminal posts (or wire-wrapping terminals) that have been daisy-chained, you may have to remove six wires (the maximum number of wire levels being three), whereas with level-ordered wiring, four would be maximum.

Wires placed on posts by level order are iden-

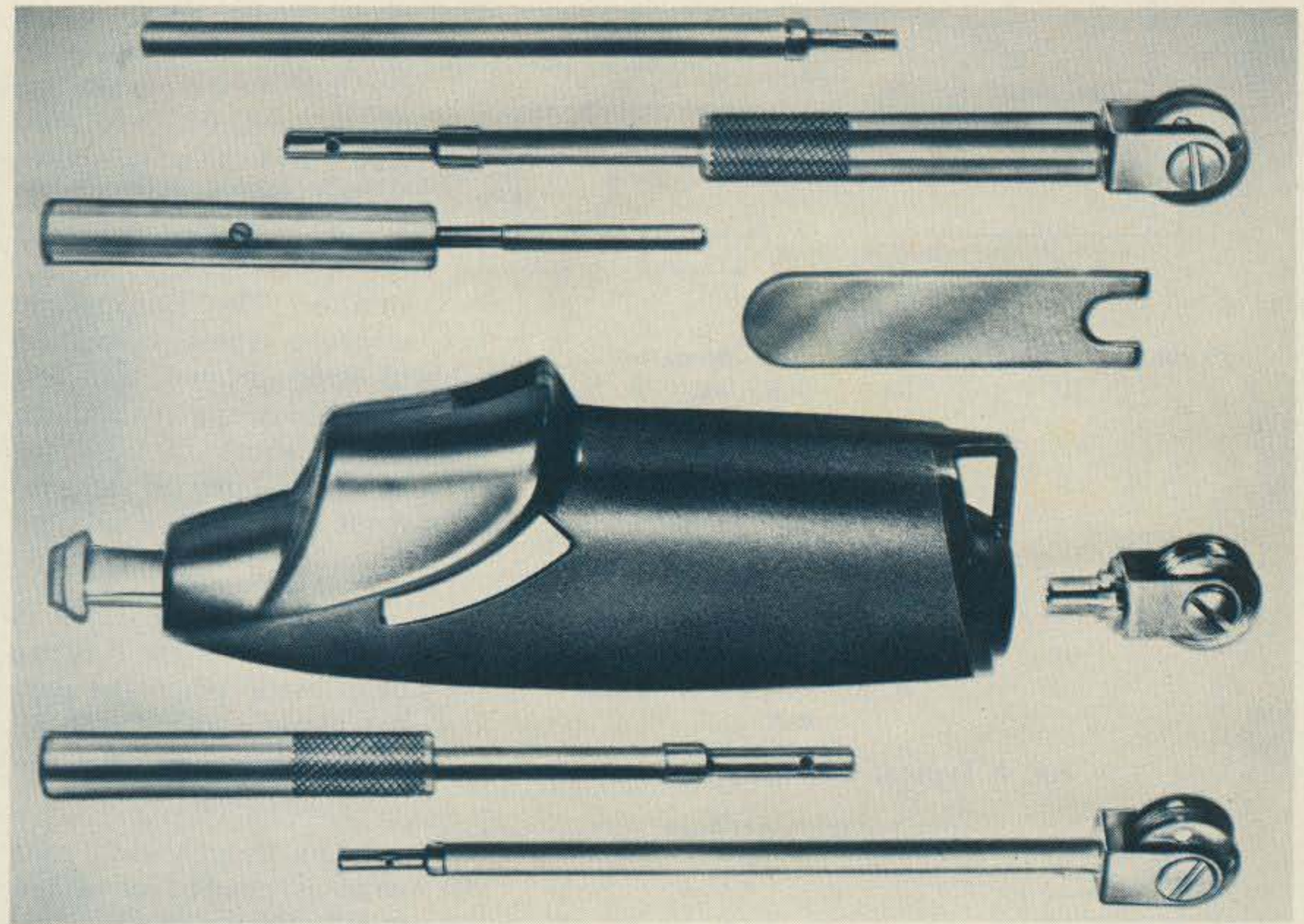

Photo A. Low-cost manual and electric wire-wrapping tools.

tified as levels 1, 2 and 3, with level 1 being the wire nearest the component board (Fig. 3).

### Ordering of Wiring

Although not absolutely essential, especially on a smaller project, it may be desirable to "order" your wiring prior to commencing the actual job. That is, you must consider that certain wires will go on level 1, certain others on level 2, and so on. The only real reason for this, of course, is for later corrections, modifications, and additions. With all three levels full, and density wiring, it is of immense help to know that the wire you wish to remove is on "terminal post 6, IC23, level 2," for instance. This information can be part of your "wire list" prepared directly from the circuit diagram. If you have a good wire list, you can rapidly wire a back panel using wire-wrapping techniques, without reference to the schematic. In fact, electronics laboratories have persons skilled in wire-

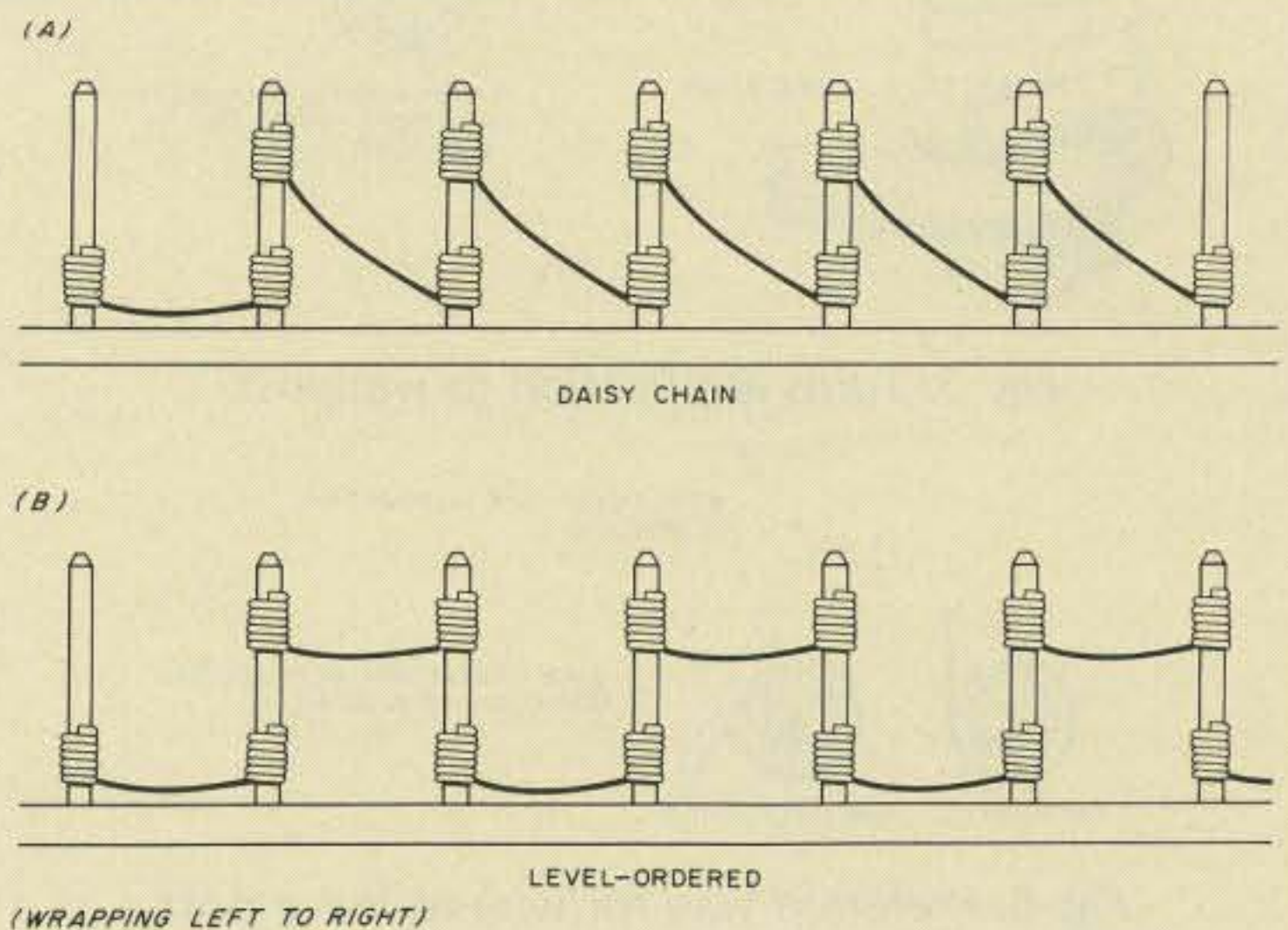

Fig. 2. Daisy-chain and level-ordered wiring.

wrapping, but unskilled in electronics, doing this constantly.

### Wire-listing

Whether or not you level order your wires, do plan on wire-listing your connections as mentioned above when wiring complex circuitry. Make up a wire-list table, as shown in Fig. 4, and, working from the schematic, such as that shown in the figure, draw a line through the schematic as you enter the information on the wire list.

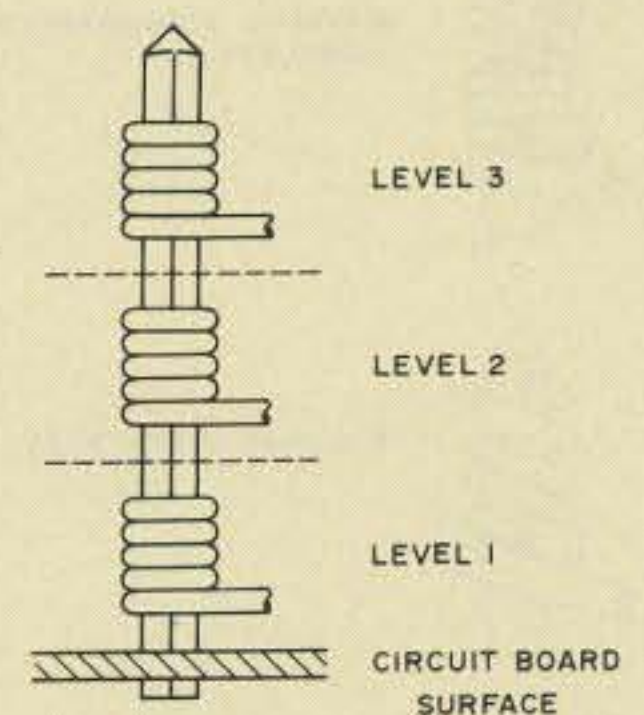
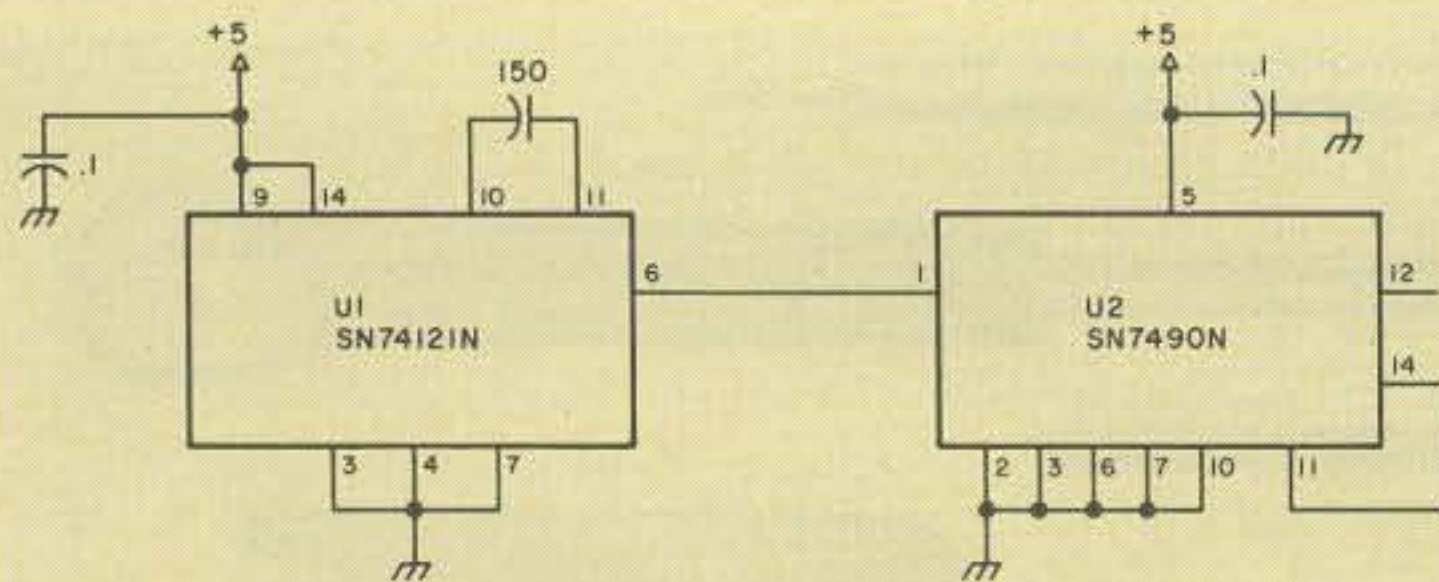

Fig. 3. Level orders of wire-wrapping.

Check this over, and your chances of wiring error are minimal. If you do mis-wire, locating your error is done quickly.



Component Reference	From	To	Remarks
U1	U1-9	+5	Vss
	U1-9	U1-14	
	U1-9	.1	.1 uF to gnd
	U1-10	150 pF	150 pF to U1-11
	U1-3	G	Chain
	U1-4	G	Chain
	U1-7	G	Chain
U2	U1-6	U2-1	
	U2-5	+5	
	U2-5	.1	.1 uF to gnd etc.

Fig. 4. Typical wire-list table.

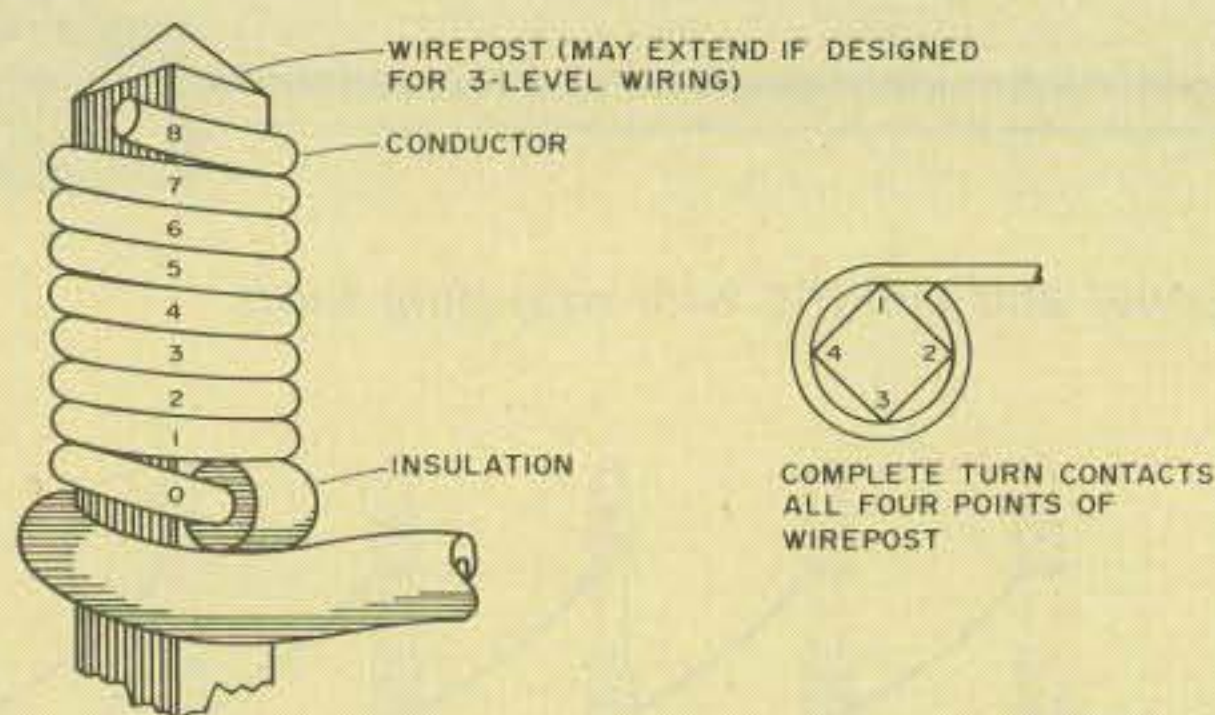

Fig. 5. Turns application to wirepost.

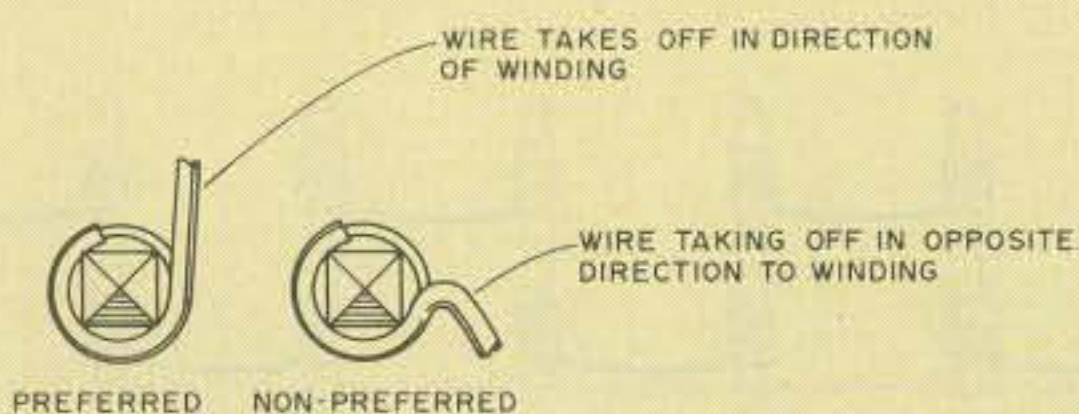

Fig. 6. Preferred way for wire to leave post.

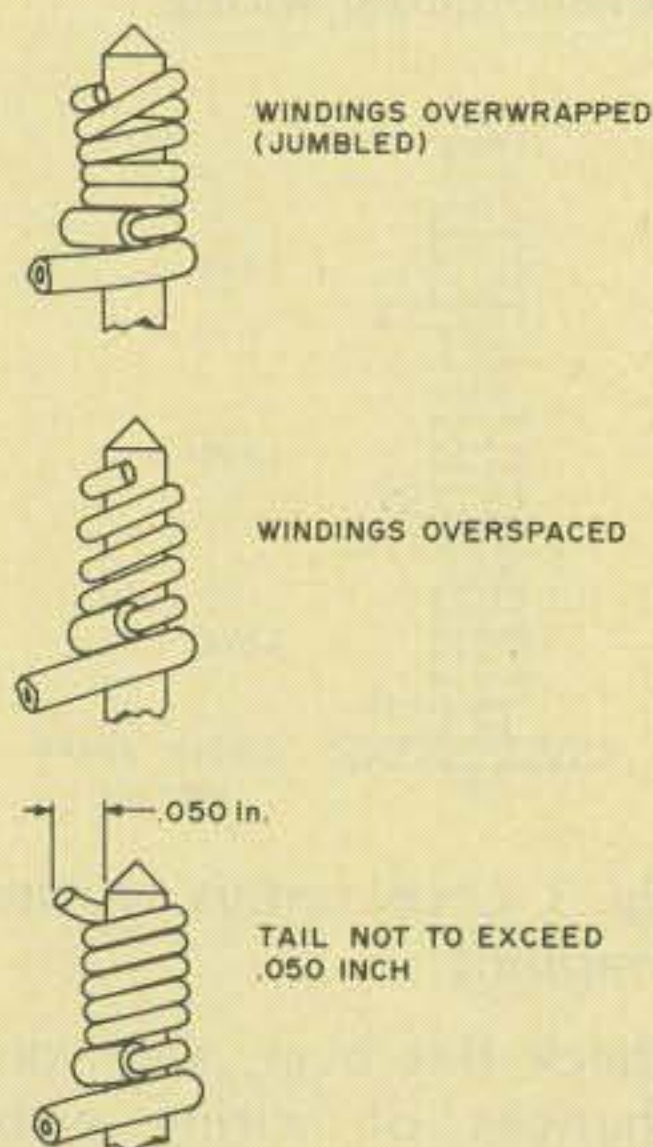

Fig. 7. Three types of unsatisfactory wraps.

### Wire Application

Using conventional wire-wrapping tools, whether electric or manual, is the same, as far as the wiring on the post is concerned. We say "conventional," because later on we are going to describe some newer tools that have been produced with you, the at-home constructor, in mind.

Wires wrapped on a post should look like the greatly enlarged sketch in Fig. 5. The number of wire turns should be six of bare wire (plus two

turns, minus one turn as a variable), in addition to one-half to three-quarters of a turn of insulated wire. This also is shown in the above figure, and applies to wire sizes of no. 26 AWG (0.0159-in.) or smaller. The purpose in allowing some insulation to wrap around the post is for strength and to avoid short circuits (as could happen if several wires bared of insulation extended from the posts).

A completed turn is considered as having been made when the wire has made contact with all four corners of the terminal post (Fig. 5).

Even though only one wrap is needed on a terminal, always put the first wrap at level 1. If you find it necessary to unwrap a wire from a post, never attempt to reuse it, but remove the other end also, and discard the wire. Once applied and removed, wire is structurally damaged so that it is totally unreliable for reuse. Caution should also be used in attempting to reuse terminal posts too many times. After ten or so wraps and unwraps, inspect the post closely, with a magnifier if possible, for damage such as loss of plating, corrosion, nicks, and structural weakness. This is more important if a powered wrapping tool has been used, as manual use is not so likely to apply as many stresses.

Route your wires rather openly from terminal to terminal. It is not unusual to loop the wires in an upward direction and dress them carefully later. Do not draw them tightly around other posts or parts, and never kink or sharply bend the wires. As long as electrical factors such as rf, hum,

choke effect, etc., are not a consideration, multiple loops are acceptable in order to take up slack if the lead is too long. Always inspect the wires as the work progresses for any bare spots that may have been made in the insulation of the wire between wiring points. Never repair; always replace, if any are found.

Whenever possible, have the wire wrapped on the post in an orientation that allows the wire to leave the post without any tendency to unwind, as in Fig. 6. This means that you should always look ahead to see where the next post is that is to be connected.

With most tools, you cannot make other than perfect wraps. However, a non-perfect wrap, should it occur, is one that has the wires "jumble-wound" (a wire on top of itself in a spiral) or a wire that has too much space between each turn (should not be more than one-half the wire diameter). Last—but certainly very important because of short-circuit potential—do not permit the end of the wire resulting from the last turn to project out from the post more than .05 inch (1.3 mm). Spacing between two of these wire ends should be a minimum of 1/32 inch (.08 cm). See Fig. 7.

All of the preceding makes wire-wrapping sound difficult and complex—which is far from being true—but these hints are merely ways to do the job well. Now let us consider some of the tools that make the job easy.

A wire-wrapping tool used in a power-operated device is known as a bit, just as for a drill. Bits are provided to accommodate various sizes of bare

wire, e.g., no. 22-24, 24-26. A sleeve, customarily used, is insulated and protects adjacent terminals. The bit rotates within the sleeve. Photo A shows several wire-wrapping tools.

A tool for manual operation is known generically as a wire-wrapping tool—sometimes as a hand-wrapping tool. A number of trade names are in use. We also have “unwrapping” tools, discussed later.

The basic tool is composed of a handle, as a screwdriver has, and a narrow cylinder about two inches long. The operating end is approximately .070 inch (1.8 mm) in diameter to permit easy working between terminal posts. These tools are usually made of metal, although one manufacturer produces a low-cost tool made with fiberglass filled nylon. A tool manufactured by Vector Electronic Company, Sylmar, California, uses a hardened beryllium copper bit, and can easily wrap multilevels. This particular tool will accept no. 26 through 30 gauge wire, and has the unique capability of accepting bare wire through the top end for continuous wiring.

The bit end of the tool accepts the bared end of insulated wire or the end of uninsulated wire. The principle of inserting the wire and wrapping is similar. The enlarged view of the bit end shown in Fig. 8, through the courtesy of Vector Electronic Company, Inc., is used here for illustration.

The wire to be inserted should be held in one hand with your thumbnail 1.3 inches (3.3 cm) from the end of the wire. The side of the bit that has the wire tunnel may be identified by the probe hole on the side of the tool tip.

Holding the tool horizontally, or with the tip elevated slightly, insert the

wire end into the tunnel. If the position of the wire probe hole has been noted, there should be no problem. But if you have inadvertently inserted the wire into the wirepost hole, the wire will not enter as far as your thumbnail holding the wire. Therefore, remove the wire and try again. Once it is inserted correctly, remove the wire about half of its length, bend it slightly and reinsert it. This will hold it securely. Now, releasing the wire, bend it at 90° at the tip.

Place the tool down over the wire-wrap post, and route the other end of the wire toward the next terminal post to be wrapped. Hold the loose end of the wire to the board with a firm but soft tool (an alignment tool is good for this, or a small screwdriver with a piece of heatshrink tubing on the end), make one clockwise turn using no downward pressure. Continue, using slight downward pressure, for the full number of turns. If the amount of insulation removed is correct for the number of turns, the tool should release itself. But if you continue to turn and exert downward pressure, jumblewrap (or overwrap) will result.

Wires may be stripped as you wire, using standard wire-stripping tools (they must be for the small wire sizes used, of course), or you may strip ahead of time. Considering the relatively minor cost involved, this rather irksome task may be avoided by purchasing your wire pre-cut and pre-stripped. The Cambridge Thermionic Corporation (Cambion®), for instance, supplies kits of 25 pieces each of 1.5-, 2.5-, 5.0-, and 7.0-inch (3.81-, 6.35-, 12.7-, and 17.78-cm) no. 30 AWG kynar-insulated wire. Each length is stripped one inch (2.54 cm) on each end.

Unwrapping may be

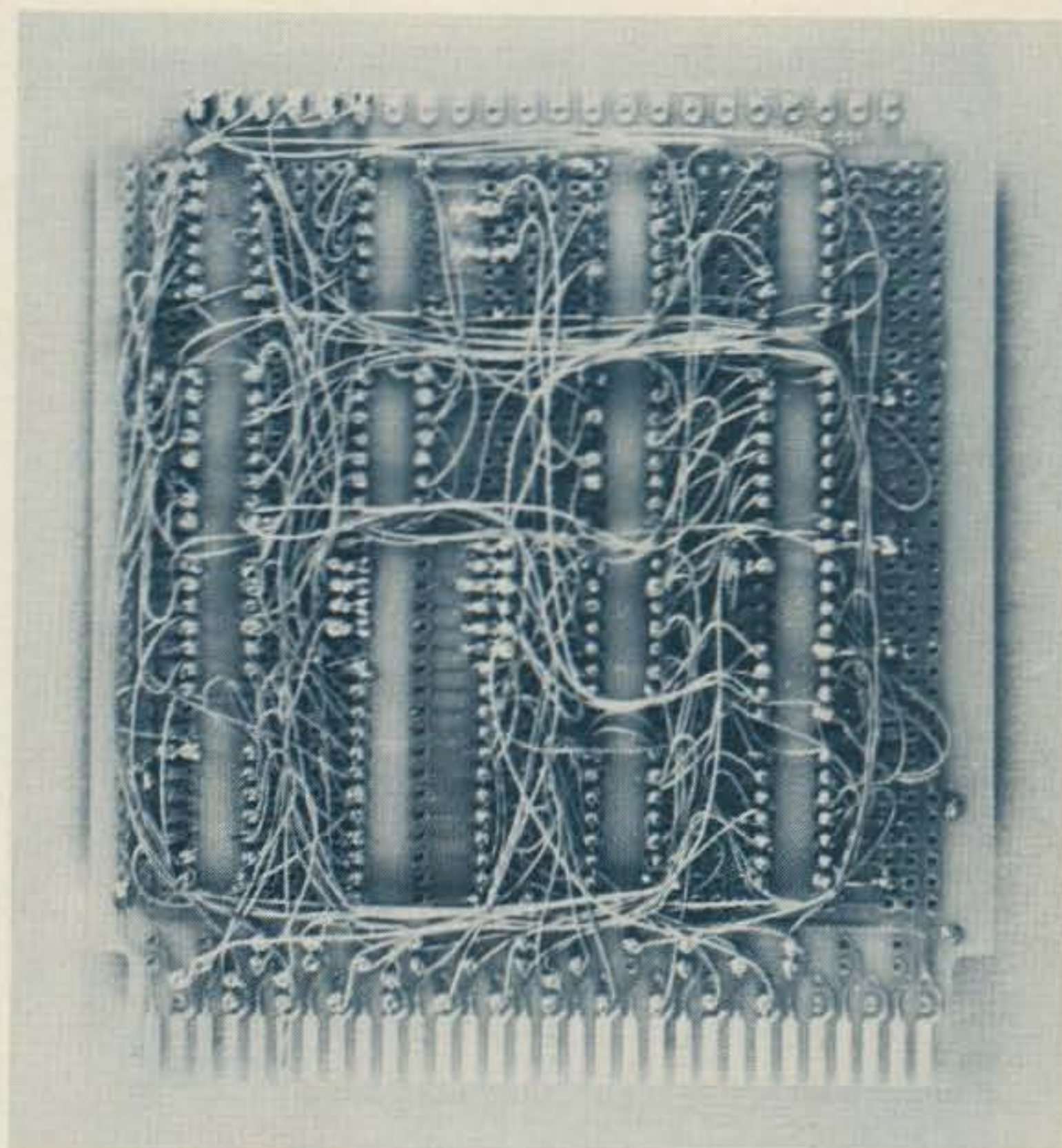

Photo B. Typical wire-wrapped circuit board. This board is of “universal type” with printed circuitry on opposite side.

done by carefully gripping the wire with needlenose pliers and unwinding the spiral. But this is tedious and time-consuming if many unwindings are to be made. An unwrapping tool, manually operated, is very low in cost and should be on hand.

In order to unwind a wrap, all that is necessary is to place the tool over the post, press it down slightly, and turn it counterclockwise. As previously mentioned and again emphasized—discard the wire.

One rather innovative approach to prototype wire-wrapping has been made by Vector. The tool used for this purpose is the Model P180, and has been designated “Slit-n-Wrap.” A Motor-driven model, the P160-4T, is also available, but utilizes the hand tool as a driving bit, thus permitting you to upgrade your initial purchase if you desire.

The wire normally used for this tool is no. 28 AWG, nylon-polyurethane insulated, but it is also possible to wrap using standard no.

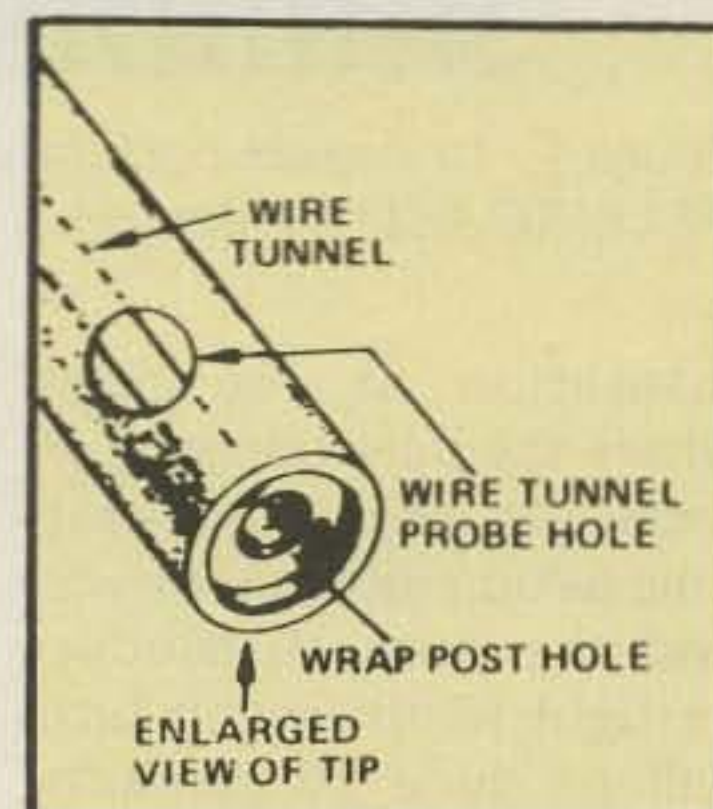

Fig. 8. Wire-wrap (Vector).

28 or no. 30 gauge pre-stripped and pre-cut wire. The wire may be obtained in clear, red, green, or blue, and is run from a spool attached to the top of the tool.

The system has been designed so that six turns provide extremely low resistance connections, each contact being approximately 0.003 Ohms. The secret to the success of this tool is in the removal of insulation from the wire as it passes over a narrow sharp edge in the bit. As the tool is rotated, the wire rolls along a path from this sharp edge to the wire post, which further opens the slit in the

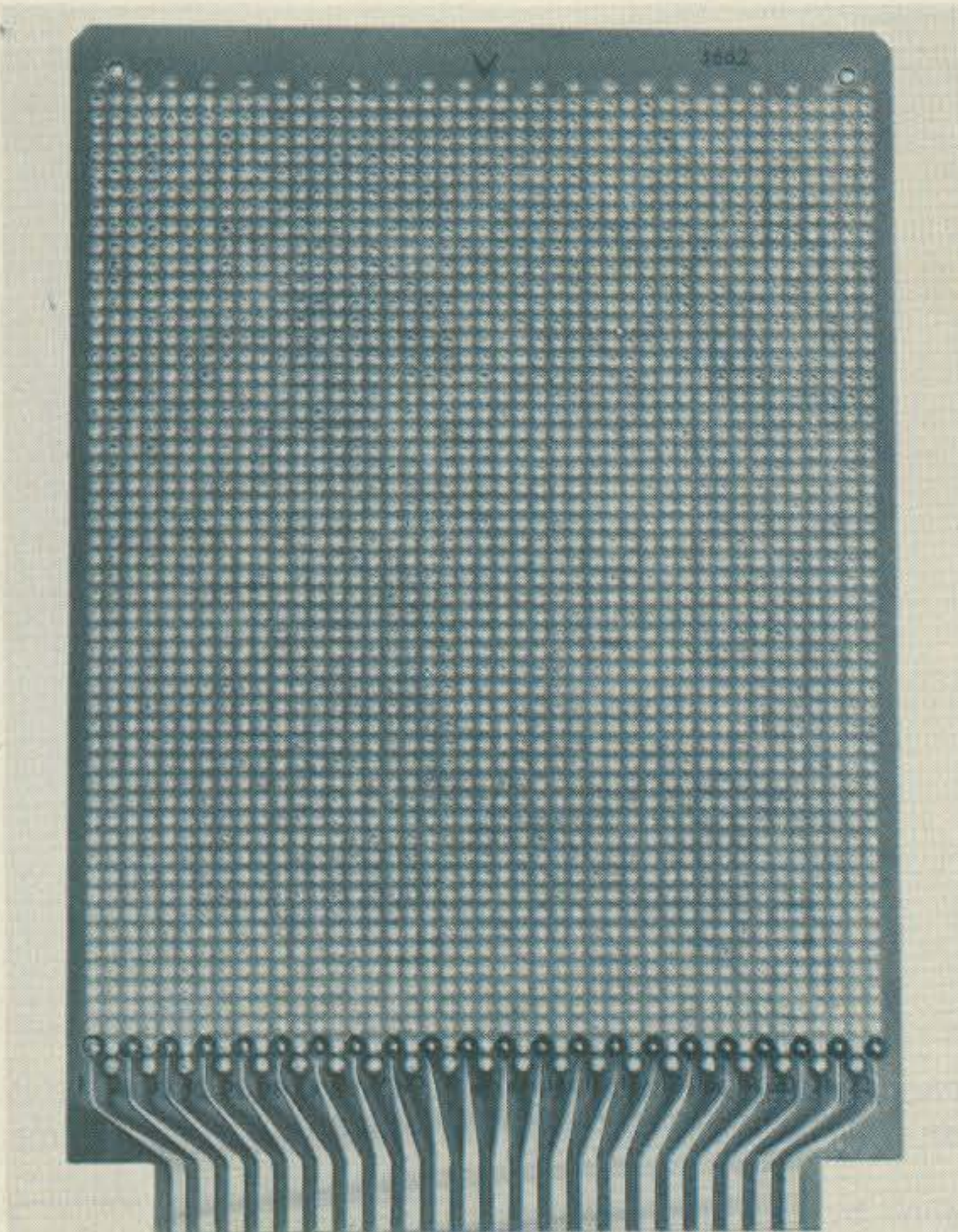

Photo C. Universal perforated board with end connectors (PLUGBOARD by Vector).

insulation at the point where the bare copper contacts the post. The wrapping action indents the wire and the post, to produce gastight joints (seven turns will produce 28 contacts). Insulation removal only occurs when wrapping takes place, not when wire is removed from the tool.

Fig. 9 shows a cross-section of how the wire wraps on the post. Any insulation that is displaced reforms in the space between the wire turns. Wire is held close to the board (when starting or moving to the next terminal) using a dull wire-holder. No looping is necessary, and this type of wiring is amenable to daisy chaining. Wire is not cut until the end of a run or until a circuit path is reached.

#### Circuit Boards for Wire-wrapping

You may design and make your own PCB that will permit you to use wire-

wrapping techniques. You may purchase "universal" PCBs (Photo B) that allow complete flexibility of design using wire-wrapping. And you may purchase component boards containing prepunched holes for mounting parts to be connected by wire-wrapping.

The technique of wire-wrapping is the same in each case. However, with a board etched for a specific project there is little or no flexibility, which is intended.

Universal-type wrap-pable boards have an overall grid of 0.042-inch-diameter (1.1-mm) holes on 0.1-inch (2.5-mm) centers, and use tinned interleaved buses. Any one or more Dual In-line Package (DIP) sockets may be installed anywhere on the boards. If parts such as resistors and capacitors are placed on the board, they should be installed using component carriers in order to take full

Fault	Probable Cause
Spiral or spread out wraps	Lifting tool during wrapping
Overlapping (jumble) turns	Excessive downward pressure during wrap
End tail too long	Removing tool before sufficient rotations have been made
Insufficient turns	Insulation not stripped back far enough. Wire not inserted fully into bit
Excessive turns	Too much insulation stripped

Table 1. Wire-wrapping problem guide.

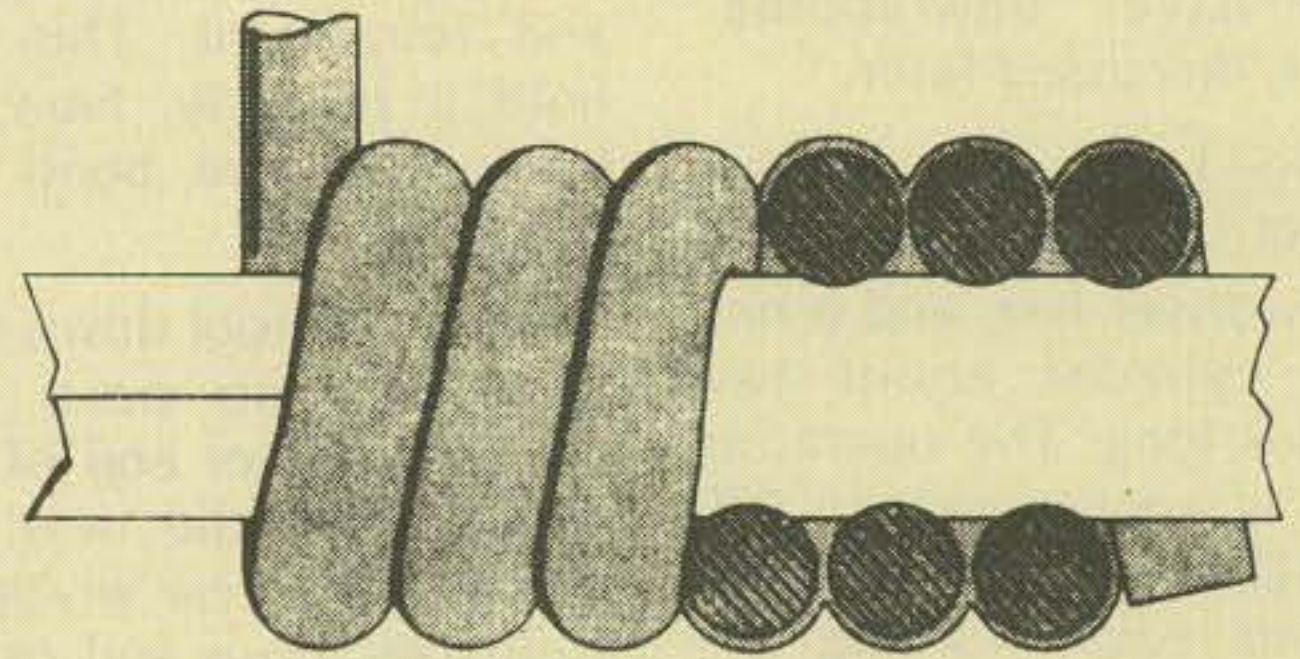

Fig. 9. Cross-section of "Slit-n-Wrap" connection (Vector).

advantage of wire-wrapping shortcuts (or, the circuit paths may suffice). A component carrier looks like an IC with the "lid" off, has wire-wrap terminals in this case, and on the open top surface has solder terminals to accept resistors, etc.

Sockets are also available for SCRs, transistors (all cases), and other components.

At least one manufacturer produces these boards with card connector terminations on one edge. This makes each board a separate entity within a system, with only the edge connector receptacle wiring between boards needed to complete the system.

End connector boards, by the way, frequently develop open circuits between the card and the connector. This can usually be corrected by removing the card and then reinserting it. If this doesn't work, the edge connections should be cleaned with alcohol, or even with a soft pencil eraser.

Component boards, made up of either epoxy paper or epoxy glass, use no

copper etching paths except possibly as an edge connection. Typical of these boards is the one shown in Photo C, again manufactured by Vector under the name "PLUGBOARD." As in the case of etched boards, this carrier has 0.042-inch holes on 0.1-inch centers. A great deal of flexibility can be used in making prototypes with these boards, as parts of any reasonable physical size may be placed on them. They also have the advantage of being less costly than etched boards.

Wrapped-wire-type square pins are obtainable to insert into the holes on component boards or to use as parts holders or connecting points.

#### Wire-wrapping Problem Guide

Causes and cures for wire-wrapping problems have been mentioned throughout the preceding paragraphs. These have been summarized in Table 1. If you encounter difficulties in your initial wire-wrapping endeavors, check the table to analyze your problem. ■

# Clegg is VHF Headquarters!

SELECTED PRODUCTS FROM CLEGG AND FRIENDS!!

## CLEGG FM-88

Fully synthesized  
143-148.995 in 5 KHZ steps.  
CAP & MARS coverage  
Variable power (1-25w)  
1 year warranty

## CLEGG FM-88S

All of the great features of the FM-88 Plus  
800 channel programable scanner

## CLEGG MARK-3 & FM-76

12 channel crystal controlled  
MARK-3 — 146-148 MHZ  
FM-76 — 220-225 MHZ

## CLEGG POWER SUPPLIES

Four popular models  
PS-7A-7 Amp  
PS-12A-12 Amp  
PS-20A-20 Amp  
RS-35A-35 Amp

## CLEGG ALL BANDER AB-144

Converts your "ALL-MODE"  
2 meter transceiver to General  
Coverage Receiver.  
100 KHZ to 30 MHZ

## CLEGG TT-2

Solid State Touch Tone encoder featuring  
automatic transmitter keying.

ANTENNAS BY:

ASP, CUSHCRAFT,  
HUSTLER, KLM, TONNA

AMPLIFIERS BY:

MIRAGE AND  
KLM

POWER METERS BY:

MIRAGE

SSB TRANSCEIVERS BY:

ICOM AND YAESU

HAND-HELDS

YAESU & WILSON

ROTATORS, TOWERS

& CABLES

ALLIANCE

CONSOLIDATED

TIMES WIRE

BERK-TEK

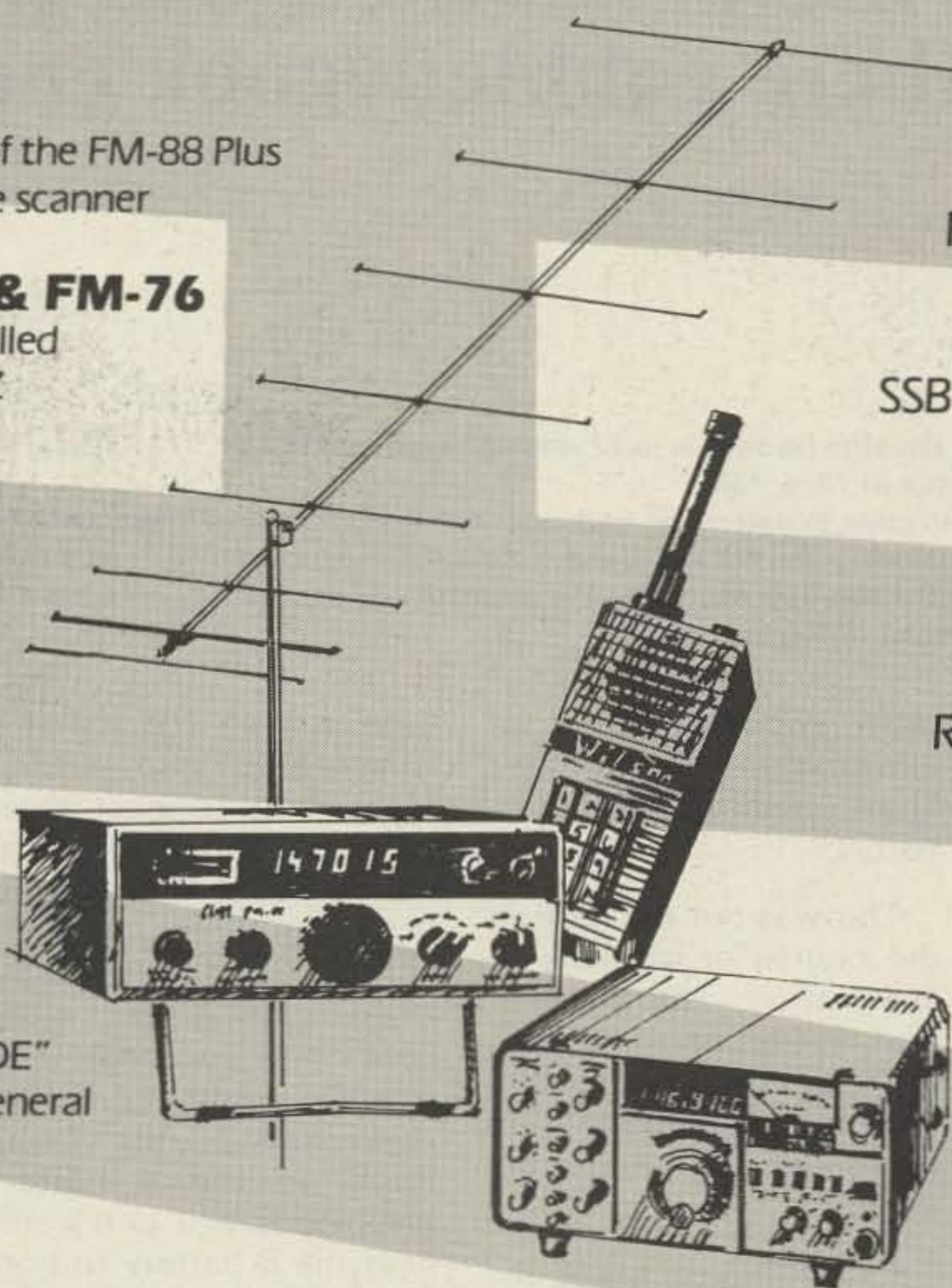

CALL OR WRITE FOR DESCRIPTIVE LITERATURE:

**IF YOU'RE GOING TO DO IT ON VHF  
YOU'LL DO IT BETTER WITH CLEGG AND FRIENDS!**

# Clegg

Communications Corp.  
1911 Old Homestead Lane  
Greenfield Industrial Park East  
Lancaster, PA 17601  
(717) 299-7221

✓ C31

# Working with Transistors

— useful knowledge begins  
where gobbledygook ends

**Author's Note:** This article was about to be sent in to 73 when an excellent article, "73 Reveals Bias," by Carl C. Drumeller W5JJ, appeared in the September, 1978, issue of 73, p. 136.

He used a method very similar to mine to determine transistor component values. There are differences in our approaches, though, and this article also covers material which he did not present. So, after talking with 73, it was decided to go ahead with this one, too.

I recommend that you compare the two approaches to the problem and particularly note the different choices we each made in circuitry as well as the similar pragmatic answers.

Some years ago, I was able to take the Navy's "two-pound" course in basic electronics. It starts with "this is an electron," and ends up with "this is a computer."

There was a full section on transistor theory and application. This was good, as I didn't know anything about transistors.

By some fluke, I completed that part of the course with a high score. I also came away with one

other important piece of information: I still didn't know anything about transistors.

This was not the fault of the course or my lack of application. The information was centered on having total control of specifications and technical information on the devices being used.

Out in the real world, the slide-rule approach simply would not work at all. I never could get all the info needed to work the formulas, and I still did not have a firm grasp of what I was trying to do.

Contrast the almost religious devotion to the slide-rule approach to transistors with the usual way one learned about tubes, as I was introduced: Here is a

tube (a type 30). It has a filament, a grid, and a plate. You connect three volts and a rheostat to the filament, like this, and the B battery to the plate circuit and one side of the filament, like this. Now, here's how you hook it up to make a radio (a one-tube regenerative set). Don't hook up the B battery backwards and don't connect the B battery to both sides of the filament or you'll burn it out.

That and a book of old tube circuits was about it as far as the theory was concerned. Then I was in business. The time required from start to finished product was the better part of an afternoon. If there was such a thing as the electron theory, parameters, and other assorted drivel, it was not men-

tioned and was not missed for some years.

A slight amount of reflection should yield the following: The 30 took two voltages. A transistor only takes one. Therefore, a transistor should be easier to work with than a tube. Why isn't it?

Basically the problem is gobbledygook—too many words got in the way. The transistor had to be sold as something new and different and an entire mythology was created to obscure everything about the transistor. You can hardly make head or tail of the little beasties. The nice thing to remember about transistor mythology is that most of it is bunk. What's needed is some how-do-you-use-it information and this is much easier to get than is commonly thought.

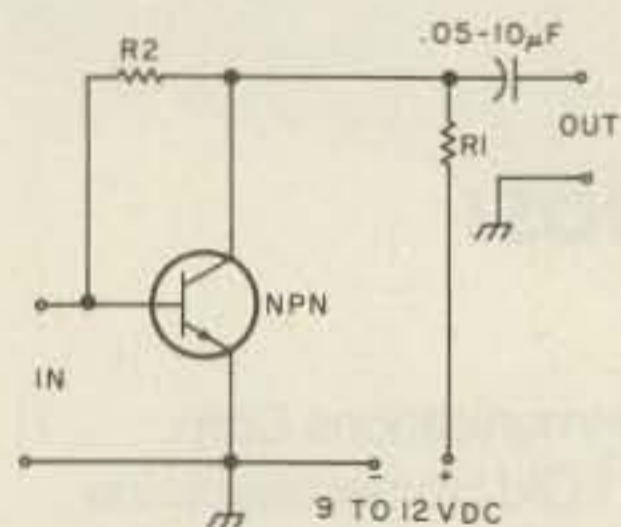

Fig. 1. Basic transistor voltage amplifier.



First of all, we need some parameters. What's a parameter? That's a catch-all phrase to cover all of the operating conditions of your pampered little transistor.

Tubes have parameters, too, only they don't know it. They have a maximum voltage for the filament, one for the plate, voltage limits between other elements, a maximum current, maximum signal input, etc. With tubes, it's no big deal, but with a transistor, everything gets a fancy title. Let's try and isolate what we need from the rest.

Transistors can work with one voltage. This is the supply voltage. It has a maximum value which the device can take. As with any device, but particularly with a transistor, you don't even want to come close to this. Figure a design maximum of 12 to 18 volts for most uses. The maximum rating is usually more. They also have a maximum current rating just like a tube does, but instead of the plate glowing cherry red and giving you a chance to shut it off, transistors go pffft the first time. Dead transistors are nature's way of telling you not to do that again.

While there are a myriad of transistor parameters available, the only other one that you need to know right now is the maximum voltage which can be applied between various elements. The next biggest cause of a terminal pffft, after too much collector current, is too high of a signal being applied to the base or emitter junctions. Too much signal will blow them. In time, you may want more parameters to play with, but those are enough for the cut-and-try experimenter.

There are reams of equations for determining all the resistance values in a simple transistor amplifier circuit. Since you probably

won't have the information you need for them, there has to be another way. At least this is what I thought after sitting and staring at my collection of unknown transistors. I had come through the course in fine shape but I sat there without the faintest idea of what to do. A few basics came to me. I had little information, my transistors were unknown, and what was the worst thing that could happen? I could blow out a nickel transistor. That's not too bad for some experience. But, as I worked on just how to do it, some of the course material trickled through to the top.

It is these cut-and-try basics which I will try to present as an organized approach to starting to experiment with transistors.

Transistors are of two main types, PNP and NPN. This refers to the polarity of the internal material. This is theory, but there are theoretical and pragmatic considerations which are important about this.

In many of the older types you might work with, the NPN version of an identical PNP type might have a higher frequency range than the PNP transistor. This might be important in some circuits. Also, the polarity of the device determines how the polarity of the supply hooks up. The NPN is the one which hooks up with the same polarity that you are used to with tubes.

The B+ goes to the collector (plate) and the minus goes to the emitter (cathode). This makes it easy to get it right. Also, a pragmatic effect which I noticed was that, in many cases, the identical circuit was far more stable using an NPN rather than a PNP. There is one mechanical disadvantage to working with NPN power transistors; this is heat sinking. Here the voltage polarity

works against you. It's nice to be able to work with the same voltage polarity as with tubes, but you pay for it when compared to the PNP.

With a PNP, the collector gets the minus voltage. With most power types, the collector is also connected directly to the case. With a PNP transistor, you can then mount the transistor directly on the chassis and also make the chassis be ground for your supply. A heat sink may or may not be needed, too, but it also can be grounded to the chassis directly.

With an NPN, you can't just do this. The usual method is either to use a transistor mounting kit with a mica washer and insulated hardware so that the transistor can still be mounted to the chassis, or to insulate the heat sink from the chassis.

I never was too happy with the washer method, and prefer the separate heat sink, but there is still a disadvantage to this: There then becomes a voltage difference between the chassis and the heat sink or transistor which might be a safety hazard. The best bet here is to shield the heat sink so that direct contact with it is avoided. You can connect the transistor directly to the chassis if you make your plus voltage the one which is grounded and leave the minus floating. If there is an internal supply for the unit, this is not hard to do. However, it is confusing, to say the least, and if there is other equipment connected to the unit, you may have conflict between various ground connections and power supplies.

For most breadboard use, I just used the transistor mounted on a big heat sink by itself. Connections were made by sloppy clip lead, anyway, so the problem of mounting the transistor in equipment never came up. It worked

for test purposes. If I wanted to produce a finished circuit, I would go for the insulated heat sink and shield it mechanically so that there would be no shock hazard.

There may be times when a special purpose needs a PNP transistor, but for starting out and most uses, divide your transistors first by NPN and PNP. Then put the PNP transistors away where you will not be tempted to use them. The remaining NPN types can be roughly divided into three important main categories. These categories reflect both a basic application and a rough measurement of their power-handling abilities. The three categories are: small signal—up to 10 mA of current, general purpose—10 to 100 mA, and power types—100 mA and up.

This disregards the distinction between audio, rf, switching, or other special-purpose types. It does, though, give a rough guide for immediate application and to introduce a way of thinking. Your two basic immediate needs are to see that the device does not have its ratings exceeded, and to see that it is not overdriven.

To start with a mostly-unknown transistor, assume that it is a small-signal type. By the way, many large-signal or higher-power devices can also be used for small-signal use, and do a very good job. The basic transistor amplifier circuit is usually

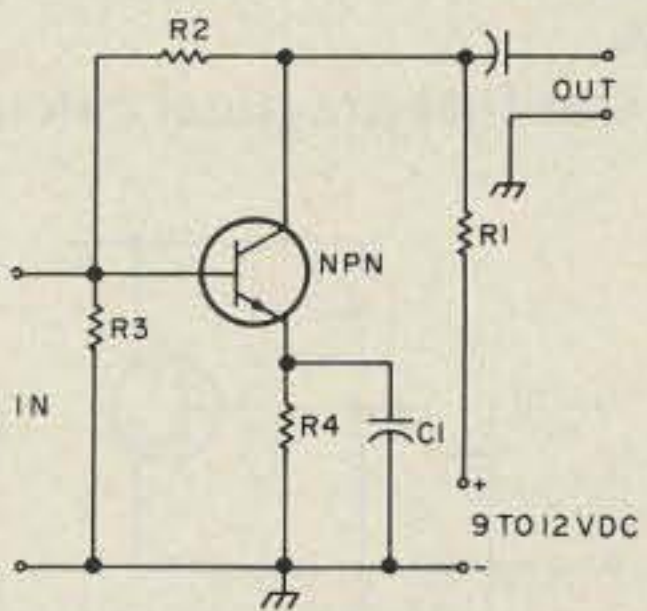

Fig. 2. Complete textbook circuit.

a small-signal application, both in audio and rf. It makes an ideal place to start.

Some equipment will be needed for experimentation. Besides the usual transistor hardware and parts, you will want an oscilloscope, a VOM, a resistance substitution box or handful of potentiometers or resistors, and a signal source.

Start with a microphone. It's safe. An FM tuner or audio signal generator would also be nice for further testing. An adjustable amplitude is highly desirable. The simple one-stage small-signal transistor voltage amplifier is a fiend to design by formula but it is quite easy to do pragmatically. This is where some of what the course taught me really helped. The basic circuit is shown in Fig. 1. R1 and R2 are the two key resistance values in the circuit. They will have to be arrived at experimentally but it is quite easy to do once you get the hang of it. The important thing is the safety of the device. Protecting the transistor is what takes up your time at the start and makes it seem a little clumsy to do.

According to theory, a class A transistor amplifier will draw half its allowable current at rest (no signal). The output signal goes above and below the midpoint. This gives us two assumptions. The first is that we are using a small-signal device (even if we are not). This also means that we are limited to 10 mA.

Our first practical calcu-

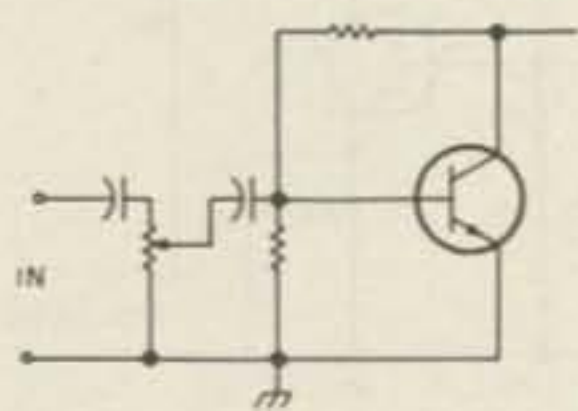

Fig. 3. Transistor volume control.

lation is a resistance value which will limit the current to 10 mA in the worst case, that is, if the transistor were a dead short. This gives you a value of R1. This is not critical, so pick the next highest resistance which you have if you can't get the exact value. Remember, this will not be the actual final value, but a working load resistance to start with which will protect the device.

In most cases, the actual value for best results will probably be much higher—similar to a triode tube voltage amplifier which usually has quite a high load resistance. However, start with the value derived in that manner. Hook up your VOM to measure the actual current at the collector. At this point, with one resistor, there should be no current. Without some form of bias to the base, the transistor should be cut off and no current should flow.

Now, take your resistance substitution box and, starting with the highest value at R2, click your way down until the transistor just starts to draw some current. At this point, there should be some indication that the circuit is functioning. Use your mike and a sensitive range on your scope, and watch the waveform. I also used the output from an FM tuner. Even at these low levels, I got an indication of circuit function and could see obvious distortion or clipping. The circuit should work, but not too well. Here is where the fun starts.

Replace the substitution box with a fixed value at R2. Put the substitution box in place of the fixed value at R1. Starting at the original R1 value, increase it and see what effect it has on the signal. You should get more amplification and less distortion up to a point. If you don't, try go-

ing a few clicks in the other direction, but watch the meter. When you get better results, replace the box with the appropriate fixed value and go back to R2 with the substitution box and see what effect changing that will have. A simple circuit like this should have quite a range of practical values over which it will work. It should only take a few back and forth trips to make an optimum choice.

At this point, you have a working amplifier. Usually there are a few more resistors which get put in the circuit for stability or other reasons. These get put in last. They are shown in Fig. 2. R3 is not critical. There is a simple formula for doing it by math: R3 is usually about 1/10 the value of R2. R2 and R3 act as a voltage divider and also help to tame the base-emitter circuit by providing a load to help limit current flow in the circuit.

When you have the basic circuit going, just hook up the substitution box and see what effect different values of R3 have to the actual signal. Start high, and as you click down, the signal will begin to be attenuated by the resistance. At that point, or a little lower, is the point at which you want to stop.

R4 is another matter. It is something like a cathode resistor but it doesn't work the same way. It also has a stabilizing effect on the transistor circuit, and helps limit the current of the stage. It also may have the effect of permitting a wider range of input signal without distortion. That doesn't mean you can exceed the element-to-element rating, but, as with tubes, the added bias can place the signal on a more favorable part of the current curve.

Use your scope and a variable input. The values are quite similar to the

tube values, several hundred Ohms, with 1000 and 2200 Ohms used quite commonly. Watch the scope and see at what point your signal starts to distort or clip. Put in the resistor and see what effect the values have on the signal. If there is an improvement, increase the signal to get the distortion again. Try different values and see what that does. You may want to go back and try some new values for R1 and R2 at this point, too. However, R4 will probably be a minor factor in the overall amplifier circuit.

As with vacuum-tube cathode resistors, the emitter resistor is usually bypassed. This is a husky electrolytic often in the same range as those used with a tube. 20 uF on up to a few hundred uF are common values. When the resistor is not bypassed, it also has some degenerative effect. The output will be less, but you will also get the stabilizing effect of an emitter which is not bypassed. You can see the difference on the scope as you try different resistance values or bypassing. Just play around with a few electrolytic values and watch what happens.

The main killer of transistor circuits is heat. They have the habit of drawing more current as they warm, which makes them warmer and they draw even more current, and pffft. If you work well within the ratings, you should have little trouble. Most devices are run too close to what they can handle.

The only other thing is to keep it from becoming externally heated. Don't put the transistors right over the power transformer. Allow room for ventilation. If you avoid extremes of both heat and cold, you should get reliable results with this circuit. The only way to assure operation at temperature extremes is to test

your circuit at the temperature extremes which you will normally encounter. Use husky transistors and parts and derate them for extremes. With care, this should not be any great problem.

Input and output circuits provide little problem with this stage. Capacitor coupling is easy and common with such a circuit. The value is not critical. 10  $\mu$ F, or so, is a common value.

The real stinker is the volume control. You can't just hook up an audio-taper pot in place of R3. When you turned it down, it would become a dead short across the emitter-base junction. A circuit such as that shown in Fig. 3 will do the job. A few extra parts are quite cheap at transistor power levels.

You can use one or two stages which are similar for an audio amplifier, depending on how much amplification is needed. The output will be high impedance and will drive a high-impedance pair of headphones with sufficient volume. More stages can lead to troubles such as feedback or motorboating. There are two things at work here. The higher gain of cascade stages is a troublemaker and the additional wiring picks up anything.

Driving a speaker is not hard to do either, if you are not overly squeamish. Much attention is given to proper impedance matching with transistors. If you can just ignore that urge, you should be okay.

Start with the circuit of Fig. 4. The transformer should be a medium-to-low-impedance transformer. It probably should be critical, but I have used anything from a 48-Ohm c-t transistor output type to a replacement tube type. Use the 8-Ohm output and whatever primary you have to start with. Here you just

do the same thing that you did with the load resistance procedure. Adjust R1 with one eye on the VOM, and listen to the output.

It would be assumed that you would start with an audio power type, not a small-signal type. Then start drawing some current and listen for what you get. This circuit will not be the most efficient, but you will be surprised just how loud even a small amount of audio can sound.

I found that an amplifier in the range of 200 mW to a Watt, or so, was quite practical with this sort of set up. In fact, I even hooked the speaker coil in alone in place of the transformer. I don't recommend the practice, though. It's too easy for the steady dc current to exceed the rating of the speaker winding, and burn out an expensive speaker. It does improve the frequency response, though. With care, even with a junk-box transformer, there will not be any serious loss for communications use, and even music may be acceptable.

It is always stressed that the transistor is a current-operated device; you always get current ratings but little is said about voltage. Your total output power is the signal voltage times the current through the impedance which you are using. The value can be found by Ohm's Law.

For example, the measured output voltage across the speaker winding divided by the impedance gives you the current (ac). The voltage is again used to calculate your power output. Or, even easier, use  $P = E^2/R$ .

It usually is thought that you get more output if you can get the transistor to deliver more current to the speaker coil. It's a nice theory, but just drawing more transistor current doesn't automatically deliver more output. As effec-

tive output goes up, so does the output current and the output voltage. At no point can the effective output voltage exceed the actual supply voltage to the transistor. It usually will be somewhat less. While your formula sounds great that 12 volts at 2 Amps would give you 24 Watts, at twelve volts, the transistor may not deliver that two Amps.

Enjoy the extra safety margin. You can get enough from just a simple power stage to hurt your ears at close range. Here, too, watch the scope for distortion. Measuring your output voltage values will give you the full story. When you drive the transistor to its supply voltage, you get clipping and distortion.

A common thing with transistor amplifiers is direct coupling between transistors. This is one of the all-time headaches to design and debug. Or repair, if it comes to that. Without going into convulsions on how to do it, there is one basic circuit configuration which is easy to play with, shown in Fig. 5.

Q1 and Q2 can be small-signal types. Q3 is shown as a 2N3055, which is quite common. I have used three 2N3055s and a number of oddball combinations. Try for some sort of method to your choice.

There is one important consideration you should keep in mind when working with power transistors. They are very rugged current-wise when compared with the smaller ones, but many of them can only accept a small input voltage without damage. Many which I worked with would only take about four volts between emitter and base. Many small-signal types would take 35 volts between emitter and base. That's a very strong case for using small-signal types to drive the power stage for

you. Also, in many cases, the small-signal type will be more sensitive to weaker input signals.

An FM tuner is a high output signal source. So may be the output from a detector in a receiver. However, in a simple set, the audio stages may have to supply some of the small-signal gain needed for the set. Try some combinations when you work with these circuits so that you get a feel for different operating conditions.

I have worked with many sets which had impressive bench test specs, but on-the-air tests with weak signals showed the importance of real sensitivity to weak signals and the effect small amounts of change in distortion, clarity, and other conditions have. You just do not notice these effects without real on-the-air testing.

R1 is chosen the same way as in the first amplifier: first for the current, and then for the sound. This amplifier is about the simplest "complex" amplifier that you can build. The first two stages are working as voltage amplifiers and the last is the power output stage. This circuit will also work well with just two transistors if less pre-amplification is needed.

I did not build these circuits into any equipment. I just used these circuits to learn on. However, I found even the simple circuit like Fig. 5 to be quite stable. I had it running on the bench for hours at a time as an amplifier for an FM tuner, and most of the other successful circuits worked

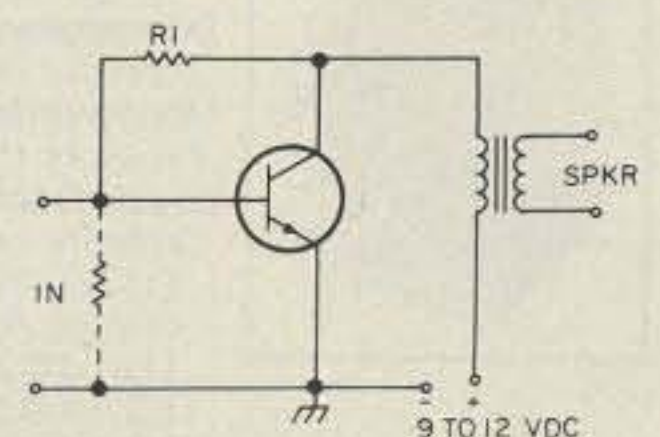

Fig. 4. Basic transistor power amplifier.

well with no problems. Even without all the resistors which a classic circuit is supposed to need for stability, they just sat there and worked for hours on the bench.

I think the key is to pick husky transistors and run them very conservatively. The power amp only draws a few hundred milliamps resting, if that, and the first stages use a tiny amount of current. However, as stated earlier, many of these stages were tried with the PNP transistors

which were exact equivalents, and there was trouble. It appeared to be thermal runaway. The stage would start drifting into a higher-current condition and then I would get distortion and other problems.

There did not appear to be an easy fix for this condition. Even though the circuit could be stabilized so that it would not draw dangerous current, it was not tame, which means it's not reliable. And yet the same circuit with NPNs was a joy to work with. Stay away

from PNPs. They will lead you into trouble.

There are a number of other simple configurations which can be done with just a few transistors. Any good transistor manual should have a number of basic circuits which can be tried.

There are also combination circuits using both NPN and PNP transistors tied back to back. Stay away from the more complex direct-coupled circuits with lots of components, dual power supplies, and the like. You get into servicing and reliability problems which you really don't need.

I found that none of the other simple combinations which I tried really gave me anything which these simple circuits didn't. There were differences in operation, but they were not significant for any normal use which I wanted to make of the circuit.

By the time you have played for a few weeks or a month with these simple circuits, you should have gotten over the fear of transistors. Then you will have built-in safety procedures to use when you are breadboarding, and it should not be hard to progress to more specialized simple circuits such as i-f amplifiers or rf circuits.

If you play by the important transistor rules and ignore many of the rest at first, you can learn a lot about the exact function of the circuits, how to get them going without formulas, how to deal with parts substitutions, and how to get wide operating tolerances.

You will learn to see what is actually happening inside the circuit as you make changes. The faults you find will also help you to debug other circuits which you may work with. ■

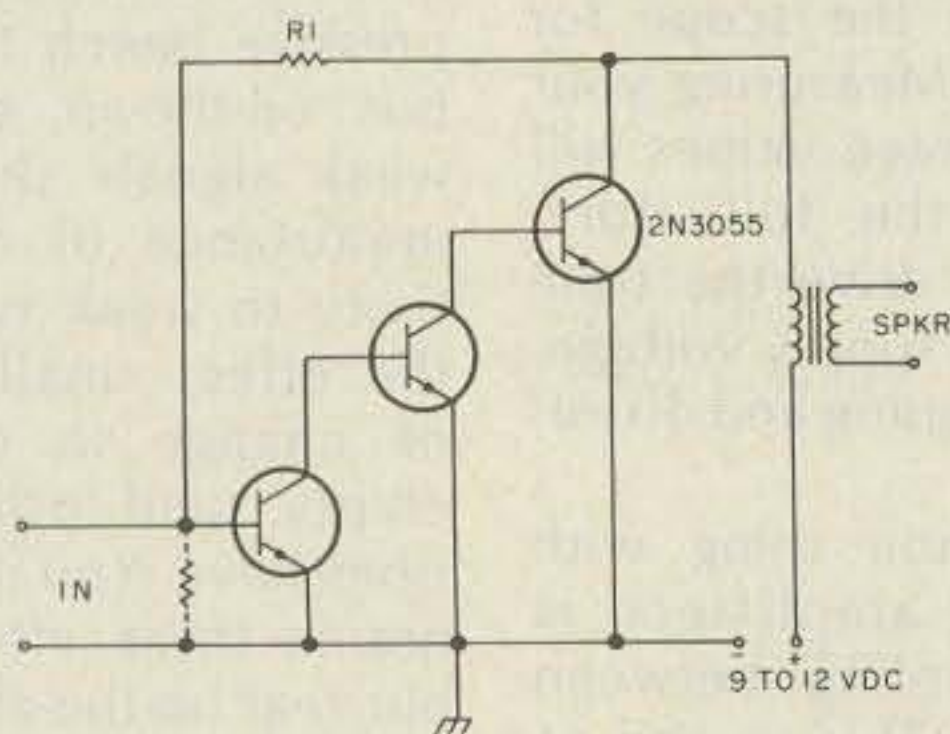
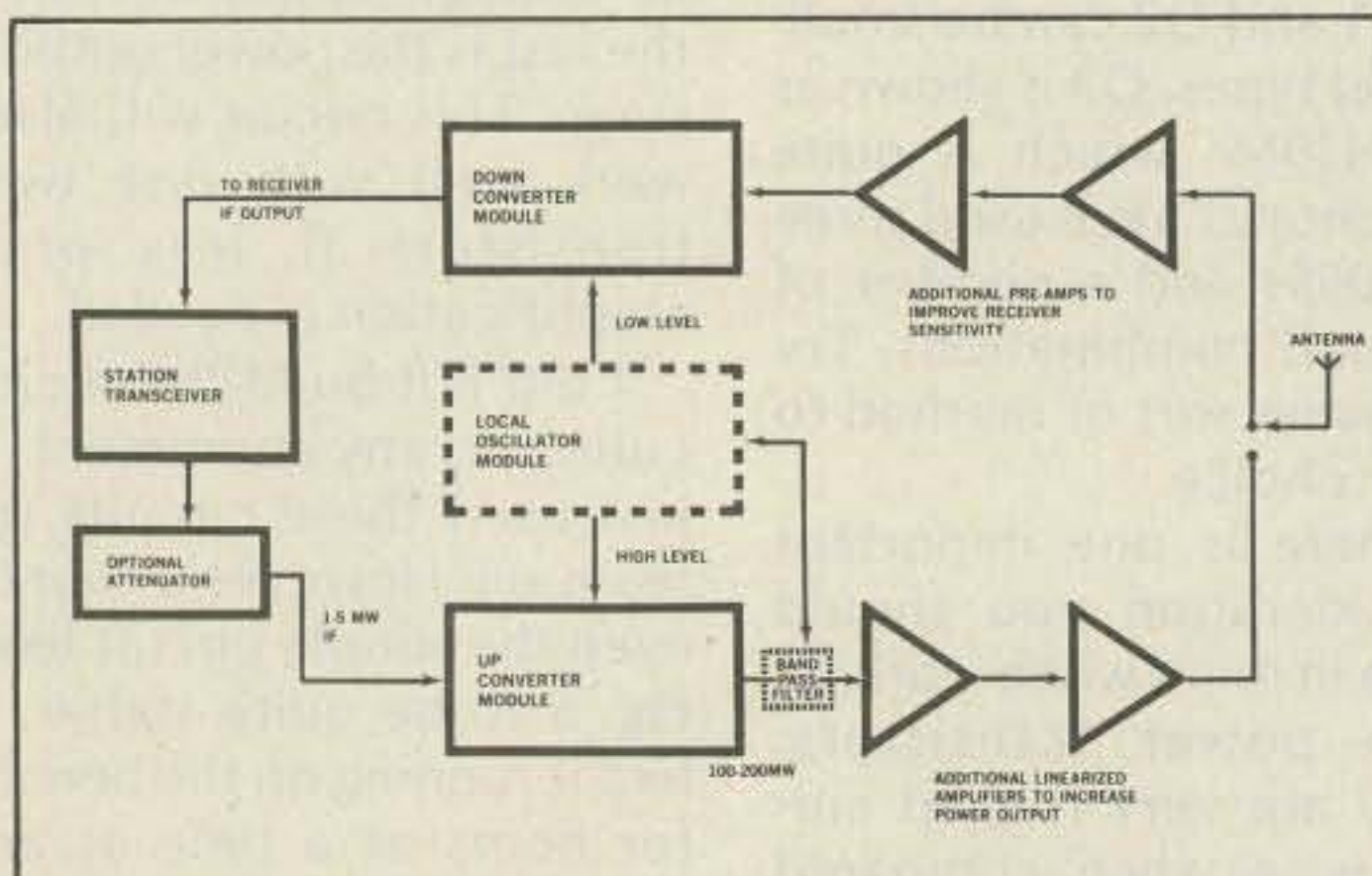

Fig. 5. Simple multi-stage power amp circuit.

# 1980 is the year for 220MHz AND LUNAR CAN PUT YOU THERE!



HERE AT LAST - modules for transverter system development. Lunar's line of modules allow complete system flexibility in achieving multi-band VHF/UHF state-of-the-art capability. By combining appropriate modules, EME capability is readily achieved. The 100% successful K6LEW 144 MHz DX-peditions to Delaware & West Virginia in Fall '79 attest to the module's capability. Converter NF of 1.6 dB and overall NF of 1.3 dB with preamp gave outstanding copy of EME signals using just four antennae. The basic system is the Downconverter module and the Upconverter module selected to suit your IF requirement. Adding the appropriate Local Oscillator/Filter module puts you on the desired band. Changing LO modules changes bands - thus retaining the converter modules. The basic system yields approx 6 dB DSB NF and 200 mW RF output (1-5 mW drive at IF). Adding preamps to receive side will yield desired NF, while adding power amplifiers on output will yield desired power level. Filters utilize microwave techniques, including printed capacitors. The LO modules are dual frequency with IC oscillator/multiplier stage, .001% crystals for maximum stability and dual output power levels for both low and high level mixers. The LO outputs are filtered and all non-desired signals are less than -50 dB below LO. Downconverter uses broadband DBM with an integral low noise preamp stage and bandpass filter. The Upconverter use a high level DBM and a broadband linear 30 dB gain module yielding 200 mW *linear* output, with 1-5 mW drive at IF required. System interconnects utilize high quality SMA-type connectors, while input/output to your system are BNC. Power amplifier modules due in early '80 boost the 200 mW to readily desired levels.



### Availability listing for modules:

\*1 qtr '80; \*\*late 1 qtr '80; \*\*\*2 qtr '80

**Downconverter Modules:**

(specify IF) Model DC-28, DC-50\*, DC-144\*

**Upconverter Modules:**

(specify IF) Model UC-28, UC-50\*, UC-144\*

**Local Oscillator Modules:**

(specify output band/IF) Models:

LO-50/28, LO-144/28, LO-144/50\*

(single freq models)

LO-144/28/2; LO-220/28/2; LO-432/28/2;

LO-144/50/2\*; LO-220/50/2\*; LO-220/144/2\*\*;

LO-432/50/2\*\*; LO-432/220/2\*\*



Louis N Anciaux  
WB6NMT

2785 Kurtz Street, Suite 10  
San Diego, CA 92110  
(714) 299-9740  
Telex 181747

### Power Amplifiers Modules:

10 W PEP output from 200 mW UC module for each band — these modules due 2nd qtr '80

### Attenuator:

Model AT-33; 33 dB 10W attenuator for reducing 10W rigs to 5 mW IF level.



Check 73's New Product Review (July '78)

Well known 10 and 2 meter DX'er Gordon West, WB6NOA, comments: "Since I switched from the gray loading coil system to the Metz, my mobile range has been substantially improved. I run a half gallon on both 10 and 2 SSB mobile, and after an hour of operation the Metz coil is barely warm! With the 'gray loading coil' antennas, they would be hot. Whether it's less I'R losses or just plain good construction, the Metz out-talks them all!"

Julie Metz

2 Meter and 70CM come pretuned.

No cutting required and needs no ground plane.

# Lifetime Coil Guarantee!!

### MOBILE 10

- 17-7 PH Stainless Steel Tapered 54" Whip—Deflects easily when struck—Minimum wind deflection—cut in field to match ground plane variables.
- 150 Watt capacity
- Unique dual-angle radiation pattern is ideal for groundwave communications as well as skip propagation.
- Minimum SWR at Band Edges
- Frequency Range 28-29.7mc

### MOBILE 2

- 17-7 PH Stainless Steel Tapered 42" Whip—Deflects easily when struck—Minimum wind deflection.
- No ground plane required.
- 200 Watt capacity
- Low angle of radiation for repeater and Simplex operations.
- Low SWR across entire 2-Meter Band—Excellent for existing and new repeater channel operation
- Frequency Range 144-174mc

### MOBILE 70CM

- 17-7 PH Stainless Steel 14" Whip
- 200 Watt capacity
- No ground plane required.
- Low Angle of radiation maximizes performance to hilltop remote base stations
- Designed for uplink and direct communications.
- Frequency Range 430-470mc



**METZ COMMUNICATION CORP.**

Corner Route 11 & 11C  
Laconia, New Hampshire 03246  
Tel.: 603-524-8806

M100

### PRICING (Any frequency)

- Coil with 90 lb. pull Mag Base \_\_\_\_\_ \$49.95
- Coil with Thru-Vehicle Mount \_\_\_\_\_ 39.95
- Coil with Right Angle Bracket \_\_\_\_\_ 34.95

Enclosed \$ \_\_\_\_\_  Check  Money Order

Master Charge  VISA

Credit card # \_\_\_\_\_ Exp. date \_\_\_\_\_

Name \_\_\_\_\_

Address \_\_\_\_\_

City \_\_\_\_\_ State \_\_\_\_\_ Zip \_\_\_\_\_

Signature \_\_\_\_\_

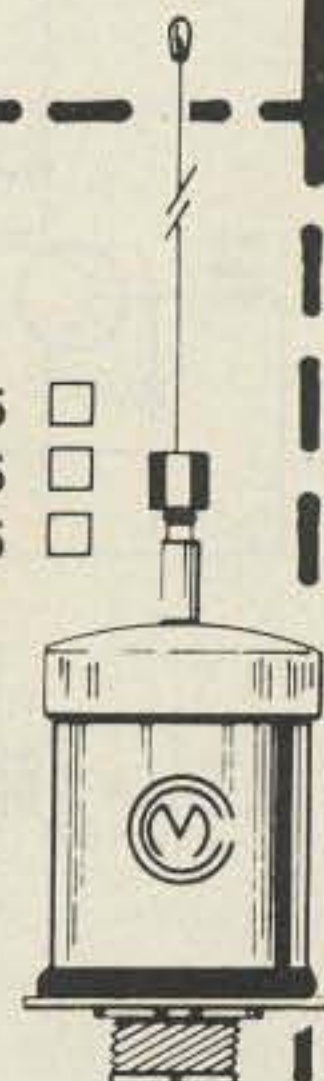

# A Digital Clock with Analog Readout

— this is progress?

G. Windolph W9IEA  
PO Box 3305  
1901 N. 18th St.  
Quincy, IL 62301

The clock described here brings you the best of two worlds—the digital and the analog. It combines the reliability of the no-moving-parts, all-electronic clock with the instant readability of a clock with hands.

I built this clock for two main reasons. In the first

place, I wanted an all-electronic clock that I could read from a distance of three or four feet in the dark without my glasses. If you happen to be as myopic as I am, you know that the ordinary digital clock might as well be just a night light after you have retired and have put your glasses on the shelf. This clock face can be as large as you wish.

In the second place, I wanted a clock that gives

the instant readout of the old-fashioned clock with hands. One swift glance at an old-style clock and you know immediately how close you are to that 1:00 deadline. With the ordinary digital clock reading 12:53, it takes a bit more than a quick look to tell you that you've got seven minutes left. There's something about a clock with hands that makes 8:20 look like "twenty after eight" and 8:40 look like "twenty to

nine." This visual shift doesn't occur with a digital readout. I suspect that this is one reason why Texas Instruments has come out with an analog readout on a digital watch. I predict that the clock-makers will follow suit. Even if you're not a nearsighted clock-watcher, you may find this project to your liking.

## General Description

Two concentric circles of discrete light-emitting diodes form the "hands" of this clock. The outer circle is for the minute hand; the inner circle, with a diameter about three-fourths that of the outer one, is for the hour hand. One LED in each circle is on at any given time. Another, LED5, is on continuously at the center of the circles to act as a visual point of reference so that the eye somewhat automatically constructs each hand of the clock out of the central LED and the peripheral minute or hour LED. As additional reference points, particularly for nighttime viewing, there are blinking LEDs (1-4) of a different color located at 12:00, 3:00, 6:00, and 9:00. They show that the clock is running. They also are used in setting the clock, as is explained later.

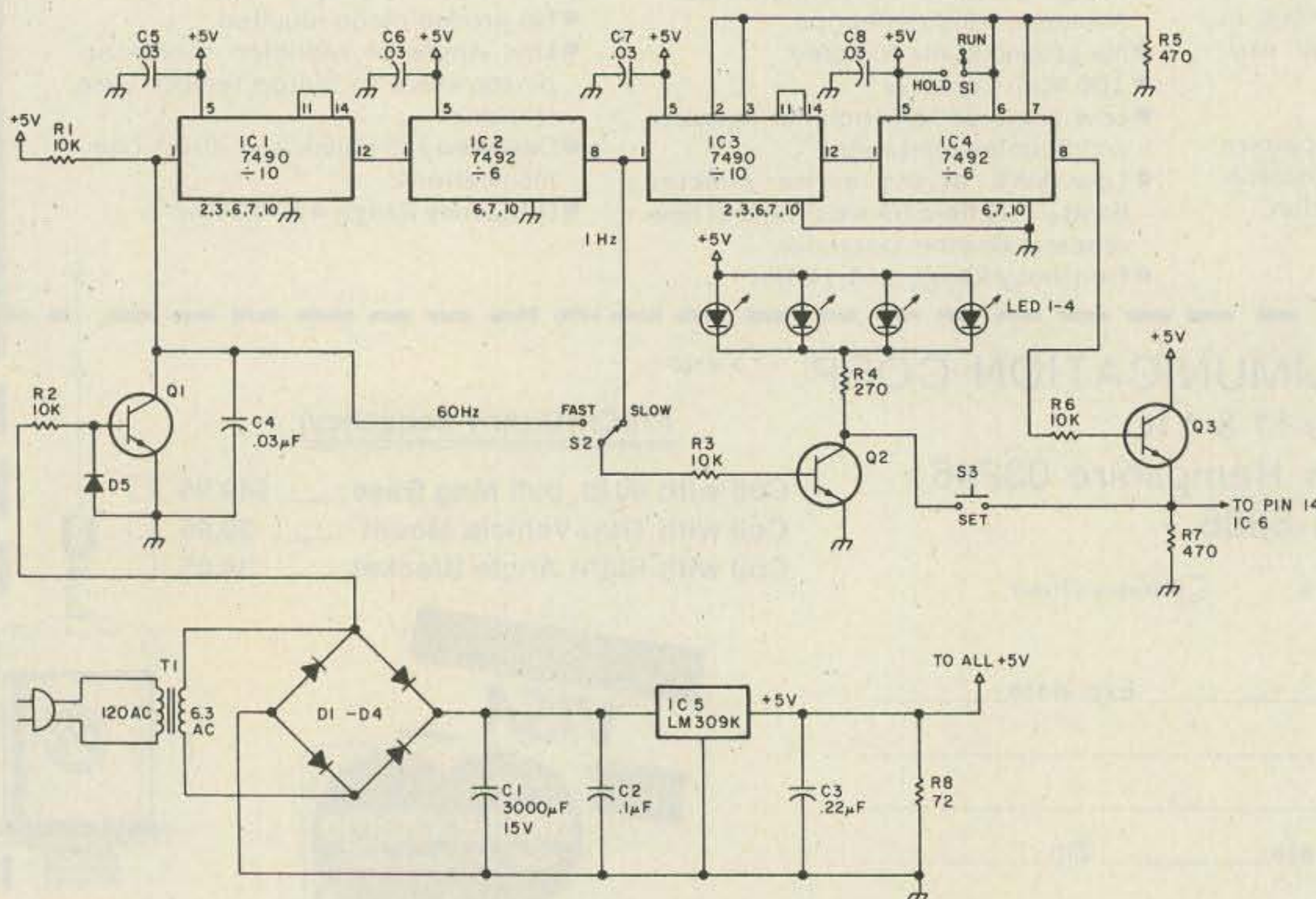

Fig. 1. Power supply and timing circuit.

A one-pulse-per-minute signal operates the clock. A one-pulse-per-second signal shows that the clock is running and, along with a 60-Hz signal, is used to set the clock. The 60-Hz signal is obtained from the collector of Q1, which squares up the sine wave to operate the TTL integrated circuits. This frequency is divided by 10 in IC1 and by 6 in IC2 to give a 1-Hz signal. This is again divided by 10 and 6 in IC14 and IC15 to produce the one-pulse-per-minute signal that operates the clock.

The 74154 integrated circuit is a 4-line-to-16-line decoder. For any binary number from zero to fifteen on input pins 20 to 23, one of the sixteen outputs goes low and turns on one LED.

Since there are 60 LEDs for the minute hand, we need four of these ICs. Only one of them is enabled at a time, by a low on pins 18 and 19. The other three are turned off by a high on pin 18 or 19. The 7493 counter, IC6, puts out the binary numbers from 0 to 15 in sequence when pin 14 is pulsed once per minute by IC4. Q3 isolates IC4 from the setting signal. The binary numbers are fed to all four decoder ICs. The one which will give a readout is determined by the 7476, IC7. This is a dual J-K flip-flop which is made to flip every time a negative-going pulse comes from pin 11 of the 7493. This pin contains the most-significant bit of the binary output, and it drops to zero when the output goes from

15 (1111) to 0 (0000). The 7476 puts out a low on the following pairs of pins in sequence: 11 and 15, 11 and 14, 10 and 15, and 10 and 14. These pairs then enable IC10 to IC13 in sequence, and one LED lights up as determined by the binary number on pins 20 to 23. The other 74154s are inactivated since they have a high on pin 18 or 19.

With 64 outputs but only 60 minutes per hour, the last four outputs are unused, and the minute hand would disappear for four minutes if IC13 were enabled for its full count. To prevent this, IC6 must be reset to zero after the 59th minute. The low appearing at the 60th minute on pin 14 of IC13 is inverted by one

section of a 7400 and fed to pins 2 and 3 of IC6. This resets IC6 so that its output goes from 1100 back to 0000. The negative-going pulse on pin 11 clears IC7 so that pins 11 and 15 are both low again and IC10 is enabled to begin the first minute of the next hour.

The hour hand functions similarly but we don't need as many LEDs. Twelve would not suffice since there would be a period of ambiguity depending upon when the hour hand jumped to the next hour. One could, of course, use 60 LEDs. I settled for 24, which is sufficient to prevent any ambiguity. When the clock is set on any hour, the hour hand stays on the hour until the beginning of the 16th minute after the

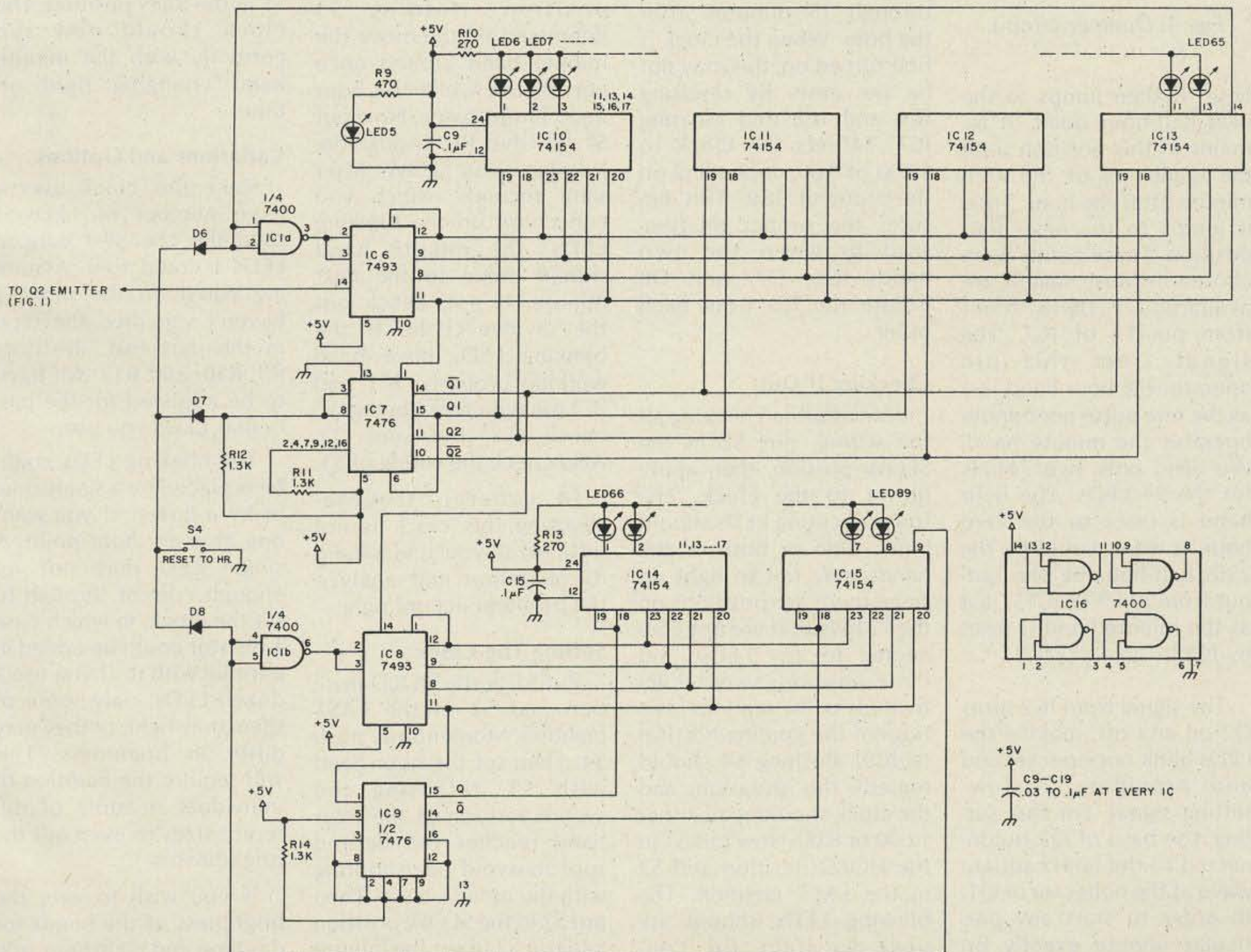

Fig. 2. Readout circuit.

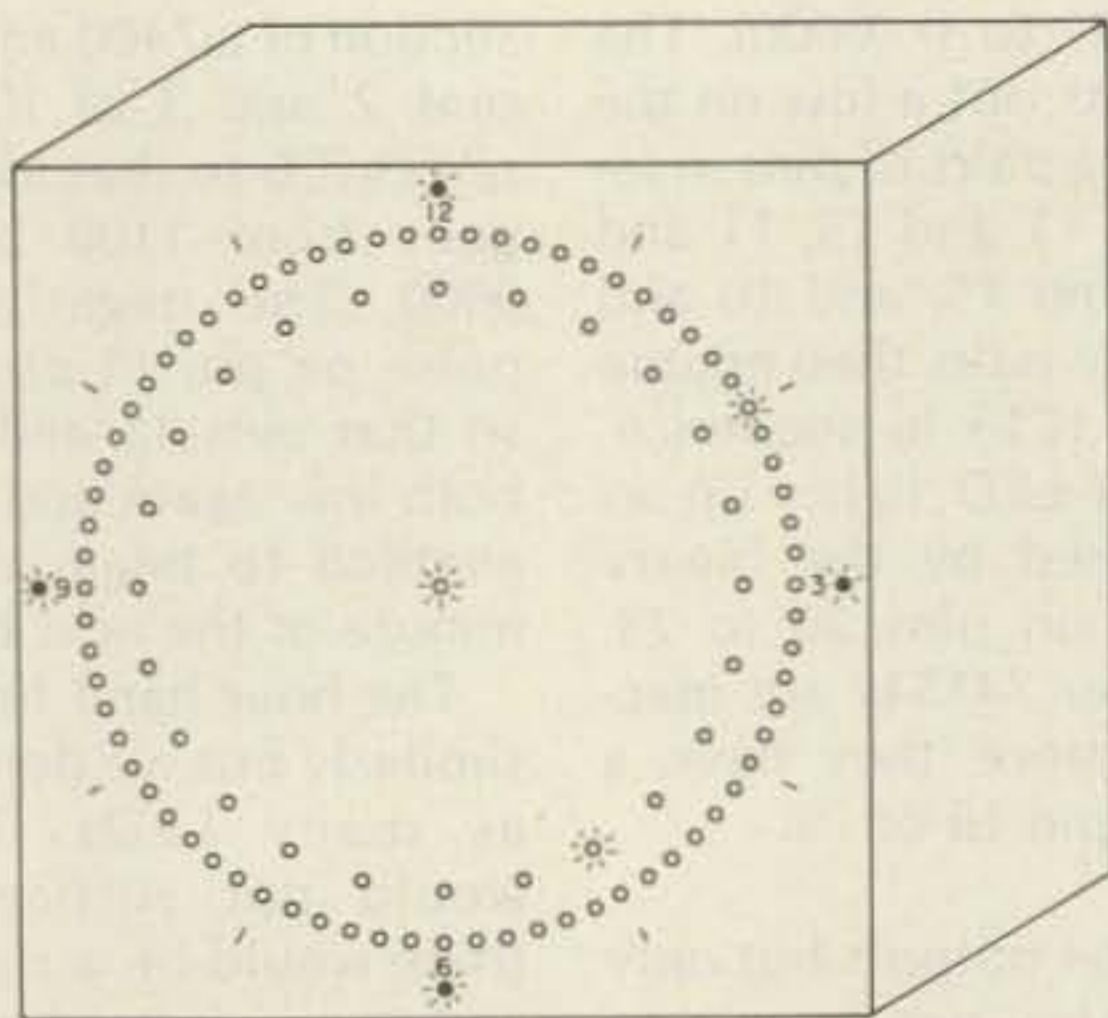

Fig. 3. Face layout.

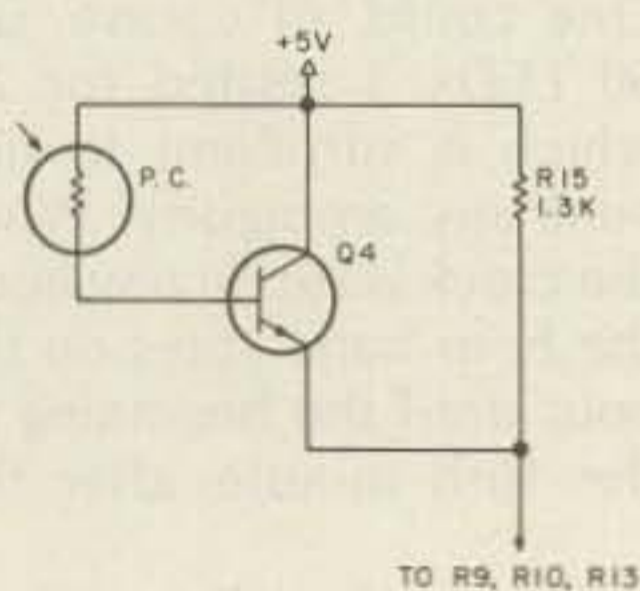

Fig. 4. Dimmer circuit.

hour. It then jumps to the next half-hour point. It remains in this position until the beginning of the 48th minute after the hour. Then it jumps to the next hour position. These points were chosen because signals are available at these times from pin 14 of IC7. The signal from this pin operates the hour hand just as the one-pulse-per-minute operates the minute hand. We need only two 74154s for the 24 LEDs. The hour hand is reset to the zero hour at what would be the 25th half-hour by the output from pin 9 of IC15, just as the minute hand is reset by IC13.

The signal from IC2 turns Q2 on and off, making the LEDs blink once per second and providing a slow-setting signal. For fast setting, the base of Q2 is connected to the 60-Hz square wave at the collector of Q1. In order to start any particular minute exactly on time, IC3 and IC4 are set to zero by S1 which puts a

high on reset pins 2 and 3 and 6 and 7, respectively. This keeps the output of IC4 low so that the setting signal from Q2 can pull pin 14 of IC6 low.

The hour hand should be on the hour from 12 minutes before the hour through 15 minutes after the hour. When the clock is first turned on, this may not be the case. By resetting IC6 and IC8 and clearing IC7, S4 sets the clock to 12:00 or 8:00, depending on the state of IC9. This ensures the proper relationship between the two hands. D6, D7, and D8 isolate the ICs from each other.

#### Checking It Out

After double-checking all the wiring, put S2 in the SLOW position, then apply power to the clock. The four indicating LEDs should blink. One or both of the hands may fail to light up since there are positions on the 74154s that are not connected to any LEDs, and these positions may be activated with random settings of the guiding ICs (IC6 to IC9). Pushing S4 should remedy this situation, and the clock should read either 12:00 or 8:00. Now put S1 in the HOLD position and S2 in the FAST position. The blinking LEDs should appear to light up continuously since they are now blinking at 60 Hz.

Pressing the set button, S3, should make the minute hand revolve once per second and the hour hand jump twice per second. The latter should jump as the minute hand passes from 15 to 16 minutes after and from 13 to 12 minutes before the hour. If either hand doesn't go continuously around but skips whole sections, this would indicate a defect associated with one of the 7476s since they should sequentially enable the 74154s. If either hand disappears temporarily before the 12:00 point, this would indicate that the reset signal is not getting back to the 7493s. Check for a defective IC16, IC6, or IC8. I had a 7493 that counted beautifully but would not reset.

Now put S2 in the SLOW position. Holding S3 depressed should move the minute hand around once per minute while the hour hand jumps twice. Now put S1 in the RUN position, leaving S2 on SLOW. After sixty seconds, which you can count on the blinking LEDs, the minute hand should move to the next minute. If not, check out the divider chain. If the blinking LEDs have been working properly, IC1 and IC2 must be functioning, so check IC3, IC4, and Q3. Also check the wiring of S1.

In general, troubleshooting this clock is not difficult if you understand its operation and analyze the problem accordingly.

#### Setting The Clock

Put S1 in the HOLD position and S2 in the FAST position. Momentarily push S4. Then set the hour hand with S3, releasing the switch as soon as the hour hand reaches the desired spot to avoid overshooting with the minute hand. Then put S2 in the SLOW position and use S3 to set the minute hand to the next minute. In setting the minute hand,

you probably will find that the hand jumps a number of minutes when you first depress S3 or when you release it. This is due to bounce in the switch contacts. It can be prevented by watching the blinking LEDs and depressing and releasing S3 only when the LEDs are on. When the LEDs are on, the collector of Q1 is low and, since pin 14 of IC6 is also low when S1 is in the HOLD position, the setting switch cannot send in a series of pulses when it bounces. This method of setting is not difficult, but it takes a bit of practice since you have to watch the blinking LEDs and the moving minute hand at the same time. When your reference clock reaches the next minute and zero seconds, immediately put S1 in the RUN position. The clock should now run correctly with the minute hand changing right on time.

#### Variations and Options

Since this clock uses a large number of LEDs, I used the cheapest bargain LEDs I could find. Assuming you'll do the same, I haven't specified the type in the parts list. Resistors R9, R10, and R13 will have to be adjusted for the particular LEDs you use.

The blinking LEDs could be replaced by a single one, or by a dozen, if you want one at every hour point. A single LED may not let enough current through to set the clock, in which case a resistor could be added in parallel with it. If you use a dozen LEDs, only some of them may light, or they may differ in brightness. This will require the addition of individual resistors of different sizes to even out the brightnesses.

If you wish to vary the brightness of the hands for daytime and nighttime, add a resistor from +5 V to the common connection of R9,



# Key Electronics

## AUTOMATIC DIALING TOUCH TONE MICROPHONE

CES Model 235

- Stores 5 eleven digit and 5 seven digit phone numbers
- Programs and operates entirely from keyboard
- Programmable dialing rate
- Stores last manually dialed number
- Built-in speaker for tone monitor
- Programmable 2 second pause
- Automatic PTT 5 second before first tone



69<sup>95</sup>

### INTEGRATED CIRCUITS:

SN76477N	Complex sound generator	\$2.95
TL489C	Analog level detector	\$1.25
LM317T	Adj. volt. reg. 1.5 amp.	\$2.75
ICM7555	Low pwr. CMOS Timer	\$1.25
LF351N	High speed JFET Op Amp	.75
NE565	PLL	\$1.10

FREE: CA3140 with orders of \$5.00 or more

Please include \$1.00 for postage and handling

N.Y.S. Residents Add 4% Sales Tax

Send to: Key Electronics

P.O. Box 3506

Schenectady, NY 12303

✓ K14

# SCANNERS:

## KDK 2015R, KDK 2016A

## MIDLAND 13-510, 13-513, CLEGG FM-28

## YAESU FT227R, ICOM IC22S, KENWOOD TR7400A

### NOW INTRODUCING SCANNERS FOR THE KENWOOD TR7600 AND TR7625

- AED continues to expand its line of quality scanners. All of the above scanners are custom designed for their respective rigs.
- All scanners install completely inside the rig. No obtrusive external connections.
- All are easy to assemble and come complete with a detailed instruction manual.
- Scanned frequency displayed on digital readout (except IC22S).
- In the scanner OFF mode the rig operates normally. In the scanner ON mode the scanner locks on an occupied frequency, pauses for a preset time (about 5 secs.) and then resumes scanning.
- This gives you the ability to eavesdrop all over the band without lifting a finger. When you hear something interesting, you flip the switch to the LOCK mode and the rig is ready to transmit.

### AED SCANNER SPECIFICATIONS

	KDK 2015R	KDK 2016A	KENWOOD TR7600 TR7625	KENWOOD TR7400A	YAESU FT227R	MIDLAND 13-510 13-513	CLEGG FM-28	ICOM IC22S
SCAN RATE	Adjustable 100kHz/sec-1MHz/sec			50kHz/sec	200kHz/sec	100kHz/sec	100kHz/sec	100kHz/sec
SWEEP WIDTH	144-148 or only the mHz segment you select on mHz switch	142-149.995	complete band or mHz you want	complete band or mHz you want	adjustable eg. 146-148 144-146 146-147	scans the mHz seg. selected by the mHz switch	same as Midland	145.35-147.99
SCAN CONTROLS	2 mini toggle switches mounted on rig — LOCK switch may be mounted on mic.		2 mini toggle switches mounted on rig.	2 mini toggle switches mounted on rig.	1 mini toggle switch mounted on mic or rig.	2 mini toggle switches mounted on rig.	same as Midland	1 mini toggle switch mounted on mic or rig.
PRICE FOR KIT	\$39.95	\$39.95	\$39.95	\$39.95	\$34.95	\$39.95	\$39.95	\$34.95
PRICE PRE-ASSEMBLED	\$59.95	\$59.95	\$59.95	\$59.95	\$54.95	\$59.95	\$59.95	\$54.95

Add \$1.50 for postage & handling

DEALER INQUIRIES INVITED

✓ A60



## AED ELECTRONICS

750 LUCERNE RD., SUITE 120  
MONTREAL, QUEBEC, CANADA H3R 2H6  
TEL. 514-737-7293



### CONNECTOR ASSORTMENT

\$25.00 Postpaid      \$23.50 each lots of three

Includes: 5 - PL259, 5 - SO239, 5 - UG175, 5 - UG176, 2 - PL258, 1 - DM, 1 - M358, 2 - M359, 1 - UG255, 1 - UG273, 2 - PL259PO, 1 - 1021-20, 1 - Lightning Arrestor.

Master Charge & Visa accepted / Send for Free Catalog

COAKIT ✓ C21

P.O. Box 101-A Dumont, N. J. 07620

Circle C21 on Reader Service Card

# DUPLER & CAVITY DIGEST

- ★ 6 Meters, 2 Meters, 220 MHz, 450 MHz
- ★ CONSTRUCTION DETAILS, OPERATION
- ★ CONFIGURATIONS, CHARACTERISTICS
- ★ COUPLING, CASCADING, ISOLATION
- ★ APPLICATIONS, MEASUREMENTS
- ★ NOISE, DESENSE, INTERMODULATION
- ★ PROBLEMS, SOLUTIONS, FIGURES

\$8.50 POST PAID

✓ C162

Castle Publishing

Box 17778 • Tucson • Az • 85731

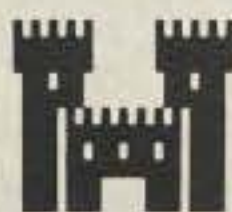

# TRS-80 OWNERS!

## M800 Deluxe RTTY for the TRS-80

Adds these additional RTTY features to the M80.

- Split-screen display. Full ASR.
- Save all text on cassette.
- Instant Replay - RCV and XMT text.
- Instant break operation - preserves buffers.
- WRU - save on cassette - automatically.
- Execute external programs - interactive graphics.
- One-time call sign insertion.
- Auto line numbers, margin labels, CR / LF, CR suppress, XMTR control.
- 4 small messages (255 char. ea.) plus big message (up to max. RAM).
- Additional RY, FOX, CQ messages.
- UT4 output speed control.
- Baudot (4 speeds) plus ASCII (110 baud).

Requires the M80 Ham Interface. **\$99**

## M80 Ham Interface Send-Receive RTTY & CW

- Auto send. & receive: RTTY & CW
- Complete hardware & software.
- Connects to TRS-80 User Port & Key / headphone jacks.
- 10 message memories - 255 char. ea.
- Keyboard buffer - allows typing ahead.
- Uses built-in PLL or external TU.
- Includes hardware, cassette & manual.
- Morse trainer - random 5 letter words.
- Requires Level II Basic & 16K RAM.

## NEW FEATURES★

- MORSE tutorial-10 lessons-corrects mistakes-Simplest, fastest way to learn the code!
- Auto-numbering contest keyer.
- Interactive Graphics-Custom PIX.
- Auto transmitter control-PTT.

Assembled & Tested **\$149**

■ PET, APPLE, SORCERER versions available.

Write or Call for Complete Catalog.



MACROTRONICS, inc.®

P.O. Box 518 (S) Keyes, CA 95328

(209) 634-8888 / 667-2888

We are experiencing telephone difficulties, please keep trying.

✓ M48

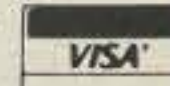

California residents add 6% tax

R10, and R13. It should be large enough to make the clock as dim as you want it for nighttime. Then use an NPN transistor and a photocell as in Fig. 4. As light falls on the photocell, its resistance drops, feeding more current to the transistor, which then partially shorts out the nighttime dropping resistor.

In my first version of this clock, I used a 5316 clock chip for the timing signals, eliminating IC1 to IC4 and Q1. It was a bargain chip because the alarm was defective. If you happen to have one of these chips in your supply and would like to use it, I can furnish the circuit diagram on request. Please send an SASE!

If you find the fast-set signal a bit too fast at 60 Hz, you can connect the fast contact on S2 to the output of IC1, which will give you a 6-Hz setting signal.

### Construction

There is nothing critical about the construction, but the TTL ICs can cause erratic operation if they are not properly bypassed. Each IC should have a capacitor connected right at the IC from the +5 V input to ground. The LEDs are wired so that pin 1 of IC10 and pin 1 of IC14 go to the LEDs at the 12:00 location on the clock face; the other pins go to the LEDs that follow, clockwise around the face. I used wire-wrap technique for part of the clock and point-to-point soldering for the rest.

The face of the clock can be made as large as you desire. If it is large enough, the ICs can be mounted on the face itself. A black sheet of cardboard can be used to cover the electronics, or you can cover the whole face with a dark red plastic sheet. I used a dry letter

### Parts list

R1, R2, R3, R6—10k, ¼ W  
 R4—220 Ohms, ½ W  
 R5, R7, R9—470 Ohms, ½ W  
 R8—720 Ohms, 2 W  
 R10, R13—270 Ohms, ¼ W  
 R11, R12, R14, R15—1.3k, ¼ W  
 C1—3000 uF, 15 V  
 C2—.1 uF  
 C3—.22 uF  
 C4-C19—.03 to .1-uF bypass disc capacitors from +5 V to ground at every IC (not all drawn on diagram)  
 T1—120 V ac/6.3 V ac, at 2 A  
 IC1, IC3—7490 counter  
 IC2, IC4—7492 counter  
 IC5—LM309K 5-volt regulator  
 IC6, IC8—4-bit binary counter  
 IC7, IC9—7476 dual J-K flip-flop  
 IC10-IC15—74154 4-line-to-16-line decoder  
 IC16—7400 quadruple NAND gate  
 S1—SPST toggle or slide switch  
 S2—SPDT toggle or slide switch  
 S3, S4—NO push-button switch  
 Q1-Q4—2N718 or similar small-signal NPN transistor  
 LED1-LED4—any small yellow or green light-emitting diode  
 LED5-LED89—any jumbo red LEDs  
 PC—VT133L or similar photocell

transfer kit to put white numbers on the dark face of the clock. I built a case for the clock out of wood. If you are good at carpentry,

you can make this clock into a neat and functional piece of furniture that you won't want to keep hidden in the bedroom. ■

NEW MFJ-410 "Professor Morse" lets you . . .

## COPY CW FASTER AND UPGRADE QUICKER

NEW MFJ Random Code Generator/Keyer sends unlimited random code in random groups for practice. Never repeats same sequence. Tailor level to your ability. Vary speed 5 to 50 WPM. Vary spacing between characters. Speed Meter. Full Feature Keyer.

**Sends unlimited random code. Never repeats same sequence.**

**Tailor level to your ability. Vary speed 5-50 WPM.**



**\$149<sup>95</sup>** ✓ M52

**Copy code faster and upgrade quicker.** Now you can tailor the level of code practice to your exact needs. Practice copying code anywhere and anytime you have a spare moment. Practice at home, in bed, driving to work, during lunch, etc.

**The new MFJ-410 "Professor Morse"** is a computer-like random code generator and keyer that sends an unlimited supply of precision Morse Code in random groups.

**It never repeats the same sequence** so you can't memorize it like code tapes.

**Vary speed 5-50 WPM** and read on speed meter.

**Vary spacing** between characters and character groups (for example, copy 5 WPM with 13 WPM characters) to give proper character sound at low speed.

**Select** alphabetic only or alphanumeric plus punc-

tuation (period, comma, question, slash, double dash.)

**Tone control. Room filling volume.** Built-in speaker. **Ideal for classroom teaching.** Earphone jack (2.5 mm) for private listening.

**Uses 110 VAC, or 9-18 VDC, or 4-C cells** (for portable use). Optional cable for car cigarette lighter (\$3.00). 6x2x6 inches.

**Built-in full feature keyer.** Volume, speed, internal tone and weight controls. **Weight control** adjusts dot-dash space ratio; makes your signal distinctive to penetrate QRM. Speed meter works for keyer, too. Tune switch keys transmitter for tuning. Reliable solid-state keying: grid block, cathode, solid state rigs. **OPTIONAL BENCHER IAMBIC PADDLE.**

Dot and dash paddles have fully adjustable ten-



sion and spacing. Heavy base with non-slip rubber feet eliminates "walking". \$39.95.

**Order from MFJ and try it — no obligation.** If not delighted, return it within 30 days for refund (less shipping). **One year unconditional guarantee.**

**Order today.** Call toll free 800-647-1800. Charge VISA, MC or mail check, money order for \$149.95 plus \$3.00 shipping for MFJ-410 and/or \$39.95 plus \$3.00 shipping for Bencher paddle.

**CALL TOLL FREE . . . 800-647-1800**

Call 601-323-5869 for technical information, order/repair status. Also call 601-323-5869 outside continental USA and in Mississippi.

**MFJ ENTERPRISES, INC.**  
 BOX 494, MISSISSIPPI STATE, MS 39762

# MILITARY SURPLUS WANTED

**WE NEED:** ARC-51BX, ARC-94, ARC-102, ARC-109, ARC-115, ARC-116, ARC-131, ARC-134, ARC-164, ARN-82, ARN-83, ARN-84, APN-59, APN-153, APN-141, APN-147, APN-171, APX-72, 618T, CU-1669A, 490T-1, CU-1658A, 51Y-4, 51R-8, 51RV-1, FM-622, 807A, URC-9, TOP DOLLAR PAID OR TRADE FOR NEW AMATEUR GEAR. WRITE OR PHONE BILL SLEP (704) 524-7519

✓ S4

**SLEP ELECTRONICS COMPANY**  
P.O. BOX 100, DEPT. 73,  
OTTO, NORTH CAROLINA 28763.

**AN/APR-4Y AM & FM Receiver**—115 Volts 60 Cycle for Frequencies 38 to 4000 megacycles. **\$79.50**  
(Tuning Units Available P.U.R.)

**AN/ART-13 Transmitter** for 80, 40, 20 and 10 meters. 100 Watts Output on AM, CW & MCW.

With all tubes **\$47.50**

**SCR-522 TRANSMITTER-RECEIVER** 100-156 mc. Crystal Controlled on 4 Channel. Excellent condition.

All tubes **\$42.50**

**ARC-5 TRANSMITTER** with all tubes and crystal Brand new (BC-457-4.5.3mc . . . BC-458-5.3-7mc.). **\$16.95**

**AC POWER SUPPLY** for above transmitter completely wired and tested. New **\$26.50**

**R-28/ARC-5 VHF RECEIVER** Crystal Controlled on 4 channels. 100-156 MC Excellent used cond. **\$27.50**

**T-23/ARC-5 VHF Transmitter**, Crystal Controlled on 4 channels. 100-156 mc. **\$29.50**

**DM-32 Dynamotor**, New **\$3.95**

**R-23/ARC-5 RECEIVER** 190-550 KC continuous tuning used, with all tubes **\$16.95**

**ARR-2 RECEIVER** 234-238 MC. New **\$10.95**

Write for catalog—send 50c for postage.

Terms: F.O.B. NYC. 25% deposit with order, balance COD or remittance in full. Subject to prior sale and price change.

**G&G Radio Electronics CO.** ✓ G26  
45-47 WARREN ST.  
NEW YORK, NY 10007 Ph. 212-267-4605

## SCANNERS \* SCANNERS \* SCANNERS

**YOU'VE SEEN THE REST, NOW BUY THE BEST  
HAM SCAN-2**

Kenwood 7400A, KDK 2015R, KDK 2016A, Pace Comm II, Midland 13-510, HW-2036, others

- Features one channel of memory, without need of resetting dials to zeros as required by others.
  - Unit mounts totally inside of rig, no external boxes.
  - Scanning rate 200 kHz nom, not 50 kHz, with a 3 second pause on all active channels before resuming scan.
  - Mike-mounted switch provides 3 functions: scan start/stop, remote frequency incrementing, and transmit interlocking when in active scan mode.
  - Totally assembled and tested **\$59.95 \$1.50 shp.**
- Order HAM SCAN-2 and please specify type of rig

## Technical Clinic

P.O. BOX 636  
STERLING HTS. MI 48078 ✓ T64  
Phone Orders Call: (313) 286-4836

# Station ID Timer and Code Practice Oscillator

ONLY **\$19<sup>95</sup>**  
IN KIT FORM

**\$26<sup>95</sup>**  
ASSEMBLED PLUS \$2.00 SHIPPING



**NEW!**

**NOW! EAGLE ELECTRONICS INTRODUCES** a practical accessory to every amateur station: The TM-1000™ 10 minute ID timer and code practice oscillator will remind you with a loud clear tone when it is time to identify. No longer is it necessary to keep an eye on the clock to be sure you identify in time; **the TM-1000™ keeps track of the time for you.** And, when you're not on the air, you can use it to improve your code speed because it **doubles as a code practice oscillator.**

**THE TM-1000™ HAS FULLY ADJUSTABLE** volume and tone and its timer is adjustable from 45 seconds to 10 minutes. It comes in an attractive walnut-grain cabinet and is powered by one 9v battery (not included).

**THERE'S NO NEED TO WORRY ABOUT** missed ID's during roundtables and QSO's anymore. **With the TM-1000™ in your station, you are assured of identifying in time.**

**THE TM-1000™ AUTOMATICALLY RESETS** after alerting you and can be reset any time by pressing the reset button.

**TRADITIONALLY, AMATEURS HAVE** endeavored to obey all regulations as closely as possible. **The TM-1000™ is an important aid to help amateurs** maintain that tradition by assuring that identification is accomplished at the proper intervals.

**THE TM-1000™ COMES WITH A 1 YEAR** guarantee and a 10 day, money back (less shipping) guarantee.

**SO ORDER YOUR TM-1000™ STATION ID TIMER/CODE PRACTICE OSCILLATOR TODAY FROM:**

**EAGLE ELECTRONICS®**

BOX 426C, PORTAGE, MI 49081  
or call 1-616-375-7469 to order COD or by bank card.  
Mich. res. add 4% sales tax.  
Optional AC adapter \$7.95 extra.

# MOVE YOUR HAMSHACK INTO THE FUTURE! COPY CW AND RTTY AT VIRTUALLY ANY SPEED, ANY SHIFT

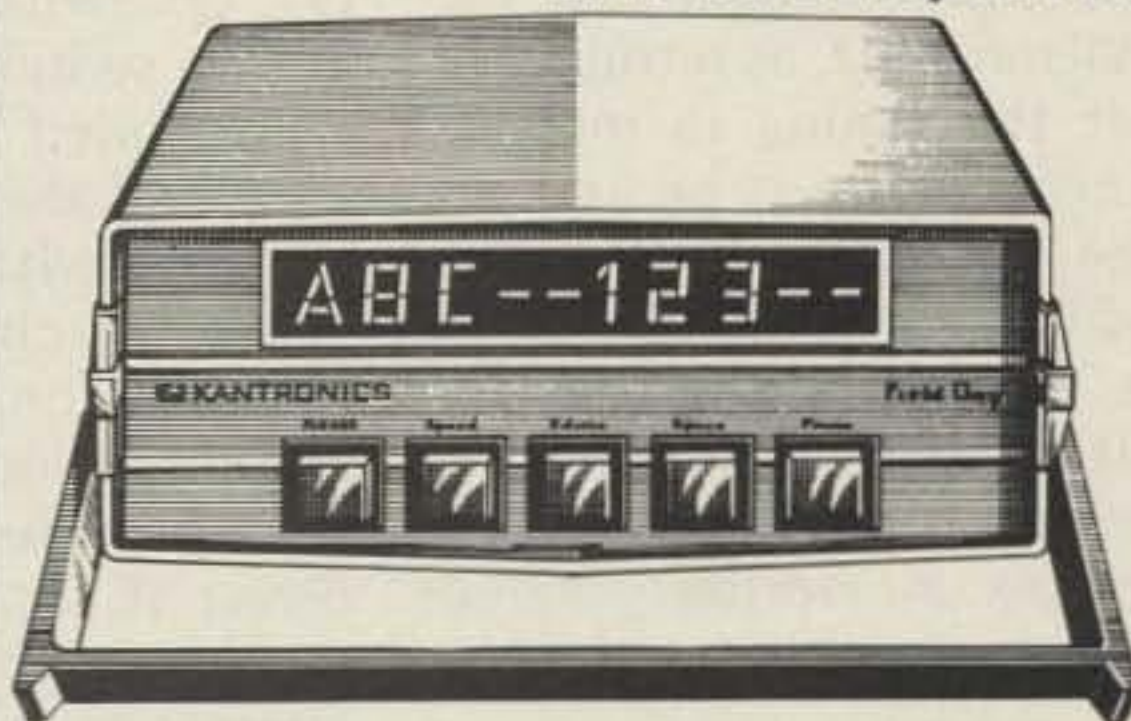

**KANTRONICS**  
**Field Day**  
TRADEMARK

**Smart Machine**

**NO KNOBS TO TUNE  
OR TURN - NO EXTRA  
GADGETS TO ADD OR  
CONNECT**

**MADE IN U.S.A.**

On board Microprocessor thinks for itself . . . continuously selecting proper speed, edits "sloppy copy", enters spacing all at the touch of a button. Tuning indicator allows fast signal selection. Big 1/2" traveling 10 character display runs the message in bright clear letters for effortless reading. CW - 3 to 80 words per minute. RTTY: 60-67-75 and 100 baudot. TTL demodulator output. Indicates speed of incoming CW at the touch of a button. Plugs into headphone jack on shortwave receiver. 117 VAC. Size 3-1/2 X 8-1/2 X 9-1/4". \$449.95. 9A588-3

**BURSTEIN-APPLEBEE**

3199 Mercier  
Kansas City, MO. 64111



CALL TOLL FREE  
**1-800-821-3686**  
IN MISSOURI 1-816-756-2525

# Turn Off Repeater Windbags

## — HT mod brings welcome relief

Gary L. Long W5HYQ  
Route 5, Box 267  
Muskogee OK 74401

At last a nifty circuit is available that can be used in the Wilson 1402 to make it a monitor (automatically).

Perhaps you are one of those people who really like to monitor the repeater, but find that there are always those few hams around chewing the rag so that continuous monitoring is more trouble than turning off the rig. Well, cheer up, Bunky, I have just what you need—a time-delay circuit that lets the Wilson operate normally for about 10 seconds after the squelch opens and a call is made or a con-

versation is started. After the 10 seconds has elapsed, the circuit mutes the speaker until the call in progress is over. No more will you have to listen to all of those dull, long-winded conversations just to be sure that you won't miss a call, and the circuit is automatically disabled when you need to get in on the conversation.

### Circuit Details

The circuit uses the 0-to-4½-volt transition when the squelch opens in the Wilson 1402, as a trigger to set the timing in motion. This voltage is picked off the top of the end-mounted 6.8k-Ohm resistor which is directly above the LD 3030 audio driver IC on the printed circuit board. This makes all wiring connections available on the top

of the board for ease in construction. The basic circuit design is that of a switching transistor with a timing circuit and an audio gate transistor tied to it.

### Circuit Operation

When the squelch opens, a voltage at the 6.8k resistor goes from 0 to around 4½ volts. This voltage is applied to the circuit to start charging the R1C1 combination through R2. As soon as about 1.2 volts is attained on the base of Q1, Q1 switches on which in turn switches on Q2. Q2 is provided as an audio gate, and also to isolate the timing switch from the audio switch. When Q2 is switched on, it gates the audio that normally would have been fed to the audio driver IC from the center tap (wiper) of the volume control pot to ground.

Anyway, I guess it goes to ground, since it works. It might be going through the batteries, but wherever it sends the audio, it effectively shorts whatever audio is available to operate the driver IC to ground and kills all the audio output from the speaker. This takes about 10 seconds for the choice of resistors and capacitors I used.

When the 1402's squelch closes, the voltage at R2 goes to zero and C1 is discharged through R1 until Q1 switches off, which switches off Q2 and restores the audio to a squelched receiver ready for the next call. This takes about 6 seconds for the values that I used. The measured current draw for this circuit is less than 1 mA, and if you are running the audio level fairly loud (volume control at ½ maximum or louder) the circuit also will function as a battery saver. This is because the circuit clips the audio on extended conversations to zero, which reduces the radio's current draw to that of minimum specs for un-squelched operation.

The switch S1 can be any kind of an SPST switch, but since I didn't want to drill a hole in the radio, I used a mercury tilt switch similar to the one in most residential wall-mounted heating thermostats which I found in my adequately-stocked junk drawer. The switch is positioned inside the radio so that when the radio is lying on a table, the switch is open and will let the capacitor, C1, charge. When the radio is picked up and held in the vertical handheld operating position,

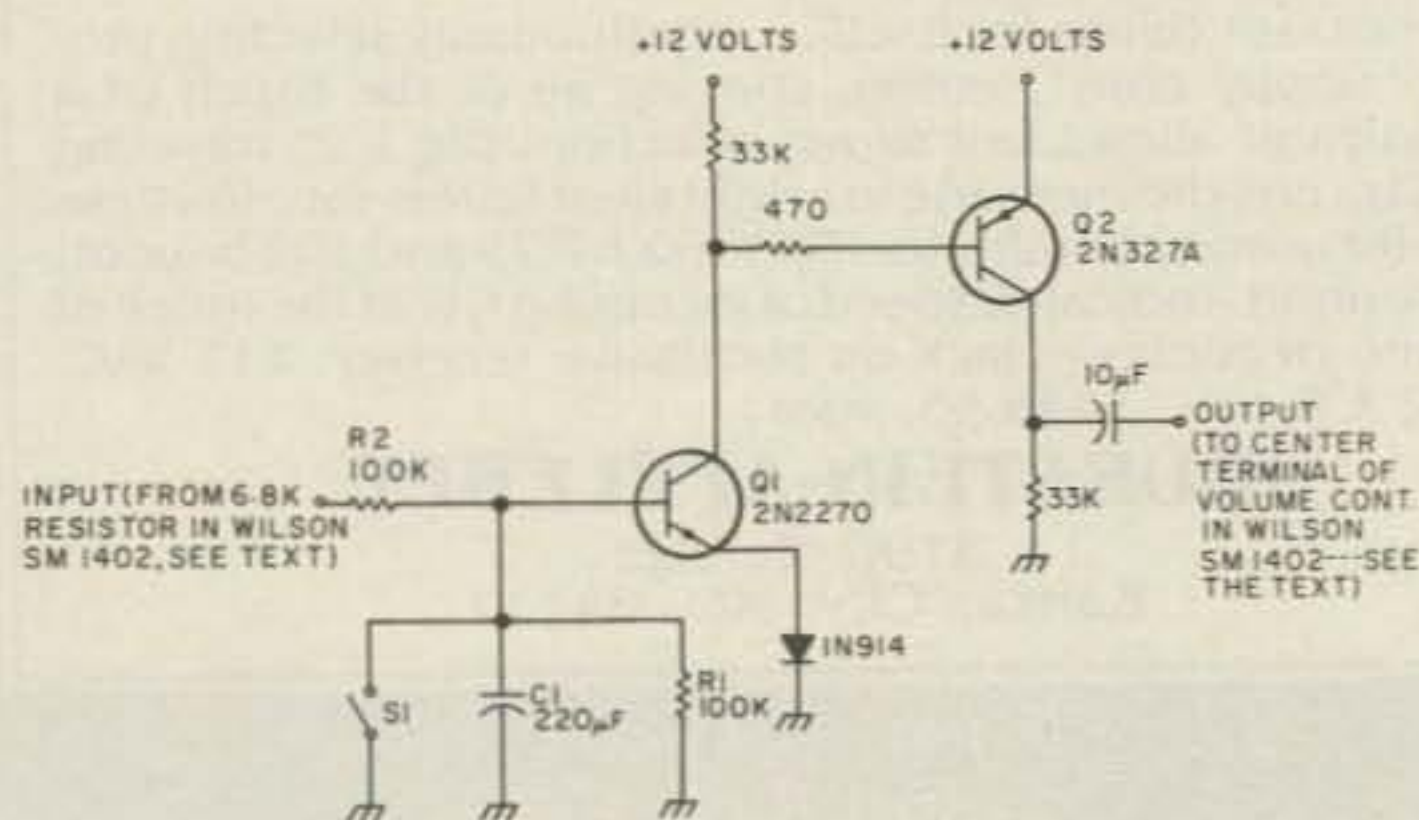
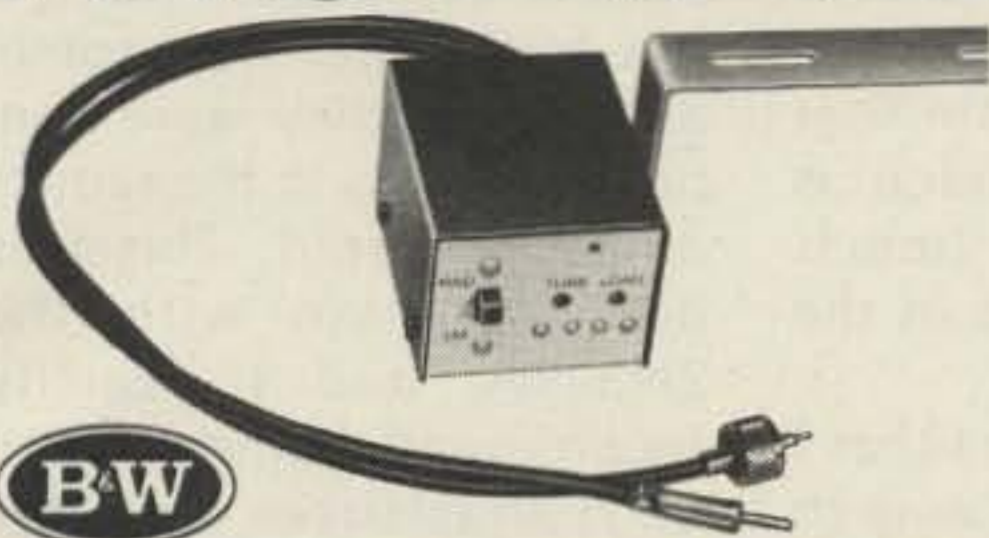

Fig. 1. Schematic of automatic muting circuit.

# 2-METER MOBILE



**B&W**  
**AT-200 Antenna Matcher**

Use your car's AM/FM antenna for your 2-meter mobile rig.—Eliminate the two-antenna tip-off to thieves, without the nuisance of hideaways.

Save the cost of a 2-meter mobile antenna.

AT-200 tunes from the front panel for maximum output, minimum VSWR (1.2:1 or less for most car antennas).

at your B&W dealer. ✓ B23

Made in the U.S.A. by **B&W**

**Barker & Williamson, Inc.**  
10 Canal Street, Bristol, PA 19007

## ALL BAND TRAP VERTICAL ANTENNAS!

**FULL 1/4th WAVE - All Bands!** Automatic Selection with proven HI-Q Traps. 3 Models—ALL self supporting - Ground or roof mount. **HEAVY** Double wall seamless Aluminum lower section - **HI IMPACT POLY** Low Loss Plastic Cover **OVER-ALL. NO WOBBLY, LUMPY TRAPS - NO UNSIGHTLY CLAMPS** needed - Same size all the way up - 1 1/4" - Traps hidden inside. You can use it in a 1 ft. sq. Backyard! Neighbors will never know this is a **HI-Power ALL Direction DX Antenna.** **FOR APARTMENTS, ROW HOUSES, MOBILE HOMES - CONDOS** etc. where minimum space and neat appearance is **MANDATORY!** Instant "Drive In" ground mount (included). Use with or without radials (included) (All angle roof mount - Extra) **COMPLETELY PRETUNED - NO ADJUSTMENTS NEEDED EVER! NO TUNER NEEDED Over All Bands** (except 80 meter - 400 KC) SWR 1-1 to 2-1 at Band edges, Stnd, SO239 connector - 50 ohm for any length RG58U - RG8U feedline. **MATCHES ALL MAKES TRANSRECEIVERS. 2000 Watt PEP.** Shipped in 5 ft. Box - **PREPAID IN USA.** Assembles in 3 min. using only screwdriver. **WEATHERPROOF!**

No.-AVT80-10 5 Band 24'9" \$79.95  
No.- AVT40-10 4 Band 18'9" \$69.95  
No.- AVT20-10 3 Band 12'6" \$59.95

**SEND FULL PRICE FOR PP DEL IN USA** (Canada is \$5.00 extra for postage, clerical, Customs etc.) or order using **VISA** (BankAmericard) or **MASTER CHARGE** or **AMER EXP.** Give Number and Ex. date. Ph 1-308-236-5333 9AM-6PM weekdays. We ship in 2-3 days. Prices will increase Sept 1, so order **NOW AND SAVE.** All

Antennas Guaranteed for 1 year - 10 day money back trial. Made in USA. Free Inf. Available from **WESTERN ELECTRONICS** Dept. A7-12 Kearney Ne, 68847



### PERSONALIZED LICENSE PLATE FRAMES YOUR NAME, QTH, 73 ETC. IN RAISED, WHITE LETTERS ON A BLACK BACKGROUND.

- DURABLE, DIE CAST METAL FRAME
- TRIPLE CHROME PLATED
- LETTERS CHEMICALLY FUSED
- FITS ALL AUTOMOBILES
- ACCOMMODATES ALL LICENSE PLATES
- EXCITING NEW GIFT ITEM!

**\$ 8<sup>95</sup>**

PER FRAME  
POSTPAID

✓ A107



WHEN ORDERING, SPECIFY TOP LINE COPY (12 LETTERS MAX. INCLUDING SPACING) "AMATEUR RADIO" APPEARS AS BOTTOM LINE ON ALL FRAMES UNLESS OTHERWISE SPECIFIED (12 LETTERS MAX.)

### AJT ENTERPRISES

4442 VINTON AVENUE CULVER CITY, CA. 90230 (213) 836-2223

SATISFACTION GUARANTEED OR MONEY REFUNDED

CHECKS AND MONEY ORDERS ACCEPTED. CALIF. RESIDENTS ADD 6% SALES TAX

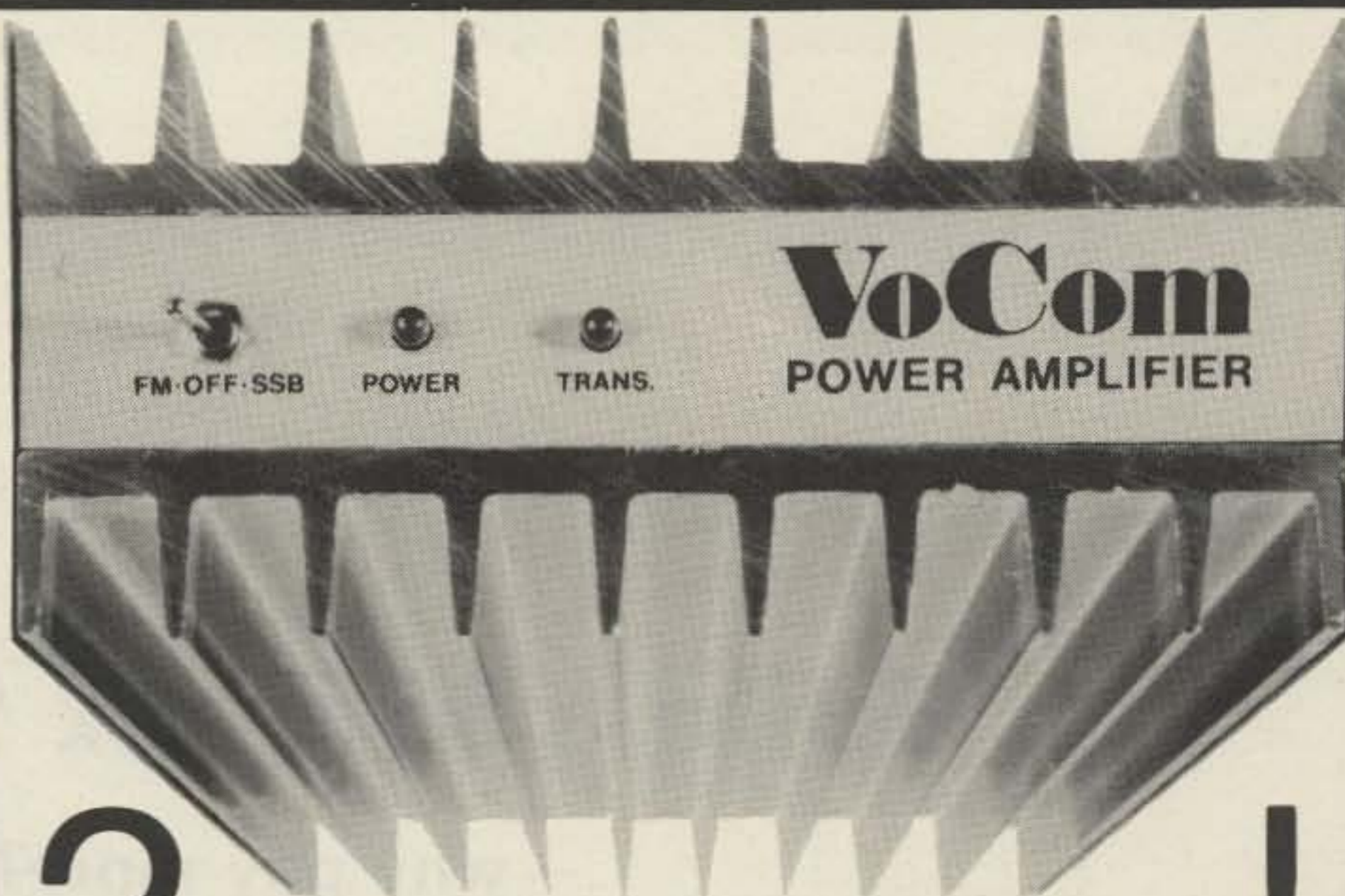

# 2 Meter POWER!

**FM—SSB—CW—RTTY—SSTV—AM**

Power when you want it, power when you need it. Power to boost your hand-held for effective cross-country mobile operation, power to work DX on the lower band edge when it's not really quite open. VoCom has it in a variety of compact, efficient, clean signaled modular RF power amplifiers. Built-in flexibility, too... ask for information on programmable input models.



MODEL	PRICE
2C400 <sup>1</sup>	\$489.95
2C200 <sup>1</sup>	\$259.95
2C100 <sup>2</sup>	\$169.95
2C025 <sup>3</sup>	\$69.95

1. For 10 or 25 W drive only (specify)
2. 10 or 25 W drive (specify)
3. For 2 W (nominal) drive only

- Output power 25, 100, 200 or 400 watts at rated drive
- 2, 10 or 25 watts drive
- Harmonic and spurious down more than 70 dB
- 10 MHz bandwidth for CAP, MARS
- Efficiency 70% on most models
- 2 watt drive models deliver near rated output with Syncom, Wilson or other 1-1.5 watt hand-helds
- SSB, remote control kits available
- Massive heat sinking for long life
- LED status indicator
- FCC Type Accepted versions available for commercial service

**NEW! 200 mW Drive, 25,50 or 100 W Out Models for Yaesu FT-207R!**

**VoCom** PRODUCTS CORPORATION **Box 219, Prospect Heights, IL 60070**  
(312) 870-8060



the switch is closed, which holds capacitor C1 permanently discharged for the normal two-way operation of the radio.

### Construction Hints

I built all the components in the area at the top of the radio around the volume and squelch controls. This was done with hard wiring since space is limited, and also since there really isn't much to

wire. The largest component was the capacitor, and it fit nicely in the small recess beside the S-meter. The resistors were 1/4-Watt jobs, and the mercury switch was one that I had which was larger than necessary, but fit nicely in the gap between crystals in the crystal deck. I adjusted the mercury switch so that the mercury ran away from the contacts when the radio was lying flat.

After connecting all the items as shown, the unit can be checked out by holding it in the horizontal position and breaking the squelch. After about 10 seconds, the audio will mute and will remain that way until the squelch is closed or until the unit is picked up and held in the vertical position.

In closing: An idea that I didn't try out, that came to me after I built the circuit,

is to use a LED instead of the 1N914 diode which would give a visual indication of a muted radio. Also worth noting is that I tried several transistors for Q2, but found that with some, as soon as they were connected, a loss in the radio's audio occurred. This was not the case with the 2N327A, and I heartily recommend being careful of substitutes in this area. ■

## Build a \$5 Coax Switch

— why pay more?

\$3.47 or \$5.02.

*Jerrold Swank W8HXR  
657 Willabar Drive  
Washington Court House  
OH 43160*

**A** two-way coax switch is a real convenience for switching between two

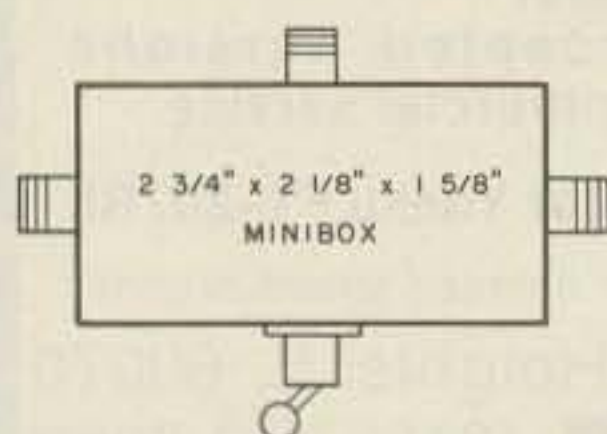

Fig. 1.

antennas, or for grounding an antenna, or for switching one antenna to another rig. Take a small minibox, Bud #5A30005 or #5A3014, and with a 5/8" drill or a Greenlee punch cut three holes as shown in the drawing in Fig. 1. These are cut on the three sides of the U-section.

Mount three SO-239 connectors on the three sides of the U-shaped section. Then punch a 1/2" hole in the other section and mount a heavy-duty toggle

switch—SPDT. I used a DPDT and strapped the two sections together to take heavier current.

Connect as shown in Fig. 2. Use a flexible piece of coax shield from RG-58/U for connection to the "common" connector so that the box can be put back together easily.

Use #12 wire or the center conductor from RG-8/U coax for the other connections.

The total actual parts cost was \$5.02, saving

about \$35 over a commercial switch of the same type.

The same idea can be used without the toggle for an emergency T connector, by connecting all three SO-239s together. Cost: \$3.47. ■

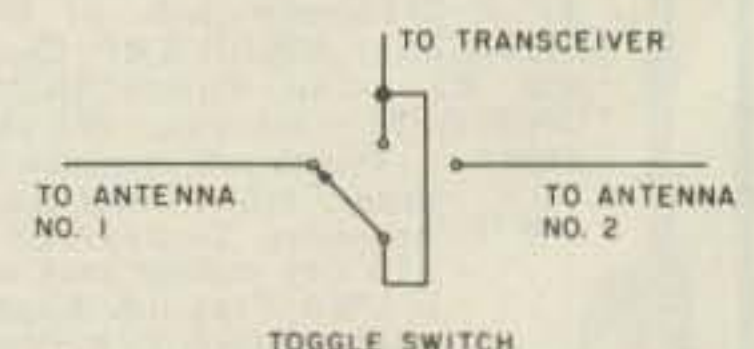

Fig. 2.

# JAN CRYSTALS

**JAN  
CRYSTALS  
KEEP  
YOU ON  
THE AIR**

- CB
- CB standard
- 2 meter
- Scanners
- Amateur Bands
- General Communication
- Industry
- Marine VHF
- Micro processor crystals

Send 10¢ for our latest catalog.  
Write or phone for more details.

Jan Crystals  
2400 Crystal Drive  
Ft. Myers, Florida 33907  
all phones (813) 936-2397



easy to charge

# HAMTRONICS, INC.

WHERE THE HAM IS KING

FOR OVER 30 YEARS

✓H8

Let Us Fill Your



Specific Needs From

## OUR \$2,000,000.00 AMATEUR GEAR INVENTORY

ALL THE FAMOUS NAMES—TRANSCEIVERS—AMPLIFIERS—ANTENNAS—TOWERS

**Give us a try before you buy • Call Jim Titus**

a Division of TREVOSE ELECTRONICS, INC/ 4033 Brownsville Road, Trevoise, PA 19047

FREE UPS SHIPPING  
ON PREPAID ORDERS



# 215-357-1400

## Info-Tech's Great New M-200E TRI-MODE CONVERTER

Converts  
**MORSE, RTTY  
& ASCII to  
video.**



This advanced model in the M-200 Series  
extends the horizons of capability and performance:

- **Morse Reception:**  
6-60 wpm with automatic speed & wordspace
- **RTTY Reception:**  
4 speeds, 3 shifts, unshift on space select, automatic threshold select, auxiliary baudot loop output, tuning meter, auto. speed readout
- **ASCII Reception:**  
110 Baud with built-in T.U.
- **Video Outputs:**  
32 character line x 16 line video with scrolling  
72 character line x 16 line video with scrolling
- **Special Feature:**  
ASCII, Loop or RS232 output on all modes

**M-200E (32) . . . . . \$500.00**

**M-200E (72) . . . . . \$525.00**

Order direct or from these dealers:

**Global Communications**  
606 Cocoa Isles Blvd.  
Cocoa Beach, Florida 32931  
305-783-3624

**Cohoon Amateur Supply**  
Highway 475  
Trenton, Kentucky 42286

**Dialta Amateur Radio Supply**  
212 48th Street  
Rapid City, S. Dakota 57701  
605-343-6127

**Emona Electronics**  
661 George Street  
Sidney N S W Australia

**Germantown Amateur Supply**  
3202 Summer Avenue  
Memphis, Tennessee 38112  
800-238-6168

**Ham Radio Center**  
8342 Olive Blvd  
St. Louis, Missouri 63132  
800-325-3636

**Rickles Electronics**  
2800 W. Meighan Blvd  
Gadsden, Alabama 35904  
205-547-2534

**Universal Amateur Radio**  
1280 Aida Drive  
Reynoldsburg, Ohio 43068  
614-866-4267

**N & G Distributors**  
7285 N W 12th St  
Miami, Florida 33126  
305-592-9685

**PANACOM**  
P O Box 76093  
Caracas 107 Venezuela

**Marcucci-SPA**  
via F. LLI-Bronzetti  
Milan, Italy



## HAM REPEATER AUTOPATCH

Offer your club **COMPLETE**  
emergency communications

Commercial quality, gold plated contacts, plug in, epoxy glass PC boards. 12 volt DC or 115 volt AC operation - Power supply included. Four digit access - Single digit releases - field programmable. Hybrid network - No switching required. FCC certified telephone line coupler. Auxiliary "In Use" contacts supplied. Land line "call-in" signalling control contacts provided. Price complete \$498 + \$3 shipping & handling. Master Charge, Bank money order, or certified check acceptable.

Accessories: CES-300 powered tone pad - \$59 BUS-COM Soft-touch® telephone powered mike/pad element - \$34.95. ✓M76

**MONROE ELECTRONICS, INC.**  
412 Housel Ave., Lyndonville, N.Y. 14098



## INFO-TECH INCORPORATED

Specializing in Digital  
Electronic Systems

✓145

2349 Weldon Parkway • St. Louis, Missouri 63141 • (314) 576-5489

# Hamdom's Evangelical Crusade

— born-again ops, arise!

I have given up trying to explain ham radio to my wife. And who can blame me? Last time I mentioned that something was wrong with my keyer, she called a locksmith. And how could I try to explain *that* to someone who thinks TVI is what you get when you sit too close to the television set?

So, I've decided to keep my thoughts in that area to myself. Except for the Tuesday-night gathering of hams at our place (at which my wife, by the way, chews us out for always talking about OSCAR but never having the courtesy to invite him over), I've pretty much regressed into a domestic ham fantasy-world.

Which is not all too bad, actually—it beats trying to explain the thrill of operating 160 meters to someone who thinks it's an Olympic running event.

Take last Thursday night, for example: The XYL and I, having finished the dinner dishes, had settled down for an evening of the all-American, middle-class, intellectual challenge—watching television, of course. I sat in the easy chair, fiddling with a 450 MHz handie-talkie, which my wife proudly tells her friends is “an expensive

CB.”

Like I said, who can blame me?

My wife had long since given up on what channel I want to watch, since I usually mumble something about “20 meters” (unless the band happens to be a total disaster, in which case I grumble something about “the gang on two”). So as I sat fiddling with a stubborn battery pack, she flipped to the “Billy Graham Crusade.”

She settled herself on the couch and picked up her knitting. “Is that alright with you, dear?” she asked. “Mfgpht,” I said. She went back to her knitting and I went back to my battery pack. Finally, I got the thing in place. I stuck an earplug in the jack, fiddled with the squelch control a bit, and then turned the channel selector to the local repeater. With that odd combination — Billy Graham in the right ear and some guy testing an autopatch in the left — I sat back in the chair and promptly fell asleep.

What was it that Freud said about people who were depressed by daylight — that all their secret thoughts revealed themselves in dreams? Anyway, the last thing I remember thinking is, “Wouldn't it be

great if we had someone who could do the same thing for ham radio that Billy Graham is doing for religion?” Then, I had my first glimpse of a frustrated ham's vision.

Madison Square Garden. The Astrodome. The Hollywood Bowl. It didn't matter; the scene was the same every time. Hundreds of thousands of people stream into the nation's gathering places to learn about ham radio. CBers, SWLers, and even stereo freaks crowd the auditoriums and stadiums of the nation to hear the world's greatest spreader of the ham's way of life. Suddenly I awoke with a start, sat up in the chair, and said aloud:

“Ham. Elmer Ham.”

My wife put down her knitting and stared at me quizzically. “What was that, dear?” she asked.

“Nothing,” I said, and then I pointed to the handie-talkie. “Just thought I heard a friend of mine.” I knew it was pointless to say any more, because trying to explain ham radio to my wife usually resulted in disaster. Last time I'd spoken of inductance in her presence, she'd called the Pentagon and begged them not to draft me.

She shook her head. “Honestly, dear. I'd swear

all you ever think about is your silly little radios.”

“Mfgpht,” I said cheerfully. Before long I was asleep again, and the vision returned.

The Astrodome. Thousands pour into the stadium; millions more watch on television. Elmer Ham doesn't appear immediately, of course — they save him for the last while they warm up the audience. Maybe they will play tapes of rare DX QSOs over the stadium PA system, or have a choir chanting in CW — something like that. Ushers pass out Novice-class study guides as the curious throng floods through the doors; attendants begin circulating straight keys and antenna tuners throughout the audience as the stadium fills. And then Elmer Ham takes the stage.

He's a dynamic, charismatic man, and the audience responds enthusiastically as he extols the virtues of ham radio. An attendant in a white lab coat wheels up a cart full of equipment, and Elmer Ham goes through the rounds of explaining the mysteries of hamdom to a hundred thousand gaping neophytes. They “ooohhh” at SSTV. They “aahhh” at DX and RTTY. And they





The VBC Model 3000, the world's first and only narrow band voice modulation system is now a proven success. Leading communications engineers were enthusiastic about the NBVM system from the beginning. Now the idea of more QSO's per kilocycle has fired the imagination of Amateurs everywhere. The benefits of this advanced communications system are being demonstrated all over the world.

For present VBC users we can provide a list of other happy owners. For those Amateurs, who have not experienced NBVM yet, "why not add your name to the list?"

The VBC Model 3000 provides full audio level compression and expansion... complete intelligibility in only 1300 Hz bandwidth. It permits you to take full advantage of other stations' RF speech clippers and processors... similar to the amplitude compression and expansion used for many years in telephone and satellite communications.

The Model 3000 is for mobile and fixed station use and requires no modifications to your existing equipment. It is completely self contained, including its own audio amplifier. The unit automatically switches into transmit

mode when microphone is keyed or voice operation is used. It connects just after the microphone on transmit and just prior to the speaker on receive. In addition to its basic function of operating in a narrow bandwidth, the Model 3000 also increases the performance of your station in the following ways:

- Reduces adjacent channel interference
- Increases signal to noise ratio
- Increases communications range

Some of its outstanding features include:

- High quality narrow band speech
- Self contained transmit/receive adapter
- Built in audio amplifier
- 5 active filters with a total of 52 poles
- Rugged dependable hybrid IC technology
- Low power consumption

Receive only features, such as sharp voice and CW filtering and amplitude expansion, provide improved reception without requiring a unit at the transmitting station.

For the more advanced experimenter the Model 3000 is available in a circuit board configuration for building into your present transceiver.

Henry Radio is ready to offer technical assistance and advice on the use and servicing of the Model 3000 and will help introduce new owners to others operating NBVM units. Get in on the ground floor... order yours now.

Price: VBC Model 3000 \$349.00

Circuit board configuration \$275.00

For more detailed information please call or write. The Model 3000 will be available from most Tempo dealers throughout the U.S. and abroad.

NEW TOLL FREE ORDER NUMBER: (800) 421-6631

For all states except California.  
Calif. residents please call collect on our regular numbers.



11240 W. Olympic Blvd., Los Angeles, Calif. 90064 213/477-6701  
931 N. Euclid, Anaheim, Calif. 92801 714/772-9200  
Butler, Missouri 64730 816/679-3127

✓ H3

**Henry Radio**

Prices subject to change without notice.

"wowww" as Elmer effortlessly copies CW at 65 wpm.

After a good hour, he makes the big pitch: Would anyone in the audience be interested in obtaining a ham license? Thousands raise their hands. Elmer warns them that they'll be required to learn their code and theory, that the battle won't be won without a little study and dedication. Some of them are afraid,

but others have made up their minds that they're going to do it—and at Elmer Ham's invitation, they flock down to the stage where attendants sign them up for code and theory courses.

"Beautiful," I said aloud. Then I opened one eye. Billy Graham had been pre-empted by some commercial about a lady plumber, and my wife was still working at her knitting.

And, of course, the gang was still jabbering away on the local repeater.

"What happened to Elmer Ham?" I asked.

"Who?"

"Billy Graham. I meant Billy Graham."

"Oh, him. He's all over, and you missed the best part. It was so exciting," she said.

"I know." I continued to fiddle with the handie-talkie until the next pro-

gram—a rerun of "I Love Lucy"—hit the air.

"This all right with you?" my wife asked methodically.

"Mfgpht," I said, and settled back into the easy chair. This one, I mused, would require a little more thought. How about a Cuban bandleader who keeps in touch with his crazy redheaded wife through 2 meters? Hmmm... ■

Tom Merrick W1WUO  
64 Maple Avenue  
Atkinson NH 03811

# The Memorizer Flies Inverted

— something Yaesu never told you

The popular Yaesu FT-227R Memorizer presented me with a hidden capability one evening. I had always envied those who could instantly "go inverted" with one flick of some super-switch thoughtfully provided by some brilliant designer. It was a great pleasure to discover that this was an unspecified option in my own transceiver! It was even more fun to think that I had discovered something that even the designers on this unit hadn't thought of.

This operating procedure, which requires no physical modifications at all, causes the transceiver to exchange 600-kHz-offset transmitting and receiving frequencies with one click of the function switch. It is accomplished by using a

not-obvious combination of control settings which is not mentioned in the instruction manual.

The following steps specify how to memorize the lower frequency, set to the higher frequency, energize the memory recall, and utilize the MEM and +600 positions of the function switch.

1. Release M (Memory) and MR (Memory Recall) switches.

2. Set the frequency display to the *lower* of the repeater input and output frequencies.

3. Press M switch.

4. Set the frequency display to the *higher* of the repeater input and output frequencies.

5. Press MR switch.

6. Set function switch to the MEM or +600 position.

The frequency display now indicates the receiving frequency. Choose the frequency you want to listen to, the repeater input or output. When the transceiver transmitter is keyed, the output frequency will be offset 600 kHz *up* or *down* as required to effect the desired operation.

For normal operation on repeaters with a low-side input frequency, use MEM. In this position, the transmitter is forced to be the memorized (lower) frequency and the MR switch function is defeated so that the received frequency (higher) is what is set into the dial. When you set to the +600 position to go inverted, the MR becomes effective so that the memorized (lower) frequency is recalled and the transmitter is offset up by 600 kHz.

For normal operation on repeaters with a high-side input frequency, use +600 and switch to MEM to go inverted.

As long as the memorized frequency is not lost, the transceiver can be used on other frequencies with any offset you want and returned to this special mode by following steps 4 through 6.

If you have to ask what this type of operation is good for, I'm surprised you have read this far. In truth, I don't know of much practical use unless your favorite repeater frequently goes off the air due to timeout failure. At least it is fun to be able to use all of the capability of the equipment.

See you on the output—direct! ■

# M & M For Quality Ham Products at Discount Prices!

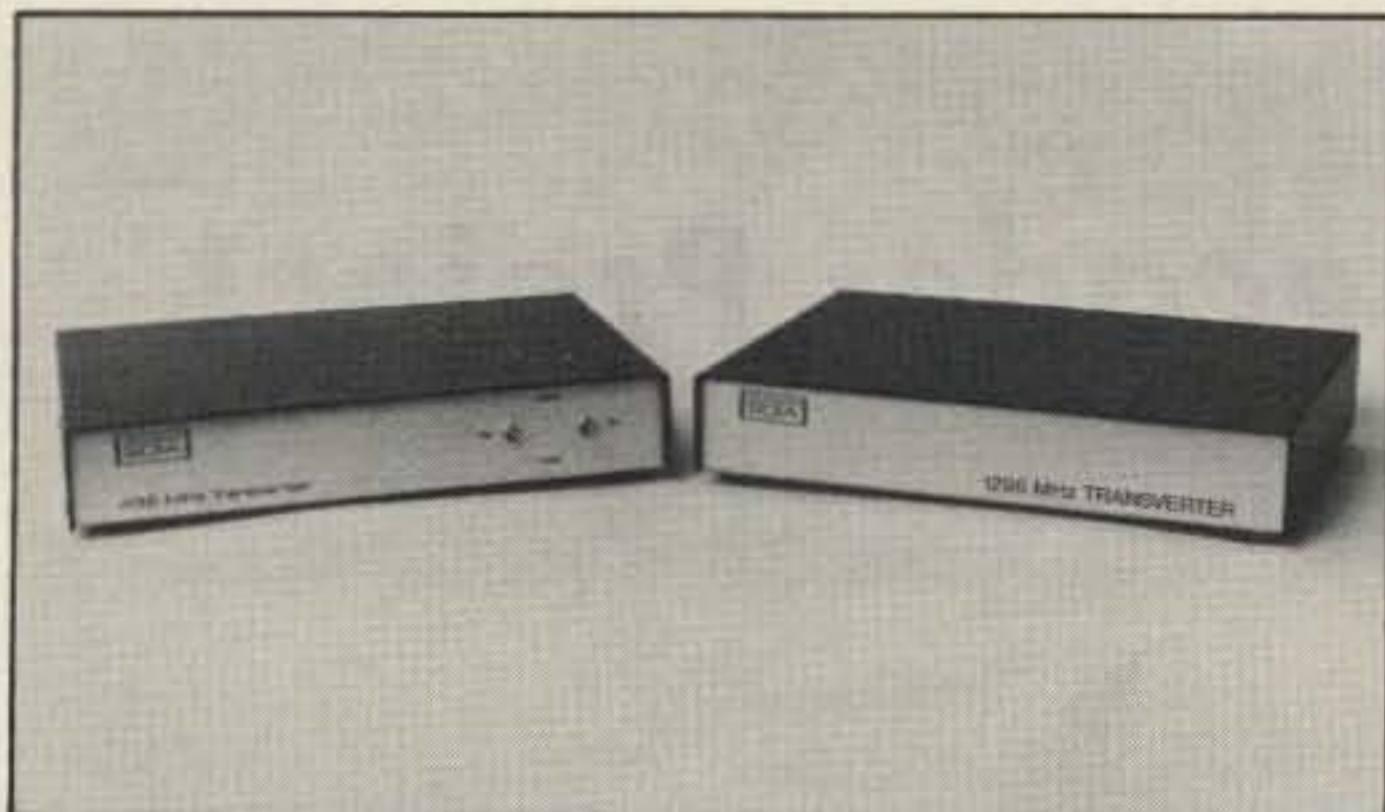

## LINEAR TRANSVERTERS

M&M has been appointed the exclusive U.S. distributor for these new products from SOTA Communications Systems Ltd. These units are produced by SOTA under a license agreement from UKW, and are the commercial versions of some products previously in issues of VHF Communications.

### 1296 TRANSVERTER

- Receive NF under 3 dB
- Image Rejection 20 dB or better
- Output Power 2½W min
- Covers 1296-1298 with 28-30 MHz input.
- 144 MHz available soon.

### 1296 CONVERTER

- Receive portion of transverter only with same specs

### 1296 POWER AMPLIFIER

- 50W output
- Built-in AC Supply
- Compatible with transverter

M&M has the items listed below for immediate delivery. Call for quote now before prices go up at first of year.

### TRANSVERTERS

SOTA	23 cm 2W out 28 MHz in	\$499.95
SOTA	23 cm 2W out 144MHz in	\$499.95
SOTA	70 cm 15W out 28 MHz in	\$424.95

### CONVERTERS

SOTA	23 cm 28 MHz IF 3 dB NF	\$149.95
SOTA	23 cm 144 MHz IF 3 dB NF	\$149.95
SOTA	70 cm 28 MHz IF 2 dB NF	\$124.95
LUNAR	70 cm OSCARBOX 'J'	\$124.95

### POWER AMPLIFIERS

SOTA	23 cm 50W output AC Supply	\$699.95
SOTA	70 cm 50W output AC Supply	\$499.95
MMW	70 cm 50W out 12.5V (MML 432/50)	\$369.95
LUNAR	220 & 144 MHz power amps also - call for quote	

### ANTENNAE

SI	23 cm 28 el Loop Yagi	\$59.95
RIW	70 cm 19 el Yagi	\$59.95
NMT	1.3 m 11 el Yagi (220 & 223 models)	\$54.95
NMT	2 m 11 el Yagi (144 & 146 models)	\$59.95

Year end close out KR-500 elevation rotors - \$150.00

**RIW ANTENNAS  
SPECIAL YEAR END  
CLOSE-OUT PRICES!**

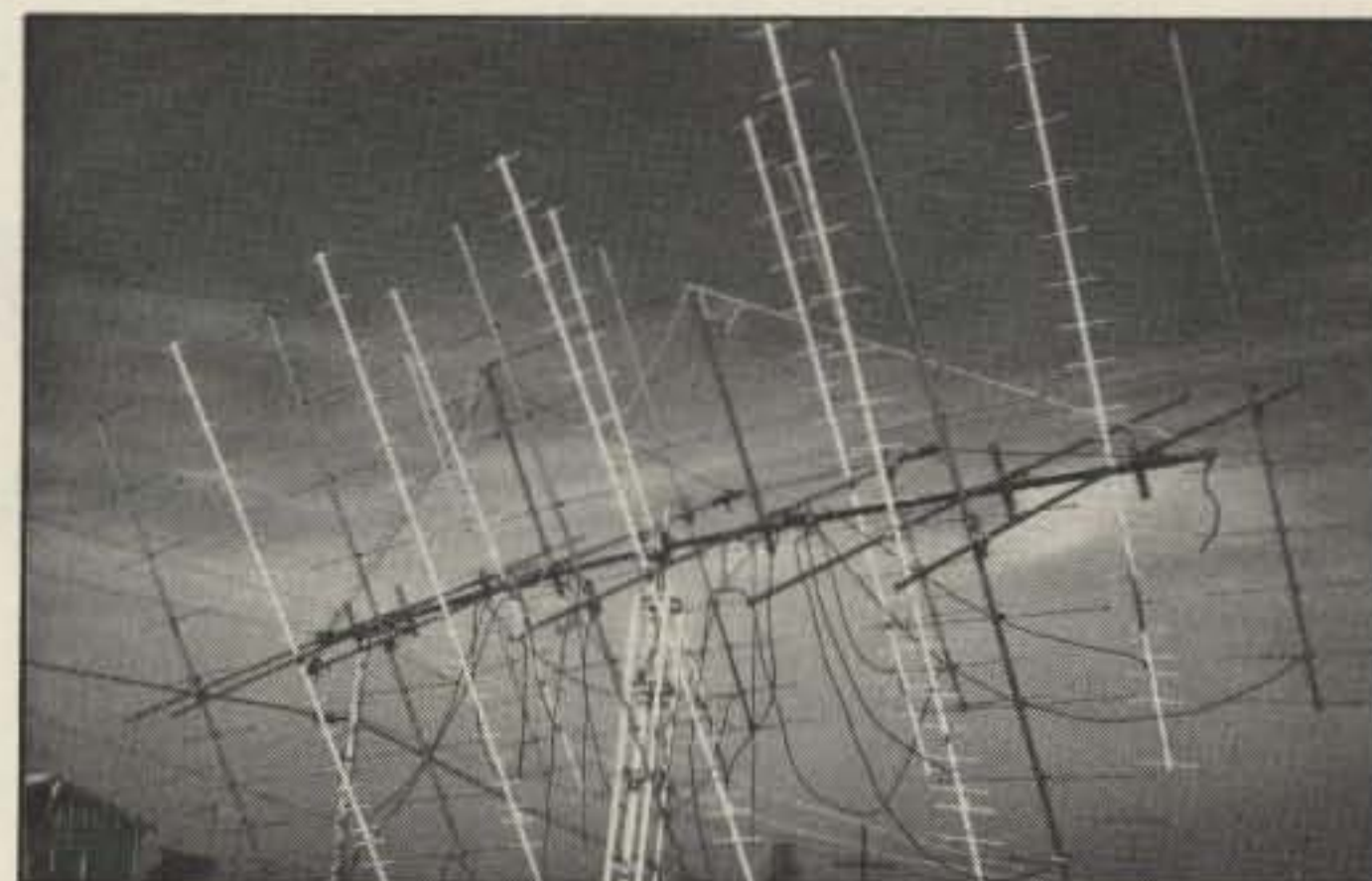

## YAGI ANTENNAS

Announcing the new NMT-11 series of 144 & 220 MHz Yagis. Originally developed by WB6NMT for his pioneering 220 MHz work, these modern designs meet the demanding criteria required by all serious VHFers. High gain with high efficiency; good mechanical strength without additional boom structures; vertical or horizontal mounting; all elements ¼" thru the boom, insulated mounting; driven element ½" brass tubing with tunable insert (may be silver plated); integral 50 ohm 4:1 balun included; S0239 or type N connector options; models for each sub-band for optimum performance where you want it. EME proven on 144 and 220 bands.

General Specs:	144 MHz Model	220 MHz Model
Boom Diameter	1 ¾"	1 ¾"
Active boom length	17.4 ft	11.5 ft
Mast clamp accepts	to 2½" diam	to 2½" diam
Parasitic elements	¼" aluminum	¼" aluminum
Driven element	¼" brass w/ insert	¼" brass w/ insert
Beamwidths	31° E 34° H	31° E 34° H
Stacking (-20 dB lobes)	9.9' E 8.8' H	6.5' E 5.8' H
Stacking (max gain)	12.9' E 11.9' H	8.4' E 7.8' H
SWR (at resonance)	less 1.1:1	less 1.1:1
Relative gain	-0.5 dB ref 3.2 NBS	-0.5 dB ref 3.2 NBS
Bandwidth NMT-11/144	144-146 MHz	
Bandwidth NMT-11/147	145.5-148 MHz	
Bandwidth NMT-11/220	220-222.5 MHz	
Bandwidth NMT-11/223	222-225 MHz	



**KEN PRO KR 500  
ROTATORS  
SPECIAL YEAR END  
CLOSE-OUT PRICES!**



**AIGA ROTORS  
SPECIAL YEAR END  
CLOSE-OUT PRICES!**

# M&M RF DISTRIBUTORS

2785 Kurtz Street, Suite 4, San Diego, CA 92110  
P.O. Box 82183, San Diego, CA 92138

**CALL (714) 299-9741**

✓ M76

# Double-Duty Decoder Project

— listen to SCA and tune in RTTY

Geoffry W. Kufchak  
WAIUFE/5  
159 Ashford  
San Antonio TX 78227

Here are two projects that I've had in mind for a long time. Since they are very similar in design, I am combining them into one article divided into two parts. Part One covers the SCA decoder, and Part Two covers the FSK decoder.

## Part One

For a long time I have

been wanting to receive the background music that many FM stations broadcast. I had read several construction articles describing decoders, but they were all too complicated. I wanted something simple and easy to build. I knew that a 565 PLL could be used to decode SCA broadcasts, so out came the *Signetics Data Book*. A schematic shown in Fig. 1(a) is included, along with the specifications on the IC. Another schematic (Fig. 5) demonstrated that FSK decoding is possible. Since the two circuits were very similar, I designed a printed circuit

board to permit constructing either circuit by installing the appropriate parts.

SCA is uninterrupted background music transmitted by some FM stations for use in offices and commercial businesses such as department stores. The SCA signal is on a 67-kHz subcarrier of the regular FM channel, and is only ten percent of the total signal. The subcarrier is frequency-modulated, and has a bandwidth of plus and minus 7 kHz.

An input signal greater than 50 mV is required by the 565 to be able to operate properly. A resistive voltage divider is used to

establish the correct operating bias for the inputs, and a high-pass filter is used to attenuate the regular FM channel audio. The 67-kHz operating frequency of the 565's vco is set by the RC constant of R6 and C3. The vco requires only approximate tuning, as it will lock over a range of plus and minus 30 percent. However, a test point is provided so that the vco may be set exactly with a frequency counter. A low-pass filter and de-emphasis network is formed by resistors R7, R8, and R9, along with capacitors C6, C7, and C8. This filter removes most of the bias that usually accompanies the SCA signal.

The audio output from the 565 is approximately 30 to 50 mV and may be fed into your receiver's stereo demodulator. Most receivers today utilize an IC as a stereo demodulator and can distinguish between mono and stereo signals. A mono signal lacks a 19-kHz pilot signal, and the demodulator will automatically apply the same audio to both output channels. Coincidentally, these ICs also require about 50 mV of audio signal at the input. Most of these ICs also include the proper de-emphasis network for the regular FM signal.

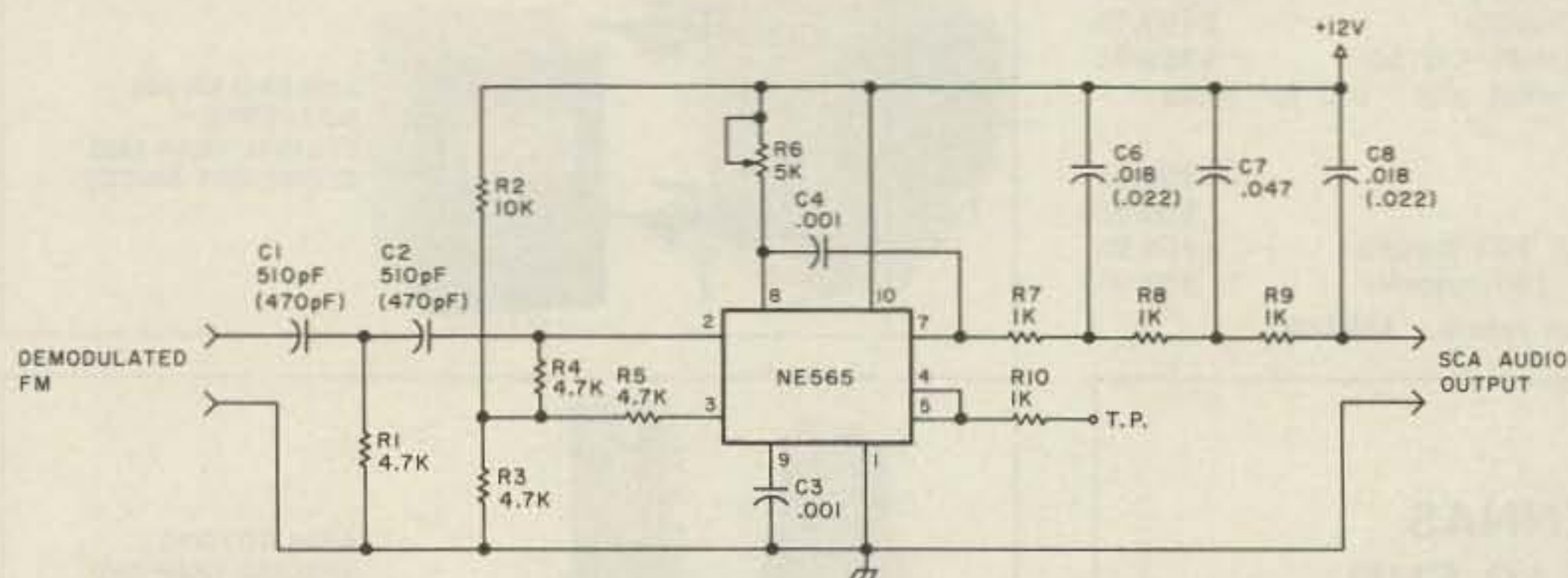

Fig. 1(a). Schematic of SCA decoder. Values in ( ) are acceptable substitutes. Adjust R6 for 67 kHz at TP.

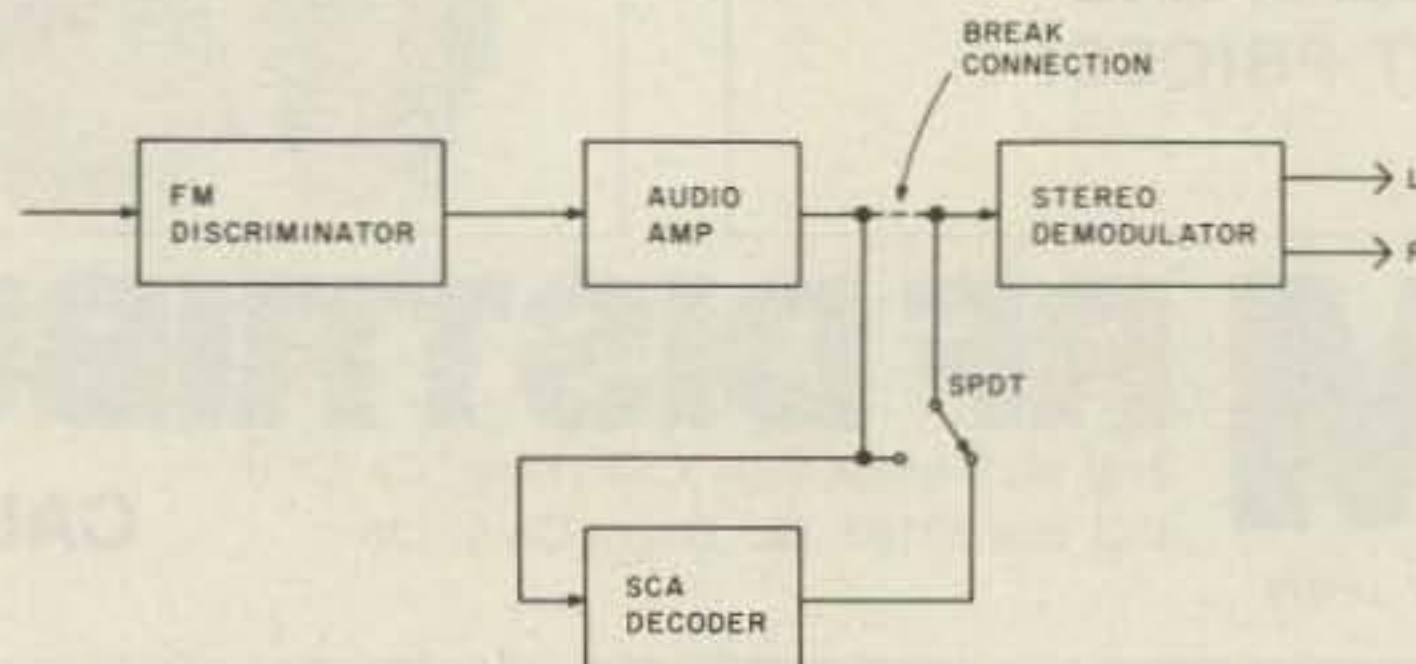

Fig. 1(b). Typical connection for decoder.

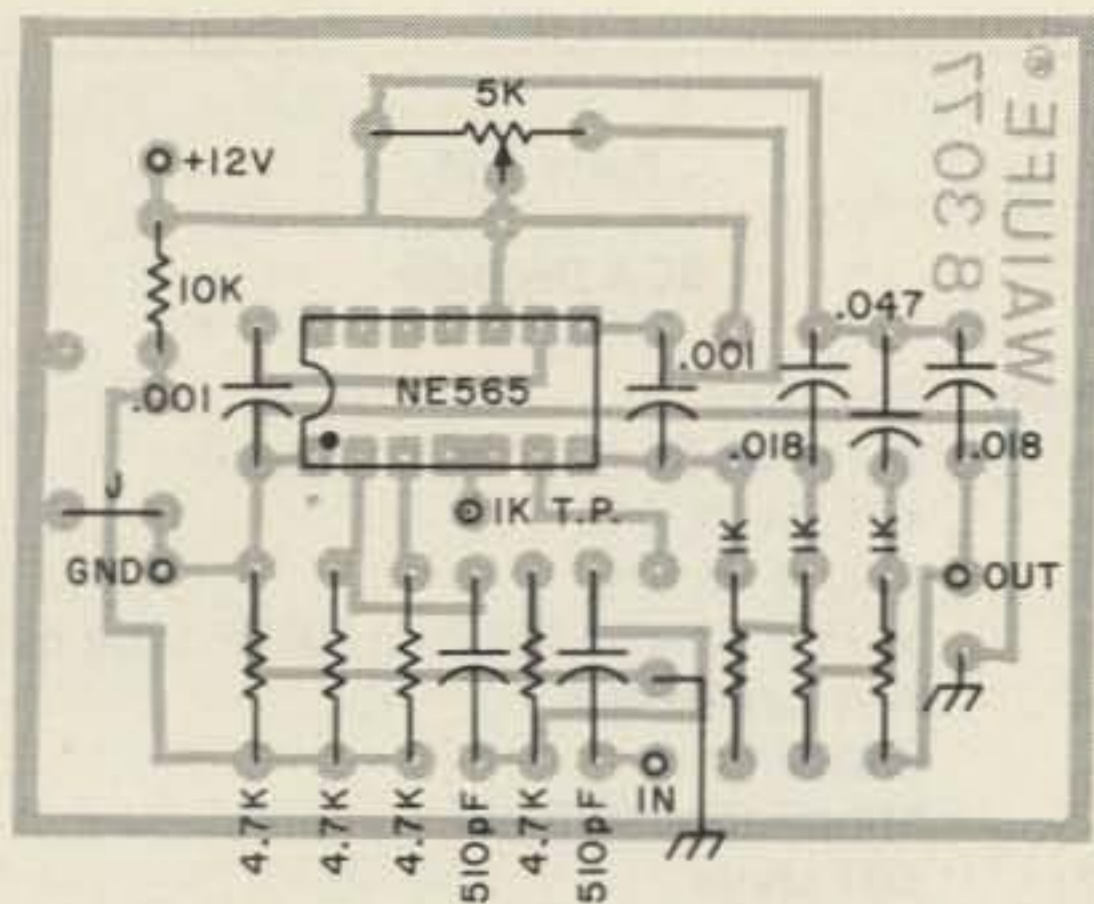

Fig. 2(a). Parts layout of decoder.

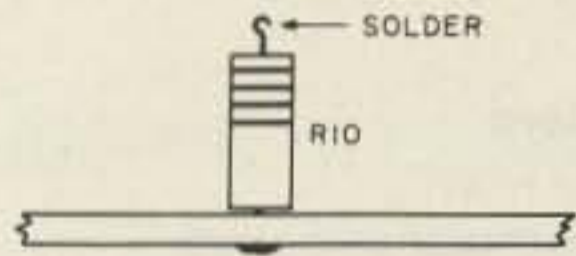

Fig 2(b). R10 TP. Mount vertically and form top lead into a loop.

The input of these ICs is usually preceded by a transistor-amplifier whose input comes from the receiver's discriminator. This signal contains both the SCA audio and the FM multiplexed audio. The demodulator normally eliminates the audio signal above 50 kHz. Fig. 1(b) shows a typical connection scheme for installing the SCA decoder. It may be to your advantage to obtain the schematic for your receiver to locate the proper connection point.

I installed an SPDT switch so that I could alternate between the regular channel and the SCA signal. This also makes it easy to locate a station in your area that transmits SCA. Just tune to each station, and flip the switch. It may be necessary to increase the volume control due to the low level of the SCA signal.

Use 1/4-Watt 5% resistors and Mylar™ capacitors, except for C1 and C2, which may be disc type. If you have difficulty obtaining exact values, acceptable substitutes are noted in parentheses. These are the values I used, and I encountered no trouble in the operation of the decoder.

Also, use shielded audio cable if the decoder is to be mounted more than a couple of inches away from the tie-in point. This will reduce the possibility of hum being picked up and amplified. Power consumption is about 8 mA, so a power switch should not be needed. Just find a point in your receiver where you can obtain +12 volts and wire the decoder to it.

#### Part Two

The FSK decoder is a little more difficult because of the dual power supply requirement. Both plus and minus 5 volts and 12 to 15 volts are needed. Fig. 9 shows a schematic for a suitable power supply.

Fig. 4(a) shows an audio processor stage to supply an approximate 50 mV signal to the input of the 565. These two amplifiers have a gain of .1, so you'll need more than 500 mV of audio input. You should be able to tap off from your receiver's headphone jack.

Fig. 4(b) is the digital processor stage. The signal from the 565 output and reference is applied to IC2a

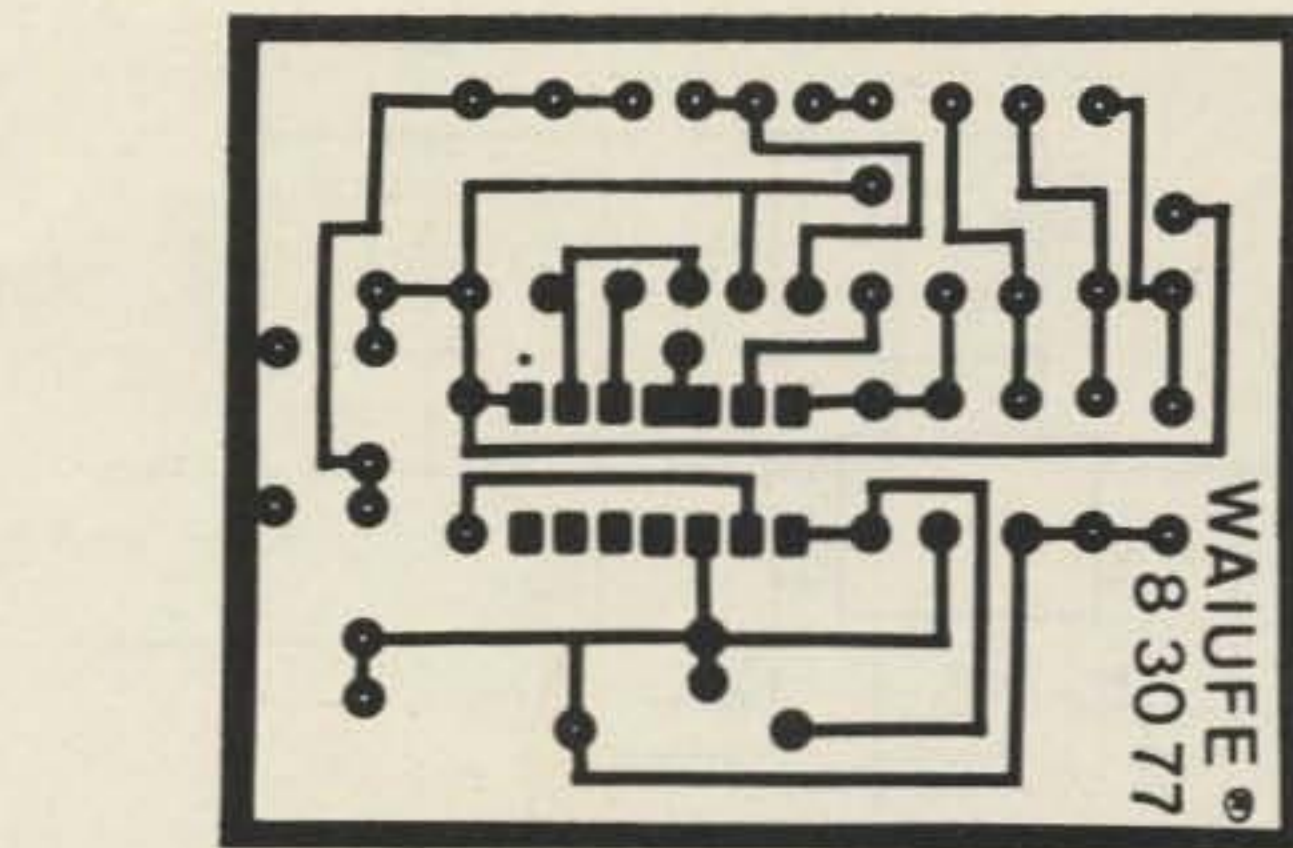

Fig. 3. SCA/FSK decoder board. Board is 2" x 2 1/2". Foil side view.

which buffers the signal. The output from this amp is a distorted square wave. IC2b further conditions the signal, and the 200k potentiometer is adjusted for a 3-volt peak-to-peak signal at TP1. IC3 converts this signal to a clean square wave. Pin 3 of IC3 should be set at -.2 volts for proper symmetry of the output signal. However, this is only an approximate setting. Due to differences in components, it may be necessary to align this stage.

There are two methods of aligning this stage. The first requires the use of a general-coverage receiver capable of tuning RTTY signals. Start by tuning in a good strong FSK signal. Try one of the RTTY net fre-

quencies. Connect the output of the decoder to the keying circuit of your page printer, and be sure that the printer is set properly for the speed of the signal being received. Use a high-impedance voltmeter between pin 3 of IC3 and ground, and adjust the resistor while watching the printer for the best copy. Take note of the reading for future reference.

The second method is for all you purists who have everything. You will need: frequency counter, oscilloscope, square wave generator with variable baud width and amplitude controls, and a voltage-controlled sine wave generator with amplitude control.

Set the sine wave gen-

For Figs. 4(a), 4(b): IC1, IC2—uA747, 14-pin DIP. Pins 9, 13—+15 V, pin 4—-15 V. IC3—uA741, 8-pin DIP. Pin 7—+15 V, pin 4—-15 V.

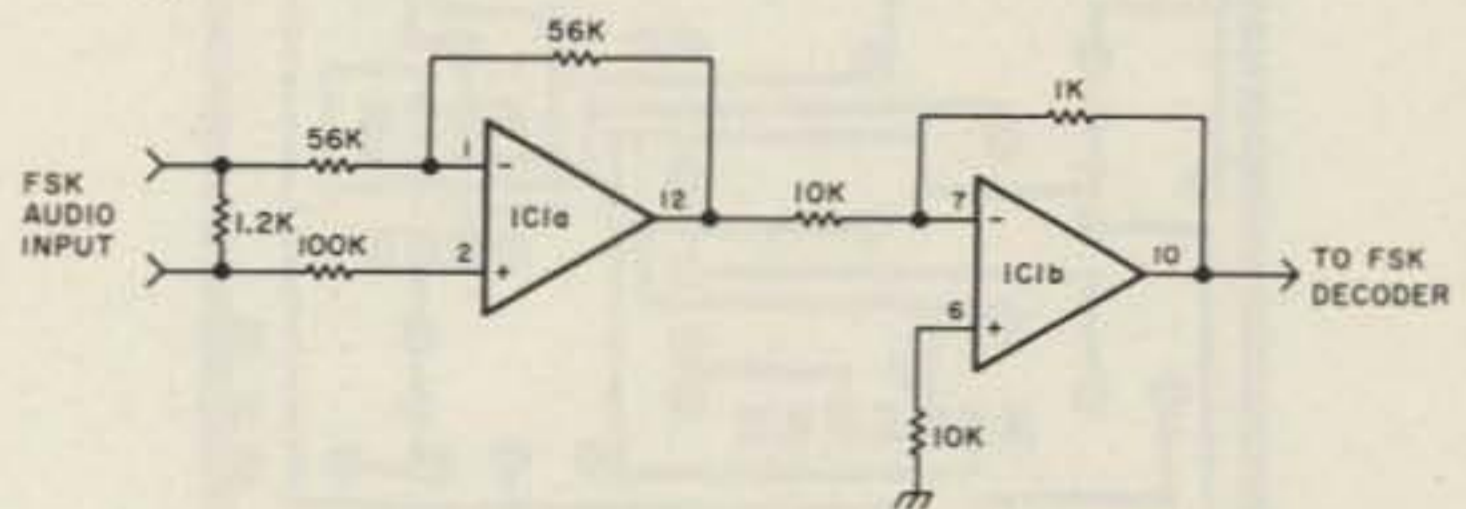

Fig. 4(a). Audio processor. Audio input > 500 mV ac.

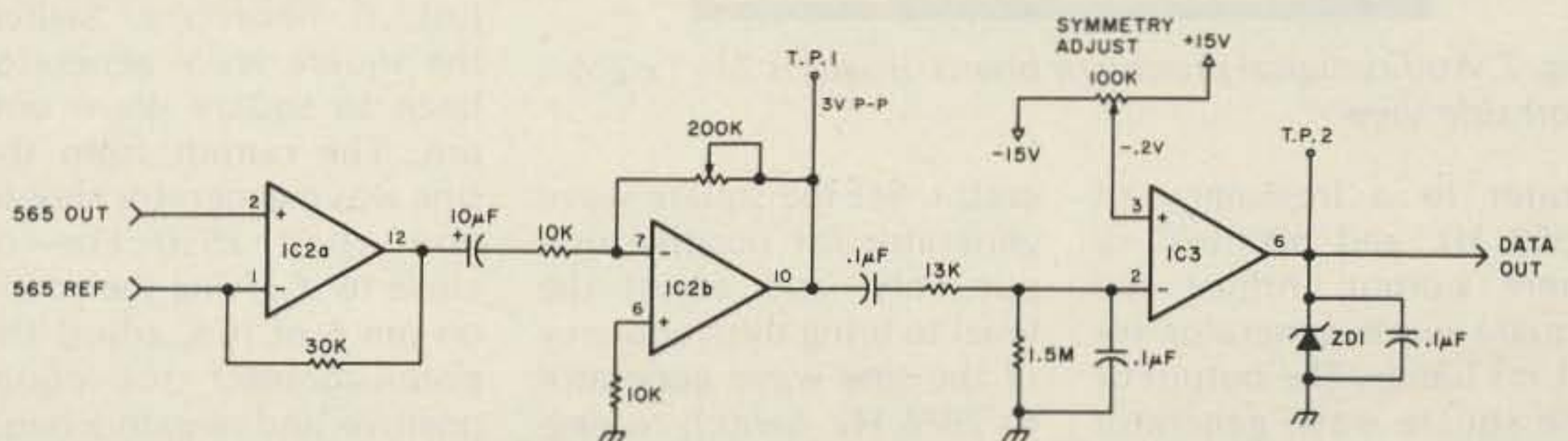

Fig. 4(b). Digital processor. Choose ZD1 for maximum output voltage required.

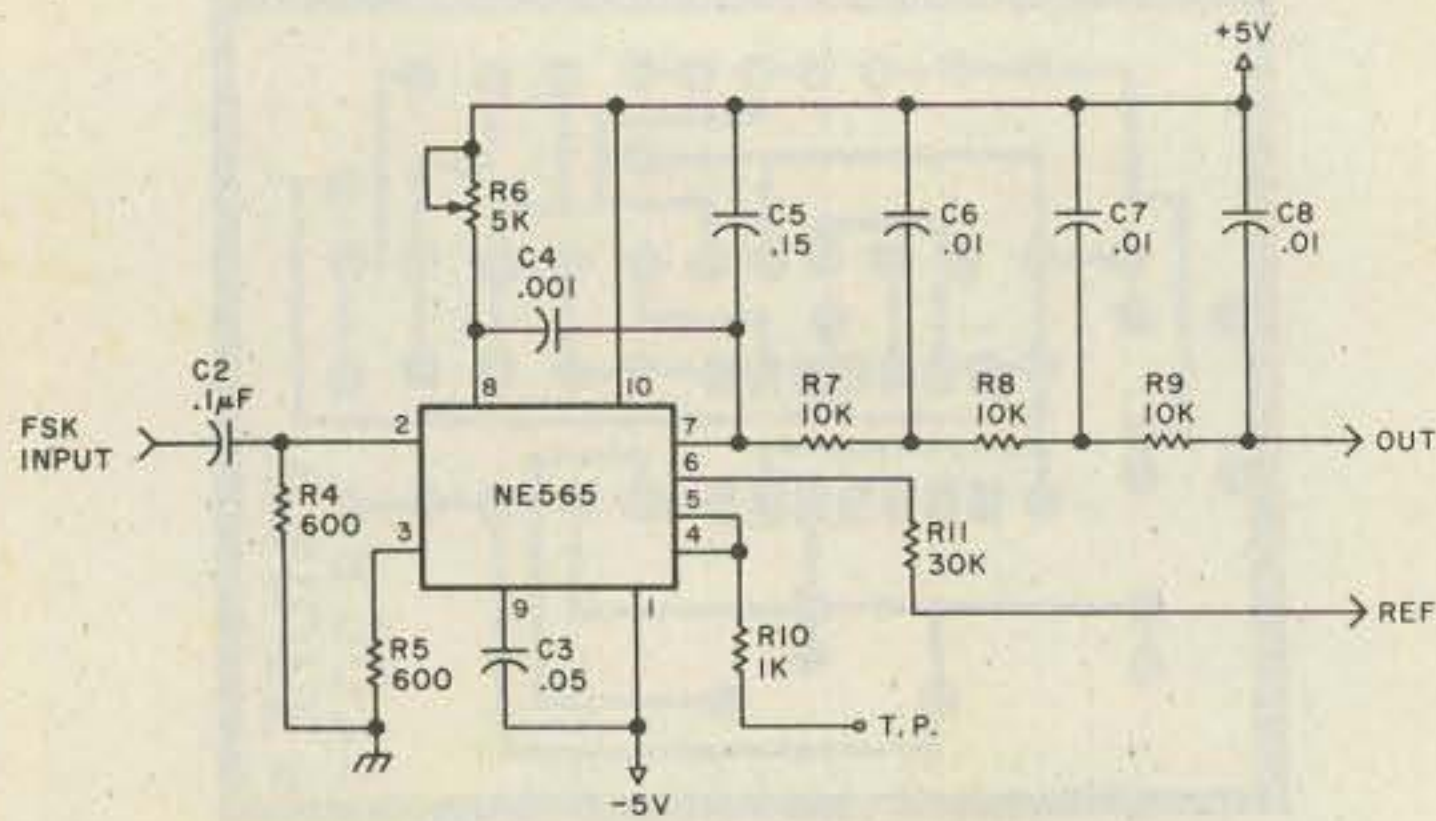

Fig. 5. Schematic of FSK decoder. Uses same board shown in Fig. 3. Adjust R6 for 2550 Hz with no input signal, for operation at 2125 Hz to 2975 Hz, 850-Hz shift.

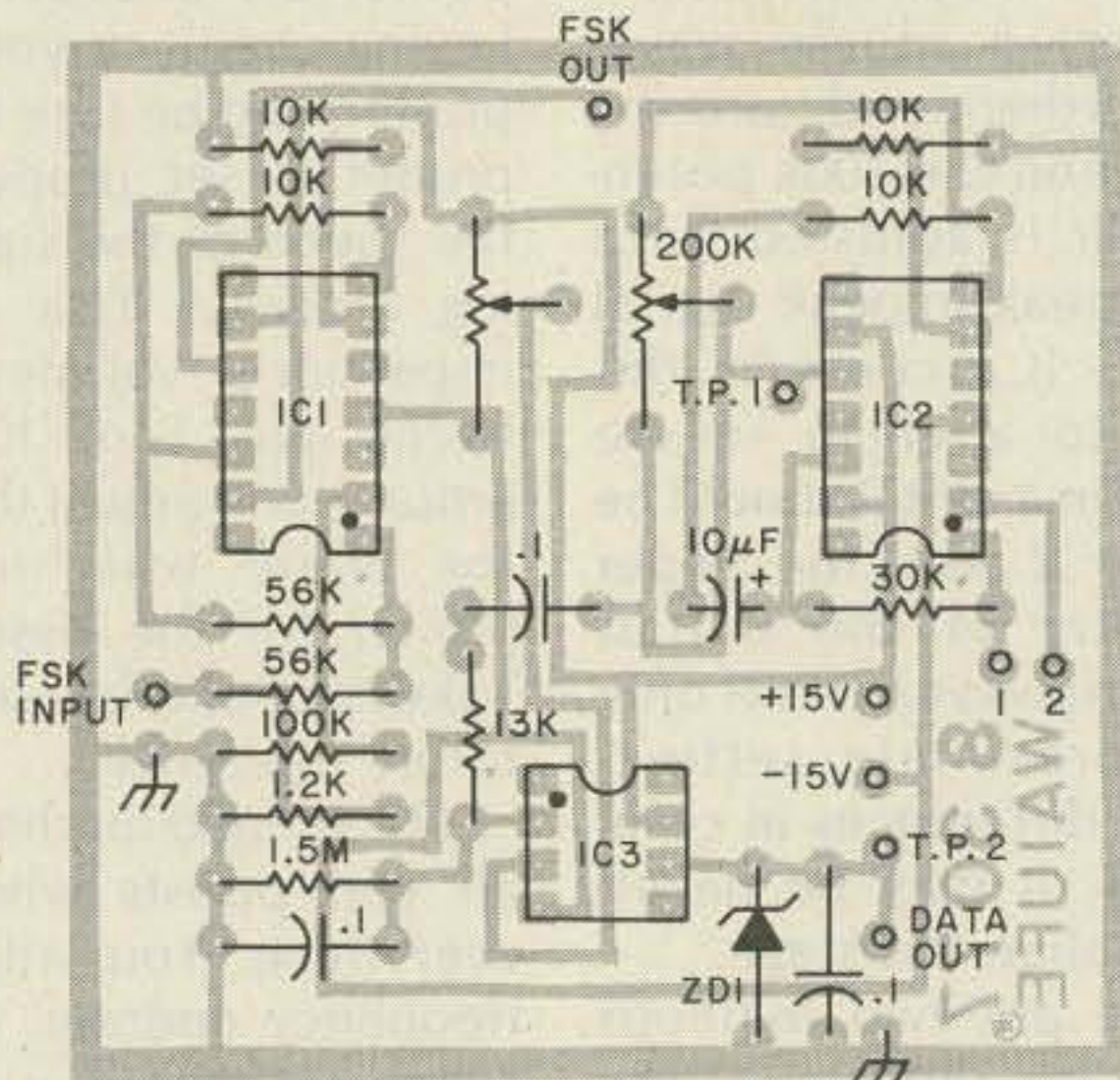

Fig. 6. Parts layout. Audio/digital processor. Pin 1, IC2: 565 reference input. Pin 2, IC2: 565 output input. Be certain that both decoder and processor boards have common ground when used together.

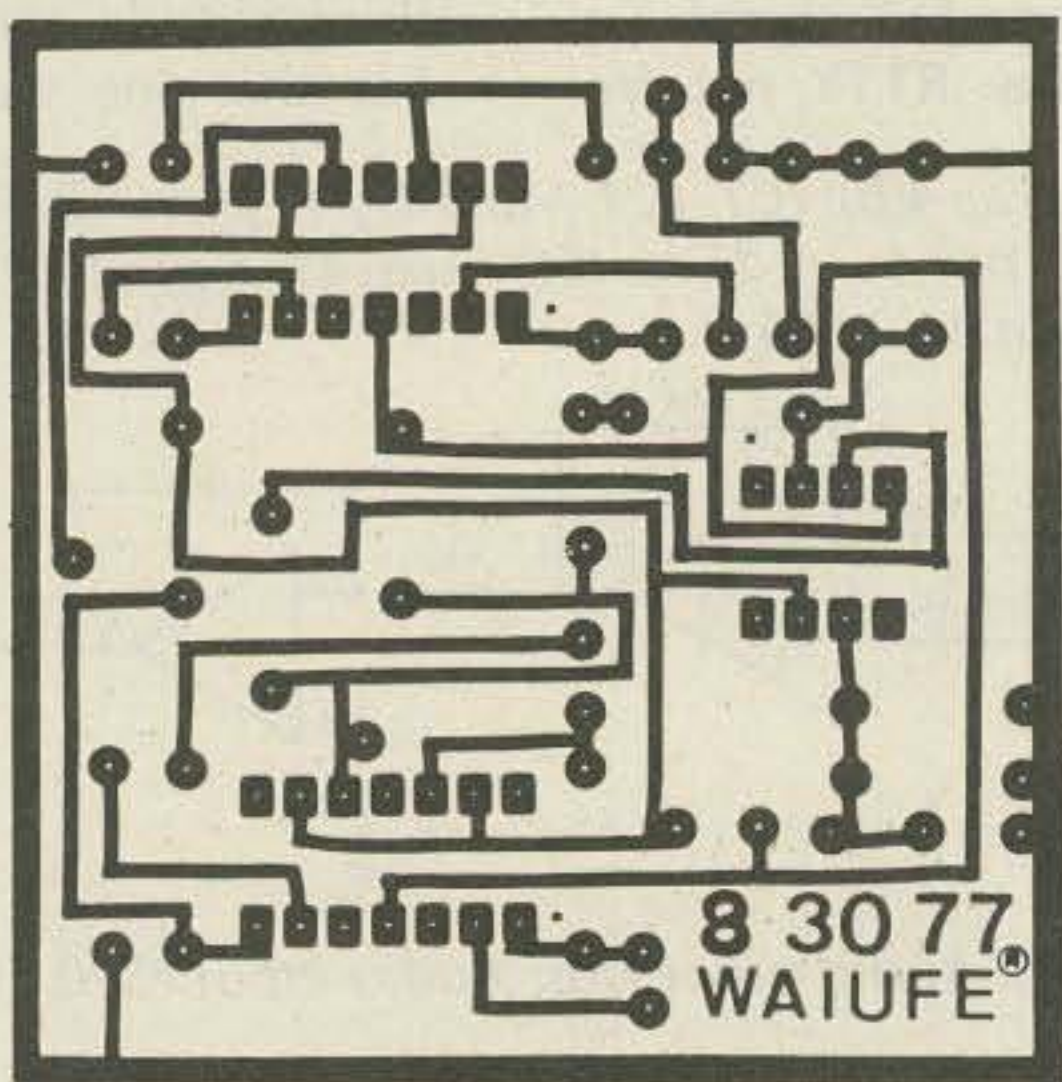

Fig. 7. Audio/digital processor board. Board is 2½" x 2½". Foil side view.

erator to a frequency of 2550 Hz and 500 mV or more output. Adjust the square wave generator for 11 ms bauds. The output of the square wave generator goes to the voltage control input of the sine wave gen-

erator. Set the square wave generator for positive output only, and adjust the level to bring the frequency of the sine wave generator to 2975 Hz. Switch to negative output only, and adjust the level for a frequen-

Parts List	
SCA Decoder	
<b>Quantity</b>	<b>Resistors</b>
4	1k, ¼ W, 5%
4	4.7k, ¼ W, 5%
1	10k, ¼ W, 5%
1	5k Pot. Bourns E-Z-Trim 3067P-1-502 or Weston 43P502
	<b>Capacitors</b>
2	510 pF Disc (470 pF)
2	.001 Mylar
2	.018 Mylar (.022)
1	.047 Mylar
	<b>ICs</b>
1	NE565
	<b>Processor Board</b>
	<b>Resistors</b>
1	1k, ¼ W, 5% (unless otherwise noted)
1	1.2k
4	10k
1	13k
1	30k
2	56k
1	100k
1	100k Pot. Bourns E-Z-Trim 3067P-1-104
1	200k Pot. Bourns E-Z-Trim 3067P-1-204
1	1.5M
	<b>Capacitors</b>
3	.1 uF Mylar
1	10 uF 25 V Tantalum Electrolytic
	<b>ICs</b>
2	747 dual op amp
1	741 op amp
	<b>Misc.</b>
1	Zener Diode (see text)
	<b>FSK Decoder</b>
	<b>Resistors</b>
2	600 Ohm, ¼ W, 5% (unless otherwise noted)
1	1k
1	5k Pot. — same as SCA Decoder
3	10k
1	30k
	<b>Capacitors</b>
1	.001 uF Mylar
3	.01 uF Mylar
1	.05 uF Mylar
1	.1 uF Mylar
1	.15 uF Mylar
	<b>ICs</b>
1	NE565

cy of 2125 Hz. Recheck the positive level again, and adjust, if necessary. Switch the square wave generator back to square wave output. The output from the sine wave generator should now read 2550 Hz—or close to it. Using the scope on pin 6 of IC3, adjust the potentiometer for equal positive and negative baud widths. The board should now be aligned, and oper-

ate properly with FSK RTTY signals.

Fig. 5 is the schematic for the FSK decoder. Note the differences in values for the change in operating frequency. Use ¼-Watt 5% resistors and Mylar capacitors here, also. R6 sets the vco frequency to 2550 Hz for 850-Hz shift RTTY. This circuit is capable of decoding down to 150 Hz shift, although for narrow shift

# 1-800-228-4097

## CALL TOLL FREE

### Hy-Gain 3806

### 2-Meter Hand-Held Amateur Transceiver



**HOLIDAY  
SPECIAL  
PRICE**  
\$109.95  
Good thru 12/31/79 only.

- Low cost, 8-channel hand-held provides superb voice transmission over short to medium distances
- Sharply tuned on-frequency selectivity in the RF amplifier stages plus FET's in the 1st and 2nd mixers for "virtual" immunity to out-of-band signals
- Intermodulation distortion and cross-modulation enhanced audio
- Separate microphone and speaker elements for enhanced audio
- Internally adjustable mic preamp—s Hy-Gain exclusive
- Specially gasketed case seals out water, dirt and corrosive salt air
- Watertight, high-impact ABS plastic case—ribbed for non-slip grip
- Top-mounted controls for instant access

**Accessories:**

Model No.	Description	Price
3807	Nucast Battery Pack	\$31.95
1104	Touch Tone Pad	\$44.95
1106	AC Battery Charger	\$ 9.95
1107	Cigarette Lighter Adapter Cord	\$ 9.95
1108	Antenna Adaptor Card	\$ 9.95
1110	Carrying Case (Leather)	\$17.85
1111	Carrying Case (Vinyl)	\$ 9.95
269	Rubber Duck Antenna	\$ 5.95
	Crystal Certificates	\$ 3.95

PLEASE ENCLOSE \$2.00 FOR SHIPPING AND HANDLING PER UNIT

CALL TOLL FREE

# 1-800-228-4097

## Communications Center

443 N 48th Street

Lincoln, Nebraska 68504

In Nebraska Call (402)466-8402

# Antenna Sale!

**HY-GAIN**

	Regular	Special
TH6DXX Super Thunderbird	\$329.95	\$269.95
TH3MK3 3 el. 10-15-20M beam	222.95	179.95
TH3JR 3 el. 10-15-20M beam	169.95	139.95
Hy-Quad 2 el. 10-15-20M Quad	274.95	219.95
205BA 5 el. "Long John" 20M beam	329.95	269.95
155BA 5 el. "Long John" 15M beam	199.95	159.95
105BA 5 el. "Long John" 10M beam	129.95	109.95
204BA 4 el. 20M beam	249.95	199.95
204MK5 5 el. conversion kit	99.95	79.95
153BA 3 el. 15M beam	89.95	79.95
103BA 3 el. 10M beam	74.95	59.95
402BA 2 el. 40M beam	239.95	189.95
BN-86 Balun for beam antennas	15.95	15.95
TH2MK3 2 el. 10-15-20M beam	149.95	119.95
TH5DX		
18HT Hy-Tower 80-10M vertical	\$369.95	\$289.95
18AVT/WB 80-10M Trap vertical	105.95	84.95
14AVO/WB 40-10M Trap vertical	69.95	57.00
12AVO 20-10M Trap vertical	42.95	34.95
14RMO Roof Mounting kit (verticals)	33.95	29.95
5BDQ 80-10M Trap doublet	109.95	89.95
2BDQ 80-40M Trap doublet	119.95	99.95
66B 6 el. 6M beam	15.95	15.95
203 3 el. 2M beam	21.95	21.95
205 5 el. 2M beam	29.95	29.95
214 8 el. 2M beam	34.95	34.95
LA-1 14 el. 2M beam	59.95	49.95
TH5DX Deluxe lightning arrester	269.95	209.95

**MOSLEY**

	Regular	Special
Classic 33 3 el. 10, 15, 20 Mtr. beam	304.75	209.95
Classic 36 6 el. 10, 15, 20 Mtr. beam	392.75	249.95
TA-33 3 el. 10, 15, 20 Mtr. beam	264.00	189.95
TA-36 6 el. 10, 15, 20 Mtr. beam	392.75	249.95
TA-33 Jr. 3 el. 10, 15, 20 Mtr. beam	197.00	149.95
TA-40KR 40 Mtr. Add On	119.95	89.95

**CUSHCRAFT**

	Regular	Special
ATB-34 4 ele. 10, 15, 20 Mtr. beam	289.95	219.95
ATV-4 10, 15, 20, 40 Mtr. Vertical	89.95	69.95
ATV-5 10, 15, 20, 40, 80 Mtr. Vertical	109.95	89.95
ARX-2 2 Mtr. Ringo Ranger	39.95	32.95
AR-6 6 Mtr. Ringo	36.95	32.95
ARX-220 220 Mhz. Ringo Ranger	39.95	32.95
ARX-450 435 Mhz. Ringo Ranger	39.95	32.95
A144-11 11 ele. 144-146 Mhz. beam	36.95	30.95
A147-11 11 ele. 146-148 Mhz. beam	36.95	30.95
A147-22 22 ele. Power Pack	109.95	89.95
A144-10T 2 Mtr. "Twist" 10 ele.	42.95	34.95
A144-20T 2 Mtr. "Twist" 20 ele.	62.95	52.95
A147-20T 2 Mtr. beam	62.95	52.95
A430-11 432 Mhz. 11 ele. beam	34.95	29.95
A432-20T 430-436 Mhz. Beam	59.95	49.95

**HUSTLER**

	Regular	Special
3-TBA 3 ele. 10, 15, 20 Mtr. beam	259.95	189.95
4-BTV 10-40 Mtr. Vertical	99.95	79.95
5-BTV 10-80 Mtr. Vertical	134.95	99.95
RM-75 75 Meter Resonator	16.95	14.50
RM-75S 75 Meter Super Resonator	31.95	27.50
G6-144B 2 Mtr. Base Colinear	79.95	59.95
G7-144 2 Mtr. Base Colinear	119.95	89.95

**ROTORS**

	Regular	Special
HAM 4 \$149.95		
TZX Tailwater \$199.95		

Call for prices on rotor cable, Coax, Towers, and Accessories. All prices do not include shipping.

**We carry all major brands of ham radios  
AT DISCOUNT PRICES**



Kenwood — Yaesu — Drake — ICOM — Dentron —  
Ten-Tec — Swan — Tempo — Midland — E.T.O. — Wilson



CALL TOLL FREE

# 1-800-228-4097

for Quality Ham Radio Products at Discount Prices

KENWOOD	DENTRON	E.T.O. ALPHA
YAESU	HY GAIN	VHF ENGINEERING
DRAKE	MOSLEY	BERK TEK CABLE
ICOM	CUSHCRAFT	CONSOLIDATED TOWER
STANDARD	WILSON	SAY
PANASONIC	HUSTLER	SHURE
AEA	LARSEN	TELEX
	BENCHER	ROBOT SSTV

Call and Talk to

Don	WBØYEZ	John	WBØMTS
Denny	WØQR	Blaine	WBØQLH
Bill	KA7CDF	Bob	WBØROZ
Joe	WAØWRI	Jim	KAØCRK

Our Mail Order Hours (CST)  
M-F 8 am to 12 Midnight  
Saturday 8 am to 6 pm  
Sunday Noon to 8 pm



**Communications Center**  
443 N. 48th, Lincoln, Nebraska 68504  
In Nebraska Call (402)466-8402



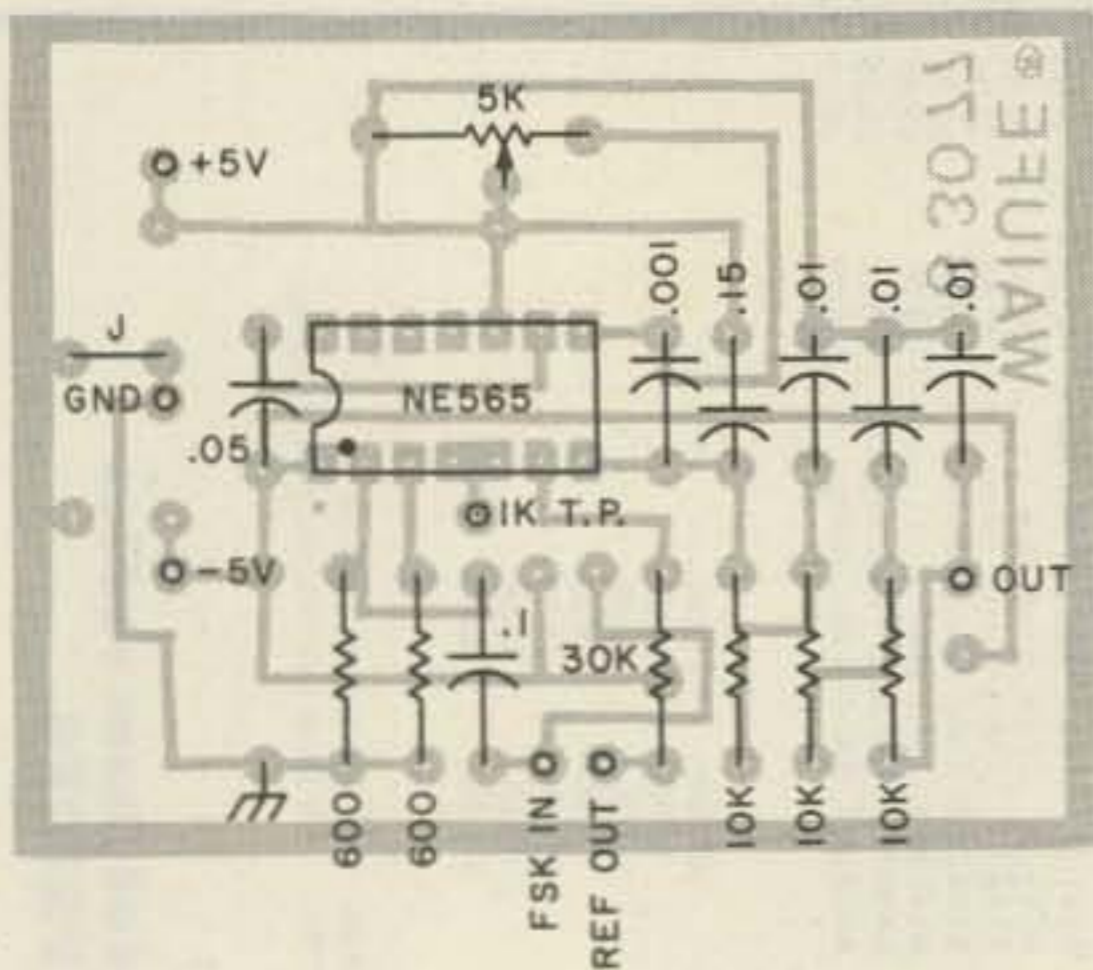

Fig. 8(a). Parts layout for FSK decoder.

RTTY, it may be necessary to add a 10k resistor between pins 6 and 7 of the 565. This will narrow the lock range, and improve the tracking of the vco. Always tune the vco for a frequency halfway between the upper and lower limits of the signal you wish to decode, with no input applied to the decoder.

Choose the zener diode at pin 6 for the output voltage required for your

application. For TTL circuits, use a 1N751, 5.1-volt zener. A 1N757 will give you 9 volts.

I haven't tried it yet, but it would seem that if the FSK decoder is tuned to 1800 Hz, it may operate for decoding audio tapes using the Kansas City Standard of 1200-2400 Hz. If it does, tape decoding for microprocessors is possible, and that makes this a three-in-one project. ■

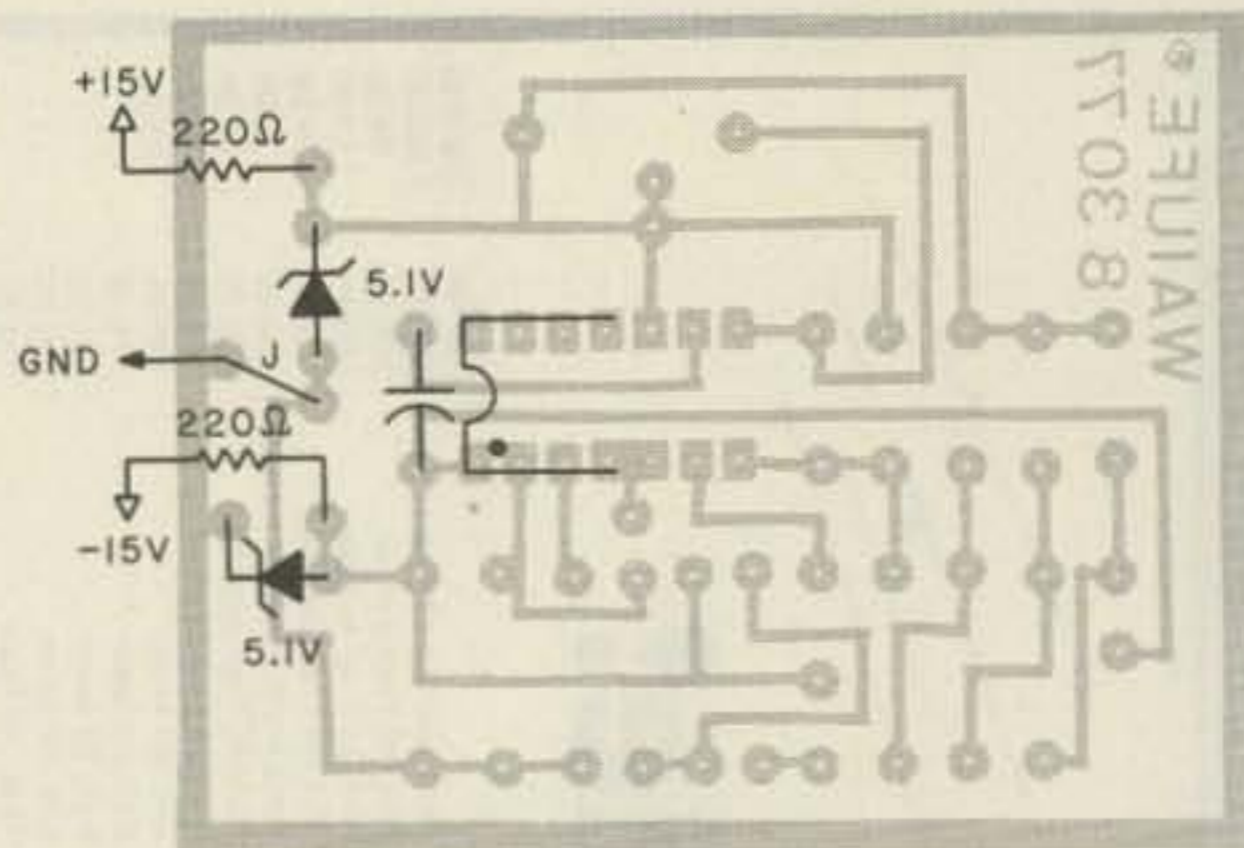

Fig. 8(b). Alternate layout for use with  $\pm 15$  V supply only. Mount 220 $\Omega$  resistors vertically.

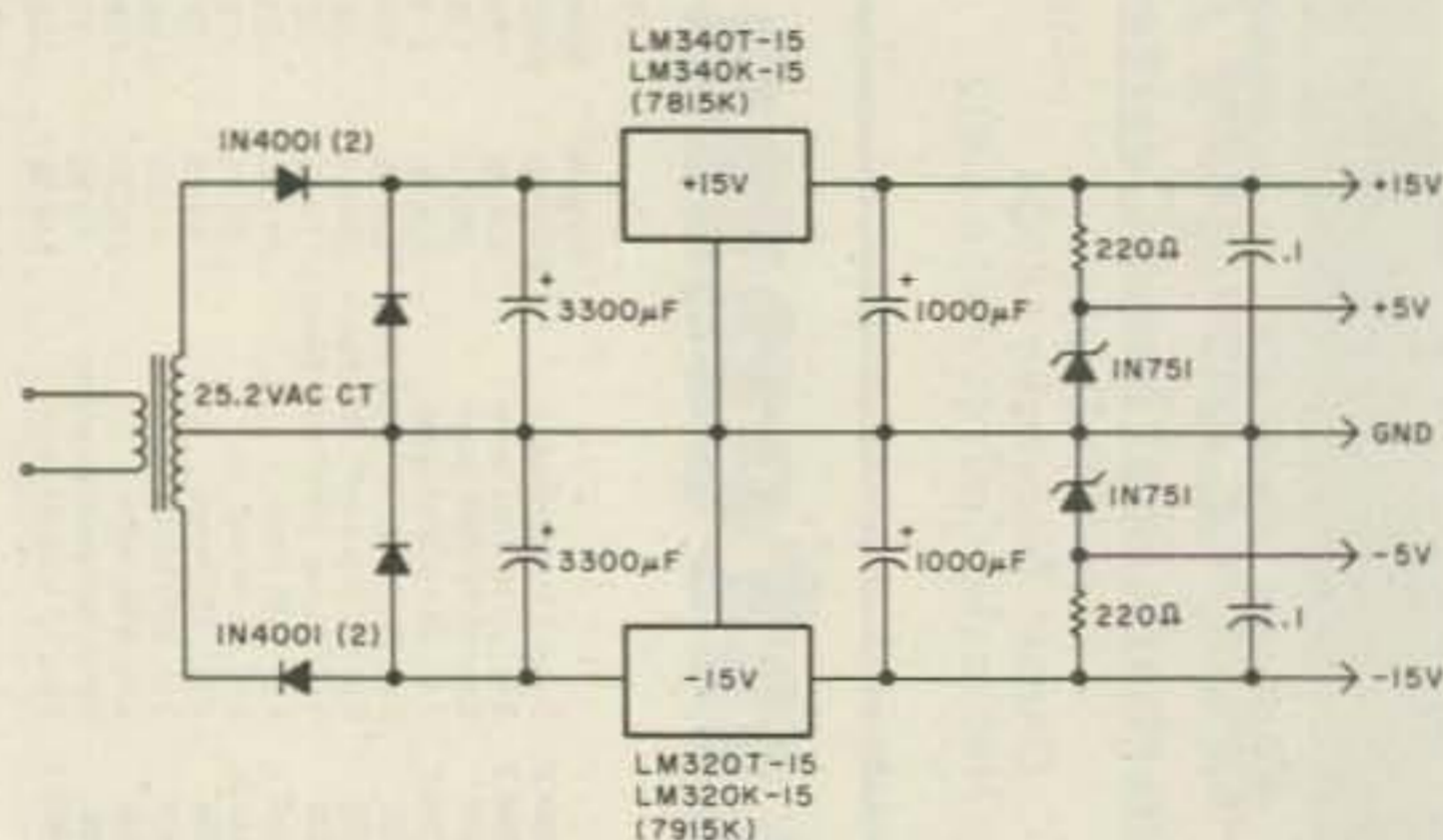

Fig. 9. Power supply for FSK decoder and processor.



# The LEADER In the Northwest!

ATLAS • ICOM • KENWOOD • YAESU



Kenwood 7600  
2m FM Transceiver



Kenwood TS180S



Kenwood TS120S



**ABC**  
COMMUNICATIONS



Yaesu FT101ZD



17550 15th Ave. N.E. • Seattle WA 98155 • (206) 364-8300



Other locations: (Walk-in customers only) • Bellevue—12001 N.E. 12th • Everett—4610 Evergreen Way • Open Mon. thru Sat.



# The MICROLOG Video Display Terminal for Morse & RTTY . . .



Permanent display of selected Mode, Speed and clock

Normal or ZOOM\* display

Computer Enhanced dual tone RTTY demod  
Audio tuning aid-on/off  
LED tuning indicator

On/off-Morse Baudot & ASCII select  
Morse calibrate & RTTY speed select

## . . . and the Story Behind It

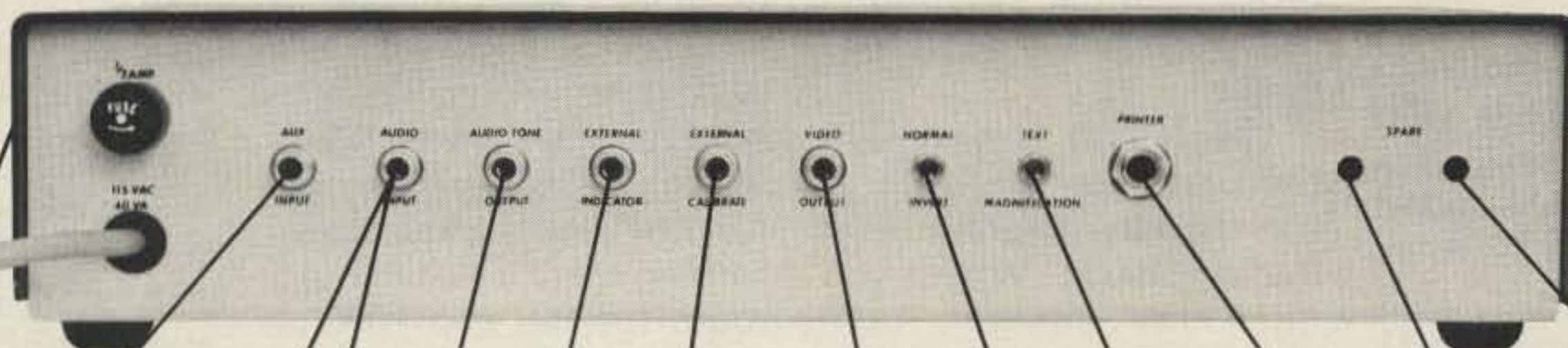

Heavy duty enclosure  
Keyboard hand Key or TTL  
Receiver speaker  
To scope display  
Remote LED  
Remote pushbutton  
Monitor or television  
Black or White screen  
Normal/Zoom select\*  
Loop or RS-232\*  
Split-Screen cable to AKB-1\*  
Computer cassette interface\*

AVR-2 Video Display Terminal	\$499
VM-4209 Video Monitor (9 inch)	\$189
VHF Video Modulator	\$ 30

Prices subject to change

\*Optional Features

One year warranty on all products. Write for additional information.



M55

**MICROLOG**  
CORPORATION

4 Professional Drive — Suite 119  
Gaithersburg, Maryland 20760  
Telephone (301) 948-5307

# Build a Simple HT Charger

## — doubles as a 12-V supply

When I acquired my Standard handie-talkie in 1972, I went all out—leather case, rubber ducky, mini mike, fistfull of crystals, and a shiny black charger.

The SCH HUC1 charger was prone to losing its filter capacitors (bad lot or something) without giving any indication of malfunction except that a full charge would last only a few hours. Since Standard chose to use a voltage quadrupler circuit, that loss required four new 100- $\mu$ F capacitors.

Recently, I bought a

Heathkit 2 meter 10-Watt amplifier for use with the handie-talkie on trips and in rental cars. The amp takes about 100 mA in transmit. I decided to build a 12-volt two-Amp power supply in the charger case and replace the charger circuit with one of the new three-terminal regulators in a constant current mode.

The circuit is easy—all the parts are available at the friendly neighborhood Radio Shack. When you open the charger, take everything out. The slide switch is too big with the new transformer in place

and you have to drill some holes anyway, so take everything out and drop the remains in the junk box. You will use only the line cord and the cabinet. The chassis is the S-shaped piece of steel surrounded by the outside shell.

I used banana jacks  $\frac{3}{4}$  of an inch apart for output terminals and a small piece of P-type vectorboard to hold the small parts. If you use the existing switch hole for one end of the transformer, there is just enough room for the two 1000- $\mu$ F filter capacitors to be crammed lengthwise against the transformer

frame. There is not much room, but underneath the capacitors, is a five-terminal phenolic terminal strip bolted to the other mounting hole of the transformer. This terminal strip holds the four-terminal bridge rectifier, the positive ends of the filter capacitors, provides a ground contact, and connects the secondary of the power transformer.

I tried to use a 12-volt rms transformer, but, with only 2000  $\mu$ F in the filter, the output voltage under load drops to about 8 or 9 volts. Using a higher voltage transformer allows the regulator circuit to handle the ripple dynamically, since the dc instantaneous value never drops below 14 volts.

Output ripple under load was measured at under 30 millivolts; no hum is detectable without instruments on the rf carrier. The pass transistor is bolted to the bulkhead inside the charger case. Install it with a mica washer and be sure that there is no short between the collector and the case. Note the fuse in the schematic for short-circuit protection. It

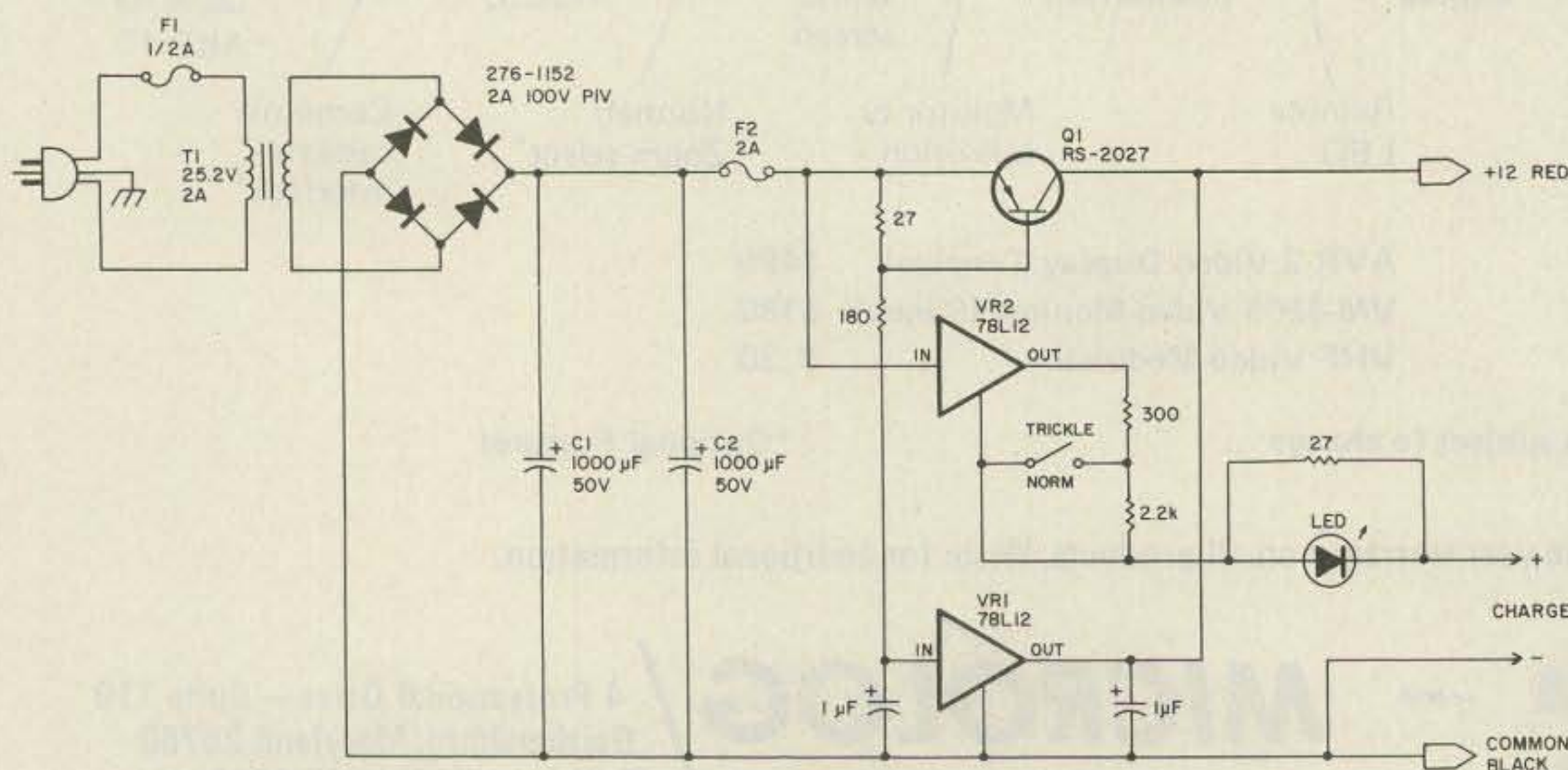

Fig. 1.

# Amateur Radio Supply of Nashville, Inc.

615 South Gallatin Road - Madison, Tennessee 37115

## CALL A.R.S.O.N. NOW!

# 615 868-4956

## for the Best DEALS

Sure, we take trades on new equipment! Call or write.

We're Burning to Make "Hot" Deals!!

We no longer print a Catalog. We carry all major lines. Use this Magazine as your catalog. Call or write for price quotes!



Accepted at slightly higher prices!

**YAESU**

NOW IN STOCK!  
**FT1012D**  
Digital 160M-10M  
Deluxe Features  
Check the others then get our price!



**YAESU FT 901 DM**  
Call for yours today!



SWL's! - FRG7 and FRG7000  
All band receivers in stock!

**NEW! YAESU FT207R**  
Synthesized Handi-Talkie.  
Call now for our price!  
We stock the complete YAESU line!

**KENWOOD**

**NEW! TS 520 SE**  
A new version of the FAMOUS STANDARD!  
Call or write for our price!



**NEW! TS 180S**  
All Solid State with Digital Frequency Control. 200W P.E.P. Memory.  
Best Price Anywhere!



**NEW! TS 120S**  
ALL SOLID STATE HF TRANSCEIVER PLUS A FULL LINE OF ACCESSORIES!



**DRAKE**

**TR/DR-7**  
Now in stock!  
Full 7 line of accessories!



**TEN-TEC OMNI**  
Unbeatable Prices!  
Century 21, 540, 544, 545, 546 - Argonaut, Plus all Accessories!



D&A

**SWAN ELECTRONICS** - **NEW!**

**ASTRO 150**  
HF SSB Transceiver featuring "VRS"  
Fully Synthesized 235 Watts PEP & CW.  
See the Swan ads and Call us or write for BEST PRICES ANYWHERE!



**NEW! 102BX**  
Dual PTO's SYNTHESIZED 1.8-30 MHz  
235 Watts PEP



**DATONG**  
We have in stock the amazing Datong FL-1 active audio filter. Also now have the ASP, Automatic speech processor... plus the Code tutor... Fantastic additions to your station. Call or write for information and prices.

**ICOM**  
701, 211, 215, 280, 30A & 255A  
All in stock now!

**ROBOT**

**SSTV - ROBOT**  
PUT YOURSELF IN THE PICTURE!  
Get in on the latest in Ham Radio!  
CALL OR WRITE NOW FOR PRICES!



**DSI Counter Semi-kit**  
Get on Frequency! Write or call for special price!



**ANTENNAS CUSHCRAFT - HYGAIN**  
LARSEN - HUSTLER - AVANTI  
**SPECIAL!** Cushcraft ATB34 - \$220.00  
Delivered anywhere in the Cont. U.S.A.  
**HYGAIN** - NEW TH5DXX IN STOCK!

**avanti antennas**

The fantastic new Avanti 2 meter Mobile Antenna - mounts on your car window glass! 3 DB gain. Neat and compact installation!  
**SPECIAL PRICE - \$30.00!**  
Please send Cashiers Check or Money Order. Delivered anywhere in the cont. U.S.A.

USED EQUIPMENT? OUR STOCK TURNS FAST!  
WRITE OR CALL YOUR SPECIFIC NEEDS!

Prices quoted in this Ad guaranteed until 12/31/79, or as Manufacturer's supplies last!

**Dentron**

**Dentron GLA 1000**  
1 KW DC INPUT!  
1200 W. PEP!  
LOW PRICES!



**CLIPPERTON L**  
1 KW DC INPUT!  
2 KW P.E.P.  
In Stock - Low Prices!



MLA 2500 B - DTR 2000L  
Dentron Antenna Tuners and Antennas.  
CHECK OUR LOW PRICES!

**MIRAGE** MP1 HF & MP2 VHF  
SWR MTR. - B108 2M AMP. & B1016  
160 WATT, 2M AMP. In Stock, call or write!

**TRIONIX INC**

**TR-1000 - 600 MHz**  
Frequency Counter now in stock!



**BW** ANTENNA SWITCHES in stock!

**DAIWA**  
**J. W. Miller**



Call or write for SUPER LOW prices!

**MFJ ENTERPRISES, INC.**  
TUNERS - FILTERS - We've got 'em!  
CHECK US FIRST!

Fast UPS Delivery. Place your order then STAND BACK!  
We ship your order the same day we get it!  
Best prices and quick handling of your order!

**TR 7600/7625** **TS 700SP**  
**HOLIDAY SALE!** Special low prices!  
TR 7600/7625 and RM 76 Micro Processor, and TS 700SP - Call or write for these special lowest prices yet!



**NEW!** Ask us about the NEW  
**TR 2400 2M**  
**HANDI TALKIE!**



**R-1000**  
Deluxe Communications Receiver  
**NEW!** Full coverage to 30 MHz. DIGITAL READOUT-3 Position Filters - Also available HS-5 Deluxe Headphones & matching speaker SP-100.



**NEW!** **KENWOOD OWNERS!** We have the new Kenwood Phone Patch!  
We stock the full KENWOOD line and provide warranty and after-warranty service.  
**BUY WITH CONFIDENCE!**

**ALLIANCE Rotor Special**  
**SPECIAL OFFER!!** **ALLIANCE HD-73**  
\$105.00 including Shipping in U.S.A.  
HD-73 with 100 feet rotor cable \$120.00  
HD73 with 100 feet rotor cable and 100 feet R8BU \$150.00  
Cashiers check or M.O. please



**CDE ROTOR SPECIALS**  
The NEW HAM IV Rotor  
Shipping included

**LIMITED QUANTITY!**

HAM IV Rotor \$147.00  
HAM IV Rotor with 100 ft. rotor cable \$162.00  
HAM IV Rotor plus 100 ft each rotor cable and first grade R8BU \$185.00  
Send cashiers check or M.O.  
**BEAT THE PRICE INCREASE! Order NOW!**  
Prices on CDE Rotors good ONLY until 12/31/79.



STORE HOURS - Monday thru Friday, 9 AM to 5 PM

# Amateur Radio Supply of Nashville, Inc.

was hard-wired into the lead from the bridge to Q1, and its ends were covered with tape.

Because the open circuit charging voltage is over 25 volts, be sure your handie-talkie's external power jack is wired so that the nicads are always connected to the charger pads and disconnected from the radio power bus when the external jack is plugged in.

The constant-current

regulator, VR2, maintains the regulator voltage across the series resistance. To find the resistance value for any constant current within the regulator's power range, divide the regulator voltage by the desired constant current.

With the switch in the normal charging position, the regulator delivers a constant 43 mA (just like the Standard circuit was

supposed to) even into a short circuit with no ill effects. I connected two battery packs in series and the current was still just 43 mA. The LED gives positive indication of charging current—43 mA will never hurt the nicads. The trickle-switch position reduces the charge current to around 7 mA and is used when the handie-talkie gets only infrequent use. The 27-Ohm resistor across the LED

shares the current in the normal charge mode to prevent burning out the LED. In the trickle mode, not enough current is left to illuminate the LED. The normal/trickle switch is installed in one of the rivet holes from the old slide switch; the LED is spot-epoxied into the other rivet hole.

I now have a charger I'm sure of and a utility 12-volt supply as well! ■

Charles Willson K2GMZ  
505 East Main St.  
Palmyra NY 14522

## Do-It-Yourself Carrying Case for Wilson HTs

— save \$14.88

I'm the proud owner of a new Wilson Mark II HT,

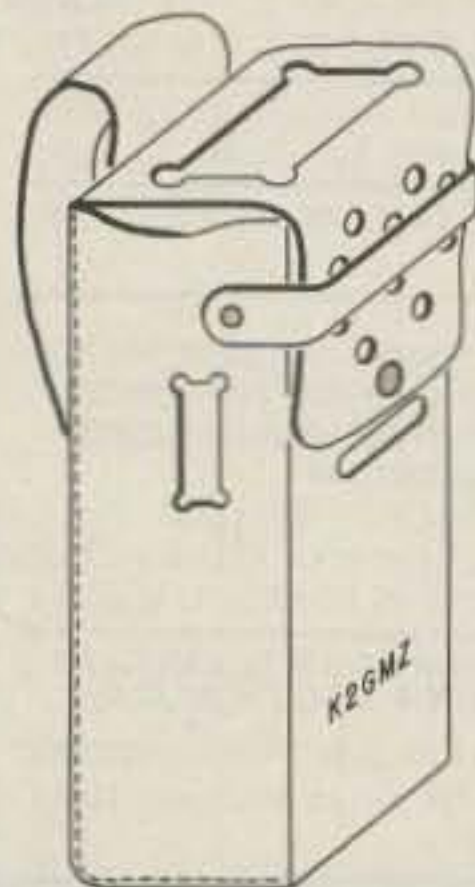

Fig. 1. Instamatic camera case—after surgery.

which I had the good fortune to win at the 1978 Syracuse hamfest. This little gem came complete with .52-.52 xtals, rubber ducky antenna, and a wall charger for the nicad battery pack.

The first thing I did, after I came down to earth, was to fire off an order to a 73 advertiser for crystals for several local repeater frequencies.

Next, I needed a carrying case. Ouch. The Wilson (no relation, unfortunately) leather case lists at \$18.95.

Seemed like an extravagant outlay for a case to carry around an HT which merely cost me the price of a dollar raffle ticket!

An alternative which came to mind was, "Can a nearsighted, middle-aged ham with two left hands consisting of ten thumbs cut out and sew a leather or vinyl case which would have enough class to house this fabulous HT?" The painfully obvious answer to this question was a resounding "No!"

While wandering through the camera department of

a local discount department store (K-Mart), I spotted a top-grain cowhide leather Instamatic-type camera case which had the exact dimensions I needed. Cost? \$4.07 plus sales tax.

A few minutes worth of surgery using an X-acto knife as a scalpel, and *voilà*, a case which could compete with the high-priced spread. In addition to the openings shown in Fig. 1, I punched a hole in the bottom which allows me to plug in the charger without having to remove the unit from the case. ■



# Radio World



CENTRAL NEW YORK'S LARGEST HAM DEALER

## HOLIDAY SALE DAYS

YOU MIGHT BE ABLE TO BEAT OUR PRICES . . .

. . . BUT YOU WON'T BEAT OUR SERVICE

*Season's Greetings  
From Our Staff*

Warren/K2IXN  
Bob/WA2MSH  
Allan/WA2MSI  
Norman/K2KLV  
Jack/WB2LCP  
Chuck/WA2GJN  
Bev/K2TPE  
Val/KA2GNA



YAESU  
FT225RD



YAESU  
FT-901DM



SWAN  
ASTRO  
150



YAESU  
CPU-  
2500RK

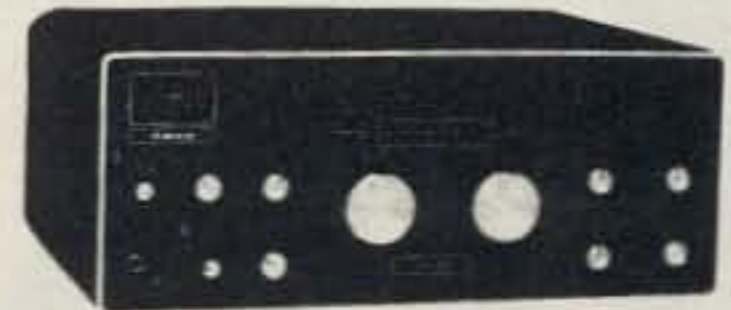

SWAN  
102BX

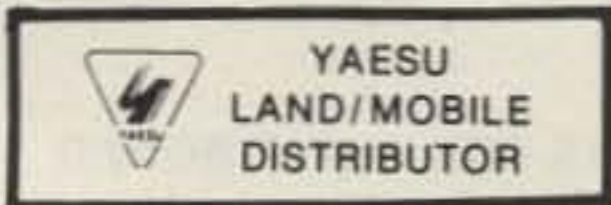

DENTRON  
CLIPPERTON L



KDK  
FM2016A



DRAKE  
TR7-DR7

All Sales Over \$750.00 Will Entitle You To A  
FREE 1980 Callbook Until December 31st.

OUT OF STATE  
CALL TOLL FREE

# 1-800-448-7914

Featuring: Yaesu, Drake, Ten-Tec, Dentron, ICOM, Atlas, Robot, Swan, Midland, Wilson, KDK, MFJ, Bird, Tempo, Astron, KLM, Hy-Gain/Telex, Mosley, Larsen, Cushcraft, Hustler, Mini-Products, Universal, Tri-Ex, Aluma Tower, Vibroplex, Bencher, Microwave Module, DSI, Anteck, Electronic Research, CES, Ham Key.

**WE SERVICE EVERYTHING WE SELL!**

**CALL FOR A QUOTE . . . YOU WON'T BE DISAPPOINTED**



We are just a few minutes off the NYS Thruway (I-90) Exit 32



Warren  
K2IXN

ONEIDA COUNTY AIRPORT TERMINAL BUILDING  
ORISKANY, NEW YORK 13424

Bob  
WA2MSH

315-337-2622 or 315-337-0203

# 1-800-633-3410 TODAY!

CALL LONG'S TOLL FREE

## LONG'S CHRISTMAS BUYERS GUIDE



Prices in this catalog subject to change without notice. Prices good only while supply lasts.

**DON'T WAIT**

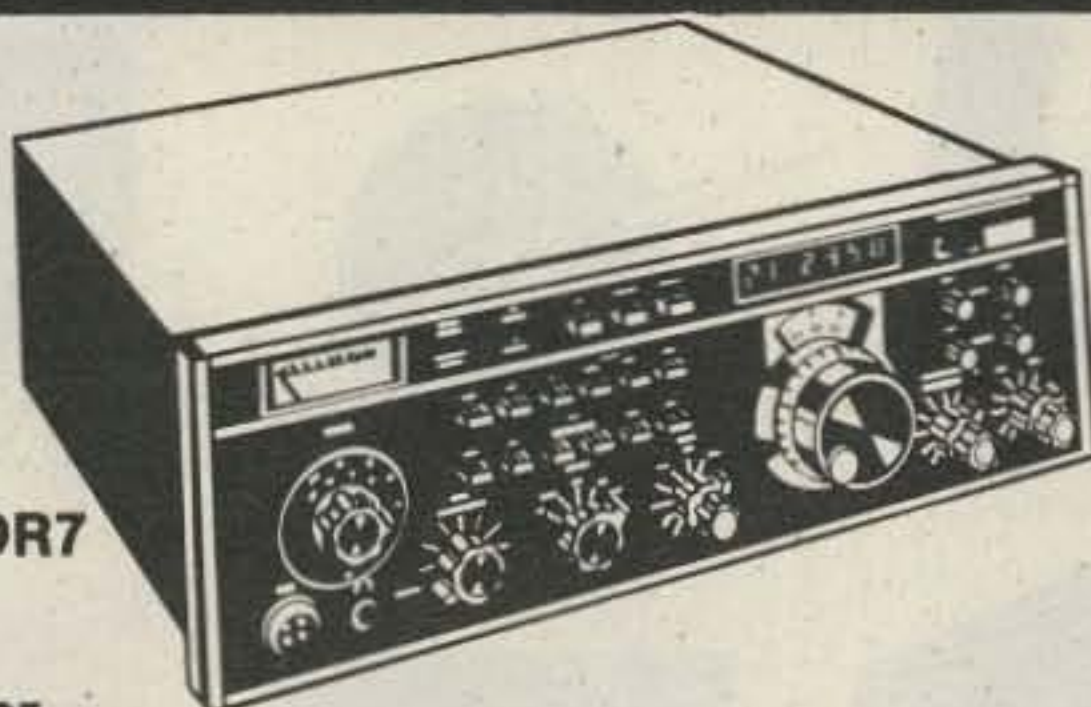

### DRAKE TR/DR7 Solid state synthesized HF transceiver

Covers 160 thru 10 meters, reception from 1.5-30 continuous, 0-30 MHz with optional AUX-7, modes: USB, LSB, CW, RTTY, AM. True pass and tuning, RIT, built-in RF wattmeter/SWR bridge, SSB 250 watts PEP, CW 250 watts, AM 80 watts. Power supply required for AC operation, PS-7 120/240V power supply available.

**1395.00** List. Call for quote.



#### ACCESSORIES

DL1000 1000W dummy load .....	49.95
DL300 300W dummy load .....	24.95
FA-7 fan for use with the TR/DR7 .....	25.00
NB7 noise blanker for TR/DR7 .....	90.00

#### FILTERS FOR THE TR/DR7

SL-300 CW filter .....	52.00
SL-500 CW filter .....	52.00
SL-1800 SSB, RTTY filter .....	52.00
SL-6000 AM filter .....	52.00

#### INTEGRATED CIRCUITS FOR AUX. 7 BOARD

RRM-7 plugs in for receive .....	7.50
MS-7 matching speaker .....	36.00
AUX.-7 extended range board for the TR/DR7 .....	45.00

#### MICROPHONES

7077 deck mic. Modes: push to talk or VOX, dynamic, high impedance, freq. res.: 300-5000 Hz, 4 pin connector .....	45.00
--	-------

### ICOM IC-551 50 MHz all mode transceiver

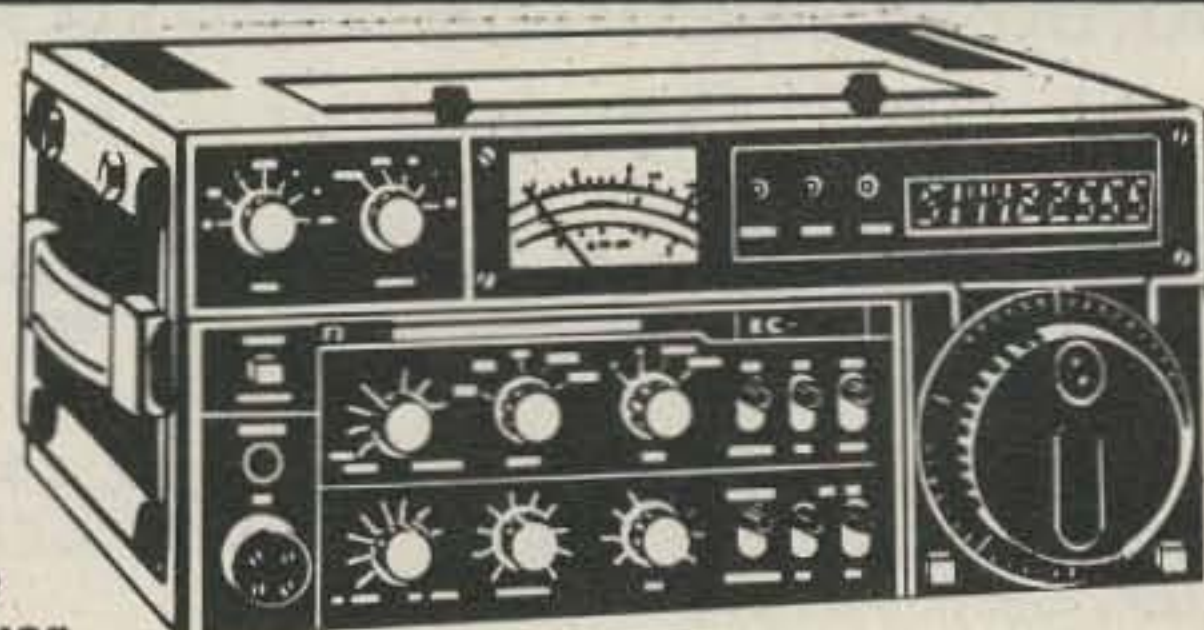

An all mode, 6 meter unit with multipurpose scanning. Either memory scan (monitor 3 different channels) or program scan (scanning between 2 programmed frequencies). It also features built-in dual VFO's, built-in AC/DC power supplies, digital readout, 10 watts, noise blanker, high quality crystal filter, and scans the 6 meter band. Options include EX-108 (pass band tuning), EX-106 (FM board) and EX-107 (VOX).

**489.95** Call today.



### YAESU FT-227RB 2m FM transceiver



With 4 memory channels, a remote scan for mic, can select to scan clear or busy channel, a frequency coverage of 144 to 148 MHz, 800 channels, power requirements: 13.8 VDC at 2.5 amps continuous, RF output: 10W hi/1W lo, tone burst  $\pm$  600 KHz repeater offset. Complete with YM-22 touch tone mic.

**425.00** List. Call for quote.



# Long's Electronics



# CALL LONG'S TODAY!

1-800-633-3410 TOLL FREE

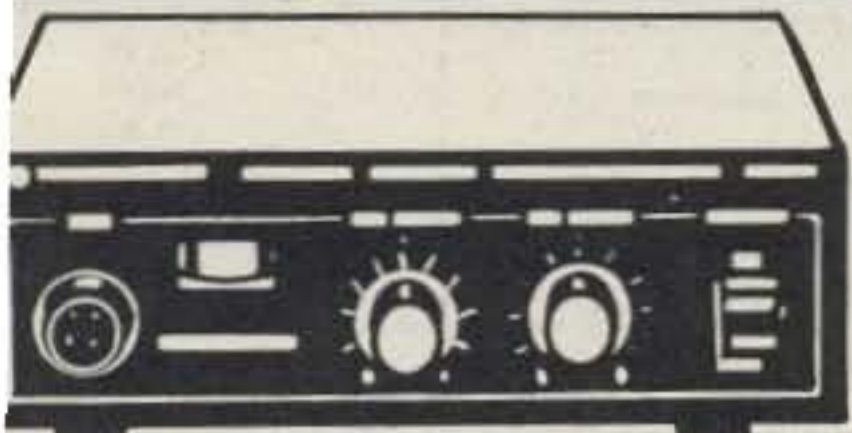

**KENWOOD PC-1 phone patch**  
A matching phone patch for Kenwood equipment. It has NULL control, RX gain control and TX gain control. It may be connected between a transceiver and phoneline.

**59.95** Call today.



**KENWOOD PS-30 power supply**

Designed to match the TS-180S/TS-120S, this unit supplies regulated 13.8 VDC at 15A continuous, 20A intermittent load with complete ease and safety due to the use of generous heat sinks and an automatic reset electronic overload trip.

**139.00** Call for quote.



**KENWOOD MC-50 dynamic desk mic**

This mic has dual impedance, 50 ohms or 50K ohms. Compatible with Kenwood equipment.

**45.00** Call today.

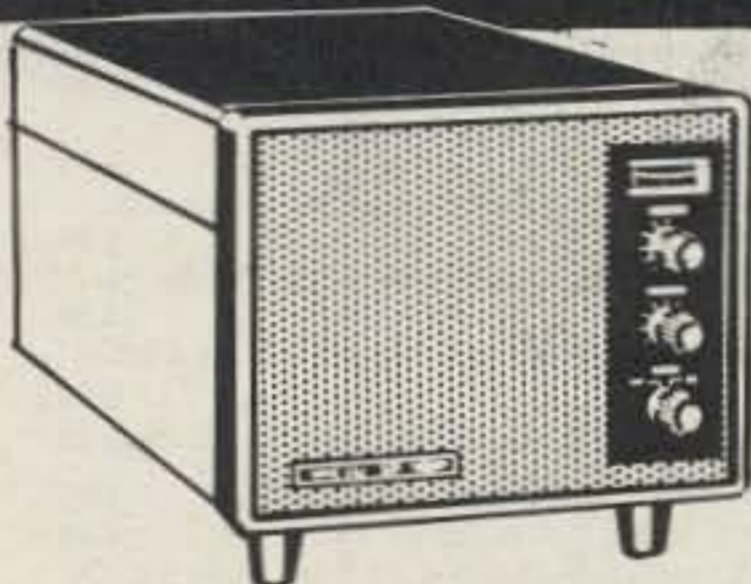

**SP-901P speaker/patch**

A speaker/phone patch to match the FT-901 series. The unit has full metering and level controls.

**74.00** Call today.

**BIG BUY!**

**200 Watts PEP! KENWOOD TS-180S solid state HF transceiver with Digital Frequency Control**

With 4 memories, manual scanning, tuning in 20 Hz steps with recall of stored frequency. Cover 160 to 10 meters. Needs no tune up. Built-in microprocessor, digital display, IF shift, selectable bandwidth, tunable noise blanker, RF AGC, dual RIT, improved speech processor, 13.8 VDC operation. Adaptable to proposed bands.



**1149.95** List. Call for quote.

**BIG BUY!**

**200 WATTS PEP! KENWOOD TS-120S All solid state HF SSB transceiver**

No tune up! Miniaturized circuits, solid state construction, built-in digital display, IF shift, final transistor protection, VOX, noise blanker, 25 KHz marker. Frequency range is 80 to 10 meters and WWV, modes: SSB and CW, power requirements: RX-0.7A 13.8 VDC, TX-18A 13.8 VDC. 3 1/2"Hx9 1/4"Wx13 1/2"L. Weight: 11.7 lbs.



**699.95** List. Call for quote.



**YAESU FT-101Z high performance HF transceiver**

Covers 160 thru 10 meters plus WWV, modes are: LSB, USB, and CW, built-in power supply, built-in RF speech processor, built-in noise blanker, variable IF bandwidth, analog frequency readout, 6146 final tubes with RF negative feedback, heater switch, VOX, attenuator 10 dB or 20 dB selectable. Power requirements: 100/110/117/200/220/234 volts AC 50/60 Hz.



**749.00** List. Call for quote.



**ICOM IC-701 HF transceiver**

All solid state, 100W continuous duty on all bands, all modes. 160 thru 10 meters, dual built-in digital VFO's for split frequency operation, VOX, semi-break-in CW, RIT, AGC, noise blanker, and built-in speech processor. IC-701 PS needed for AC operation. Power supply requirements: DC 13.6V negative ground

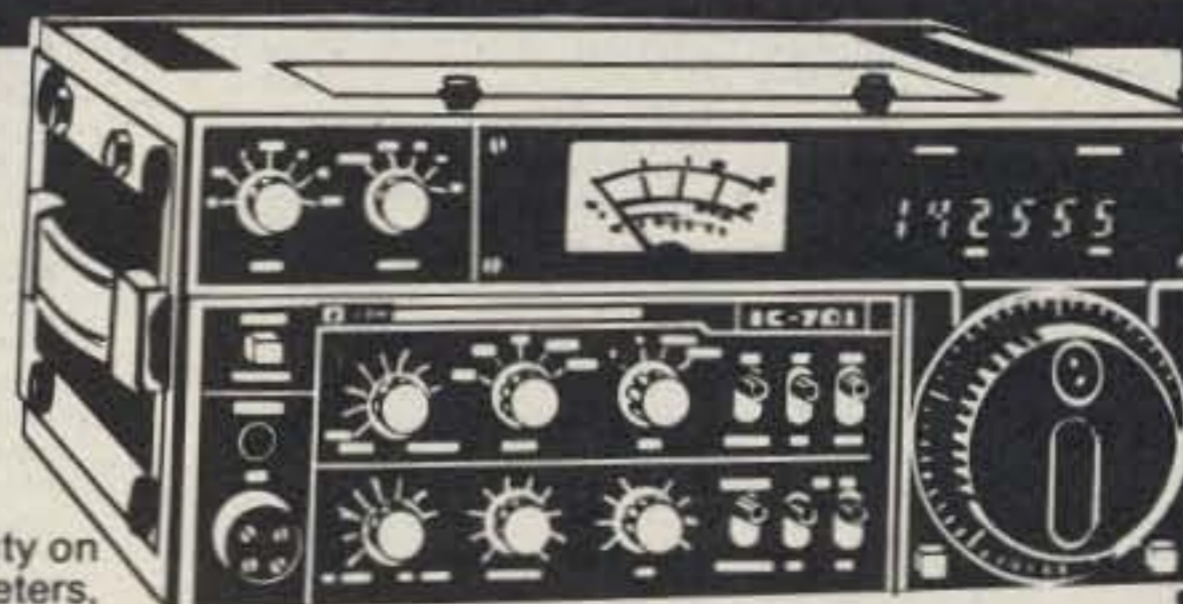

**1169.00** Call today.

VISA

# Long's Electronics



# & MAPS CALL TOLL

FOR YOUR BOOKS, TAPES



## ARRL Publications

**ARRL Radio Amateur's Handbook** Newly revised & jam-packed with everything from basics to latest developments. I.N. 10081 ..... 9.75

**ARRL Radio Amateur's License Manual** The most up to date compilation of rules & regulations. Covers from Novice to Extra Class. I.N. 10012 ..... 4.00

**ARRL Novice Q and A Book.** A new pocket sized study guide with 223 sample question and answers and a sample novice exam. 96 pages. I.N. 10008 ..... 2.00



**ARRL Antenna Handbook** Complete instructions for building antennas of all types. I.N. 10026 ..... 5.00

**ARRL World Map** I.N. 10099 ..... 3.50

**LCF Calculator** Slide rule type calculator to compute resonant frequency, etc. A great aid! I.N. 10062 ..... 3.00

**Electronic Data Book** All you need to know about Filter design, RF circuit data, antennas and feedline info & more. I.N. 10027 ..... 4.00

**Learning to Work With Integrated Circuits** Build a digital voltmeter/freq. counter while learning about IC's. I.N. 10060 ..... 2.00

**Single Sideband for the Radio Amateur** Covers theory and practical how-to-built ideas. I.N. 10017 ..... 3.00

**FM and Repeaters for the Radio Amateur** Learn all about FM and repeaters from this handy book. I.N. 10014 ..... 5.00

**Solid State Design for the Radio Amateur** Packed with information for practical use of solid state devices. I.N. 10061 ..... 7.00

**Solid State Basics** Pure solid state information and practical basics for today's ham. I.N. 10037 ..... 5.00

**ARRL Repeater Directory** By Stan Horzepa, WA1LOU. Handy sized booklet with room for your own notations. I.N. 10047 ..... 1.00

**ARRL Radiogram Message Pads** I.N. 10007 ..... 75 ea.

**ARRL Special Operating Kit** Consists of ARRL Ham Radio Guide, full color U.S. area call map, ARRL log book, 70 ARRL radiograms. I.N. 10063 ..... 6.50

**ARRL Ham Radio Operating Guide** Brush up on good operating practices with this ready reference source. I.N. 10025 ..... 4.00

**ARRL Satellite Communications** Includes Getting to Know OSCAR, info on the "RS" satellites, maps, locators and more! I.N. 10064 ..... 4.75

**80 meter DXing Handbook.** Contains 4 sections on propagation, antennas, station equipment, and operating practices. It's filled with solid practical experience. I.N. 26307 ..... 4.50

**The Amateur Radio Vertical Antenna Handbook.** The first book for amateurs solely about vertical antennas. It is full of information. I.N. 26316 ..... 5.00

**The Challenge of 160** The unique operating characteristics are explained and there are tips on building simple equipment. I.N. 26312 ..... 4.95

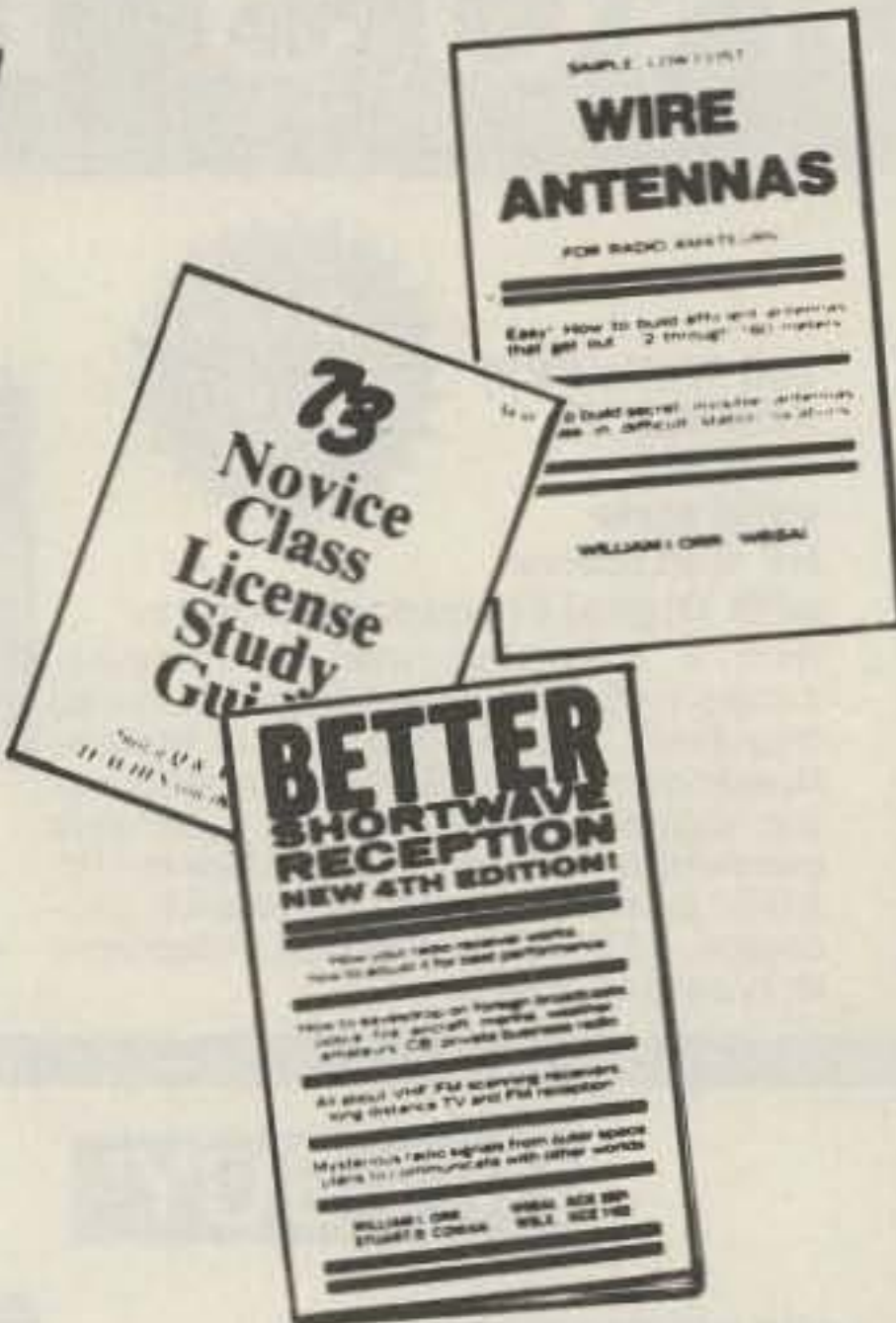

**Hints and Kinks** New ideas written by hams themselves. This is full of practical ideas and tips that they have used successfully. I.N. 10029 ..... 4.00

**Radio Frequency Interference** A new book to help everyone understand RFI. It covers all from good neighbor relations to simple technical cures for RFI. Helps identify and solve problems. I.N. 10083 ..... 3.00



**ARRL Code Kit** Upgrade your Novice or Tech. License with these 2 60 min. cassettes with speeds of 5, 7 1/2, 10, & 13 wpm. Instruction book included. I.N. 10046 ..... 8.00

**ARRL Log Books** spiral bound books  
Large I.N. 10015 ..... 1.75  
Small I.N. 10020 ..... .75

**Tune in the World with Ham Radio** Learn all about amateur radio with a text and a morse code cassette. For the beginner studying for the Novice exam. I.N. 10031 ..... 7.00

**Understanding Amateur Radio** A must guide for the newcomer, it explains in simple language elementary principles of electronics & tells how to build low cost equipment. I.N. 10016 ..... 5.00

## Radio Publications, Inc.

**Beam Antennas Handbook** by Wm. Orr, W6SAI. I.N. 26200 ..... 4.95

**Wire Antennas** by Wm. Orr, W6SAI. I.N. 10058 ..... 5.95

**All About Cubical Quad** by Wm. Orr, W6SAI. I.N. 26201 ..... 4.75

**The Truth About CB Antennas** by Wm. Orr, W6SAI. I.N. 26202 ..... 5.95

**EIMAC's Care and Feeding of Power Grid Tubes** I.N. 26205 ..... 5.95

**The Antenna Handbook** I.N. 26207 ..... 6.95

**VHF Handbook** by Wm. Orr, W6SAI. I.N. 26203 ..... 5.95

**Better Short Wave Reception** by Wm. Orr, W6SAI. I.N. 26204 ..... 4.95



## Ameco Books

**Communicate with the World with Ham Radio NP-1** I.N. 24825 ..... 6.95

**Ameco 7-01 Question and Answer Guide for the Novice Exam** I.N. 24828 ..... 1.00

**Ameco 12-01 General Class Question and Answer Guide.** I.N. 24829 ..... 1.50

**Question & Answer for Advanced Class Exam 16-1** I.N. 24809 ..... 1.50

**Question & Answer for Extra Class Exam 17-1** I.N. 24810 ..... 1.50

**Radio Amateur Theory Course 102-01** I.N. 24812 ..... 5.95

**Radio Electronics Made Simple** I.N. 24800 ..... 2.50

**Logbook** I.N. 24807 ..... 1.50

**Commercial Radio Operator Theory Course 15-01** I.N. 24808 ..... 6.95

**Commercial Q&A License Guide Ele. 4 10-01** I.N. 24805 ..... 1.95

**Commercial Q&A License Guide Ele. 3 9-01** I.N. 24804 ..... 2.95

**Commercial Q&A License Guide Ele. 1, 2, & 8, 8-01.** I.N. 24803 ..... 1.50

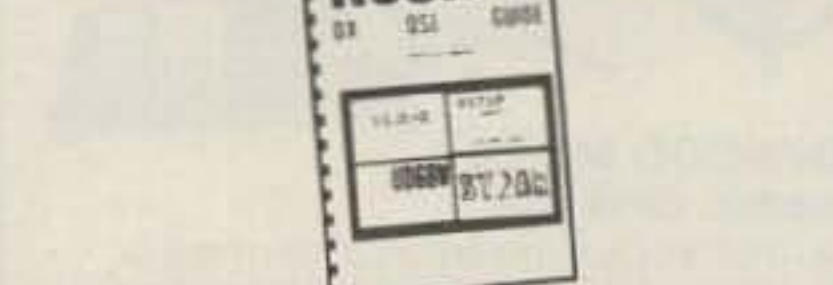

## Other Great Books

**Practical Antennas for the Radio Amateur** by Robert Myers, W1XT. A new basic antenna book to tell you every thing about making and using antennas. Ills. with pictures and line drawings. I.N. 32407 ..... 9.95

**Collins Radio Co. SSB Amateur Single Sideband** I.N. 10092 ..... 4.95

**73 Magazine VHF Antenna Handbook** I.N. 26303 ..... 4.95

**73 Magazine Novice Class Study Guide.** I.N. 26300 ..... 4.95

**73 Magazine General Class Study Guide.** I.N. 26301 ..... 5.95

**The Beverage Antenna Handbook.** I.N. 26208 ..... 5.00

**K3CHP DX QSL Guide** I.N. 26313 ..... 3.95

**Amateur TV in a Nutshell** I.N. 26322 ..... 5.00

**How to Make Better QSL's.** I.N. 26304 ..... 4.95

**The Complete Handbook of Slow Scan TV.** I.N. 30518 ..... 9.95

Remember, you can Call Toll Free: 1-800-633-3410 in the U.S.A. or call 1-800-292-8668 in Alabama for our low price quote. Store hours: 9:00 AM til 5:30 PM, Monday thru Friday.

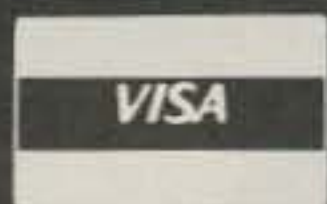

# Long's Electronics



MAIL ORDERS P.O. BOX 11347 BIRMINGHAM, AL 35202 • STREET ADDRESS 2808 7TH AVENUE SOUTH BIRMINGHAM, ALABAMA 35203



# FREE 1-800-633-3410 OR

# ORDER BY MAIL TODAY

## Tab Books

- Novice Class Study Guide I.N. 30517 ..... 5.95
- General Class Study Guide I.N. 30519 ..... 7.95
- Advanced Class Study Guide I.N. 30522 ..... 5.95
- Extra Class Study Guide I.N. 26302 ..... 5.95
- A Beginners Guide to Microprocessors I.N. 30502 ..... 5.95
- 57 Programs and Games in Basic I.N. 30501 7.95
- The "Compulator" Book I.N. 30509 ..... 7.95
- Ham Radio Incentive Licensing Guide I.N. 30503 4.95
- Programming Microprocessors I.N. 30508 6.95

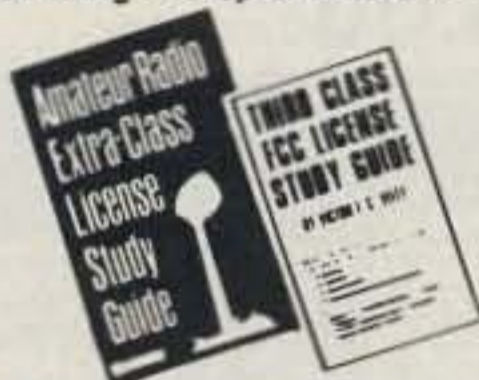

- Third Class FCC License Study Guide I.N. 30514 6.95
- First Class FCC License Study Guide I.N. 30542 7.95
- Electronics Data Handbook I.N. 30549 ..... 5.95
- Impedance I.N. 30520 ..... 5.95
- Basic Digital Electronics I.N. 30527 ..... 4.95
- Basic Electronic Problems Solved I.N. 30545 4.95
- Tower's International FET Selector I.N. 30500 6.95
- Second Class FCC Encyclopedia I.N. 30535 7.95
- How to Use AF and RF Signal Generators I.N. 30512 ..... 5.95
- Electronics Unraveled I.N. 30531 ..... 5.95
- Master Transistor/IC Substitution Handbook I.N. 30510 ..... 7.95
- RF and Digital Test Equipment You Can Build I.N. 30521 ..... 5.95
- Commercial FCC License Handbook I.N. 30542 7.95
- IC Projects for the Amateur and Experimenter I.N. 30543 ..... 5.94
- How to Read Electronic Circuit Diagrams I.N. 30546 ..... 6.95

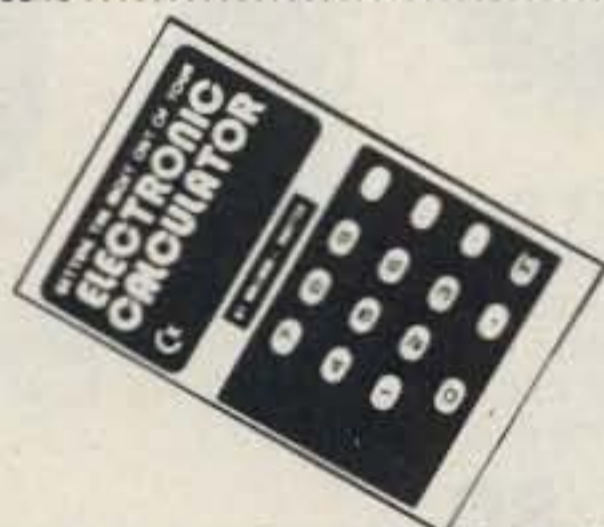

- Getting the Most Out of Your Electronic Calculator I.N. 30528 ..... 4.95
- How to Install Everything Electronic I.N. 30552 7.95
- The 2 Meter FM Repeater Circuit Handbook I.N. 30537 ..... 6.95
- Modern Applications of Linear IC's I.N. 30530 9.95
- Mobile Radio Handbook I.N. 30534 ..... 4.95
- Basic Electricity and Beginning Electronics I.N. 30536 ..... 5.95
- Practical Solid State DC Power Supplies I.N. 30515 ..... 6.95
- Electronic Conversions, Symbols, and Formulas I.N. 30524 ..... 5.95
- Tower's International Transistor Selector I.N. 30507 ..... 6.95
- Electronic Test Equipment and How to Use It I.N. 30526 ..... 4.95



- Master Handbook of 1001 Practical Electronic Circuits I.N. 30523 ..... 9.95
- Master Handbook of Ham Radio Circuits I.N. 30506 ..... 8.95
- Complete Short Wave Listeners handbook I.N. 30532 ..... 6.95
- Master OP-AMP Applications Handbook I.N. 30505 ..... 9.95
- C.E.T. License Handbook I.N. 30513 ..... 8.95
- Effective Trouble Shooting with EVM and Scope I.N. 30525 ..... 5.95
- Handbook of Electronic Tables I.N. 30548 4.95
- Homebrew HF/VHF Antenna Handbook I.N. 30504 ..... 5.95
- How to Be a Ham I.N. 30533 ..... 3.95



## Radio Amateur Callbook

- Map Library A complete set of maps, prefix world map, great circle chart, map of N. America, and world atlas. I.N. 10005 ..... 3.75
- Callbook binders
  - U.S. callbook red I.N. 10054 ..... 6.00
  - DX callbook blue I.N. 10055 ..... 6.00
  - DX Callbooks I.N. 10001 ..... 15.95
  - U.S. Callbooks I.N. 10000 ..... 16.95
  - Prefix map of North America I.N. 10004 ..... 1.25
  - Zone prefix map of the World I.N. 10022 ..... 1.25
  - Great circle chart of the World I.N. 10003 ..... 1.25
- ARRL US Call Area Map I.N. 10030 ..... 3.00
- ARRL World Prefix Map I.N. 10006 ..... 3.50

## RSGB Books

- Oscar - Amateur Radio Satellites The comprehensive book on amateur satellites illustrated with pictures and charts I.N. 10059 8.50
- VHF-UHF Manual If you have any interest above 30 MHz, then get this book. It covers everything in this field. I.N. 26208 ..... 13.95



## TRAINING PACKAGES TAPES

Crack the code and ace your exam by studying the new way with our selection of cassettes. Just drop them into a cassette player and study anywhere easily and quickly. You'll have great results.

### 73 cassettes

Novice Theory Tapes prepare you for the FCC novice exam. Clearly presented material can be reviewed many times. I.N. 26306 ..... 15.95

### Code Tapes

- 5 word per min. Blitz Tape I.N. 26308 ..... 4.95
- 6 word per min. Blitz Tape I.N. 26309 ..... 4.95
- 13 word per min. Blitz Tape I.N. 26310 ..... 4.95
- 20 word per min. Blitz Tape I.N. 26311 ..... 4.95



Te co Code Practice Tape are guaranteed for life.

- Novice tape I.N. 31461 ..... 3.95
- 5 wpm tape I.N. 31450 ..... 3.95
- 7 1/2 wpm tape I.N. 31451 ..... 3.95
- 10 wpm tape I.N. 31452 ..... 3.95
- 13 wpm tape I.N. 31460 ..... 3.95
- 15 wpm tape I.N. 31454 ..... 3.95
- 17 wpm tape I.N. 31455 ..... 3.95
- 20 wpm tape I.N. 31456 ..... 3.95
- 22 wpm tape I.N. 31457 ..... 3.95
- 25/30 wpm tape I.N. 31458 ..... 3.95
- 35/40 wpm tape I.N. 31459 ..... 3.95

### Ameco Code Tapes

- Junior Code Course #100-T Covers start to 8 wpm I.N. 24819 ..... 4.95
- Advanced Code Course #103-T From 8 1/2 to 18 wpm I.N. 24821 ..... 4.95
- Senior Code Course #101-T Double length covering the Junior and Advanced Courses start to 18 wpm I.N. 24820 ..... 8.95
- Extra Class Code Course #104-T Covers from 13 wpm to 22 wpm includes FCC type exam. I.N. 24822 ..... 4.95
- General Class QSO tapes #105-QT 12, 13, 14, & 15 wpm I.N. 24827 ..... 4.95
- Extra Class QSO tape #106QT 19, 20, 21, & 22 wpm I.N. 24826 ..... 4.95

### Kantronics

- QSO Code Tapes Covers 7 1/2, 10, 13, & 15 wpm. Be ready for the new FCC exams! I.N. 28906 4.95
- Super QSO 13 A 13 wpm cassette tape. An excellent study guide. I.N. 28921 ..... 4.95
- Novice Combo A kit that includes a novice License Manual, Novice theory cassette, 5 wpm cassette, and 7 1/2, 10, 13, 15 wpm QSO tape. I.N. 28922 ..... 14.95
- General Class Theory Course A set of two cassettes. I.N. 28920 ..... 8.95
- Novice Theory Cassette Theory for the novice on 1 cassette. I.N. 28920 ..... 4.95

Remember, you can Call Toll Free: 1-800-633-3410 in the U.S.A. or call 1-800-292-8668 in Alabama for our low price quote. Store hours: 9:00 AM til 5:30 PM, Monday thru Friday.

VISA

# Long's Electronics



MAIL ORDERS: P.O. BOX 11347 BIRMINGHAM, AL 35202 • STREET ADDRESS: 2808 7TH AVENUE SOUTH BIRMINGHAM, ALABAMA 35233

# 1-800-633-3410 TODAY!

CALL LONG'S TOLL FREE

**KENWOOD TR-2400 synthesized 2m hand held transceiver**

143.900-148.495 MHz, 10 memories, up/down scanning for busy or clear ch., mode switch for standard non-standard repeater splits, LCD digital readout, built-in touchtone generator. 1.5 watts RF output. With flex antenna with BNC connector, NiCad battery pack & charger.



Call today.

**ORDER NOW!**



**SHURE 444 desk mic**

Has PTT switch, adjustable head. Freq. 300 to 3000 Hz. Omnidirectional with controlled magnetic mic element for SSB. High impedance: 50K ohms.

**39.18** Call today.

**YAESU FT-207R synthesized Handle-Talkie**

Covers 144-148 MHz, has 10 KHz steps, 3 watt output, 4 memories plus programmable offset, priority channel, memory band and auto scan, keyboard encoded frequency entry, 2 tone input from keyboard lock.



**399.00** Call today.

**B&W 595 coax switch**

Features: 6 outputs, a power rating of 2 KW PEP, VSWR of less than 1.2:1 up to 150 MHz, grounds all unused antennas.

**21.50** Call today.



**B&W 593 3 position coax switch**

This switch features: 3 outputs, a power rating of 2 KW PEP, VSWR of less than 1.2:1 up to 150 MHz, & grounds all unused antennas.

**17.50** Call today.



**YAESU QTR-24 world clock**

The QTR-24 World Clocks allows you to determine the time anywhere in the world at a glance. Using the included batteries, operation up to a year is possible without replacement of cells, making the QTR-24 perfect for home or portable operation.

**35.00** Call today.

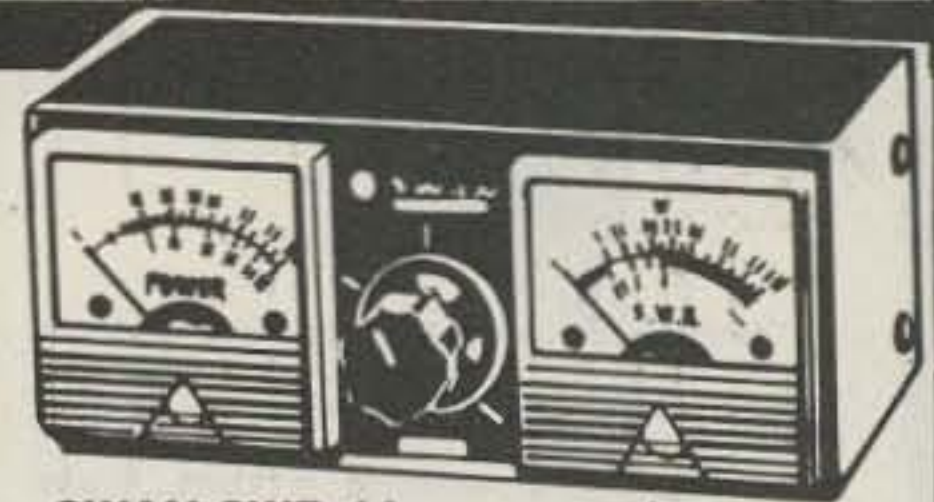

**SWAN SWR-1A power meter and SWR bridge**

Frequency range: 3.5 to 150 MHz. Compact and light weight for portable or mobile use. Capable of handling 1,000 watts RF and measures 1:1 to infinity VSWR.

**29.95** Call today.



**KENWOOD HS-4 headphones**

You can wear these comfortable headphones for hours. Adjustable and light-weight.

**19.50** Call today.



**YAESU YH-55 headphones**

The YH-55 headphones are light in weight, and an extra-soft cushion makes for many hours of comfort. The audio response is shaped to match that of your transceiver.

**15.00** Call today.



**TELEX C-1320 headphone**

The headphone is fully cushioned, audiometric type drivers are ultra-sensitive DX'ers choice. 20-20,000 Hz. Low impedance 8-20 ohms.

**41.80** Call today.

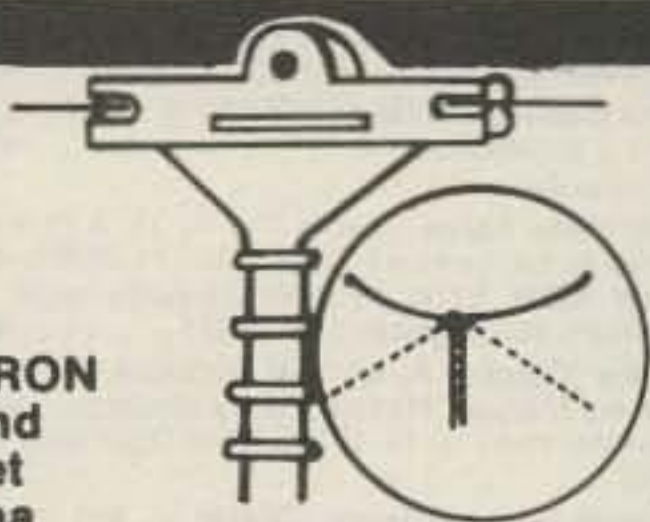

**DENTRON All band doublet antenna**

Covers 160 thru 10 meters and has a total length of 130' (14 ga. stranded copper). It may be made shorter. It is center fed through 100' of 470 PVC covered balanced transmission line. Assembly is complete. Antenna tuner required. Tunes 160 thru 10 with 1 antenna.

**24.50** Call today.



**BIRD Model 43 Thruline® watt meter**

50 ohms nominal impedance, permits direct reading of full scale power from 100 Mw to 10,000 W. Shock mounted.

**130.00** Call for yours today.

**BIRD plug-in elements**

Frequency Bands in MHz

Power range:	2-30	25-60	100-250	200-500	400-1000
5W		5A	5C	5D	5E
10W		10A	10C	10D	10E
25W		25A	25C	25D	25E
50W	50H	50A	50C	50D	50E
100W	100H	100A	100C	100D	100E
250W	250H	250A	250C	250D	250E
500W	500H	500A	500C	500D	500E
1000W	1000H	1000A	1000C	1000D	1000E
2500W	2500H				
5000W	5000H				

H-Elements (2-30 MHz) ..... 47.00 ea.  
A-C-D-E Elements (25-1000 MHz) 39.00 ea.



# Long's Electronics

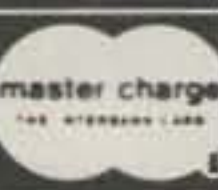

# CALL LONG'S TODAY!

1-800-633-3410  
TOLL FREE



### MFJ 949 Deluxe Versa Tuner II

A 300 watt antenna tuner with features like dummy load, SWR, forward and reflected power meters, antenna switch and balun. It matches every thing from 1.8 thru 30 MHz, coax random wires and balanced lines.

**119.95** List. Call for quote.



### MFJ-16010 random wire tuner

Operate on all bands with a simple random wire. Up to 200 W RF output. Ultra compact 2" x 3" x 4". Match high and low impedances by interchanging input and output. SO-239 connectors.

**29.95** List. Call today.



### MFJ-941B Versa tuner II

This accurate unit has SWR and dual range wattmeter, antenna switch, built-in balun, 300W RF output. Matches everything from 1.8 thru 30 MHz. You can use just one antenna and increase the useable bandwidth. Has SO-239 connectors. Mobile mounting bracket.

**79.95** List. Call today.

### BENCHER BY-1 Iambic paddle

The Ultimate iambic paddle. Features solid silver contact points, full range adjustment, non-skid feet and heavy steel black textured base.

**39.95** Call today.

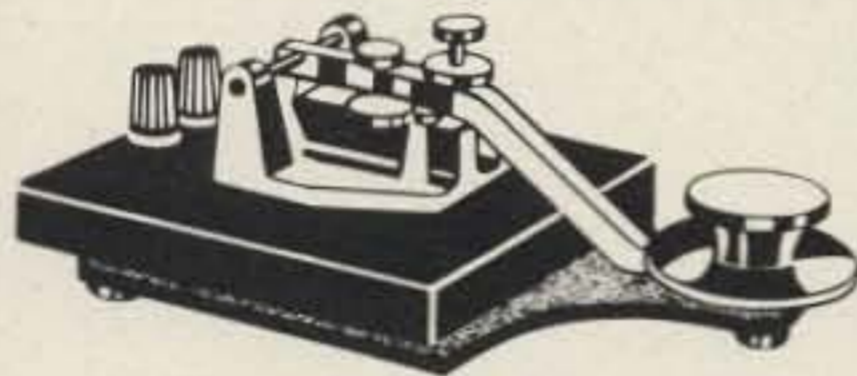

### HAM-KEY HK3M

Improved straight key with a footed base so there's no reason to attach it to the desk. It has velvet smooth action.

**19.95** Call today.



### NYE VIKING "Master Key" 114-330-001

The "master key" is the first major improvement in telegraph key design in 50 years! Contact assembly is isolated from base, greatly reducing shock hazard. Heavy diecast body eliminates "walking". Gold-plated silver contacts. Complete with Navy knob and two conductor cords with 1/4" key plug.

**19.50** Call today.

### BENCHER BY-2 Iambic paddle

The BY-2 has all the features of the By-1 but comes with chrome base.

**49.95** Call today.



**ORDER NOW!**

### KANTRONICS 2m trunk mount antenna

1/4 wave trunk mount antenna complete with coax cable and connectors. No drilling necessary.

**7.95** Call today.

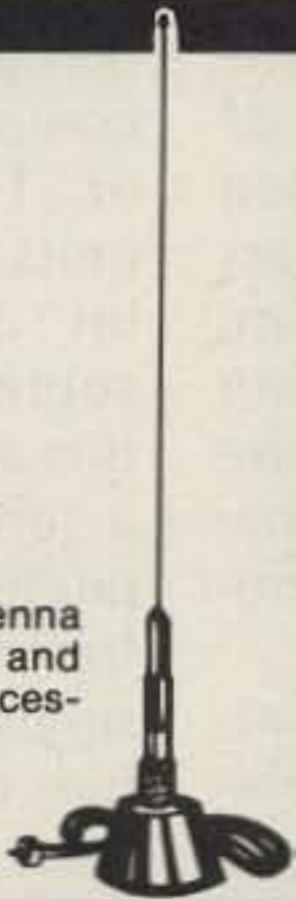

**ORDER NOW!**

### AVANTI Thru the glass antenna

A 2 meter antenna that attaches thru glass without drilling holes. VHF. Use for mobile, marine, & base station.

**32.95** Call today.

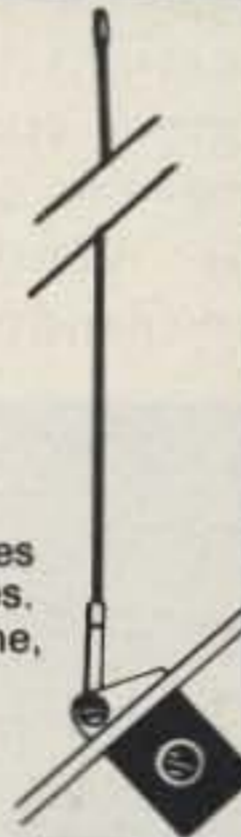

### HY-GAIN HB-MAG 287 Hy-bander foldover antenna

A magnetic mount antenna with foldover for hatchback cars. 5/8 wave provides low angle radiation for maximum gain. Ratchet foldover thru 180 degrees. Holds position up to 120 mph. Less than 1.4:1 VSWR, 144-148 MHz, 3 dB gain.

**19.95** Call today.

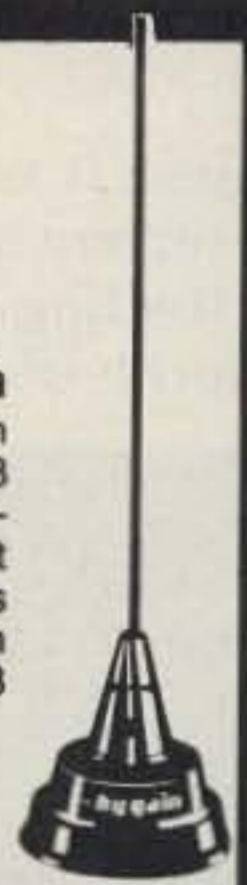

### KENWOOD MC-45 touchtone mic

Touchtone circuit provides PTT (push to talk) with 1/2 second hangtime after any button is pushed. Dynamic, omnidirectional, 500 ohm impedance mic with adjustable tone output level. Power requirement: 8 VDC, 20 mA. Complete with coiled cord and 5 pin mic connector. Compatible with the TR-7600 and TR-7625 with no modification.

**49.95** Call today.



### DENTRON Big Dummy load

Now you can tune-up off the air with the Big Dummy! It has a flat SWR, full freq. coverage from 1.8 to 300 MHz and a high grade of industrial cooling oil furnished with the unit. Fully assembled. Cut out the QRM factor now!

**29.50** Call today!

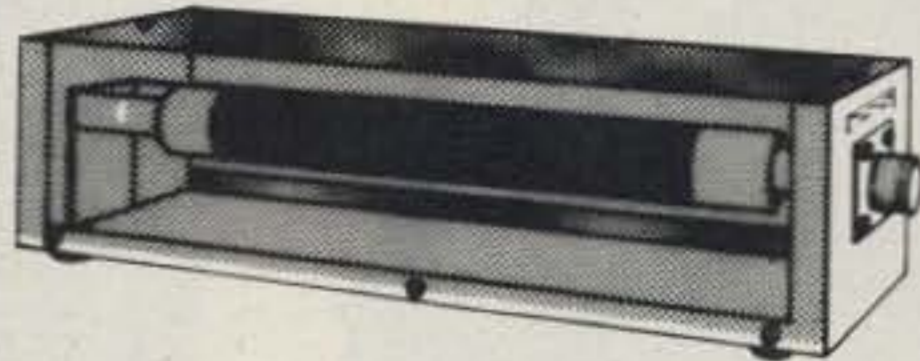

### DRAKE Dummy loads

DL-1000 air cooled dummy load. Power rating 1000 watts. SWR: 1.5:1 max. 0-30 MHz. SO-239 connectors. Expanded rating limitation when used with the FA-7 cooling fan. Also available: DL-300 dummy load 24.95.

**49.95** Call today.

VISA

# Long's Electronics



# Come On In— The Viewing Is Fine

## — an update on trends and developments in SSTV

*Dave Ingram K4TWJ  
Eastwood Village, #1201 South  
Rte. 11, Box 499  
Birmingham AL 35210*

**T**he interest, excitement, and technical advancements affecting the fascinating world of slow-scan

TV during recent times have been a phenomenal experience. Newcomers and old-timers alike are enjoying the pleasures of visual communications as this amateur frontier continues expanding on an unlimited basis. While some operation-minded

amateurs are visually sharing their lives and interest with SSTVers thousands of miles away, others are diligently pursuing new developments—many of which may be perfected before this article appears in print. This enthusiasm, devotion, and progress are prime indicators of the sheer fun awaiting all amateurs seeking new communication horizons.

As an updating account, this article will describe some of the latest happenings in SSTV.

If you are thinking of joining our ranks, if you're a newcomer to SSTV, or if you haven't been overly video-active, this information should update you on recent innovations. Possibly, this article will send you racing back to the shack, anxious to share in the fun of slow-scan TV activity.

### Trends and Innovations

Large numbers of SSTV newcomers continue to grace the airwaves, and their popular choice of

gear is the Robot 400 system. Home-brew scan converters have dwindled in popularity due to their complexity and high cost, compared with the Robot or Thomas Engineering units. While the cost-per-bit of memory chips is somewhat expensive as this article is being written, a substantial change is expected in the near future. Indeed, the introduction of single memory chips capable of 65,000-bit storage may soon open new possibilities for inexpensive and compact home-brew scan converters.

Surprisingly, the interest in digital scan converters hasn't created a large open market for used P7 SSTV gear. While many slow-scanners retain their P7 equipment when progressing to a digital scan converter, others sell their P7 gear directly to an awaiting SSTV newcomer. The recent interest in medium-scan TV appears to be another major reason for continued P7 monitor popularity.

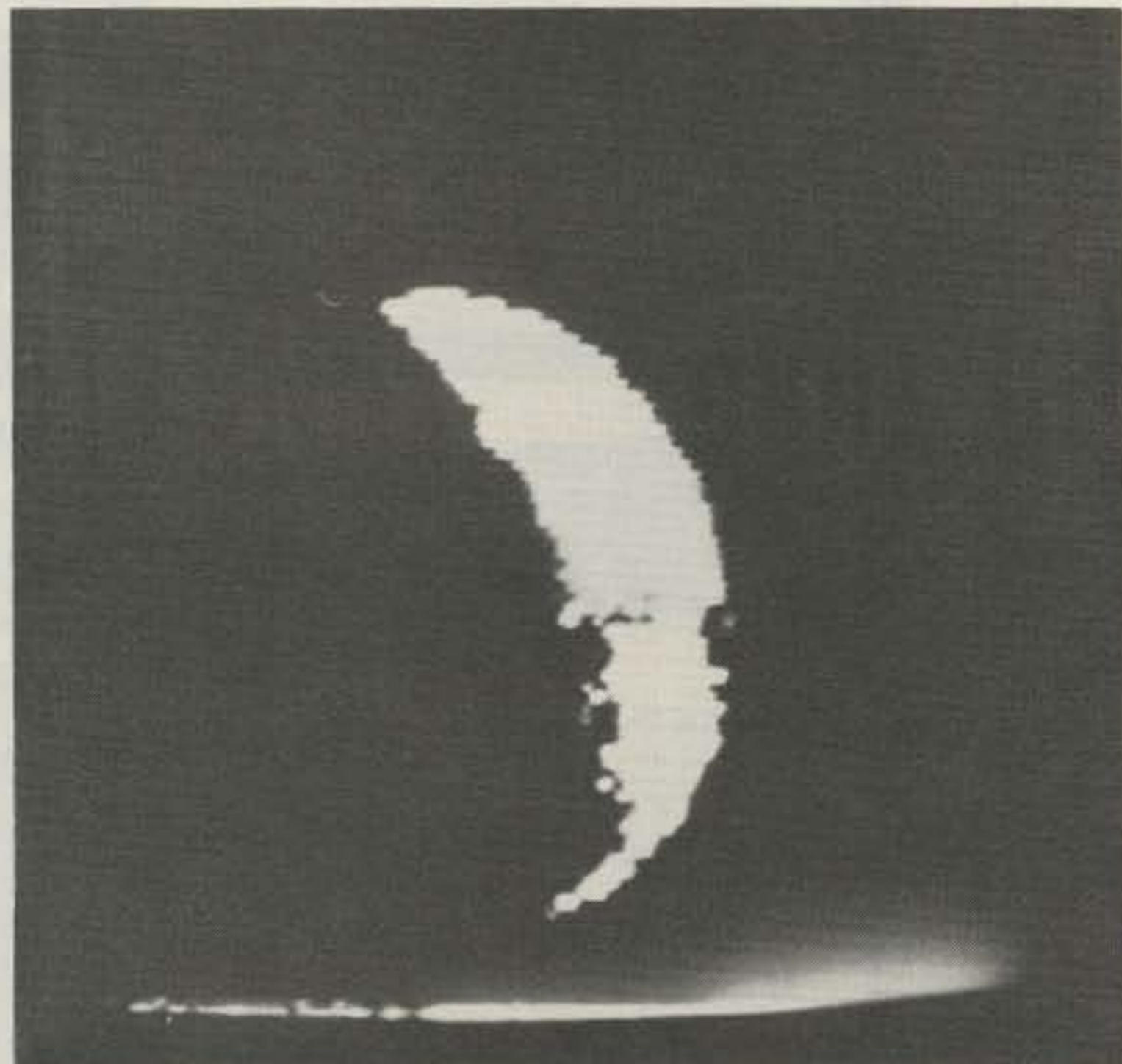

*Voyager II, 150,000 miles from Earth, looks back and acquires this crescent-shaped view of home. This picture was transmitted on 20-meter SSTV by Dick K6SVP.*



*This W6VIO-retransmitted view of Jupiter shows multiple layers of ammonia ice crystal clouds surrounding the planet. The shadowing effect of the sun prevents full view of Jupiter. The phenomenal "red spot" is visible in the lower right of the picture. This view was obtained with a 1500-mm telescope aboard Voyager II. The spacecraft was approximately 50 million miles from Jupiter at the time.*



*View of Jupiter's atmosphere in an area not far from the noted "red spot." This picture was acquired by Voyager II on March 5, 1979, and also retransmitted by W6VIO during their March "Commemorative" operations.*

Many slow-scanners consider using their freed equipment for this new 10-meter frontier.

Interest in SSTV keyboards appears to be declining, compared with a couple of years ago. Likewise, lengthy transmissions of pure text are being replaced by actual in-shack scenes and operator views. This aspect definitely indicates the ability to use SSTV rather than just prove that "the box works."

A second SSTV net recently began operating on 14,230 kHz, and its support has been extremely good thus far. This net begins at 2330 GMT each Thursday night. Net Controls are Tom N7AON and Stan WD4DCW. The prime objective of this net is providing technical assistance and SSTV newcomer guidance. A large number of fascinating SSTV pictures is exchanged during each net session, so that Thursday nights are becoming a very exciting time for all

active SSTVers.

#### **DX SSTV Drive**

During the latter part of 1978, word was received in the United States of the extreme enthusiasm of two outstanding DX stations to operate SSTV. These stations were Tom Christian VR6TC, of Pitcairn Island, and VK9RH, of Norfolk Island. Soon thereafter, an appeal was introduced, both on the air and via magazine articles, and gear for both stations was acquired. The concern and support among slow-scanning amateurs is a phenomenal situation! As this information is being written, donors of SSTV equipment for VR6TC and VK9RH desire to remain anonymous. Their reasons for anonymity are quite simple: The donors do not desire special considerations of prima donna titles.

The *Yankee Trader* left Florida en route to Pitcairn during February, 1979. A part of the vessel's cargo was a Robot 400 system,



*Extremely close view of Jupiter's "red spot" reveals a boiling storm with electromagnetic radiation equivalent to several atomic bombs.*

complete with camera and monitor. Soon thereafter, a Robot 70 and 80 system was shipped to VK9RH on Norfolk Island. The Northern California DX Foundation assisted in this operation. Truly, this DX SSTV drive was one of amateur radio's most outstanding accomplishments during

1979.

#### **MSTV**

An expanded frontier of SSTV development which is rapidly gaining widespread popularity is in the area of medium-scan TV. Essentially, the concept of MSTV permits limited-motion, long-distance TV



Classic picture of Jupiter's moon, Io, in front of the gigantic planet. That's Jupiter's atmosphere in the background. This was one of the most popular pictures relayed by W6VIO.



Jupiter's moon, Ganymede, as viewed by Voyager II from 1.6 million miles away and retransmitted on 20-meter SSTV by W6VIO.

communications in a 35-kHz frequency spectrum. This limited motion is accomplished through the use of scanning rates which are faster than slow-scan but slower than fast-

scan. Special Temporary Authorization has been granted to several amateurs to allow their medium-scan TV transmissions on the high end of 10 meters. Any amateur with

appropriate equipment may join the fun of viewing these transmissions. Don Miller W9NTP, of Waldron IN 46182, is spearheading this project. Additional supporters and STA stations include W0LMD, W3EFG, W6MXV, and WB9LVI.

During early 1979, the first phase of medium-scan TV swung into action. W9NTP placed a beacon transmitter on 29,150 kHz to check channel communications capability. The beacon was reliably received throughout North America and Europe, thus ensuring that a medium-scan TV signal could successfully be utilized on the 10 meter high end. As this information is being written, the second phase of medium-scan TV is approaching initiation. This phase will involve using modified P7 SSTV equipment for medium-scan TV operation. Ultimately, the P7 gear will be replaced with microprocessors and digital scan converters designed to the established MSTV parameters.

Modifying conventional P7 slow-scan gear for medium-scan TV requires a reasonable amount of experimentation, but the final results make all effort definitely worthwhile. Medium-scan TV will use a 5-field-per-second interlaced format with a horizontal line rate of 317 Hz. These sync signals must trigger a monitor's sweep driver circuits, which in turn must produce a MSTV raster. The horizontal ramp-generating capacitor must thus be decreased in value by a factor of 317/15 while the vertical capacitor must be changed from 1/8-field per second to 5 fields per second. The SSTV monitor's front end should be bypassed, and the approximately 20-kHz video signal should be wideband-amplified to an

appropriate level and applied to the cathode ray tube. The previous concept should prove successful for modifying Robot or W6MXV P7 monitors for medium-scan TV operation.

The final phase of medium-scan TV development will consist of replacing P7 gear with converted digital scan converters and microprocessors. This phase will bear a close resemblance to the present scan converter evolution with SSTV. The medium-scan project is a rigorous undertaking, and success isn't absolutely guaranteed. True amateur spirit and widespread dedication are two essential ingredients which need additional emphasis at the time this report is being written.

#### The Voyager Spacecrafts and SSTV

Alert and sharp-eared SSTVers have some exciting times in store for them during future months and years. Members of the Jet Propulsion Lab Radio Club have been providing "ringside seats" during high points of the Voyager space mission, and views thus far have been fantastic. This deep space mission began during August, 1977, and it is projected to continue until approximately late 1986. A brief outline of the events of *Voyager I* and *Voyager II* are as follows.

*Voyager II* was scheduled to fly by Jupiter during July, 1979. As *Voyager I* passes Jupiter, a slingshot effect hurdles it on toward Saturn. Its estimated flyby of Saturn will be during August, 1981. During this pass, *Voyager I* will move to within 2500 miles of Titan, Saturn's largest moon. Titan is the only one of Saturn's moons which has an appreciable atmosphere. Assuming everything is then progressing

# Now These DAIWA CORPORATION Communications Essentials



RF-440



RF-660

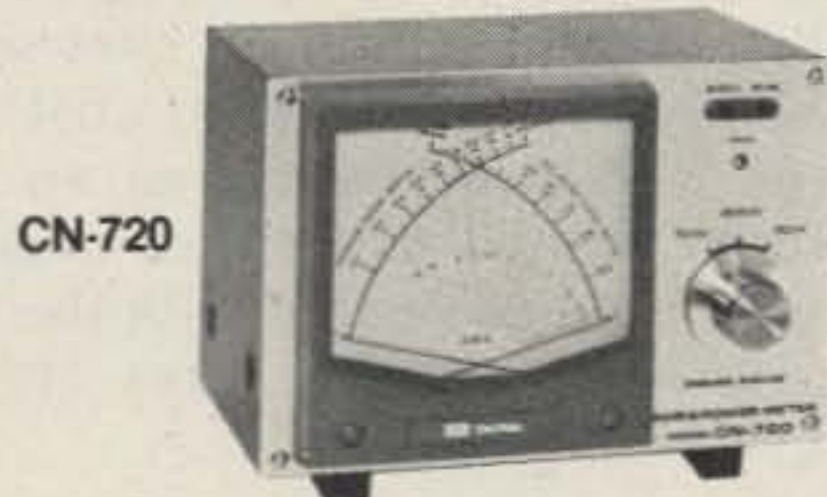

CN-720

## SWR & Power Meters Models CN-720, CN-620 and CN-630

Simultaneous direct reading SWR, Forward Power and Reflected Power. Tolerance: all units  $\pm 10\%$  full scale. Connectors: SO-239

**CN-720 and CN-620**  
Frequency Range: 1.8—150 MHz  
SWR Detection Sensitivity: 5 Watts min.  
Power: 3 Ranges (Forward, 20/200/1000 Watts)  
(Reflected, 4/40/200 Watts)



CN-620

**CN-630**  
Frequency Range: 140—450 MHz  
Power: 2 Ranges (Forward 20/200 Watts)  
(Reflected 4/40 Watts)



CN-630

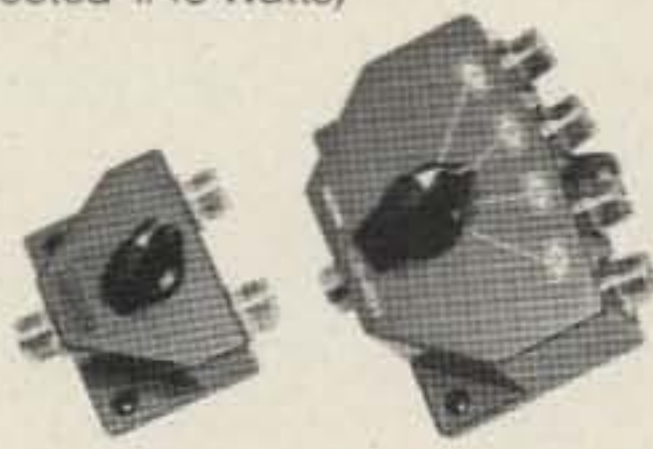

## RF Speech Processor Models RF-440 & RF-660

Increases talk power with splatter free operation. RF clipping assures low distortion. **Simply install between microphone and transmitter.**

Talk Power: Better than 6 dB  
Frequency Response: 300-3000 Hz at 12 dB down  
Distortion: Less than 3% at 1 kHz, 20 dB clipping  
Power Requirement: RF-440 self contained AC power supply; RF-660 13.5V DC external supply.

## Coaxial Switches

2 Position/Model CS-201  
4 Position/Model CS-401  
Professionally engineered cavity construction. Power Rating: 2.5 kW PEP, 1 kW CW  
Impedance: 50 Ohms  
Connectors: SO-239  
Insertion Loss: Less than .2 dB  
VSWR: 1:1.2  
Maximum Frequency: 500 MHz  
Isolation: Better than 50 dB at 300 MHz; better than 45 dB at 450 MHz; adjacent terminal  
Unused Terminals grounded

### Available from these authorized distributors...

- ARIZONA**  
Kryder Electronics  
Phoenix (602) 249-3739
- ARKANSAS**  
Lavender Distributors  
Texarkana (501) 733-4631
- CALIFORNIA**  
Ham Radio Outlet  
Anaheim (714) 761-3033  
Henry Radio Company  
Anaheim (714) 772-9200  
Ham Radio Outlet  
Burlingame (415) 342-5757  
Henry Radio Company  
Los Angeles (213) 477-6701  
Tower Electronics  
Mission Viejo (714) 768-8900  
U-do Electronics  
Mountain View (415) 968-8894  
Zakit/Sacramento  
Sacramento (916) 446-3131  
Ham Radio Outlet  
San Diego (714) 560-4900  
Omega Radio & Electronics  
San Diego (714) 578-3324  
Western Radio  
San Diego (714) 239-0361  
Quement Electronics Inc.  
San Jose (408) 998-5900  
Wescom Engineering  
San Marcos (714) 744-0700  
H.E.M.E.C.  
Santa Barbara (805) 963-3765  
Ham Radio Outlet  
Van Nuys (213) 988-2212
- COLORADO**  
CW Electronics  
Denver (303) 893-5525
- CONNECTICUT**  
Thomas Communications  
Newington (203) 667-0811
- DELAWARE**  
Delaware Amateur Supply  
New Castle (302) 328-7728  
Amateur & Advanced Communications  
Wilmington (302) 478-2757
- FLORIDA**  
Hialeah Communications  
Hialeah (305) 887-5936  
Quad Electronics  
Pensacola (904) 438-3319
- GEORGIA**  
Ack Radio Supply  
Atlanta (404) 351-6340
- HAWAII**  
Honolulu Electronics  
Honolulu (808) 949-5564

- ILLINOIS**  
Erickson Communications  
Chicago (312) 631-5181  
Tri-State Electronics Corp.  
Mount Prospect (312) 255-0600  
Spectronics, Inc.  
Oak Park (312) 848-6778
- IDAHO**  
Ross Distributing Company  
Preston (208) 852-0830
- INDIANA**  
The Ham Shack  
Evansville (812) 422-0231  
Calumet Electronics  
Gary (219) 887-4961  
Graham Electronics  
Indianapolis (317) 634-8202  
Rodefelf Company, Inc.  
Richmond (317) 966-3505
- IOWA**  
Mid-State Distributing  
Des Moines (515) 244-7231
- KANSAS**  
Associated Radio Communications  
Overland Park (913) 381-5900  
Electronics, Inc.  
Salina (913) TA 7-7377  
Radio Supply  
Salina (913) 823-6353  
Amateur Radio Supply  
Wichita (316) 264-9166
- MARYLAND**  
Comm Center  
Laurel (301) 792-0600
- MASSACHUSETTS**  
You-do-it Electronics  
Needham (617) 449-1005  
Tufts Radio & Electronics  
Medford (617) 395-8280
- MICHIGAN**  
Purchase Radio Supply  
Ann Arbor (313) NO 8-8696  
Radio Supply & Engineering  
Detroit (313) 435-5660  
Radio Parts, Inc.  
Grand Rapids (616) 459-0247
- MINNESOTA**  
Northwest Radio  
Duluth (218) 727-1565
- MISSOURI**  
Ham Radio Center  
St. Louis (314) 993-6060
- NEVADA**  
Communications Center West  
Las Vegas (702) 647-3114

- NEW JERSEY**  
C.H. Electronics Distributing  
Clifton (201) 478-9700  
Route Electronics 46  
Totowa (201) 256-8555
- NEW YORK**  
Genesee Radio & Parts  
Buffalo (716) 873-9661  
Harrison Radio Corp.  
Farmingdale (516) 293-7990  
B. C. Communications, Inc.  
Huntington Station (516) 549-8833  
Barry Electronics  
New York (212) WA 5-7000  
Harvey Radio  
New York (212) 575-5200  
S & S Accessories & Parts  
New York (212) 354-5889  
T & M Electronic Supply  
Patchogue (516) 289-2520  
Radio World  
Oriskany (315) 337-2622  
Harrison Radio Corp.  
Valley Stream (516) 872-9565
- OHIO**  
Universal Amateur Radio  
Reynoldsburg (614) 866-4267  
Srepco Electronics  
Dayton (513) 224-0871
- OKLAHOMA**  
Radio Inc.  
Tulsa (918) 587-9123  
Kryder Electronics  
Oklahoma City (405) 789-1951
- OREGON**  
Portland Radio Supply  
Portland (503) 228-8647  
Portland Radio Supply  
Medford (503) 773-5815
- PENNSYLVANIA**  
Trevose Hamtronics  
Trevose (215) 357-1400  
"Ham" Buerger, Inc.  
Willow Grove (215) 659-5900

- TENNESSEE**  
Amateur Radio Supply  
Madison (615) 868-4956  
Germantown Amateur Supply  
Memphis (901) 452-4276
- TEXAS**  
Wholesale Electronics Supply  
Austin (512) 478-9568  
Douglas Electronics  
Corpus Christi (512) 883-5103  
AGL Electronics  
Dallas (214) 241-6414  
Hardin Electronics  
Fort Worth (817) 429-9761  
Tracy Electronics  
Fort Worth (817) 292-3371  
Electrotex  
Houston (713) 526-3456  
Madison Electronic Distributors  
Houston (713) 658-0268  
Space Radio Supply  
Houston (713) 688-4594  
Appliance & Equipment Company  
San Antonio (512) 733-0334
- UTAH**  
Ballard Supply  
Salt Lake City (801) 972-2430
- VIRGINIA**  
EEB  
Vienna (703) 938-3350
- WASHINGTON**  
ABC Communications  
Seattle (206) 364-8300  
Amateur Radio Supply  
Seattle (206) 767-3222  
Consumer Communications  
Seattle (206) 784-7337
- WISCONSIN**  
Amateur Electronic Supply  
Milwaukee (414) 442-4200
- CANADA**  
Ham Radio Atlantic  
St. John, N.B. (506) 652-5753

Exclusive USA agent for these units; inquiries invited.

Write for literature.



**J. W. Miller Division**  
**BELL INDUSTRIES**

19070 REYES AVE. ■ P.O. BOX 5825  
COMPTON, CALIFORNIA 90224

✓ M92

successfully, *Voyager I* will continue toward Uranus. Its estimated time of flyby is January, 1986.

*Voyager II* was approaching Jupiter as this report was being written, and the views were truly breathtaking. Most *Voyager* and/or JPL activity is on 14,235 or 28,680 kHz. The usual times of operations are during weekends and early evening hours. The JPL club station call is

W6VIO (W6 Viking In Outerspace). Don't miss the upcoming views!

#### Looking Forward

A number of technical and operational advancements are due to affect the SSTV world favorably during the near future, and now is the opportune time for amateurs to prepare for these exciting times. Several SSTV contests, QSO parties, etc., are being

planned, while on-the-air slow-scan activities are also beginning to reflect progressive ideas and personal interests.

AMSAT's Phase III satellites also should provide some unique SSTV capabilities, provided all satellite operators discipline their operating techniques. EME, transequatorial propagation, and packet radio communications are some other examples of future

horizons which, if combined with data compression techniques, can provide unlimited video capabilities.

If you would like to fully renew your interest in amateur radio, try the fascinating frontier of slow-scan television. The cost of visually equipping an existing setup is truly negligible compared with the unlimited pleasures it affords. ■

*Michael Black VE2BVW*  
16 Anwoth Road  
Montreal, Quebec  
Canada H3Y 2E7

## Rack 'Em Up

—glass jars and orange crates are "where it's at" for parts storage

Over the years, many methods have been described for storing parts, including just about everything from shoe boxes to old tin cans. Perhaps, though, most popular is the ordinary food jar. The common jar is great as a parts container since it has a lid, is transparent, is easily available, and is inexpensive. Now, I use old jars to store my parts which I don't use too often, and while that is not too interesting, I feel that the method of storing these jars is.

A favorite way of storing jars full of components is to place them standing up

on a shelf, but that has a couple of disadvantages. If you have a deep shelf and a number of rows of jars, the problem is that it is hard to see what is in the jars in the back, and you have to remove the front rows in order to get at those in the back. To alleviate this situation, you could have only one row of jars, but then you use up a lot of wall space with your jars. The solution is rather simple. When you put your jars on the shelf, lay them on their sides. That way, you can just slide out the jar you want. As for the problem of identification, you can put a label on the

top of the jar. If you actually want to see what's in the jar, just put it on the shelf backwards so you can look through the bottom.

Now for some details on what I'm using. For jars, I've got tall and narrow iced-tea jars, with a rated capacity of 13 ounces. For the shelves, I'm using old orange crates stacked on top of each other. These crates are about 8" x 11" x 6" and they're just about perfect for my jars. I can fit two rows of four jars and another row of three jars in there and there's just a bit of wasted space in the top two corners. I used what I had on hand but it

shouldn't be too hard to throw together some sort of box for your jars. Don't make your boxes too big, since the jars might have a tendency to roll around. Also, I'd suggest that when you're picking your jars, find something which is tall as compared to its diameter.

So that's the story. The jars in their box sort of remind me of wine bottles in their rack. When you pull out a bottle from a bottom layer, the top layers drop down, so keep a hand on the jar immediately above the one you're taking out. Now, isn't that better than a bunch of old tin cans? ■



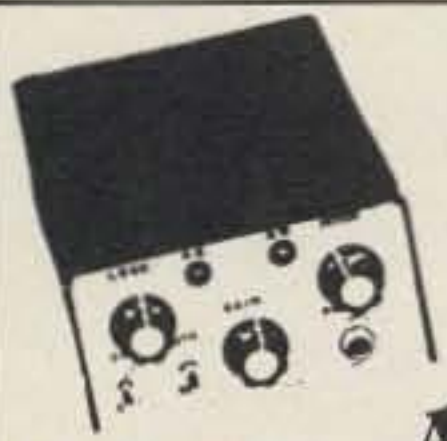

IT'S HERE!!

# THE AMCODER

4" x 2 3/8" x 6"

## A NEW ERA IN CW REGENERATION

- Select any CW signal that's 40 hz away from any other (Tune—400 to 1500 hz)
- Lock and switch to "auto" and you have tape quality audio. One and one only signal reception.
- Only 20 mv of audio above receiver noise required for acquisition.
- A 40 db over S9 signal, 50 hz away cannot come through.
- Reduce operator fatigue by not listening to any other band and/or signal noise except the one you want to work.
- Variable acquisition frequency—400 to 1500 hz.
- Variable output tone frequency—100 to 2000 hz.
- Variable output audio level (drives ear-phones or station speaker).

Kit includes all parts including cabinet, power supply and complete instructions. Epoxy glass boards, plated and pre-drilled.

Available—Factory wired and tested with 1 year warranty on parts and workmanship.

Kit—\$69.95 FWT—\$89.95

301-799-7741

VISA and Master Charge Accepted.

AMC ENGINEERING ✓ A106

P. O. Box 427, Jessup, MD 20794

# ALL BAND TRAP ANTENNAS!



PRETUNED - COMPLETELY ASSEMBLED - ONLY ONE NEAT SMALL ANTENNA FOR UP TO 6 BANDS! EXCELLENT FOR CONGESTED HOUSING AREAS - APARTMENTS LIGHT - STRONG - ALMOST INVISIBLE!

FOR ALL MAKES & MODELS OF AMATEUR TRANSCEIVERS - TRANSMITTERS - GUARANTEED FOR 2000 WATTS SSB 1000 WATTS CW. INPUT FOR NOVICE AND ALL CLASS AMATEURS!

COMPLETE AS SHOWN with 90 ft. RG58U-52 ohm feedline, and PL259 connector, insulators, 30 ft. 300 lb. test dacron end supports, center connector with built in lightning arrester and static discharge - molded, sealed, weatherproof, resonant traps 1"X6"-you just switch to band desired for excellent worldwide operation - transmitting and receiving! WT. LESS THAN 5 LBS.

160-80-40-20-15-10 bands 2 trap--209 ft. with 90 ft. RG58U - connector - Model 777BU ... \$64.95  
 80-40-20-15-10 bands 2 trap --- 102 ft. with 90 ft. RG58U - connector - Model 998BU ... \$59.95  
 40-20-15 -10 bands 2 trap --- 54 ft. with 90 ft. RG58U coax - connector - Model 1001BU ... \$58.95  
 20-15-10 bands 2 trap --- 26 ft. with 90 ft. RG58U coax - connector - Model 1007BU .... \$57.95

SEND FULL PRICE FOR POST PAID INSURED DEL. IN USA. (Canada is \$5.00 extra for postage - clerical - customs - etc.) or order using VISA Bank Americard - MASTER CHARGE - AMER. EXPRESS. Give number and ex. date. Ph 1-308-236-5333 9AM - 6PM week days. We ship in 2-3 days. ALL PRICES WILL INCREASE MAR 1-SAVE - ORDER NOW! All antennas guaranteed for 1 year. 10 day Money back trial! Made in USA. FREE INFO. AVAILABLE ONLY FROM.

WESTERN ELECTRONICS ✓ W18 Dept. A7-12

Kearney, Nebraska, 68847



# Radio World



CENTRAL NEW YORK'S FASTEST GROWING HAM DEALER



Featuring Yaesu, Icom, Drake, Atlas, Ten-Tec, Swan, Dentron, Pace, Palomar, Alda, Midland, Wilson, KDK, MFJ, Microwave Module, Standard, Tempo, Astron, KLM, Hy-Gain, Mosley, Larsen, Cushcraft, Hustler, Mini Products, Universal and Tristao Towers. We service everything we sell! Write or call for quote. You Won't be Disappointed. We are just a few minutes off the NYS Thruway (I-90) Exit 32

CALL TOLL-FREE ONEIDA COUNTY AIRPORT TERMINAL BUILDING ORISKANY, NEW YORK 13424  
1-800-448-7914

Bob Warren WA2MSH K2IXN

NY STATE RESIDENTS CALL 315-337-2622 or 315-337-0203

# 2-METER MOBILE



## AT-200 Antenna Matcher

Use your car's AM/FM antenna for your 2-meter mobile rig.—Eliminate the two-antenna tip-off to thieves, without the nuisance of hideaways.

Save the cost of a 2-meter mobile antenna.

AT-200 tunes from the front panel for maximum output, minimum VSWR (1.2:1 or less for most car antennas).

at your B&W dealer. ✓ B23

Made in the U.S.A. by

**Barker & Williamson, Inc.**

10 Canal Street, Bristol, PA 19007

# UNADILLA

## The WA2ZOT "INTERFILTER"

2000 WATT LO-PASS

LIFETIME GUARANTEE

The **only** Lo-Pass you'll ever need.



FULL-POWER, QUALITY HAM ANTENNA PARTS

AT YOUR DEALER

- BALUNS-TRAPS-INSULATORS
- QUAD PARTS-ANTENNA KITS
- BOOM/MAST MOUNTS-WIRE
- CABLE-CONNECTORS

Write or call for full Catalog

### ASSISTANCE?

Call: HUGH GUNNISON, WA2ZOT  
Toll-Free 800-448-1666  
(NYS Collect 315-437-3953)

MICROWAVE UNADILLA/REYCO DIVISION  
FILTER COMPANY, INC. ✓ U9 [Dept. 73]  
6743 KINNE STREET, EAST SYRACUSE, NEW YORK 13057

DEALERS WANTED - OVER 300 WORLD-WIDE

# IRON POWDER and FERRITE PRODUCTS

## AMIDON Associates ✓ A26

Fast, Reliable Service Since 1963

Small Orders Welcome

Free 'Tech-Data' Flyer

Toroidal Cores, Shielding Beads, Shielded Coil Forms  
Ferrite Rods, Pot Cores, Baluns, Etc.

12033 OTSEGO STREET, NORTH HOLLYWOOD, CALIFORNIA 91607

# Gadzooks! A Variable 0-260 V Ac Supply!

—junk-box delight

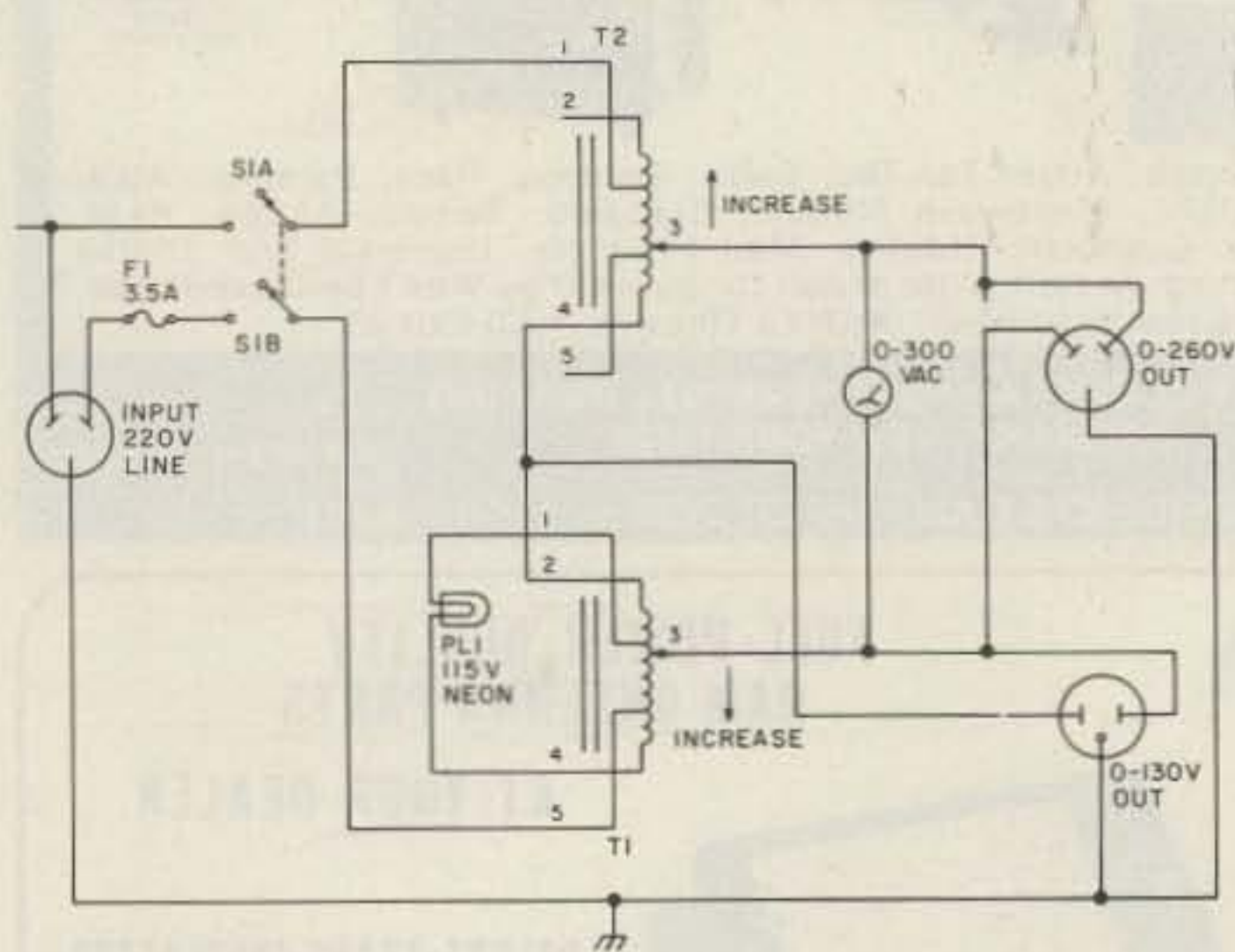

Fig. 1. Variable 0-260 volt ac supply.

William P. Winter, Jr.  
WB8JCO/LUIAKO  
530 College Ave.  
Ashland OH 44895

**N**eed and the lack of money are the parents of home brew, it seems—at least in my case. I had a need to test plate transformers for power output under varying load conditions. I was trying to test various 220-volt primary transformers which

were available to me for use in a linear amplifier. I had a 0-150 volt, 500-Watt supply which I used with a 110-220 volt auto transformer, but things began to saturate at about 700 Watts.

It occurred to me that two variable transformers hooked up in series might do the trick. I knew that I had tucked back in the junk box two Ohmite VT-4 rotary transformers which had come out of a piece of \$2.50 surplus I had picked up years ago. I had long since used much more value than that in diodes, connectors, chassis, and cabinet, so the rotary transformers were just lying there for free.

I checked them out with clip leads to make sure everything worked OK. Then back to the junk box; out came a 0-300 volt ac meter of unknown origin, a large vibrator inverter supply which had long since given up the ghost, plugs, receptacles, switch, fuse holder, and a pilot light. Inspection showed that everything would fit snugly inside the old inverter cabinet. A few hours of work resulted in a nice in-

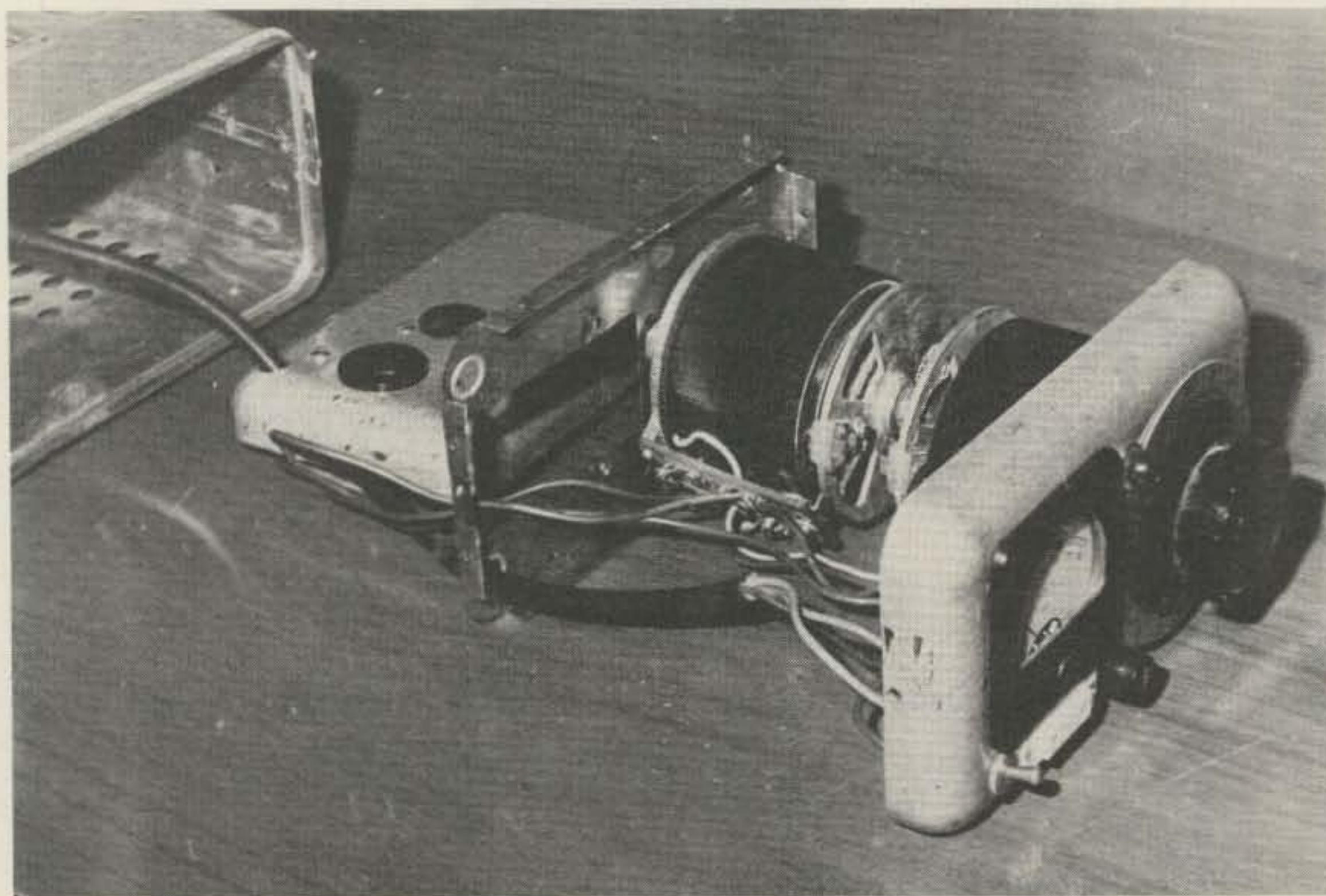

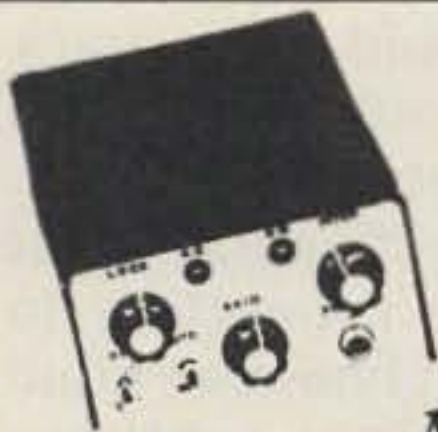

IT'S HERE!!

## THE AMCODER

4" x 2 3/8" x 6"

### A NEW ERA IN CW REGENERATION

- Select any CW signal that's 40 hz away from any other (Tune—400 to 1500 hz)
- Lock and switch to "auto" and you have tape quality audio. One and one only signal reception.
- Only 20 mv of audio above receiver noise required for acquisition.
- A 40 db over S9 signal, 50 hz away cannot come through.
- Reduce operator fatigue by not listening to any other band and/or signal noise except the one you want to work.
- Variable acquisition frequency—400 to 1500 hz.
- Variable output tone frequency—100 to 2000 hz.
- Variable output audio level (drives ear-phones or station speaker).

Kit includes all parts including cabinet, power supply and complete instructions. Epoxy glass boards, plated and pre-drilled.

Available—Factory wired and tested with 1 year warranty on parts and workmanship.

Kit—\$69.95      FWT—\$89.95

301-799-7741

VISA and Master Charge Accepted.

AMC ENGINEERING      ✓ A106  
P. O. Box 427, Jessup, MD 20794

# DUPLEXERS



US PATENT  
4080601

✓ W15

OUR NEW BANDPASS-  
REJECT DUPLEXERS WITH  
OUR EXCLUSIVE

## BpBr CIRCUIT\*

... provides superior performance, especially at close frequency spacing.

Models available for all Ham bands. Special price for Amateur Repeater Clubs

CALL OR WRITE FOR DETAILS:

**WACOM PRODUCTS, INC.**



Box 7307  
Waco, Texas 76710  
817/776-4444



# HAM

## REPEATER AUTOPATCH

Offer your club **COMPLETE**  
emergency communications

Commercial quality, gold plated contacts, plug in, epoxy glass PC boards. 12 volt DC or 115 volt AC operation - Power supply included. Four digit access - Single digit releases - field programmable. Hybrid network - No switching required. FCC certified telephone line coupler. Auxiliary "In Use" contacts supplied. Land line "call-in" signalling control contacts provided. Price complete \$498 + \$3 shipping & handling. Master Charge, Bank money order, or certified check acceptable.

Accessories: CES-300 powered tone pad - \$59 BUS-COM Soft-touch® telephone powered mike/pad element - \$34.95. ✓ M76



**MONROE ELECTRONICS, INC.**  
412 House Ave., Lyndonville, N.Y. 14098

# There's only one bad thing about a Kenwood from G.I.S.M.O. She'll hate it.



Your poor wife. Now that G.I.S.M.O.'s handling Kenwood, it's only a matter of time until you own a TS-520SE with DG-5 digital frequency readout, or one of Kenwood's other impeccable products. The TS-520SE is the result of Kenwood expertise and your improvement suggestions. The DG-5 option gives you crystal clear, dead accurate readout while sending and receiving.

Only problem is your lady's going to see a lot less of you when you get hooked on Kenwood quality.

We've got the entire Kenwood line. For a free, instant quote (mail's too slow), call the toll free number below.

# G.I.S.M.O. ✓ G22 1-800-845-6183

In S.C. call 1-366-7157  
2305 Cherry Road, Rock Hill, S.C.  
29730 (Exit 66-B off I-77)

strument capable of more than 1000 Watts intermittent output.

The schematic (Fig. 1) shows the hookup and terminal numbers for the Ohmite units I used. Other models may be different. The two units must be coupled mechanically back to back. In my case it was necessary only to loosen the shaft setscrews and slide the shafts back enough to

couple the two shafts together. I drilled out an old shaft coupler to fit the two shafts, then mounted a sheet metal support on the other end to support the rear transformer. The pilot light was hooked between 115-volt fixed taps, and a 0-130 volt output was taken from one of the variable transformers.

It should be noted that the hooking back-to-back

is the only way to get one transformer to rotate clockwise (looking from the front) and the other to rotate counterclockwise. Otherwise, a set of gears would have been necessary. It can be seen from the schematic that the slider on T1 goes down to increase voltage output as the slider on T2 goes up to increase voltage output. If the two transformers were hooked up in tandem, the

sliders would only track back and forth with a fixed 110-volt output.

Need a variable 220-volt supply for connecting to the 220-volt line? Can't find one available at a cost you are willing to pay? Do as I did and have the satisfaction of home-brewing something not too complex—and the best bonus of all for me was the cost—\$0.00. You can't beat that! ■

## Scrounger's Special: Used Dental Tools

— your DDS throwaways make dandy PCB drills

*J.E. Corwin WA7OYX  
1511 E. Third Street  
Mesa AZ 85203*

**D**id you ever get to the middle of a PC project and find one of the holes too small to accept that end of tinned stranded wire? Or that square LED lead? Did you then get out your trusty drill and bit and proceed to accidentally damage either the PC board or a component or both?

If so, dear reader, perhaps your friendly dentist can help you.

Over the past years, I have paid out to my dentist about as much as I have contributed to the IRS welfare and pension funds, and have thus been able to help him maintain his private airplane and a pair of matched quarter horses. Dentists, like most people, are more than willing to explain what they are doing and how the procedure is performed. As a result of a recent visit and the usual

question and answer session, my dentist gave me a set of conventional root-canal reamers he had discarded for no longer being sharp enough to be used on human teeth.

Root-canal reamers are similar to the familiar twist drill, come in various diameters, and have a knurled knob at the top end to permit the reamer to be twirled with the fingertips. The set given to me (in a plastic box about the size of a book of matches) contains six reamers, sized

from about 1 mm to 2 mm. The reamer shanks are 1" long and the knurled knobs are 1/2" long by 1/8" in diameter. It is a simple matter to select the proper size reamer and enlarge the PC hole to accommodate the wire or component with just a few twirls of the fingers—and without damage to other components, PC board, or foil.

The next time you see your dentist, ask him to save his throwaways—they do come in handy around the shack. ■

## AMATEUR TELEVISION

FAST SCAN 420-450 MHz

APTRON OFFERS THE ATV ENTHUSIAST THE MOST COMPLETE LINE OF EQUIPMENT AVAILABLE

- \*Model 1570B ATV REPEATER a complete unit-transmitter, receiver-demodulator, control, identifier, power supply
- \*TXR15A ATV TRANSCEIVER a complete unit-15w transmitter with subcarrier sound, dual frequency xtal converter-ch2 or 3 out, power supply
- \*TX15A ATV TRANSMITTER a complete unit-15w, subcarrier sound, power supply
- \*XR 70B XTAL CONVERTER dual frequency, ch2 or 3 out, high performance, power supply
- \*XD 25 B IN-LINE DETECTOR samples-detects video modulation at xmtr output, video output drives any standard tv monitor
- \*TD100A VIDEO-AUDIO DEMOD demodulates converter output, video drives monitor, audio drives speaker, power supply
- \*TV HANDBOOK for the AMATEUR

Call 812-336-4775, or write for our detailed catalog.

APTRON LABORATORIES ✓ A6  
PO Box 323, Bloomington, IN 47402

## AHF ANTENNAS

INTRODUCES OUR NEW EXCLUSIVE

### MOBILE ANTENNA

- ★ GREATER FIELD STRENGTH
- ★ GREATER TUNING RANGE
- ★ ALL NON-CORROSIVE PARTS
- ★ ALL THREADS U.S. STANDARD 3/8 x 24
- ★ MADE ENTIRELY OF QUALITY MATERIALS

Radiator, Mast, 10 Meter Adaptor, and 1 ea. 75, 40, 20 and 15 Meter Coils (Parts may be purchased separately)

Common 2 - 4 - 6 and 8 MHz MARINE frequency coils also available

2 to 30 MHz Custom Frequency Coils, made to order

✓ A92 Contact your favorite dealer or Write for brochure

**AHF / ANTENNAS**  
2814 S. Baywater Ave.  
San Pedro Ca. 90731  
Phone (213) 831-5444  
Dealerships available

## The Only Automatic Dialing Touch Tone MIC

The CES Model 235A Automatic Micro-dialer has a 10 number memory that can store even 11 digit numbers. Just dial \* and one digit to bring up auto-patch, pause and dial phone number automatically. Program Dialing speed for virtually any repeater auto-patch, then dial number at fastest speed. Automatic PTT with manual or automatic dialing. All dialing and programming done from Keyboard. LED indicator for programming or PTT and ...



79.95

ALL CONTAINED IN A SMALL MIC.

At your Ham Radio Dealer For more information write

**CES** COMMUNICATIONS ELECTRONICS SPECIALTIES, inc.

✓ C115 P.O. Box 507, Winter Park, Fla. 32790 305/645-0474

# Field Day <sup>Trademark</sup> is ready to go

The best code / radioteletype reader and speed-display package available!

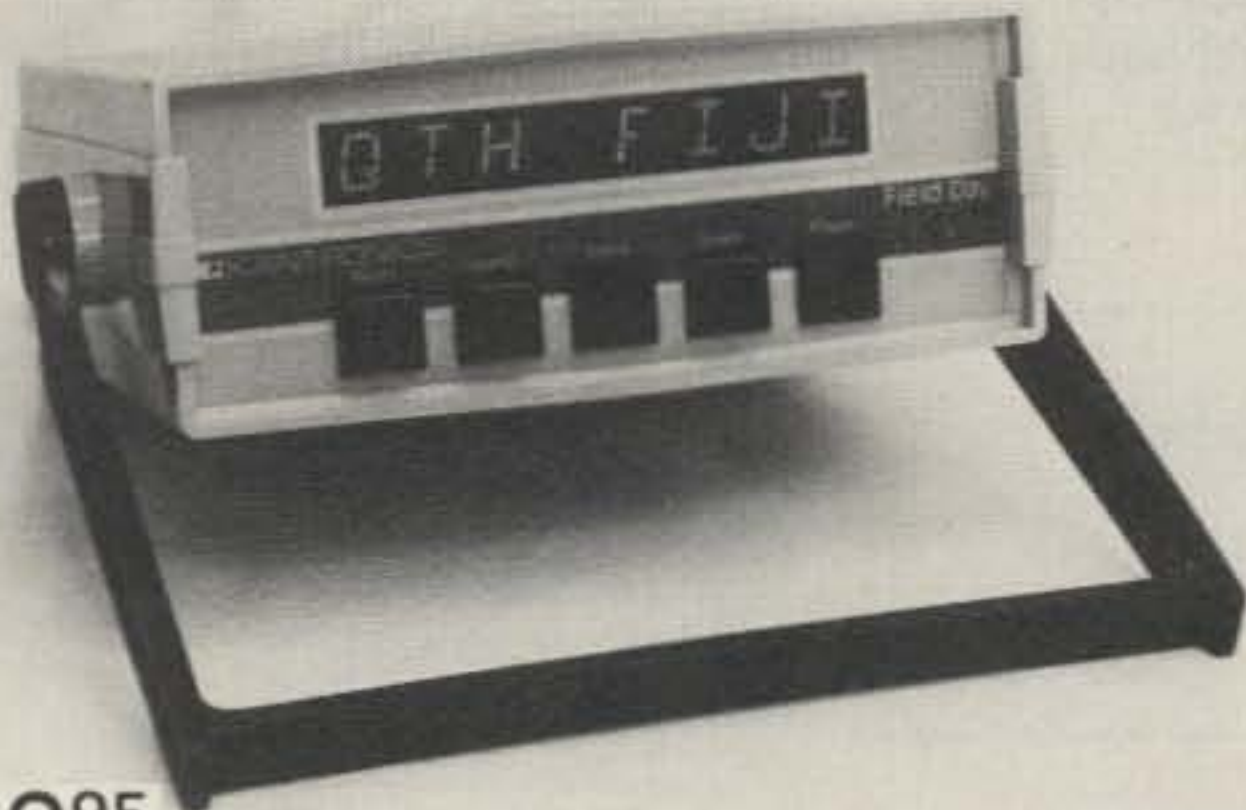

\$449<sup>95</sup>  
Plus shipping

We've designed a special **Field Day**, model "B," that is in stock and ready to ship. Right now. Some of the parts designed into the original **Field Day** just couldn't meet your ordering demand.

The **Field Day-B** has a special, high-reliability, 8 character display that costs us about \$40 more than the original displays! But we've still held the original price. We've added a "tuning eye" to make tuning easier and faster. Slow-arrival parts have been designed out, and an improved demodulator circuit has been designed in.

But the best part is they're ready to go now. Get 'um while they're hot.

**Alabama** - Long's; **California** - Electronics Emporium, Fontana; **Colorado** - H-E-P Enterprises; **Delaware** - Amateur & Advanced Communications; **Florida** - Amateur Electronic Supply, Amateur Radio Center, N & G Distributors, Ray's Amateur Radio; **Georgia** - ZZZ; **Idaho** - Ross Distributing; **Illinois** - Spectronics; **Indiana** - Ham Shack; **Kansas** - Associated Radio; **Kentucky** - Cohoon; **Massachusetts** - Tufts; **Michigan** - Omar; **Minneapolis** - PAL; **Missouri** - Burstein-Applebee, MidCom; **North Carolina** - Bob's Amateur Center; **Nebraska** - Heinrich's Communication; **New Hampshire** - Metz Communication; **New York** - Amerisil Overseas, Barry, Communications Technology, Ham Shack, Hirsch, Kelper, Radio World; **Ohio** - Queen City; **Oklahoma** - Brodie; **South Dakota** - Burghardt; **Texas** - Kennedy Associates, Madison, Tracy; **Virginia** - Tuned Circuit; **Washington** - Northwest Radio; **Wisconsin** - Amateur Electronic Supply; **Ontario** - Metro Ham Shack; **West Germany** - Richter & Company

**Kantronics**  
A commitment to excellence.

1202 E. 23rd Street (913) 842-7745  
Lawrence, Kansas 66044  
Visa, Master Charge accepted

# SEMICONDUCTORS SURPLUS

✓ S63

2822 North 32nd Street/Unit #1 Phoenix, Arizona 85008 (602) 956-9423

We accept checks, MasterCharge, and Visa

Prices subject to change without notice



## NEW TEXAS INSTRUMENTS

### L.E.D. DISPLAYS

TIL 311  
Hexadecimal Display  
with logic \$5.99 ea.

### TIL 312

Numeric Display  
Common Anode, RED  
99¢ each

## NEW MALLORY SONALERTS

Model SNP428  
4-28VDC @ .003-.016A  
\$6.99 each

## HP DUAL OPTICAL

ISOLATOR  
High speed  
Type #HCPL-2531  
\$3.00 each

## PLESSEY SP8666B

UHF Decade Counter  
14 pin dip  
1.1 GHz + 10  
Supply voltage 6.8VDC  
1.1 GHz 600MV to  
1.2Vp.p. \$39.95

## FAIRCHILD L.E.D.'s

and DISPLAYS  
F1V-110 RED  
20¢ each or 100/\$12.50  
FND359/70  
99¢ each or 10/\$8.00

## IR 1N2637 SOLID STATE

TUBE. Same as 866,  
866A, 3B28 \$6.99 ea.

## NEW SUB-C NICAD PACKS

6VDC 1.2AH  
5 in a pack/\$8.99

## JUMBO L.E.D.'s

Red	10/\$1.00
Yellow	10/\$1.00
Green	10/\$1.00

## LITRONIX DL-1416

4 Digit, 16 Segment  
Alphanumeric Intelligent  
Display with memory,  
decoder, driver. 64  
character ASCII format  
5V power supply only.  
TTL compatible  
\$30.00 each

## JENNINGS VACUUM RELAYS

RF2B-26S  
26.5VDC 920 Ohm SPST  
\$19.95

## KILOVAC VACUUM RELAYS

P/N H-8/S4  
26.5VDC SPDT  
\$29.95

## KILOVAC VACUUM RELAYS

HC-1/S75  
26.5VDC SPDT  
\$29.95

## AMPEREX VACUUM CAPS

10-1000pf 5000VDC  
Amperex #CVC10/1K-5KV405A  
Jennings #CVCH-1000-5N885  
(Jennings number only for  
reference.)  
\$59.95

## ANTENNA ROTOR CABLE

Columbia #04083  
8 conductor 2-#18 and  
6-#22. 100ft. spools  
\$9.99

## BURROUGHS 100 ELEMENT

DUAL LINEAR BAR GRAPH  
DISPLAY  
Model BG-16101-2  
\$9.99 Data 50¢

## HIGH VOLTAGE DIODES

HEP170  
1000VDC 2.5Amps  
20¢ each or  
100/\$15.00

## TRW CA602/CA2601BU

MICROELECTRONICS  
BROADBAND AMPLIFIER  
15 to 270MHz  
30DB gain, 30VDC  
maximum supply voltage  
\$9.99

## NE555P TIMERS

39¢ each or 10/\$3.00

## SIGNAL DIODES

1N914/1N4148  
30/\$1.00 or 120/\$3.00

## UHF CONNECTORS

PL259 and SO 239  
Quality American made  
50¢ each

## CERAMIC IF FILTERS

EFC-L-455K  
455KC filter  
2/\$3.00

## TRIMMER CAPS

Small enough to fit  
in your watch.  
3.5-11pf or  
5.2-40pf  
50¢ each

## VARIABLE VOLTAGE

REGULATORS  
LM317T 1.2V to 37V  
1.5Amp \$1.50 each or  
10/\$10.00 or 100/\$85.

## REGULATORS

LM309K/7805K  
5VDC 1Amp  
\$1.25 each

LM340T-12	LM340T-5
12VDC 1Amp	5VDC 1Amp
\$1.00 each	\$1.00 ea.
LM340T-15	LM340T-6
15VDC 1Amp	6VDC 1Amp
\$1.00 each	\$1.00 ea.

# SEMICONDUCTORS SURPLUS

S63

2822 North 32nd Street/Unit #1 Phoenix, Arizona 85008 (602) 956-9423

We accept checks, MasterCard, and Visa

Prices subject to change without notice



## REGULATORS

LM323  
5VDC @ 3Amps  
\$3.99

78HO5KC  
5VDC @ 5Amps  
\$4.29

## AIR VARIABLE CAPS

Cambion 563-7625-03-00-00  
3-30pf 600VDC  
1/4 in. shaft, 1 in. long  
\$1.99

## AIR VARIABLE CAPS

#074055  
3-105pf 1000VDC  
1/4 in. shaft, 7 in. long  
\$4.99

## PISTON CAPS

1.2-10pf \$1.00 ea.  
1-8pf 1.50 ea.  
.8-4.5pf 1.50 ea.

## ARCO VARIABLE CAPS

404 8-60pf  
400 .9-7pf  
42X 5-60pf  
402 1.5-20pf  
405 10-80pf  
422 4-40pf  
424 16-150pf  
\$1.00 each or  
10/\$8.00

## E.F. JOHNSON MICRO-T

### AIR VARIABLE CAPS

T3-5 1-5pf  
T6-5 1.7-11pf  
T9-5 2-15pf  
\$1.50 each

## UNELCO RF CAPS

350VDC  
6.8pf, 10pf, 12pf,  
13pf, 43pf, 100pf,  
200pf, 820pf, 1000pf  
\$1.00 each

## RELAYS

POTTER & BRUMFIELD  
Model PR5DY  
12VDC @ 25Amps, SPST  
\$3.99 each

Model PR7AY  
115VAC @ 25Amps, SPDT  
\$4.99 each

Model R10-E2822-1  
12VDC @ 3Amps, SPDT  
185 Ohms \$1.99 each

Model R10-E1-Y2-V52  
6VDC @ 3Amps, SPDT  
\$1.99 each

Model GA-2290  
110VDC @ 10Amps, 4PDT  
\$2.99 each

## SIGMA

Model 65F1A  
12VDC @ 3Amps, SPST  
\$1.99 each

## OMRO

Model MY4-02  
12VDC @ 3Amps, 4PDT  
160 Ohms \$2.99

## MAGNECRAFT

Model 88KDX-44  
12VDC @ 25Amps, SPDT  
100 Ohms \$3.99 each

## NAP CONTROLS

Model 13A12D12  
12VDC @ 10Amps, SPDT  
\$3.99 each

## BCD SWITCHES

Model T20-37AE  
3BCD switch with  
end plates  
\$6.29 each

## FERRITE BEADS

12/99¢ or 100/\$5.00

## BURR-BROWN

DC to DC POWER SUPPLY  
Model 510A/25  
Input voltage 22-34VDC  
Output voltage  $\pm 15V$  @ 100MA  
\$19.99 each

## NEW METERS

Emico 0-5MADC  
2 1/4 x 2 1/4 \$3.99

Beede 0-1MADC  
3 1/2 x 3 1/4 \$4.99

Beede 200UA for Pal  
KW-1 watts/SWR  
3 1/2 x 3 1/2 \$4.99

Allied 0-20MADC  
2 1/2 x 2 1/2 \$3.99

## TOROIDAL CORES

T37-6 and T37-10  
5/\$1.00, 25/\$4.00 or 100/\$18.00  
Not sold mixed

## TRIMMER CAPS

5-80 pf  
50¢ each or 10/\$4.00 or 100/\$30.00

## HIGH VOLTAGE CAPS

.001/1000pf 10KVDC  
\$1.00 each or 10/\$8.00

## CERAMIC STAND OFFS

1/2 in. round, 1 in. high  
or 3/8 in. round, 1 1/4 in. high  
36¢ each

## HIGH FREQUENCY FERRITE BEADS

3/8 in. long  
UHF to 10GC  
5/\$1.00, 25/\$4.00, 100/\$15.00

## NEW HEAVY DUTY RELAYS

12VDC @ 12Amps, 3PDT  
\$5.00 each

# SEMICONDUCTORS SURPLUS

✓ S63

2822 North 32nd Street/Unit -1 Phoenix, Arizona 85008 (602) 956-9423

We accept checks, MasterCharge, and Visa

Prices subject to change without notice



## E.F. JOHNSON TUBE SOCKETS & PARTS

### POWER TUBE SOCKET

for RCA 8072, 8021, 8122, and 8462  
EIA base #E11-81  
Will also fit CRT tubes 1EP11 and 1EP1 EIA base #E11-22

**\$4.99 each**

### SCREEN GRID BY-PASS CAPACITOR

1450pf @ 1000pf  
Part No. 124-0113-001

**\$9.95 each**

### POWER TUBE SOCKETS

for 4X150A and D, 4CX250B and R, 4CX350A  
Part No. 124-0107-001

**\$14.95**

### CHIMNEY for 4CX250B and R, 4X150A and D, and 4CX350A

Part No. 124-0111-001

**\$3.99**

### POWER TUBE SOCKETS

for 4-125A, 4-250A, 4-400A/C etc., 3-400Z, and 3-500Z

Part No.  
**\$29.95 per pair only**

### SPRAGUE RF NOISE FILTERS

#JN17-4080A  
100VDC @ 70Amps  
.22mfd

**\$2.99 each**

### CARBIDE DRILL BITS

for drilling P.C.B.

5 mix **\$6.00**  
10 mix **\$10.00**

## 25AMP SCR's

2N681	\$1.10
2N682	1.25
2N683	1.45
2N684	1.60
2N685	1.70
2N686	1.95
2N687	2.45
2N688	3.45
2N690	3.95

## E.F. JOHNSON MINIATURE TYPE V AIR VARIABLE CAPS

189-503-105	1.4-9.2pf
189-504-4	1.8-5pf
189-504-5	1.5-11.6pf
189-505-5	1.7-14.1pf
189-506-105	1.8-16.7pf
189-507-5	2-19.3pf
189-508-5	21.-22.9pf
189-509-5	2.4-24.5pf
189-1-1-4	1.2-4.2pf
189-4-5	1.5-9.1pf
189-5-8	1.1-11pf
189-6-8	1.8-13pf
189-503-5	1.4-9.2pf

**\$1.50 each**

## FET's

3N128	\$1.00 or 10/8.00
40673	1.39 or 10/10.00
MPF102	.45 or 10/3.50
MFE131	1.00 or 10/8.00
U2705/2N4416	1.00 or 10/8.00
MFE2000	1.00 or 10/8.00
MPF4391	.80 or 10/6.00
2N4303	.50 or 3/1.00
2N5484	.50 or 3/1.00
2N5555	.90 or 2/1.50
2N5639	.48 or 3/1.00
2N5246	.50 or 3/1.00
2N5248/MPF102	.45 or 10/3.50
3N201	1.99 or 10/12.00
3N157A	6.00 each

## MOTOROLA POWER TRIACS

TO-220 case  
15Amps 600PRV  
**99¢ each or 10/\$7.50**

## TUBES

2E26	\$ 5.00
3-500Z	90.00
3B28	4.00
3X2500A3	125.00
3X3000F1	200.00
4-65A	30.00
4-125A	40.00
4-250A	60.00
4-400A	80.00
4-1000A	175.00
4CX250B	38.50
4CX250R	40.00
4CX350A	50.00
4CX1000A	150.00
4X150A	20.00
4X150G	30.00
572B/T160L	39.00
811A	9.95
6146	4.50
6146A	5.25
6146B	6.50
6146W	7.50
6360	7.95
6939	8.00
8072	45.00
8295/PL172	300.00
8950	5.95
8877	300.00
7289	6.99
6KD6	4.00
6LF6	4.00
6LQ6/6JE6	5.99
8908	8.99
6550A	8.00

Other numbers on request

## HIGH VOLTAGE CAPS

22mfd @ 500VDC  
7/8 in. x 1 1/2 in.  
**\$1.99 each**

330mfd @ 450VDC  
Can Type  
1 7/8 in. x 4 1/4 in.  
**\$4.99 each**



# SEMICONDUCTORS SURPLUS

S63

2822 North 32nd Street/Unit -1 Phoenix, Arizona 85008 (602) 956-9423

We accept checks, MasterCharge, and Visa

Prices subject to change without notice



## HIGH VOLTAGE CAPS

150uf @ 450VDC  
Can Type  
1 3/8 in. x 3 1/2 in. high  
**\$2.99 each**

50uf @ 450VDC  
Can Type  
1 in. x 3 in. high  
**\$2.99 each**

## MINI TRIM POTS

5 Ohm	5 K
10 Ohm	10 K
17 Ohm	20 K
50 Ohm	25 K
100 Ohm	50 K
150 Ohm	100 K
200 Ohm	200 K
500 Ohm	250 K
1 K	500 K
2 K	1 Meg
2.5 K	5 Meg
4.7 K	

**49c each**

## MINI RF CHOKES

.2 uh	33 uh
.5 uh	39 uh
.56 uh	47 uh
.68 uh	100 uh
1.5 uh	680 uh
2.2 uh	1000 uh
3.3 uh	1 mh
6.8 uh	1.1 mh
10 uh	2.5 mh
22 uh	6.8 mh
27 uh	10 mh

**79c each**

## PRESS FIT RECTIFIERS

DO-21 500VDC @ 25Amps  
**2/\$1.00**

**MAN 3's**  
**4/\$1.00**

## FULL WAVE BRIDGES

Motorola MDA 204/3N256	2Amps @ 400VDC	<b>\$ .69 each</b>
Varo VH147	6Amps @ 100VDC	<b>1.00 each</b>
Varo VS148	2Amps @ 100VDC	<b>.69 each</b>
Varo VS647	2Amps @ 600VDC	<b>1.29 each</b>
Motorola and GI	25Amps @ 600VDC	<b>2.99 each</b>

## RF TRANSISTORS

2N2270	\$ .78	2N6084	\$13.20
2N2857	1.80	2N6094	5.75
2N2857JAN	2.45	2N6095	19.35
2N2947	17.25	2N6097	28.00
2N3261	2.10	2N6166	36.80
2N3375	7.99	2N6439	43.45
2N3553	1.80	40280	2.00
2N3866	1.09	40281	10.90
2N3866JAN	2.70	40282	11.90
2N3866JANTX	4.43	40894	.99
2N3925/M9477	6.00	FT3551C/2N6082NS	4.00
2N3948	2.00	(no stud)	
2N3950	26.25	PT3563	5.00
2N3818	6.00	PT4132D/2N5641	4.90
2N4072	1.70	PT4571A	1.50
2N4427	1.09	MRF216	20.00
2N4429	7.50	MRF221	10.00
2N4877	.90	MRF227	2.00
2N4959	2.12	MRF240	price on request
2N5108	3.90	MRF245	31.05
2N5109	1.55	MRF247	39.95
2N5179	.43	MRF314	14.00
2N5177	20.70	MRF412	price on request
2N5190	1.50	MRF422A	42.30
2N5583	4.43	MRF426A	price on request
2N5214	20.00	MRF450	10.35
2N5589	4.60	MRF450A	10.35
2N5590	6.30	MRF454/568BLYCF	17.95
2N5591	10.35	MRF472	1.15
2N5637	20.70	MRF475	2.90
2N5645	11.00	MRF476	1.38
2N5842/MM1607	8.65	MRF477	2.00
2N5919	30.00	MRF479	price on request
2N5946	13.20	MRF485	price on request
2N5849/MM1620	20.00	MRF502	.49
2N5862	50.00	MRF629	3.00
2N6080	5.45	MRF901	3.99
2N6081	8.60	MRF911	3.99
2N6082	9.90	MRF5176	13.00
2N6083	11.80	MRF8004	1.44
		Other numbers on request	

# SEMICONDUCTORS SURPLUS

✓ S63

2822 North 32nd Street/Unit #1 Phoenix, Arizona 85008 (602) 956-9423

We accept checks, MasterCard, and Visa

Prices subject to change without notice



## DIP TANTALUMS

.1 uf @ 10V  
 .1 uf @ 35V  
 .47 uf @ 35V  
 1 uf @ 35V  
 2.2 uf @ 25V  
 2.2 uf @ 16V  
 10 uf @ 35V  
 22 uf @ 10V  
 22 uf @ 16V  
 100 uf @ 3V  
**49¢ each**

## CAPACITORS

.001/1000pf @ 100VDC  
 1/8 in. round  
**10/\$1.00, 50/\$4.00,  
 100/\$7.00, 1000/\$40.00**

.01 @ 1KVDC  
**6/\$1.00**

.01 @ 25VDC  
**10/\$1.00**

.1 @ 25VDC  
**10/\$1.00**

.01 @ 50VDC  
**10/\$1.00**

.001 @ 50VDC  
**10/\$1.00**

## HAM MICROWAVE DOWNCONVERTER KIT

2100 to 2400MHz  
 Power supply kit with  
 P.C.B., downconverter  
 kit with P.C.B. and  
 antenna all for **\$159.95**  
 Or assembled and tested  
**\$299.95** (specify frequency  
 tuned to)  
 All parts necessary  
 included in kits.

## DIP PLUGS

14 pin **25¢**  
 28 pin **45¢**

## IC SOCKETS - LOW PROFILE

8 pin **20¢**  
 14 pin **17¢**  
 16 pin **19¢**  
 22 pin **25¢**  
 24 pin **28¢**  
 28 pin **30¢**  
 40 pin **40¢**

## IC SOCKETS - WIRE WRAP

40 pin **\$1.10**

## CHOKES (U252)

2.5mh 150ma  
**69¢ each**

## MUFFIN FANS

Removed from equipment  
 115VAC  
**\$4.99 each**

## MOTOROLA POWER TRANSISTORS

PNP MJE2955 **\$1.69**  
 NPN MJE3055 **.99**  
 60V @ 10Amps @ 90 Watts  
 20/120HFE

## MOTOROLA POWER DARLINGTONS

PNP MJ900 **\$1.69**  
 NPN MJ1000 **1.29**  
 60V @ 8Amps @ 90Watts @  
 1000HFE min.

## NEW SPST DIP SWITCHES

3 position **\$1.00**  
 4 **1.25**  
 5 **1.30**  
 6 **1.35**  
 7 **1.25**  
 8 **1.50**  
 10 **1.35**

## UA703 RF/IF

limiting amp.  
**\$1.00 each**

## LIGHT ACTIVATED SCR's

TO-18 case  
 400VDC @ 800MA  
**2/\$1.25**

## HIGH VOLTAGE CAPS

.02 @ 8000VDC  
 2 1/2 in. x 1 in.  
**\$2.00 each**

## FEED THRU CAPACITORS

.0015 uf  
 .0033 uf  
 .1 uf  
 .001 uf  
 100 pf  
 500 pf  
 800 pf  
 1000 pf  
 1200 pf  
 1500 pf  
 6200 pf  
**99¢ each**

## MOTOROLA/RCA 2N3055

NPN TO-3 case  
 115Watts, 100VCB,  
 70VCE, 15Amps,  
 20-70HFE min.  
**79¢ each**

## UA715 HIGH SPEED

OP AMP  
**\$1.00 each**

## C106B SCR

TO-92 case  
 .8Amps, 200V  
 200UA gate  
**10/\$1.00**

# SEMICONDUCTORS SURPLUS

✓ S63

**2822 North 32nd Street/Unit #1 Phoenix, Arizona 85008 (602) 956-9423**

**We accept checks, MasterCard, and Visa**

Prices subject to change without notice



## MURATA 455 KHz CERAMIC FILTERS

Model	SFD-455D	SFB-455D
Center Frequency	455KHz $\pm$ 2KHz	455KHz $\pm$ 2KHz
3db Bandwidth	4.5KHz $\pm$ 1KHz	8KHz $\pm$ 2KHz
Selectivity	26db Min. at - 10KHz 20db Min. at + 10KHz	
Ripple	1.5db Max.	
Input and Output Impedance	3K Ohms	30 Ohms Max. Impedance at Resonance
Insertion Loss	9db Max.	
Freq. Stability vs. Temp.		within $\pm$ 0.4% from - 10°C to + 80°C
Freq. Stability vs. Time		within 0.5% for 10 years
Working Voltage		50VDC Maximum
PRICE	<b>\$3.99</b>	<b>\$2.99</b>

## CRYSTAL AND CERAMIC FILTERS

10.7MHz narrow band crystal filter type 2194F  
 3db Bandwidth, 15KHz minimum  
 20db Bandwidth, 60KHz minimum  
 40db Bandwidth, 150KHz minimum  
 Ultimate 50db: Insertion loss 1.0db Max., Ripple 1.0db Maximum  
 Ct. 0  $\pm$  5pf., Rt. 3600 Ohms  
**\$5.95**

## AMATEUR RADIO SSB/CW RECEIVER BOARD

Design credit goes to: JAY RUSGROVE, W1VD, refer to April/May 1978 QST  
 P.C.B. **\$7.95 each**  
 P.C.B. with 3-MPF102, 1-LM386V, 1-2N2222A, 1-9.1V 1W Zener, 1-2.5Amps 50Volts Diode, 3-T36-6 Toroid cores, 4-T37-2 Toroid cores, and 2-FT37-63 cores.  
 All for only **\$14.95**

## MURATA 455 KHz CERAMIC FILTER

CFM 455E	Center Frequency 455	3DB Bandwidth $\pm$ 5.5KHz Min.
6DB Bandwidth $\pm$ 8DB Min.	70DB Bandwidth $\pm$ 15KHz Max.	Spurious Response 70DB Min.
Insertion loss 6DB Max.	Input, output Impedance 1500 Ohm	<b>\$6.99 each</b>

## MURATA 455 KHz CERAMIC FILTER

CFU455H2	Center Frequency 455 $\pm$ 1KHz	6DB Bandwidth $\pm$ 3DB Min.
40DB Bandwidth $\pm$ 9DB Max.	Spurious Response 25DB Min.	Insertion loss 6DB Max.
Input, output Impedance 2000 Ohm		<b>\$2.00 each</b>

# SEMICONDUCTORS SURPLUS

S63

2822 North 32nd Street/Unit # 1 Phoenix, Arizona 85008 (602) 956-9423

We accept checks, MasterCharge, and Visa

Prices subject to change without notice



## 10.7MHz CERAMIC FILTERS

SFE 10.7MA RED (must specify when ordering)

3DB Bandwidth

280 ± 50KHz

50DB Bandwidth

± 750KHz

Input, output

Impedance 330 Ohms

Center Frequency

10.700MHz ± 30KHz

Insertion loss

7 ± 2DB

Spurious Response

(8 Ohm, 12MHz)

**\$3.99 each**

## 10.7MHz CERAMIC FILTERS

SFE 10.7MA WHITE (must specify when ordering)

3DB Bandwidth

280 ± 50KHz

50DB Bandwidth

± 750KHz

Input, output

Impedance 330 Ohms

Center Frequency

10.760MHz ± 30KHz

Insertion loss

7 ± 2DB

Spurious Response

(8 Ohm, 12MHz)

55DB Min.

**\$3.99 each**

## CRYSTALS

1	MHz	47.250
1.6896	MHz	47.350
2.52	MHz	47.450
3.33	MHz	47.550
3.579545	MHz	47.650
3.80	MHz	47.750
4	MHz	46.850
5	MHz	46.950
5.896800	MHz	15.750
1	MHz	20.3200
10.240	MHz	26.250
10.695	MHz	81.920
12.80	MHz	147
13.102	MHz	315
14.317800	MHz	500
17.2800	MHz	3007
18	MHz	3009
24.88320	MHz	3011
47.050	MHz	3013
47.150	MHz	3707

**\$4.99 each**

## LINEAR I.C.'s

MHz	LM111H	\$5.11	LM386V	\$1.55
MHz	LM124J	2.55	LM387V	1.00
MHz	LM139AJ	3.00	NE526A	3.00
MHz	LM202H	3.50	NE531T	5.00
MHz	LM205H	2.50	NE527A	3.00
MHz	LM211H	3.75	NE555V	.39
MHz	LM211D	4.50	NE555H	4.00
MHz	LM301A	.25	NE560N	4.25
KC	LM304H	1.00	NE556N	1.00
KC	LM307A	.25	NE565	1.30
KC	LM308H	2.50	NE566V	2.00
KC	LM310H	.90	NE566H	2.50
KC	LM311V	.70	NE567V	3.00
KC	LM312H	2.70	LM709N	.25
KC	LM319H	1.50	LM711H	.25
KC	LM318H	1.25	LM723H	.50
KC	LM324N	1.45	LM723N	.50
KC	LM339N	.75	LM741V	.25
KC	LM342N15	1.50	LM741H	.25
KC	LF355H/B	3.00	LM747N	.50
	LM376V	1.50	LM1310N	2.00
	LM377N	2.40	LM1458V	.60
	LM380-8	1.00	LM1514J	2.00
	LM380-14	1.75	LM2901N	2.00
	LM380-14	1.75		
	LM381N	1.75		

# SEMICONDUCTORS SURPLUS

✓ S63

2822 North 32nd Street/Unit #1 Phoenix, Arizona 85008 (602) 956-9423

We accept checks, MasterCharge, and Visa

Prices subject to change without notice



## MICROWAVE DIODES

1N21	\$ 1.25
1N21B	1.90
1N21D	2.00
1N21WE	2.00
1N23WE	2.10
1N446	8.00
1N3655A	4.00
1S1544A	4.00
1N78	4.00
MV1863D	10.40
MBD101	1.99
HP5085-8328/1N5711/12	1.99
MV834	1.35
MV1624	1.42
MV2109	1.00
MV2201	1.00
GC20183-38	25.00
8K1003-1B	25.00
5082-8348	25.00
5082-2593	25.00
5082-6216MP	10.00

## 28 PIN LOW PROFILE I.C. SOCKETS

1-49	50-99	100-999
39¢ each	30¢	25¢

## USED AA NICAD BATTERIES

Untested - AS IS  
3 to a pack  
**\$1.17 a pack**  
(that's only 39¢ per battery!)

## TRIMMER CAPS

2-30pf or 5-50pf  
**45¢ each or 10/\$3.50**  
Not sold mixed

## ELECTROMOTIVE TRIMMER CAPS

308	130-1000pf
310	300-1500pf
<b>\$1.00 each</b>	

## RF CHOKES

500MH 150MA  
**79¢ each**

## VARIABLE CHOKES

10-85UH 500MA Coil  
**\$1.99 each**

## MOTOROLA RECTIFIERS

MR752  
6Amps 200PIV  
**55¢ each or 100 or more 35¢ each**

## 2N6308 NPN 125Watts

VCB700, VCE350,  
HFE12-60 min. 3Amps  
**\$1.99 each**

## 1N966B 15V ZENER 5%

10/\$1.00 100/\$6.00  
1000/\$30.00

## FAIRCHILD PHOTO

### TRANSISTORS

FPE 100  
**\$1.99 each**

## PISTON CAPS

.85 - 7pf **\$1.99 ea.**  
.8 - 18pf **1.99 ea.**

## NEW AMPHENOL

UG646/U  
90° UHF  
**\$1.65 each**

## PHOTO CELLS

VT700 and VT800  
**3/\$1.00**

## USED GOULD NICKEL-CADMIUM BATTERIES

9.6VDC @ .225AH  
2¼ in. long by 1 in. rnd.  
**\$1.99 each**

## USED NICKEL-CADMIUM BATTERIES

¾ in. high by ¾ in. round.  
8 batteries to a pack  
**\$1.99 a pack**

## TANTALUM CAPS

Cut and formed  
3.3uf @ 15VDC  
**15/\$1.00, 100/\$5.00**

## CLOCK OSCILLATORS

Q-Tech QT6C1  
1MHz  
14 pin dip  
**\$6.99 each**

## TMC Systems

No. XO-2004  
108KHz  
**\$6.99 each**

## TMC Systems

No. XO-2004  
2.128MHz  
**\$6.99 each**

## MOTOROLA

K1100A/6104B  
24.07342MHz  
14 pin dip  
**\$6.99 each**

## MOTOROLA

K1091A  
14.04MHz  
14 pin dip  
**\$6.99 each**

## TOSHIBA-K

P-TO-19C  
25.000MHz  
**\$6.99 each**

## GREENRAY IND.

Y1234AF6  
11MHz  
**\$6.99 each**

## MONITOR

No. 3725-09  
7.692MHz  
**\$6.99 each**

## GOLD 14 pin and 16 pin

**WIRE WRAP I.C. SOCKETS 30¢ each**

# SEMICONDUCTORS SURPLUS

✓ S63

2822 North 32nd Street/Unit #1 Phoenix, Arizona 85008 (602) 956-9423

We accept checks, MasterCard, and Visa

Prices subject to change without notice



## R.F. CONNECTORS

New Amphenol  
UG273/U  
UHF male to BNC female  
**\$2.00 each**

New UG1094  
BNC female  
**89¢ each or 10/\$6.50**

NEW DM1  
Dual male UHF  
**\$1.29 each**

NEW UG83B/U  
UHF male to type N female  
**\$5.00 each**

NEW UG255A/U  
BNC male to UHF female  
**\$3.00 each**

NEW VHF BARREL PL258  
**\$1.29 each**

NEW UG146A/U  
UHF female to type N male  
**\$5.00 each**

NEW UG201A/U  
BNC female to type N male  
**\$3.00 each**

UG274A/U  
BNC "T"  
**\$3.00 each**

NEW UG177/U  
Hood **39¢ each**

M358  
UHF "T"  
**\$3.00 each**

NEW UG349B/U  
Type N female to BNC male  
**\$4.00 each**

UG27  
90° Type N  
**\$1.99 each**

UG914U  
BNC female to BNC female  
**\$3.00 each**

NEW PL363  
UHF female Barrel  
2 in. long  
**\$2.50 each**

PLESSEY  
Model 94375/L6997-AE10  
**\$1.99 each**

AUTOMATIC  
Model 94375/L6995-AEXX  
**1.99 each**

AUTOMATIC  
Model L-6901-C05-929  
**\$1.99 each**

SEAELECTRO  
Model 50-624-9188-31/AI-107  
**\$2.29 each**

CRIMP TYPE  
Amphenol  
No. 225398-9  
BNC female  
**69¢ each**

Amphenol  
No. 2-330830-2  
UHF male  
**69¢ each**

POWER SUPPLIES  
Powertec Model 2B5-3  
Output 4.5VDC - 6.3VDC @ 3Amps  
5 in. high x 4 in. long x  
1 5/8 in. deep  
**\$19.95 each**

Standard Power Incorporated  
NEW model SPS-120-5  
5VDC @ 12Amps  
7 in. long x 5 in. high x 7 in. deep  
**\$59.95 each**

WIRE WRAP WIRE  
10,000 ft. per roll  
Insulation Milene  
AWG30 Color: Blue  
**\$69.96 per roll**

## METER MOVEMENTS

Simpson Meter  
0-1MADC  
Model 1327  
Cat. #17210  
0-150 cycles  
deviation  
3 1/4 in. x 3 1/4 in.  
**\$4.99 each**

NEW Pride Electronic Meter  
1MADC  
0-1000 RF watts  
output  
3 1/4 in. x 4 1/4 in.  
**\$3.99 each**

## USED TRANSFORMERS

BGH9  
6.3VCT @ 10Amps  
**\$3.99 each**

Triad F-108U  
Stancor P6378  
12V @ 8Amps or  
24V @ 4Amps  
**\$9.95 each**

Triad F-49U  
36V @ 3Amps and  
36V @ 3Amps  
**\$9.99 each**

Triad F23U  
10VCT @ 7Amps  
**\$9.99 each**

Triad F54X  
35VCT @ 1.5Amps  
**\$3.99 each**

# SEMICONDUCTORS SURPLUS

✓ S63

2822 North 32nd Street/Unit #1 Phoenix, Arizona 85008 (602) 956-9423

We accept checks, MasterCharge, and Visa

Prices subject to change without notice



## NEW TRANSFORMERS

SIGNAL DU-2 Primaries

0-104-110-120

0-104-110-120

Secondaries

0-104-110-120

0-104-110-120

\$69.99 each

TRIAD F18X

Primary 115VAC

Secondary 6.3VCT @ 6Amps

\$4.95 each

PT1627 12V @ 250MA

\$1.99 each

TRIAD F94X

Universal Voltage

\$3.99 each

SM5B-ATC-1035-7545

24VCT @ 300MA and 1V @ 1Amp.

\$2.99 each

## ORDERING INSTRUCTIONS TERMS AND CONDITIONS

### TERMS:

Domestic: Check, money order, credit cards, or COD orders welcome (Mastercharge and VISA only). Foreign: No personal checks or certified personal checks accepted. Money order or cashier's check in U.S. funds only. No COD available to any foreign country. Letters of credit are not acceptable.

### COD:

COD's by UPS will be charged a \$2.00 handling charge plus shipping. COD by mail will be charged \$1.00 handling charge, plus COD charges by post office, plus shipping.

### POSTAGE:

Minimum shipping by UPS is \$2.00 plus 35¢ insurance per \$100.00. Please allow extra shipping charges for heavy items. Shipping of light, small items by mail (to fit in insulated envelopes) is \$1.00, not insured.

### RESTOCK CHARGE:

All parts returned due to customer error will be subject to a 15% restock charge.

### SHORTAGE/DAMAGE:

Claims must be made within ten (10) days after receipt of parcel. All requests must include invoice number and date.

### DEFECTIVE MATERIAL:

Claims must be made within ten (10) days after receipt of parcel. All requests must include defective material, invoice number and date.

PRICES are subject to change without notice. Prices supersede all previously published. Some items offered are limited to small quantities and are subject to prior sale.

**\$10.00 MINIMUM ORDER plus shipping. ORDERS LESS THAN THIS MINIMUM WILL BE RETURNED UNPROCESSED. NO EXCEPTIONS.**

# First Look at Latest Radio Laws — the official work

Read from right to left.

*John W. Bailey KB5AO  
Route 9, Box 279  
Sour Lake TX 77659*

**1** All rules and regulations are printed in reverse order. They should be read from right to left for maximum comprehension.

2. Any section of Part 97 conducive to good operating procedures will be changed on the next FCC docket.

3. The FCC encourages all amateurs to improve their skills toward the goal of being allowed to operate in the 27.405-28.000-MHz band.

4. Propagation characteristics of HF signals are influenced mainly by the distance (in meters) between the transceiver and the nearest wall.

5. Propagation forecasts may be ignored, as they are formulated by those who understand the subject.

6. Minimize interference to other services by disconnecting the microphone (or key) from the transmitter. Note that in some cases, additional shielding may be required.

7. Wideband F3 emissions are not allowed below 50 MHz.

8. Wideband F3 emissions are not allowed above 50 MHz.

9. Average power is 1.5 times unmodulated power, which is 4 times the modulating power (1.717x) as related inversely to PEP/average ratio of 2 to 1 or 4 to 1, as the case may be.

10. Resistors and inductors are identical, and those of like values may be interchanged (see Ohm's Law). Capacitors react inversely and must be installed backwards.

11. Ohm's Law is an unproven theory which changes, depending on whether one reads QST or 73. Note: QST takes the conservative view.

12. In ACs (audio circuits), black wires must be connected to black wires and red wires must be inductively coupled to red wires of the same gauge.

13. Circuits oscillate because of insufficient neutralization of tuned circuits. This leads to degeneration of the entire circuit. Such a condition may be prevented by careful adherence to #12 above.

14. Vacuum tubes are sacred instruments of the gods and should not be adjusted internally under any circumstances.

15. Transistors (and ICs) are instruments of the devil and should be left alone.

16. Semiconductor diodes are the source of many electronic problems, as they pass current in only one direction.

17. Toroidal inductors create a magnetic field and are very useful in picking up small items dropped into the rig. In normal operation, these devices attract

metal. By reversing the leads (and thus the magnetic field), plastic and mica are attracted.

18. Resonant circuits in rf amplifiers cause a hollow, tinny sound in the transmitted signal. Key clicks may also be observed if a scope is attached.

19. The transmission line must be of a length sufficient to reach from the rig to the antenna. Insufficient length leads to non-resonance and reduced signal output.

20. If an antenna stays up, it is too small. (This information was obtained from other sources and is subject to personal verification.)

21. The oscilloscope is valuable in observing radio phenomena such as wavelength, resistance, impedance, and the size of the outer conductor.

22. "You can't work 'em if you can't hear 'em." (Illustrates the need for a receiver in all shacks.) ■



## FAST SCAN ATV

### WHY GET ON FAST SCAN ATV?

- You can send broadcast quality video of home movies, video tapes, computer games, etc, at a cost that is less than sloscan.
- Really improves public service communications for parades, RACES, CAP searches, weather watch, etc.
- DX is about the same as 2 meter simplex — 15 to 100 miles.



### ALL IN ONE BOX

TC-1 Transmitter/Conv  
Plug in camera, ant, mic and you are on the air . . . . . \$399 ppd



HITACHI HV-62 TV CAMERA  
High performance closed circuit camera just right for atv. with lens . . . . . \$239 ppd

### PUT YOUR OWN SYSTEM TOGETHER



TVC-1B CONVERTER tunes 420 mhz down to ch 2 or 3.. \$49.50 ppd  
TXA5 EXCITER . . . . . \$69 ppd  
PA5 10 WATT LINEAR . . \$79 ppd  
FMA5 Audio Subcarrier . \$24.50 ppd

### SEND FOR OUR CATALOG, WE HAVE IT ALL

Modules for the builder, complete units for the operator, antennas, color cameras, repeaters, preamps, linears, video ider and clock, and more. 19 years in ATV.

Call 213-447-4565 5-6 pm

✓ P41



## P.C. ELECTRONICS

Maryann  
WB6YSS

2522 PAXSON  
ARCADIA, CA 91006

Tom  
W6ORG



## ANTENNAS

Model OJA-146

### TWO METER AMATEUR BAND 146-148MHz

- NO GROUND PLANE REQUIRED
- USE FIXED, MOBILE, OR PORTABLE
- 5dB GAIN OVER ISOTROPIC IN MOST MOBILE APPLICATIONS
- OVERALL LENGTH: LESS THAN 64 INCHES
- COLLAPSIBLE TO 22 INCHES. MAY BE PACKED IN SUIT-CASE FOR THOSE OUT-OF-TOWN TRIPS
- STEEL WHIP AND ADAPTER INCLUDED FOR MOBILE AND FIXED APPLICATIONS
- VSWR: LESS THAN 1.2:1

PRICE \$39.95 UPS Prepaid  
220 MHz — \$37.95 450 MHz — \$37.95



# MADISON

Electronics Supply, Inc.

1508 McKinney • Houston, Texas 77002 • (713) 658-0268

✓ M35

## The Iambic Keyer Paddle.



Our newest keyer paddle was designed in response to your request for an iambic paddle with the famous Vibroplex quality and features built right in.

### Features include:

- Adjustable jeweled bearings
- Tension and contact spacing fully adjustable
- Large, solid, coin silver contact points
- 2½ lb. chrome plated steel base rests on non-skid feet
- Lifetime guarantee against manufacturing defects.

“Standard” model with textured gray base available for \$49.50, “Deluxe” \$65.00. Available at your dealers or through the factory. Send check or money order, or use your VISA or Master Charge. We pay all shipping charges except on orders outside the continental U.S.



P.O. Box 7230  
476 Fore Street  
Portland, Maine 04112  
Telephone: (207) 775-7710

✓ V24

JUST GETTING ON THE AIR?  
**See Adirondack for**



- New Equipment
- Used Gear
- Friendly Advice

**ADIRONDACK** Radio Supply

185-191 West Main Street • P.O. Box 88  
 Amsterdam, N.Y. 12010 Tel. (518) 842-8350  
 Just 5 minutes from N.Y. Thruway — Exit 27

✓A1

# BEWARE!!

Aluminum towers are not usually as strong as steel towers — ask for engineering facts before purchasing any tower. Aluminum towers, in most cases, are one-half as strong as steel towers within the same price range.

Notice Paid For By Unarco-Rohn U2

(Advertisement)

When it comes to  
**AMATEUR  
 RADIO QSL's...**

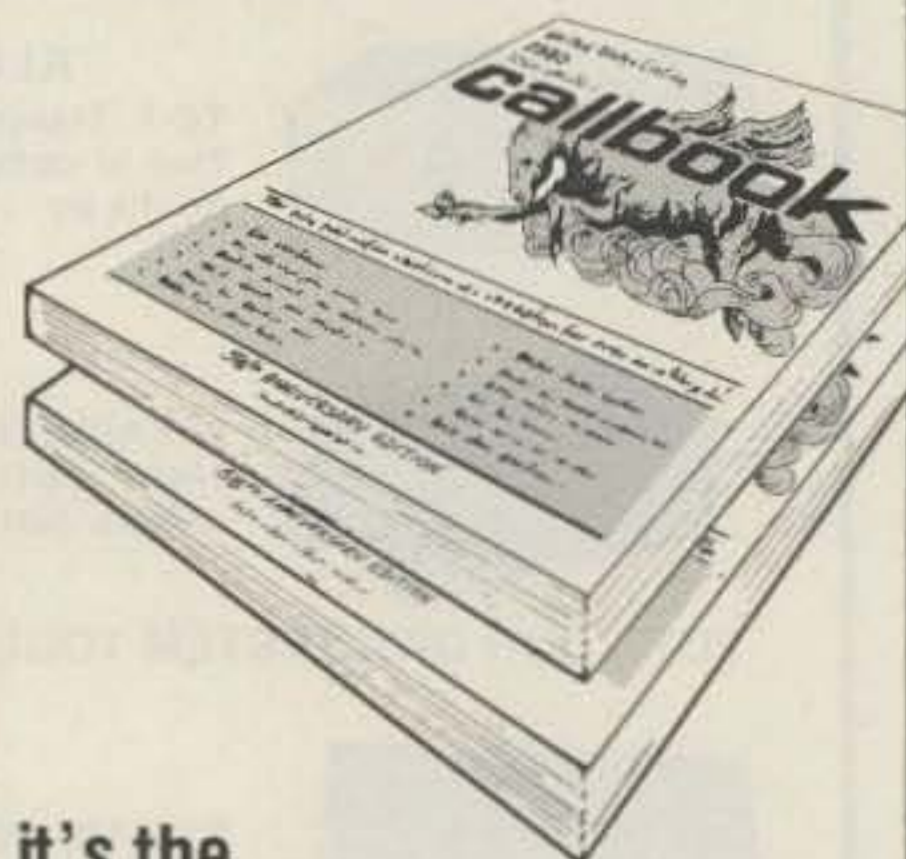

it's the  
**ONLY BOOK!**  
 US or DX Listings

1980  
**callbooks**  
 NOW READY!

Here they are! The latest editions. World-famous Radio Amateur Callbooks, the most respected and complete listing of radio amateurs. Lists calls, license classes, address information. Loaded with special features such as call changes, prefixes of the world, standard time charts, world-wide QSL bureaus and more. The new 1980 Radio Amateur Callbooks are available now. The U.S. Edition features over 400,000 listings, over 120,000 changes from last year. The Foreign Edition, over 315,000 listings, over 90,000 call changes. Place your order now.

	Each	Shipping	Total
<input type="checkbox"/> US Callbook	\$16.95	\$1.75	\$18.70
<input type="checkbox"/> Foreign Callbook	\$15.95	\$1.75	\$17.70

Order both books at the same time for \$34.65, includes shipping.

Order from your favorite electronics dealer or direct from the publisher. All direct orders add \$1.75 for shipping. Illinois residents add 5% Sales Tax.



**SPECIAL LIMITED OFFER!**  
**Amateur Radio  
 Emblem Patch  
 only \$2.50 postpaid**

Pegasus on blue field, red lettering. 3" wide x 3" high. Great on jackets and caps. Sorry, no call letters.

**ORDER TODAY!**

✓R1

RADIO AMATEUR  
**callbook** INC.



Dept.  
 925 Sherwood Drive  
 Lake Bluff, IL 60044

Completely Free  
Standing Towers

TELE TOW'R

PAT. NO. 4,151,534

**40' MODEL**

Model 40 (extends from 21' to 40')  
List \$259.10

**Breakover Model 40** (extends from 23' to 40' with breakover at ground level)  
List \$440.62

**55' MODEL**

Model 55 (extends from 21' to 55')  
List \$473.97

**Breakover Model 55** (extends from 23' to 55' with breakover at ground level)  
List \$661.75

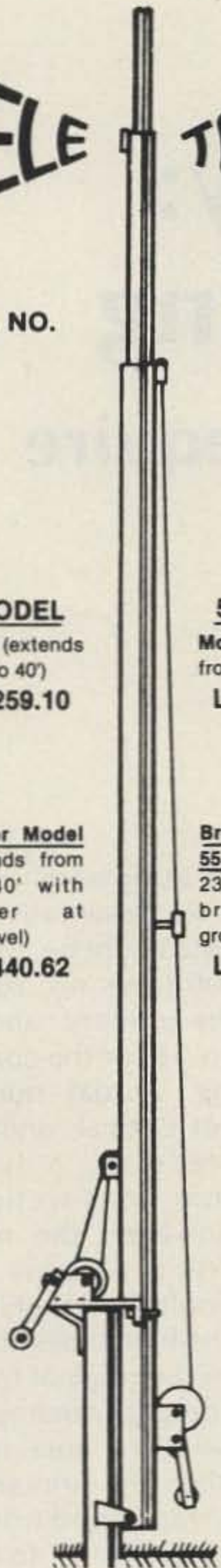

All steel constructed.

Concrete sleeve available for all models.

TELE-TOW'R MFG. CO., INC.  
P.O. Box 3412 • Enid, OK 73701  
405-233-4412 ✓T52

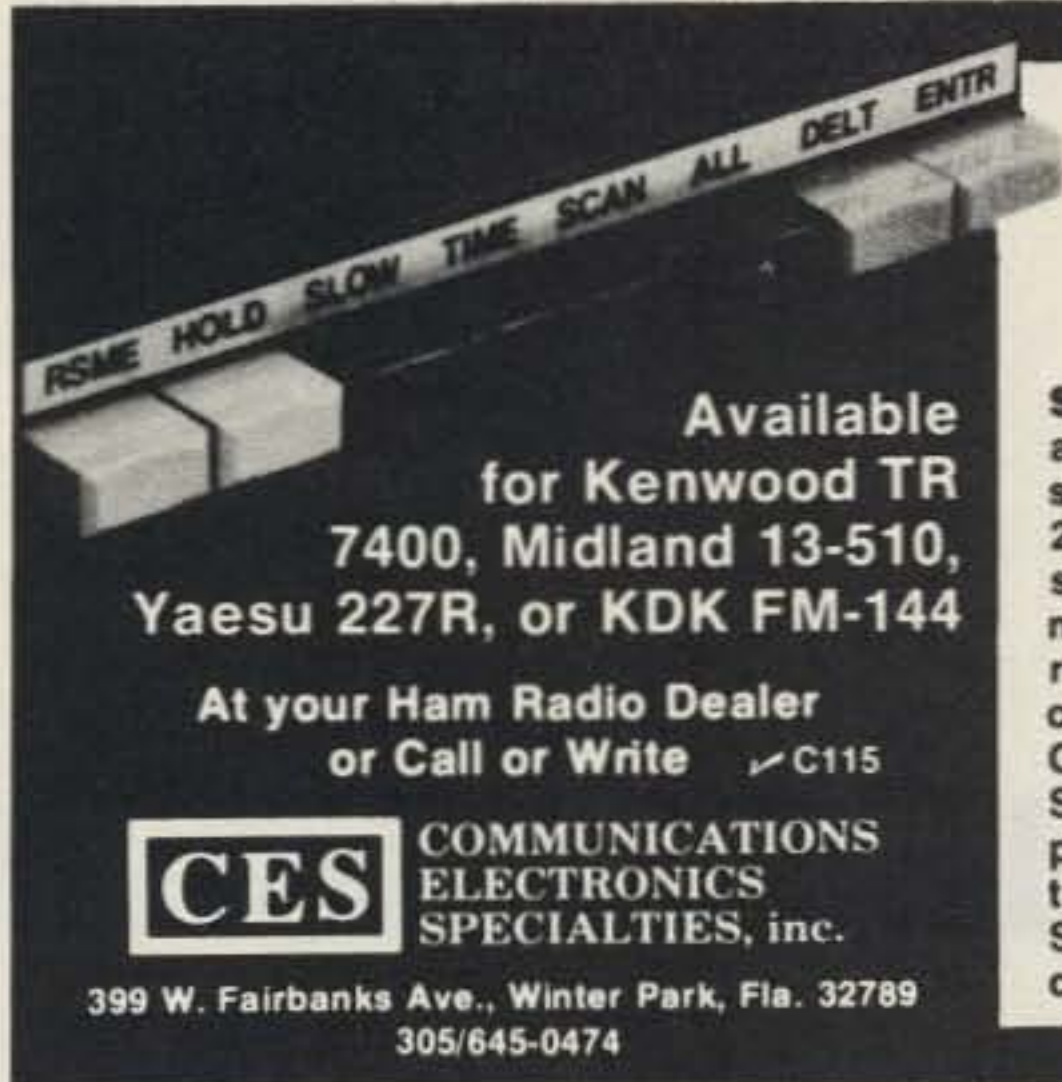

Available for Kenwood TR 7400, Midland 13-510, Yaesu 227R, or KDK FM-144

At your Ham Radio Dealer or Call or Write ✓C115

**CES** COMMUNICATIONS ELECTRONICS SPECIALTIES, inc.

399 W. Fairbanks Ave., Winter Park, Fla. 32789  
305/645-0474

**TODAY'S MOST VERSATILE SCANNER**

Scan a few channels or all 800 - for example - you can program CES Model 800 to scan Repeater and Simplex Channels or all 2 Meter Bands - Other features include: Instantaneous Addition or Deletion of Channels • Scan Resume delay assures hearing return calls • Resume and Hold provides complete control of scanning action • Hold Control activated by mic's P.T.T. switch • Scan entire band in 5 KHz steps and retain programmed memory • Selectable automatic scan resume after 10 secs. on channel. Slow Scan of memory to locate specific channels.

**DOVETRON**



**MPC-1000C**

Multipath Correction In-Band Diversity & AFSK Tone Keyer

Amateur Net: \$545.00

Standard features include CONTINUOUSLY tuneable Mark and Space channels (1000 Hz to 3200 Hz), Dual Mode (MARK or FSK) Autostart and internal high level neutral loop keyer (20 to 60 ml). Both EIA and MIL FSK outputs are provided for direct interface to microprocessor and video terminal peripherals.



**MPC-1000CR**

Signal Regeneration & Speed Conversion

Amateur Net: \$645.00

A front panel switch permits internal TSR-200 Signal Regenerator-Speed converter assembly to electronically "gear-shift" between 60, 67, 75 and 100 WPM. All incoming and outgoing signals are regenerated to less than 0.5% bias distortion. Also available with DIGITAL Autostart (TSR-200D): Amateur Net: \$695.00



**MPC-1000R/-  
TSR-500**

Dual UART Regeneration, Speed Conversion, 200 Char. Memory, Word Correction & DIGITAL Autostart

Amateur Net: \$895.00\*

The MPC-1000R/TSR-500 provides Preloading and Recirculation of the 200 character FIFO Memory, a keyboard-controlled Word Correction circuit, Variable Character Rate, Tee Dee Inhibit, Blank/LTRS Diddle, a Triple Tone-Pair AFSK Tone Keyer and a Character Recognition/Speed Determination DIGITAL (DAS-100) Autostart mode.

\*The MPC-1000R is also available without a TSR assembly and functions as a MPC-1000C with a Triple Tone-Pair AFSK Tone Keyer. This "Basic-R" permits future expansion with a TSR-100, TSR-200, TSR-200D or TSR-500 by simply lifting the lid and plugging in the appropriate TSR assembly: Amateur Net (Basic-R): \$595.00

Your QSL will bring complete specifications, or call: 213-682-3705.



✓D23

627 FREMONT AVENUE  
(P. O. BOX 267)  
SOUTH PASADENA, CA. 91030

✓ Reader Service—see page 259

Dec 1979

# The Induction Relay: Self-Powered Switching

— this unusual actuator doesn't require a separate control voltage

Waldo T. Boyd K6DZY  
P. O. Box 86  
Geyserville CA 95441

A standard relay requires a separate source of low-voltage current to pull in the armature, usually supplied by either a step-down transformer or a low-voltage dc supply. There's an interesting and potentially very useful way of controlling remote equipment without need for a separate low-voltage source: The induction relay.

An induction relay is particularly appropriate when a mechanical function such as opening a detent is needed.

In Fig. 1, a laminated core, such as an old transformer "E" core, is wound with the main or primary winding on one outside leg. The other outside leg is sawed off and used as the armature. A secondary winding of a few turns of heavier wire is placed around the center leg of the "E" to form the control winding.

The primary winding is connected across the 115-V

supply line. With the control winding open, the primary winding induces a magnetic flux that flows through the path of least magnetic reluctance, the center leg of the "E", leaving the armature unaffected. When the remote switch shorts the control coil, the major portion of the flux shifts to the longer circuit path that includes the armature, pulling it in to close that magnetic circuit. Thus, only a minimum holding current flows through the control winding and external switch circuit.

The value of the open-circuit voltage is not important, but can be determined easily since it bears the same relationship to the source voltage as the turns-ratio relative to the primary. In essence, the signal transformer is incorporated in the relay itself.

Variations of remote control may be had by substituting mechanical linkages for the relay contacts, or

by using both.

Representative winding data might be, for instance, 400 turns no. 26 or 28 for the primary, and 50 turns no. 18 for the control winding. Actual numbers are not critical, and minimum needs are a function of core cross-sectional area. However, the number of primary turns required would be roughly one and one-half times the number on the original transformer primary winding because the core area is reduced when the primary winding is transferred from the center of the "E" to the end. If all the original primary wire is rewound onto a smaller coil form, the number of turns will come out just right.

In the example above, the control voltage would be about 14 volts, open circuit, just right for a no. 18 bell wire pair, provided the run (distance from relay to shorting switch) is not excessive. ■

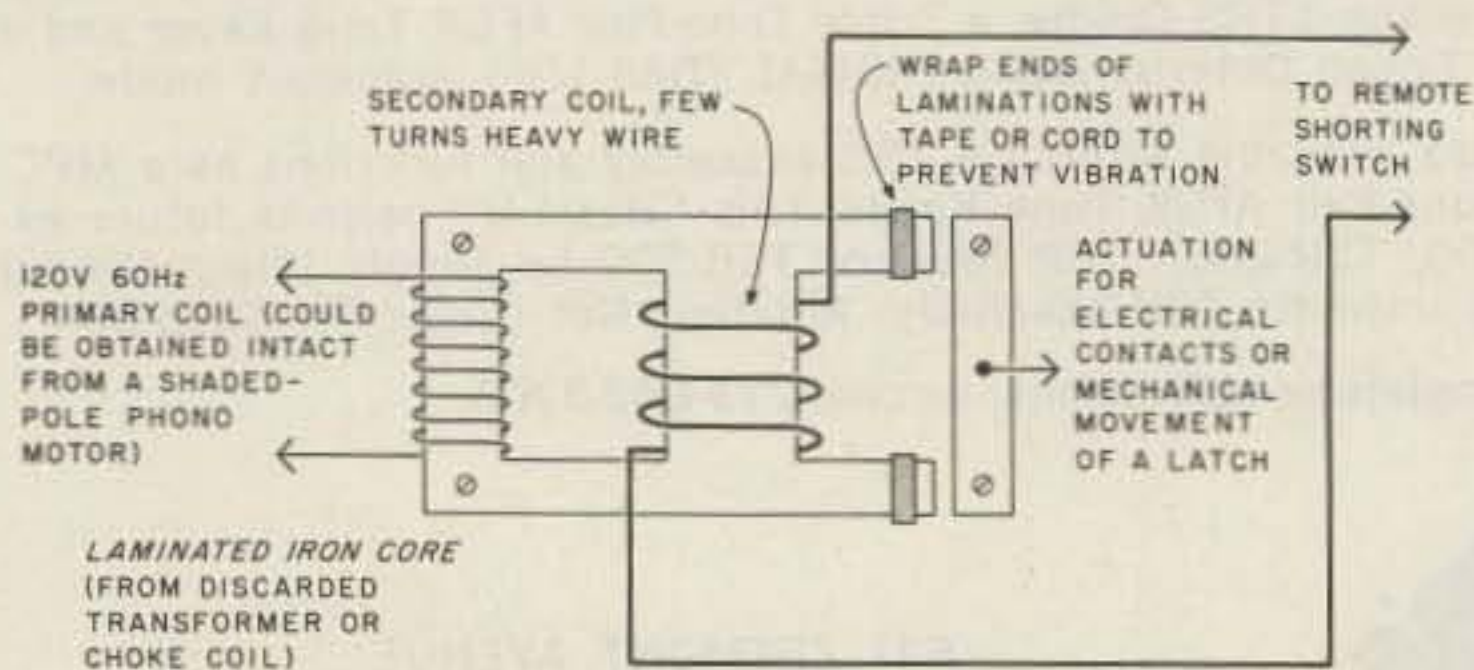

Fig. 1.

# MILITARY SURPLUS WANTED

WE NEED: ARC-51BX, ARC-94, ARC-102, ARC-109, ARC-115, ARC-116, ARC-131, ARC-134, ARC-164, ARN-82, ARN-83, ARN-84, APN-59, APN-153, APN-141, APN-147, APN-171, APX-72, 618T, CU-1669A, 490T-1, CU-1658A, 51Y-4, 51R-8, 51RV-1, FM-622, 807A, URC-9, TOP DOLLAR PAID OR TRADE FOR NEW AMATEUR GEAR. WRITE OR PHONE BILL SLEP (704) 524-7519

SLEP ELECTRONICS COMPANY  
P.O. BOX 100, DEPT. 73,  
OTTO, NORTH CAROLINA 28763.

## Key Electronics

### AUTOMATIC DIALING TOUCH TONE MICROPHONE

CES Model 235

- Stores 5 eleven digit and 5 seven digit phone numbers
- Programs and operates entirely from keyboard
- Programmable dialing rate
- Stores last manually dialed number
- Built-in speaker for tone monitor
- Programmable 2 second pause
- Automatic PTT 5 second before first tone



69<sup>95</sup>

#### INTEGRATED CIRCUITS:

SN76477N	Complex sound generator	\$2.95
TL489C	Analog level detector	\$1.25
LM317T	Adj. volt. reg. 1.5 amp.	\$2.75
ICM7555	Low pwr. CMOS Timer	\$1.25
LF351N	High speed JFET Op Amp	.75
NE565	PLL	\$1.10

FREE: CA3140 with orders of \$5.00 or more  
Please include \$1.00 for postage and handling

N.Y.S. Residents Add 4% Sales Tax

Send to: Key Electronics  
P.O. Box 3506

Schenectady, NY 12303

## AMCT-80

Automatic Morse Code Teacher for the TRS-80

This is the only morse code program available that will automatically speed up or slow down depending on your proficiency to receive code. Will send in single or group character mode. Written in machine language. Specify Level 1 or Level 2 and memory size.

AMCT-80 on cassette \$14.95

Send for TRS-80 catalog.

### COST EFFECTIVE COMPUTER SERVICES

728 S. 10th St., Suite #2  
Grand Junction, CO 81501

(303) 243-3629

# URFI

(UNIVERSAL RECEIVED FREQUENCY INDICATOR)



Digitize your receiver's dial with the DIAL SPOTTER. Adapts to most Communication Receivers with simple connection to VFO. From \$149.95 Write for Data Sheet.

## GEMINI INSTRUMENTS INCORPORATED

Box 205, Larchmont, NY 10538

## NOW! NOW! NOW! NOW! NOW!

The ultimate answer for eliminating the damaging effects of antenna weight on your rotor . . . it's the "UDM THRUSTOR"



- Fits any taper tower or can be used with flat top.
- Accepts 1 1/4" mast pipe
- All steel construction.
- Utilizing precision ground & hardened ball-type thrust bearing.
- Comes ready to install.
- Eliminates the damaging effect on your rotor.
- Shipped prepaid UPS (U.S.A.)
- Check, cash, money order, Visa, MasterCard. \$49.95 complete.
- Also available for 2" mast pipe for \$59.95

UDM ENTERPRISES  
P.O. Box 2037, Sandusky, Ohio 44870

GND INPUT

MINI MODULES & PLUG IN ASSEMBLIES TO FIT YOUR PROJECT & POCKET

BROADBAND AMPLIFIERS Q1

RF & IF Q2

FET MIXERS & CONVERTER

AMPLIFIERS

COMPRESSIVE AUDIO PREAMPLIFIER

This ad is a scale outline of an Audio Power Amplifier 1101-2

Q3 SEND FOR YOUR Q4

SHORT FORM CATALOG

**HFT INC**

158 WEST 9TH ST. DEER PARK NY 11729

TO SPEAKER 8 OHM

## 50 144 REPEATERS 220 450 Mhz

### Hi Pro Mk I



#### OPTIONS

- Duplexers
- Basic auto patch
- Matching cabinet
- .0005% High stability crystals

50 MHz \$889.95 450 MHz 899.95  
144 or 220 MHz 799.95

New and Improved Receiver and Transmitter

#### Available Separately:

COR Identifier: All on one board, programmable, Fully adjustable, time out (.5-7 min.), hang time (0-1 min.), identifier (1-10 min.), tone, speed, volume, L.E.D. outputs, low current drain CMOS logic, plugs for easy installation and removal plus much more. \$79.95

Basic Repeater \$599.95

2M 130-175 MHz Basic Repeater for 2 meters with all the features of the Hi Pro MkI less the power supply and front panel controls and accessories.

PA Res. add 6% tax  
PLUS SHIPPING

## Maggiore Electronic Laboratory

845 WESTTOWN RD.  
WEST CHESTER, PA. 19380 PHONE 215 436-6051

# Code Made Easy.

To really master code, get Pickering Code Master instruction tapes. They're easy to use, easy to learn, complete and reliable. But don't just take our word for it, ask any ham. Or order a set and see for yourself.

**CM-1 Novice.** A complete course with 5, 7 and 9 WPM code group practice.

**CM-1½ General.** No instruction, just practice. ½ hr. at 11 WPM, 1 hr. at 14 WPM and ½ hr. at 17 WPM. Tape includes coded groups and straight text.

**CM-2 Extra Class.** Mostly straight text, some groups. 1 hr. at 20 WPM, ½ hr. at 25 and 30 WPM.

All courses are two hours long and come with key sheets for checking problem areas.

To order, send your check, money order, Master Charge or Visa number (along with card expiration date) to Codemaster. Specify number and quantity of tapes desired. Tapes are \$7.95 each, two for \$14, and three for \$19. Also specify 7" reel or cassette. We'll send your tapes post paid by fourth class mail. First class, Canada and Mexico orders, add \$1 per reel, 50¢ per cassette. To order by phone, call (401) 683-0575.

R.I. residents, add 6% sales tax.

Pickering  
Codemaster Co.,  
P.O. Box 396 D,  
Portsmouth, R.I.  
02871



**Pickering Codemaster. Your key to code.**

# CUSTOM TRANSFORMERS



## HEAVY-DUTY

### REPLACEMENT TRANSFORMERS

BTILK-2000 Plate	\$135	HEATH HA-10 Plate	\$115
COLLINS 30S-1 Power	\$215	HEATH HX-10 Power	\$95
COLLINS KWS-1 Plate	\$135	HEATH SB-220 Plate	\$125
COLLINS 516F-2 Power	\$95	HENRY 2K Plate	\$150
DENTRON 160-10L Power	\$125	HENRY 2K-2 Power	\$155
DRAKE L4B Plate	\$165	HENRY 2K-4 Power	\$165
GONSET GSB-100 Power	\$95	HENRY 3K-A Plate	\$165
GONSET GSB-201 Power	\$135	HENRY 3K-A DC Choke	\$85
H-CRAFTERS HT-32 Power	\$95	EFJ T-BOLT Plate	\$125
H-CRAFTERS HT-37 Power	\$95	EFJ 500 Modulation	\$95
HEATH DX-100 LV Power	\$95	EFJ 500 DC Choke	\$75
HEATH DX-100 Modl	\$95	NATL NCL-2000 Plate	\$125

### OFF-THE-SHELF SPECIALS

PLATE XFMR:	3000 VAC @ 3.0A CCS 230 PRI-120LB	\$450
PLATE XFMR:	2400 VAC @ 1.5A ICAS 220/240 PRI-41LB	\$150
PLATE XFMR:	3000 VAC @ 1.5A CCS 230 PRI-60LB	\$195
PLATE XFMR:	3000 VAC @ 0.7A ICAS 115/230 PRI-27LB	\$115
PLATE XFMR:	3500 VAC @ 1.0A ICAS 115/230 PRI-41LB	\$150
PLATE XFMR:	4000/4600 VAC @ 1.5A ICAS 230 PRI-60LB	\$195
PLATE XFMR:	6000 VCT @ 0.8A CCS 115/230 PRI-41LB	\$150
FILMT XFMR:	5.0 VCT @ 30A 117 PRI-9.5LB	\$30
FILMT XFMR:	7.5 VCT @ 21A 117 PRI-9.5LB	\$30
FILMT XFMR:	7.5 VCT @ 55A 115/230 PRI-14.6LB	\$65
FILMT XFMR:	7.5 VCT @ 75A 115/230 PRI-20.2LB	\$95
FIL CHOKE:	30 AMP Bifilar Wound on ½" x 7" rod	\$9
DC CHOKE:	8.0 Henries @ 1.5 AMP DC 41LB	\$150
SWG CHOKE:	5-30 Henries @ 1.0 AMP DC 23LB	\$100

ALL TRANSFORMERS & CHOKES GUARANTEED FOR 24 MONTHS

Many others also available. Write for free list or quote on any custom transformer, choke, or saturable reactor.

## Peter W. Dahl Co.

4007 Fort Blvd. • El Paso, Texas 79930  
Telephone (915) 566-5365



**Germantown  
Amateur  
Supply,  
Inc.**

MEMPHIS, TENNESSEE

## NO MONKEY BUSINESS!

- (A) Complete Service Facilities
- (B) Good Deals on most Brands
- (C) Shipping within 24 Hours
- (D) All inquiries handled by Active Hams with over 20 years experience in ham radio

CALL TOLL FREE  
1-800-238-6168

IN TENNESSEE, CALL 901-452-4276  
MONDAY - SATURDAY 8:30-5:30  
FOR YOUR SPECIAL.

Write: 3202 Summer Ave., Memphis, Tennessee 38112

# The Ultimate QRM Killer

DATONG MODEL FL-1



FREQUENCY-AGILE  
AUDIO FILTER  
**\$199.95**

Including Pre-Paid  
Shipping & Full Insurance

- Made in England
- 90 Day Warranty
- Reviewed in QST Aug. 1979
- VISA-MASTERCHARGE accepted

Model FL 1 is a versatile add-on audio filter for communications receivers. It gives great flexibility in helping to extract the desired signal (SSB, CW, RTTY, etc.) from background interference and yet simply connects between loudspeaker and receiver output.

- Fully automatic search/lock/track operation for notching out unwanted heterodynes.
- Selectable bandpass or band-reject modes.
- Bandwidth smoothly variable from 20 Hz to 1000 Hz.
- Center frequency smoothly variable from 280 to 3000 Hz.
- Built-in 2 watt power output stage.
- Uses internal 9-volt battery or external source of 6 to 12 volts DC.

#### Application to CW

Model FL 1 is superb for CW reception. As an extra refinement automatic frequency control can be switched, which enables the filter to tune itself onto a CW station over a 100 Hz range. This way the 20 Hz minimum bandwidth becomes as easy to tune in as if it were 100 Hz.

#### Application to SSB and RTTY

For SSB or RTTY reception Model FL 1 can be used to give either a fully adjustable audio "window" to pass the wanted signal and to reject others, or as a variable notch to remove unwanted narrow band signals. Tuning in the notch mode can be fully automatic or manual. Auto-notching allows routine "hands off" use of a notch only 20 Hz wide so that the wanted signal is completely unaffected.

Dedicated to Excellence (Exclusive importers of DATONG ASP's)

**AR**

Technical  
Products  
Corp.

Box 62  
Birmingham, Michigan 48010  
Telephone 313/644-5698

✓A105

**AMATEUR RADIO'S  
BIGGEST MAGAZINE AT HALF PRICE!**

# INFLATION **73** FIGHTER!!!

We want you to enjoy Amateur Radio's biggest magazine for only \$1.25 per issue. With the rising cost of everything, we want to help you combat inflation. We're making this extraordinary offer on the world's biggest amateur radio magazine to prove to you that 73 will put more fun into your hobby than anything else for the money.

## **MONEY BACK GUARANTEE**

If, after reading your first issue, or even your 11th one, you don't agree that 73 is worth far, far more than \$1.25 an issue to you—simply cancel and receive a full refund on all remaining issues.

However, we think we will have you for life. Because no matter what aspect of amateur radio you're interested in—or want to get interested in—73 Magazine covers it more thoroughly and makes it more fun than any other publication.

Quality features each month fill you in on the latest techniques and equipment . . . expand your expertise . . . guide you into new areas that will make amateur radio as exciting to you as the day you keyed your first transmission.

So act now! Fill out the attached postage-paid card today and drop it in the mail. You'll receive your first information-packed issue in four to six weeks.

# The Further Adventures of Keycoder

— simplified wiring for the toroidal cores

In the July, 1976, issue of *73 Magazine*, there was an article about Keycoder I, a Morse code generator using a typewriter-style keyboard. This article by WA9VGS caught my eye. I had seen other circuits in the past, but this one

seemed simpler. Besides, I'd just about had it with paddles and electronic keyers. I tried single paddles, dual paddles, finger keying, dot memories, dash memories, iambic, etc. Even with the Accu-Keyer, I made too many mistakes.

So this would be the answer.

Let me point out that progress is very slow in my ham shack, and, so, the October, 1976, issue of *73 Magazine* arrived. Here was another article by WA9VGS describing a CMOS version of the Keycoder I. This one was still simpler; no power supply was needed—just a 9-volt battery. I was determined to build one!

By late 1978, I got around to it! I built not just one (with a few modifications, of course), but several more, for friends. Two other friends, AB9J and WB9ROU, also built them. We all think they are the greatest.

Since just about everyone is familiar with the

forementioned Accu-Keyer, a comparison is in order: The Accu-Keyer takes 7 ICs plus an ac power supply, miscellaneous parts, and a fairly expensive paddle; the CMOS Keycoder takes 7 ICs, miscellaneous parts, a 9-volt battery, and a keyboard. A new keyboard can be obtained for about the price of a paddle. But even surplus, used, or homemade keyboards will give excellent results. So, for less than the cost of an Accu-Keyer, you can have a code typer. Keyboards should become very popular for CW even for those who don't own computers.

Now, if I've convinced you to build a code typer, here are some ways to simplify the keyswitch wiring. Whether you build the

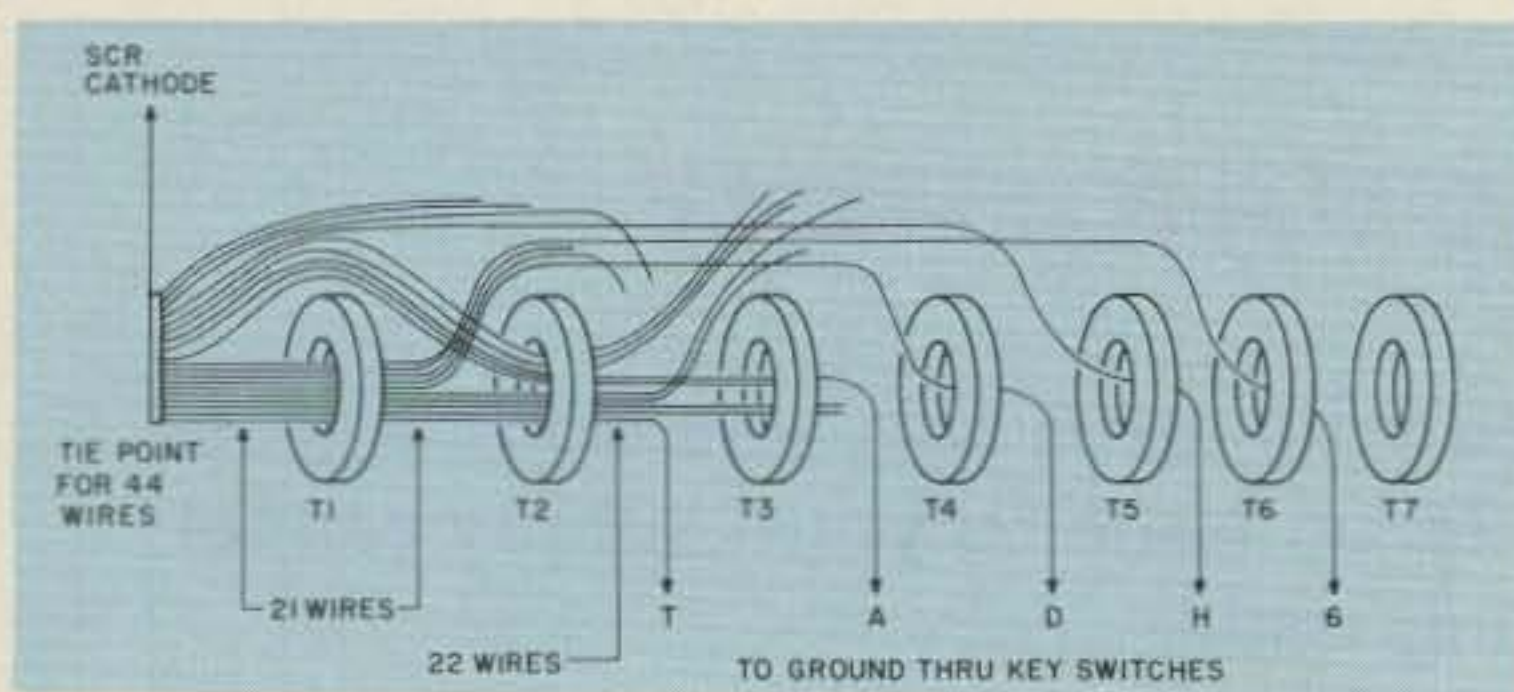

Fig. 1. Typical wiring. Note that only five characters are shown here, for simplicity.

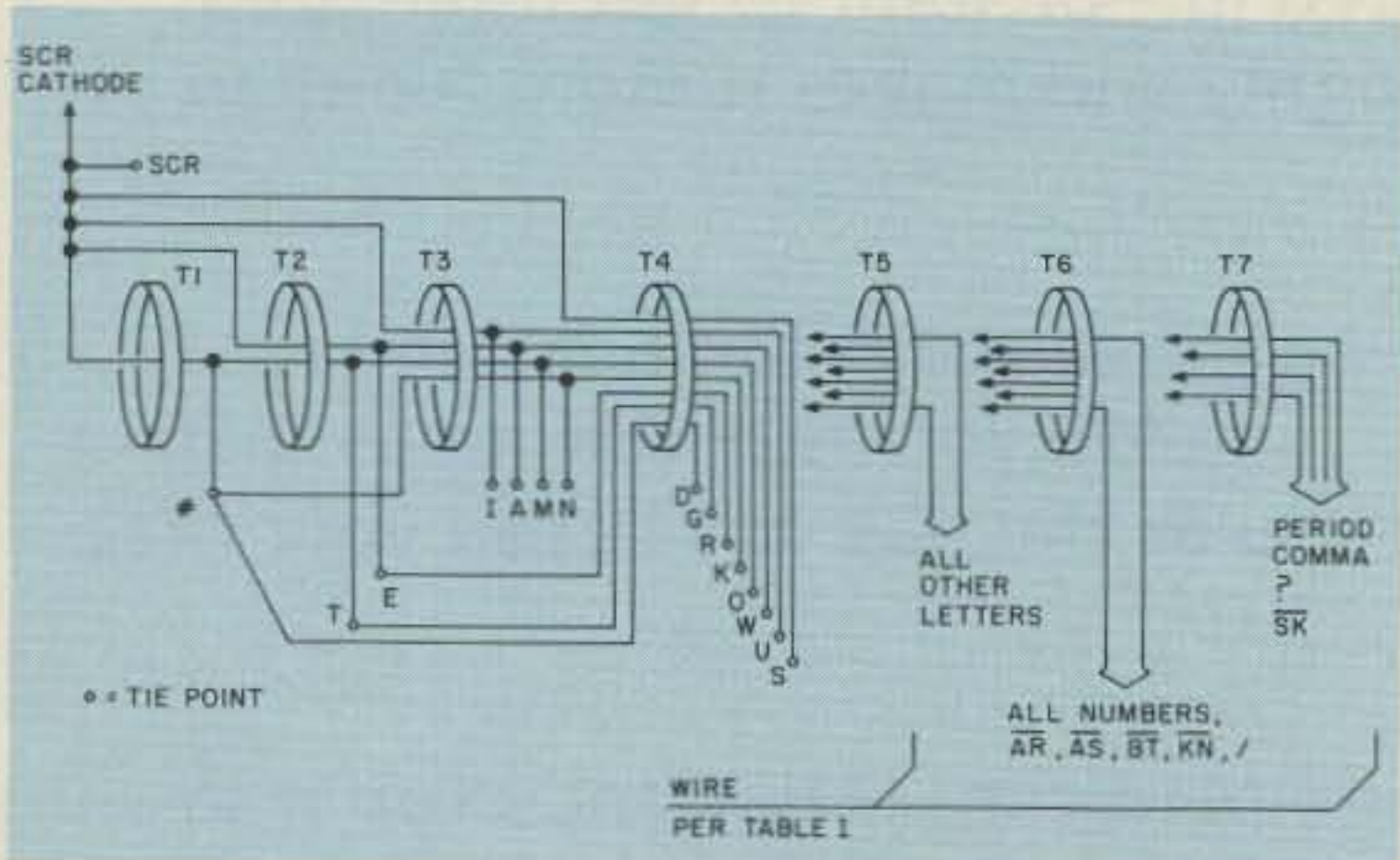

Fig. 2. Eliminate unnecessary duplicate wiring with tie points. Follow Table 1 to complete the wiring.

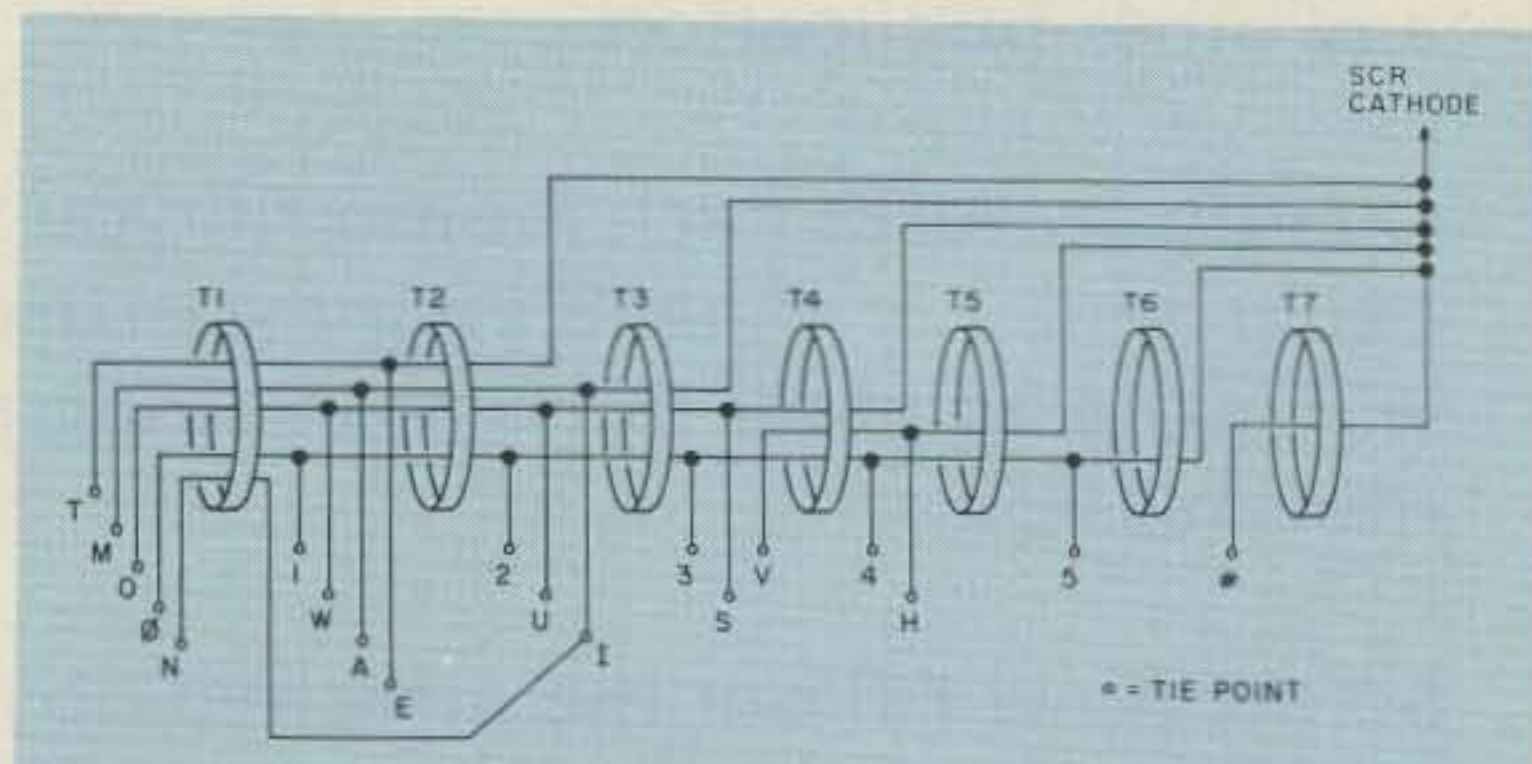

Fig. 3. Wiring for opposite polarity (SCR line at T7). Follow Table 2 to complete the wiring.



TTL or CMOS version, or any other using five to eight toroidal transformers, these principles can be applied.

First, to refresh your memory, keyboard encoding is done with the very simple but clever idea of passing wires through toroidal cores. This idea has been around so long I forget where it originated. Each core has a secondary winding of about ten turns which sets (or resets) an associated flip-flop when a wire passing through the core (the primary) is pulsed. A wire going outside the core has no effect.

### Phasing Is Important

The pulses produced on the secondaries must be the correct polarity for your circuit. Phasing (or polarity) of windings can be determined experimentally during construction. Some designs may have enough "ringing" in their secondary circuit that they will work either way. My circuit boards were built with T1 on the left and T7 on the right. My SCR line was brought out just to the left of T1. Each keyswitch wire was started at the SCR line and run toward T7, passing through and outside the proper cores to encode that particular letter, and then run directly to the corresponding keyswitch. This was not difficult with #30 magnet wire, but resulted in as many as 23 wires going through some cores.

### Simplification

By using tie-points for some or all of the characters, it is possible to reduce the number of wires considerably: one wire through T1, two wires through T2, four wires through T3, and eight wires through T4. If you put a connector between the circuit board and the keyboard, the connector terminals can be the tie-points. Looking at the original wiring table, or Fig. 1, it is seen

that about 21 wires pass through T1. These could all be tied together between T1 and T2 with no change in operation—so replace them with just one wire! The bundle of wires passing through T2 (about 22) can be broken into two groups: One group came through T1, and the other group came around T1 from the SCR tie-point. So, only two wires are needed passing through T2. By the same logic, only 4 need pass through T3; 8 through T4. By the time you get to T5, the saving is still 4 wires.

Fig. 2 shows the pre-wiring, using tie-points for 14 characters. Notice that tie-point "#" is not a character but just a tie-point designation. This pre-wiring can be done with plastic insulated wire. That means a lot less scraping of magnet wire. Table 1 lists the routing of the remaining wires. These may go to additional tie-points or directly to the corresponding keyswitches.

I would advise you to get your complete circuit board wired and operational before starting the keyswitch wiring. Keep power on the circuit and have a sidetone oscillator connected to the output. This allows you to check each wire before soldering to be sure it produces the correct character. It also will show up any mistakes in my list as well as printer errors (such confidence!), and it gives you the last check on correct phasing.

Now, if your phasing is reversed or you wish your SCR line to enter from the T7 end, Fig. 3 shows pre-wiring for 18 characters. Route the remaining wires according to Table 2.

My hope is that this article will encourage many of you to build code machines and that my wiring will make it just a little easier. ■

### Reference

1. Garrett, "The WB4VVF Accu-Keyer," *QST*, August, 1973.

Character	Through Cores:	To Tie-Point:
B	T5	#
C	T5	N
F	T5	I
H	T5	SCR
J	T5	W
L	T5	E
P	T5	A
Q	T5	G
V	T5	S
X	T5	D
Y	T5	K
Z	T5	T
1	T6, T5	W
2	T6, T5	U
3	T6, T5	S
4	T6, T5	SCR
5	T6	SCR
6	T6	#
7	T6	T
8	T6	M
9	T6,	O
0	T6, T5	O
AR	T6	R
AS	T6	E
KN	T6	K
BT	T6, T5	#
/	T6	D
PERIOD	T7, T6	R
COMMA	T7, T6, T5	T
?	T7	U
SK	T7, T6	S

Table 1. Wiring for Fig. 2 (SCR line at T1). Go from keyswitch or terminal through cores indicated from right to left.

Character	Through Cores:	To Tie-Point:
B	T1	H
C	T1, T3	H
D	T1	S
F	T3	H
G	T1, T2	S
J	T2, T3	V
K	T1	U
L	T2	H
P	T2, T3	H
Q	T1, T2	V
R	T2	S
X	T1	V
Y	T1, T3	V
Z	T1, T2	H
6	T1	5
7	T1, T2	5
8	T1, T2, T3	5
9	T1, T2, T3, T4	5
AR	T2, T4	5
AS	T2	5
BT	T1, T5	5
KN	T1, T3, T4	5
/	T1, T4	5
PERIOD	T2, T4, T6	#
COMMA	T1, T2, T5, T6	#
?	T3, T4	#
SK	T4, T6	#

Table 2. Wiring for Fig. 3 (SCR line at T7). Go from keyswitch or terminal through cores indicated from left to right.

\$5.95

# ARE YOU A BIG GUN CONTESTER?

The small number of elite operators at the top of the list when the results are published know what it takes to win a major contest . . . do you?

Now the winners reveal their secrets in THE CONTEST COOKBOOK by Bill Zachary N6OP. It contains detailed suggestions for the first-time contesteer as well as tips for the advanced operator.

Domestic, DX and specialty contests are all discussed . . . complete with photographs and diagrams showing the equipment and operating aids used by the top scorers.

Can you make 150 contacts . . . in one hour? Find out how in 73's latest publication, THE CONTEST COOKBOOK. Whether you take contests seriously or just enjoy a few hours of skilled operating, this 170-page book is sure to make your participation more pleasurable . . . and increase your score.

Winning a contest means more than having a kilowatt and beam—it takes a good operator with lots of determination. Don't settle for being a little gun . . . THE CONTEST COOKBOOK (BK7308) is available from the Radio Bookshop.

**MAIL THE COUPON  
BELOW OR FILL OUT THE  
POSTAGE PAID CARD AT  
THE BACK OF THIS ISSUE.  
ORDER TODAY!**

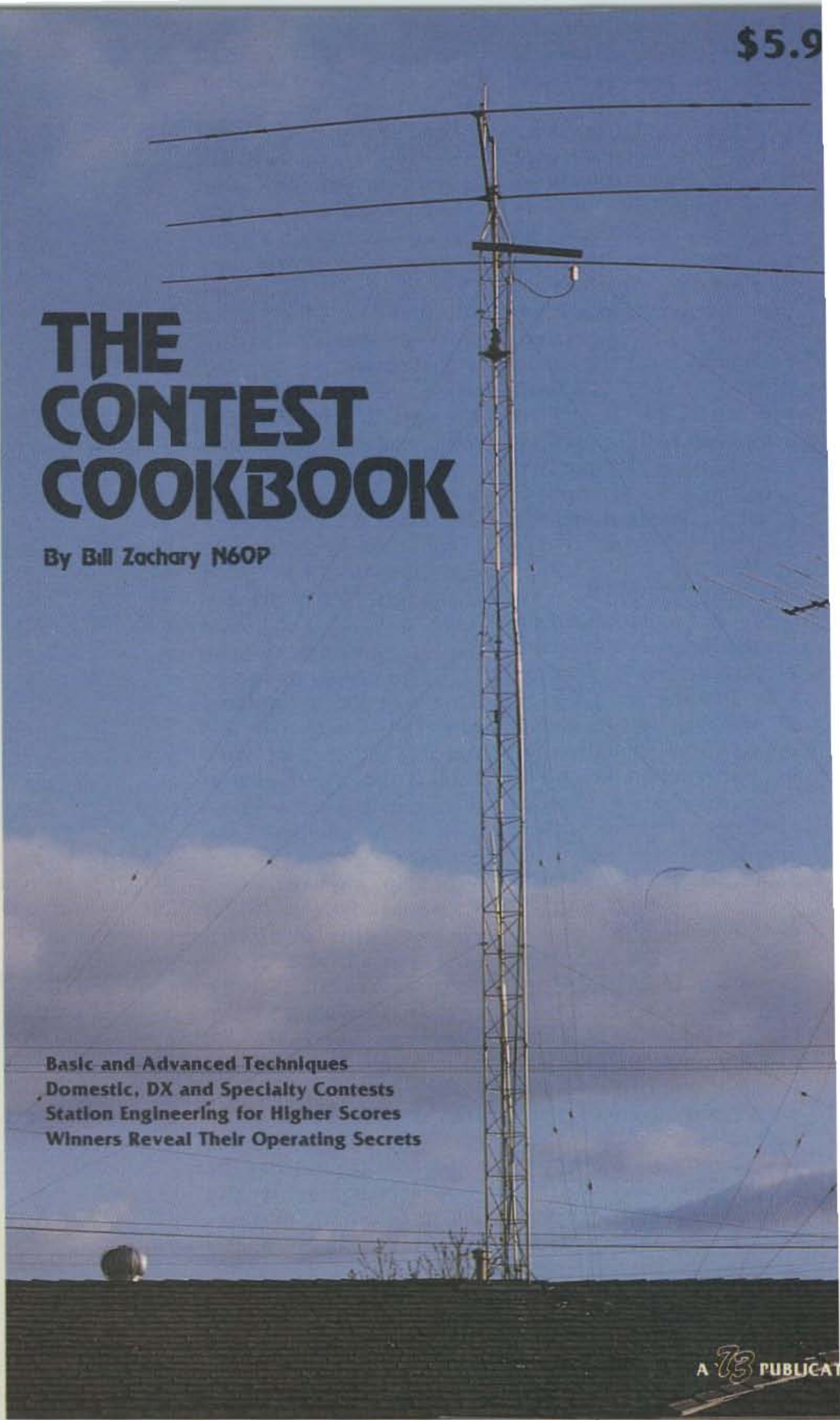

Basic and Advanced Techniques  
Domestic, DX and Specialty Contests  
Station Engineering for Higher Scores  
Winners Reveal Their Operating Secrets

- Yes! Please rush me \_\_\_\_\_ copies of THE CONTEST COOKBOOK (BK7308) at \$5.95 each.
- Bill me
- Visa     Mastercharge     American Express

Card # \_\_\_\_\_ Exp. date \_\_\_\_\_ Signature \_\_\_\_\_  
 Name \_\_\_\_\_  
 Street \_\_\_\_\_  
 City \_\_\_\_\_  
 State \_\_\_\_\_ Zip \_\_\_\_\_



## For some, only the best is good enough.

In every discipline there is one definitive statement of quality. In driving it's Rolls Royce, and in amateur radio it's Vibroplex. Vibroplex introduces the definitive statement for 2m FM Transceivers: The Vibroplex 225 SL. From now on, all others will be compared with its quality, performance, and sense of pride it will give its owners. Since 1890 Vibroplex has set the standard in its field, and Vibroplex owners have been perceived by their fraternity as the highest achievers and most skillful practitioners of their art. Frankly, the Vibroplex 225 SL is not for everyone. It is for those who wish to defy mediocrity; who wish to state that they appreciate owning only the best. We know you'll agree.

Like our world famous "bugs", our design concept was simple. First we built a unique transceiver with unmatched performance characteristics; then we added advanced digital circuitry to allow you to operate it to suit your own style. We think that amateurs who want to operate in style, with the best equipment, will have only one choice: the Vibroplex 225 SL.

In designing the ultimate 2m radio, we asked you, the customer what you wanted. Here is what you said: "... front end selectivity," "... a good receiver," "... eliminate intermodulation." And we listened. Never before has such a superior receiver been built. By using an advanced dual-gate MOSFET and a five-pole, high-Q torodial filter in an ad-

vanced circuit design intermodulation is a thing of the past. Our specs say we're the best and your field test will prove it. Add state-of-the-art 10 pole filters and you have IF adjacent channel selectivity of remarkable quality. We say we have the best transceiver on the market. When you test it, we know you'll agree. Next you said: "... make it flexible," "... easy to operate," "... good looking." Again we listened.

Designed for mobile or fixed use, this radio is microcomputer based to provide unequalled operating flexibility; sixteen completely flexible, programmable memory channels (no diodes); memory channel monitoring (lets you operate on one channel while monitoring another for a friend); any transmitter off-set (programmable from the front panel); two scanners—one to tune the band, the other to scan the memory channels; selectable pause/latch, pause defeat feature with programmable pause from .5 sec. to 10 sec. This feature takes all the effort out of making the next contact. Full 1 year Vibroplex warranty against defects. And good looking? Well, you tell us!

For a brochure on the most exciting radio this year, write us, or better yet, give us a call. But, if you are really serious, ACT NOW to be sure of receiving yours soon. The Vibroplex Company Inc., P.O. Box 7320, 476 Fore Street, Portland, Maine 04112, (207) 775-7710.



*"the oldest name in amateur radio"*  
Since 1890

✓ V24

# All About Ground Rods

## — getting connected to Mother Earth

**G**round rods are usually used in amateur installations for grounding purposes related to lightning protection. However, they are also the only choice one may have when using a short vertical antenna which requires a good ground. The use of buried radials is certainly preferable to establish a ground screen for a vertical antenna, but an elaborate radial system may require more space than is available, or it may be impossible to lay down such a screen because of obstacles. Usually, vertical antennas are used because of space restrictions. Hav-

ing the best ground for them, even if it is only a grounding rod, cannot help but improve their efficiency.

Whatever the application one may have for ground rods, it is useful to take a detailed look at how they work. The effectiveness of ground-rod usage can vary widely depending on how they are installed, and sometimes a few simple measures can vastly improve their performance.

### Basic Principles

One of the basic factors affecting ground rod performance is the nature of the soil in which it is

placed. The relative resistance of a ground connection using a ground rod can vary from 2 Ohms in a clay-type soil to over 2700 Ohms in a very sandy soil. As shown in Fig. 1, it is mainly the resistivity of the soil closest to the ground rod, however, that determines the overall effectiveness of the ground connection. Ninety percent of the total grounding effectiveness is determined by the soil characteristics within a radius of about 6 feet around the ground rod.

There is nothing one can do about the nature of the soil in a given location, of course, but a general awareness as to whether the soil has a high clay content, is a mixture of moist clay and sand (loam), or is

mostly sand and gravel, will act as a general guide for the elaborateness needed for an effective ground rod installation.

The moisture present in a given soil can have a marked effect on its resistivity. Fig. 2 gives an illustration of this for common red clay soil. Note how sharply the resistivity increases when the moisture content of the soil falls below 20%. Again, in reality, there is not much one can do to control this factor, but it is useful to be aware of it since, depending on seasonal rainfall conditions, the effectiveness of some ground connections using ground rods can vary widely.

Temperature is another factor influencing ground rod performance. Offhand,

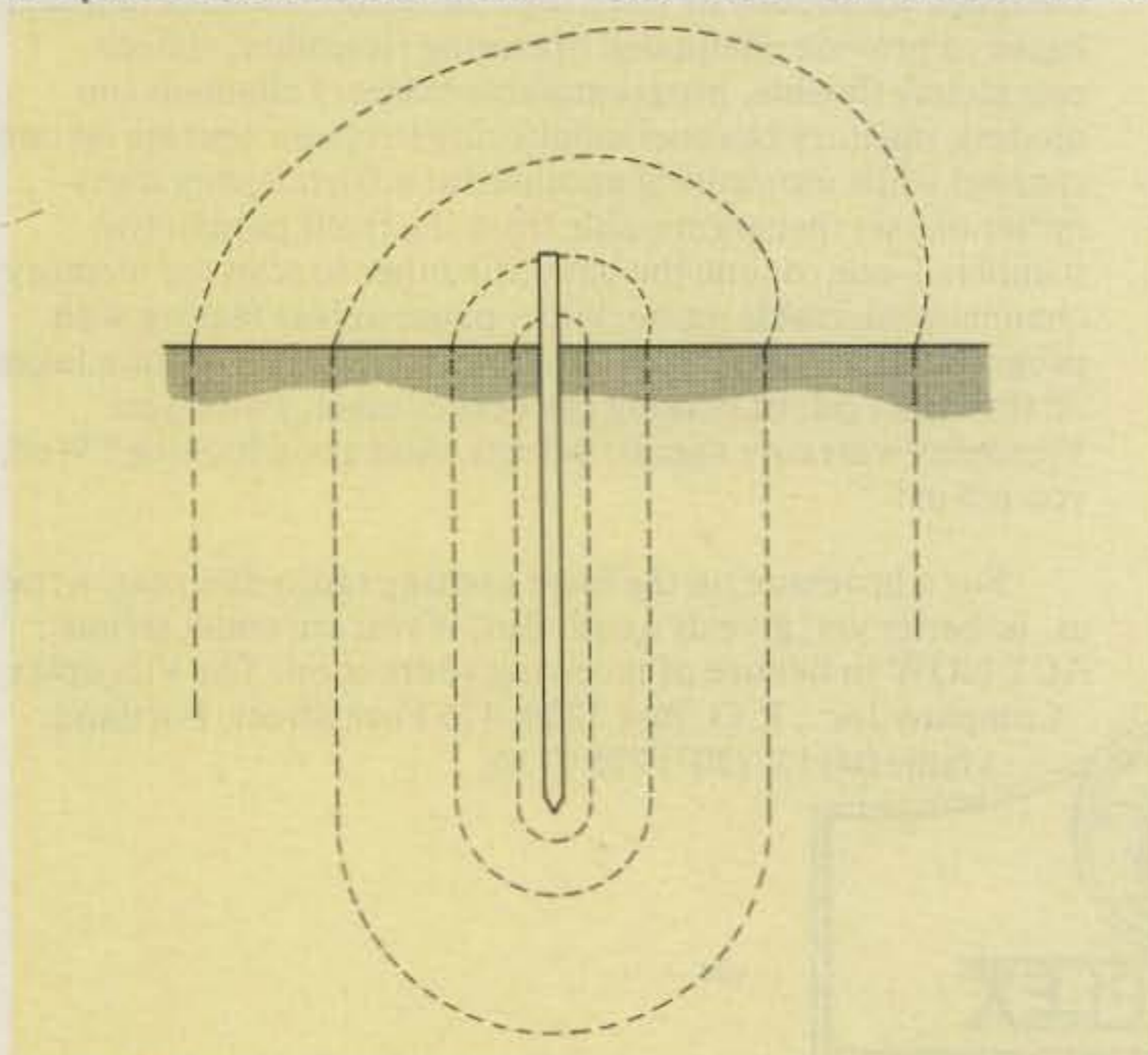

Fig. 1. One can visualize a ground rod as being surrounded by shells of soil. The shells nearest the rod mainly provide the rod's connection to the earth.

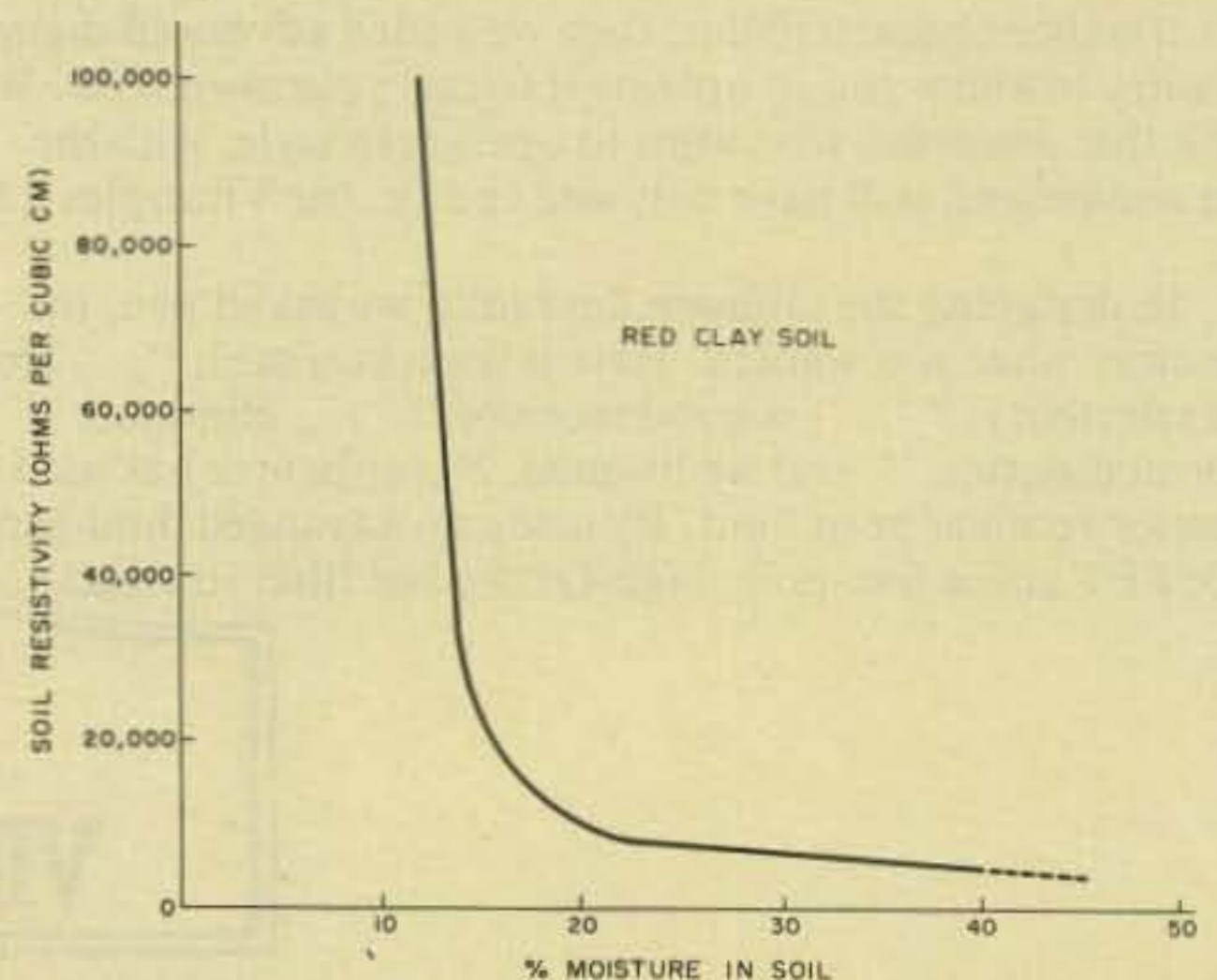
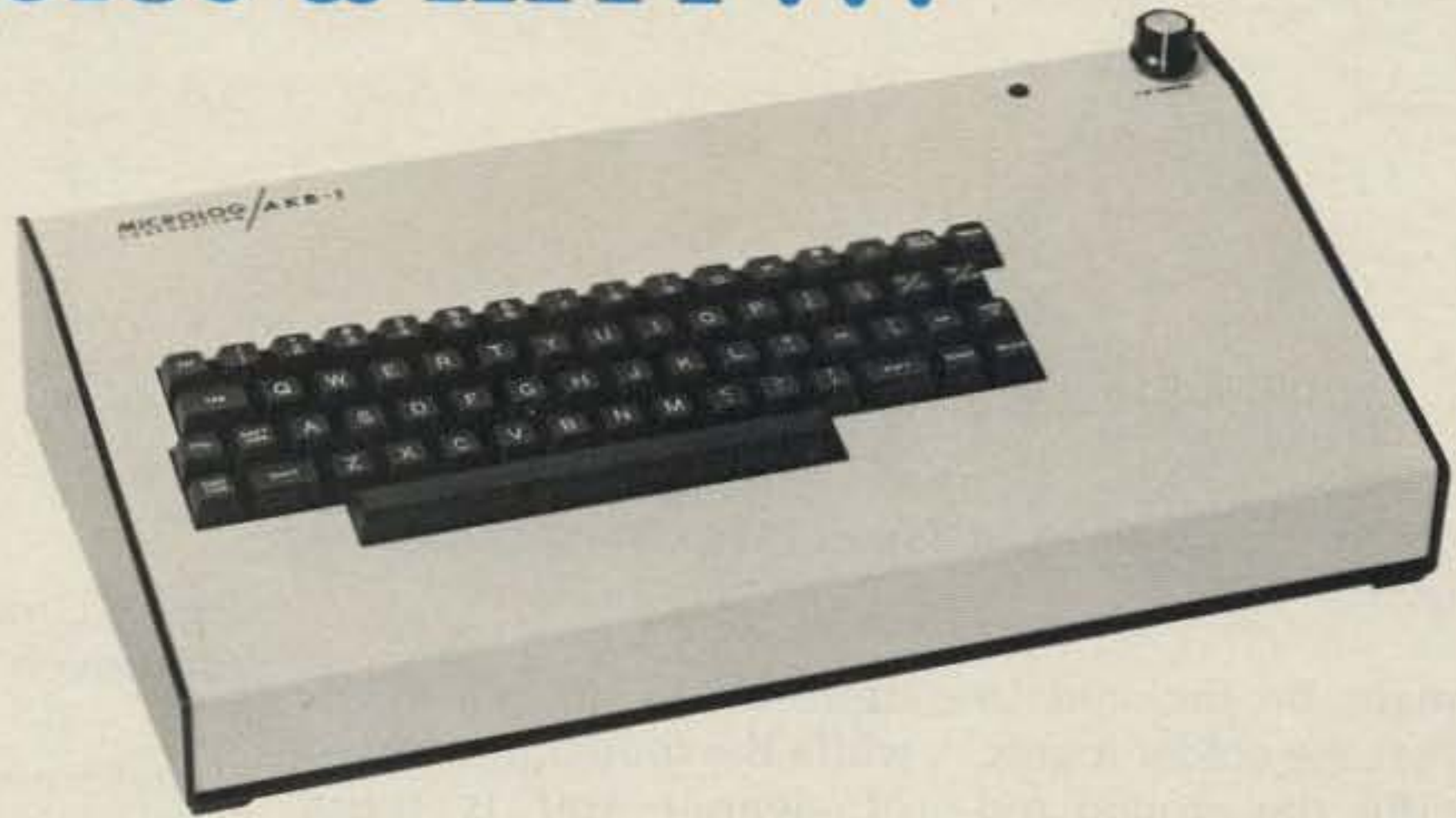

Fig. 2. The percentage of moisture in a soil can have a significant effect upon its resistivity.

# The MICROLOG Programmable Keyboard for Morse & RTTY ...

		= Quick Brown Fox
		= RYRY
		= RTTY Blank Fill (Diddle)
		= Special Message
		= Auto CW ID in RTTY
		= Word Mode
		= Speed Change
		= Random Code



		= Infinite Buffer Repeat		= Line Feed in RTTY	
		= Memory Message (1 of 10)		= Carriage Return in RTTY	
		= Call Letters Repeat Function			
		= Correction Key			

Auto CRLF, LTR, FIG in RTTY  
1950 Character Memory

## ... and the Story Behind It

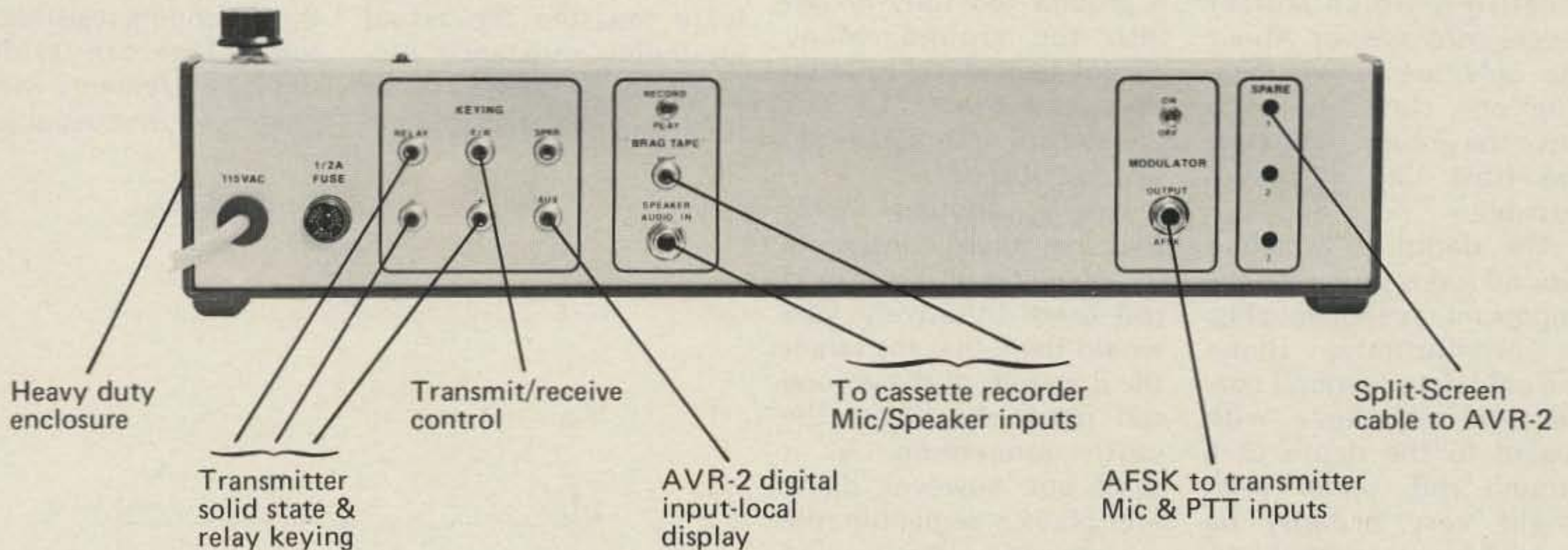

AKB-1 Programmable Keyboard From \$299

One year warranty on all products. Write for additional information.



**MICROLOG**  
CORPORATION

4 Professional Drive - Suite 119  
Gaithersburg, Maryland 20760  
Telephone (301) 948-5307

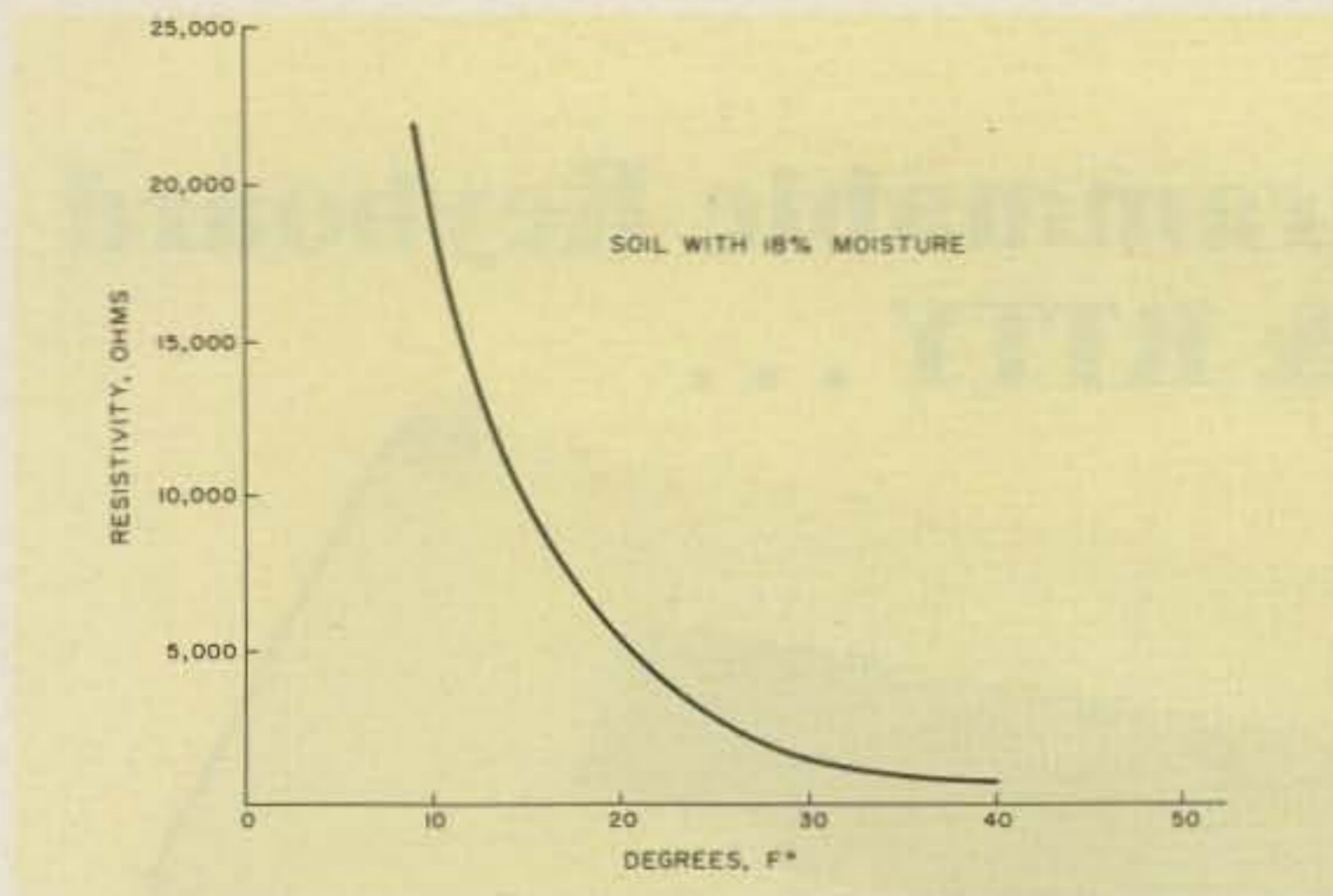

Fig. 3. Temperature also can have a sharp effect on soil resistivity.

one might be inclined to think that the colder it gets, the better the ground rod should perform, since we associate coldness with rain or snow. The opposite is true, however, when just cold temperatures are considered. When the earth freezes to any depth, the water in the soil freezes, moisture is lost, and the resistivity of the soil increases. Fig. 3 shows the sharp effect decreasing temperature can have on soil resistivity. So, again, seasonal weather changes regarding temperature can severely affect ground rod effectiveness in some localities which suffer severe cold seasons. About the only preventive measure one can take is to drive the ground rod below the frost line whenever possible.

The depth to which a ground rod is driven also is important, as shown in Fig. 4. This illustration shows the calculated ground connection resistance with regard to the depth of a ground rod, under what might very broadly be termed "average" soil conditions. The illustration assumes uniform moisture and soil resistivity at all depths. In reality, soil resistivity usually decreases with depth since the few feet near the surface are subject to alternate wetting and drying,

depending on rainfall, while the moisture content of deeper soil is more stable. For ground rods more than a few feet long, therefore, performance is usually better than that indicated by Fig. 4.

The greatest reduction in ground connection resistance is obtained by driving a ground rod to between 6 and 8 feet down. Although there may be particularly moist soil conditions in certain locations and at certain times of the year where a 3-foot rod is effective, this generally is not the case. Note also that the illustration is based on a ground rod fully driven into the ground. Many casual ground rod installations leave from 1/3 to 1/2 of the rod's length above the surface of the soil.

Finally, another factor that one might consider is the diameter of the ground rod used. Intuitively, one would think that the larger the diameter of the ground rod used, the better the earth connection. As it turns out, however, diameter plays a negligible role in improving the ground connection. This has been confirmed by various tests done by the former Bureau of Standards and the Underwriters Laboratories. Whether one uses a 1/2", 1", or even larger diameter rod can be based on mechanical strength factors,

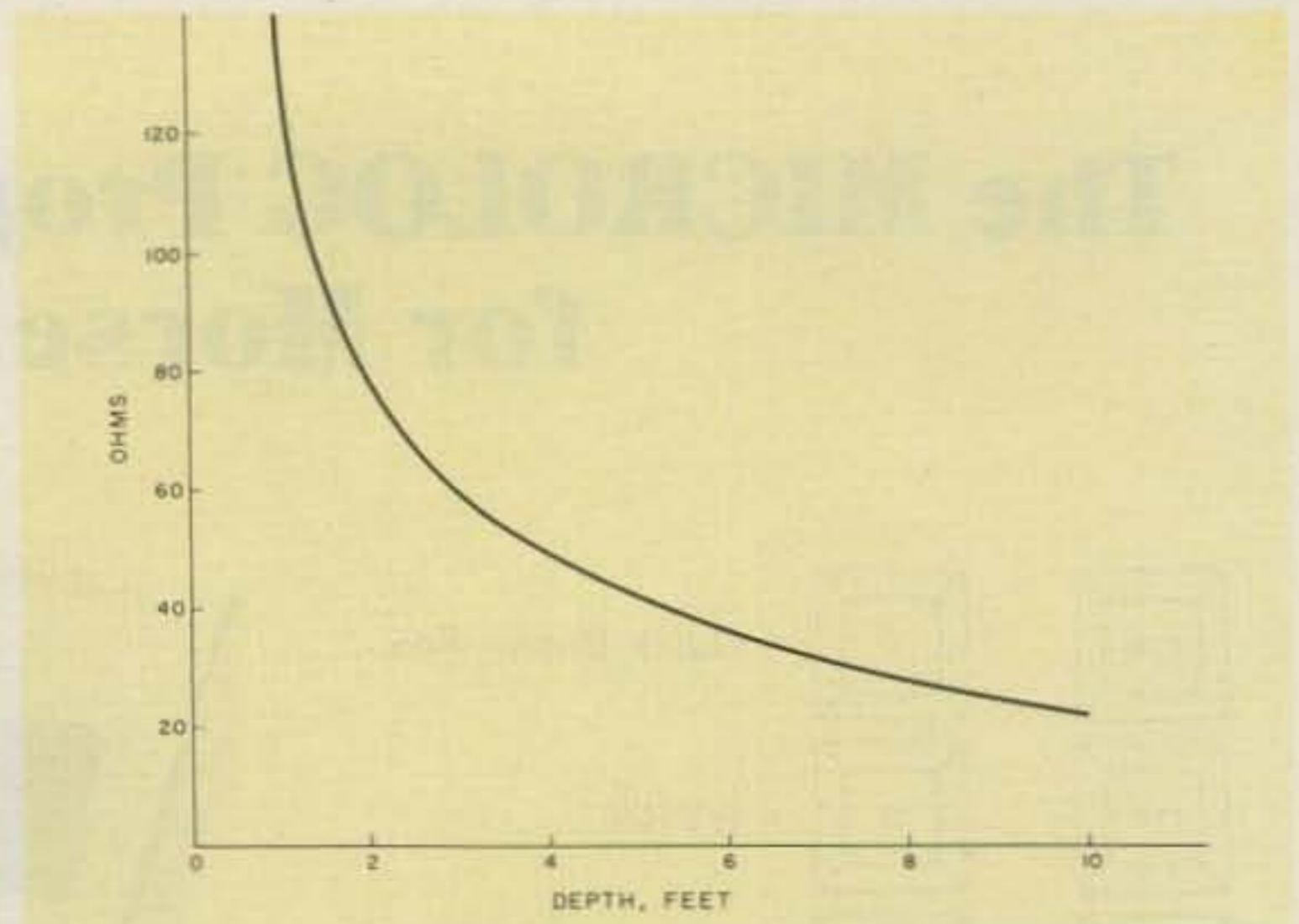

Fig. 4. Ground connection resistance for a single ground rod driven to different depths.

therefore—that is, a size large enough to be driven into a particular type of soil without bending.

The metal the rod is made out of is not important except for the factor of corrosion. Steel rods are commonly used, although if one can obtain Copper-weld grounding rods, they are ideal for the purpose. They have a steel core for strength and an exterior of copper for corrosion resistance.

### Measuring Grounding Resistance

It is not necessary usually to measure the actual grounding resistance provided by a ground rod as long as good practices are

used in installation of the rod. If one is curious about the approximate grounding resistance achieved, however, it can be measured fairly easily by the three-point method shown in Fig. 5. In this illustration, A represents the actual ground rod and B and C represent two temporary ground rods of two- to three-foot lengths. The temporary rods should be placed about 6 feet from the actual ground rod and from each other. The resistances between rods are measured and used in the formula shown to obtain the grounding resistance of rod A. One can try doing the measurements with an ohmmeter, but usually bet-

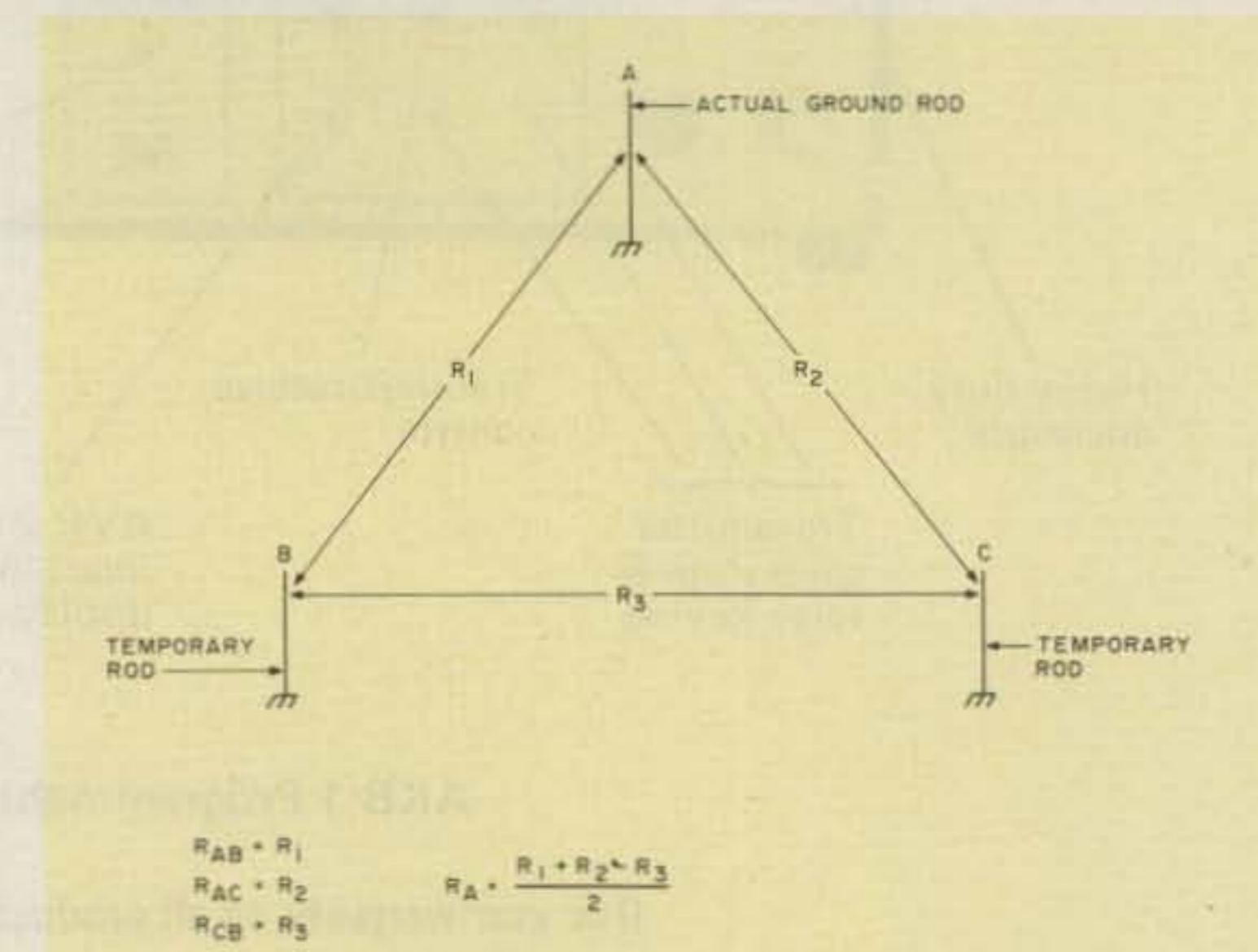

Fig. 5. By installing two temporary ground rods and taking some resistance readings, one actually can measure the ground connection resistance of a ground rod.

# New OMNI/SERIES B Filters The Crowd

The new OMNI/SERIES B makes today's bands seem less crowded. By offering a new i-f selection that provides up to 16 poles of filtering for superior selectivity. And a new Notch Filter to remove QRM. No other amateur transceiver we know of out-performs it.

**NEW I-F RESPONSE SELECTION.** OMNI comes equipped with an excellent 8-pole 2.4 kHz crystal ladder i-f filter which is highly satisfactory in normal conditions. But when the going gets rough, the new OMNI/SERIES B, with optional filters installed, provides two additional special purpose i-f responses.

The 1.8 kHz crystal ladder filter transforms an unreadable SSB signal in heavy QRM into one that gets the message through. The 0.5 kHz 8-pole filter provides extremely steep and deep skirts to the CW passband window which effectively blocks out even the very strong adjacent signals.

Both of these filters can be front-panel switched in series with the standard filter to provide up to 16 poles of filtering for near-ultimate selectivity. In addition, the standard CW active audio filters have three bandwidths (450, 300, and 150 Hz) to give even further attenuation to adjacent signals. In effect, OMNI/SERIES B has six selectivity curves—three for SSB and three for CW. That's true state-of-the-art selectivity.

**NEW NOTCH FILTER.** A variable frequency notch filter in OMNI/SERIES B is placed inside the AGC loop to eliminate interfering carriers and CW signals without affecting received signals. Attenuation is more than 8 "S" units (over 50 db) for any frequency between 0.2 kHz and 3.5 kHz.

**OMNI/SERIES B RETAINS ALL THE FEATURES THAT MADE IT FAMOUS.**

All solid-state; 160-10 meters plus convertible 10 MHz and AUX band positions; **Broadband design** for band changing without tuneup, without danger;

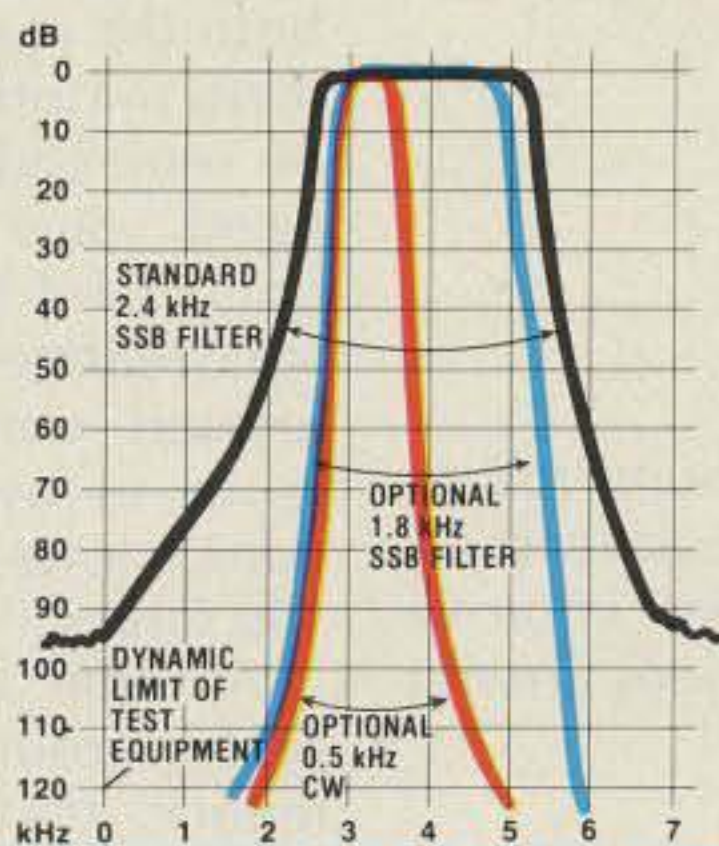

**OMNI/SERIES B I-F RESPONSES WITH STANDARD AND OPTIONAL FILTERS.**

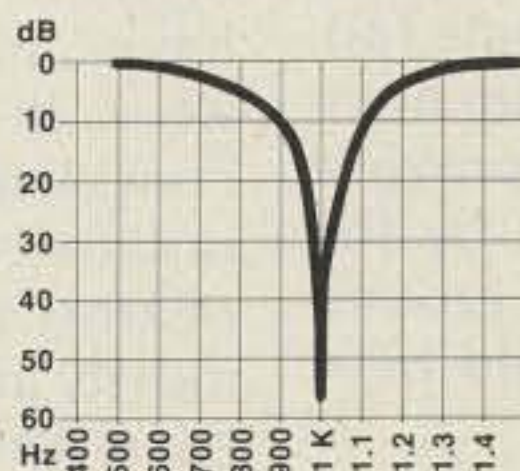

**NOTCH FILTER PERFORMANCE ADJUSTED TO 1 kHz POINT.**

**TEN-TEC, INC.**  
SEVIERVILLE, TENNESSEE 37862  
EXPORT: 5715 LINCOLN AVE., CHICAGO, ILL. 60646

**Choice of readouts** —OMNI-A for analog dial or OMNI-D for digital dial; **Built-in VOX and PTT** facilities; **Selectable Break-in**, instant or delayed receiver muting; **Dual-Range Receiver Offset Tuning**,  $\pm 5$  kHz or  $\pm 0.5$  kHz; **Wide Overload Capabilities**, dynamic range typically exceeds 90 dB and a PIN diode switched 18 dB attenuator is also included; **Phone Patch Interface Jacks**; **Adjustable ALC**; **Adjustable Sidetone**; **Exceptional Sensitivity**; **200 Watts** input to final with full warranty on final transistors for first year, pro-rata for 5 years; **100% Duty Cycle** for RTTY, SSTV or sustained hard usage; **12 VDC Circuitry** for mobile use, external supplies for 117/220 VAC operation; **Front Panel Microphone and Key Jacks**; **Built-in 25 kHz Calibrator** in analog dial model; **Zero-Beat Switch**; **"S"/SWR Meter**; **Dual Speakers**; **Plug-In Circuit Boards**; **Functional Styling**, black textured vinyl over aluminum "clamshell" case, complementary non-reflective warm dark metal front panel; **Complete Shielding**; **Easier-to-use size**: 5 $\frac{3}{4}$ "h x 14 $\frac{1}{4}$ "w x 14"d; **Full Options**: Model 645 Keyer \$85; Model 243 Remote VFO \$139; Model 252MO matching AC power supply \$139; Model 248 Noise Blanker \$49; Model 217 500 Hz 8-pole Crystal Ladder CW Filter \$55; Model 218 1.8 kHz 8-pole Crystal Ladder SSB Filter \$55;

**OMNI owners note:** Your OMNI can be converted to a SERIES B model at the factory for just \$50 (plus \$5 for packing and shipping). The notch filter replaces your present squelch control and provision is made for the two additional optional filters; a partial panel with new nomenclature is provided. Contact us for details.

**Model 545 Series B OMNI-A \$949**  
**Model 546 Series B OMNI-D \$1119**

Experience the uncrowded world of OMNI/SERIES B. See your TEN-TEC dealer or write for full details.



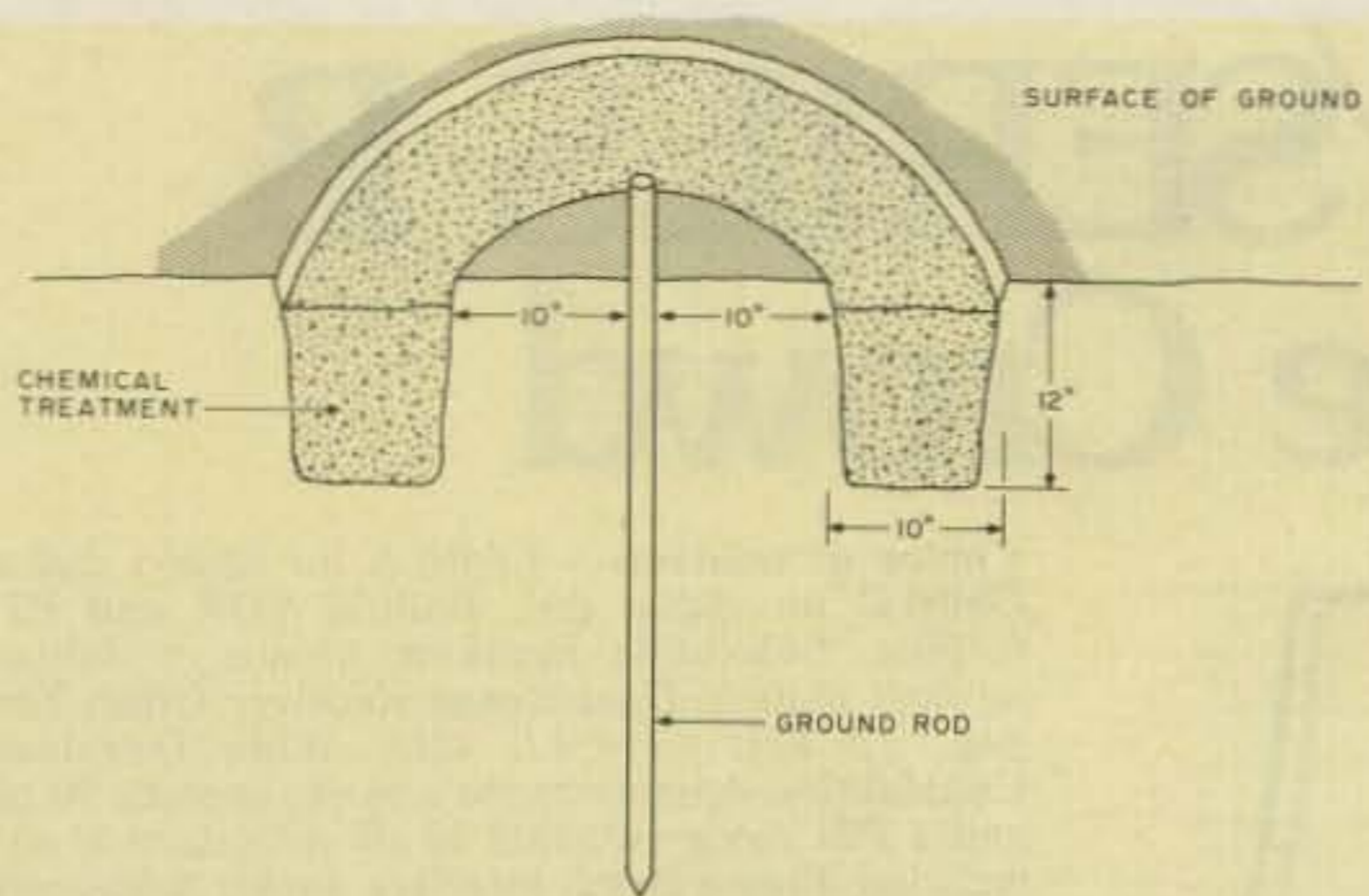

Fig. 6. Construction of a trench around a ground rod to hold a chemical treatment. The rod should be at least six feet into the ground, although the treatment will improve the performance of shorter rods also. Dimensions are not at all critical.

ter results are obtained if one goes the old-fashioned voltmeter/milliammeter route, using some low voltage ac or dc as a voltage source.

### Improving Ground Rod Performance

There are several methods one can use to improve ground rod performance if it is felt that a simple ground rod installation is inadequate. One of the simplest methods is to use multiple ground rods. If the rods are spaced 6 to 10 feet apart, they act very much like resistances in parallel. So, two rods will effectively cut the ground connection resistance in half, and so on. It is very important to maintain the spacing between the rods.

A few rods clustered closely together will be no more effective than a single rod. A practical maximum number of rods to improve a ground connection by the use of multiple ground rods probably would be 4 to 6.

The ground lead from each rod should be run directly to the base of the vertical antenna in the center of the ground rod array. There should also be one directly underneath the base of the antenna to act as a central ground rod. There might be some value also to running interconnecting wires between adjoining ground rods, but this is not as important.

Another fairly simple method to improve a single or multiple ground rod installation is to treat the area around the rod chemically, as shown in Fig. 6. This is not complicated to do since one does not have to dig a very deep trench around the rod. The treatment material can be magnesium sulphate, copper sulphate, or even ordinary rock salt. All are about equally effective; the only advantage of magnesium sulphate is that it is the least corrosive.

Note that the treatment material does not have to touch the ground rod—nor

should it. With the passage of time, the treatment material will seep towards the rod and corrode it, however, and rain will wash it away. The result of all this is that within a period of perhaps 2 to 3 years both the rod and the treatment material may have to be replaced. On the other hand, one accomplishes quite a bit by using chemical treatment. Typically, a ground connection resistance of over 1000 Ohms can be lowered to less than 100 Ohms.

Another method to improve ground rod performance that is useful in some cases is to drive the rod particularly deep. This method probably doesn't have much applicability when an antenna ground is considered, since it is soil resistivity and grounding nearer the surface that mostly affects antenna performance. Also, it is naturally hard to accomplish in many soils without specialized equipment. Nonetheless, in some soils, particularly sandy ones which start to have a clay base further down, it can be very effective from the viewpoint of lowering the ground connection resistance. For example, by using a 20-foot sectionized ground rod as compared to a 6-foot one, the resistance might be reduced by a factor of 6 or more.

### Installing Ground Rods

Any number of methods of installing ground rods have been devised, and this is pretty much an area where one's own ingenuity has to come into play. The sledgehammer approach will suffice in a great many cases. Another method which some amateurs have found successful with hollow tubing used as ground rods is to insert a garden hose in the tubing and let the water pressure wash away the soil slowly as the tubing is pushed into

the ground.

Another approach to consider, especially if one is going to drive several rods, is to construct a simple home-brew driving tool such as is shown in Fig. 7. This tool is made around a central weight mass of about 20 pounds. A short piece of tubing is affixed on one side and a longer piece of tubing on the other side. The tubing is chosen so that it is just large enough to slip over the ground rod. The length of the two sections will depend on the length of rod—three- and one-foot sections, for instance, are used for a 6-foot ground rod. In use, the long end of the tool is slipped over the ground rod and used initially to pound the rod into the ground. As the rod gets driven further in, the short side of the tool is slipped over the rod and used to complete pounding the rod into the ground. The advantage of this tool is that the tubing over the ground rod prevents the rod from bending, and the pounding force exerted by the tool is exactly in line with the axis of the ground rod.

### Ground Rod Connections

All the effort exerted in placing a ground rod can be wasted if a dependable low-resistance connection is not made to the rod. The ideal case would be to have all metals the same: a copper-plated rod using a copper clamp and copper wire. Such items and fittings can sometimes be purchased through electrical contractor supply houses. In most cases, however, one will be using dissimilar metals for the rod, clamp, and ground wire. In this case, one must be sure only that all connecting surfaces are clean and tight. Covering the clamp and rod junction with some weatherproofing compound also would be advisable. ■

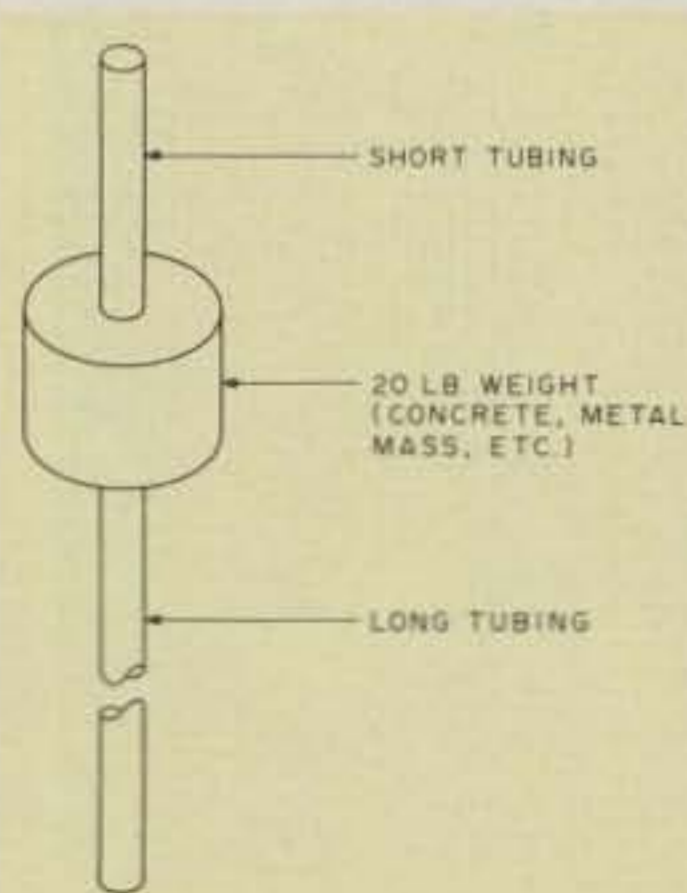

Fig. 7. A home-brew tool for driving ground rods. (See text.)



# DSI HAS DONE IT AGAIN QUIK-KIT II®

## WITH 10 MHz PROPORTIONAL OVEN TIME BASE

- DC-BATT-AC (W-AC9)
- 95% Factory Assembled
- External 10 MHz Input
- External 10 MHz Output
- 100% Factory Tested
- .2 PPM 10° to 40° C Accuracy Proportional Oven
- 9 Digits .5 Inch LED's
- 0.1 Hz Resolution to 50 MHz
- Auto Zero Blanking

**\$149<sup>95</sup>**

MODEL 5600A KIT



**WHY BUY A 5600A:** Because 95% of the assembly is completed by DSI and you are only one hour away from solving all those difficult bench problems, from setting the frequency of a audio signal to within 1/10 of a HZ, to checking the frequency of a 486 MHz mobile radio. Whether you are servicing a VTR, trouble shooting a PLL circuit, the 5600A is the right counter with accuracy that will meet any FCC land mobile, broadcast, or telecommunications requirements. On the bench or in the field the 5600A will do the job you need. The 5600A includes a self contained battery holder providing instant portability or we offer a 10 hour rechargeable battery pack option. Other options include a audio multiplier which allows you to resolve a 1/1000 of a HZ signal and finally a 25db preamplifier with an adjustable attenuator making the 5600A perfect for communications, TV servicing, industrial testing or meeting your QSO on the correct frequency every time.

**FACTS ARE FACTS:** With the introduction of the 5600A. The sun has set on the competition. This may sound like a bold statement on the part of DSI BUT FACTS ARE FACTS. No counter manufacturer except DSI offers a Full Range 50 HZ to 512 MHZ counter with — 9 Digits — 0.1 Hz resolution — .2 PPM 10° to 40° C proportional oven — RF pre-amp — 600 MHZ prescaler — three selectable gate times — oven ready, standby and gate time indicator lights as standard features — For only \$149.95 kit and \$179.95 factory wired. In fact the competition doesn't even come close unless you consider \$200.00 to \$800.00 close. With DSI having the best price to quality features ratio in the industry, no wonder we've become one of the world's largest manufacturers of high quality frequency counter instrumentation.

FOR INFORMATION — DEALER LOCATION — ORDERS — OEM  
CALL 800-854-2049 CALIFORNIA RESIDENTS CALL 800-542-6253

Model	Price	Frequency Range Typ	Accuracy Over Temperature	Sensitivity Typ			Number of Readouts	Power Requirements	Size		
				@ 100Hz-25MHz	@ 50-250MHz	@ 250-450MHz			H	W	D
5600A-K	\$149.95	50Hz-550MHz	Proportional Oven	5-10MV	5-10MV	5-50MV	9	*115 VAC or 8.2-14.5 VDC	3 1/4"	9 1/2"	9"
5600A-W	\$179.95		.2 PPM 10° - 40° C								
5500 Wired	99.95	50Hz-550MHz	TCXO	10-15MV	10-15MV	15-50MV	8	*115 VAC or 8.2-14.5 VDC	1 1/2"	5"	5 1/2"
500HH Wired	\$149.95	50Hz-550MHz	TCXO	25MV	20MV	75MV	8	*115 VAC or 8.2-14.5 VDC or NICAD PAK.	1"	3 1/2"	5 3/4"

5600A wired factory turned in 1 year limited warranty. 5600A kit 90 day limited warranty. Prices and/or specifications subject to change without notice or obligation.

\*With AC-9 Adaptor.

### 3550 OWNERS

You can add the 35P.2 .22 PPM 10° to 40° C proportional oven to your existing 3550

35P.2 ..... 29.95  
Factory Installed ..... 49.95



### DSI INSTRUMENTS, INC.

9550 Chesapeake Drive  
San Diego, California 92123  
(714) 565-8402

TERMS: MC - VISA - AE - Check - M.O. - COD in U.S. Funds. Please add 10% to a maximum of \$10.00 for shipping, handling and insurance. Orders outside of USA & Canada, please add \$20.00 additional to cover air shipment. California residents add 6% Sales Tax.

5600A Kit ..... \$149.95  
5600A Wired ..... 179.95  
AC-9 AC Adaptor ..... 7.95  
T600 BNC Ant. .... 7.95

### BUILT-IN OPTIONS

BA56 Rechargeable  
10 Hr. Bat. Pack ..... 29.95  
AM56 Audio Multiplier  
.001Hz Resolution ..... 34.95  
PA56 25dB Preamplifier  
with Attenuator ..... 59.95

# DSI GOES LCD

TRUE RMS - 3½ DIGITS - DMM - .1% BASIC ACCURACY

# 149<sup>95</sup>

## LC 5000

FACTORY WIRED

AVAILABLE  
JANUARY 1980

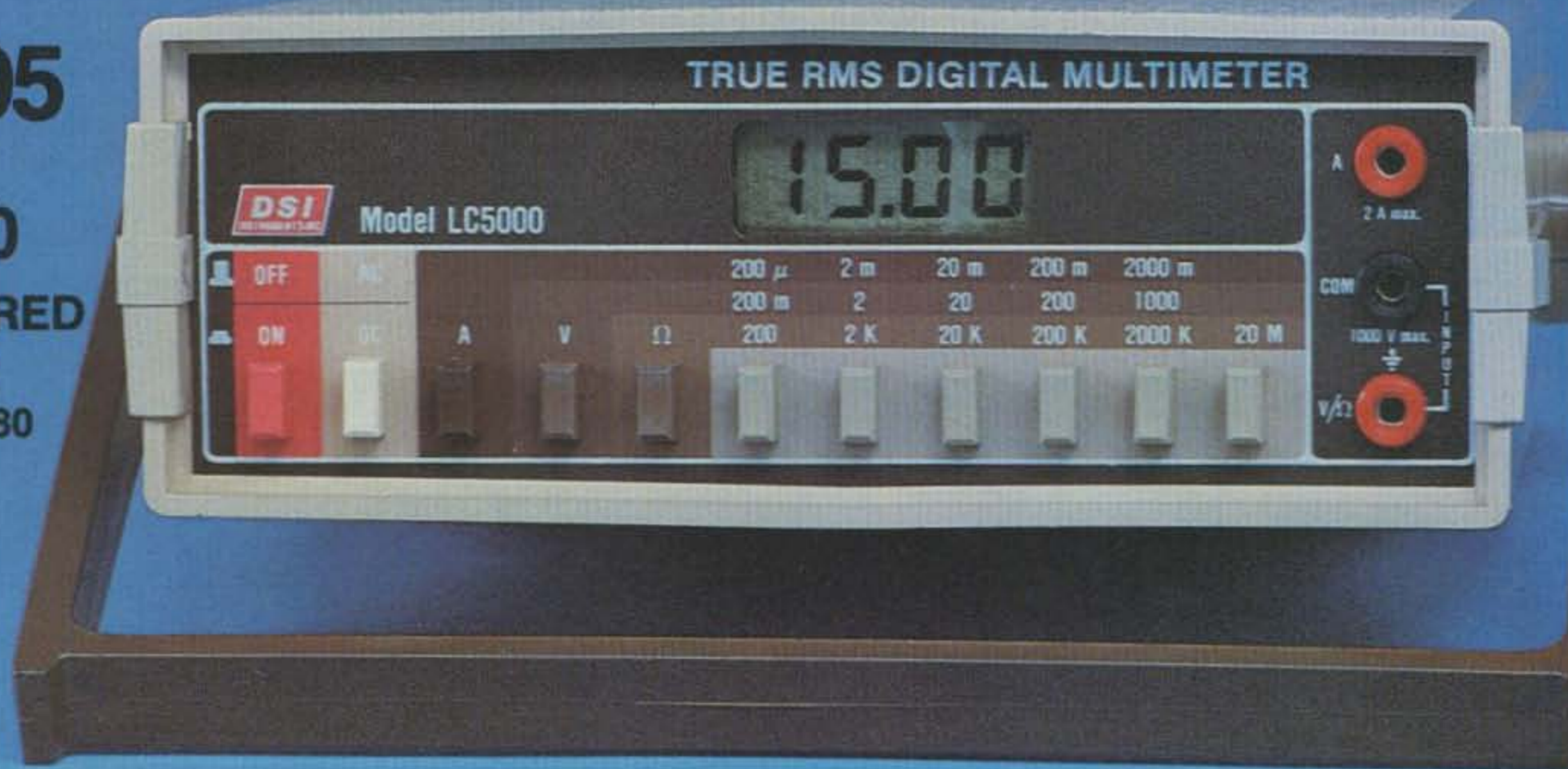

### RANGES

- AC TRUE RMS TO 1000V — 200mv, 2v, 20v, 200v, 1000v
- DC VOLTAGE TO 1000V — 200mv, 2v, 20v, 200v, 1000v
- DC CURRENT TO 2 Amps — 200μa, 2ma, 20ma, 200ma, 2A
- RESISTANCE TO 20 Megohms — 200, 2k, 20k, 200k, 2mg, 20mg

**AN UNPRECEDENTED DSI VALUE . . . .**  
in a high quality, LSI Design, .1% basic accuracy, 3½ digit DMM and because it's a DSI innovation, you know it obsoletes all competitive makes, both in price and performance.

No longer do you have to settle for small readouts, short battery life, a kit with a bag of parts, a black box with 20 Resistors that need adjustment every time you need to recalibrate, because you only budgeted \$100.00 or \$150.00 for a DMM.

The Model LC 5000 is factory assembled and tested in the USA. DSI has designed in Precision Laser Trimmed

Resistor Networks to provide maximum accuracy, resulting in long time periods between recalibration and a simple two adjustment calibration procedure. The LC 5000 incorporates a fused input circuit to help prevent damage to the DMM. The large .5 inch LCD Readouts are easy to read even in the brightest sunlight and allows for very low battery drain, normally only two battery changes a year is required. The LC 5000 is the perfect lab quality instrument on the bench or in the field — you can depend on DSI LC 5000 to meet all your needs. Buy Quality — Buy Performance — Buy Reliability — Buy DSI.

FOR INFORMATION — DEALER LOCATION — ORDERS — OEM  
CALL 800-854-2049 CALIFORNIA RESIDENTS CALL 800-542-6253

LC 5000 wired factory burned-in 1 year limited warranty. Prices and/or specifications subject to change without notice or obligation.  
TERMS: MC - VISA - AE - Check — M.O. - C.O.D. in U.S. Funds.  
Please add 10% to a maximum of \$10.00 for shipping, handling and insurance. Orders outside of USA & Canada, please add \$20.00 additional to cover air shipment. California residents add 6% Sales Tax.

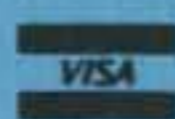

**DSI INSTRUMENTS, INC.**  
9550 Chesapeake Drive  
San Diego, California 92123  
(714) 565-8402

**Model LC 5000 . . . . \$149.95**  
**LCBA - Rechargeable**  
**Battery Pack Includes**  
**AC Battery Charger . \$24.95**

# DSI Super Meter

## Transistor Tester — VOM

Diode Protected • Fused • Gold Plated Selector Switch



- DC VOLTAGE
- DC CURRENT
- AC VOLTAGE
- $\Omega$  RESISTANCE
- AF OUTPUT — DB
- 20k $\Omega$  PER VOLT
- HFE DC AMP FACTOR
- ICEO LEAKAGE

**\$ 29<sup>95</sup>**  
MODEL YF-370

COMPARATIVE VALUE 49<sup>95</sup>

YF-370 ..... \$29.95  
Shipping, Handling and Ins. ... \$3.00

### SPECIFICATIONS

Measurement	Measurement Ranges	Accuracy
DCV	0 - .1V - .5V - 2.5V - 10V - 50V - 250V - 1000V	$\pm 3\%$ fs
ACV	0 - 10V - 50V - 250V - 1000V 30Hz to 30kHz	$\pm 4\%$ fs
DCA	0 - 50 $\mu$ A - 2.5ma - 25ma - .25A	$\pm 3\%$ fs
$\Omega$	.2 to 20m $\Omega$ Range x 1 x 10x 1k x 10k	$\pm 3\%$ arc
dB	+ 10db~+22db for 10VAC	$\pm 4\%$ fs
ICEO	0 - 150 $\mu$ A x 1k 0 - 15ma x10 0 - 150m x 1	$\pm 3\%$ arc
HFE	0 - 1000 @ x 10 $\frac{I_c}{I_B}$	$\pm 3\%$ arc

Every YF-370 is factory assembled, tested, and includes diode protected meter movement with a fused input and an extra fuse. The switch assembly has double wiping gold plated contacts to assure years of trouble-free service. At this low price buy two...one for the car and one for the shop.

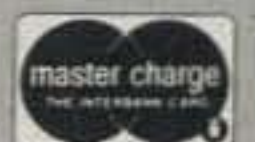

**CALL TODAY TOLL FREE: (800-854-2049) Calif. Res. CALL (800-542-6253) TO ORDER OR RECEIVE MORE INFORMATION ON DSI'S FULL PRODUCT LINE OF FREQUENCY COUNTERS RANGING FROM 10HZ TO 1.3GHZ.**

TERMS: MC — VISA — AE — Check — M.O. — COD in U.S. Funds. Orders outside of USA & Canada, please add \$5.00 additional to cover air shipment. California residents add 6% Sales Tax.

**DSI INSTRUMENTS, INC.**

9550 Chesapeake Drive San Diego, California 92123 (714) 565-8402

# NEW FROM DSI!

50 Hz — 500 MHz      8 DIGITS  
 1 Meg INPUT — 1 Hz RESOLUTION — 1 PPM TCXO

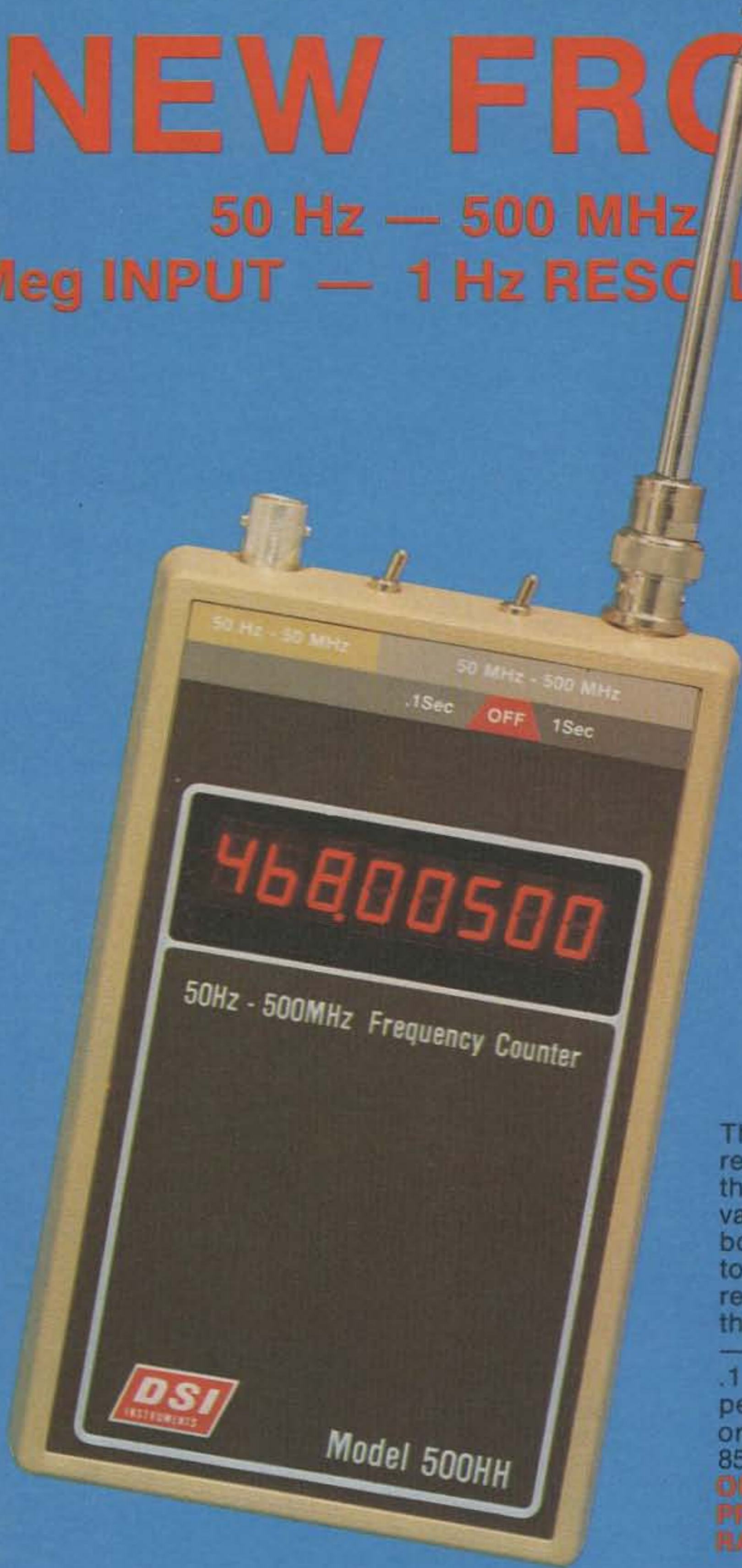

- AC—DC Operation
- BNC Inputs 1 Meg Direct 50 Ohms Prescaled
- 8 Large .4" LED Readouts
- Auto Decimal Point & Zero Blanking
- 1 Year Limited Warranty Parts & Labor
- 100% Factory Assembled in U.S.A.

## \$149<sup>95</sup>

MODEL 500 HH  
 50 Hz — 500 MHz  
 Without Battery Capability

MODEL 100 HH  
 50 Hz — 100 MHz

## \$99<sup>95</sup>

Without Battery Capability

### SAVE \$5<sup>00</sup>

With Battery Capability

MODEL 500 HH .. \$169.95

MODEL 100 HH .. \$119.95

Includes AC-9 Battery Eliminator

The 100 HH and 500 HH hand held frequency counter represent a significant new advancement, utilizing the latest LSI design . . . and because it's a DSI innovation, you know it obsoletes any competitive make both in price and performance. No longer do you have to sacrifice accuracy, ultra small readouts and portability resolution to get a calculator size instrument. Both the 100 HH and 500 HH have eight .4 inch LED digits — 1 Hz resolution — direct in only 1 sec. or 10 Hz in .1 sec. — 1 PPM TCXO time base. These counters are perfect for all applications be it mobile, hilltop, marine or bench work. **CALL TODAY TOLL FREE: (800-854-2049) Cal. Res. CALL (800-542-6253) TO ORDER OR RECEIVE MORE INFORMATION ON DSI'S FULL PRODUCT LINE OF FREQUENCY COUNTERS RANGING FROM 10 Hz TO 1.3 GHz.**

### FREQUENCY COUNTER CONSUMER DATA COMPARISON CHART

MANUFACTURER	MODEL	SUG'STD. LIST PRICE	FREQUENCY RANGE	TYPE OF TIME BASE	ACCURACY OVER TEMPERATURE		SENSITIVITY			DIGITS		PRE-SCALE INPUT RESOLUTION	
					17° - 40°C	0° - 40°C	100 Hz - 25 MHz	50 MHz - 250 MHz	250 MHz - 450 MHz	No.	SIZE IN INCHES	.1 SEC	1 SEC
DSI INSTRUMENTS	100 HH	\$ 99.95	50Hz-100MHz	TCXO	1 PPM	2 PPM	25 MV	NA	NA	8	.4	100 Hz	10 Hz
DSI INSTRUMENTS	500 HH	\$149.95	50Hz-550MHz	TCXO	1 PPM	2 PPM	25 MV	20 MV	30 MV	8	.4	100 Hz	10 Hz
CSC†	MAX-550	\$149.95	1kHz-550MHz	Non-Compensated	3 PPM @ 25°C	8 PPM	500 MV*	250 MV	250 MV	6	.1	NA	1 kHz
OPTOELECTRONICS	OPT-7000	\$139.95	10Hz-600MHz	TCXO	1.8 PPM	3.2 PPM	NS	NS	NS	7	.4	1 kHz	100 Hz

\* 1 KHz - 50 MHz † Continental Specialties Corp.

The specifications and prices included in the above chart are as published in manufacturer's literature and advertisements appearing in early 1979. DSI INSTRUMENTS only assumes responsibility for their own specifications.

100 HH... \$ 99.95    W/Battery Pack... \$119.95  
 500 HH... \$149.95    W/Battery Pack... \$169.95

Prices and/or specifications subject to change without notice or obligation.

These prices include factory installed rechargeable NiCad battery packs.

✓ D25



**DSI INSTRUMENTS, INC.**

9550 Chesapeake Drive  
 San Diego, California 92123  
 (714) 565-8402

T-500 Ant. .... \$ 7.95

AC-9 Battery Eliminator ..... \$ 7.95

TERMS: MC - VISA - AE - Check - M.O. - COD in U.S. Funds Please add 10% to a maximum of \$10.00 for shipping, handling and insurance. Orders outside of USA & Canada, please add \$20.00 addition to cover air shipment. California residents add 6% Sales Tax.

# OSCAR Orbits

Courtesy of AMSAT

The listed data tells you the time and place that OSCAR 7 and OSCAR 8 cross the equator in an ascending orbit for the first time each day. To calculate successive OSCAR 7 orbits, make a list of the first orbit number and the next twelve orbits for that day. List the time of the first orbit. Each successive orbit is 115 minutes later (two hours less five minutes). The chart gives the longitude of the day's first ascending (northbound) equatorial crossing. Add 29° for each succeeding orbit. When OSCAR is ascending on the other side of the world from you, it will descend over you. To find the equatorial descending longitude, subtract 166° from the ascending longitude. To find the time OSCAR 7 passes the North Pole, add 29 minutes to the time it passes the equator. You should be able to hear OSCAR 7 when it is within 45 degrees of you. The easiest way to determine if OSCAR is above the horizon (and thus within range) at your location is to take a globe and draw a circle with a radius of 2450 miles (4000 kilometers) from your QTH. If OSCAR passes above that circle, you should be able to hear it. If it passes right overhead, you should hear it for about 24 minutes total. OSCAR 7 will pass an imaginary line drawn from San Francisco to Norfolk about 12 minutes after passing the equator. Add about a minute for each 200 miles that you live north of this line. If OSCAR passes 15° east or west of you, add another minute; at 30°, three minutes; at 45°, ten minutes. Mode A: 145.85-.95 MHz uplink, 29.4-29.5 MHz downlink, beacon at 29.502 MHz. Mode B: 432.125-.175 MHz uplink, 145.975-.925 MHz downlink, beacon at 145.972 MHz.

OSCAR 8 calculations are similar to those for OSCAR 7, with some important exceptions. Instead of making 13 orbits each day, OSCAR 8 makes 14 orbits during each 24-hour period. The orbital period of OSCAR 8 is therefore somewhat shorter: 103 minutes.

To calculate successive OSCAR 8 orbits, make a list of the first orbit number (from the OSCAR 8 chart) and the next thirteen orbits for that day. List the time of the first orbit. Each successive orbit is then 103 minutes later. The chart gives the longitude of the day's first ascending equatorial crossing. Add 26° for each succeeding orbit. To find the time OSCAR 8 passes the North Pole, add 26 minutes to the time it crosses the equator. OSCAR 8 will cross the imaginary San Francisco-to-Norfolk line about 11 minutes after crossing the equator. Mode A: 145.85-.95 MHz uplink, 29.4-29.50 MHz downlink, beacon at 29.40 MHz. Mode J: 145.90-146.00 MHz uplink, 435.20-435.10 MHz downlink, beacon on 435.090 MHz.

OSCAR 7 Orbital Information				OSCAR 8 Orbital Information			
Orbit	Date (Dec)	Time (GMT)	Longitude of Eq. Crossing °W	Orbit	Date (Dec)	Time (GMT)	Longitude of Eq. Crossing °W
23068	1	0050:49	79.5	8862Jbn	1	0008:41	49.7
23081	2	0145:06	93.1	8876Jbn	2	0013:49	51.0
23093qrp	3	0044:26	78.0	8890Abn	3	0018:58	52.3
23106	4	0138:43	91.5	8904Abn	4	0024:06	53.6
23118X	5	0038:04	76.4	8918X	5	0029:14	54.9
23131	6	0132:20	90.0	8932Abn	6	0034:23	56.2
23143	7	0031:41	74.8	8946Abn	7	0039:31	57.5
23156	8	0125:58	88.4	8960Jbn	8	0044:39	58.8
23168	9	0025:18	73.3	8974Jbn	9	0049:48	60.1
23181qrp	10	0119:35	86.9	8988Abn	10	0054:56	61.4
23193	11	0018:55	71.7	9002Abn	11	0100:04	62.7
23206X	12	0113:12	85.3	9016X	12	0105:12	64.0
23218	13	0012:32	70.2	9030Abn	13	0110:21	65.3
23231	14	0106:49	83.8	9044Abn	14	0115:29	66.6
23243	15	0006:09	68.6	9058Jbn	15	0120:37	67.9
23256	16	0100:26	82.2	9072Jbn	16	0125:45	69.2
23269qrp	17	0154:43	95.8	9086Abn	17	0130:53	70.5
23281	18	0054:03	80.7	9100Abn	18	0136:02	71.8
23294X	19	0148:20	94.2	9114X	19	0141:10	73.1
23306	20	0047:40	79.1	9127Abn	20	0003:04	48.6
23319	21	0141:57	92.7	9141Abn	21	0008:13	49.9
23331	22	0041:18	77.5	9155Jbn	22	0013:21	51.2
23344	23	0135:35	91.1	9169Jbn	23	0018:29	52.5
23356qrp	24	0034:55	76.0	9183Abn	24	0023:37	53.8
23369	25	0129:12	89.6	9197Abn	25	0028:45	55.1
23381X	26	0028:32	74.4	9211X	26	0033:53	56.4
23394	27	0122:49	88.0	9225Abn	27	0039:01	57.7
23406	28	0022:09	72.9	9239Abn	28	0044:09	59.0
23419	29	0116:26	86.5	9253Jbn	29	0049:17	60.3
23431	30	0015:46	71.3	9267Jbn	30	0054:25	61.6
23444qrp	31	0110:03	84.9	9281Abn	31	0059:33	62.9

## FCC

Reprinted from the Federal Register.

### Amateur Radio Service; Modifying Procedures for Notifying the Commission of Name and Mailing Address Changes; and To Give a 5-Year License Term to All Licenses Issued

**AGENCY:** Federal Communications Commission.

**ACTION:** order.

**SUMMARY:** The Commission amended §§ 97.13 and 97.47 to delete provisions which allowed Amateur licensees to notify the Commission of name and mailing address changes by letter. All future Amateur license modifications must be requested by filing the appropriate application form. The Commission also amended § 97.59 to provide that all Amateur licenses will be given a five-year term.

**DATES:** The effective date of the Order is November 12, 1979.

**ADDRESSES:** Federal Communications Commission, Washington, D.C. 20554.

**FOR FURTHER INFORMATION CONTACT:** Maurice J. DePont, Private Radio Bureau, (202) 254-6884.

#### SUPPLEMENTARY INFORMATION:

##### Order

Adopted: September 27, 1979.  
Released: October 5, 1979.

By the Commission: Commissioner Lee absent.

In matter of amendment of §§ 97.13, 97.47 and 97.59 of the Commission's rules.

1. Sections 97.13 and 97.47 of the Commission's rules set forth the procedures to be followed by amateur licensees who wish to renew or modify their amateur radio license. In each instance, the request must be made by submitting an FCC Form 610 (or 610-B in the case of a club or military recreation station) to the Commission's office in Gettysburg, Pennsylvania. However,

these rule sections also provide that a change in the licensee's name or mailing address may be accomplished by notifying the Commission by letter.

2. The provision concerning notification by letter has apparently led to confusion on the part of many amateur licensees and has unnecessarily increased the workload of the Commission's application processing staff. Most letter requests for address change fail to specify that it is only the licensee's mailing address which has changes. Therefore, the staff is required to ascertain whether or not the station location has also changed. In the majority of cases, the station location has indeed changed. In such a situation, § 97.47 requires a formal modification of the license. Therefore, it is necessary that the licensee file an application.

3. In order to eliminate the confusion among amateur licensees as to when an application need be filed, and to lessen the burden on the processing staff, the Commission is amending §§ 97.13 and 97.47 to delete the provisions concerning letter notice. Henceforth, all amateur license modifications must be requested by submission of the appropriate application form.

4. The Commission is also amending § 97.59 to provide that modified licenses will be issued for a five-year term commencing on the date of the modification. Currently, that section provides that modified licenses shall bear the same expiration date as the license being modified.

5. Since the amendments herein ordered are procedural in nature, they are excepted by Section 553(b) of the Administrative Procedure Act from the requirement of prior public notice and comment.

6. Accordingly, it is ordered, effective November 12, 1979, that Part 97 of the Commission's rules is amended as shown in the Appendix attached hereto.

Authority for this action is found in Sections 4(i) and 303 of the Communications Act of 1934, as amended.

7. For further information on these rule changes, contact Maurice J. DePont, 254-6884.

(Secs. 4, 303, 48 stat., as amended, 1066, 1082 (47 U.S.C. 154, 303))

Federal Communications Commission.

William J. Tricarico,

Secretary.

#### Appendix

Part 97 of Chapter I of Title 47 of the Code of Federal Regulations is amended as follows:

##### § 97.13 [Amended]

1. In § 97.13, paragraph (e) is deleted.

##### § 97.47 [Amended]

2. In § 97.47, paragraph (c) is deleted.

3. Section 97.59 is amended to read as follows:

##### § 97.59 License term.

(a) Amateur operator licenses are normally valid for a period of five years from the date of issuance of a new, modified or renewed license.

(b) Amateur station licenses are normally valid for a period of five years from the date of issuance of a new, modified or renewed license. All amateur station licenses, regardless of when issued, will expire on the same date as the licensee's amateur operator license.

(c) A duplicate license shall bear the same expiration date as the license for which it is a duplicate.

## Ham Help

I would like to meet other amateurs who are avid bridge players. Perhaps we could form a net and discuss bridge hands, conventions, tournaments, and the possibilities for bridge-playing computer programs over the air. I am an experienced tournament player, but would be happy to talk to anyone interested.

**Mike Marmer KB8GH**  
2749 Symphony Way  
Dayton OH 45449

I'm a disabled amateur and could really use some help with the following:

1. I need someone to use my acetate film and their transfers, lines, etc., to make negatives

from which I can expose sensitized PC boards myself. Any layout from my specs would be acceptable; their name, call, or whatever can go on the board.

2. I also need manuals for the BC-1306, RT-70, and VRC-19. I especially need a "Surplus Schematic Handbook" to copy. It is black with red letters and a white schematic on the front.

3. I am looking for a Knight-kit signal tracer (circa 1960) with an rf-af probe.

4. I also need someone to construct projects, at cost or a little over, from my diagrams and their/my parts.

**John C. White WB6BLV**  
560 N. Indiana St.  
Porterville CA 93257

# 1979 Index

## AMPLIFIERS

70-Watt Shoes for the IC-502.....	WA1PDY	128	Sep
Amplify Your 6-Meter Fun.....	N4QH	80	Nov

## ANTENNAS

A Remotely-Tuned Matchbox.....	W4PSJ	38	Jan
How To Bury Coax.....	W4MEA	40	Feb
Mobile Antenna Ingenuity.....	WA8ATE	42	Feb
The NCX-Match.....	WA6NCX/1	32	Mar
Brew Up a Beam for Two.....	VE3BSM	88	Mar
What About an Active Antenna?.....	W5JJ	44	Apr
Try a Bi-Loop Antenna.....	W7CJB	58	Apr
Antenna Bonanza for 10.....	W6LVT	102	Apr
An 8-Element, All-Driven Vertical Beam.....	W1DBM	132	Apr
A Visit to Antenna Specialists.....	W2NSD/1	30	Jul
Secrets of Guyed Towers.....	WB3BQO	34	Jul
Feed-Horn Mounting Made Easy.....	WB8DQT	44	Jul
Shortened Antennas for 75 and 80.....	W4AEO	58	Jul
Build This Simple 220 Yagi.....	N8AJA	66	Jul
GIANT Wire Antennas.....	WD8CBJ	72	Jul
The 9-Element Duoband DX Attention-Getter.....	K4FK, N4DG	92	Jul
Here's a "Twist".....	K4TWJ	96	Jul
A Fortified 2m Whip.....	W9AMM	98	Jul
Ageless Wonder: the Collinear Beam.....	W1FK	100	Jul
So You Want to Raise a Tower.....	WA7DPX	104	Jul
The Revolutionary Organic Antenna.....	Gaddie	118	Jul
DDRR Dipole for VHF.....	W6VX	126	Jul
Compact Beams for 20 or 15.....	W8HXR	144	Jul
"Weeping Willow" Vertical for 40.....	WA6OYS	150	Jul
Try the Potted J.....	Staff	106	Aug
The Tri-Polarized VHC Antenna.....	K8UR	116	Aug
The 80 Meter Coax L.....	AA4AG/DA1KV	126	Aug
Four Bands on a Bamboo Pole.....	W0VM	60	Sep
Digital Readout Rotator Control.....	K8TMK	72	Sep
The Big Bopper.....	W0VDJ	136	Sep
Center Insulator for your Next Antenna.....	AC5P	52	Oct
The Miserly Mobile PVC Special.....	AA4RH	112	Oct
The Black Art of Antenna Design.....	Reynolds	40	Nov
Building Long Yagis for UHF.....	W8DMR	56	Nov
Sloppiness Will Get You Nowhere.....	WA5TDT	116	Nov
The Small But Mighty Arboreal Aerial.....	K5JRN	148	Nov
What Do You Do When Your Rotator Dies?.....	W5JJ	149	Nov
The Chicken Delight Beam.....	K8SD	158	Nov
The W4HCY Antenna System.....	W4HCY	178	Nov
A 3-Band Mast-Mountable Miniquad.....	WA6UHU	182	Nov
Bargains in Remote Antenna Switches.....	W5JJ	185	Nov
The Space-Saving Square Vee Antenna.....	W7DJB/6	80	Dec

## CB

CB to 10—part XVI: a CW conversion.....	W4GBB	56	Jan
CB to 10—part XVII: SBE and Pace rigs.....	K3SZN	156	Jan
CB to 10—part XVIII: several PLL rigs.....	K9PS	30	May
CB to 10—part XIX: Lafayette SSB rigs.....	WB0LLP/5	60	Jun
CB to 10—part XX: converting the Royce I 655.....	N8AMR	72	Nov
CB to 10—part XXI: the Johnson Viking 352.....	WA6OYS	82	Nov
External Relay Control for Converted CBs.....	W5JJ	140	Nov

## CLOCKS

A Digital Clock with Analog Readout.....	W9IEA	138	Dec
--	-------	-----	-----

## COMMERCIAL GEAR

Happiness is a WE-800.....	K3JML	28	Jan
The Vacationer.....	WA2ALT	29	Feb
"I Love My Ten-Tec!".....	WA0JIH	120	Feb
RAM Scan Your KDK.....	WB2JHN	26	Mar

The Memorizer Goes to MARS.....	KH6JMU	38	Mar
10¢ Mod for the 22S.....	K5XT, WB5SXT	56	Mar
A Better Micoder™.....	KG6JIF	116	Mar
An Intelligent Scanner for the HW-2036.....	WA9TAH	150	Mar
PTT For Ten-Tec's Linear.....	DA1NF/WD6AXL	68	Apr
Comfort Mods for the Mark II.....	WA4HUZ	78	Apr
Who Needs SSB?.....	K8JS	118	Apr
The Heath/Kenwood Connection.....	WB5QGI	128	Apr
User Report: the IC-245.....	W8YA	96	May
Improving the Sabtronic 2000.....	N8AMR/4	138	May
Customize Your HT144B.....	W2KGV	46	Jun
Charging up the WE-800.....	K7CMS	94	Jun
The Ramsey 2m Amp Kit.....	N8RK	100	Jun
An Improved Display for the TR-7400A.....	WA6AVJ	108	Jun
The Resistance Substitution Box.....	WA2SUT/NNN0ZVB	112	Jun
Death-Defying PL Mods for the KDK 2015.....	W8GQL	40	Jul
Add Solid-State Braking to the T <sup>2</sup> X.....	WB2DTY	140	Jul
Frosting for the FT-901DM.....	K4TWJ	50	Aug
Mods for the Mark.....	K9EID	52	Aug
Little Extras for the Century 21.....	KN4JJG	64	Aug
A Powerful Plus For Your TR-2200A.....	W6RON	96	Aug
Testing the DSI 3600A Frequency Counter.....	WA6ITF	108	Aug
A Better Heathkit "Cantenna".....	W5ZG	124	Aug
Maximum Security for the 22S.....	K8KW	48	Sep
The Triton IV Goes QRP.....	W1FK	64	Sep
An LED Display for the HW-2036.....	WA4BZP	36	Oct
CW Fans: Give Superior Selectivity to your Atlas Rig.....	WB9WWM	90	Oct
FSK Fix for the 820S.....	W1PN	114	Oct
New Rig for 10 FM.....	K4TWJ	38	Nov
Preserve Your Sanity with this Midland 509 Mod.....	WA6MPG	144	Nov
Touchtoning Your Memorizer.....	AD1B	146	Nov
The TR-7500 Goes Inverted.....	WA2JKN	160	Nov
Ready for the New Repeater Subband?.....	WA6FWQ	162	Nov
New Product: Swan's Astro 150 SSB Transceiver.....	WB8BTH	32	Dec
Turn Off Repeater Windbags.....	WD5HYQ	144	Dec
The Memorizer Flies Inverted.....	W1WUO	150	Dec

## CONSTRUCTION

A Solution to the Home-Brew Housing Shortage.....	W0IHI	38	Jun
Protect Your Home-Brew Panels.....	VE2BVW	80	Jun
Tools and Techniques for Wire- Wrapping.....	W6SWZ	126	Dec
Scrounger's Special: Used Dental Tools.....	WA7OYX	176	Dec

## CONTROL

The Twofer.....	K3JML	78	Jan
Major League TT Controller.....	K3NCL	140	Jan
Foiling the Mad Kerchunker.....	K5MAT/N5EE	66	May
Power Line DXCC (Distant Control Circuit).....	W9CGI	34	Sep
No More Rotary Switches.....	WA2FPT	118	Sep
Another Approach to Repeater Control.....	W7JSW	54	Oct
A Simple 2m/10m Crossband Repeater System.....	K9EID	44	Dec

## COUNTERS

Project Update.....	K2OAW	148	Jun
---------------------	-------	-----	-----

## CW

The MINI-MOUSE Key.....	WA6EGY	120	Jan
The Soft Touch Keyer.....	WA3PKU	128	Jan
Five-Chip Auto IDer.....	Bartholomew	28	Feb
This Station Plays Beautiful CW.....	WB9WRE	84	Feb
The Cure for Migraines.....	Harper	92	Feb
Build a CW Memory.....	WA1ZFW	106	Apr
Tricky QSK.....	Blasco	124	Apr
CW with a Nordic Flair.....	K2VJ	146	Apr

PROM IDer for Longer Callsigns.....	W4VGZ	34	May
Poor Man's CW Memory.....	WB0RYN	142	Jun
Add-On Keyboard for Your Keyer.....	K4BZD	60	Aug
The One-Note Pipe Organ.....	WB7CMZ	120	Aug
In Quest of Perfect Break-In.....	WB7CMZ	106	Sep
The Double-Sawbuck QRM Annihilator.....	WA5QAP	50	Oct
Son of Keycoder.....	W4RNL	106	Nov
The Further Adventures of Keycoder.....	AD9K	196	Dec

### DIGITAL

An 8-Bit DPDT Digital Switch.....	W1SNN	130	Oct
-----------------------------------	-------	-----	-----

### GADGETS

Explore the World of VLF.....	W3QVZ	32	Jan
The S.H.A.F.T.....	K5CW	34	Jan
Build a \$10 Digital Thermometer.....	McClellan	52	Jan
Adam-12 Revisited.....	N8AMR/4	80	Jan
Two Meter Tone Alert.....	WA3ENK	90	Jan
Sneaky Car Security System.....	WB8SWH/W8VL	94	Jan
Oh, My Poor Quad!.....	K2CL	56	Feb
Don't Get Burgled!.....	Fletcher	60	Feb
Batteries Dead?.....	Staff	78	Feb
A \$5 Phone Patch.....	WA6RJK	122	Feb
The Filcher Foiler Revisited.....	Davis	136	Feb
An Audio Morse Memory.....	WB6WQN	144	Feb
Car Battery Charger.....	W1DWZ	156	Feb
Immortality for Vacuum Tubes?.....	K5KXM	160	Feb
The Hot Mugger X1.....	WB9QZE	163	Feb
Universal Alarm Circuit.....	Staff	50	Mar
A Speedy Spinner Mod.....	W2RZJ	40	Apr
A Variable Bandpass Active Filter.....	W3KBM	42	Apr
Help for the Hearing-Impaired.....	W4VRV	56	Apr
Tales of Speech Processing.....	WA4JHS	62	Apr
Wire-Wrap on a Budget.....	K4LPQ	108	Apr
Make Life Easier.....	W4CQQ	126	Apr
A Low-Cost Circuit Board Holder.....	Steele	92	May
Turn Signal Timeout.....	K1OTW	142	May
How to Toot Your Own Horn.....	WA4CLG	72	Jun
Inexpensive Scope Tuner.....	VE7CGK	110	Jun
Protect Yourself with a GFI.....	WA6PEC	138	Jun
Three Baluns for a Buck.....	W6SJK	102	Jul
The Big Blinker.....	AD5X	50	Sep
Morse Converter for DMMs.....	WA6AXE/3	52	Sep
A Three-Digit Timer for TTL Illiterates.....	K3VTQ	136	Nov
A Versatile, Variable Active Filter.....	WA8HEB	66	Dec
Build a \$5 Coax Switch.....	W8HXR	146	Dec
The Induction Relay: Self-Powered Switching.....	K6DZY	192	Dec

### HISTORY

The W7GAQ Key Collection.....	K7NZA	38	May
The History of Ham Radio—part VIII.....	W9CI	100	May
"The Voice of Wolf Creek".....	W6CK	54	Jun
The History of Ham Radio—part IX.....	W9CI	56	Aug
The History of Ham Radio—part X.....	W9CI	44	Sep

### HUMOR

DX Fantasy.....	VE3FLE	109	Mar
Chamber of Horrors.....	WB6WFI/LB	144	Mar
Einstein Was Wrong!.....	Phenix	116	Oct
Hamdom's Evangelical Crusade.....	WB8TCC	148	Dec
First Look at Latest Radio Laws.....	KB5AD	188	Dec

### IC

Experimenting with Tones.....	W2FPP	62	Feb
A Single IC Time Machine.....	K6SK	148	Feb
Experimenter's Corner: The MM5369N.....	Patten	68	Sep

### I/O

Design-a-Notcher.....	WA4HUU	100	Jan
The Cosmac Connection: Part 1.....	VE3CWY	102	Jan
Noise Bridge Basics.....	N6RY	108	Jan
The Morse Master.....	WB9TNW	114	Jan
An 8080 Repeater Control System— part I.....	N3IC	94	Feb
The Cosmac Connection: Part 2.....	VE3CWY	106	Feb

Learning the Code.....	Waldie	110	Feb
Books for Beginners.....	WA7NEV	116	Feb
An 8080 Repeater Control System— part II.....	N3IC	100	Mar
Try a Log Periodic Antenna.....	WA1ZAC	110	Mar
The Micro Magic Pi Designer.....	Boelke	114	Mar
Winning the QSO Name Game.....	WA3MWM	118	Mar
An 8080 Repeater Control System— part III.....	N3IC	82	Apr
The Micro Duper.....	WB2MIC,WA2RZR	96	Apr
An 8080 Disassembler.....	Raskin	98	Apr
An 8080 Repeater Control System— part IV.....	N3IC	72	May
RTTY Transceive for the KIM-1.....	WB8VQD,WB3GCP	78	May
Keyboard Convenience.....	WA7NEV	86	May
DXCC in One Sitting.....	WA4FYZ,N2CR	88	May
Now You Can Possess Instant Recall.....	WB5UTJ/N5AUX	86	Jun
Calcu-Trip.....	Lutz	92	Jun
Microcomputer RTTY... a Software TU... Baudot Hard Copy For Your SWTPC.....	N1AW	78	Jul
Computerize That Mailing List.....	WB5UTJ/N5AUX	78	Aug
Build the KIM Keyer.....	K0EI	80	Sep
No More TRS-80 Cassette Woes.....	WA9PUL,K9POX	96	Sep
The Microsizer: Computerized Frequency Control.....	N4ES,W4BF	74	Oct
My TRS-80 Is Here... Now What?.....	W3KBM	96	Dec
Teaching Your Micro to Count.....	K6EW	104	Dec

### MISCELLANEOUS

Diodes of the Dead.....	K5JNR	44	Jan
Take the Pledge.....	K3MPJ	86	Jan
One Step Further.....	Staff	124	Jan
High Seas Adventure—ham style— part IV.....	WA6FEI	184	Jan
A Touch of Class.....	WA4CUD	39	Feb
The 2 Meter ECM Caper.....	W2JTP	118	Feb
The Last DXpedition.....	K3FDL	142	Feb
The Amazing Active Attenuator.....	VE2BVW	146	Feb
Reaching for the Top.....	N1PL	46	Mar
Keyboard Serialization.....	Bosen	90	Mar
New Coax Cable Designations.....	W5JJ	112	Mar
On the Razor's Edge.....	W5WY/1	122	Mar
Lightning!.....	W8HXR	104	Apr
House Hunting for Hams.....	WB9URA	150	Apr
At Last! A Really Simple Speech Processor.....	W9UT,WB9OEC	64	Jun
New Life for Tube-Type Dippers.....	K4LJA	66	Jun
You Can Watch Those Secret TV Channels.....	K0JB, K0FQA	32	Aug
Blueprint for Biofeedback Experimentation.....	WD5BNL	42	Sep
The Amazing Audio Elixir.....	N6WA	116	Sep
Confessions of a Teenage HFer.....	Peter	122	Sep
Extremely Low Frequency Radiation: Cause for Worry?.....	WB2NEL	34	Oct
Freedom Fighters on Forty.....	KA5M	108	Oct
The MARC Success Story.....	K9EID	64	Nov
Exploring Uncle Sam's Bookstore.....	WB3DRF	84	Nov
Audio Booster for Mil-Surplus Receivers.....	McClellan	50	Dec
Ham Radio Marriage Manual.....	WB5YVE	76	Dec
Muffin Fan Mania!.....	WA6NCX/1	88	Dec
Operation Santa!.....	WD8LPN	118	Dec
Do-It-Yourself Carrying Case for Wilson HTs.....	K2GMZ	160	Dec
Rack 'Em Up.....	VE2BVW	172	Dec

### MOBILE/PORTABLE

Ignition Noise and 2m FM.....	W3QG	94	Mar
Power Up for Mobile Operation.....	WB9SKX	146	Jun
Tennamatic: An Auto-Tuning Mobile Antenna System.....	W6TWW	132	Jul
Get a Piece of The Rock.....	W9JVF/ZB2C2	136	Oct

### OPERATING

SOS! Ship in Trouble.....	W1BNN	132	Jan
---------------------------	-------	-----	-----

Minicontests.....	Stocking,W0VM	138	Jan
Alaskan Adventure.....	WB5WDG	140	Feb
Legalized ASCII! The Quad-S System!.....	W2FJT	80	Mar
Disaster Preparedness.....	N4AL	74	Apr
The DXer's Secret Weapon.....	W6BKY	64	May
You Ought To Be in Pictures.....	K4TWJ	68	Jun
Where Have All the kHz Gone?.....	W8GI	96	Jun
Vodka Amongst the Penguins.....	W1FK	126	Jun
A Close Encounter With Voyager I.....	K6PGX	70	Jul
Marine-Band Activity.....	WA2KBZ	154	Jul
Hit the Panic Button!.....	AA6C	94	Aug
Beams vs. Linears: Which Should You Buy First?.....	N4OE	156	Nov
A No-Nonsense Operating Table.....	Anderson	186	Nov
Are Repeaters Ripping Us Off?.....	KB2JN	92	Dec

**OSCAR**

Autotrak II.....	W9CGI	62	Jan
Has Anyone Seen OSCAR 7?.....	Mayse	122	Apr

**POWER SUPPLIES**

Try A Little KISS.....	K8AO	58	Jan
The All-Wrong Power Supply.....	WA3EEC	32	Feb
Custom-Designed Power Supplies.....	K2GEJ	34	Feb
Power x 2.....	Miller	61	Feb
Power Plus!.....	W6YUY	42	Mar
A New Approach To Nicad Care.....	W0LM	119	Mar
Trickle-Cost Trickle Charger.....	W5JJ	163	Mar
12 Volts, 5 Amps, 3 Terminals.....	WA4FYZ	120	Apr
A Junk-Box HT Charger.....	WB9JLY	76	Jun
Simple Dual-Voltage Supply.....	W4VGZ	44	Aug
The Many-Talented 723.....	WB0SKX	68	Aug
More Power to You.....	K9MLD	90	Aug
Build a Simple HT Charger.....	W6SMJ	152	Dec
Gadzooks! A Variable 0-260 V Ac Supply.....	WB8JCQ/LU1AKO	174	Dec

**RECEIVERS**

Building an Economy Receiver.....	WB4NEX	46	Jan
Dual-Band Smokey Detector.....	W1SNN	48	May
Add Digital Display for \$50.....	K4IQJ	28	Jun
High-Performance Receiver Add-Ons.....	W5DA	32	Jun

**RTTY**

The ST-5 Plus.....	K5QY	50	Jan
Digital RTTY Is Simple.....	WB5NYX	84	Jan
A Rock-Solid AFSK Oscillator.....	WB4MBL	52	Feb
Simple RTTY IDer.....	G3MEJ	60	Apr
Double-Duty Decoder Project.....	WA1UFE/5	152	Dec

**SATELLITE—OTHER THAN OSCAR**

Attention, Satellite Watchers!.....	WB8DQT	66	Feb
The Satellite TV Primer.....	W5KHT	120	Nov
Low-Cost Receiver for Satellite TV.....	N6TX	38	Dec
Variable Tuning for WEFAX Receivers.....	N6TX	70	Dec

**SSTV**

Computerized Slow Scan ... Revisited...	K6AEP	90	Nov
Come On In—The Viewing Is Fine.....	K4TWJ	168	Dec

**SURPLUS**

Trends in Surplus.....	WA2SUT/NNN0ZVB	68	May
------------------------	----------------	----	-----

**TEST GEAR**

The Italian Freq Generator.....	K7YZZ	24	Jan
Are Your Op Amps Opping?.....	W3KBM	139	Jan
Pulser Plus.....	VE2BVW	54	Feb
A Self-Contained, Fully-Automated, Transistorized Fuse Tester.....	G3TAI	58	Feb
Build An Economy Zener Checker.....	W4RBL	137	Feb
Build the Mini-Probe.....	Rister	164	Feb
Build a Hybrid Capacity Meter.....	WA4HUU	40	Mar
Compact Continuity Tester.....	Miller	116	Apr
Ultra-Simple CMOS Logic Probe.....	WB9PHM	50	Jun
Antenna Tuning Joy Revisited.....	W9CGI	48	Jul

Bargain Zener Classifier.....	WD8AAM	46	Aug
Build a Wide-Range Rf Resistance Bridge.....	K4KI	100	Aug
It's a Wattmeter... It's an Swr Bridge...			
It's Swattmeter!.....	K4LBY	42	Oct
Something New: the MVM.....	Ogushwitz	74	Nov
Sound for the CMOS Logic Probe.....	WB9PHM	138	Nov
"Hey! That Sounds Like .01 uF!".....	W4KIX,W4RYY	170	Nov
Build this \$50 Mini-Counter.....	McClellan	58	Dec

**THEORY**

Hooray for LC Filters!.....	Ogushwitz	126	Jan
Electronics Education by Mail Order.....	N6UE	172	Jan
Time-Domain Reflectometry.....	Staff	178	Jan
The Hardhearted Rf Detector.....	N4ES	33	Feb
Impedance and Other Ogres.....	Staff	46	Feb
The Active Filter Cookbook.....	VE2BVW	50	Feb
Exorcise Those Unwanted Frequencies....	Staff	54	Mar
The 10-GHz Cookbook.....	K6IQL	60	Mar
Tips for VOM Users.....	Staff	128	Mar
How Do You Use ICs?— part XI.....	WA2SUT/NNN0ZVB	42	Jun
Modern Solid-State Equipment Design: A Better Way.....	W4RNL	52	Jul
Beware of the Dreaded Phantom Ground.....	WA2SUT/NNN0ZVB	68	Jul
What the Hell is a Decibel?.....	WA5EBB	48	Aug
How to Home-Brew Your Own Crystal Filters.....	Staff	56	Sep
Analog Telemetry Techniques.....	K4IPV	68	Oct
Working with FETs— part I.....	WA2SUT/NNN0ZVB	60	Nov
Want to Upgrade? Take a Tip from a Ham Who Did!.....	KB6FC	66	Nov
A Microwave Primer.....	W1SNN	68	Nov
Working with FETs—part II. .	WA2SUT/NNN0ZVB	54	Dec
License Upgrading—A Plan of Attack.....	WB2RVA	84	Dec
Working with Transistors...	WA2SUT/NNN0ZVB	132	Dec
All About Ground Rods.....	Staff	200	Dec

**TOUCHTONE**

Tone Decoder Improvements.....	WA1LMV	30	Feb
One-Chip Tone Decoding.....	WB0VGI	72	Aug
A Sensible CMOS TT Decoder.....	N6WA	98	Oct
DTMFR for your Repeater.....	K4ALS	102	Oct

**TRANSCEIVERS**

Proper FM Transceiver Adjustment.....	VE3AVY	44	May
The Incredible Shrinking Transceiver....	K4DHC	100	Sep

**TRANSMITTERS**

Yes, You Can Build this Synthesizer....	WB2BWJ	58	Oct
A Fresh Start for your Old Tx.....	KE4Y	52	Nov

**VHF**

Synthesize Your Ash Tray.....	WB9VWM	64	Feb
How to Nab a Jammer.....	WB0CMC	80	Feb
Easy-to-Build 220 Transverter.....	WA7SPR	142	Oct
Introducing the 2m/220 Connection....	WB4HXE	48	Nov
An Inflation Fighter for 220.....	WA3HWG	54	Nov

# Ham Help

I need a manual for a Heathkit model IM-32 VTVM. I will gladly reimburse reasonable duplicating and mailing expenses, or I will duplicate on receipt and send back by return mail. Thanks.

Lawrence Young W1YVW  
54 Samuel Ave.  
Pawtucket RI 02860

I have a Pride HFL-125 Bilinear Amplifier and I need a schematic and information on the finals. Specifically, what replacement numbers could I use? I will pay for the postage and copy. Thank you.

Fritz Zingel KA2FCG  
341 72nd St., Apt. B  
North Bergen NJ 07047



**SELECTIONS**

**REGULATED POWER SUPPLY**

± 12V. 6 amp. or can be connected in parallel for 12V 12 amp. Voltage adjustable 10-14V. Regulation .01%. 5" x 8" x 16". SHPT. WT. 23#. PRICE: \$30.00 ea.

**12V. 8 amp. ADJUSTABLE.** 10-14V current limited. SHORT PROTECTED. O.V. PROTECTION. 5" x 5" x 9". SHPT. WT. 15#. PRICE: \$30.00 ea.

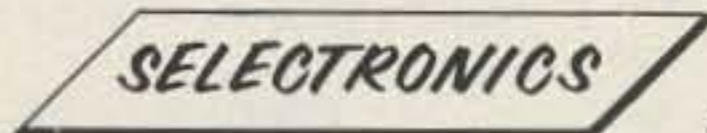

✓ S16

<b>TELEPHONES:</b>	<b>WAREHOUSE</b>
Area Code 215	1206-18 S. Napa St.
HOward 8-4645	1201-49 S. Patton St.
HOward 8-7891	1207-25 S. Napa St.

1206 S. Napa Street • Philadelphia PA 19146

PENNA. RESIDENT PLEASE ADD 6% SALES TAX. ALL PRICES ARE F.O.B. OUR WAREHOUSE, PHILA., PA. ALL MERCHANDISE ACCURATE AS TO DESCRIPTION TO THE BEST OF OUR KNOWLEDGE. YOUR PURCHASE MONEY REFUNDED IF NOT SATISFIED. MIN. ORDER \$10.00.

**RF Speech Processors for Drake TR-7, TR-4s, T-4Xs**

Special 8-pole IF crystal filtering, followed by highly-effective active hard limiting: the key to intelligibility and talkpower. TR-7 processor provides room for an additional accessory filter. All solid-state pin-diode switching. TR-7, TR-4 units feature selectable 16-pole receive. Model 7-SP for TR-7: \$265.00. Model 4-SP for T-4X: \$285.00. TR-4 unit available at a later date.

**NEW! RF CLIPPERS**



**Mike Equalizer Pre-Processor**

Companion to above units, but good between any mike and rig. Can reduce distortion, improve crispness, intelligibility. Easily-adjustable single control tailors both high and low frequencies to optimize response of any microphone. Contains in/out, gain, equalization controls. Model SE-1: \$65.00.

**Sherwood Engineering Inc.**

1268 South Ogden St. Denver, Colo. 80210 ✓ S125  
(303) 722-2257

Money back if not satisfied

Add \$3 per order shipping: \$6 overseas air

Dealer Inquiries Welcome

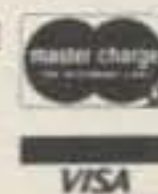

**THE FIRST CHOICE IN REPEATER CONTROL**

The Power and Flexibility of Microprocessor Technology

AUTOPATCH, REVERSE PATCH, SMART ID, ACCESS CODE MUTING, MORSE CODE ANNOUNCEMENTS, FLEXIBLE FUNCTION TIMEOUT, COURTESY TONE, LINKING, CONTROL OP. FUNCTIONS, TWELVE USER FUNCTIONS, ... AND MUCH MORE.

Call or write for specifications:

**MICRO CONTROL SPECIALTIES (617) 372-3442**

✓ M69

23 ELM PARK GROVELAND, MA. 01834

**NEW MFJ SOLID STATE**

**24 HOUR DIGITAL CLOCK**

Eliminate converting to GMT. Pleasant **BLUE** easy-on-eyes display. Bright .6 inch digits. **ID timer**. Alarm, snooze, lock functions. Power out, alarm on indicators. Assembled.



**Pleasant Blue Display is easy-on-eyes. Bright .6 inch digits. Built-in ID timer.**

**\$29<sup>95</sup>**

The MFJ-101 is a new all solid state 24 hour digital clock. Just set it to GMT and forget about converting to GMT.

**Pleasant blue .6 inch digits** (like TS-820S) are easy-on-eyes and bright enough to see clear across your room.

**ID timer** alerts you every 9 minutes after you tap ID/doze button.

**Set alarm** to remind you of SKED or simply to wake you up in morning. Has alarm on indicator.

**Fast/slow set buttons** make setting time and alarm simple.

**Lock function** prevents missetting time/alarm. Digits flash if power is interrupted. Rugged black plastic case. Brush aluminum front/top panel.

**UL approved.** 110 VAC. 50/60 HZ switch for USA, Europe, Japan and other countries. Use

220/240 VAC with optional AC adapter. 6x2x3 in.

**Order from MFJ and try it — no obligation.** If not delighted, return it within 30 days for refund (less shipping). One year limited warranty by MFJ.

**Order today.** Call toll free 800-647-1800. Charge VISA, MC or mail check, money order for \$29.95 plus \$3.00 shipping/handling for MFJ-101.

**Don't wait any longer** to enjoy the convenience of reading GMT time directly.

**CALL TOLL FREE ... 800-647-1800**

Call 601-323-5869 for technical information, order/repair status. Also call 601-323-5869 outside continental USA and in Mississippi. ✓ M52

**MFJ ENTERPRISES, INC.**

BOX 494, MISSISSIPPI STATE, MS 39762

STATEMENT OF OWNERSHIP, MANAGEMENT AND CIRCULATION (Required by 39 U.S.C. 3685). 1. Title of publication, 73 Magazine. 2. Date of filing, Sept. 25, 1979. 3. Frequency of issue, Monthly. A. No. of issues published annually, 12. B. Annual subscription price, \$18. 4. Location of known office of publication (Street, City, County, State and ZIP Code) (Not printers), 73 Pine Street, Peterborough, Hillsboro County, N.H. 03458. 5. Location of the headquarters or general business offices of the publishers (Not printers), 73 Pine Street, Peterborough, Hillsboro County, N.H. 03458. 6. Names and complete addresses of publisher, editor and managing editor. Publisher (Name and Address), Wayne Green, Pine Street, Peterborough, N.H. 03458. Editor (Name and Address), Wayne Green, Pine Street, Peterborough, N.H. 03458. Managing Editor (Name and Address), Jack Burnett, Pine Street, Peterborough, N.H. 03458. 7. Owner (If owned by a corporation, its name and address must be stated and also immediately thereunder the names and addresses of stockholders owning or holding 1 percent or more of total amount of stock. If not owned by a corporation, the names and addresses of the individual owners must be given. If owned by a partnership or other unincorporated firm, its name and address, as well as that of each individual, must be given.) Name, 73, Inc., Peterborough, N.H. 03458. W. Sanger Green, Rt. 3, Littleton, N.H. 03561. 8. Known bondholders, mortgagees, and other security holders owning or holding 1 percent or more of total amount of bonds, mortgagees or other securities (If there are none, so state) Name, none. 9. For completion by nonprofit organizations authorized to mail at special rates (Section 132.122, PSM). The purpose, function, and nonprofit status of this organization and the exempt status for Federal income tax purposes (Check one) Not applicable. 10. Extent and nature of circulation. (X) Average No. copies each issue during preceding 12 months. (Y) Actual No. copies of single issue published nearest to filing date. A. Total No. copies printed (Net Press Run) (X) 87,000 (Y) 86,000. B. Paid circulation 1. Sales through dealers and carriers, street vendors and counter sales (X) 13,500 (Y) 13,450. 2. Mail subscriptions (X) 67,500 (Y) 66,750. C. Total paid circulation (Sum of 10B1 and 10B2) (X) 81,000 (Y) 80,200. D. Free distribution by mail, carrier or other means samples, complimentary, and other free copies (X) 1,200 (Y) 1,200. E. Total distribution (Sum of C and D) (X) 82,200 (Y) 81,400. F. Copies not distributed 1. Office use, left over, unaccounted, spoiled after printing (X) 4,300 (Y) 4,050. 2. Returns from news agents (X) 500 (Y) 550. G. Total (Sum of E, F1 and 2—should equal net press run shown in A) (X) 87,000 (Y) 86,000. 11. I certify that the statements made by me above are correct and complete. Signature and title of editor, publisher, business manager, or owner. Robert R. LaPointe, Business Manager.

# Social Events

Listings in this column are provided free of charge on a space-available basis. The following information should be included in every announcement: sponsor, event, date, time, place, city, state, admission charge (if any), features, talk-in frequencies, and the name of whom to contact for further information. Announcements must be received two months prior to the month in which the event takes place.

## HAZEL PARK MI DEC 2

The Hazel Park Amateur Radio Club will hold its 14th annual swap & shop on December 2, 1979, from 8:00 am to 2:00 pm, at the Hazel Park High School, Hazel Park, Michigan. Admission is \$1.00 at the door, and main prize tickets are also \$1.00. There will be food, plenty of free parking, and door prizes. Featured will be computer demonstrations of the Apple II, PET, TRS-80, and more. Talk-in on .52 simplex. For information, send an SASE to the Hazel Park Amateur Radio Club, Robert Numerick WB8ZPN, 23737 Couzens, Hazel Park MI 48030.

## LORAIN OH DEC 8

The Northern Ohio Amateur Radio Society will hold its annual Christmas banquet on Saturday, December 8, 1979, at Gargus Hall, Lorain, Ohio. There will be many excellent door prizes and an RCA TV, Regency scanner, and liquor prizes will be given away at a benefit raffle (tickets are \$1.00). Tickets for the banquet are \$9.00 and available on an advanced-sale-only basis. The deadline is December 6, 1979. Talk-in on 146.10/.70. For tickets and complete details, send check or money order to NOARS, PO Box 354, Lorain OH 44052.

## SOUTH BEND IN JAN 6

A hamfest swap & shop will be held on January 6, 1980, at New Century Center, on US 31 by the river, South Bend, Indiana. Tables are \$3.00 each. Food service, automobile museum, and art center are in the same building as the hamfest. Talk-in on 146.52/.52, .13/.73, .34/.94, 147.99/.39, .87/.27, and .69/.09. For information, write the Repeater Valley Hamfest committee, Wayne Werts K9IXU, 1889 Riverside Drive, South Bend IN 46616, or phone (219)-233-5307.

## RICHMOND VA JAN 13

The Richmond Frostfest III, sponsored by the Richmond Amateur Telecommunications Society, will be held Sunday, January 13, 1980, at the Bon Air Community Center. There will be a home-brew contest with four awards: most original idea, best electrical work, best mechanical work, and most deserving work, and prizes. FCC exams start 10:00 am and completed Form 610s must be received in the Norfolk Office of the FCC at 870 North Military Highway, Bank of Virginia Bldg., Norfolk VA 23502, no later than January 9th. Admission is \$3.00, indoor flea market tables are \$3.00, and tailgaters are \$2.00. Talk-in on .28/.88 and .34/.94. For further information, contact the Richmond Amateur Telecommunications Society, PO Box 1070, Richmond VA 23208.

## SHARON PA JAN 19

The third annual Mercer County Amateur Radio Club seminar will be held at the Holiday Inn, West Middlesex, Pennsylvania, off I-80, from 9:00 am to 5:00 pm. Come to hear speakers on your favorite amateur radio topics. Advance admission is \$2.00. There will be door prizes. For further details, write K3LA, PO Box 673, Sharon PA 16146.

## ARLINGTON HEIGHTS IL JAN 27

The Wheaton Community Radio Amateur Club will hold its Wheaton Hamfest Portable Nine on Sunday, January 27, 1980, at the Arlington Park Expo Center, Arlington Heights Race Track, Arlington Heights, Illinois. Doors will open at 8:00 am sharp! 300 free flea market tables will be available, plus 100 commercial booths. There will also be hourly door prizes. Tickets are \$3.00 at the door and \$2.00 in advance. For information, send an SASE to WCRA, Box QSL, Wheaton IL 60187.

## LIVONIA MI FEB 17

The Livonia Amateur Radio Club will hold its 10th anniversary Swap 'n Shop on Sunday, February 17, 1980, from 8:00 am to 4:00 pm, at the Churchill High School, Livonia, Michigan. There will be plenty of tables, door prizes, refreshments, and free parking available, plus reserved table space of 12-foot minimum. Talk-in on 146.52. For further information, send an

SASE to Neil Coffin WA8GWL, c/o Livonia Amateur Radio Club, PO Box 2111, Livonia MI 48150.

## DAVENPORT IA FEB 24

The Davenport Radio Amateur Club will hold its ninth annual hamfest on Sunday, February 24, 1980, from 8:00 am to 4:00 pm, at the Davenport Masonic Temple, Highway 61 (Brady Street) and 7th Street, Davenport, Iowa. Tickets are \$2.00 in advance; \$3.00 at the door. Tables are \$3.00 each, no limit, with a \$2.00 additional charge for ac electrical hook-up. Talk-in on 146.28/.88 W0BXR repeater. Advance tickets can be purchased by writing to club treasurer Clarence Wilson WA0OEW, 1357 W. 36th Street, Davenport IA 52806.

## LANCASTER PA FEB 24

The Lancaster Hamfest will be held on February 24, 1980, at the Guernsey Pavilion, located at the intersection of Rtes. 30 and 896, east of Lancaster, Pennsylvania. General admission is \$3.00, except children and XYLs. Doors will open at 8:00 am. All inside spaces are available by advance registration only and are \$3.00 each for an 8-foot space, which includes a table. There will be free tailgating in a specified area outside, if the weather permits. There will be a two-hour Dutch Country tour by an advance registration of \$4.00. Food will be served at the hamfest. Also, there are excellent restaurants and accommodations in the area. Talk-in on .01/.61. For information, write Sercom, Box 6082, Rohrerstown PA 17603.

## STERLING IL MAR 9

The Sterling-Rock Falls Amateur Radio Society will hold its 20th annual hamfest on Sunday, March 9, 1980, at the Sterling High School field house, 1608 4th Ave., Sterling, Illinois. Advance tickets are \$1.50; door tickets are \$2.00. Over \$2,000 worth of prizes will be given away. A large indoor flea market will be restricted to radio and electronic items only. There will be plenty of free parking, lots of bargains, and plenty of good food. Talk-in on .25/.85 (WR9AER). For tickets, write Don Van Sant WA9PBS, 1104 5th Avenue, Rock Falls IL 61071.

## VERO BEACH FL MAR 15-16

The Treasure Coast Hamfest will be held on March 15-16, 1980, at the Vero Beach Community Center, Vero Beach, Florida. Featured will be prizes, drawings, and a QCWA luncheon. Admission is \$3.00 per family in advance; \$3.50 at the door. Talk-in on 146.13/.73,

146.04/.64, and 222.34/223.94. For information, write PO Box 3088, Vero Beach FL 32960.

## FORT WALTON BEACH FL MAR 22-23

The Playground Amateur Radio Club will hold its 10th anniversary swapfest on Saturday and Sunday, March 22-23, 1980, from 8:00 am to 4:00 pm each day, at the Okaloosa County Shrine Fairgrounds, Fort Walton Beach, Florida.

## TIMONIUM MD MAR 30

The Baltimore Amateur Radio Club will hold its greater Baltimore Hamboree and Computerfest on March 30, 1980, at the Maryland State Fairgrounds, just off I-83, 2 miles North of I-695, Timonium, Maryland. There will be plenty of space for dealers, displays, tables, and commercial exhibits. Special events, lectures, and demonstrations will be held. Food service will be provided. There will be acres of space for tailgate sales. Door prizes will be awarded throughout the day. Admission is \$3.00 and tables are \$5.00. Talk-in on the BARC repeaters, 146.07/.67 and 146.34/.94. For additional information, tickets, and space reservations, please write to Joseph A. Lochte, Jr., 2136 Pine Valley Drive, Timonium MD 21093, or for a recorded message, dial (301)-HAM-TALK.

## ST. CLAIR SHORES MI APR 13

The South Eastern Michigan Amateur Radio Association will hold its 22nd annual hamfest on April 13, 1980, from 8:00 am to 3:00 pm at South Lake High School, 21900 E. Nine Mile Road (at Mack Ave.), St. Clair Shores, Michigan.

## ST. LOUIS MO MAY 24-25

The ARRL Midwest and Central Divisions will hold their amateur radio and computer hobbyist convention on May 24-25, 1980, at the Cervantes Convention Center, St. Louis, Missouri. Featured will be prominent speakers, information forums, equipment displays and demonstrations, and an indoor flea-market sale. Friday night, May 23rd, will be "Amateur Radio Night" at Busch Memorial Stadium, where the St. Louis Cardinals will play the San Diego Padres. On Saturday night, May 24th, the convention banquet and dance will be held on the riverboat *Admiral*. On Memorial Day, May 26th, there will be an all-day visit to Six Flags Over Mid-America. For more information, write to Gateway Amateur Radio Association, Inc., Box 68, Marissa IL 62257.

# FAST SCAN ATV

## WHY GET ON FAST SCAN ATV?

- You can send broadcast quality video of home movies, video tapes, computer games, etc., at a cost that is less than slocan.
- Really improves public service communications for parades, RACES, CAP searches, weather watch, etc.
- DX is about the same as 2 meter simplex — 15 to 100 miles.



### ALL IN ONE BOX

**TC-1 Transmitter/Conv**  
Plug in camera, ant, mic and you are on the air . . . . . \$399 ppd



**HITACHI HV-62 TV CAMERA**  
High performance closed circuit camera just right for atv. with lens . . . . . \$239 ppd

### PUT YOUR OWN SYSTEM TOGETHER



**TVC-1B CONVERTER** tunes 420 mhz down to ch 2 or 3 . . \$49.50 ppd  
**TXA5 EXCITER** . . . . . \$69 ppd  
**PA5 10 WATT LINEAR** . . \$79 ppd  
**FMA5 Audio Subcarrier** . \$24.50 ppd

**SEND FOR OUR CATALOG, WE HAVE IT ALL**  
Modules for the builder, complete units for the operator antennas, color cameras, repeaters, preamps, linears, video ider and clock, and more. 19 years in ATV.

Call 213-447-4565 5-6 pm

✓ P41

## P.C. ELECTRONICS

Maryann  
WB6YSS

2522 PAXSON  
ARCADIA, CA 91006

Tom  
W6ORG

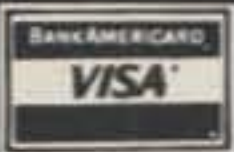

# BELDEN

Part Number	MHz	db/100 ft.	db/100 m
<b>9888</b> 39¢/ft	50	1.2	3.9
	100	1.8	5.9
	200	2.6	8.5
	300	3.3	10.8
	400	3.8	12.5
<b>8214</b> 25¢/ft.	50	1.2	3.9
	100	1.8	5.9
	200	2.6	8.5
	300	3.3	10.8
	400	3.8	12.5
<b>8237</b> 21¢/ft	100	2.0	6.6
	200	3.0	9.8
	400	4.7	15.4
	900	7.8	25.6
<b>8267</b> 25¢/ft	100	2.0	6.6
	200	3.0	9.8
	400	4.7	15.4
	900	7.8	25.6
<b>8448</b> 16¢/ft	No. of Cond. — 8 AWG (in mm) — 6-22. (7x30). [1.76]; 2-18. (16x30). [1.19]		
<b>9405</b> 26¢/ft	No. of Cond. — 8 AWG (in mm) — 2-16. (26x30). [1.52]; 6-18. (16x30). [1.17]		

## MADISON ELECTRONICS SUPPLY, INC.

1508 McKINNEY • HOUSTON, TEXAS 77002

713/658-0268

✓ M35

# Ham Help

We are interested in contacting amateurs who are Oral Roberts Partners.

**Amateur Radio Outreach Club**  
Oral Roberts University  
Box 2564  
Tulsa OK 74171

I am in need of schematics, operation manuals, service manuals, etc., for a Knight T-60 transmitter and a Lafayette 99-2501 vfo. I would also like to

find an Eico 722 vfo and an Eico 730 modulator, preferably with documentation.

**Peter A. Bergman KA0CRX**  
114 NW 6th Street  
Rochester MN 55901

Anyone not wanting to keep the postage stamps from DX QSL envelopes can send them

along for a private collection my son and I are starting.

**Joseph R. Kovac W3IVG**  
705 W. 12th Street  
Hazleton PA 18201

I need a schematic and/or operating manual for a Utica 650 6-meter transceiver and a schematic for a Utica V650 vfo. I will pay a reasonable price or can copy and return if necessary.

**John W. Daugherty WB8DEG**  
7500 N. Oliver  
Tucson AZ 85704

I'm looking for a Heathkit HW-20 2-meter AM transceiver (the Pawnee) in working condition.

**Al Gordon**  
1726 Spreckels Lane  
Redondo Beach CA 90278

I would like to contact amateurs in the Chicago area who are experimenting with MDS microwave TV.

**Steve Martin WA9MQF**  
178 Trailwood Lane  
Northbrook IL 60062

**RIPPED OFF?**

If you have a serious problem with a ham firm, send them a letter with all the facts in detail, plainly and simply . . . and send a copy to Wayne Green W2NSD/1, c/o 73 MAGAZINE. 73 protects its readers more than any other magazine.



Radio equipment not included

Floor Space: 39" Wide 30" Deep

## ... at last ... your shack organized!

A beautiful piece of furniture — your XYL will love it!

### \$149.95 S-F RADIO DESK Deluxe - Ready to Assemble

Designed with angled rear shelf for your viewing comfort and ease of operation.

FINISHES: Walnut or Teak Stain.  
Also available in Unfinished Birch, \$134.95

Additional Information on Request.

Checks, Money Orders, BankAmericard and Master Charge Accepted.

F.O.B. Culver City. (In Calif. Add 6% Sales Tax.)

✓ S33

S-F AMATEUR RADIO SERVICES

4384 KEYSTONE AVENUE • CULVER CITY, CALIF. 90230 — PHONE (213) 837-4870

# Corrections

Several minor errors crept into my article, "Add Digital Display for \$50," which appeared in the June, 1979, issue of 73.

In column two of page 28, 5445 kHz should read 5455 kHz (twice), and 4995 kHz should be 4955 kHz.

The crystal frequency in Fig. 1 should be 5455 kHz.

The "5" or "9" switch position indications in Fig. 3 should read "9" or "4".

The reset line for the 7490 is missing in Fig. 3 and should connect to pins 2 and 3 of the 7490. Pin 3 should not be grounded.

S1 and S2 are push-button switches.

I would suggest using 74LS

components in the counter since they should substantially reduce power and heat.

I have had many requests for circuit boards, but unfortunately they are not available at this time. Also, my address has changed since the article was published.

**Richard C. Jaeger K4IQJ**  
727 McKinley Avenue  
Auburn AL 36830

J. C. Pinckney WB2VNM has pointed out a mistake in my arti-

cle ("Experimenter's Corner: The MM5369N") which appeared in the September issue. In the article, I stated that 3.579545 MHz divided through three MM5369Ns gives you 1 Hz every 1.88 years. Joe is correct in pointing out that 1 Hz is one cycle per second and that what you indeed get is one cycle every 1.88 years. I managed to miss that correction during my proofreading and apologize for the error.

**Charles B. Patten**  
Andrews AFB MD

# New Products

from page 34

frequencies ( $\pm 75$  Hz). A minor annoyance here is that these two controls do not possess a detent or click-stop to indicate when they are in the neutral position. Both controls are always active and cannot be switched off.

Instead of the usual rf gain pot, the Astro 150 has an i-f gain control. When receiving strong signals, reducing the i-f gain eliminates much of the normal background noise. The proper use of this control can substantially reduce the fatigue that sets in after several hours of listening.

The front-panel meter does double duty as a conventional S-meter and as a power output meter. In the transmit mode, it functions as a peak-reading wattmeter. It is accurately calibrated at the factory.

There are a host of other controls and adjustments which are accessed either through small holes in the transceiver's side panels or by removing the top and bottom covers. There are separate adjustments for VOX and CW delay (when semi-break-in is used), VOX gain, VOX antitrip, sidetone level, S-meter calibration, AGC threshold, and microphone scan rate.

## On the Air

Getting the Astro 150 out of the box and on the air is a five-minute job. It's simply a matter of plugging in the power supply, speaker, and mic cables, attaching the antenna of your choice, and flipping on the power supply and transceiver power switches.

When you first apply power, the speaker is quiet for 10-15 seconds, while the PLLs lock on. The frequency display places a decimal point after each digit while this is going on so you'll know what's happening. When the decimal points blink off, the speaker springs to

life, and you're set to go.

It took me a couple of days to evolve my own favorite technique for using the 150's tuning controls. A Swan representative told me that others have come to the same conclusions I did. I found the VRS knob best suited for fairly large excursions across a band, say 25 or more kHz. Then, when I was in the vicinity of my desired frequency, I switched to the push-buttons atop the microphone. At first, this might sound like an unwieldy method of tuning, but it becomes quite natural once you've done it a few times. The push-buttons make it easy to tune up and down from your chosen spot while leaning back in your operating chair—a sort of remote control.

Dozens of contacts on every band produced many good comments about the audio quality of the rig. I ran most of the time without a linear amplifier and had no problem making plenty of DX contacts.

I had never used full break-in before checking out the 150. For most operation, I'll probably stick with the more familiar semi-break-in. When using QSK, one hears what's happening on the frequency between each dit and dah. Thus, it's possible to hear QRM while you are still transmitting and to cut your transmission short, in order to avoid competing with the QRM. Of course, experienced traffic handlers often find QSK a must. When both the sending and receiving stations are so equipped, the receiver can immediately interrupt the sender if he misses a portion of the message. I find QSK operation to be a little bit distracting after years of operating CW in silence. The break-in on the Astro 150 performed flawlessly.

## Conclusion

The Astro 150 (and 151) carries a suggested price of \$925, making it the least expensive synthesized HF rig I've seen.

The PSU-5 Power Supply/Speaker is \$179.95. The rig is worlds apart from the majority of transceivers available today, both on the outside and on the inside. Swan has taken a very different approach to transceiver design, starting from square one to produce a radio that takes full advantage of modern digital technology. The only allegiance to the past would seem to be the single conversion receiver, something Swan has long favored.

If you would rather operate than twiddle with a lot of knobs, and you want to go with thoroughly modern technology, the Astro 150 is an awfully attractive value. For further information, contact *Swan Electronics*, 305 Airport Road, Oceanside CA 92054; (714)-757-7525. Reader Service number S44.

**Jeff DeTray WB8BTH**  
Assistant Publisher

## THE WILSON SYSTEMS, INC., SYSTEM 33 TRIBANDER

Until now, the antenna farm at my QTH consisted of a monoband yagi for 20 meters on a Rohn BX-32 tower and a Wilson WV-1 vertical roof-mounted on the roof of the garage. Both antennas have performed well for both CW and SSB operation, but with the increase in sunspot activity, it has been my desire to replace the monobander with a good triband yagi beam. Lot size and tower limitations have precluded erection of the larger "DX" tribanders, so it was decided to investigate the three-element variety of beams.

Consulting with other amateurs who own tribanders and comparing the published swr curves of the various manufacturers, I finally opted for the Wilson Systems, Inc., System 33 (formerly System Three). After having purchased a Wilson WV-1 four-band vertical, I have come to accept that Wilson's swr curves were not only the most desirable, but also the most believable. The published curves indicate that the System 33 is a reasonable compromise for the amateur who wishes to work both the CW and phone portions of the

10-, 15-, and 20-meter bands.

## Mechanical Construction and Assembly

Like the WV-1 vertical, the System 33 is well constructed mechanically. The boom is 14' 4" long, 2" in diameter, and comes in three sections which fit together and are held in place with heavy-duty zinc-plated muffler clamps. From the consumer's point of view, the three-piece boom is a blessing; it allows for a compact shipping carton which can be reasonably handled by UPS (truck shipments of other beams have cost twice as much to ship for about the same weight class).

When assembling the boom, I would advise that the simple addition of a bolt or heavy sheet-metal screw at the junction of each boom section be made. This should be done in order to keep the boom from twisting in heavy winds, as the muffler clamp U-bolts are not threaded far enough to snug the sections together adequately. The center section of the boom which clamps to the mast is double-wall aluminum tubing and a striking example of Wilson's mechanical overkill. The boom is attached to the mast (not supplied) with a 1/4"-thick aluminum plate and 8 heavy muffler clamps.

Unlike other moderately-priced beams, the System 33's elements are heavy-duty, tapering from 1 1/4" where the elements meet the boom to 5/8" at the ends. The dual-section traps are affixed to the elements at approximately 32 inches from the ends of the elements. Despite their large size, there is very little droop to the elements. Each trap is clearly identified with a sticker which indicates director, driven element, or reflector and has an arrow to indicate the direction toward the boom (little chance for error here). The director and reflector are attached to the boom with a unique one-piece extruded aluminum clamp which fits around the boom. When the clamp is tightened, equal pressure is applied in all directions around the boom so that boom

20 Meters		15 Meters		10 Meters	
MHz	swr	MHz	swr	MHz	swr
14.025	1.3:1	21.025	1:1	28.025	1.1:1
14.100	1.1:1	21.100	1.1:1	28.500	1.9:1
14.200	1.1:1	21.275	1.3:1	28.600	2.1:1
14.250	1.3:1	21.350	1.3:1		
14.300	1.5:1	21.445	1.4:1		

Table 1. Swr readings for the System 33 adjusted for the CW portion of the bands.

Band (MHz)	14, 21, & 28
Maximum power input	legal limit
Gain (dBd)	8 dB
Vswr at resonance	1.3:1
Impedance	50 Ohms
F/B ratio	20 dB
Boom (o.d. x length)	2" x 14'4"
No. of elements	3
Longest element	27'4"
Turning radius	15'9"
Maximum mast diameter	2" o.d.
Surface area	5.7 sq. ft.
Wind loading at 80 mph	114 lbs.
Assembled weight (approx.)	37 lbs.
Shipping weight (approx.)	42 lbs.
Maximum wind survival	100 mph

Table 2. Manufacturer's specifications.

flattening does not occur. The clamp which holds the split-dipole driven element in place is similar to the clamps used on other popular beams and seems more than adequate mechanically and electrically.

Element sections are joined by one-piece aluminum clamps which provide for good electrical bonding and effective mechanical holding ability because the element sections will dimple slightly when tightened. The dimples will prevent element sections from sliding out of place.

The antenna is fed at the center of the split-dipole driven element with 50-Ohm coaxial cable such as RG-8/U, and there are no matching sections to adjust or stubs to tune. Resonance is set by adjusting the length of the driven and parasitic elements according to the dimensions given in the instruction manual. A balun (1:1 impedance ratio) may be used if one wishes, but it is not necessary.

#### Electrical Characteristics

A definite advantage of the System 33 over other triband

beams is the broadband response of the antenna. It is possible to work almost all of the CW and phone portions of the three bands while maintaining a reasonably low standing-wave ratio. My primary interest is CW and the lower portion of the phone band for DX purposes, so the antenna was adjusted for the CW setting. Table 1 illustrates the swr response for the System 33 at 33' above ground. With regard to swr, the results obtained were better than the data published by the manufacturer. See Table 1.

Although it has not been tried at my QTH, I believe that the response values listed in Table 1 could be improved by shortening the dimension of the adjustable part of each element by about 1 to 2 inches less than the CW setting. Despite the somewhat high swr on ten-meter phone, it appears that the beam is more broadband than most of the tribanders I have had the opportunity to own or work with.

#### Results and General Conclusions

On-the-air results have been

gratifying. With regard to forward gain, results indicate that gain is at, or near, the published 8-dB value. The subjective difference between the System 33 and my three-element monobander for 20 meters is minimal. The front-to-side ratio is excellent, with a clear null heard when the antenna is positioned 90 degrees off the desired heading. The only major difference between the System 33 and the monobander is in the area of front-to-back ratio. The front-to-back ratio is at least as good as other triband beams, though.

All things being considered, I can highly recommend the Wilson System 33 for its superior mechanical construction, the ease with which it can be assembled, and its true broadband response. The System 33 is an excellent value and a wise choice. *Wilson Systems, Inc., 4286 S. Polaris Avenue, Las Vegas NV 89103, (702)-739-7401; toll-free order number is 1-(800)-634-6898. Reader Service number W33.*

Lawrence W. Stark K9ARZ  
Saint Charles IL

#### NEW BEARCAT® SCANNER HAS OVER 2,000 FREQUENCIES IN MEMORY

The development of a new scanning monitor radio with over 2,000 pre-programmed frequencies, plus 50 user-programmable channels, has been announced by Electra Company. Named the "Bearcat® 300 Service Search," the new radio features the convenience and simplicity of advanced programmed scanner technology. By pushing a single button, the radio will search the actively assigned frequencies for the service selected. This feature completely eliminates the need to know in advance the frequencies for the most-listened-to services. The Service Search has 11 different services: police, fire, marine, "ham," mobile phone, emergency, government, forestry, business, ground transportation, and even air-to-ground aircraft channels. In all, there are 2,138 frequencies pre-programmed into the Service Search memory to ensure that the active channels for any local area are covered.

In addition to Service Search, the new Bearcat scanner also features the flexibility of a user-programmable memory. The frequencies for up to 50 channels can be stored or changed in this memory by simple keyboard entry. These frequencies can be in any mix from the 7 VHF and UHF frequency bands covered by the radio, including the AM aircraft band. Lockout, scan delay, and automatic activation of accessories (such as an alarm) can also be individually entered for each of the 50 channels. Ar-

ranged in banks, these channels can be activated or locked out in groups of 10 with a single push-button. Many other operating features are also included in this deluxe radio, including "search" between operator selected frequency limits, hold and resume controls, direct channel access without the need to "step through" channels, scan speed control, plus provisions for a priority override channel.

The clean, professional look of the new Bearcat 300 Service Search scanner features a die-cast front panel which is accented by a vacuum fluorescent digital display. The display, with bright/dim control, offers excellent readability under all lighting conditions. It not only displays the frequency being received, but also automatically shows accurate digital time when the radio is switched off. (If desired, the time can also be viewed when the radio is receiving calls by simply pushing the "time" button.) The radio measures 12¼" wide by 3⅞" high by 7" deep, permitting easy shelf or vehicle installations. Electra Company believes the radio will add a new dimension to the rapidly expanding market for scanner radios, which have already penetrated approximately 5% of US households. The radio is expected to appeal not only to sophisticated scanner users, but also to those who appreciate a unique entertainment product combining complex technology with simplicity of operation. Complete details are available from Bearcat scanner suppliers or by writing directly to *Electra Company, PO Box 29243, Cumberland IN 46229. Reader Service number E40.*

#### CHECKING OUT THE CLEGG AB-144 ALL-BANDER

I'm a sucker for every new transceiver add-on, accessory, and gadget. My most recent acquisition of this nature is the Clegg AB-144 All-Bander receiving upconverter, which I purchased for use with my two fixed-station 2-meter multi-mode transceivers.

The AB-144 is a novel frequency-range extending device that should be of interest to amateurs who would like to expand the coverage of their VHF set. The Clegg unit converts your present ham-bands-only transceiver to a continuous-coverage receiver that spans the spectrum from LF (100 kHz) to 30 MHz with no gaps. Because it works ahead of the set's rf and i-f stages, it covers this frequency range with sensitivity, selectivity, tuning rate, calibration accuracy, and mode selection (SSB, AM, CW, etc.) essentially as estab-



New Bearcat® 300 Service Search.

Band	Tuning Range
1	0.1-4 MHz
2	3.0-7 MHz
3	7.0-11 MHz
4	11.0-15 MHz
5	14.0-18 MHz
6	18.0-22 MHz
7	22.0-27 MHz
8	26.0-30 MHz

Table 1. Tuning ranges.

lished by your existing rig.

Although the unit was not yet available when the first ads appeared in early spring, it took Clegg less than one week to get the AB-144 to me by UPS when I placed my order this summer. Upon unpacking the 2-lb. unit (which came in a securely wrapped and padded box), a quick scan of the 3-page operating manual provided all the instruction needed to connect the upconverter to my Yaesu FT-221R transceiver.

A 110-volt, 100-mA, plug-in, ac-adaptor-type power supply is furnished, and it's more than adequate to supply the 12 V dc @ 30 mA required by the AB-144, though you can also tap into the transceiver's dc supply if you like. I found that two additional connections, in addition to the power supply cable, had to be made. The first was the output line to the transceiver, which was made by means of a short length of RG-58 cable terminated in PL-259 connectors (user-supplied). A jack is also provided on the rear panel to connect a suitable LF/HF antenna. (A single wire will normally do fine, or if your transceiver has a separate antenna/receiver jack, you may be able to use it as a handy spot to feed in the upconverter's output.)

Hooking up the two rf cables and the power cord put the AB-144 in operation. There was one final step, however. I took the precaution of removing the microphone from the transceiver to prevent the accidental pumping of 2-meter rf into the AB-144—an easy thing to do if you later forget that the unit is connected. Although the upconverter is internally protected against such an unfortunate occurrence, this added measure will prevent possible damage to either piece of equipment.

I found that the Clegg unit did what the advertising literature claimed it would do. It nicely extended the range of my FT-221R down to 100 kHz, making the purchase of a high-quality all-band communications receiver of marginal value, especially considering the relatively low cost of the Clegg upconverter (\$129.95) and the high cost of top-quality receivers in today's market.

Specifically, the specs call for 0.3 microvolt sensitivity (on SSB and CW) and a  $\pm 3$  kHz ( $\pm 1$  kHz typical) frequency calibra-

tion accuracy. Selectivity is equal to that of the transceiver with which it is used. While I did not measure the sensitivity, it seemed to be at least equal to my Tempo 2020 on the ham bands and my Yaesu FRG-7 over the full range of 100 kHz to 30 MHz. Calibration accuracy was found to be close to the  $\pm 1$  kHz figure. Frequency stability was excellent; no trace of drift or instability was noticed with movement of the cabinet.

Overall results you can expect to obtain with the AB-144 depend almost completely on the transceiver you feed with the upconverter's output. When using the unit with my FT-221R, which is also equipped with an outboard YC-221 digital readout display, it was a real convenience to have both analog and digital frequency display on all bands, especially the crowded AM broadcast and shortwave bands. FM and SSB reception was excellent, mainly because the Yaesu transceiver is primarily designed for these modes. CW reception was broad, as expected, due to the transceiver's i-f passband characteristics, though addition of a sharp active audio filter (such as those sold by MFJ, Autek Research, Datong, and others) would easily narrow the effective passband for better CW reception. AM reception results were marginal because the FT-221R's i-f filters are designed for SSB, having a too narrow 2.4-kHz bandwidth. The narrow AM selectivity results in some distortion, bassiness, and low audio recovery on received signals. While AM reception was usable on my transceiver, this problem might prove detrimental to avid broadcast-band and shortwave listeners. Again, this is not a problem of the converter, but of the transceiver with which it is used. If you intend to use the AB-144 with your present VHF gear, you may want to modify the set's i-f passband to broaden its AM response curve.

It also took a little "getting used to" and some rapid mental gymnastics to calculate how each of the eight band segments are upconverted to 144-148 MHz. Each band is 4 MHz wide (corresponding to the width of the 2-meter band), except the first band, which is only 3.9 MHz wide—remember, the set only goes down to 100 kHz, not 0 kHz. The bottom of each of the upconverter's eight bands is heterodyned up to 144 MHz by means of eight separate crystal oscillator circuits; the conversion process is worked upwards from there. For example, to receive a BC-band station at 1060 kHz, set the bandswitch on the AB-144 to band 1 (.1-4 MHz) and tune the transceiver



Clegg's AB-144 All-Bander.

to 145.060 MHz. Or, to receive a 3900-MHz signal, set the switch to band 2 (3-7 MHz) and dial in 144.900 MHz on the transceiver. This process can be confusing, with either analog or digital displays (especially the latter) until you get the hang of it. The complete tuning ranges are shown in Table 1.

I also tried out the AB-144 with my KLM 2700 transceiver, which has both a vfo (with an analog display) and a digital readout controlled by a 3-knob digital synthesizer. I found the analog display easy to work with on this set, especially since the 2-meter band was split into four 1-MHz ranges which coincided nicely with the upconverter. But the digital synthesizer—with its 3-knob tuning divided into 1-MHz, 100-kHz, and 10-kHz frequency increments and its resultant inability to directly dial in frequencies other than in 10-kHz steps—was just "too much" to get used to. However, the synthesizer was great for BC-band DX-ing, where most channel separations in North and South America are pegged at 10 kHz; you can set up the synthesizer and whip through the band at exact 10-kHz intervals with ease.

SSB and CW reception was good on the KLM 2700, about the same as on the FT-221R, and AM was a little better on this rig. (Some transceiver manufacturers recognize the AM reception problem and make available information on how to improve reception. KLM, for example, has issued a technical bulletin on the 2700 which shows how to broaden the AM-mode response curve for improved AM signal quality. The modification they suggest for the 2700 involves only two components, a resistor and a capacitor. I installed the modification on my set and found reception quite acceptable on the standard and shortwave broadcast bands.) Clegg mentions that the

AB-144 is designed for use with the FT-225, TS-700, and IC-211, in addition to the two transceivers with which I used my unit.

What was inside the attractive 5¼" x 2½" x 6" Ten-Tec-style enclosure? The instruction manual didn't provide a clue, and no schematic diagram or servicing procedures were included (Clegg warrants the unit for 1 year and expects that you'll send the device back to them for repair). I was disappointed in not having been provided a diagram, so I peeked inside and found a small rectangular circuit board holding a 10-transistor circuit, with separate oscillators for each of the eight bands. Although it's not necessary to perform any internal adjustments or alignment unless components have been replaced and repairs made, I managed to touch up each oscillator's tuning slug to bring the frequency calibration accuracy under 1 kHz on all bands and to slightly peak up the unit's output. In examining the AB-144, I found workmanship to be good throughout.

Is it worth it? Yes, especially when compared with the alternatives of buying a separate general-coverage receiver or another of the recently-introduced upconverters designed to capture this wide-open market. I was impressed by the Clegg unit's very few birdies and images, its good calibration accuracy and resetability, and its reasonably consistent performance over each band and from band to band. You do have to be careful with overload, however. Cross-modulation is not as much of a problem (though there was a trace on some close-by BC stations), but overloading the transceiver on strong signals was. This is because there is no tie-in with the transceiver's agc circuit. This means that you do have to do some manual rf gain control riding, especially on SSB and AM, for best results. Also, I

found that the external ac adapter power supply furnished with the AB-144 produced a small amount of hum on stronger signals; hooking into the transceiver's dc supply cured the problem. Too, I would recommend that Clegg add a small LED indicator to let you know that the unit is on; unless you're hooked into your set's power supply, it's easy to forget to turn off the upconverter when you turn off your rig.

Finally, you need to be careful not to zap the converter with a healthy dose of rf from your set, as I've indicated. Installing a coax switch at your transceiver's output connector will allow you to conveniently switch from converter to normal transceiver operation. A coax relay could also be used, but that would require going inside the AB-144 to arrange switching.

All in all, the Clegg people have produced a handy, useful accessory to be used with the thousands of all-mode VHF transceivers in operation today. I should also mention that Clegg has now introduced a similar upconverter, known as the MD-28-9, which transforms your ham-bands-only HF transceiver or receiver to a wide-range 100-kHz-to-18-MHz unit. With this unit, the received signals are heterodyned to the 10-meter band rather than to 2 meters.

In my opinion, the AB-144 is a real jewel that is well worth its price tag. It's an especially attractive purchase for the ham

newcomer who entered the hobby from CB radio and who invested first in a 2-meter rig, rather than a shortwave set. Besides providing a good auxiliary receiver for my shack, the Clegg unit will be a welcome addition on my vacation trips to enable me to monitor HF with the 2-meter rig. *Clegg Communications Corp., 1911 Old Homestead Lane, Greenfield Industrial Park East, Lancaster PA 17601; (717)-299-7221. Reader Service number C3.*

**Karl T. Thurber, Jr. W8FXJ4  
Ft. Walton Beach FL**

#### RADIO SHACK CORDLESS TELEPHONE

Now available from Radio Shack is the DuoFone ET-300 Cordless Push-button Telephone with an operating range of up to 300 feet from the base unit. It has a universal dial system for compatibility with both electronic push-button and mechanical dial telephone systems.

The ET-300 can be installed simply by plugging the base/recharger into a 120 V ac outlet and a modular phone jack—no other wiring is required.

A special feature of the phone is Auto-Redial, for one-button redialing of the last number called if it was busy or did not answer. A call push-button lets you signal the handset from the base with a tone signal.

To answer or make a call on the cordless handset, flip the talk switch and raise the antenna. To hang up, lower the antenna.



Radio Shack's ET-300 Cordless Telephone.



Trac's TE284 Deluxe Message Memory Keyer.

The base/recharger is 8 $\frac{1}{8}$ " x 7 $\frac{1}{8}$ " x 2 $\frac{3}{4}$ " and includes a built-in modular jack for your regular phone. The handset is 2 $\frac{1}{2}$ " x 6 $\frac{3}{4}$ " x 1 $\frac{1}{4}$ ".

For further information, contact *Radio Shack, 1300 One Tandy Center, Fort Worth TX 76102.*

#### TRAC DELUXE MESSAGE MEMORY KEYS

Trac Electronics, Inc., has introduced a new, completely CMOS, state-of-the-art, Deluxe Message Memory Keyer, the Model TE284. Containing all CMOS integrated circuitry, the Deluxe Message Memory Keyer contains three choices of message storage: two-message capacity (50 characters each), four-message capacity (25 characters each), or one 50-character message and two 25-character messages. The keyer can record at any speed and the message can be replayed at any speed. A memory operating LED tells when the keyer is in the memory function. The three choices of memory operation make the Model TE284 ideal for both daily QSOs and contests. In addition to the message functions, the keyer contains both dot and dash memory keying, iambic keying, 5-50 wpm, speed, volume, tune, tone, and weight controls, as well as a sidetone with speaker. The Model TE284 keys both negative- and posi-

tive-keyed rigs. *Trac Electronics, Inc., 1106 Rand Building, Buffalo NY 14203. Reader Service number T18.*

#### ICM INTRODUCES NEW GROUND STATION SATELLITE RECEIVER

A new low-cost satellite receiver, covering all channels 3.7-4 GHz, is now being manufactured by International Crystal Mfg. Co., Inc., Oklahoma City.

The TV 4200 receiver is fully tunable and provides standard dual audio outputs of 6.2 and 6.8 MHz, with other outputs available. The receiver has a built-in LNA power supply, and output levels are compatible with video-monitor or VTR input.

For further information, contact *International Crystal Mfg. Co., Inc., 10 North Lee, Oklahoma City OK 73102. Reader Service number I48.*

#### RAPID MOBILE CHARGER

With the current trend toward using hand-held transceivers for mobile operation, keeping the hand-held batteries charged has become a problem. DebTed Engineering has solved this problem with a new line of 12-volt-operated rapid chargers for amateur and commercial use. Available exclusively through Debco Electronics, the rapid charger units are equipped with a cigarette lighter plug on the in-

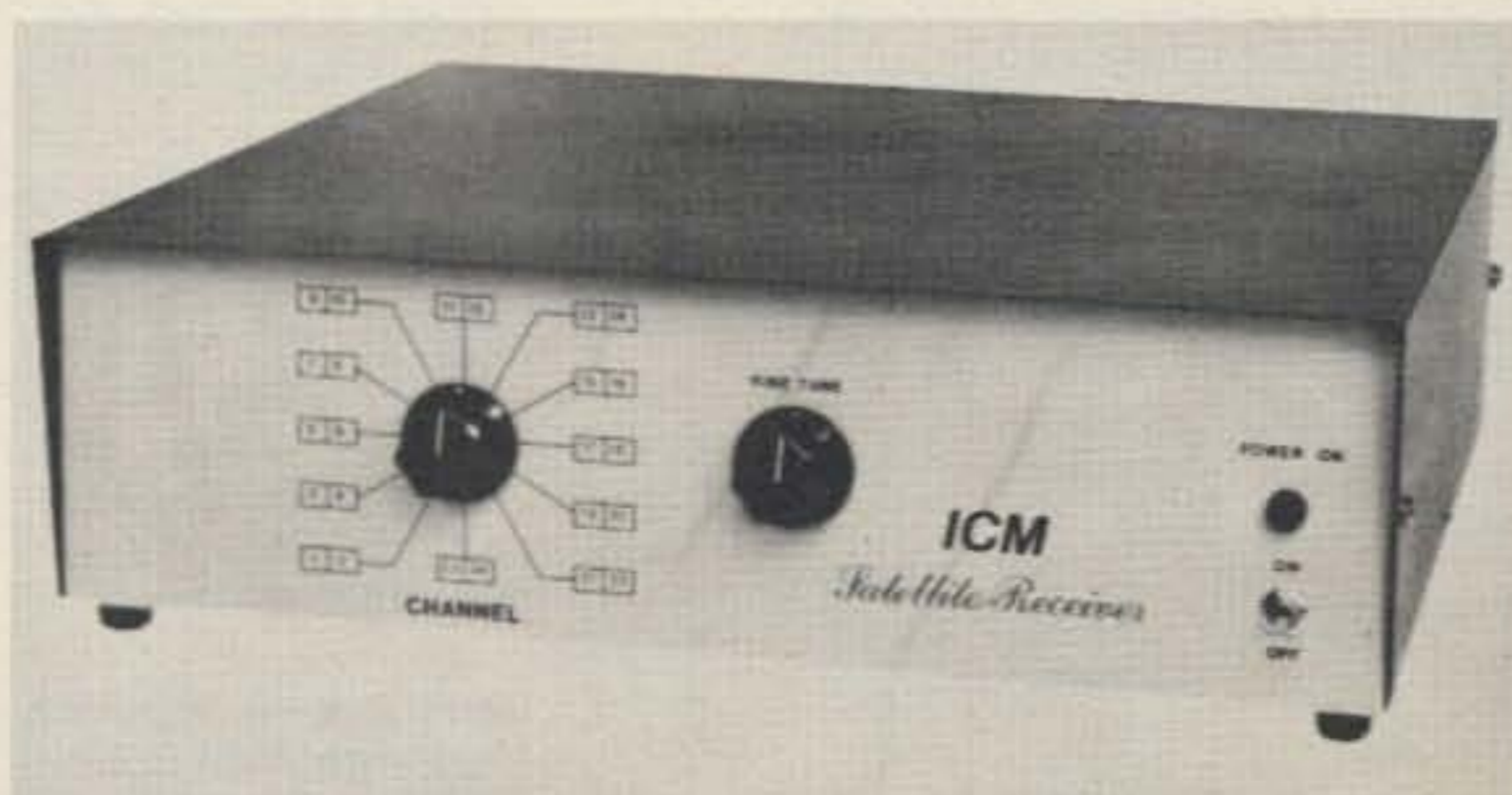

ICM's satellite receiver.

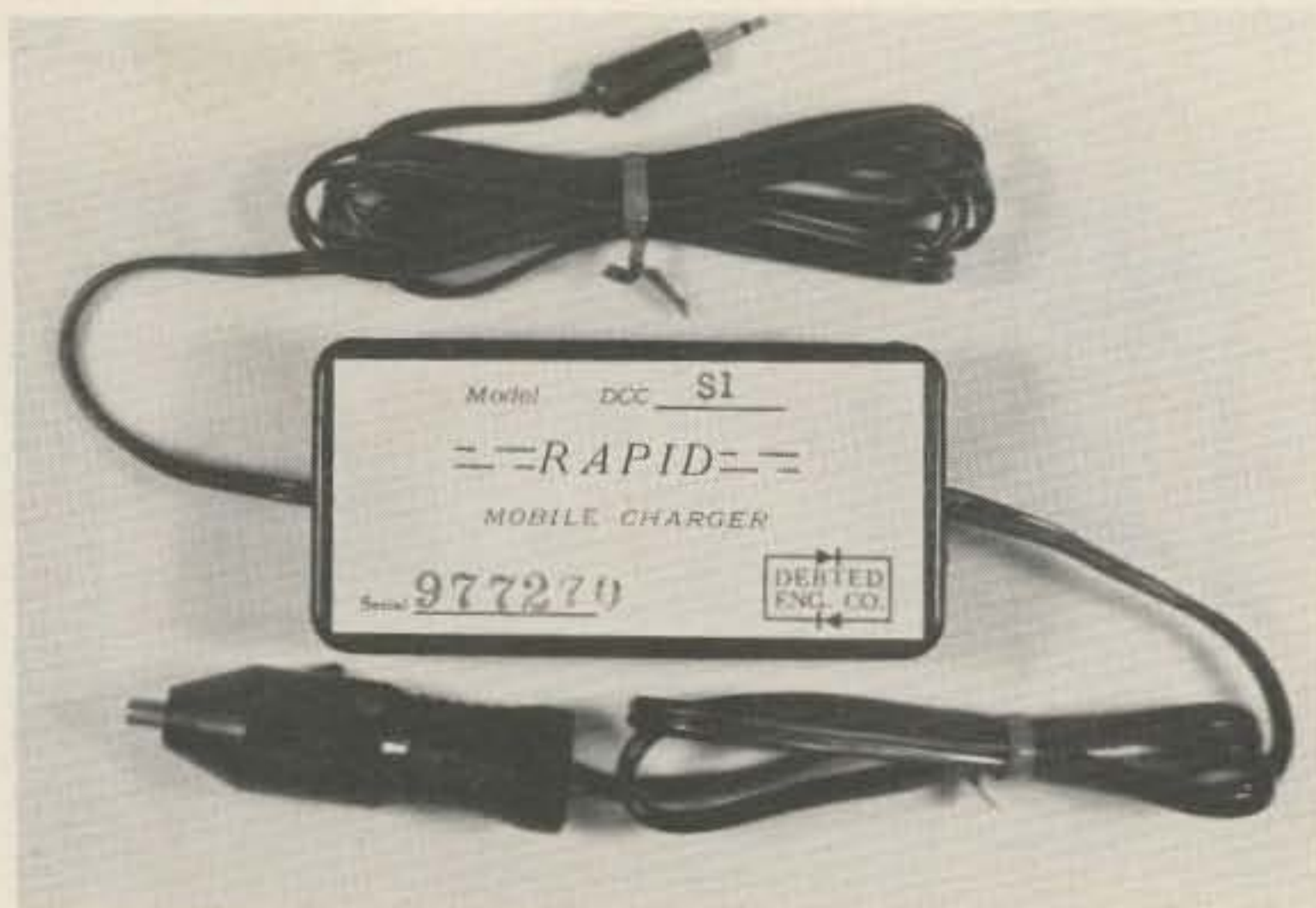

Debco's Rapid Mobile Charger.

put side and an appropriate charging plug on the output side. Models are currently available for the Tempo S-1, Wilson Mark II, and Wilson Mark IV. The charger will rapidly charge a fully discharged good battery in 4-6 hours and may be used during transmit, receive, and off periods. Furthermore, it will not damage batteries if left connected for prolonged periods of time, due to automatic shut-off circuitry. *Debco Electronics, PO Box 9169, Cincinnati OH 45209.* Reader Service number D68.

#### HAMTRONICS' UHF FM EXCITER KIT

Continuing in their tradition of making professional quality transmitter and receiver modules, Hamtronics, Inc., has announced a new UHF FM Exciter Kit. The model T450 is rated at 1 Watt for continuous duty, which makes it an ideal unit for repeater and control link service.

Features include low-imped-

ance dynamic mic and receiver audio inputs; crisp, clear modulation; low spurious output; and built-in test points for easy alignment. The unit is designed on a 3" x 5 1/4" PC board and uses both individual coil shields and compartmental shielding. Double-tuned circuits are used for low spurious output, and decoupling uses ferrite beads and resonant bypasses for stability.

For further information, contact *Hamtronics, Inc., 65F Moul Rd., Hilton NY 14468; (716)-392-9430.* Reader Service number H16.

#### NEW KEYSER USES OPTOISOLATORS

An advanced-design electronic keyer employing optoisolators for key isolation has been introduced by Curtis Electro Devices, Inc. Based on the popular 8044 single-chip circuit, the EK-480M features a direct meter readout of code speed in wpm. Measuring only 7" x 4 1/2" x 2 1/2", the unit features dot and dash



The EK-480M keyer from Curtis Electro Devices.

memories, iambic or standard mode operation, internal 117 V ac or battery supply, internal sidetone and speaker, front-panel volume, pitch, weight, and speed controls, and an accessory socket for soon-to-be-announced message memory, Instructo-Keyer, and keyboard keyer add-on units. The unit will key  $\pm 300$  V dc at up to 200 mA.

For additional information,

contact *Curtis Electro Devices, Inc., Box 4090, Mountain View CA 94040; (415)-494-7223.* Reader Service number C90.

#### THE ISOPOLET™ CONT.

We should have noted in our October issue (p. 167) that AEA's new ISOPOLET™ is indeed a VHF antenna. Versions are available for 2m and 220 MHz.

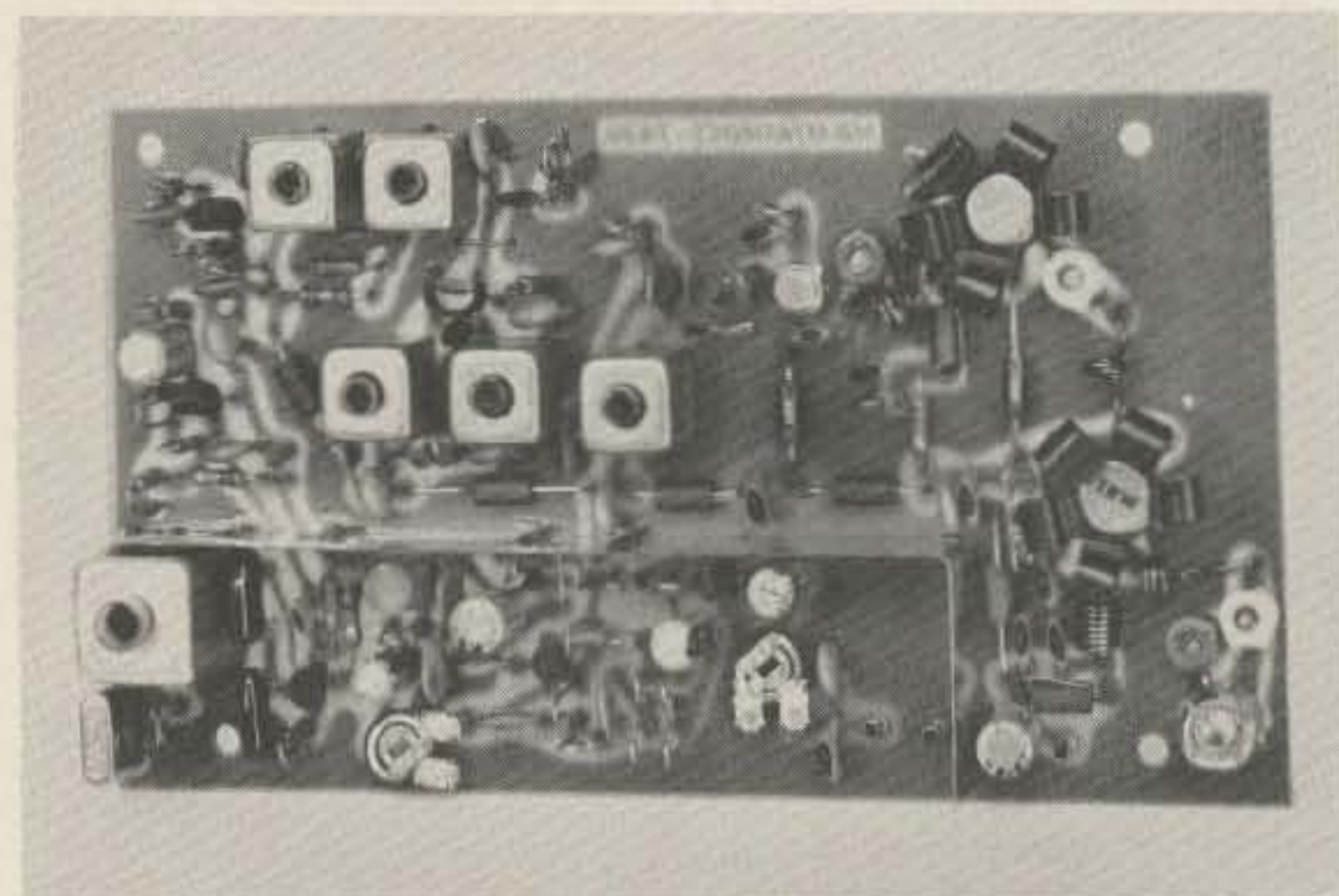

Hamtronics' UHF FM Exciter.

## Ham Help

I have recently come into possession of an Elmac receiver, Model PMR-6A. I have not been able to find any info on this unit. I do not have the power supply, but I understand that it was a mobile unit.

I need a schematic for the unit and a list of the voltages needed for operation so a power supply can be assembled. I will appreciate any help and will happily reimburse copying and postage costs involved. Thank you.

**Paul Uhlig K0MD**  
1342 Estate Ct.  
Wichita KS 67208

I have an xtal XCB-4 AM CB radio and I would like to convert

it to 10 meters. Has anyone made this conversion? Can anybody help?

**John S. Lee KA4EPR**  
17401 N.W. 20th Ave.  
Miami FL 33055

Carthage High School is organizing a club, and we desperately need any junk or articles collecting dust. Anything would be appreciated: books, magazines, spare parts, wire, coax, old repairable transmitters or receivers, etc. We will gladly reimburse postage or shipping.

**Jerry Reeves WD5IMA**  
Carthage High School  
PO Drawer D  
Carthage TX 75633

I am in need of a circuit diagram and manual for an Allied A-2515 receiver. I would certainly pay any copying costs, and it will help a future ham get on the air.

**Robert Napoli K2LGO**  
Box 158  
Riverhead NY 11901

The Wells High School Amateur Radio Club is a new organization that needs help. We have a group of interested students, three co-advisors, and not one speck of equipment.

The group is now raising money for an equipment fund and working on a vocational education grant application, but we are wondering if someone might be willing to either donate old gear or place gear with the club on loan, until the club can afford to buy its own rig.

The club would be more than

willing to pay shipping costs or, if practical, pick up equipment in the coastal Boston/Portland area.

**David W. Rotthoff**  
Amateur Radio Club  
Wells High School  
Wells ME 04090

I would like to find out about the existence of any Bible study nets or round tables to help my study of the word of God. Thank you.

**Gary L. Anderson WB0GWP**  
1528 34th St. S.E.  
Cedar Rapids IA 52403

I would like to hear from someone who has successfully interfaced the IF-1 regenerative repeater (73, November, 1978, p. 254) to an ST-6000.

**A. Ustal WB4TRJ**  
180 Arlington Rd.  
West Palm Beach FL 33405



from page 30

quency, that is, on the frequency of his last station worked. Either a remote vfo on your transceiver, RIT (receiver incremental tuning), or a separate transmitter and receiver is required. Any of these setups will accomplish the goal.

First, tune in the DX operator and listen while he works one or two stations, to establish in your mind what his operating pattern is. Books and articles have preached this simple rule for decades. When your radios are warmed up and tuned up (off the air, naturally), get ready to put your transmitter on the proper spot. When the DX turns it over to someone, find that someone and put your signal just slightly off his frequency—off a matter of Hertz, *not* kilohertz!

That's all there is to it. When you call, your signal should be right where the DX station's receiver is tuned, and he will hear you without touching his receiver tuning knob. If the DX operator is getting calls by carefully listening for "tail-enders," you have no choice but to play his game and tail-end yourself. Tail-ending means giving your call, or just your suffix, at the very end of the transmission of the station who is signing off with the DX. A very skilled operator can pick out parts of callsigns from tail-enders and can keep a string going without ever saying "QRZ?" or whatever. Mostly, however, tail-ending degenerates into a mob scene. *Never* use the technique unless the DX station encourages it, and even then only if it is working.

It's difficult to not feel smug after finding a pileup, observing the poor slobs who call and call but never figure out what is happening, then make one or two quick calls yourself, exchange reports, and tune away looking for more rare QSOs, while the same pileup goes on and on. There's something more training classes should teach: It's called using your head. Put yourself in the shoes of the DX station you want to work. Think like he does and you will invariably call at the right time on the right frequency. Otherwise, you can call all night.

### 160 METERS

December is the time to talk about our lowest frequency band, since the winter months are to 160 as the summer months are to sporadic "E" skip on VHF. Many modern rigs

cover 1.8 MHz, and the amateur magazines have had their share of tips the last couple of years on how to put a signal on 160 when only modest real estate is available. A dipole is 270 feet long, a fact which constrains most of us. But there are ways!

Many have become interested in 160 since the hundred-country barrier was broken a couple of years ago. As we recall, W1BB actually had the magic century figure some time before, but a few of the countries were "pre-War" and didn't count when the ARRL decided to offer a 160 endorsement to DXCC. By 1979, several have made this achievement level. Now most expeditions to rare spots include 160-meter coverage, as well as 6 meters and OSCAR. When one has worked his fill of Europeans or JA stations on 80, 160 becomes the natural band to which to gravitate for more thrills.

DX on 160 is found primarily in the "window," 1825-1830. Do *not* transmit in this segment unless you are outside of the US and Canada. The DX will specify a listening frequency around the bottom edge of the band, 1800-1805. Pacific island stations such as Hawaii will transmit near the top edge of the band, as will JA stations. Send an SASE to the ARRL and ask for their special chart of 160-meter allocations, which includes information on how much power you can use at various times of day and night in different regions of the US.

Six-Band DXCC, anyone? (It's been done!)

### MAILBAG

KV4FZ reminds us that he was the first operator outside the 50 states to make WAS on 160 meters; PY1RO, mentioned in this column last July, was the first station outside North America to accomplish the feat. Herb KV4FZ has also confirmed 100 countries on six different bands, 160-10 meters.

A nice letter came from Cliff Sides KX6SC, who, along with Ed Williams KX6SA, has been keeping the Kwajalein Atoll active. They have been on 6 meters, with consistent openings to Japan, Hawaii (2000 miles NE of KX6), Guam, the Solomon Islands, Papua-New Guinea, and Jordan. Some openings to Australia and New Zealand have also occurred.

Their best time on 50 MHz, where they hang out around 50.110, has been 0900 to 1200 UTC. If you can hear KH6 stations this winter, you may work

a real rare one if the skip runs to KX6.

Here's how Cliff summarizes the low-band openings:

**10 Meters:** Open from Kwajalein sunrise to sunset (1800-0600 UTC); Europe comes in first, followed by stateside and VK, then Japan at night between 0600 and sunrise.

**15 Meters:** Open sunup to sundown, very similar to 10.

**20 Meters:** Best openings to the US occur between 0300 and 0800 and again between 1100 and 1500. Europe is very good between 0500 and 2200.

**80 Meters:** Propagation to the US peaks about 1400, Europe slightly later. East-coast US stations have the best shot at this part of the world at their sunrise on the east coast, about 1200 UTC in the winter.

The first expedition to VK9 (Cocos-Keeling) in some time took place September 18 and 19, 1979. VQ9s JJ, KK, and MR (yes, the same one mentioned in Novice Corner) started out by having their plane delayed 24 hours. They finally arrived on Cocos Island (about 1500 miles from their homes on Diego Garcia) and fired up at 0830 UTC on the 18th.

Their next problem was dead bands. Our active sun, responsible for the excellent propagation on the bands these days, greeted the Cocos group with the residual effects of a solar flare. The bands came back to life a little toward the end of their two-day stay, but working them from stateside, for example, was no picnic.

In 30 hours, the trio did manage some 2200 contacts, almost all on 15 and 20 meters. For those who missed this one, there's good news: VQ9JJ and VQ9TR are talking about going back early in 1980, with a beam antenna this time.

August, 1979, was a banner month for expeditions. Manihiki (Northern Cooks chain) Island was represented by no less than two different groups. K0SVW provided a report on one, which signed ZK1AM. Other operators were W0WP, K0EVE, and ZK1DR; they made 15,000 contacts on 80-10 meters. W0WP is handling QSLs, which were supplied by Collins Radio.

ZK1AM was on the air August 18-25, using a pair of IC-701s, an FTDX-400, and loaned TH3 Hy-Gain beams and DenTron amplifiers. Expenses for the operation, including a six-day boat ride each way, totaled twelve thousand dollars, which was paid by the participants. If your group is interested in seeing the slide show and talk on this interesting adventure, contact Dr. Steve Towle K0SVW, 214 N. 34th Avenue East, Duluth MN 55804.

September's Hurricane David devastated the island of

Dominica in the Caribbean. David wiped out all communications there except for amateur radio. J7DAY was all alone for the first few days and provided all government-to-government communications for relief operations.

J7DAY was joined by KP2A (American Virgin Islands) and W0DX. They set up at a Red Cross headquarters first as KP2A/J7 and then as J73A. W4UY joined them later. As things got in order, J73A was able to do some casual operating; if you worked them and would like the special QSL card, send yours with an SASE to K2TJ.

As you read this, the Indian Ocean-Africa expedition by N2KK, K5CO, and N5AU should be in full swing. Their itinerary includes 3B7 and 3B9, Glorioso and Juan de Nova, and then Mayotte and 5R8 (Malagasy Republic). After that, N2KK hopes to get into Somalia (6O) solo.

Dave N2KK is a professional photographer who has traveled extensively throughout the world (to more than 100 countries). He will be taking many photos during the expedition and will undoubtedly be prepared for the "convention circuit" upon his return.

If you worked KP4AM/D (Desecheo) last spring, you might want to send your QSL now to David Novoa KP4AM, PO Box 50073, Levittown PR 00950.

VE3FXT should be operating from Thailand by now, after getting in some air time from HS4AMA while awaiting his own callsign. Also active from there, of course, is Fred Laun HS1ABD. Fred listens for stateside and Canada on 3517 at 1130 daily.

The December issue of CQ magazine, a publication which has been quite DX-oriented over the years, is the first under the new management of K2MGA, K2EEK, and W2LZX. Among other things, CQ has sponsored the Worldwide DX Contest, the WPX (prefix) contest, and a 160-meter contest, not to mention an awards program, including the USA-CA (US counties) award. It is expected that CQ's emphasis will continue mostly unchanged, at least for the time being.

With the departure of Chuck Stuart N5KC as editor of this column, new authorship begins with this issue of 73. Please send your input c/o 73, Peterborough NH 03458. And thanks from all DXers to Chuck Stuart for the excellent work he has done with the column during the past year!

Most of the information for this column came from *The DX Bulletin* (Vernon CT 06066). Thanks.

# Looking West

from page 18

and other "radio tricks" and increased lawlessness.

## Where Are We Headed?

As this lawless group becomes larger and more powerful, it will become more fearless. It will also become more sophisticated in the "art" of raising hell via radio technology.

Please realize that the driving force of this group is an ego trip based on the power they can apply to other parts of society. Also, be aware that this sort of ego trip *can never be satisfied*. That is to say, once they have their way with the ham bands, they will begin to turn their eyes (egos) to other targets.

What targets might these be? What with scanners in abundance, targets are very easy to find. What about mobile radio services, taxis, fire, police, etc.? I can imagine thinking like the following:

"Wouldn't it be a lot of fun to study the fire frequencies and learn how to get around their security systems and send half of the LA Fire Department out on a wild-goose chase? Wow! That was fun. Next week, let's fake LAPD into another Watts riot!" Or, "Let's talk to a 747 pilot coming into LAX and burn his ears!"

The technology is not too difficult for this group of lawless people. They already know how to put a synthesized 2m transmitter well outside its design band limits. They know the frequencies that many services and individual agencies use. They know a great deal more.

I don't wish to be disrespectful of the FCC and its abilities, but I feel it would take quite a while to nail someone who is doing the things I project above. Meanwhile, the FCC receives a tremendous black eye, and society will pay a large bill in monies, property, and maybe lives.

## What To Do?

It seems to me there are several choices:

1. Do nothing. Result:
  - Eventual anarchy within the whole radio spectrum.
  - FCC in total disgrace.
2. Vigilante action. Result:
  - People hospitalized.
  - Houses burned.
  - Innocent parties hurt.
  - "Good" people (vigilantes) sued and hurt.
  - FCC gets black eye.
3. FCC participation in restoring law and order to the ham bands. Result:

- Stop anarchy before it spreads further into the non-ham parts of the spectrum (where the FCC would not have a vast army of hams to help with the clean-up).

- Cooperation from those of us hams who have developed RDF skills and equipment. This will aid the FCC in its work.

- Restoration of what is probably the most effective weapon of all—peer pressure in the form of fear of exposure to the FCC.

- FCC gains respect and stature.

\* \* \* \* \*

The only question left is: "When will the tide begin to change back in the direction of collective decency?" Maybe the shift has already begun.

## BYE-BYE, MISS AMERICAN PIE DEPARTMENT

On September 6th, the FCC acted to suspend, pending revocation action, both the operator's and station license of Scott Lookholder WB6LHB of Los Angeles, California. Earlier this year, Lookholder had entered a guilty plea in federal court on a number of counts in an indictment charging him with the use of "foul and abusive language" while operating on the two-meter amateur band. Allegedly using the callsign W6JAM, Lookholder spent many hours making life miserable for the usership of many Los Angeles area repeaters, especially the Mt. Lee WR6ABN repeater.

Ironically, Lookholder was even a member of the DFing committee set up to catch W6JAM, and it was only due to some rather phenomenal detective work by another member of that same committee that he was caught at all. Even after they were sure that Lookholder was their man, they found it hard to believe and spent many hours trying to disprove their "find" before turning their evidence over to the authorities.

The rest you already know. Scott Lookholder was given his day in court, admitted to the charges against him, was sentenced to pay a fine, and was placed on probation. He was also ordered by the judge not to utilize his amateur equipment during the term of the probation. However, though a number of letters were sent to the Commission by area amateurs requesting that Lookholder's license be pulled, the FCC took months to act on the matter. Infuriated, many amateurs charged the FCC with running



Congressman James Corman (left) with Attorney Joe Merdler N6AHU. Both care a lot.

scared of anything that even remotely smelled of First Amendment. Letters to the Commission have gone unanswered, including my own.

In the meantime, the inaction by the Commission on this and other regulatory violations issues helped worsen an already highly volatile situation. The kooks have realized that the FCC is seemingly powerless in this type of matter and have made a field day of it. Filth, racial slurs, character assassination, and hate have replaced normal day-to-day operation on many repeaters. It's even been reported, though not confirmed, that at least one "jamming" club has been formed to further wreak havoc. Carrying their banner of "our way or no way," the kooks have been growing in number and strength. No longer would they hide behind the anonymity of their microphones. Rather, they were proud of who they were and what they were doing. They declared open war on Joe Ham, and Joe was hard put to fight back.

Not every Joe was inclined to sit still and accept the decaying situation, nor every "Jay" for that matter. In what might be considered one of the finest political moves ever initiated within the ARRL, League Southwestern Division Director Jay Holladay W6EJJ convinced the Board of Directors that a *bad* situation did exist and was able to get the Board to pass a resolution which instructed ARRL General Counsel Bob Booth to contact and develop a working guideline with the FCC in handling this type of problem. Jay's next step was to appoint Los Angeles Attorney Joseph Merdler N6AHU as a Special Assistant Director, charged with advising Jay in methods to eliminate this ever-growing

maliciousness that was, by this time, threatening to destroy normal amateur operation.

Through Joe, a meeting was arranged with US Congressman James Corman, Democrat from Van Nuys, California, which Jay and Joe attended. Congressman Corman was briefed on the deteriorating situation, the problems with FCC inaction on these cases, and given a basic education about the amateur service itself. As a result of this meeting in August, Congressman Corman agreed to support the amateur community in its internal house-cleaning effort and said that he would see what could be done through Washington. About two weeks later, I personally interviewed Congressman Corman, and what follows is the text of that interview.

Q: Congressman Corman, what led to your decision to get involved in this matter?

A: All of us who have had little contact with amateur radio are still aware of its importance. I'm occasionally aware due to news items of amateurs who have performed important services during times of disaster, maybe an individual disaster or something that affects a whole community. I was not, until recently, aware that there were some problems. Those problems involve the use of false call letters, interference with the normal use of the airwaves, and some serious cases of obscenity. I have discovered that the FCC appears to be doing little to police the use of the airwaves for amateurs and is potentially diminishing this service which the amateur operator can give to his community.

Q: Congressman, now that you are involved, what direction do you intend to take?

A: Joe Merdler (N6AHU), who is a good, long-time friend of mine

and the new president of the Personal Communications Foundation, has given me tapes to show me what is happening on the airwaves, and I'm going to be sure that the FCC hears those tapes. I hope that will generate some action from them. Also, I'm going to be working with Congressman Van Deerlin, who heads the Communications Subcommittee, which has jurisdiction in this area, to see whether or not we need some statutory change, to make certain that the FCC is doing a responsible job of policing the airwaves.

**Q: Do you feel that the FCC is doing its job in this matter?**

**A:** Evidence I have at the moment would indicate that they are not! For instance, a man was convicted in a court of law of using both false call letters and obscenities, very serious ones interfering with the normal legal use of the airwaves, and yet the FCC was reluctant to take action against him. He may be punished in a civil court or criminal court, but as long as he has the ability to continue to interfere with the normal legal use of the airwaves, then the FCC is not doing its job and I want to find out why.

**Q: I assume you are speaking of the Scott Lookholder matter?**

**A:** Yes.

**Q: Do you feel that the Commission may be running scared of First Amendment issues in this matter?**

**A:** I'm sure that the FCC feels controlled by the First Amendment, but there are things here that go well beyond First Amendment rights, having to do primarily with interference with other people's use of the airwaves, and clearly there are obscenities that go far beyond one's constitutional right. I

know Chairman Ferris and plan to contact him and ask if that's what they're (the FCC) worried about; I want to sort it out and get some legal opinions as to whether or not they can move. It may be that it's something else, and I suspect that something else may very well be that they just get bogged down in the normal bureaucracy and that nobody has paid close attention yet. Maybe I'm wrong and it is something else, but we will find out what it is and try to get to the bottom of it.

**Q: Are you going to bring the Lookholder matter to their attention and try to get action on it?**

**A:** Yes. I want to be sure that it is before the chairman of the Commission. He may have a valid reason for not proceeding. I want to know what that reason is. If it is a valid reason, I will come back and report it to the people involved. If it's not a valid reason, I'll try to see that action is taken.

**Q: What if some of these alleged "bad guys" charge you with violation of their First Amendment rights? Will you still stand behind the amateur community in its housecleaning efforts?**

**A:** The point is that the courts will protect the First Amendment. There is no First Amendment right to falsifying call letters. There's no First Amendment right to blasting obscenities on the airwaves. Admittedly, obscenity is a difficult thing to determine under the First Amendment, but aside from that, assuming that they are saying something very proper, if they're falsifying call letters and if they are intentionally interfering with the normal use of the airwaves, then it's my suggestion that it is *not* their First

Amendment right. I believe very strongly in freedom of speech. Clearly, when you think about the airwaves and their importance, there is the necessity for using them in some reasonable and rational way for all. To use them irrationally, to intentionally jam them, has nothing to do with First Amendment rights in my book.

**Q: I understand that you are going to be coordinating your efforts with the American Radio Relay League through its General Counsel, Bob Booth. Would you care to elaborate?**

**A:** I asked if I could see Mr. Booth as soon as I get back to Washington. I'm hoping that Mr. Merdler will be able to come back as well. For one thing, there are 435 of us in the House of Representatives and we don't want to be running in 435 different directions. That's why it's so important that the association (ARRL) quarterback what's going on, so that we are all moving in the same direction. We need to coordinate a good reference.

\* \* \* \* \*

Less than two weeks after my interview with Congressman James Corman, word reached us that the FCC had acted on the Lookholder case, and since that time, the FCC has apparently been quite busy helping us clean house, not just on two meters, either. Could it be that an overall cleanup of the amateur bands has become an FCC priority? The rumors of almost daily "busts" run rampant, but the FCC refuses to say anything. Following up on such a rumor just this week, Westlink Correspondent Alan Kaul W6RCL called FCC Field Engineer in Charge Larry Guy at the Long Beach field office. How far did he get? Read his final "air copy" here:

#### NEWS ITEM: THE WESTLINK AMATEUR RADIO NEWS EDITION #106

"In Los Angeles last week, another FCC raid was made on an amateur station allegedly involved in illegal transmissions. Officials from the Long Beach field office took part in the action. In a capsule, here's what happened: A signal from an amateur transmitter was jamming a two-meter repeater in the Los Angeles area. Direction-finding equipment led to the location, but no one was home. Westlink has learned that the jamming operation was done by remote control, and that the owner of the station was activating the transmitter by telephone.

"The FCC refuses to confirm or deny the report, and will say only in terse governmentese: 'An inspection was made on Monday, September 10th, but the results of that inspection are not public information.'

"So, we don't really know what happened and can't really be sure who the ham involved was, but it looks like the score from Los Angeles is FCC 2, jammers nothing."

If there is real validity to the rumors, and I have good reason to believe that such is the case, then it looks as if a cleanup of our amateur bands is our Christmas present to ourselves, with a bit of help from the FCC. The only ones who won't appreciate the gift are the foul-mouthed, the carrier-throwers, and jammers in general. Why? Because the gift they get will probably be notification that they are no longer licensed amateurs; *good riddance*. You see, the "good guys" who wear white hats and ride white horses can win a fight — even today!

Happy holidays!

## Microcomputer Interfacing

from page 28

shown in Fig. 1 pressed, a negative pulse of duration 2.62 seconds will also be observed. If you fail to press the pulser, however, and thus do not apply a positive edge at GATE0, no monostable pulse is observed. On the other hand, if you repeatedly press and release the GATE0 pulse at time intervals less than 2.62 seconds, the monostable pulse can be prolonged indefinitely. In this way, a *retriggerable monostable multivibrator* output can be produced.

With a control word of 064,

the behavior depicted for MODE 2 in Fig. 2 can be observed. By repeatedly generating positive edges at GATE0 at time intervals of less than 2.62 seconds, counter #0 is repeatedly reset and the appearance of the short negative clock pulses is prevented. The same purpose may be accomplished by allowing GATE0 to remain at logic 0 after a positive edge has been applied. The GATE0 input thus exhibits both gating and trigger/reset behavior.

MODE 3 behavior (control word of 066) is similar to that for MODE 2, except that a nearly symmetrical square wave is pro-

duced. Deviations from symmetry occur when the counter byte is an odd number and are most pronounced when the counter byte is very small.

In MODE 4 (control word of 070), the positive edge of the WR pulse (which is applied at pin 23 of the timer when the STA instruction at 003 014 is executed) initiates counting that culminates in the production of a negative clock pulse of pulse-width T. The time duration between the positive edge and the pulse is 2.62 seconds. The GATE0 input acts as a gating input, with a logic 0 inhibiting the counting process.

Finally, in MODE 5 (control word of 072), a positive edge at GATE0 initiates counting. By repeatedly generating positive edges at GATE0 at time intervals of less than 2.62 seconds, counter #0 is repeatedly reset and the appearance of the

single negative clock pulse is presented.

It should be noted that in all modes, counter action begins on the first negative clock transition after WR (pin 23) or GATE0 goes to logic 1, and that WR can initiate counting in all modes except MODE 1 and MODE 5.

Although in many applications of the 8253 timer the primary interest will be to generate the proper signal at OUT0, as shown in Fig. 2, you can also read the contents of the 16-bit counter *without affecting the counting operation*. By inputting a control word of 000, 100, or 200, you latch the 16-bit count of either counter #0, counter #1, or counter #2, respectively. As shown in the memory-mapped I/O example in Table 1, the two bytes can then be read into the 8080A chip, with the LO byte first and the HI byte second.

ou goons don't ever profit  
lousy manuscripts from bat  
bunch of rock  
you like to read  
I insist that you print ev  
tell Ma Bell that she shou

# LETTERS

from page 16

sultant squeal from various troopers to your magazine. I noticed some of the biggest squeals around here came from police who have linears in their patrol cars on CB and they own amateur gear for a home CB station. One local community police department is almost entirely involved in overpower on CB. In fact, in this particular area, a county of maybe 7,000, there are 15 to 18 Yaesus and 7 Siltronix, and linears in autos and home are almost commonplace. Only one Yaesu is owned by a licensed amateur.

Then we see an article printed by a completely illegal, overpowered, out-of-band HFer (Peters) trying to convince us he is just a good ol' guy trying to do his thing, fellas, so please give us HFers some consideration and kindness as they operate like hams and are really good guys. Horse cocky! He is an illegal bootlegger using illegal equipment and should be in jail on a criminal conviction, not being published in an amateur magazine.

Then we have the article that, merely because a ham was a Conditional or Tech, says it was justifiable and cute for an Advanced-type ECM engineer to break the law in dozens of ways to "teach him a lesson." All because the so-called offender was a Conditional whose comments the hot-shot engineer didn't like. I'd rather see ads by Trigger.

In the past, your mag always had the best of amateur radio, every article seemed to be informative, and construction articles for amateurs were of the accepted *ham* type, i.e., licensed and law-abiding. Other than the abovementioned drivel, though, you still have the best mag published and someday you will get back to the average amateur and make us feel we are with you on a one-to-one basis as we read your editorials.

Joe Feagans W9HCL  
Tallula IL

## EGYPTIANS

Now the "other side" has had its say in the pages of 73, with the word of Bess Nelson (September, 1979, page 156) pitted

against the earlier letter of Tania Miller (August, 1978, page 8) in regard to the situation prevalent at the Egyptian Radio Club, Granite City IL. It is one of the oldest, strongest, and most prestigious clubs in the nation, whose chief accomplishment seems to have come 40 years ago, within a decade of its founding, when it won ARRL's Field Day three years in a row.

When I saw Tania's letter, I thought it a bit hasty in remonstrance against an admitted problem, but now I think she, not Bess, had the better perspective on things there.

At present, Mrs. Nelson is editor of the club's newsletter, a journal I had the honor to publish several years ago. Her latest edition, besides containing two unsigned letters—something most of the rest of us editors stopped airing quite a while back—gives the news that the club's regular membership stands at 126, with the obvious implication that the membership is *up* to this figure. The true picture is that club membership must be *down* to 126, following the mass exodus of 29 former members, according to my sources, who walked out the door, led by old-timer Harry Turner (holder of world record for sending code on a straight key—35 wpm—see 73 Magazine, Jan., 1976, page 5), who turned his back in disgust and dropped not only his membership, but also his position as club treasurer, a post he had held for more than a quarter century.

Up until early this summer, I had felt sure that "our" problems would soon be resolved and we would all be back in the same boat again. But I now no longer think this is possible. The arrogant and supercilious behavior of a small knot of hierarchical dictators within the club has made any broadly-based "aura of good feeling" an impossibility. Oh, not that disagreements are ever expected to end, but they need not break up the party. To be sure, old traditions and ideas must and will be changed, and I never particularly agreed with the notion that women should not be members of the club. But it was not this issue that was at the heart of the troubles—rather like the issue of slavery, destined to be the most memorable point of the American Civil War, but

which was not really the cause of it all. The more likely situs of the ERC problem is exactly what Bess points to: feelings of power on the part of a chiefly self-appointed elite within the club.

Oddly enough, my strongest disagreements have been with Harry Turner himself, who once walked out of a board of directors meeting because I was there although not a member, but at the invitation of that body. But Mr. Turner and I can stick to our positions responsibly and still keep our composure and our friendship—as we have continued to do. With the 27 others, I must agree, there's little point in continuing the animosity; I just walked away from it, too. But I don't like to see in print an appearance that the "good guys" won, when they didn't.

Harry Church W0KXP/9  
Lebanon IL

## ATV

On the night of September 4, 1979, all hell broke loose on ATV. At eight thirty pm, VE3IWP, who lives in Toronto, informed me via two meters that W9ZIH from Chicago was coming in on his screen. I fired up my TV station, and sure enough, there he was. I just couldn't believe that I was receiving an ATV picture all the way from Chicago (Hickory Hills) IL about four hundred twenty miles away, while my normal range is about seventy to eighty miles. He was working VE3EYR in Brantford, Ontario.

After that contact, he worked W3POS in Erie PA, approximately four hundred miles between the two stations. At ten pm, I got ahold of W9ZIH myself; we worked both ways, live on camera as well as sound. He received me P4, and I received him P5 (broadcast quality). I nervously took some pictures and made a video recording for future reference. W9ZIH was on for several hours, not just a few minutes as might be expected. VE3EYR, VE3IWP, and myself were in contact with each other on two meters. There were times when I would almost lose W9ZIH, and VE3IWP, who is fifty miles from me, would see him P5, and sometimes conditions would be reversed.

After I finished my ATV QSO with W9ZIH, I picked up N9AB from Mundelein IL, which is four hundred forty-one miles from me. We only flashed our logos at each other for a while; he came in P2 at times. We also saw K9KLM from Oak Creek WI once; he was P3 on my screen and is four hundred eight miles away. Later on that night, W2RPO in Lockport NY and

VE3AHS in Welland, Ontario, also saw W9ZIH. Needless to say, I had a sleepless night after all this. I don't know who holds the world record for DX on fast scan, but we might be close to it. Ron W9ZIH was running five hundred Watts out on 439.25 MHz video, and one hundred fifty Watts on 443.75 MHz sound; his antenna on video had one hundred seven elements up sixty-five feet. I was putting out forty Watts on video and ten Watts on sound with a forty-eight element antenna on video and twenty elements on sound. My converter and preamps are home brew as well as my transmitting equipment. I am not trying to take any credit; we were all active in this and were very enthusiastic. We all hope that what has happened to us might spark some interest in others. I have been a ham since 1959, but after the initial excitement of the first several years wore off, I lost interest in the hobby. After getting involved in amateur fast scan TV, I got my old spirit back again. There is no better way that I can think of for old-timers who are getting stale to rejuvenate the interest in our wonderful hobby. ATV has got all the excitement of the early days of radio, with lots of room for experimentation.

John Vander Ryd VE3CYC  
Hamilton, Ontario

## EUREKA!

Re: 890-960 MHz Machine-to-Machine CB

Eureka!

It now looks fairly definite that the new proposed amateur band in the 890-960 MHz band will not remain vacant due to the lack of equipment.

Our Canadian Department of Communications, through its Director General of Regulations, is proposing a 5-MHz portion be set aside for CB operation. They are proposing a wide-open mode of operation including man-to-machine and machine-to-machine. Comments on band plan, modulation schemes for voice and data, and, most important, eligibility requirements are being requested from the public.

My opinion is that the DOC feels that the big boys, G.E., Motorola, etc., are not being aggressive enough in their development in this area for the private commercial user. The commercial manufacturers keep screaming for more spectrum rather than developing improved technology to communicate within the spectrum they now have.

Motorola has developed a DVP Digital Voice Privacy System along with Harris and pos-

sibly others. This appears to have been developed only for the purpose of privacy. I feel the big "M" and others are going to be left out in the cold unless they and other domestic manufacturers join in on the development of this proposed new band, if it is approved.

Of course I am excited because this brings new and inexpensive technology to the amateur portion of the band.

**Paul Cassel VE3AVY**  
Kitchener, Ontario

*Well, unless we somehow manage to get a lot more licensed amateurs than we have now, I'm not sure that we will have enough people to do much pioneering on a new band. Of course, the availability of relatively inexpensive equipment would help a lot and might take some of the pressures off 450 MHz as a repeater control band. But remember that we have a 1215-1300 MHz band which is virtually unused... primarily because it is so difficult to make the necessary equipment.*

*The 900-MHz band might be one where amateur TV fanatics could set up a series of repeaters and make it possible for that mode to cover more ground.* —Wayne.

### THINK TANK

I'm not writing to bitch or complain about anything. As a matter of fact, I'm writing to obtain my copy of "How to Write for 73." Hopefully, we can strike up a mutual agreement whereby I give you excellent articles for publication and you give me money!

I also want to comment on 73 Magazine in general. I've been a reader of 73 since I was first licensed in 1963. I've followed your magazine's growth from "just another ham rag" to the best ham magazine currently being published. 73 gets in my mailbox first (most of the time) and gets read the longest. The articles are, by far, the most practical and fairly easy to duplicate. The articles also provide an excellent base for "think-tanking" my own projects.

I was delighted with the letter from K8DNV about "Wayne Green's Lair" in the July, '79, issue. Doug DeMaw W1FB has long been one of my favorite authors. Unfortunately, the rest of the senior ARRL staff don't share his opinion.

Several hams here in England are in the process of forming a G5 Amateur Radio Club for all licensed G5 operators. The unofficial G5 calling frequency is S19 (no relation to the CB counterpart) or 145.475 (simplex) MHz. No HF net has been

set up as yet. So far, we have about 10 interested hams. Once we get a few more together, we'll have election of officers, formation of a G5 awards program, and all the other things that go into the makings of a ham club. So, any G5 licensed ham who would like to get in on the ground floor of the G5 ARC, please contact G5CSU at 10 Apple Close, Lord's Walk Estate, RAF Lakenheath Camp, Brandon, Suffolk, IP 279 PJ (my British mailing address), or come up on S19 to get full details.

One more item: 29.6 MHz FM is alive and well. G5BRB has a rig on 29.6 FM and I'll have an old Motorola L41 on as soon as the crystals come in, so look for some G5 activity on 10 FM from Jolly Old England.

That's about it for now. Once the G5 ARC is formed and the awards program is adopted, I'll provide you with the details. Keep up the good work in 73 and Kilobaud MICROCOMPUTING.

**Richard H. Arland G5CSU**  
APO New York NY

### THANKS, HARRY

I would like to comment on the article, "The 80 Meter Coax L," by Harry Pardue in your August, '79, issue.

Even though Fig. 1 is in error to the extent that the feedline braid is not connected to the ground rod as it should be (and as it is described in the text), the article is a fine contribution to our hobby and I wish to thank Harry and 73 for its publication.

My version of it, which runs 20 feet on the vertical to a chimney bracket and then slopes down about 5° to anchor to a nearby tree, shows an SWR of about 1.2 and required no trimming whatsoever! First contact was Oklahoma City to St. Louis, which approaches 600 miles; at 3:00 pm, that's not bad (80m Novice CW).

**Clarence H. Dollmeyer KA5EKM**  
Edmond OK

### VINTAGE QSLs

I purchased the following QSLs at a local stamp and coin dealer. He had purchased them at an estate sale and was selling them to stamp and postcard collectors. If any of the following hams are still active and would like to have the QSL, send me your name and QTH and I'll send you the card.

W1BYF - '33; W1BFP - '31; NU1VT - '28; NU1WV - '28; W2AMM - '29; 2AON - '27; 2BBC - '26; U3BNU - '25; 3LB - '28; U3QW - '25; U3VF - '26; 4AG - '23; 4EE - '25; 5PE - '22; 5WK - '25; 6ACH - '26; W6AIF -

'32; W6AIY - '31; 6ARW - '25; 6ASL - '28; 6AZZ - '26; 6BDW - '28; W6BMH - '31; 6CZU - '26; 6DAQ - '25; 6DOG - '28; 6DTP - '28; W6EBV - '29; W6FOC - '34; W6QY - '29; 6RJ - '25; 8AIB - '21; 8AVZ - Sept., '26, "Been on air week hr"; 8CTD - '24; W8ESG - '55, "ex-W8AKV"; 9AIG - '21; 9ASK - '22; 9ASN - '21; 9BEW - '24; 9BHB - '24; 9BOB - '24, "ex-9BDQ"; 9BQZ - '25; 9BVK - '24; 9DAE - '27; 9DHJ - '24; 9DMX - '24; W9FTR - '31; 9HO - '22; W9LAY - '33; U9WK - '27.

Is there a radio museum which would be interested in a donation of unclaimed cards from the above?

**Gary Payne WD6BJK**  
1347 E. Dakota  
Fresno CA 93704

### SHINGLE POWER

Without a doubt, WB6AAM (September Letters) is right in urging hams to get busy and power their rigs with solar and alternative forms of energy. Considering the momentum that Jane Fonda and the "hate nukes" society is gaining, blackouts are coming. If you like the gasoline shortages of the '70s, you will love the electric power shortages of the '80s and '90s. (For more information, write to Department E, National Rural Electric Association, 1800 Massachusetts Avenue N.W., Washington DC 20036.)

If anyone can come up with a solar cell that can be used instead of shingles for a roof, it will be welcomed across the nation (even by power companies). Power companies need some support.

TMI was the worst nuclear disaster in history—yet no one was hurt. Oh, yes, it is claimed that there may be one to ten

## Ham Help

The Cincinnati Area UFO Net has been active Thursday evenings on 28.8 MHz (alternate frequency 28.795 MHz) at 0100 UTC. A Saturday afternoon section will be inaugurated beginning January 5, 1980, at 2000 UTC. Stations in the western, southwestern, and southern states with UFO traffic or interest are cordially invited to check in on or about 28.8 MHz at that time. Net control will be KA8BVO, with K8NQN providing assistance and liaison with the Mutual UFO Network nets which meet in the morning on 40 and 75 meters.

Information relating to UFO movies shown to radar specialists in the military service dur-

more cases of cancer in the next decade, but peddlers of hysteria fail to mention that over 325,000 cases are expected anyway. Yes, TMI was a tragedy. It set back nuclear power 20 years. Yes, there are risks involved with nuclear power, but these are small compared to others that we take.

For more eloquent thoughts on the subject, readers are referred to A. Hailey's new book, *Overload*. It provides sober food for thought.

**Russell C. W. Crom AG9N**  
Mt. Prospect IL

### MALICIOUS FOOLS

This will no doubt be one of many letters to you highly commending the fantastic job done by the hurricane watch during the recent hurricanes, David and Frederic.

I cannot commend too highly the excellent work done by all those running the net and most particularly by Ellie K4RHL and Lynne WA1KKP. So many people who benefited from information received by their tireless efforts will hold them in warm regard, and for those of us who sat on the sidelines during the long hours, their patience and fortitude under difficult conditions was more than admirable.

The difficult conditions were unfortunately made doubly so by some sick pranksters or malicious fools who persisted in heckling and attempting to block vital transmissions with all manner of QRM. It is hoped that the FCC is in a position to take positive action. I think that every ham who heard the QRM deplored it and would love to have been in a position to throttle the bastards.

**George Benson GY5GB**  
Kingston, Jamaica

ing the 1950s is of particular importance. If you or someone you know has seen such movies, please contact Mick Georgin KA8BVO, 8788 Mockingbird Lane, Cincinnati OH 45231, in confidence. His landline is (513)-729-3430. Thank you.

**David L. Dobbs K8NQN**  
6612 Pleasant Street  
Cincinnati OH 45227

If anyone has any information on any organized net of Masons on the amateur bands, please drop a line to Bill Williams, Box 419, Philmont NY 12565. Thank you.

**Arthur Roraback III**  
RD 1, Box 87  
Chatham NY 12037

# Awards

from page 22

of the amateur receiving this award.

## WORKED ALL SM WASM I

This award is offered by the Swedish Amateur Radio Society as tangible evidence of the proficiency of foreign amateurs in making contacts with the

various call areas of Sweden.

The award may be claimed by any amateur in the world who has fulfilled the following qualifications. Swedish amateurs will not be eligible.

European amateurs must work two stations in each of the eight Swedish call areas. These areas are SM1 to SM7 inclusive and SM0. The contacts may be made with SM, SK, and SL sta-

tions, and all stations have to be land-based. All contacts must be made after World War II. Non-Europeans need only contact one Swedish station in each of the required call areas.

The contacts may be made using any authorized amateur band and any type of emission. No endorsements for work on any certain band or for phone work will be given.

The applicant must submit a list of claimed contacts which may be verified by two amateurs, a local radio club secretary, or a notary public.

To cover expenses for this award, which is cloth and beautifully designed, there is a fee of 11 IRCs. Applicants are to send this fee and list of contacts to: SSA Diploma Manager, Ostmarksgatan 43, S-123 42 Farsta, Sweden.

Join us again next month as we span the globe looking for additional incentives to make those new contacts worthwhile. Continue to forward award information as it becomes available. Perhaps your own radio club sponsors an awards program. Why not share it with our readers worldwide?

# Contests

from page 35

## GARDEN CITY CONTEST Starts: 1200 GMT December 8 Ends: 1159 GMT December 9

The Visvesvaraya Industrial and Technological Museum, Bangalore, and the Bangalore Amateur Radio Club cordially invite all amateurs to participate in the VU2DX Contest. There will be two groups of operation, with one group operating both 20 and 40 meters and the other group operating only 40 meters. Log sheets regardless of score will be of definite interest to all concerned along with any photographs of the shack and contestants. The contest is open to all amateurs but restricted to CW only and single operators. The station must be manned by the individual amateur contesting without receiving any assistance from any other persons for log-keeping or spotting, etc., during the entire period of the contest. Stations may be worked once per band and valid points can be scored by contacting stations not in the contest provided complete RST exchanges are made and logged.

### EXCHANGE:

RST and serial QSO number in three digits or more.

### SCORING:

Each completed QSO counts 1 point with the following multipliers: VU station contacting Asia = multiplier of 1, contacting Europe, Africa, and Australia = multiplier of 2, and contacting North and South America = multiplier of 3.

### ENTRIES AND AWARDS:

All entries to the contest must be postmarked no later than December 31st and sent to: The Convenor, Garden City Contest 1979, Visvesvaraya Industrial and Technological Museum, Kasurba Road, Bangalore 560 001, India. There is no entry fee and the entries must be a true copy of the actual log for the contest period. All DX stations who contact 20 or more VU2 stations will be issued a "Garden City Certificate."

## TEENAGE RADIO SPRINT

Starts: 0000 GMT December 22  
Ends: 2400 GMT December 23

Sponsored by the Twin City Teenage DX Club, the contest's purpose is to promote teenage amateur operators and to help friendship with other teenagers. All hams over 21 years of age must work only stations under 21 years of age. Stations under 21 may work all stations. To

show under 21, put "/T" after your callsign. General call will be "CQ TNGE TEST."

### EXCHANGE:

RS(T) and age; if over 21 and you don't want to send your age, simply send xx in place of the age.

### SCORING:

Score 2 points per QSO in one's own country, 4 points for all DX QSOs. Double QSO points (4 and 8 points) for QSOs on 160, 80, or 40 meters. Multiplier is number of different prefixes worked on each band and mode. No crossband contacts except via OSCAR.

### FREQUENCIES:

CW—40 to 60 kHz up from bottom of band, 10 kHz up for Novice.

SSB—near or around 3975, 7275, 14275, 21375, 28575.

6 and 2 meters may also be used.

### ENTRIES AND AWARDS:

Awards will be given depending on the activity! Entry classes include single-operator, all band; multi-operator, single transmitter; and multi-multi. Also, special classes for CW only, SSB only, or mixed. A summary sheet is requested and a sheet with scoring and contact totals along with the usual contest information signed by the operator is requested. All logs must be sent to Greg Deuhs KB0CV, 1945 Ashland Avenue, St. Paul MN 55104.

## 12TH AUSTRALIAN JAMBOREE December 29, 1979 — January 7, 1980

The vast distances and small potential of people power do not deter Western Australians from thinking big. Although covering one third of the Australian continent, making it the biggest state in the world, the West has only 8% of its population at about 1.2 million people.

1979 is the state sesquicentenary (150th anniversary) year, so many years ago the W. A. Scout Branch applied for the regular three yearly Australian Jamborees always previously held in the populous eastern seaboard states. This was agreed and the Jamboree becomes the final event in a year-long birthday party embracing the whole population from all towns, utilizing all activities which could be imagined.

World Scout Bureau gave it regional status as the 4th Asia-Pacific Jamboree. Subsequently, with the postponement of the 1979 World Jamboree in Teheran, Iran, it became one of the 1979 World Jamboree Year Camps. About 8000 scouts from eastern states and over 1000 from 30 overseas countries will mix with 2000 locals for eight days of camping, activities, sight-seeing, shopping, trying new skills, fraternization, and fun.

Because amateur radio amplifies many of these Jamboree concepts, e.g., new skills, fraternization, and fun, local amateurs are preparing one of the biggest VK6 stations ever mounted. Facilities will include:

- a high-frequency station on 20 or 15 meters operating round the clock beaming the world, including eastern states;
- a high-frequency station on 15 or 10 meters operating all day beaming eastern capitals;
- a high-frequency station on 40 or 80 meters operating as required with dipole aerials favoring north/south;

# Results

## RESULTS OF 1978 TOPS CONTEST

Winner was HA5NP — Robert Soket of Budapest, Hungary

No. of contacts — 549	Number of points — 1014
No. of prefixes — 115	Total score — 116,610
FT-250 at 200 Watts	

Second was HA9RU — Janos Pokker of Miskde, Hungary

No. of contacts — 480	Number of points — 851
No. of prefixes — 130	Total score — 110,630
FT-250 at 200 Watts	

Third was YU1OCV — Vojislav Kapun of Kikinda, Yugoslavia

No. of contacts — 386	Number of points — 810
No. of prefixes — 118	Total score — 95,580
FT-200 and amplifier at 500 Watts	

- a RTTY station operating most of the time as signals are available;
- amateur TV F/S on UHF with special receivers located in subcamp fraternity areas;
- three or more VHF stations on 2 meters and 6 meters and perhaps other bands; and
- a workshop where, under the supervision of amateurs, the scouts will be able to build a simple electronic working project.

In addition, a broadcast band radio station on 1610 kHz is in preparation so that items of news, happenings, instruction, and music can be conveyed quickly to all scouts for their entertainment.

It is expected that the stations will be busy with amateurs in contact and that the special Jamboree Badge QSL Card will be in demand. It is hoped also that scout groups and units with radio amateur capabilities or friends will make a special time to get together during the Jamboree to make contact. Further, it is expected that many groups around the world will

want to make contact to find out how the Jamboree and their particular people are progressing. To assist these contacts, skeds will be accepted for a particular frequency, date, and time. Mail to: Scout Amateur Radio VK6SH, 12th Australian Jamboree, Box 467 P.O., West Perth, Western Australia 6005.

To test propagation conditions as far as it is possible, all skeds will be acknowledged by trying all contacts with one of the VK6 amateurs on the organizing team exactly four weeks to the day and hour on which the contact is asked for. If that sked does not work, another will be tried a week later—three weeks from the Jamboree. The sooner that skeds are requested, the better can the arrangements be.

The Jamboree is being held at Perry Lakes Stadium and associated grasslands—an international track and field site established for the Empire Games in Perth in 1962. The radio station is to be sited on the top floor of the stadium building using most of an area 250 feet long by 11 feet wide.

For further information, con-

tact: (Jamboree) Mr. Alex Shaw, The Scout Association of Australia (W. A. Branch), Box 467 P.O., West Perth, W. A. 6005, phone 321-7217 (Mr. Doug Napier); or (Radio) Mr. Peter Hughes, Asst. Branch Commissioner, 58 Preston Street, Como, W. A. 6152, phone 367-1740 (mornings 364-7588).

#### CANADIAN CHRISTMAS QSO PARTY

**Starts: 0001 GMT Saturday, December 30**  
**Ends: 2359 GMT Saturday, December 30**

This contest is sponsored by the Canadian Amateur Radio Federation and is open to all amateurs. Everybody may work everybody on all bands, 160-2 meters, CW and phone combined. Entry classes are single-operator allband and single-operator single band.

#### EXCHANGE:

Exchange signal reports and consecutive serial numbers, e.g., 599001. VE1 stations also send province.

#### SCORING:

Stations may be worked

twice on each band, once on CW and once on phone. Score 10 points for each contact with Canada, 1 point for contacts with others. Multipliers are the number of Canadian provinces and territories worked on each band and mode (12 provinces/territories times 8 bands times 2 modes for a maximum of 192).

#### FREQUENCIES:

CW—1810, 3525, 7025, 14025, 21025, 50100, 144100 kHz.

Phone—1810, 3770, 3900, 7090, 7230, 14150, 14300, 21200, 21400, 28400, 28600, 50100, 146520 kHz. Suggest phone on the even hours GMT, CW on the odd hours.

#### ENTRIES:

Entries, with dupe sheets and summary sheet, must be mailed by January 31, 1980, to CARF, Box 76752, Vancouver BC, Canada V5R 5S7.

#### OOPS

Hope we didn't cause any problems, but there was a slight typo error in the September contest calendar write-up on the 89'ers Run. Certificate applications should go to WB5YKD and not WB5TKD as listed.

# W2NSD/1 NEVER SAY DIE

editorial by Wayne Green

from page 6

emissaries a few minutes before a net is scheduled to open. They can get on, check around, and, if the net frequency is in use, find a spot for the users to move, if they can be coaxed into it. Most hams are like me, they will do almost anything for you if you ask nicely . . . and will fight to the death if told what to do.

If the chaps are obstinate . . . or if one of the net people trying to get a clear channel is less than diplomatic, there should be an understanding that the net can move up or down a few kilohertz to keep peace in the family. Blessed are the peacemakers for they are the first to get killed when war starts.

#### FINDING THE JAMMERS

Little has been written or even done about trying to find the jammers. We are a whole generation behind in working on the problem. The FCC and other agencies have gone years beyond us in the design of sophisticated equipment for searching out jammers . . .

while we are still out waving loop antennas around, chasing off in the opposite direction at top speed.

I've heard that the FCC is able to get a fix on a jammer within one or two seconds . . . or is it milliseconds? As I've mentioned before, I'd sure like to have some articles in 73 on how to build some modern DF equipment. The Happy Flyers in California have run up an impressive record of tracking down repeater kerchunkers and jammers by plane, but I should think that we might be able to go beyond that before long.

We could use articles on techniques for identifying stations by looking at their keying patterns. This means freezing the leading edge of a kerchunk and looking at it on a scope. I understand that every rig may have its own identifiable pattern. We want to know more about triangulation via receiving both the signal on the repeater input frequency and the repeater output. If pairs, or more, of operators could get a net going to do instant triangulation, that might be worthwhile. Let's start tackling this.

#### AFTER YOU FIND 'EM

In most cases, a ham will shut up once he knows he's been discovered. In those cases where the ham is blatant about it, stronger measures are needed. I've heard that massive visits from concerned local amateurs can have a settling effect on strong-willed jammers. It is impressive when a hundred hams drive up and come to your door to reason with you . . . particularly if they have sticks in their hands.

There are a lot more articles needed on ways which have worked to calm down hard-core jammer cases. I doubt if broken arms are necessary—just some powerful reasoning.

#### THE WORST WAY

Amateur radio has a reputation of being self-regulating. We try, as much as the FCC will permit, to generate our own rules and we have an enviable record of sticking to them. I can't think of a case yet where FCC-generated rules have been nearly as well suited to our work as our own rules. Amateurs are very considerate of each other, most of the time, and tend to go overboard in the protection of special interests more than in putting them down.

So, in view of this image of self-regulation, every time we turn crying to the FCC over some interference problem, we are hurting our image with the outfit where our image is the most important. We should move heaven and Earth to handle our own problems and not

keep calling up the FCC every time some idiot lets loose.

#### WHAT'S NEXT?

Until we get a lot more information on direction-finding and have a few dozen stations set up for instant fixes, there isn't much we can do. Swinging a three-element 20m beam is hardly the way to try to locate some idiot in Nebraska who is raising hell with hurricane communications. We need to be able to pinpoint the trouble quickly and have things organized enough so we can get in touch with a net in the specific area which can get action.

Clubs which get set up to participate in direction-finding can let me know and I'll try to run a list so other groups will know whom to contact when a problem arises. I should get contact call letters and phone numbers, together with some idea of the bands which can be DFed, etc.

Let's get going on this . . . with articles and organization.

#### COOL THE HAMFESTS

The QST editorial suggesting that hamfests be cut back sure wasn't given much thought before being put to paper. Sure, there are major problems for some of the ARRL conventions . . . there have been real bummers. But this doesn't mean there is anything wrong with hamfests. The Milwaukee Central Division Convention, after two solid years of planning and work, featuring Harry Dannals as speaker, brought in eight exhibitors and a crushing

400 in attendance. The National, in Baton Rouge, also featuring Harry, was another disaster.

Let's compare that with the first-time hamfest in St. Louis (boycotted by the ARRL) which drew about 2,500. There were over 1,500 put to sleep by my talk alone. This year, the St. Louis crowd is loaded for bear... they've rented the largest riverboat on the Mississippi for the banquet... seven decks and a capacity of 3,500... two orchestras... and some entertainment by Wayne Green. I understand that there is a possibility that Arthur Godfrey may be able to make it... he's been sick lately, so we don't know yet. And there will be a lot more entertainment.

You may be sure that every exhibitor from last year will be back... they cleaned up from the money-waving crowds. I predict there will be many more ham and computer dealers and manufacturers exhibiting this time.

The fellows down in Maryland are cooking up a big event for the spring... again featuring me. Why do I draw crowds? Well, I say exactly what I think about things... and I'm able to say a lot at talks like this that I would never be able to print. Perhaps I go too far sometimes and say things, which, though true, shouldn't be let out of the bag.

A lot of people come to see what Wayne Green is really like... since I aggravate the hell out of them in my editorials... and they usually find that after 40 years around this hobby and 27 years of publishing, I really do know what I'm talking about.

No, there's nothing wrong with hamfests except the stifling effect of the League trying to keep the truth from getting out. Boy, do those fellows remind me of the Kremlin!

#### WHAT'S DOING AT 73?

With the ham field in the doldrums, we're not indulging in many expansion plans for 73. It is doing well, obviously, but the growth is mainly in the micro-computing end of things. *Kilobaud MICROCOMPUTING* has been growing steadily. We have a new magazine, *80-MICROCOMPUTING*, for the TRS-80 owners, starting in January (out before then). The *Industry Newsletter* has grown into a magazine of its own... now pushing 60 pages a month, and with no end in sight. The Instant Software publishing is now perking along, with over 100 program packages already in publication and a couple thousand in various stages of production. Since this division

has only been in serious production since the first of the year... and since it takes about six months to process and publish a program, the project is doing surprisingly well.

Instant Software is now being distributed all through Europe, in several hundred outlets in the US, in South Africa... and will soon be distributed in Asia. It's going in Australia and is getting started in South and Central America. Programs are being produced in German, Italian, French, Spanish, and even English.

A headquarters building and the seed staff for still another magazine has been organized in Boston. This will be a magazine devoted to leisure in that area. If it works well, it might expand to similar magazines for other cities, just as the New York, Philadelphia, and Boston magazines have proliferated. This is scheduled to kick off early next spring.

Having had dozens of hobbies and interests, the leisure magazine idea seemed a natural to me. I've been heavily into horseback riding and horse training, flying, skin diving, skiing, gourmet cooking, sports car rallies and gymkhanas, boating, water skiing, mountain climbing, hamming, hobby computers, car racing, spelunking, restauranting, and more things which don't come to mind immediately, so what better than to do a magazine about all of the activities which are possible in and around greater Boston? It will be fun.

#### DECEPTIVE ADVERTISING?

Every time I see an ad for the Little Giant antenna in *Ham Radio Magazine*, I laugh. From my viewpoint, this piece of garbage is a pure rip-off and I feel that no reputable publisher should accept an ad for it.

In addition to knowing enough antenna theory to recognize that the contraption is useless, I've also tested the silly thing. It first popped up around 1958 when I published an ad for it. I got in touch with the "inventor," a very nice chap, Stan Byquist... K0AST, I think was his call. I looked over his literature and tried to figure out some way... any way... that it could be more effective than a piece of window screen. I failed, so I got Stan to send me one.

Sure, I could tune it up... heck, you can make almost anything load... but it was no more effective than an old window screen. Stan said he was getting good results... but when he said he had to keep the feedline away from his tower to get good reports, I knew what was happening... it was the feedline which was radiating and the intricate (and expen-

sive) lump on top was a weird loading coil, in effect.

I talked it over with Sam Harris W1FZJ and he agreed. But, just to make sure, he borrowed the kludge and tried it every way possible... he felt that it was *inferior* to a window screen. I passed the bad news along to Stan and told him we would accept no more advertising. A short while later, I noticed an order from Stan for an 8JK antenna handbook coming in to Radio Bookshop. I hope Stan read the book... but I somehow doubt it.

By 1960, Stan had moved to Ohio as K8VRM and had put aside his Little Giant antenna (oh, I forgot to mention... that was my idea for the name of the dumb thing). He took on *73 Magazine* as a rep for the Ohio area and did a bang-up job of getting sales with electronics stores. Stan is a very nice guy and did a great job as a rep.

In the 60s, he got involved with hardware for CBers... switches, power meters, etc. Then, for some reason, the Little Giant got going again and I see ads for it in *Ham Radio* every now and then. I've talked with 'em at *HR*, so they know the antenna doesn't work. Perhaps they feel that the ad, which says that the antenna "may not outperform a full-sized beam," is warning enough to the wise. That is a true statement. I would not expect the antenna to outperform a full-sized beam, even if it were lying broken on the ground.

Shouldn't there be some responsibility on the part of publishers to protect the unwise from being sucked in on bummers? I have a whole list of firms which I won't permit to advertise in *73*... though most of them have gone back into the woodwork. I haven't seen a Dycomm ad in a while. And we shut down ads for EBC, Ebka, Processor Tech, Swivitek, Valpey Fisher, SAROC, etc.

The ARRL makes a stab at trying to protect the *QST* readers, but they permit rip-off advertisers that I would never let run. I do enjoy their bragging about what few they do avoid.

Let me repeat something I keep repeating: If you feel ripped off over any ham gear, please let me know the details. I prefer you write a letter to the perpetrator with all details and send a copy to me.

## Ham Help

I need a schematic, manual, or data sheet on an Instrument Corporation of Florida very low frequency receiver, model R-500. This fixed-tuned 5-chan-

#### 1980 ASPEN CONFERENCE

Ham manufacturers are always looking for some new concept which might permit them to bring out ham equipment which would make all past rigs obsolete, thereby triggering a massive buying of new equipment. Since we're talking about something on the order of \$1 billion or more in sales, this is not to be treated lightly.

Oddly enough, hams, too, are looking for exactly the same thing... something new. It is fun to buy a new rig, but the expense is a major one and not to be made unless there is a darned good reason.

I think I have two breakthrough ideas which together could make all existing rigs completely obsolete... and that includes both low-band gear and FM equipment! It will be possible to use these new modes of operating with add-on units for starters, but I suspect that most amateurs will want to opt for equipment with these new modes built right in. These concepts will, I think, make it possible for us to see profound changes in amateur radio over the next few years.

The first public unveiling of these ideas will be at the Aspen Ham Industry Conference, January 12-19th. The admission fee will be a signed non-disclosure contract for one percent of the wholesale price of any equipment sold using the concepts I shall divulge.

It is too late now for us to make reservations for you, so if you are going to attend the conference (which includes a lot of skiing), you'll have to handle the reservations yourself. Please do let Sherry know if you are going to be there so we can include you in the activities and workshop session (Sherry Smythe, *73 Magazine*, Peterborough NH 03458). The main group will be staying at the Limelight, in downtown Aspen.

#### AUGUST WINNER

Amassing the largest total vote ever recorded in our Most Popular Article contest, "You Can Watch Those Secret TV Channels" walked away with August's award. Authors Jim Barber K0JB and Jevon Lieberg K0FQA will be splitting the \$100 prize. If you have a favorite article in this issue, be sure to use the Reader Service card ballot to let us know what it is.

nel receiver was part of a Cubic Timing Systems network.

Harry A. Weber  
2605 West 82nd Place  
Chicago IL 60652





Same day shipment. First line parts only. Factory tested. Guaranteed money back. Quality IC's and other components at factory prices.

INTEGRATED CIRCUITS

Table listing various integrated circuits and components including 7400TTL, 7400N, 7402N, 7404N, 7409N, 7410N, 7412N, 7413N, 7414N, 7415N, 7416N, 7417N, 7418N, 7419N, 7420N, 7421N, 7422N, 7423N, 7424N, 7425N, 7426N, 7427N, 7428N, 7429N, 7430N, 7431N, 7432N, 7433N, 7434N, 7435N, 7436N, 7437N, 7438N, 7439N, 7440N, 7441N, 7442N, 7443N, 7444N, 7445N, 7446N, 7447N, 7448N, 7449N, 7450N, 7451N, 7452N, 7453N, 7454N, 7455N, 7456N, 7457N, 7458N, 7459N, 7460N, 7461N, 7462N, 7463N, 7464N, 7465N, 7466N, 7467N, 7468N, 7469N, 7470N, 7471N, 7472N, 7473N, 7474N, 7475N, 7476N, 7477N, 7478N, 7479N, 7480N, 7481N, 7482N, 7483N, 7484N, 7485N, 7486N, 7487N, 7488N, 7489N, 7490N, 7491N, 7492N, 7493N, 7494N, 7495N, 7496N, 7497N, 7498N, 7499N, 7500N.

ATTENTION ELF OWNERS: QUEST SUPER BASIC

Quest, the leader in inexpensive 1802 systems announces another first. Quest is the first company worldwide to ship a full size Basic for 1802 systems. A complete function Super Basic by Ron Cenker including floating point capability with scientific notation (number range ± 17E<sup>26</sup>), 32 bit integer ± 2 billion, Multi dim arrays, String arrays, String manipulation, Cassette I/O, Save and load, Basic, Data and machine language programs and over 75 Statements, Functions and Operators.

versions coming soon with exchange privilege allowing some credit for cassette version.

- Super Basic on Cassette \$40.00
Tom Pittman's 1802 Tiny Basic Source listing now available. Find out how Tom Pittman wrote Tiny Basic and how to get the most out of it. Never offered before. \$19.00
S-100 Slot Expansion \$9.95
Coming Soon: Assembler and Editor, Elf II Adapter Board. High resolution alpha/numerics with color graphics expandable up to 256 x 192 resolution for less than \$100.
16K Dynam. RAM bd. expand. 32K; less than \$150.

RCA Cosmac Super Elf Computer \$106.95

Compare features before you decide to buy any other computer. There is no other computer on the market today that has all the desirable benefits of the Super Elf for so little money. The Super Elf is a small single board computer that does many big things. It is an excellent computer for training and for learning programming with its machine language and yet it is easily expanded with additional memory, Full Basic, ASCII Keyboards, video character generation, etc.

A 24 key HEX keyboard includes 16 HEX keys plus load, reset, run, wait, input, memory protect, monitor select and single step. Large, on board displays provide output and optional high and low address. There is a 44 pin standard connector slot for PC cards and a 50 pin connector slot for the Quest Super Expansion Board. Power supply and sockets for all IC's are included in the price plus a detailed 127 pg. instruction manual which now includes over 40 pgs. of software info. including a series of lessons to help get you started and a music program and graphics target game.

Before you buy another small computer, see if it includes the following features: ROM monitor; State and Mode displays; Single step; Optional address displays; Power Supply; Audio Amplifier and Speaker; Fully socketed for all IC's; Real cost of in warranty repairs; Full documentation.

Many schools and universities are using the Super Elf as a course of study. OEM's use it for training and research and development.

The Super Elf includes a ROM monitor for program loading, editing and execution with SINGLE STEP for program debugging which is not included in others at the same price. With SINGLE STEP you can see the microprocessor chip operating with the unique Quest address and data bus displays before, during and after executing instructions. Also, CPU mode and instruction cycle are decoded and displayed on 8 LED indicators.

Remember, other computers only offer Super Elf features at additional cost or not at all. Compare before you buy. Super Elf Kit \$106.95, High address option \$8.95, Low address option \$9.95. Custom Cabinet with drilled and labelled plexiglass front panel \$24.95. Expansion Cabinet with room for 4 S-100 boards \$41.00. NiCad Battery Memory Saver Kit \$6.95. All kits and options also completely assembled and tested.

An RCA 1861 video graphics chip allows you to connect to your own TV with an inexpensive video modulator to do graphics and games. There is a speaker system included for writing your own music or using many music programs already written. The speaker amplifier may also be used to drive relays for control purposes.

Questdata, a 12 page monthly software publication for 1802 computer users is available by subscription for \$12.00 per year.

Tiny Basic Cassette \$10.00, on ROM \$38.00, original Elf kit board \$14.95. 1802 software; Moews Video Graphics \$3.50. Games and Music \$3.00, Chip 8 Interpreter \$5.50.

Super Expansion Board with Cassette Interface \$89.95

This is truly an astounding value! This board has been designed to allow you to decide how you want it optioned. The Super Expansion Board comes with 4K of low power RAM fully addressable anywhere in 64K with built-in memory protect and a cassette interface. Provisions have been made for all other options on the same board and it fits neatly into the hardwood cabinet alongside the Super Elf. The board includes slots for up to 6K of EPROM (2708, 2758, 2716 or TI 2716) and is fully socketed. EPROM can be used for the monitor and Tiny Basic or other purposes.

subroutines allowing users to take advantage of monitor functions simply by calling them up. Improvements and revisions are easily done with the monitor. If you have the Super Expansion Board and Super Monitor the monitor is up and running at the push of a button.

Other on board options include Parallel Input and Output Ports with full handshake. They allow easy connection of an ASCII keyboard to the input port. RS 232 and 20 ma Current Loop for teletype or other device are on board and if you need more memory there are two S-100 slots for static RAM or video boards. Also a 1K Super Monitor version 2 with video driver for full capability display with Tiny Basic and a video interface board. Parallel I/O Ports \$9.85, RS 232 \$4.50, TTY 20 ma I/F \$1.95, S-100 \$4.50. A 50 pin connector set with ribbon cable is available at \$12.50 for easy connection between the Super Elf and the Super Expansion Board.

Power Supply Kit for the complete system (see Multi-volt Power Supply below).

A 1K Super ROM Monitor \$19.95 is available as an on board option in 2708 EPROM which has been preprogrammed with a program loader/editor and error checking multi file cassette read/write software. (relocatable cassette file) another exclusive from Quest. It includes register save and readout, block move capability and video graphics driver with blinking cursor. Break points can be used with the register save feature to isolate program bugs quickly, then follow with single step. The Super Monitor is written with

Multi-volt Computer Power Supply 8v 5 amp, ±18v .5 amp, 5v 1.5 amp, -5v .5 amp, 12v .5 amp, -12 option. ±5v, ±12v are regulated. Kit \$29.95. Kit with punched frame \$37.45, \$4.00 shipping. Woodgrain case \$10.00, \$1.50 shipping.

60 Hz Crystal Time Base Kit \$4.40 Converts digital clocks from AC line frequency to crystal time base. Outstanding accuracy. Kit includes: PC board, IC, crystal, resistors, capacitors and trimmer.

Rockwell AIM 65 Computer 6502 based single board with full ASCII keyboard and 20 column thermal printer. 20 char. alphanumeric display, ROM monitor, fully expandable \$375.00, 4K version \$450.00. 4K Assembler \$85.00, 8K Basic Interpreter \$100.00. Power supply assy. in case \$60.00. AIM 65 in thin briefcase with power supply \$485.00.

Not a Cheap Clock Kit \$14.95 Includes everything except case. 2-PC boards. 6-.50" LED Displays. 5314 clock chip, transformer, all components and full instructions. Orange displays also avail. Same kit w/.80" displays. Red only. \$21.95 Case \$11.75

Video Modulator Kit \$8.95 Convert your TV set into a high quality monitor without affecting normal usage. Complete kit with full instructions.

S-100 Computer Boards 8K Static RAM Kit Godbout \$135.00 16K Static RAM Kit 265.00 24K Static RAM Kit 423.00 32K Dynamic RAM Kit 310.00 32K Static RAM Kit \$475.00 64K Dynamic RAM Kit 470.00 8K/16K Eprom Kit (less PROMS) \$89.00 Video Interface Kit \$139.00 Motherboard \$39. Extender Board \$8.99

79 IC Update Master Manual \$35.00 Complete IC data selector, 2500 pg. master reference guide. Over 50,000 cross references. Free update service through 1979. Domestic postage \$3.50. No foreign orders.

Auto Clock Kit \$17.95 DC clock with 4-.50" displays. Uses National MA-1012 module with alarm option. Includes light dimmer, crystal timebase PC boards. Fully regulated, comp. instrs. Add \$3.95 for beautiful dark gray case. Best value anywhere.

Stopwatch Kit \$26.95 Full six digit battery operated. 2-5 volts. 3.2768 MHz crystal accuracy. Times to 59 min., 59 sec., 99 1/100 sec. Times std., split and Taylor. 7205 chip, all components minus case. Full instructions.

NiCad Battery Fixer/Charger Kit Opens shorted cells that won't hold a charge and then charges them up, all in one kit w/full parts and instructions. \$7.25

PROM Eraser Will erase 25 PROMs in 15 minutes. Ultraviolet, assembled. \$34.50

Hickok 3 1/2 Digit LCD Multimeter Batt/AC oper. 0.1mv-1000v. 5 ranges. 0.5% accur. Resistance 6 low power ranges 0.1 ohm-20M ohm. DC curr. .01 to 100ma. Hand held, 1/2" LCD displays, auto zero, polarity, over-range. \$69.95.

Digital Temp. Meter Kit \$34.00 Indoor and outdoor. Switches back and forth. Beautiful. 50" LED readouts. Nothing like it available. Needs no additional parts for complete, full operation. Will measure -100° to +200°F, tenths of a degree, air or liquid. Beautiful woodgrain case w/bezel \$11.75

AZDEN. ★ NEW! ★ AZDEN. ★ NEW! ★ AZDEN. ★ NEW! ★ AZDEN.

# AZDEN®

## REVOLUTIONIZES THE STATE OF THE ART AWE AND AZDEN. INTRODUCE THE BRILLIANT NEW PCS-2000 MICROCOMPUTER CONTROLLED

**NEW!**

2 METER FM TRANSCEIVER

NOT \$550.00  
INTRODUCTORY  
PRICE

**\$369<sup>00</sup>**

ALSO PCS 2800 10 METER  
VERSION WITH THE SAME  
BASIC FEATURES COMING IN  
NOVEMBER. PRICE TBA.



COMPARE THESE FEATURES  
WITH ANY UNIT AT ANY PRICE

- **FREQUENCY RANGE:** Receive and transmit: 144.00 to 147.995 MHz, 5KHz steps + MARS-CAP\* and MULTIPLE OFFSET BUILT IN.
- **ALL SOLID STATE-CMOS PL DIGITAL SYNTHESIZED.**
- **SIZE:** UNBELIEVABLE! ONLY 6 1/4" x 2 1/2" x 9 1/4". COMPARE!
- **MICROCOMPUTER CONTROLLED:** All scanning and frequency-control functions are performed by microcomputer.
- **DETACHABLE HEAD:** The control head may be separated from the radio for use in limited spaces and for security purposes.
- **SIX-CHANNEL MEMORY:** Each memory is re-programmable. Memory is retained even when the unit is turned off.
- **MEMORY SCAN:** The six channels may be scanned in either the "busy" or "vacant" modes for quick, easy location of an occupied or unoccupied frequency.
- **FULL-BAND SCAN:** All channels may be scanned in either "busy" or "vacant" mode. This is especially useful for locating repeater frequencies in an unfamiliar area.
- **INSTANT MEMORY-1 RECALL:** By pressing a button on the microphone or front panel, memory channel 1 may be recalled for immediate use.
- **MIC-CONTROLLED VOLUME AND SQUELCH:** Volume and squelch can be adjusted from the microphone for convenience in mobile operation.
- **ACCESSORY OFFSET:** Provides three additional offset values: +0.4 MHz, +1 MHz and +1.6 MHz. Other offsets may also be obtained.
- **25 WATTS OUTPUT:** Also 5 watts low power for short-distance communication.
- **DIGITAL S/R/F METER:** LEDs indicate signal strength and power output. No more mechanical meter movements to fall apart!
- **LARGE 1/2-INCH LED DISPLAY:** Easy-to-read frequency display minimizes "eyes-off-the-road" time.
- **PUSHBUTTON FREQUENCY CONTROL FROM MIC OR FRONT PANEL:** Any frequency may be selected by pressing a microphone or front-panel switch.
- **SUPERIOR RECEIVER SENSITIVITY:** 0.28 uV for 20-dB quieting. The squelch sensitivity is superb, requiring less than 0.1 uV to open. The receiver audio circuits are designed and built to exacting specifications, resulting in unsurpassed received-signal intelligibility.
- **TRUE FM, NOT PHASE MODULATION:** Transmitted audio quality is optimized by the same high standard of design and construction as is found in the receiver. The microphone amplifier and compression circuits offer intelligibility second to none.
- **OTHER FEATURES:** Dynamic Microphone, built in speaker, mobile mounting bracket, external remote speaker jack (head and radio) and much, much more. All cords, plugs, fuses, microphone hanger, etc. included. Weight-6 lbs.
- **ACCESSORIES:** 15' REMOTE CABLE... \$29.95. \*MARS-CAP KIT... TBA. PCS-6R A/C POWER SUPPLY... \$49.95. TOUCHTONE MIC. KIT... \$39.95.

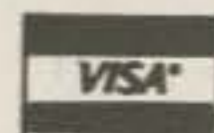

### AMATEUR-WHOLESALE ELECTRONICS ✓ A21

8817 S.W. 129th Terrace, Miami, Florida 33176

Telephone (305) 233-3631 • Telex: 80-3356

U.S. DISTRIBUTOR DEALER INQUIRIES INVITED

ORDER NOW TOLL-FREE

Credit card holders may use

our toll-free ordering number

Ask for operator 701

(800) 824-7888

In California (800) 852-7777  
Alaska and Hawaii (800) 824-7919

800

800



# COMING IN JANUARY!!

## KDK

## FM 2025A

- 25 WATTS
- MICRO COMPUTER CONTROLLED
- 10 MEMORIES
- PROGRAMMABLE OFFSETS
- BAND & MEMORY SCAN
- SINGLE KNOB TUNING

**SPECIAL SALE**

**\$299<sup>00</sup>**

REG. \$369.00

Regulated AC/PS  
Model FMPS-4R . . . \$39.95



SHOWN WITH OPTIONAL µP-800 MICRO-PROGRAMMER\* \$99.<sup>00</sup>



FMPC-1\* Micro-  
phone with Built-in  
Touch Tone Pad  
**WHY BUY LESS?  
THE FMPC-1  
HAS IT ALL!**

- New! Auto key up
- Snap Action Keyboard
- Adj. level and tone balance
- Use with any transceiver
- Only 3 1/2" x 2"

\$44.95

**! TWO ANTENNAS!  
FOR THE PRICE OF ONE!**

**NEW!**

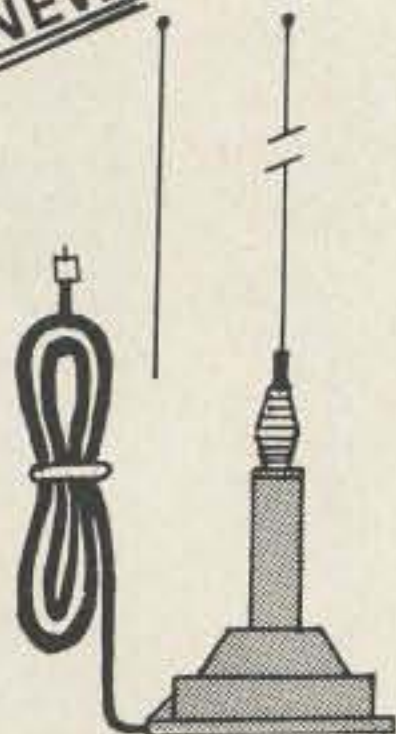

**COMPARE!!** Nothing Else Does!

### KDK MAX II

**TWIN ANTENNA**

- SUPER 80 LB. 100 M.P.H. BLACK MAGNETIC MOUNT
- 3/8 WAVE FOR MAX II SIGNAL AND
- 1/4 WAVE FOR CLOSE-IN AND RESTRICTED HEIGHT AREAS
- INSTANT CHANGE-OVER
- SUPERIOR PERFORMANCE
- STAINLESS STEEL SPRING AND WHIP, CHROME ON BRASS BASE - COMPARE!
- COMPLETE WITH 17' COAX AND CONNECTOR

REG. \$29.95

**SALE \$25<sup>00</sup>**



**SUPERB!  
NEW ICOM  
IC-701S  
H.F. XCEIVER**

Please Call or Write for Special Package Price

**ORDER NOW TOLL-FREE**

Credit Card Holders May Use Our Toll Free Ordering Number

**ASK FOR OPERATOR 701**

**(800) 824-7888**

IN CALIFORNIA (800) 852-7777

ALASKA and HAWAII (800) 824-7919

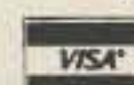
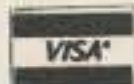

8817 S.W. 129 Terr.

Miami, Fla. 33176

Tel: (305) 233-3631

✓ A21



## MFJ SUPER CW/SSB FILTERS

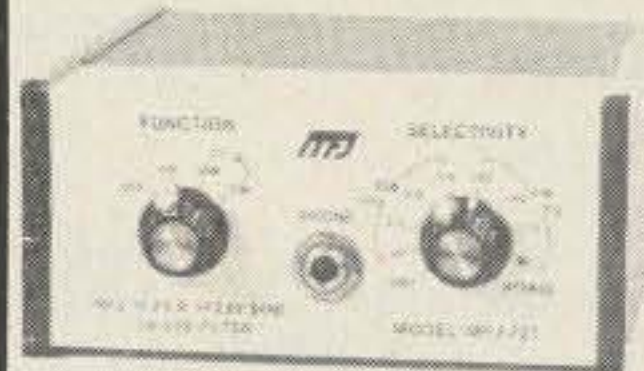

**\$59<sup>95</sup>**

**MFJ-721 SUPER SELECTOR CW/SSB FILTER** gives 80 Hz BW, steep SSB skirts, noise limiting.

**CW Filter** gives 80 Hz BW. No ringing. 8 poles give super steep skirts (60 dB down one octave from center freq. of 750 Hz). No tunable filter can match performance. BW: 80, 110, 150, 180 Hz. Reduces noise up to 15 dB.

**SSB Filter** improves readability. Reduces splatter, hiss, static, noise, hum. IC active filter has 375 Hz highpass cutoff; 2.5, 2.0, 1.5 KHz (36 dB/octave) lowpass cutoffs.

**Works with any rig.** AM, SSB, CW. Plugs into phone jack. 2 watts for speaker. Inputs for 2 rigs. Speaker and phone jacks. Phones disable speaker. OFF bypasses filter. 9-18 VDC, 300 ma. 10x2x6 in. Optional AC adapter, \$7.95.

**Switchable noise limiter** for impulse noise; trough clipper removes background noise.

**Simulated stereo for CW** lets ears, brain reject QRM. Yet, hear off frequency calls.



**\$44<sup>95</sup>**

**THIS NEW MFJ-720 DELUXE SUPER CW FILTER** gives you 80 Hz BW that is 60 dB down one octave from center frequency. 8 poles give super steep skirts with no ringing for razor sharp selectivity that no tunable filter can match.

**Bandwidths:** 80, 110, 180 Hz. Center freq.: 750 Hz. Up to 15 dB noise reduction.

**Noise limiter.** Plugs in phone jack. 2 watts for speaker. 2x4x6 inches. Requires 9-18 VDC, 300 ma. Optional AC adapter, \$7.95.



**\$29<sup>95</sup>**

EACH



**THE CWF-2BX SUPER CW FILTER AND SBF-2BX SSB FILTER** are same as in the MFJ-721, less speaker amplifier, noise limiter. Plus in rig to drive phones or connect between audio stage for speaker operation. 9 V battery. 2x3x4 in.

**Try it.** If not delighted return within 30 days for refund (less shipping). One year unconditional guarantee. **Order today.** Call toll-free 800-647-1800, charge VISA, MC. Or mail check, money order. Add \$3.00 shipping. ✓ M52

**CALL TOLL FREE ... 800-647-1800**

For technical information, order/repair status, in Miss., outside continental USA, call 601-323-5869.

**MFJ ENTERPRISES, INC.**

BOX 494, MISSISSIPPI STATE, MS 39762

# EIMAC 3-500 Z

## Special price — limited quantity

### \$150.00/pair

ALL CRYSTALS \$4.95

**TEKTRONIX**  
1LS Spectrum Analyzer  
plug-in  
50 Hz - 1MHz \$899.00

#### MURATA CERAMIC FILTERS

Model SFD-455D

455 kHz \$3.00

Model SFB-455D

455 kHz \$2.00

**TEKTRONIX**  
IL30 Spectrum Analyzer plug-in  
925MHz-10.25GHz \$899.00

Type: CFM-455E 455 kHz \$7.95

Type: SFE-10.7 10.7 MHz \$5.95

**MEASUREMENTS Model 800**  
Standard Signal Generator  
19 MHz - 475 MHz FM \$750.00

#### HEWLETT PACKARD UHF, VHF, AND MICROWAVE SIGNAL GENERATORS AND SWEEPERS, AND OTHER EQUIPMENT

**MODEL 434A**  
Calorimetric power meter  
\$450.00

**MODEL 416A**  
Ratio meter  
\$125.00

**MODEL 413AR**  
DC null voltmeter  
\$112.50

**MODEL 400DR**  
Vacuum tube voltmeter  
\$79.95

**MODEL 616B/A**  
1.8 to 4.2 GHz  
only \$399.00

**MODEL 618B**  
3.8 to 7.6 GHz  
only \$499.99  
A Model \$299.00

**MODEL 606A**  
50 kHz to 65 MHz  
.1mV to 3V into 50 ohms  
\$1,000.00

**MODEL 683C**  
2 to 4 GHz  
ONLY \$299.00

**MODEL 612A**  
450 to 1230 MHz  
.1uv to .5uv into 50 ohms  
ONLY \$499.99

**MODEL TS510/U HP608D**  
10 MHz to 420 MHz  
.1V to .5V  
\$399.95

**MODEL 620A**  
7 to 11 GHz  
.223V to 1uv.  
\$699.99

**302A with a 297A**  
Wave Analyzer and Sweep Drive  
20 HZ to 50 kHz  
\$799.00

#### WISPER FANS

This fan is super quiet, efficient cooling where low acoustical disturbance is a must.  
Size 4.68" x 4.68" x 1.50", Impedance protected, 50/60 Hz 120 volts AC  
ONLY \$9.95 or 2/\$18.00

#### TRW BROADBAND AMPLIFIER MODEL CA615B

Frequency response 40 to 300 MHz  
Gain

300 MHz 16dB MIN.  
17.5dB MAX.

50 MHz 0 to -1dB from 300 MHz  
Voltage

24 volts DC at 220ma MAX

only \$19.95

#### CARBIDE CIRCUIT BOARD DRILL BITS

Size	Price	Size	Price
35	\$2.15	58	\$1.85
42	\$2.15	59	\$1.85
47	\$2.15	60	\$1.85
49	\$2.15	61	\$1.85
50	\$2.15	62	\$1.85
51	\$2.15	63	\$1.85
52	\$2.15	64	\$1.85
53	\$1.85	65	\$1.85
54	\$1.85	66	\$1.90
55	\$1.85	1.25 mm	\$1.85
56	\$1.85	1.45 mm	\$1.85
57	\$1.85	3.20 mm	\$3.58

#### MICROWAVE DIODES

H.P. 2835	2.20
MA4882	5.00
MBD101	1.89
MBD102	1.98
1N831	8.00
1N5711	2.20
1N5712	3.45

#### INTEGRATED CIRCUITS

MC1303L	\$2.00	MC1463R	\$5.15
MC1461R	6.90	MC1469R	3.55
MC1469G	2.05	MC1560G	10.20
MC1550G	1.50	MC1563R	10.00
MC1560R	12.40	MC1568L	5.00
MC1568G	5.31	MC1590G	6.50
MC1569R	8.15	MC1648L	4.70
MC4024P	3.82	MC1648P	3.75
MC6820P	6.95	MC68B21P	12.00
2513	6.95	TMS4060	6.95
8080A	3.95	TMS4024	13.90
2716TI	29.95		
MC1460R	5.40		

19.2 kHz	2.4 MHz	3.1545 MHz	5.604 MHz	7.79850 MHz	23.25 MHz
37.35	2.42	3.158	5.61482	7.80150	23.575
49.710	2.4375	3.1585	5.619	7.81	25.9
70	2.44275	3.1615	5.6115	7.926667	25.99961
81.9	2.4495	3.1625	5.6265	8.00769	26.66667
96	2.45	3.166	5.62963	8.075	26.8965
225	2.46125	3.16975	5.6415	8.15571	26.9
250	2.482	3.177	5.64444	8.364	26.958
285.714	2.486	3.181	5.6715	8.820	27.70
576	2.5	3.1825	5.675	8.8285	27.7778
720	2.51375	3.18475	5.680	8.837	27.845
1.0000 MHz	2.56	3.1885	5.695	8.8455	27.9
1.2288	2.581	3.2035	5.7	8.854	28.728
1.3047	2.604	3.20725	5.70370	8.8625	28.88889
1.455	2.6245	3.2105	5.7105	8.871	28.9
1.689600	2.618	3.2165	5.733333	8.879500	28.93888
1.7	2.62825	3.2175	5.74815	8.888	29.896
1.76375	2.633125	3.2315	5.80741	8.905	29.9
1.77125	2.639	3.23275	5.83704	8.9135	30.0000
1.773125	2.63575	3.2365	5.85185	8.9305	30.9
1.78675	2.64325	3.23775	5.8968	8.939	31.0000
1.80224	2.646	3.2385	5.92593	8.956	31.11111
1.81875	2.647	3.238875	5.95556	9.0265	31.66667
1.845125	2.650750	3.23925	6.00	9.203906	31.9
1.84375	2.6545	3.24	6.155	9.37491	32.0000
1.845625	2.65825	3.24025	6.16296	9.545	32.22222
1.84575	2.660	3.2405	6.210	9.555	32.6
1.846	2.662	3.241	6.22222	9.565	32.9
1.84825	2.66575	3.2425	6.25185	9.585	33.0000
1.84975	2.6695	3.244	6.28146	9.65	33.33333
1.8575	2.677	3.248875	6.31111	9.7	33.9
1.908125	2.68075	3.24925	6.321458	9.75	34.0000
1.925	2.681	3.24975	6.37037	9.8	34.4444
1.925125	2.6845	3.2515	6.380416	9.85	34.44444
1.927	2.68825	3.253625	6.380833	9.9	35.0000
1.932	2.69575	3.255	6.381041	9.934375	35.55555
1.982	2.702	3.256125	6.381666	9.95	36.0000
1.985	2.704	3.258625	6.382291	9.999	36.21750
1.9942	2.71075	3.261	6.382916	10.0000	36.66667
1.995975	2.715	3.261125	6.384166	10.010	37.00000
1.964750	2.716	3.266125	6.384791	10.020	37.2175
2.0000	2.723	3.268625	6.383541	10.021	37.385
2.0285	2.730	3.271125	6.385416	10.040	37.460
2.05975	2.7315	3.273625	6.40000	10.20833	37.77777
2.125	2.73225	3.3	6.427083	10.80375	38.00000
2.126175	2.732625	3.3345	6.42963	11.0000	38.33333
2.12795	2.733	3.4045	6.45	11.13	38.77777
2.1315	2.737	3.4115	6.45926	11.1805	38.77778
2.133275	2.73975	3.4325	6.47	11.228	38.88888
2.13505	2.742125	3.4535	6.4711	11.2375	38.88889
2.136825	2.7425	3.4675	6.48889	11.27	39.00000
2.1425	2.744	3.4815	6.510	11.2995	39.160
2.144625	2.7445	3.5	6.537	11.3565	39.51851
2.14675	2.74475	3.579545	6.567	11.705	39.55555
2.148875	2.746875	3.64	6.57778	11.750	39.592593
2.151	2.751	3.656	6.582	11.755	39.629630
2.153125	2.754	3.80	6.60741	11.805	39.666667
2.15375	2.75525	3.803	6.612	11.855	39.703704
2.155	2.762375	3.805	6.645	11.905	39.74071
2.15525	2.7735	3.860	6.66667	11.955	39.777778
2.157375	2.776625	3.901	6.673	11.96125	39.81481
2.1595	2.78	3.908	6.693	11.965	39.851852
2.16375	2.790	3.9168	6.7	12.70666	39.88888
2.165875	2.814	4.0000	6.705	12.8666	39.92592
2.170125	2.817	4.011	6.723	12.925	39.962963
2.17225	2.8225	4.126666	6.7305	12.93	40.00000
2.174375	2.835	4.194	6.738	13.102	40.037037
2.1765	2.85	4.26	6.75125	13.2155	40.074074
2.17925	2.854	4.3	6.753	13.2455	40.111111
2.18475	2.854285	4.57	6.7562	13.2745	40.14814
2.18575	2.865	4.6895	6.7605	13.2845	40.18518
2.194125	2.868	4.6965	6.7712	13.2945	40.222222
2.207063	2.8725	4.7	6.77625	13.3045	40.25925
2.208313	2.876875	4.7175	6.68148	13.3145	40.29629
2.209563	2.887	4.7245	6.81482	13.3245	40.33333
2.210812	2.889	4.7315	6.84444	13.3345	40.37037
2.210813	2.894	4.765	6.87407	13.3445	40.407407
2.212063	2.910	4.89	6.880000	13.3545	40.444444
2.214562	2.920	4.90370	6.90370	13.395	40.48148
2.214563	2.925450	4.93333	6.910	14.315	40.51851
2.215625	2.92545	4.96296	6.93333	15.016	40.555556
2.217938	2.931	5.000	6.940	15.020	40.59259
2.21975	2.94375	5.13125	6.96296	15.036	40.62963
2.222125	2.945	5.139585	6.97778	16.39074	40.66666
2.22325	2.94675	5.147917	7.0057	16.39166	40.703704
2.22675	2.952	5.164583	7.17333	16.51111	40.740741
2.22875	2.966	5.21482	7.186666	16.75185	40.77777
2.23725	2.973	5.25926	7.193333	16.965	40.814815
2.2395	2.980	5.30370	7.34350	17.00925	40.85185
2.24075	2.981	5.33333	7.35	17.01018	40.88888
2.241	2.98325	5.34815	7.36296	17.015	40.925926
2.246	2.987	5.348400	7.37778	17.065	40.96296
2.2475	2.9989	5.426636	7.390	17.115	41.00000
2.2925	3.001	5.436636	7.42222	17.165	41.037037
2.2975	3.0235	5.456	7.443	17.215	43.33333
2.30000	3.045	5.4675	7.45850	17.280	45.0000
2.320	3.049	5.4990	7.4615	17.8710	47.48
2.326	3.053	5.5065	7.4685	17.9065	48.50000
2.32625	3.062	5.1111	7.4715	17.9165	49.84166
2.32825	3.067	5.515	7.473	17.9265	49.95
2.3525	3.074	5.5215	7.47850	17.9365	50.0000
2.35256	3.1125	5.52593	7.4815	17.9465	53.45
2.368	3.126	5.544	7.49850	17.9665	57.45
2.374	3.137	5.5515	7.5015	17.975	59.45
2.375	3.13975	5.559	7.62963	17.9735	60.45
2.38725	3.1435	5.5665	7.65926	17.9935	61.95
2.395	3.144	5.574	7.67407	18.290	66.66667
2.396875	3.145	5.5815	7.68889	18.330	70.0000
	3.151	5.58519	7.71852	19.100	72.855
		5.589	7.77778	20.1	75.185

Prices are subject to change. Some items are in limited quantity.

76.66667 MHz  
82.75  
83.0000  
84.0000  
90.833  
93.1346  
93.535  
93.9353  
94.3  
95.35  
106.850  
146.64  
147.09  
165.5

**Polorad Model 1206**  
1.95 to 4.20 GHz  
signal source  
\$400.00  
**Model 1107 3.8 to 8.20**  
GHz signal generator  
\$550.00

**FETS**

3N128	\$1.00
40673	1.39
MPF102	.45
MPF121	1.00
MPF131	1.00

**AA NICADS**  
Used/pull out of calculators  
79¢ each or \$59.00/100

**TUNNEL DIODES**

TYPE	PRICE
TD261A	\$10.00
TD263A	10.00
1N2930	7.65

E.F. Johnson tube socket #122-0275-001  
for 3-400Z, 3-500Z, 4-125A, 4-250A, 4-400A  
\$29.95/pair

# 2300 MHz CONVERTER KIT

- PC board and assembly instructions \$25.00
- PC board with 13 chip caps - assembled \$44.50
- PC board with all parts for assembly \$79.95
- PC board assembled and tested \$119.95

**RF TRANSISTORS**

TYPE	PRICE	TYPE	PRICE	TYPE	PRICE
2N1561	\$15.00	2N5184	2.00	MM1552	50.00
2N1562	15.00	2N5216	47.50	MM1553	56.50
2N1692	15.00	2N5583	4.43	MM1601	5.50
2N1693	15.00	2N5589	4.60	MM1602/2N5842	7.50
2N2857JAN	2.45	2N5590	6.30	MM1607	8.65
2N2876	12.35	2N5591	10.35	MM1661	15.00
2N2880	25.00	2N5637	20.70	MM1669	17.50
2N2927	7.00	2N5641	4.90	MM1943	3.00
2N2947	17.25	2N5642	8.63	MM2605	3.00
2N2948	15.50	2N5643	14.38	MM2608	5.00
2N2949	3.90	2N5645	11.00	MM8006	2.15
2N2950	5.00	2N5764	27.00	MMCM918	1.00
2N3287	4.30	2N5842	8.65	MMT72	.61
2N3294	1.15	2N5849	19.50	MMT74	.94
2N3301	.75	2N5862	50.00	MMT2857	2.68
2N3302	1.05	2N5913	3.25	MRF245	31.05
2N3304	1.48	2N5922	10.00	MRF304	43.45
2N3307	10.50	2N5942	46.00	MRF420	20.00
2N3309	3.90	2N5944	7.50	MRF450A	10.35
2N3553	1.45	2N5945	10.90	MRF476	1.38
2N3818	6.00	2N5946	13.20	MRF502	.49
2N3866	1.09	2N6080	5.45	MRF504	6.95
2N3866JAN	2.70	2N6081	8.60	MRF509	4.90
2N3866JANTX	4.43	2N6082	9.90	MRF511	8.60
2N3924	3.20	2N6083	11.80	MRF901	5.00
2N3925	6.00	2N6084	13.20	MRF5177	20.70
2N3927	11.50	2N6094	5.75	MRF8004	1.44
2N3950	26.25	2N6095	10.35	PT3539B	3.00
2N4072	1.70	2N6096	19.35	PT4186B	3.00
2N4135	2.00	2N6097	28.00	PT4571A	1.50
2N4261	14.60	2N6136	18.70	PT4612	5.00
2N4427	1.09	2N6166	36.80	PT4628	5.00
2N4429	7.50	2N6265	75.00	PT4640	5.00
2N4430	20.00	2N6266	100.00	PT8659	10.72
2N4957	3.50	2N6439	43.45	PT9784	24.30
2N4958	2.80	BFR90	3.00	PT9790	41.70
2N4959	2.12	BLY568C	25.00	PT9847	26.40
2N4976	19.00	BLY568CF	25.00	SD1043	5.00
2N5090	6.90	HEP76/S3014	4.95	SD1116	3.00
2N5108	3.90	HEPS3002	11.30	SD1118	5.00
2N5109	1.55	HEPS3003	29.88	SD1119	3.00
2N5160	3.34	HEPS3005	9.95	TA7993	75.00
2N5179	.49	HEPS3006	19.90	TA7994	100.00
		HEPS3007	24.95	40281	10.90
		HEPS3010	11.34	40282	11.90
		HEPS5026	2.56	40290	2.48
		MM1500	32.20		
		MM1550	10.00		

**MHZ ELECTRONIC KITS:**

**kit #1**  
**Motorola MC14410CP CMOS Tone Generator**  
CMOS Tone Generator uses 1MHZ crystal to produce standard dual frequency dialing signal. Directly compatible with 12 key Chomeric Touch Tone Pads. Kit includes the following:  
1 Motorola MC14410CP Chip  
1 PC Board  
And all other parts for assembly with 1 MHz crystal  
**NOW ONLY \$15.70**  
\$20.65

**Kit #2**  
**Fairchild 95H90DC Prescaler 350MHZ.**  
95H90DC Prescaler divides by 10 to 350 MHZ. This kit will take any 35MHZ Counter to 350 MHZ. Kit includes the following:  
1 Fairchild 95H90DC Chip  
1 2N5179 Transistor  
2 UG-88/U BNC Connectors  
1 PC Board  
And all other parts for assembly.  
Less 95H90 chip  
**NOW ONLY \$24.95**  
\$10.95

**FAIRCHILD VHF AND UHF PRESCALER CHIPS**

95H90DC	350MHZ Prescaler Divide by 10/11	\$ 9.50
95H91DC	350MHZ Prescaler Divide by 5/6	8.95
11C90DC	650MHZ Prescaler Divide by 10/11	16.50
11C91DC	650MHZ Prescaler Divide by 5/6	15.95
11C83DC	1GHZ Divide by 248/256 Prescaler	29.90
11C70DC	600MHZ Flip/Flop with reset	12.30
11C58DC	ECL VCM	4.53
11C44DC	Phase Frequency Detector (MC4044P/L)	3.82
11C24DC	Dual TTL VCM (MC4024P/L)	3.82
11C06DC	UHF Prescaler 750MHZ D Type Flip/Flop	12.30
11C05DC	1GHZ Counter Divide by 4	74.35
11C01FC	High Speed Dual 5-4 Input NO/NOR Gate	15.40

**CRYSTAL FILTERS: Tyco 001-19880 same as 2194F**

10.7MHZ Narrow Band Crystal Filter  
3 db bandwidth 15khz minimum 20 db bandwidth 60khz minimum 40 db bandwidth 150khz minimum. Ultimate 50 db: Insertion loss 1.0db Max. Ripple 1.0db Max. Ct. 0 + - 5pf. Rt. 3600 Ohms.  
**NOW ONLY \$5.95**

**TUBES**

2E26	\$5.00	4X150G	70.00
3-500Z	90.00	100TH	144.00
3-1000Z	225.00	572B	39.00
3B28	5.00	811A	12.95
3X2500A3	150.00	813	29.00
4.65A	54.50	5894	39.00
4-125A	68.75	6146A	5.25
4-250A	80.00	6146B	6.25
4-400A	81.50	6159	10.60
4-1000A	255.00	6293	18.50
5-500A	145.00	6360	7.95
4CX250B	38.50	6907	35.00
4CX250F	53.50	6939	9.95
4CX250G	53.50	7360	10.60
4CX250K	72.00	7984	10.40
4CX250R	48.00	8072	45.00
4CX350A	60.00	8156	7.85
4CX350FJ	70.00	8226	127.70
4CX1000A	289.00	8295A/PL172	328.00
4CX1500B	285.00	8458	25.75
4CX15000A	400.00	8560AS	50.00
4X150A	37.00	8950	5.95

**TERMS:**  
All checks and money orders are in U.S. funds!  
All orders sent first class or UPS.  
Please include \$1.50 minimum for postage.  
All prices are in U.S. dollars.  
All parts prime/guaranteed.  
5% service charge on all bank cards.



(602) 242-3037  
2111 W. Camelback  
Phoenix, Arizona 85015

**BANK AMERICARD/VISA/MASTERCHARGE**  
Your Number (or equivalent)  
Exp. Date  
Your Signature:

# GET ON PHASE THREE FOR MUCH LESS THAN YOU THINK!

## These Low Cost SSB TRANSMITTING CONVERTERS

Let you use inexpensive recycled 10M or 2M SSB exciters on UHF & VHF!

- Linear Converters for SSB, CW, FM, etc.
- A fraction of the price of other units; no need to spend \$300 - \$400!
- Use with any exciter; works with input levels as low as 1 mW.
- Use low power tap on exciter or simple resistor attenuator pad (instructions included).
- Link osc with RX converter for transceive.

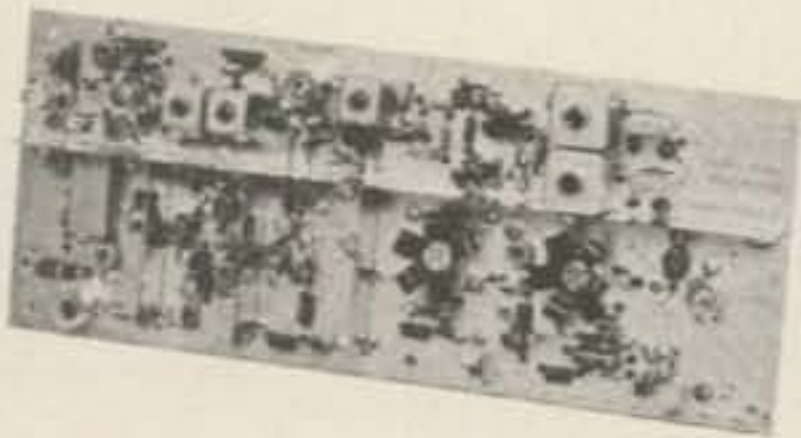

HAMTRONICS DOES IT AGAIN!

### NEW XV4 UHF KIT - ONLY \$99.95

28-30 MHz in, 435-437 MHz out; 1W p.e.p. on ssb, up to 1½W on CW or FM. Has second oscillator for other ranges. Atten. supplied for 1 to 500 mW input, use external attenuator for higher levels.

Extra crystal for 432-434 MHz range..... \$5.95

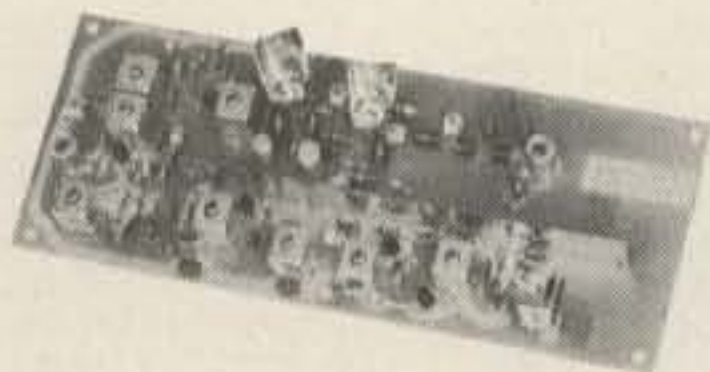

### XV2 VHF KIT - ONLY \$69.95

2W p.e.p. output with as little as 1mW input. Use simple external attenuator. Many freq. ranges available.

MODEL	INPUT (MHz)	OUTPUT (MHz)
XV2-1	28-30	50-52
XV2-2	28-30	220-222
XV2-4	28-30	144-146
XV2-5	28-29 (27-27.4 CB)	145-146 (144-144.4)
XV2-7	144-146	50-52

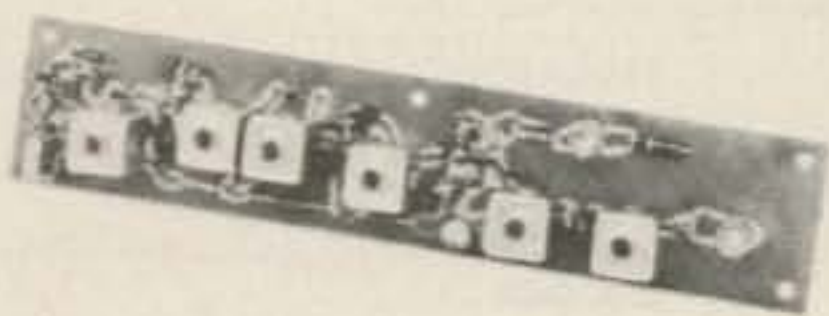

### XV28 2M ADAPTER KIT - \$24.95

Converts any 2M exciter to provide the 10M signal required to drive above 220 or 435 MHz units.

## Easy to Build FET RECEIVING CONVERTERS

Let you receive OSCAR and other exciting VHF and UHF signals on your present HF or 2M receiver

VHF KIT STILL ONLY \$34.95



MODEL	RF RANGE	OUTPUT RANGE
C28	28-32 MHz	144-148 MHz
C50	50-52	28-30
C50-2	50-54	144-148
C144	144-146	28-30
C145	145-147	28-30
or	144-144.4	27-27.4 (CB)
C146	146-148	28-30
C220	220-222	28-30
C220-2	220-224	144-148
C110 (less xtal)	Any 2MHz of Aircraft Band	26-28 or 28-30

UHF KIT ONLY \$34.95



MODEL	RF RANGE	OUTPUT RANGE
C432-2	432-434	28-30
C432-5	435-437	28-30
C432-4	432-436	144-148
C432-9	439.25	61.25

## Professional Quality VHF/UHF FM/CW EXCITERS

- Fully shielded designs
- Double tuned circuits for spurious suppression
- Easy to align with built-in test aids



T50-50	6-chan, 6M, 2W Kit.....	\$49.95
T50-150	6-chan, 2M, 2W Kit.....	\$49.95
T50-220	6-chan, 220 MHz, 1½W Kit.....	\$49.95
T450	1-chan, 450 MHz, 1W Kit.....	\$49.95

## See our Complete Line of VHF & UHF Linear PA's

- Use as linear or class C PA
- For use with SSB Xmtg Converters, FM Exciters, etc.

LPA 2-15 VHF PA, 2W in/15-20W out. Solid-state t/r switching. Kit..... \$59.95

LPA 2-45 VHF PA, 2W in/40-45W out. Can also be used with 8-10W drive. Kit..... \$109.95

LPA 4-10 UHF PA, ½W-1W in/8-10W out. Kit..... \$79.95

## FAMOUS HAMTRONICS PREAMPS

Let you hear the weak ones too! Great for OSCAR, SSB, FM, ATV. Over 14,000 in use throughout the world on all types of receivers.

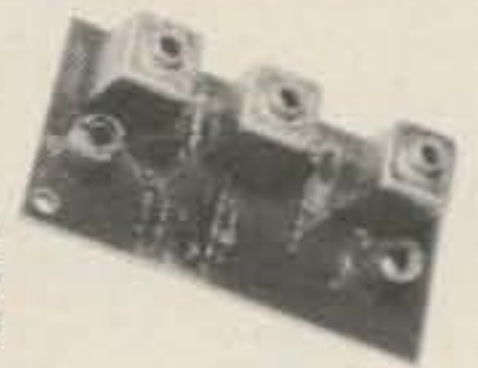

P9 Kit \$12.95  
P14 Wired \$24.95  
Specify band when ordering

- Deluxe vhf model for applications where space permits ● 1½" x 3" ● Models available to cover any 4MHz band in the 26 to 230 MHz range ● 12 Vdc ● 2 stages ● Ideal for OSCAR ● 20 dB gain

P8 Kit \$10.95  
Specify band when ordering



- Miniature vhf model for tight spaces—size only ½ x 2 ½" ● Models available to cover any 4MHz band in the range 20 to 230 MHz ● 20 dB gain ● 12 Vdc

P15 Kit \$18.95  
P35 Wired \$34.95



- Covers any 6 MHz band in UHF range of 380 to 520 MHz ● 20 dB gain ● 2 stages ● 12 Vdc

## NEW VHF/UHF FM RCVR'S

Offer Unprecedented Range of Selectivity Options

- New generation
- More sensitive
- More selective
- Low cross mod
- Uses crystal filters.
- Smaller
- Easy to align



R75A\* VHF Kit for monitor or weather satellite service. Uses wide L-C filter. -60dB at ± 30 kHz..... \$69.95

R75B\* VHF Kit for normal nbfm service. Equivalent to most transceivers. -60dB at ± 17 kHz, -80dB at ± 25 kHz... \$74.95

R75C\* VHF Kit for repeater service or high rf density area. -60dB at ± 14kHz, -80dB ± 22kHz, -100dB ± 30kHz.... \$84.95

R75D\* VHF Kit for split channel operation or repeater in high density area. Uses 8-pole crystal filter. -60dB at ± 9kHz, -100dB at ± 15 kHz. The ultimate receiver!... \$99.95

\* Specify band: 10M, 6M, 2M, or 220 MHz. May also be used for adjacent commercial bands. Use 2M version for 137 MHz WX satellites.

R85( ) UHF FM Receiver Kits, triple conversion, include C432 UHF Front End Module. Add \$20 to above prices. (Add selectivity letter to model number.)

A13-45A 6-Channel Adapter for receivers..... \$13.95

## IT'S EASY TO ORDER!

- Write or phone 716-392-9430 (Electronic answering service evenings & weekends)
- Use Credit Card, UPS COD, Check, Money Order
- Add \$2.00 shipping & handling per order

Call or Write to get FREE CATALOG With Complete Details

(Send 4 IRC's for overseas mailing)

**hamtronics, inc.**

65C MOUL RD · HILTON, NY 14468

# FREQUENCY COUNTER KIT

Outstanding Performance

Incredible Price **\$89<sup>95</sup>**

CT-50



The CT-50 is a versatile and precision frequency counter which will measure frequencies to 60 MHz and up to 600 MHz with the CT-600 option. Large Scale Integration, CMOS circuitry and solid state display technology have enabled this counter to match performance found in units selling for over three times as much. Low power consumption (typically 300-400 ma) makes the CT-50 ideal for portable battery operation. Features of the CT-50 include: large 8 digit LED display, RF shielded all metal case, easy pushbutton operation, automatic decimal point, fully socketed IC chips and input protection to 50 volts to insure against accidental burnout or overload. And, the best feature of all is the easy assembly. Clear, step by step instructions guide you to a finished unit you can rely on.

Order your today!

CT-50, 60 MHz counter kit  
 CT-50WT, 60 MHz counter, wired and tested  
 CT-600, 600 MHz scaler option, add

\$89.95

159.95

29.95

CB-1, Color TV calibrator-stabilizer

DP-1, DC probe, general purpose probe

HP-1, High impedance probe, non-loadin

\$14.95

12.95

15.95

## SPECIFICATIONS:

Frequency range: 6 Hz to 65 MHz, 600 MHz with CT-600  
 Resolution: 10 Hz @ 0.1 sec gate, 1 Hz @ 1 sec gate  
 Readout: 8 digit, 0.4" high LED, direct readout in MHz  
 Accuracy: adjustable to 0.5 ppm  
 Stability: 2.0 ppm over 10° to 40° C, temperature compensated  
 Input: BNC, 1 megohm/20 pf direct, 50 ohm with CT-600  
 Overload: 50VAC maximum, all modes  
 Sensitivity: less than 25 mv to 65 MHz, 50-150 mv to 600 MHz  
 Power: 110 VAC 5 Watts or 12 VDC @ 400 ma  
 Size: 6" x 4" x 2", high quality aluminum case, 2 lbs  
 ICS: 13 units, all socketed

## CAR CLOCK

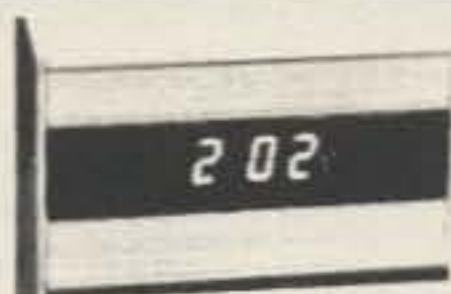

The UN-KIT, only 5 solder connections

Here's a super looking, rugged and accurate auto clock, which is a snap to build and install. Clock movement is completely assembled—you only solder 3 wires and 2 switches, takes about 15 minutes! Display is bright green with automatic brightness control photocell—assures you of a highly readable display, day or night. Comes in a satin finish anodized aluminum case which can be attached 5 different ways using 2 sided tape. Choice of silver, black or gold case (specify).

DC-3 kit, 12 hour format **\$22.95**  
 DC-3 wired and tested **\$29.95**  
 110V AC adapter **\$5.95**

## Under dash car clock



12/24 hour clock in a beautiful plastic case features: 6 jumbo RED LEDs, high accuracy (1min/mo.), easy 3 wire hookup, display blanks with ignition, and super instructions. Optional dimmer automatically adjusts display to ambient light level.

DC-11 clock with mtg. bracket **\$27.95**  
 DM-1 dimmer adapter **2.50**

## PRESCALER



Extend the range of your counter to 600 MHz. Works with any counter. Includes 2 transistor pre-amp to give super sens, typically 20 mv at 150 MHz. Specify +10 or +100 ratio.

PS-1B, 600 MHz prescaler **\$59.95**  
 PS-1BK, 600 MHz prescaler kit **49.95**

## OP-AMP SPECIAL

741 mini dip **12/\$2.00**  
 B1-FET mini dip, 741 type **10/\$2.00**

## VIDEO TERMINAL

A completely self-contained, stand alone video terminal card. Requires only an ASCII keyboard and TV set to become a complete terminal unit. Two units available; common features are: single 5V supply, XTAL controlled sync and baud rates (to 9600), complete computer and keyboard control of cursor, Parity error control and display. Accepts and generates serial ASCII plus parallel keyboard input. The 3216 is 32 char. by 16 lines, 2 pages with memory dump feature. The 6416 is 64 char. by 16 lines, with scrolling, upper and lower case (optional) and has RS-232 and 20ma loop interfaces on board. Kits include sockets and complete documentation.

RE 3216, terminal card **\$149.95**  
 RE 6416, terminal card **189.95**  
 Lower Case option, 6416 only **13.95**  
 Power Supply Kit **14.95**  
 Video/RF Modulator, VD-1 **6.95**  
 Assembled, tested units, add **60.00**

## CALENDAR ALARM CLOCK

The clock that's got it all, 6-5" LEDs, 12/24 hour, snooze, 24 hour alarm, 4 year calendar, battery backup, and lots more. The super 7001 chip is used. Size: 5x4x2 inches.

Complete kit, less case (not available) **\$34.95**  
 DC-9

## 30 Watt 2 mtr PWR AMP

Simple Class C power amp features 8 times power gain. 1 W in for 8 out, 2 in for 15 out, 4 W in for 30 out. Max output of 35 W, incredible value, complete with all parts, less case and T-R relay.

PA-1, 30 W pwr amp kit **\$22.95**  
 TR-1, RF sensed T-R relay kit **6.95**

## FM MINI MIKE KIT



A super high performance FM wireless mike kit! Transmits a stable signal up to 300 yards with exceptional audio quality by means of its built in electret mike. Kit includes case, mike, on-off switch, antenna, battery and super instructions. This is the finest unit available.

FM-3 kit **\$12.95**  
 FM-3 wired and tested **16.95**

## CLOCK KITS



our Best Seller  
 your Best Deal

Try your hand at building the finest looking clock on the market. Its satin finish anodized aluminum case looks great anywhere, while six 4" LED digits provide a highly readable display. This is a complete kit, no extras needed, and it only takes 1-2 hours to assemble. Your choice of case colors: silver, gold, bronze, black, blue (specify).

Clock kit, 12/24 hour, DC-5 **\$22.95**  
 Clock with 10 min. ID timer, 12/24 hour, DC-10 **27.95**  
 Alarm clock, 12 hour only, DC-8 **24.95**  
 12V DC car clock, DC-7 **27.95**  
 For wired and tested clocks add \$10.00 to kit price.

## Hard to find PARTS

LINEAR ICs	REGULATORS
301 \$ .35	78MG \$1.25
324 1.50	723 .50
380 1.25	309K .85
380-8 .75	7805 .85
555 .45	78L05 .25
556 .85	7905 1.25
566 1.15	7812 .85
567 1.25	7912 1.25
1458 .50	7815 .85
3900 .50	TTL ICs
CMOS ICs	74500 .35
4011 .20	7447 .65
4013 .35	7475 .50
4046 1.85	7490 .50
4049 .40	74196TI 1.35
4518 1.25	SPECIAL ICs
5369 1.75	11C90 13.50
TRANSISTORS	10116 1.25
2N3904 type 10/1.00	4511 2.00
2N3906 type 10/1.00	5314 2.95
NPN 30W Pwr 3/1.00	5375AB 2.95
PNP 30W Pwr 3/1.00	7001 6.50
2N3055 .60	4059 + N 9.00
UJT 2N2646 type 3/2.00	7208 17.95
FET MPF102 type 3/2.00	LEDs
UHF 2N5179 type 3/2.00	Jumbo red 8/1.00
MRF-238 RF 11.95	Jumbo green 6/1.00
SOCKETS	Jumbo yellow 6/1.00
8 pin 10/2.00	Mini red 8/1.00
14 pin 10/2.00	Micro red 8/1.00
16 pin 10/2.00	BiPolar .75
24 pin 4/2.00	FERRITE BEADS
28 pin 4/2.00	With info. specs 15/1.00
40 pin 3/2.00	6 hole balun 5/1.00

## Ramsey's famous MINI-KITS

### FM WIRELESS MIKE KIT

Transmits up to 300' to any FM broadcast radio, uses any type of mike. Runs on 3 to 9V. Type FM-2 has added sensitive mike preamp stage.  
 FM-1 kit **\$2.95** FM-2 kit **\$4.95**

### VIDEO MODULATOR KIT

Converts any TV to video monitor. Super stable, tunable over ch. 4-6. Runs on 5-15V, accepts std. video signal. Best unit on the market!  
 Complete kit, VD-1 **\$6.95**

### SUPER SLEUTH

A super sensitive amplifier which will pick up a pin drop at 15 feet! Great for monitoring baby's room or as general purpose amplifier. Full 2 W rms output, runs on 6 to 15 volts, uses 8-45 ohm speaker.  
 Complete kit, BN-9 **\$5.95**

### COLOR ORGAN/MUSIC LIGHTS

See music come alive! 3 different lights flicker with music. One light for lows, one for the mid-range and one for the highs. Each channel individually adjustable, and drives up to 300W. Great for parties, band music, nite clubs and more.  
 Complete kit, ML-1 **\$7.95**

### TONE DECODER

A complete tone decoder on a single PC board. Features: 400-5000 Hz adjustable range via 20 turn pot, voltage regulation, 567 IC. Useful for touch-tone decoding, tone burst detection, FSK, etc. Can also be used as a stable tone encoder. Runs on 5 to 12 volts.  
 Complete kit, TD-1 **\$5.95**

### POWER SUPPLY KIT

Complete triple regulated power supply provides variable 6 to 18 volts at 200 ma and +5V at 1 Amp. Excellent load regulation, good filtering and small size. Less transformers, requires 6.3V @ 1 A and 24 VCT.  
 Complete kit, PS-3LT **\$6.95**

### LED BLINKY KIT

A great attention getter which alternately flashes 2 jumbo LEDs. Use for name badges, buttons, warning panel lights, anything! Runs on 3 to 15 volts.  
 Complete kit, BL-1 **\$2.95**

### WHISPER LIGHT KIT

An interesting kit, small mike picks up sounds and converts them to light. The louder the sound the brighter the light. Completely self-contained, includes mike, runs on 110VAC, controls up to 300 watts.  
 Complete kit, WL-1 **\$6.95**

### SIREN KIT

Produces upward and downward wail characteristic of a police siren. 5W peak audio output, runs on 3-15 volts, uses 3-45 ohm speaker.  
 Complete kit, SM-3 **\$2.95**

**ramsey electronics**

BOX 4072, ROCHESTER, N.Y. 14610

PHONE ORDERS CALL  
 (716) 271-6487



TERMS: Satisfaction guaranteed or money refunded. COD, add \$1.50. Minimum order, \$6.00. Orders under \$10.00, add \$ .75. Add 5% for postage, insurance, handling. Overseas, add 15%. NY residents, add 7% tax.

### 16K EPROM CARD-S 100 BUSS

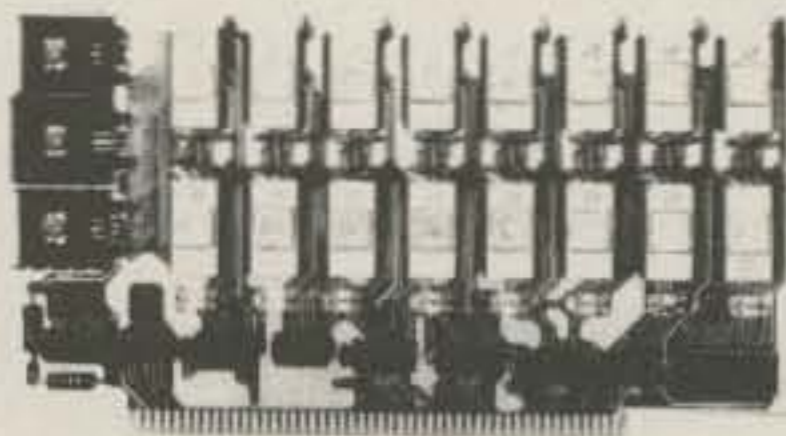

**\$59.95**  
KIT

OUR  
BEST  
SELLING  
KIT!

USES 2708's!

Thousands of personal and business systems around the world use this board with complete satisfaction. Puts 16K of software on line at **ALL TIMES!** Kit features a top quality soldermasked and silk-screened PC board and first run parts and sockets. All parts (except 2708's) are included. Any number of EPROM locations may be disabled to avoid any memory conflicts. Fully buffered and has WAIT STATE capabilities.

OUR 450NS 2708'S  
ARE \$8.95 EA. WITH  
PURCHASE OF KIT

ASSEMBLED  
AND FULLY TESTED  
ADD \$25

### 8K LOW POWER RAM KIT-S 100 BUSS SALE

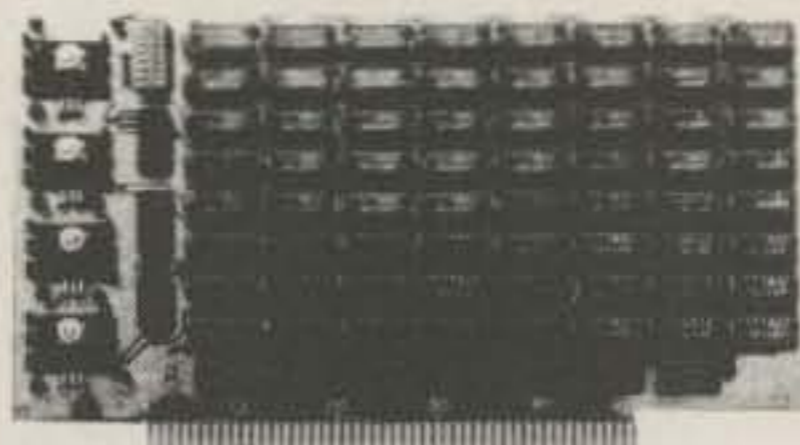

PRICE  
CUT!

**\$119.50**  
KIT

(450 NS RAMS!)

Thousands of computer systems rely on this rugged, work horse, RAM board. Designed for error-free, NO HASSLE, systems use.

#### KIT FEATURES:

1. Doubled sided PC Board with solder mask and silk screen layout. Gold plated contact fingers.
2. All sockets included.
3. Fully buffered on all address and data lines.
4. Phantom is jumper selectable to pin 67.
5. FOUR 7805 regulators are provided on card.

Blank PC Board w/Documentation  
**\$29.95**  
Low Profile Socket Set...**13.50**  
Support IC's (TTL & Regulators)  
**\$9.75**  
Bypass CAP's (Disc & Tantalums)  
**\$4.50**

ASSEMBLED AND FULLY  
BURNED IN ADD \$30

### 16K STATIC RAM KIT-S 100 BUSS

PRICE CUT!

**\$279** KIT

FOR 250NS  
ADD \$10

FULLY  
STATIC, AT  
DYNAMIC PRICES

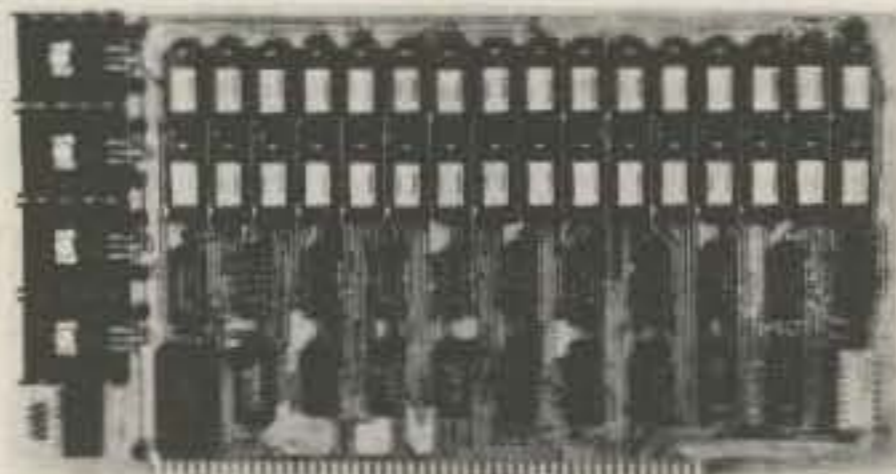

#### WHY THE 2114 RAM CHIP?

We feel the 2114 will be the next industry standard RAM chip (like the 2102 was). This means price, availability, and quality will all be good! Next, the 2114 is FULLY STATIC! We feel this is the **ONLY** way to go on the S-100 Buss! We've all heard the HORROR stories about some Dynamic Ram Boards having trouble with DMA and FLOPPY DISC DRIVES. Who needs these kinds of problems? And finally, even among other 4K Static RAM's the 2114 stands out! Not all 4K static Rams are created equal! Some of the other 4K's have clocked chip enable lines and various timing windows just as critical as Dynamic RAM's. Some of our competitor's 16K boards use these "tricky" devices. But not us! The 2114 is the **ONLY** logical choice for a trouble-free, straightforward design.

#### KIT FEATURES:

1. Addressable as four separate 4K Blocks.
2. ON BOARD BANK SELECT circuitry. (Cromemco Standard). Allows up to 512K on line!
3. Uses 2114 (450NS) 4K Static Rams.
4. ON BOARD SELECTABLE WAIT STATES.
5. Double sided PC Board, with solder mask and silk screened layout. Gold plated contact fingers.
6. All address and data lines fully buffered.
7. Kit includes ALL parts and sockets.
8. PHANTOM is jumpered to PIN 67.
9. LOW POWER: under 2 amps TYPICAL from the +6 Volt Buss.
10. Blank PC Board can be populated as any multiple of 4K.

BLANK PC BOARD W/DATA—\$33

LOW PROFILE SOCKET SET—\$12 ASSEMBLED & TESTED—ADD \$30  
SUPPORT IC'S & CAPS—\$19.95

### 16K STATIC RAM SS-50 BUSS

PRICE CUT!

**\$275** KIT

FULLY STATIC  
AT DYNAMIC PRICES

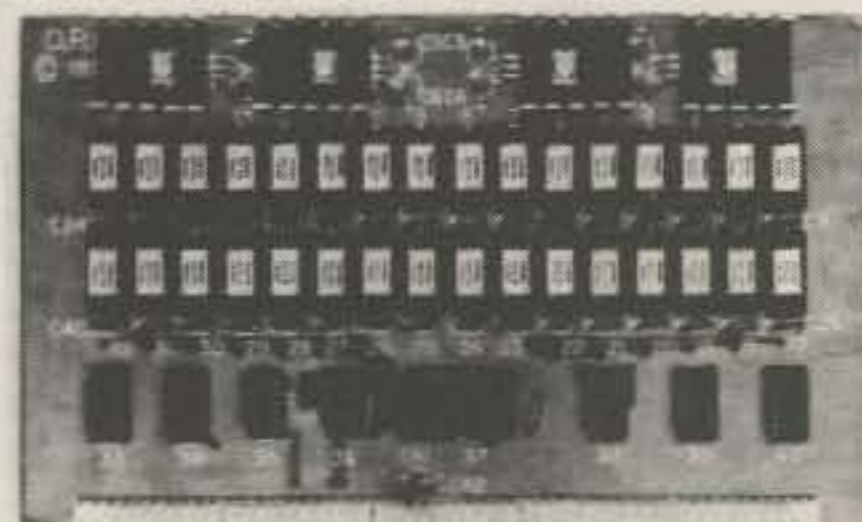

#### KIT FEATURES:

1. Addressable on 16K Boundaries
2. Uses 2114 Static Ram
3. Runs at Full Speed
4. Double sided PC Board. Solder mask and silk screened layout. Gold fingers.
5. All Parts and Sockets included
6. Low Power: Under 2 Amps Typical

FOR SWTPC  
6800 BUSS!

ASSEMBLED AND  
TESTED - \$30

BLANK PC BOARD—\$33

COMPLETE SOCKET SET—\$12  
SUPPORT IC'S AND CAPS—\$19.95

### S-100 Z80 CPU CARD

ASSEMBLED AND TESTED! READY TO USE! Over 3 years of design efforts were required to produce a **TRUE S-100 Z80 CPU** at a genuinely bargain price! **4 MHZ! \$159.95**

#### FEATURES:

- \* 2 or 4 MHZ Operation.
- \* Generates MWRITE, so no front panel required.
- \* Jump on reset capability
- \* 8080 Signals emulated for S-100 compatibility.
- \* Top Quality PCB, Silk Screened, Solder Masked, Gold Plated Contact Fingers.

Perfect For  
OEM's

### LOW POWER - 250NS 2114 RAM SALE!

4K STATIC RAM'S. MAJOR BRAND, NEW PARTS. These are the most sought after 2114's, LOW POWER and 250NS FAST. **\$7.50 ea. or 8 For \$55**  
SPECIAL SALE: (We reserve the right to limit quantities.)

PROC. TECH. QUILTS THE MICROPROCESSOR BUSINESS!  
FACTORY CLOSE OUT - SPECIAL PURCHASE!  
#16KRA

### 16K S-100 Dynamic Ram Board - \$149.95

ORIGINALLY PRICED AT \$429 each!

We purchased the remaining inventory of PT's popular 16K Ram Board when they recently closed their plant. Don't miss the boat! These are brand new, fully tested, ASSEMBLED and ready to go. All are sold with our standard 90 day limited warranty!!

72 Page Full Manual, Included Free!

NOT ASSOCIATED WITH DIGITAL RESEARCH OF CALIFORNIA, THE SUPPLIERS OF CPM SOFTWARE.

**Digital Research: Computers**  
(OF TEXAS)

P.O. Box 401565 • GARLAND, TEXAS 75040 • (214) 494-1505

TERMS: Add \$1.00 postage, we pay balance. Orders under \$15 add 75¢ handling. No C.O.D. We accept Visa, MasterCard, and American Express cards. Tex. Res. add 5% Tax. Foreign orders - except Canada add 20% P & H. 90 Day Money Back Guarantee on all items.



# BIG SCR!

2N1842 - STUD MOUNT

16 AMP - 50 PIV

**79¢ — 3 FOR \$2**

WITH HARDWARE!

# BIG TRIAC!

STUD MOUNT. ISOLATED TAB!

15 AMP - 600 PIV

BY RCA. SUPER SPECIAL!

**\$1.19 EACH**

## VARO FULL WAVE BRIDGE

6 AMPS 200 PIV

#VH248

3/4 IN. SQUARE NEW!

**89¢ ea. 4 FOR \$2.99**

## RCA SENSITIVE GATE TRIAC

TO-5 CASE. HOUSE #40531

ALSO SAME AS T2300D.

2.5 AMPS 400 PIV

**5 FOR \$1.19**

PERFECT FOR DIMMERS, COLOR ORGANS, ETC.  
PC LEADS

MICRO MINI  
TOGGLE SWITCHES  
6 for \$5 with hardware.



**99¢**  
EACH

## RCA CMOS PHASE LOCK LOOP!!

CD4046 HOUSE #. SUPER SPECIAL!!

**99¢ EACH**

We bought 350,000 LED's.  
And you get the savings.

Reds, greens, yellows, orange, small,  
medium, large. Bags of 25 - mixed **\$2.75**.  
That's only 11¢ each. Compare this bargain up to  
twice our price.

**FACTORY PRIME**

**BI - Polar LED 59¢ ea. or 10 for \$5**

### LAB-BENCH VARIABLE POWER SUPPLY KIT

5 to 20 VDC at 1 AMP. Short circuit protected by current limit.  
Uses IC regulator and 10 AMP Power Darlington. Very good  
regulation and low ripple. Kit includes PC Board, all parts,  
large heatsink and shielded transformer. 50 MV. TYP.  
Regulation. **\$15.99 KIT**

### LED BAR GRAPH AND ANALOG METER DRIVER

New from National Semi. #LM3914. Drives 10 LED  
directly for making bar graphs, audio power meters,  
analog meters, LED oscilloscopes, etc. Units can be  
stacked for more LED's. A super versatile and truly  
remarkable IC. Just out!

**SPECIAL PRICE: \$3.99 INCLUDES 12 Page Spec. Sheet**

### CLOCK MODULE OPTIONS MA1008 A and D MA1013

Switches and pot for all options.

**Includes:**

5 push buttons

1 toggle

1 10K pot

**\$2.50**

Alarm Parts (including high impedance  
transducer). Much more efficient than a  
speaker.

**\$1.50**

Transducer only (unbelievably loud!) **\$1.10**

### 16K DYNAMIC RAM CHIP WORKS IN TRS-80 OR APPLE II

16K X 1 Bits. 16 Pin Package. Same as  
Mostek 4116-4. 250 NS access. 410 NS  
cycle time. Our best price yet for this state  
of the art RAM. 32K and 64K RAM boards  
using this chip are readily available. These  
are new fully guaranteed devices by a  
major mfg.

**VERY LIMITED STOCK!**

**"MAGAZINE SPECIAL" - 8/\$79.50**

### SONY 23 WATT AUDIO AMP MODULE

#STK-054. 23 WATTS SUPER CLEAN AUDIO. 20 HZ to  
100 KHZ ± 2 DB. HYBRID, SILICON, SELF-  
CONTAINED MODULE. ONLY 1 1/4 x 2 1/2 IN. WITH  
DATA.

COMPARE AT UP TO TWICE OUR PRICE! **\$6.50 each**

### 60 Hz CRYSTAL TIME BASE \$4.95 (Complete Kit)

Uses MM5369 CMOS divider IC  
with high accuracy 3.579545  
MHZ Crystal. Use with all MOS  
Clock Chips or Modules. Draws  
only 1.5 MA. All parts, data and  
PC Board included. 100 Hz,  
same as above, except **\$5.95**.

### SILICON POWER SOLAR CELLS

2 Inch Dia. Approx. 5 VDC at 500  
MA. in sunlight. Factory new units,  
not rejects as sold by others.  
Series for higher voltage, parallel  
for higher current. Converts solar  
energy directly to electricity.

**LIMITED QUANTITY. \$5.99 ea**

### FAIRCHILD PNP

**"SUPER TRANSISTOR"**

2N4402. TO-92 Plastic. Silicon PNP  
Driver. High Current. VCEO-40 HFE-  
50 to 150 at 150 MA. FT-150 MHZ. A  
super "BEEFED-UP" Version of the  
2N3906.

**8 FOR \$1.19**

### SOUND ACTIVATED SWITCH

Not a kit. Already assembled.  
Clap your hands and turn on  
lights, music boxes, coffee pots,  
etc. Full spec. sheet with each  
unit.

**69¢ 10 for \$5.50**

### TOSHIBA POWER AUDIO AMP

5.8 WATTS RMS Typical Output. 50 to 30,000 HZ  
± 3 DB. For CB's, tape decks, PA's, etc. Works off  
of a single supply voltage from 10.5 to 18 VDC. 10  
Pin plastic DIP with special built in heat sink tab.  
Perfect for use on 12VDC.

With Data. **\$3.99 each**

NATIONAL SEMICONDUCTOR

### "COLOSSUS JR." JUMBO CLOCK MODULE

MA1013  
BRAND NEW!

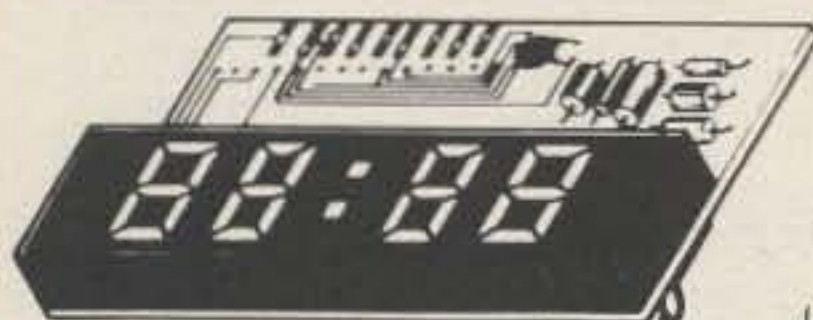

**\$8.50**

**2 FOR \$15**

(AC XFMR \$1.95)

ASSEMBLED! NOT A KIT!

MANUFACTURER'S CLOSEOUT!

PERFECT FOR USE  
WITH A TIMEBASE.

- Bright 4 digit 0.7" LED Display
- Complete-Add only Transformer and Switches
- 24 Hour Alarm Signal Output
- 12 Hour Real Time Format
- 50 or 60 Hz Operation
- Power Failure Indication
- LED Brightness Control
- Sleep and Snooze Timers
- Alarm "on" and PM Indicators
- Direct Drive - No RFI
- Direct Replacement for MA1012
- Comes with Full Data

## Digital Research: Parts

(OF TEXAS)

P.O. BOX 401247 • GARLAND, TEXAS 75041 • (214) 271-2461

**TERMS:** Add 50¢ postage, we pay balance. Orders under \$15 add  
75¢ handling. No C.O.D. We accept Visa, MasterCard and  
American Express cards. Tex. Res. add 5% Tax. Foreign orders  
(except Canada) add 20% P&H. 90 Day Money Back Guarantee on  
all items.



# SPECTRONICS, INC.

1009 Garfield St., Oak Park, Illinois • 60304

(312) 848-6777 ✓S81

## BARGAIN FAVORITES!

### OUR BEST-SELLING MULTI-BAND!



AS LOW AS  
**\$73<sup>75</sup>**

- One half the length of conventional half-wave dipoles
- Multi-band, Multi-frequency.
- Maximum efficiency — no traps, loading coils, or stubs.
- Fully assembled and pre-tuned — no measuring, no cutting.
- All weather rated — 1 KW AM, 2.5 KW CW or PEP SSB.
- Proven performance — more than 10,000 have been delivered.
- Permit use of the full capabilities of today's 5-band xcvsr.
- One feedline for operation on all bands.

40-10HD/A 40/20/15/10 Mtrs (36) . . . .	\$73.75 c
80-40HD/A 80/40 Mtr bands (69) . . . .	77.25 c
75/40HD/A 75/40 Mtr bands (66) . . . .	73.75 c
75-10HD/A 75/40/20/15/10 Mtr (66) . . . .	89.95 c
80-10HD/A 80/40/20/15/10 Mtr (69) . . . .	94.95 c

### Famous "W2AU" Balun

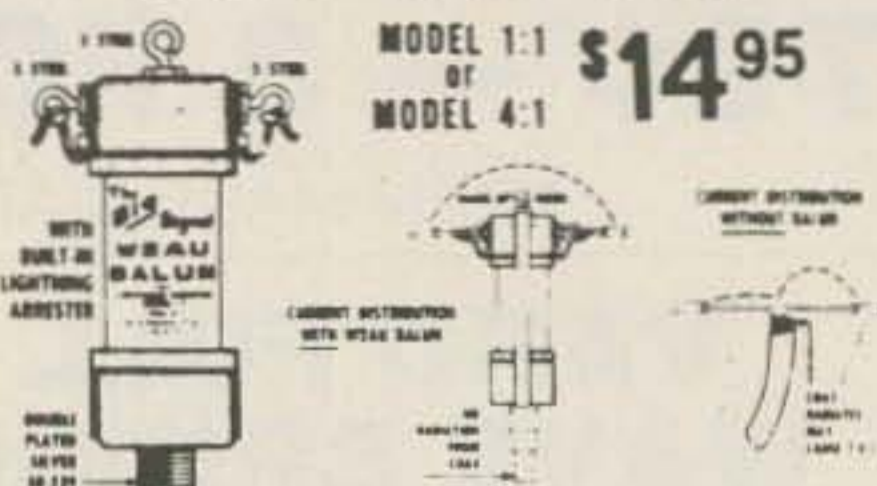

- HANDLES FULL 2 KW PEP AND THEN SOME. Broad Banded 3 to 40 Mc
- HELPS TVI PROBLEMS By Reducing Coax Line Radiation
- NOW ALL STAINLESS STEEL HARDWARE SO239 Double Silver Plated
- IMPROVES F/B RATIO By Reducing Coax Line Pick Up
- REPLACES CENTER INSULATOR. Withstands Antenna Pull of Over 600 Lbs.
- BUILT IN LIGHTNING ARRESTER. Helps Protect Balun — Could Also Save Your Valuable Gear
- BUILT IN HANG-UP HOOK. Ideal For: Inverted Vees, Multi-Band Antennas, Dipoles, Beam and Quads

NOW BEING USED BY ALL BRANCHES OF THE U.S. ARMED FORCES, FAA, RCA, CIA, CANADIAN DEFENSE DEPT. PLUS THOUSANDS OF HAMS THE WORLD OVER

Comes in 2 models. 1:1 matches 50 or 75 ohm unbalanced (coax line) to 50 or 75 ohm balanced load. 4:1 model matches 50 or 75 ohm unbalanced (coax line) to 200 or 300 ohm balanced load

Model 1:1.....\$14.95      Model 4:1.....\$14.95

### 2 METER ANTENNAS at BARGAIN PRICES!!

hy-gain 3 db GAIN  
**NEW!** MAGNETIC MOUNT  
ONLY

Model 287  
Wt. 2.5 lbs.

**\$19.<sup>95</sup>**

An economical alternative to drilling a hole. A magnetic antenna by a name you can trust at a low, low price.

Model 286 Same but trunk lid.....\$15.95 b

**NEW!** **FINCO**  
2.8 dbd GAIN  
BASE ANTENNA

ONLY **\$9.<sup>95</sup>**

Model A2-GP  
Wt. 2 lbs.

At last! An inexpensive, omni directional, 144-148 MHz. 1/2 wave antenna. Fits 1 1/4" mast, 50 ohm imp. A good antenna at a very affordable price.

**NEW!** FROM

**avanti antennas**

### ON GLASS MOBILE ANTENNAS

Modern technology lets you mount a mobile antenna right on the window. Ideal for tough installations. 3 models available

AH151.3G 144-174 MHz, 3 db gn. . . . .	\$33.95 b
AH220.3G 220 MHz, 3 db gn. . . . .	33.95 b
AH450.5G 406-512 MHz, 5 db gn. . . . .	36.95 b

### IMPROVE YOUR RECEPTION!

AN AMECO ALL-BAND PREAMP!  
• 6-160 Meters  
• 20+ dB Gain  
• Low Price

ONLY **\$49<sup>95</sup>**



MODEL PLF-2 . . . Improves weak signals as well as image and spurious rejection of most receivers. Direct switching to rec. or preamp. Includes pwr. supp. 117 VAC wired & tested . . . . . \$49.95.

### DIPOLE HEADQUARTERS

#### CABLE

8U FOAM, hi dens braid 50 ft. . . . .	\$12.95 c
8U FOAM, hi dens braid 100 ft. . . . .	24.00 e
RG58A/U stranded center 50 ft. . . . .	6.95 c
RG58A/U stranded center 100 ft. . . . .	9.95 d
RG58 3 ft w/PL259 each end. . . . .	3.35 b
RG58 5 ft w/PL259 each end. . . . .	4.39 b
RG58 50 ft w/PL259 each end. . . . .	9.95 c

#### COPPER WIRE

#14 stranded, 100 ft spool. . . . .	5.95 c
#14 solidcopper enameled 100' . . . . .	5.95 c

#### INSULATORS

Egg Ins, porcelain per pair . . . . .	.99 a
DOG BONE, porcelain set of 3 . . . . .	1.50 a
HY GAIN #155 center insulator . . . . .	5.95 b
HY GAIN Cyclocac end ins per pair . . . . .	3.95 b
MOSLEY dipole center insulator . . . . .	5.75 a

#### CONNECTORS

PL259 UHF male, 2 per pkg . . . . .	1.59 a
SO239 UHF female chassis mt . . . . .	.69 a
UG175 Adapts RG58 to PL259, pkg 2 . . . . .	.59 a
UG176 Adapts RG59 to PL259, pkg 2 . . . . .	.59 a
PL258 UHF double female . . . . .	.99 a
DM-SP UHF double male . . . . .	1.69 a
M359 90 deg UHF elbow conn. . . . .	2.10 a
UG88U BNC male for RG58 . . . . .	1.49 a
1094 BNC female . . . . .	1.49 a
M358 UHF "T" connector . . . . .	3.95 a
UG255 UHF female to BNC male . . . . .	3.49 a
UG273 BNC female to UHF male . . . . .	2.45 a

## DSI

A 550 MHz COUNTER FOR UNDER \$100.00!

**\$99<sup>95</sup>**

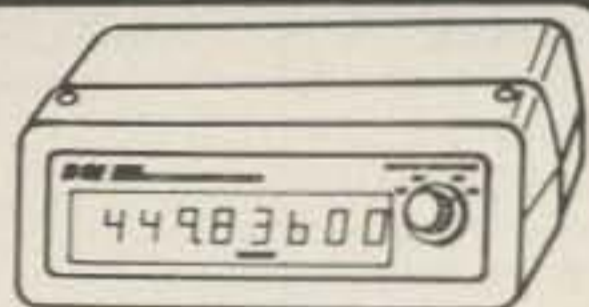

- ONE HOUR easy assembly. • 1 YEAR warranty
- 8 DIGIT readout • 1 Hz resolution • 12 VDC
- operation • 1/2 INCH LED's • 95% assembled

Whether it's adjusting a 60 Hz. time base, or netting a UHF radio, here's one low cost counter to do it all! Ideal for all types of radios, TV and PLL repair, computer maintenance & construction, and audio amplifier & Receiver repair.

3550 Kit . . . . .	\$99.95	AC-9 AC Adapter . . . . .	\$7.95
T-101 Antenna . . . . .	3.95	Shipping & Handling . . . . .	2.50

CATALOG SPECIAL —  
T101 antenna free!  
A \$3.95 value!

### NEW from HY-GAIN!

A \$269.95 Value! **ONLY** **\$221<sup>50</sup>**  
TH5DX 5 El.  
10-15-20 Meter  
Beam — Rated  
Full Legal Power  
TRUCK SHIP ONLY Output

# HF & VHF BEAMS and VERTICALS



## SPECTRONICS, INC.

1009 Garfield St., Oak Park, Illinois • 60304

(312) 848-6777

the antenna  
specialists



### 2 MTR DUCKIES

- Model HM-4. Has 5/16"-32 thread. Fits Motorola HT's. ICOM IC215 and Standard 146A ..... \$7.00
- Model HM-5. Same as above, but with PL-259 connector ..... \$7.00
- Model HM-226. Same, with TNC connector for Wilson 1405 ..... \$18.50
- Model HM-227. Same, but with BNC connector termination ..... \$12.00
- Model HM-228. With F connector for Wilson 1402 & Tempo ..... \$11.50

- HM180 2mtr, 3db trunk lip ant. .... \$33.50 b
- HM179 2mtr, 3db hole mount ant. .... 29.00 b
- HM20 2mtr, 3db for marine use. .... 39.00 b
- HM176 440MHz 5db trunk lip ant. .... 33.00 b
- HM175 440MHz 5db hole mount ant. .... 29.00 b
- HM224 220MHz 4db trunk lip ant. .... 33.50 b



- AR2 2meter Ringo base ant. .... \$24.95 b
- ARX2 2mtr Ringo Ranger base ant. . . 39.95 c
- AR220 220MHz Ringo base ant. .... 24.95 b
- ARX220 220MHz Ringo Ranger. .... 39.95 c
- AR450 UHF Ringo base ant. .... 24.95 b
- ARX450 UHF Ringo Ranger base ant. . 39.95 c
- AR6 6 meter Ringo base ant. .... 36.95 c
- ARX2K Adapts 2M Ringo to Ranger . 16.95 b
- A147-4 4 ele 2M FM beam ant. .... 24.95 b
- A147-11 11 ele 2M FM beam. .... 36.95 c
- A147-20T 10 ele 2M vert/horz twist. . 62.95 d
- A144-7 7 ele 2M CW/SSB beam. .... 26.95 c
- A144-11 11 ele 2M CW/SSB beam. .... 36.95 d
- A144-10T 10 ele Twist OSCAR ant. .... 42.95 c
- A144-20T 20 ele Twist OSCAR ant. .... 62.95 d
- A220-7 7 ele 220MHz beam. .... 26.95 c
- A220-11 11 ele 220MHz beam. .... 34.95 c
- A449-6 6 ele UHF FM beam. .... 24.95 c
- A449-11 11 ele UHF beam. .... 34.95 c
- A432-11 11el 432MHz SSB/CW beam 34.95 c
- AFM4D 144-148MHz Four Pole. .... 69.95 c
- AFM24D 220MHz Four Pole. .... 64.95 c
- AFM44D 435-450MHz Four Pole. .... 64.95 c
- ASQ-2 2M Squalo horiz ant. .... 19.95 b
- LAC-1 Coax lightning arrester. .... 4.95 a
- LAC2- Coax lightning arrester. .... 4.95 a
- ATB34 ★ 4 ele 20-10mtr beam. .... 219.95 ★
- ATV3 20-10mtr trap vertical. .... 49.95 e
- ATV4 40-10mtr trap vertical. .... 69.95 e
- ATV5 80-10mtr trap vertical. .... 89.95 e
- A50-3 3 element 6 meter beam. .... 39.95 d
- A50-5 5 element 6 meter beam. .... 59.95 e
- A28-3 ★ 3 element 10 meter beam . 69.95 ★
- A432-20T 432MHz 20 ele twist. .... 59.95 d

### 2M BASE ANT. PACKAGE



Here's what you get:

- Cushcraft AR2 Ringo South River.
- PFM71 Roof mount.
- A125-5P 5' alum mast.
- Lag bolts.
- 50' 8U foam coax.
- PL259 coax conn.

\$59<sup>95</sup>

Wt. 16 lbs.



The most rugged 6 & 2 meter beams we've seen yet!!

- A 2-10 10 ele, 2M beam ..... \$44.95 d
- A 2-5 5 ele, 2M beam, 9.5db gain. .... 27.95 c
- A 2-2 10 ele, 2M dual polarization. .... 46.50 e
- A62 6&2M antenna on one boom .... 74.95 e
- A6-5 5 element 6M beam, 11db ..... 46.50 e
- A6-3 3 ele 6M beam, 7db gain ..... 30.00 d
- A 1 1/4 220MHz 10 ele, 13.8db ..... 32.95 d



### \$9<sup>95</sup> "BUCK-BUSTER" SF-2 ANTENNA

Fits all Hustler deluxe mobile mounts. 3/8"x24 base 5/8" wave two meters, 3.4 db gain. SWR at resonance: adj. to 1.5:1 or better. Bandwidth: 6 MHz, 2:1 or better SWR. 100 watts max.

### \$7995 NEW 4-BTV VERTICAL

One setting covers 10, 15, 20, 40M. Space restricted or unlimited, you get top signal reports, consistent contacts and complete coverage. Add 5th band with a 75M resonator. Use one feedline, any length. Requires no switching or matching devices. 15 lbs.

SF-2

4-BTV

- MO1 Mobile mast ..... \$22.95 c
- MO2 Mobile mast ..... 22.95 c
- RM10 10 Meter resonator ..... 6.95 b
- RM15 15 meter resonator ..... 7.95 b
- RM20 20 Meter resonator ..... 8.95 b
- RM40 40 Meter resonator ..... 14.95 b
- RM75 75 Meter resonator ..... 16.95 b
- RM80 80 Meter resonator ..... 17.95 b
- RM10S 10M resonator 2KW PEP .... 11.95 b
- RM15S 15M resonator 2KW PEP .... 12.95 b
- RM20S 20M resonator 2KW PEP .... 13.95 b
- RM40S 40M resonator 2KW PEP .... 16.95 b
- RM75S 75M resonator 2KW PEP .... 31.95 b
- RM80S 80M resonator 2KW PEP .... 31.95 b
- CG144 5.2db 2mtr ant 3/8" x 24 stud ... 26.95 b
- CGT144 Same but trunk lip mount ... 42.95 c
- SF2 3db 2mtr ant 3/8" x 24 stud ..... 9.95 b
- SF220 3db 220MHz ant 3/8" x24 stud .. 11.95 b
- 4BTV 40-10mtr vertical ..... 79.95 e
- G6-144 2mtr base ant 6db. .... 79.95 d
- BM1 Bumper mount 3/8" x 24 thread. . 15.95 d
- RSS2 Mobile resonator spring ..... 5.95 a
- QD1 Quick disconnect 3/8" x 24 ..... 16.95 a

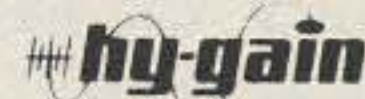

### VERTICAL ANTENNAS

- Model 14AVQ/WB ..... **SAVE \$10.00!**
- 40 thru 10 meters ..... List
- Wide band performance ..... \$69.95
- New Hy-Q traps

Self-supporting, automatic band switching vertical antenna. Omni-directional performance. Favorable L/C ratio. High Q. True 1/4 wave resonance on all bands. Low angle radiation pattern. Taper swaged seamless aluminum construction. 12" double-grip mast bracket. Full circumference compression clamps at tubing joints. Weight: 8.2 lbs.

Model 14AVQ/WB ..... 59.95

- Model 18AVT/WB ..... **SAVE \$18.00!**
- Automatic band switching ..... list
- Completely Self-Supporting ..... \$105.00
- Omni-Directional Performance

Three beefed-up Hy-Q traps permit automatic switching. 5 band capability. Favorable L/C ratio. Top loading coil. Across the band performance with one furnished setting for each band (10 thru 40). True 1/4 wave resonance on all bands. SWR of 2:1 or less at band edges. Low angle radiation pattern. Extra heavy duty tapered swaged seamless aluminum tubing with full circumference, corrosion resistant compression clamps at tubing joints. Antenna can be mounted without guide wires. 25' high. Weight: 10.7 lbs.

Model 18 AVT/WB ..... 87.00

- BN86 Ferrite balun for 80-10mtrs. .... \$15.95 a
- 155 Center insulator for doublet. .... 5.95 a
- 156 End insul. for doublet (pair) ..... 3.95 a
- 18HT ★ HyTower 80-10M vertical. .... 289.95 ★
- 18V Economy 80 tru 10M vertical. .... 29.95 c
- 12AVQ 20-10mtr trap vertical. .... 39.95 c
- 14AVQ 40-10mtr trap vertical. .... 59.95 d
- 18AVT/WB 80-10mtr trap vertical. .... 87.00 d
- 2BDQ Trap doublet for 80 & 40mtr. .... 49.95 d
- 5BDQ Trap doublet for 80-10mtrs. .... 89.95 e
- TH3 MkIII ★ 3 ele 20-10 tribander. . 189.95 ★
- TH6DXX ★ 6 ele 20-10M tribander. . 264.95 ★
- TH3 Jr 3 ele tribander (750W PEP) . 149.95 e
- HY QUAD ★ 2 ele quad 20-10 mtrs . 229.95 ★
- 103BA 3 element 10Mtr beam. .... 64.95 e
- 153BA ★ 3 element 15mtr beam. .... 79.95 e
- 204BA ★ 4 element 20mtr beam. .... 214.95 ★
- 402BA ★ 2 element 40 mtr beam. .... 204.95 ★
- 64B ★ 4 element 6 meter beam. .... 49.95 b
- 270 6db fiberglass 2M antenna. .... 49.95 b
- 203 3 element 2 meter yagi. .... 21.95 b
- 205 5 element 2 meter yagi. .... 17.95 c
- 208 8 element 2 meter yagi. .... 29.95 c
- 214 14 element 2 meter yagi. .... 34.95 d

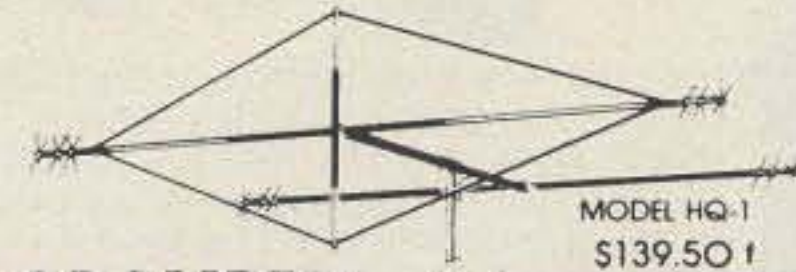

MODEL HQ-1  
\$139.50!

### CRAMPED FOR SPACE?



Then you want the antenna that's known around the world for its small size and superior performance. The Multiband HYBRID QUAD for 6, 10, 15 & 20 meters.

- WING SPAN-11 FT.
- BOOM-54 INCHES LONG
- WIND AREA-1.5 SQ. FT.
- 1200 WATTS P.E.P. INPUT TO FINAL
- FEED LINE-50 OHMS

## MFJ

GIVE US A TRY ON YOUR MFJ NEEDS. MANY TIMES WE CAN GIVE QUICKER DELIVERY THAN WHEN YOU ORDER DIRECT.

### AVERAGE SHIPPING COST GUIDE (Continental U.S.) Items sent UPS whenever possible.

Please estimate the shipping charges for your order. Any excess payment over 25c will be refunded or credited. Underpayment will be billed or sent collect. For insurance add 25c for each \$100.00 value over the first \$100.00.

WEIGHT	W/K CALL AREA			
	1,2,3,4,5	6,7	8,0	9
1 lb.	.90	1.00	.90	.85
5 lbs.	1.50	2.00	1.35	1.20
10 lbs.	2.26	3.20	1.95	1.70
20 lbs.	3.80	5.60	3.20	2.60
30 lbs.	5.30	8.05	4.40	3.50
50 lbs.	8.40	12.90	6.80	5.35

### ESTIMATED WEIGHT CODING

After the price of each item you will find a letter, i.e., 19.95 a. To make it easier to figure shipping costs, these letters indicate the approximate weight of the item as follows:

- a. Less than 1 lb.
- b. 1-3 lbs.
- c. 4-8 lbs.
- d. 7-10 lbs.
- e. 10-20 lbs.
- f. 20-30 lbs.
- g. 30-40 lbs.
- h. 40-50 lbs.

NOTE: INTERNATIONAL ORDERS write for Proforma Invoice. ITEMS MARKED ★ will be sent truck collect.

# prime products at popular prices

**MA1003 CLOCK  
MODULE \$16.50**

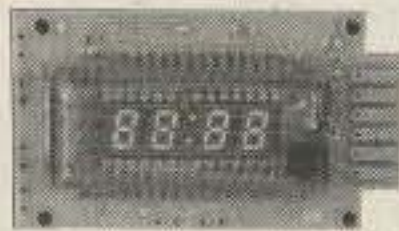

**MATCHING CASE \$5.95  
SPECIAL! CLOCK & CASE  
COMBINATION \$19.95**

Here is a clock module designed specifically for mobile applications. No external timebase necessary; a built-in timebase, accurate to .01%, provides the timing accuracy you need. We don't use wash-out prone LED displays, either; instead, you get blue/green fluorescent readouts that are as beautiful as they are readable. No time consuming, tedious assembly; just add two time setting switches, attach 12V DC, and you're ready to go (order our matching case mentioned below for a truly professional look). Additionally, our applications sheet tells you how to take maximum advantage of this module in mobile situations, including how to hook up the display so that it dims at night, and blanks to conserve power when the ignition is off.

**Also available:** Matching case with mounting hardware, and an optical filter that brings out the best in the clock readouts, for \$5.95.

This clock is not only an excellent addition to your car, van, boat or home, but also makes a great gift. Order now — you'll have it ready to go in plenty of time for holiday giving.

**12 VOLT, 8 AMP POWER  
SUPPLY KIT \$44.50**

The original hefty 12V supply, and still going strong... one look at the specs will tell you why this has been our longest-running kit. Handles 8A continuous, and 12A (!) with a 50% duty cycle. Features foldback current limiting, crowbar overvoltage protection, RF suppression, adjustable output 11-14V, heavy-duty custom wound transformer, and much more.

Applications? This supply powers mobile transceivers (ham or CB) in the home, as well as other automotive/home accessories (tape players, radios, TVs, etc.). It also makes an excellent bench supply, or can power bunches of floppy disc drives.

Assembly is about as simple as we can make it: All parts, except for transformer/power diodes/filter capacitors mount directly on the circuit board — including power transistors and heat sinks.

This supply is available from stock. Please include extra postage for this kit, as the transformer adds quite a bit of shipping weight.

**NEW! The  
Godbout  
Box is  
here!**

At last — a high quality, industrial grade home for your computer. Includes power supply. Use for either desk or rack mount. Check your local computer store for details, or write us direct... this is a product that has been needed for a long time, and we're filling that need in style.

**TERMS:** Cal res add tax. Allow 5% for shipping, excess refunded. VISA®/Mastercharge® call our 24 hour order desk at (415) 562-0636. COD OK with street address for UPS. Prices good through cover month of magazine. Thanks for your business!

**GODBOUT**  
GODBOUT ELECTRONICS  
Bldg. 725, Oakland Airport, CA 94614

**FREE CATALOG:** This ad is way too small to tell you all the things you need to know about our products, and why we feel they're second to none in the business. Send for our free catalog today.

✓ G4

**NEW S-100 COMPUTER  
PRODUCTS!**

S-100 machines are flexible, professional level systems that are easy to upgrade, modify, and adapt to specific applications. Over the years the S-100 buss has proven to be the ideal choice for commercial, industrial, and scientific applications.

We're expanding the options for S-100 systems by using the experience we've acquired in the past, mixing in the best technology offered by the present, and building products for the future... products that meet, and often exceed, the demands of the new wave of S-100 professional users. For example...

**NEW! HIGH-PERFORMANCE  
S-100 MOTHERBOARDS**

**19 slot: \$174 unkit\*, \$214 assm**  
**12 slot: \$129 unkit\*, \$169 assm**  
**6 slot: \$89 unkit\*, \$129 assm**

\*"Unkits" have edge connectors and termination resistors pre-soldered in place for easy assembly.

These 3rd generation motherboards are shielded, terminated, and designed to work with the latest 5 and 10 MHz CPUs coming on line. Fits in Godbout, Vector, IMSAI, TEI, and similar enclosures. These high quality products are a welcome addition to any system — or the start of a great one.

**2S "Interfacer" S-100 I/O Board**  
**\$189 unkit, \$249 assm, \$324 CSC\*\***

Dual serial port with 2 full duplex parallel ports for RS-232 handshake. Crystal timebase, Baud rates up to 19.2 Kbaud selectable for each port, much more.

**NEW! 3P + S "Interfacer II"  
S-100 I/O Board**  
**\$189 unkit, \$249 assm, \$324 CSC\*\***

Incorporates 1 channel of serial I/O (with all the features of a port from the 2S "Interfacer"), along with 3 full duplex parallel ports with attention/enable/strobe bits for each parallel port and individual interrupts. The versatility of each port contributes to a very versatile, and extremely flexible, I/O board.

**NEW! S-100 "Memory Manager"  
Board \$59 kit, \$85 assm, \$100 CSC\*\***

Add bank select and extended addressing to older S-100 machines — boost memory capacity beyond 64K, up to 1/2 megabyte! Use our new extended addressing memory boards, or retrofit existing memories that have phantom or extra qualifier lines.

**NEW FOR THE H8**

The latest in add-on memory: **16K Econoram XV-16** and **32K Econoram XV-32**. Both are fully static, high density/low power boards, designed from the ground up for full electrical and mechanical compatibility with the Heath H8 computer. They feature full buffering, sockets for all ICs, excellent thermal design, and a bank select option for implementing memory systems greater than 64K. 1 year limited warranty. If you've been looking for dense, cost-effective memory for the H8... you don't have to look any longer.

**Econoram XV-16 \$329 unkit\*, \$395 assm and tested**  
**Econoram XV-32 \$599 unkit\*, \$729 assm and tested**

\*Sockets and bypass caps are pre-soldered in place for easy assembly. "Econoram" is a trademark of Godbout Electronics.

★ ★ ★ **Season's Greetings** ★ ★ ★  
★ **and a Happy New Year!** ★

ETCON **AC/DC Voltage Tester**

- High visibility voltage indicator 120, 208 to 240, 277, 440 to 600 VAC; 120, 240, 400, 600 VDC.
- Positive or negative DC pole identified by neon lamps.
- Provision for quick prod storage in case.
- Case serves as prod holder for one-hand operation. Self-extinguishing, high-impact case for long life.
- Continuous duty rated thru 480V.
- Dimensions: 4-9/16" x 2-1/16" x 7/8". Color: Orange.



**VT200 \$12.95**

**Custom Cables & Jumpers**



**D9 25 Series Cables**

Part No.	Cable Length	Connectors	Price
DB25P-4-P	4 Ft.	2-DP25P	\$15.95 ea.
DB25P-4-S	4 Ft.	1-DP25P/1-25S	\$16.95 ea.
DB25S-4-S	4 Ft.	2-DP25S	\$17.95 ea.

**Dip Jumpers**

Part No.	Cable Length	Connectors	Price
DJ14-1	1 ft.	1-14 Pin	\$1.59 ea.
DJ16-1	1 ft.	1-16 Pin	1.79 ea.
DJ24-1	1 ft.	1-24 Pin	2.79 ea.
DJ14-1-14	1 ft.	2-14 Pin	2.79 ea.
DJ16-1-16	1 ft.	2-16 Pin	3.19 ea.
DJ24-1-24	1 ft.	2-24 Pin	4.95 ea.

For Custom Cables & Jumpers, See JAMECO 1979 Catalog for Pricing

**25 PIN-D SUBMINIATURE CONNECTORS (Meets RS232)**



PART NO.	DESCRIPTION	PRICE
DB25P	PLUG (as pictured)	\$2.95
DB25S	SOCKET	3.50
DB51226-1	CABLE COVER for DB25P or DB25S	1.75
DB25P-831	PLUG - Right Angle - P.C. Mount	4.95
DB25S-831	SOCKET - Right Angle - P.C. Mount	5.25

**Printed Circuit Connectors**



.156 Spacing-Tin-Double Read-Out Bifurcated Contacts Fits .054 to .070 P.C. Boards

PART NO.	DESCRIPTION	PRICE
15/30 SE	15/30 Contacts - solder eyelet	\$1.95
18/36 SE	18/36 Contacts - solder eyelet	2.49
22/44 SE	22/44 Contacts - solder eyelet	2.95
22/44 WW	22/44 Contacts - wire wrap	3.95
50/100 WW	50/100 Contacts - wire wrap (R681-1) (.125 Spacing)	6.95

**Jumbo 6-Digit Clock Kit**



- Four .630"ht. and two .300"ht. common anode displays
- Uses MM5314 clock chip
- Switches for hours, minutes and hold functions
- Hours easily viewable to 30 feet
- Simulated walnut case
- 115 VAC operation
- 12 or 24 hour operation
- Includes all components, case and wall transformer
- Size: 6 3/4" x 3 3/4" x 1 1/4"

**JE747 \$29.95**

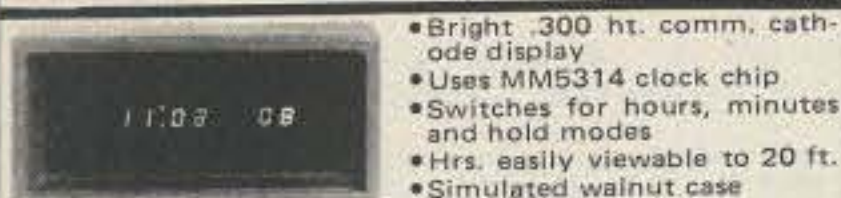

**JE701**

**6-Digit Clock Kit \$19.95**

- Bright .300 ht. comm. cathode display
- Uses MM5314 clock chip
- Switches for hours, minutes and hold modes
- Hrs. easily viewable to 20 ft.
- Simulated walnut case
- 115 VAC operation
- 12 or 24 hr. operation
- Incl. all components, case & wall transformer
- Size: 6 3/4" x 3-1/8" x 1 1/4"

**Micro-Miniature Joystick**



- 2 each 100K pots (Linear Taper)
- Printed Circuit Board Mount
- Size: 1" x 1-3/16" x 1-3/16"

**Micro-Miniature Joystick \$4.95**

**Digital Stopwatch Kit**

- Use Intersil 7205 Chip
- Plated thru double-sided P.C. Board
- LED display (red)
- Times to 59 min. 59.99 sec. with auto reset
- Quartz crystal controlled
- Three stopwatches in one: single event, split (cumulative) & taylor (sequential timing)
- Uses 3 penlite batteries
- Size: 4.5" x 2.15" x .90"



**JE900 \$39.95**

**MICROPROCESSOR COMPONENTS**

**8080A/8080A SUPPORT DEVICES**

8080A CPU	\$ 7.95
8212 8-Bit Input/Output	3.25
8214 Priority Interrupt Control	5.95
8216 Bi-Directional Bus Driver	3.49
8224 Clock Generator/Driver	3.95
8226 Bus Driver	3.49
8228 System Controller/Bus Driver	4.95
8238 System Controller	5.95
8251 Prog. Comm. 1/0 (USART)	7.95
8253 Prog. Interval Timer	14.95
8255 Prog. Periph. 1/0 (PPI)	9.95
8257 Prog. DMA Control	19.95
8259 Prog. Interrupt Control	19.95

**6800/6800 SUPPORT DEVICES**

MC6800 MPU	\$14.95
MC6802CP MPU with Clock and Ram	24.95
MC6810AIP1 128K8 Static Ram	5.95
MC6821 Periph. Inter. Adapt (MC6820)	7.49
MC6828 Priority Interrupt Controller	12.95
MC6830L8 1024X8 Bit ROM (MC6830-8)	14.95
MC6850 Asynchronous Comm. Adapter	7.95
MC6852 Synchronous Serial Data Adapt.	9.95
MC6860 0-600 bps Digital MODEM	12.95
MC6862 2400 bps Modulator	14.95
MC6880A Quad 3-State Bus. Trans. (MC6826)	2.25

**MICROPROCESSOR CHIPS - MISCELLANEOUS**

Z80(780C) CPU	\$14.95
Z80A(780-1) CPU	16.95
CDP1802 CPU	19.95
2650 MPU	19.95
6502 CPU	11.95
8035 8-Bit MPU w/clock, RAM, 1/0 lines	19.95
P8085 CPU	19.95
TMS9900JL 16-Bit MPU w/hardware, multiply & divide	49.95

**SHIFT REGISTERS**

MMS500H Dual 25 Bit Dynamic	\$ .50
MMS503H Dual 50 Bit Dynamic	.50
MMS504H Dual 16 Bit Static	.50
MMS506H Dual 100 Bit Static	.50
MMS510H Dual 64 Bit Accumulator	.50
MMS516H 500/512 Bit Dynamic	.89
2504T 1024 Dynamic	3.95
2518 Hex 32 Bit Static	4.95
2522 Dual 132 Bit Static	2.95
2524 512 Static	.99
2525 1024 Dynamic	2.95
2527 Dual 256 Bit Static	2.95
2528 Dual 250 Static	4.00
2529 Dual 240 Bit Static	4.00
2532 Quad 80 Bit Static	2.95
3341 Flip	6.95
74LS670 4X4 Register File (TriState)	2.49

**UART'S**

A-Y-5-1013 30K BAUD	5.95
---------------------	------

**MICROPROCESSOR MANUALS**

M-Z80 User Manual	\$7.50
M-CDP1802 User Manual	7.50
M-2650 User Manual	5.00

**ROM'S**

2513(2140) Character Generator(upper case)	\$9.95
2513(3021) Character Generator(lower case)	9.95
2516 Character Generator	10.95
MMS230N 2048-Bit Read Only Memory	1.95

**RAM'S**

1101 256X1 Static	\$1.49
1103 1024X1 Dynamic	.99
2101(8101) 256X4 Static	3.95
2102 1024X1 Static	1.75
21L02 1024X1 Static	1.95
2111(8111) 256X4 Static	3.95
2112 256X4 Static MOS	4.95
2114 1024X4 Static 450ns	7.95
2114L 1024X4 Static 450ns low power	10.95
2114-3 1024X4 Static 300ns	10.95
2114L-3 1024X4 Static 300ns low power	11.95
5101 256X4 Static	7.95
5280/2107 4096X1 Dynamic	4.95
7489 16X4 Static	1.75
74S200 256X1 Static Tristate	4.95
93421 256X1 Static	2.95
UPD414 4K Dynamic 16 pin	4.95

(MK4027) UPD416 16K Dynamic 16 pin 250ns	9.95
(MK4116) TMS4044 4K Static	14.95
45NL TMS4045 1024X4 Static	14.95
2117 16,384X1 Dynamic 350ns (house marked) Dynamic	4/1.00

**PROM'S**

1702A 2048 FAMOS	\$5.95
2716(INTEL) 16K EPROM	59.95
TMS2516 16K EPROM	49.95
(2716) EPROM *Requires single -5V power supply	
2716 T.I 16K** EPROM	29.95
2708 8K EPROM	89.95
2709 6K EPROM	10.95
2716 T.I 16K** EPROM	29.95

**JE600 HEXADECIMAL ENCODER KIT**



- FEATURES:**
- Full 8 bit latched output for microprocessor use
  - 3 User Define keys with one being bi-stable operation
  - Debounce circuit provided for all 19 keys
  - LED readout to verify entries
  - Easy interfacing with standard 16 pin 1C connector
  - Only +5VDC required for operation.
- FULL 8 BIT LATCHED OUTPUT-19 KEYBOARD**
- The JE600 Encoder Keyboard provides two separate hexadecimal digits produced from sequential key entries to allow direct programming for 8 bit microprocessor or 8 bit memory circuits. Three (3) additional keys are provided for user operations with one having a bistable output available. The outputs are latched and monitored with LED readouts. Also included is a key entry strobe.

**JE600 \$59.95**  
Hexadecimal Keypad only \$14.95

**DIGITAL THERMOMETER KIT**



- Dual sensors-switching control for indoor/outdoor or dual monitoring
- Continuous LED .8" ht. display
- Range: -40°F to 199°F / -40°C to 100°C
- Accuracy: ±1° nominal
- Set for Fahrenheit or Celsius reading.
- Sim. walnut case - AC wall adapter incl.
- Size: 3-1/4"H x 6-5/8"W x 1-3/8"D

**JE300 \$39.95**

**62-Key ASCII Encoder Keyboard Kit**



- FEATURES:**
- 60 Keys generate the full 128 characters, upper and lower case ASCII set
  - Fully buffered
  - 2 user-define keys provided for custom applications
  - Caps lock for upper case only alpha characters
  - Utilizes a 2376 (40 pin) encoder read only memory chip
  - Outputs directly compatible with TTL/DTL or MOS logic arrays
  - Easy interfacing with a 16-pin dip or 18-pin edge connector

The JE610 62-Key ASCII Encoder Keyboard Kit can be interfaced into most any computer system. The JE610 Kit comes complete with an industrial grade keyboard switch assembly (62 keys), IC's, sockets, connector, electronic components and a double-sided printed wiring board. The keyboard assembly requires +5V @ 150mA and -12V @ 10mA for operation.

**JE610 \$79.95**  
62-Key Keyboard only \$34.95

**REGULATED POWER SUPPLY**

Model	Description	Price
JE200	5V - 1 AMP POWER SUPPLY	\$14.95
JE205	ADAPTER BOARD - Adapts to JE200 - ±5V, ±9V and ±12V	\$12.95

- Uses LM309K
- Heat sink provided
- PC Board construction
- Provides a solid 1 amp @ 5 volts
- Can supply up to ±5V, ±9V and ±12V with JE205 Adapter
- Includes components, hardware & instructions
- Size: 3 3/8" x 5" x 2"H

The Incredible

"Pennywhistle 103"

\$139.95 Kit Only



The Pennywhistle 103 is capable of recording data to and from audio tape without critical speed requirements for the recorder and it is able to communicate directly with another modern and terminal for telephone "hamming" and communications. In addition, it is free of critical adjustments and is built with non-precision, readily available parts.

Data Transmission Method	Frequency-Shift Keying, full-duplex (half-duplex selectable).
Maximum Data Rate	300 Baud
Data Format	Asynchronous Serial (return to mark level required between each character).
Receive Channel Frequencies	2025 Hz for space; 2225 Hz for mark.
Transmit Channel Frequencies	Switch selectable: Low (normal) = 1070 space, 1270 mark; High = 025 space, 225 mark
Receive Sensitivity	-46 dbm acoustically coupled
Transmit Level	-15 dbm nominal. Adjustable from -6 dbm to -20 dbm.
Receive Frequency Tolerance	Frequency reference automatically adjusts to allow for operation between 1800 Hz and 2400 Hz.
Digital Data Interface	EIA RS-232C or 20 mA current loop (receiver is optoisolated and non-polar).
Power Requirements	120 VAC, single phase, 10 Watts.
Physical	All components mount on a single 5" by 9" printed circuit board. All components included.

Requires a VOM, Audio Oscillator, Frequency Counter and/or Oscilloscope to align

**TRS-80**

**16K Conversion Kit**

- Expand your 4K TRS-80 System to 16K.
- Kit comes complete with:
- 8 each UPD416-1 (16K Dynamic Rams) 250NS
- Documentation for conversion

**TRS-16K \$75.00**

**JUST WRAP™**

- 30 AWG wire
- Daisy chain or point-to-point
- No stripping or slitting required-just wrap
- .025" square posts
- Built-in cut off
- Includes 50 ft. wire

Part No.	Wire Color	Price
JW-1-B	Blue	\$14.95
JW-1-W	White	14.95
JW-1-Y	Yellow	14.95
JW-1-R	Red	14.95

**JUST WRAP™ Replacement Wire**

Part No.	Color	Price
R-JW-B	Blue	50 ft. roll \$2.98
R-JW-W	White	50 ft. roll 2.98
R-JW-Y	Yellow	50 ft. roll 2.98
R-JW-R	Red	50 ft. roll 2.98

**JUST WRAP™ Unwrap Tool \$3.49**

**JUST WRAP™ Kit** • 50 ft. ea.: blue, white, red, yellow wire  
• JUST WRAP Tool • Unwrapping Tool

**JWK-6 \$24.95**

**Vacuum Vise**

**VV-1 \$3.49**

Vacuum-based light-duty vise for small components and assemblies. ABS construction. 1 1/2" jaws, 1/4" travel. Can be permanently installed.

**EPROM Erasing Lamp**

- Erases 2708, 2716, 1702A, 5203Q, 5204Q, etc.
- Erases up to 4 chips within 20 minutes.
- Maintains constant exposure distance of one inch
- Special conductive foam liner eliminates static build-up
- Built-in safety lock to prevent UV exposure
- Compact - only 7-5/8" x 2-7/8" x 2"
- Complete with holding tray for 4 chips

**UVS-11E \$69.95**

**IDEAL FOR TRS 80 CASSETTE CONTROLLER**

Plug/Jack interface to any computer system requiring remote control of cassette functions.

The CC100 controls cassette motor functions, monitors tape location with its internal speaker and requires no power. Eliminates the plugging and unplugging of cables during computer loading operation from cassette.

**#CC-100 \$29.50**

# ASSOCIATED RADIO

913-381-5900

8012 CONSER BOX 4327

OVERLAND PARK, KANSAS 66204



CALL US WITH YOUR REQUIREMENTS  
**AMERICA'S NO. 1 Real Amateur Radio Store**



**(Associated Wants to TRADE - BUY - SELL  
GOT YOUR BEST DEAL? THEN CALL US AT  
913-381-5900 - NO TRADE? ASK FOR EXT. 12)**

**NOTE: SEND \$1.00 FOR OUR CURRENT CATALOG  
OF NEW AND RECONDITIONED EQUIPMENT.**

**\* ALSO WE PERIODICALLY PUBLISH A LIST OF  
UNSERVICED EQUIPMENT AT GREAT SAVINGS.  
A BONANZA FOR THE EXPERIENCED OPERATOR.  
TO OBTAIN THE NEXT UNSERVICED BARGAIN LIST,  
SEND A SELF ADDRESSED STAMPED ENVELOPE.**

**1¢ SALE** WE'RE BACK WITH OUR WORLD FAMOUS INFLATION FIGHTIN'  
**'ONE CENTERS'**

**Only 2 FOR \$14.99 \$15**  
**DIAL DESK TELEPHONE**  
 Cat. No. 92CU5653



**HY-GAIN ONE ARM BANDIT MIKES**  
 Only \$14.99 2 FOR \$15

Take one hand command of your mobile or base rig with Hy-Gain's One Arm Bandit Mike. ON/OFF, VOLUME, SQUELCH, CHANNEL SELECTOR, SPEAKER, and DIGITAL DISPLAY are all conveniently located where your fingers do the talking. Comes with 6 ft. multi-conductor, color-coded, coiled cable, (separate) for easy integration into any type of rig. Size: 4 1/2" x 2 1/4" x 1 1/2". Wt. 9 oz. No. 92CUS886



**40 CHANNEL CB BOARD \$12.50**  
 WITH 2 FOR SWITCH \$12.51

Poly Paks buys up factory close-out from Hy-Gain... so you gain! Boards have: Heatstaked 9 Watt Amp Chip, RF and Mod. Transistors, and Motorola MC series PLL. May be used for 10 meter conversion. (see continuing series "CB to 10" in 73 magazine). The parts alone make it an offer you can't refuse. Wt. 9 oz. Cat. No. 92CUS554



**LEDS! LEDS! LEDS!**  
 YOUR CHOICE 5 for \$1.29 1¢ SALE 10 for \$1.30

Cat. No. Type  
 1788 MICRO TOPHAT RED  
 1802 MICRO SINGLE PIN RED  
 1948 MICRO YELLOW  
 2135 JUMBO RED  
 2136 JUMBO TAPER RED  
 2137 MICRO RED  
 1944 Jumbo Yellow  
 2138 Jumbo Green



**6 AMP EPOXY "BULLET" RECTIFIERS**  
 Order by Cat. No. 92CU6095 and Voltage

PRV	PRICE	SALE
50	\$ .39	2 for .40
100	.49	2 for .50
200	.59	2 for .60
400	.69	2 for .70
600	.79	2 for .80
800	.89	2 for 1.00

**25 AMP BRIDGE RECTIFIERS**

PIV	SALE	2 FOR
25	1.25	1.26
50	1.95	1.96
100	2.25	2.26
200	2.95	2.96
400	3.50	3.51
600	4.25	4.26
800	4.95	4.96

Order No. 2273 & voltage

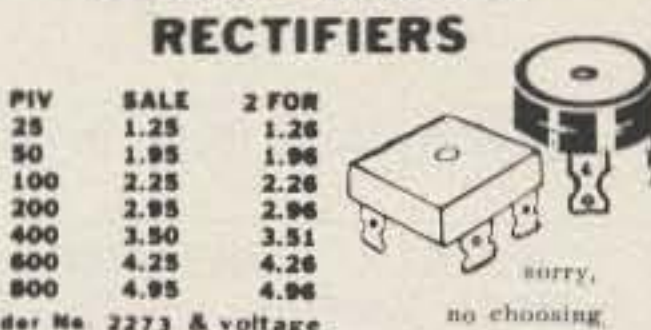

**ULTRASONIC TRANSDUCER**  
**\$3.98 2 for \$3.99**

Perfect for dozens of projects, including remote control devices, alarms, etc. Sends and Receives! 1" diameter, 3/8" deep, with standard RCA type phono jack. Wt. 2 oz. Cat. No. 92CUS375



**FANTASTIC? YOU BET IT IS! LOOK WHAT YOU GET FOR 1¢ MORE!**

1-LASCR OPTO COUPLER, type H11C3, mini dip, (#5700)	1.29	2 for 1.30
3-LINE CORDS, 6 ft. 18 gauge, 2 cond. white w/plug, (#3787)	1.29	6 for 1.30
15-SINGLE PIN MICRO RED LEDES, 100% material, 3 volts @ 10 mils, (#5896)	1.29	30 for 1.30
40-FEEDTHRU CAPACITORS, used for hams, RF, UHF circuitry, (#5668)	1.29	80 for 1.30
40-PLASTIC TRANSISTORS, asst'd untested and hobby, (#2604A)	1.29	80 for 1.30
6-6V INDICATORS, w/leads, test lamp manufacturers excess, (#5893)	1.29	12 for 1.30
40-METAL CAN TRANSISTORS, asst'd types, hobby, untested, (#2603A)	1.29	80 for 1.30
10-UPRIGHT ELECTRODS, 100% asst'd values and voltages, (#5900)	1.29	20 for 1.30
40-SEMI-CON SUPRICE, zeners, rectifiers, transistors, etc, U-test, (#2226)	1.29	80 for 1.30
65-STABISTORS, axial, for regulators & computers, U-test, (#3140)	1.29	130 for 1.30
40-SQUARE PC COILS, uprights, assorted values, for PC applications, (#3188)	1.29	80 for 1.30
50-1 AMP ZENERS, 3.3,8,10,12,15V, etc., double plug, untested, (#1964)	1.29	100 for 1.30
4-ROCKER SWITCHES, DPDT, solder eyelet terminals, (#3302)	1.29	8 for 1.30
60-LONG LEAD DISCS, 100% prime, marked capacitors, (#5899)	1.29	120 for 1.30
6-MINI TRANSFORMERS, asst'd outputs, interstage & audio, 1" sq., (#3295)	1.29	12 for 1.30
1-TV/AUDIO SHIELDED CABLE, 2 cond. 15 ft. w/RCA phone plugs, (#5812)	1.29	2 for 1.30
25-DATA ENTRY KEYCAPS, 1/2" sq. #s & functions, asst. colors, (#4013)	1.29	50 for 1.30
2-GE 3W AUDIO AMP, type PA-263 IC chip, mono, (#1522)	1.29	4 for 1.30
1-MERCURY TILT SWITCH, N.C. rated 24VDC @ .05A, w/leads, (#5686)	1.29	2 for 1.30
6-POWER TAB TRIACS, 100% prime, 100V, TO-220, (#5888)	1.29	12 for 1.30
6-POWER TAB SCR's, 100% prime, 100V, TO-220, (#5904)	1.29	12 for 1.30
2-WATCH LCD's, 3 1/2 digit, asst. types, size: 1" x 1 1/2" (approx), (#5066)	1.29	4 for 1.30
4-TV INTERLOCK JACKS for TV/power mt. ctr. solder tab terms., (#5519)	1.29	8 for 1.30
4-MOS FETS, 3N128, by Fairchild & RCA, TO-18, some duals, (#1686)	1.29	8 for 1.30
4-PHOTO ELECTRIC DARLINGTON TRANSISTORS, 2N5777, (#3276)	1.29	8 for 1.30
6-AC "UTILITY" OUTLETS, for 1 1/2" mt. ctr., solder lugs, (#3582)	1.29	12 for 1.30
15-NE-2 LAMPS, neon red, for 110VAC, less resistor, (#1435)	1.29	30 for 1.30
20-1N4148 SWITCHING DIODES, 4nS, 100V @ 10mA, axial 100%, (#3000)	1.29	40 for 1.30
2-4 AMP SILICON BRIDGE RECTIFIER, 200V, block style, (#5928)	1.29	4 for 1.30
4-VARACTOR DIODES, var. tuner capacitance, 20-50 pf., (#50887)	1.29	8 for 1.30
50-PRECISION RESISTORS, 1/2, 1, & 2 watts, 1%, assorted types, (#363)	1.29	100 for 1.30
60-CERAMIC CAPS, asst'd val. & styles, incl; tubulars, NPO's, etc., (#590)	1.29	120 for 1.30
25-PLASTIC SCR's, incl; 200V, untested, high yield, TO-92, (#3192)	1.29	50 for 1.30
40-MOLDED CAPACITORS, tubular, asst'd volt. to 1 mf. axial leads, (#348642)	1.29	80 for 1.30
60-MICRO ZENER & RECT. KIT, asst'd voltages, only 1/8" sq. U-test, (#1251)	1.29	120 for 1.30
1-LINE CORD, 8 ft. 2 cond. 16 gauge, vinyl molded plug & grommet, (#3661)	1.29	2 for 1.30
6-SPDT MICRO SLIDE SWITCH, only 3/7" cube, for PC mount, (#3429)	1.29	12 for 1.30
10-PR. RCA PLUGS & JACKS, for audio, speakers, etc., (#402)	1.29	20 for 1.30
5-2N3055 HOBBY TRANSISTORS, TO-3, (#3771)	1.29	10 for 1.30
10-ZENERS, 1 watt 9.1 volts axial leads 100% (#5370A)	1.29	20 for 1.30
40-1N4148, 4 NANO, SWITCHING DIODE, axial leads untested (#5923)	1.29	80 for 1.30
2-RELAYS, BABCOCK 6VDC, SPST, plastic case (#5807)	1.29	4 for 1.30
1-25 AMP BRIDGE RECTIFIER, 50 volts, 100% (#5948)	1.29	2 for 1.30
2-QUADRACS, 10 amp 200 PRV, TO-220 100% (#5915)	1.29	4 for 1.30
60-MINI RESISTORS, 30-1/2W, 30-1/4 watt, axial, color coded, (#5922)	1.29	120 for 1.30
12-SCRS-TRIAC-QUADRACS, asst. volts. TO-220 case (#2087)	1.29	24 for 1.30
10-BULLPLATES, asst. resistor/capacitor networks, various styles, (#5880)	1.29	20 for 1.30
2-AIR TRIMMER CAPS, alum. plates, 1/2" shaft, panel mt. solder lugs, (#5658)	1.29	4 for 1.30
30-MOLEX CONNECTORS, nylon, asst'd styles, colors, & # of cond., (#5835)	1.29	60 for 1.30
1-3 COND. LINE CORD, 8 ft. flat, w/ring terminals, 2 AC, 1 GND, (#5703)	1.29	2 for 1.30
4-12 VOLT LAMPS, w/leads, popular voltage, 100's of uses, (#5942)	1.29	8 for 1.30
25-TTL IC's, untested, asst'd gates, flip flops, etc. 14-16 pin, (#5955)	1.29	50 for 1.30
20-1000 PIV GLASS AMPS, micro-mini, axial, silicon, rated @ 1A, (#5903)	1.29	40 for 1.30
1-12 VCT 200 mA TRANSFORMER, 115 V prim., PC mount, (#5977)	1.29	2 for 1.30
20-400 mW 15V ZENERS, micro-style, asst. epoxy & glass, 100%, axial, (#5914)	1.29	40 for 1.30
100-UNMARKED CAPS, popular values, mylars & polystyrene, 100%, (#5892)	1.29	200 for 1.30
60-ONE WATT ZENERS, assorted voltages, glass pak, dbl plug, U-test, (#5947)	1.29	120 for 1.30
50-MICRO ZENERS, 1 watt, 2-30V, DO-7 & micro epoxy, axial, 100%, (#5905)	1.29	100 for 1.30
500pc-HARDWARE SURPRISE, asst screws nuts & washers, (#5891)	1.29	1000 for 1.30
60-GLASS AMPS, up to 1KV, 1N4000 series, glass encased, untested, (#5982)	1.29	120 for 1.30
200-PC BOARD PARTS, boards loaded w/100% parts, hobby bonanza, (#5946)	1.29	400 for 1.30
6-RF NPN TRANSISTORS, type-2N1059, BVcbo: 40V, TO-22, 100%, (#5895)	1.29	12 for 1.30
2-BRASS DOOR LOCKS, w/key, for doors windows, etc. 2-1/8" mt. ctr. (#5949)	1.29	4 for 1.30
1-PUSH-PUSH CB SWITCH, DPDT, 1 x 3/8" x 3/8", 100's of uses, (#3463)	1.29	2 for 1.30
30-"CRIMP-ON" TERMINALS, rings and spades, for # 12-20 wire, (#3955)	1.29	60 for 1.30
50-ONE-WATT RESISTORS, popular assort, some 5%ers, 100's of uses, (#3844)	1.29	100 for 1.30
50-METALLIC FILM 1/2 WATERS, asst. values, marked, axial leads, (#1605)	1.29	100 for 1.30
4-RIBBON CABLE CONNECTOR, single-sided, 9 contacts, PC leads, (#5967)	1.29	8 for 1.30
3-"SUPER" 2N2222, NPN, ICBO:60V, hfe:100 1W @ 2A, TO-92, 100%, (#5952)	1.29	6 for 1.30
1-12 VDC MINI BLOCK RELAY, spdt, 1 x 3/4 x 5/8", 175 ohm, 1A, (#5937)	1.29	2 for 1.30
10-1.5V GRAIN-o-WHEAT LAMPS, 5/16", w/10" leads, lens: RED, (#6002)	1.29	20 for 1.30
10-IF-FM OP AMPS, by RCA, FM-UHF circuitry, TO-5, 10 leads, (#5951)	1.29	20 for 1.30
10-NPN SWITCHING TRANSISTORS, asst'd gen. audio & switching, (#2595)	1.29	20 for 1.30
1-12 VDC SOLENOID, similar to Guardian 16-P, w/plunger, 3/8" stroke, (#6013)	1.29	2 for 1.30

10-HUMBUCKER CONTROLS W/KNOB, for TV vertical, horiz., etc. (#5882)	1.29	20 for 1.30
50-CAPACITOR SPECIAL, discs, mylars, and more, (#3775)	1.29	100 for 1.30
4-HOBBY VOLTAGE REGULATORS, LM-309, 320, 340's, TO-3, (#3330A)	1.29	8 for 1.30
12-PANEL SWITCHES, assorted slides, rotaries, modulars, etc. (#295)	1.29	24 for 1.30
60-RESISTOR SPECIAL, 1/2 to 1 watt, carbons, carbo-films, etc. (#35896)	1.29	120 for 1.30
65-HALF WATT RESISTORS, asst'd. carbons, carbo-films, various values, (#454)	1.29	130 for 1.30
6-LM340T VOLTAGE REGULATORS, 5 to 24 volts, TO-220, (#5897)	1.29	12 for 1.30
40-POLYSTYRENE CAPACITORS, asst'd values and voltages, (#1052)	1.29	80 for 1.30
15-THERMISTORS, resistors that change with the temperature, (#2048)	1.29	30 for 1.30
65-1/2 WATT RESISTORS, asst'd values, metal film, marked, (#5797)	1.29	130 for 1.30
1-12VDC SPDT RELAY, 180 ohm coil, 25 mA, 1x1x1 1/2" (#5937)	1.29	2 for 1.30
15-VOLUME CONTROLS, asst. values, audio, and switch too! (#592)	1.29	30 for 1.30
60-PREFORMED DISC CAPS, handy assortment of values, marked, (#1181)	1.29	120 for 1.30
10-AXIAL ELECTRODS, assorted values and capacitance, (#5901)	1.29	20 for 1.30
60-GLASS ZENERS, 400mW, untested, better than 50% yield, (#5889)	1.29	120 for 1.30
10-PC TRIMPOTS, screwdriver adjust, assorted values, (#3346)	1.29	20 for 1.30
25-4" CABLE TIES, plastic, like Ty-wrap style, (#5217)	1.29	50 for 1.30
5-CRYSTALS, may include; CB, ham various shapes and sizes, (#5716)	1.29	10 for 1.30
40-POWER RESISTORS, assorted types, includes 2 to 10 watters, (#228)	1.29	80 for 1.30
40-TWO WATT RESISTORS, carbo-films, carbons, some 5%ers, (#456)	1.29	80 for 1.30
50-TERMINAL STRIPS, asst'd solder and screw types, 2 lugs & up, (#334)	1.29	100 for 1.30
1-WATCH GUTS, LED, who knows how good, micro-digital bonanza, (#5115)	1.29	2 for 1.30
10-1000V 1A RECTIFIERS, 1N4007, epoxy case, axial leads, (#5926)	1.29	20 for 1.30
5-MULTI-DIGIT LED READOUTS, bubble magnifier, 2 to 6 digits, (#3624)	1.29	10 for 1.30
10-POWER TAB TRANSISTORS, NPN, plastic, TO-220, (#5629)	1.29	20 for 1.30
6-PRECISION TRIM POTS, asst'd singles and multi-turns, untested, (#3389)	1.29	12 for 1.30
50-1N4000 RECTIFIERS, epoxy, axial leads, untested, (#2594)	1.29	100 for 1.30
30pc-HEAT SHRINK, Thermo-fit, useful asst. of sizes, shrinks 50% (#5248)	1.29	60 for 1.30
10-SLIDE SWITCHES, SPST, SPDT, etc. all shapes and sizes, (#5927)	1.29	20 for 1.30
25-DTL's, 100% prime, asst'd flip flops, etc., marked, (#3709)	1.29	50 for 1.30
4-HOBBY OPTO COUPLERS, 1500 VOLT ISOLATION, U-test, (#2629A)	1.29	8 for 1.30
8-TAPE RECORDER EARPHONE, for radios, recorders, 8 ohms, (#2946)	1.29	16 for 1.30
5-MICRO-MINI JACKS, in a block, for 2mm sub-mini plugs, (#1437)	1.29	10 for 1.30
5-PL-55 PHONE JACKS, standard bushing, for hams, communications, (#5868)	1.29	10 for 1.30
40-RED DEVIL CAPACITORS, handy assort. of pop. values, axial leads, (#3823)	1.29	80 for 1.30
50-MICAS asst. sizes-n-shapes, incl. "silvers" too! (#373)	1.29	100 for 1.30
10-TRANSISTOR SOCKETS, for npn and pnp types, (#5944)	1.29	20 for 1.30
12-LED DRIVER IC's, similar to 75491, (#5890)	1.29	24 for 1.30
10-MODULAR SWITCHES, Centralab "push-on" type, up to 8PDT, (#3150)	1.29	20 for 1.30
5-"MOTORS MOTORS", small, high speed, asst'd sizes, 3-6VDC, (#2551)	1.29	10 for 1.30
2-HEAVY DUTY LINE CORDS, 8 ft., 2 cond., 18 gauge, black insulation, (#5803)	1.29	4 for 1.30
10-LED SOCKETS, "snap-in" minis, for LEDs, and transistors, too! (#5745)	1.29	20 for 1.30
10-MV-54 MICRO-MINI LEDES, flat top style, diffused red lens, (#1789)	1.29	20 for 1.30
30-WIRE NUTS, twist-on's, for #20-24 gauge wire, (#3724)	1.29	60 for 1.30
2-ALUM. HEAT SINKS, 2 1/2"x3", for power tabs, innumerable uses, (#5338)	1.29	4 for 1.30
1-"MICRO MINI" METER, 1/2" dia. 0-1 basic movement (#5858)	1.29	2 for 1.30
2-DOUBLE-SIDED PC BOARDS, 3"x12" high quality G-10 glass, (#5694)	1.29	4 for 1.30
60-TUBULAR CAPACITORS, asst'd 100mml to .1mf to 600 WVDC, (#35A219)	1.29	120 for 1.30
6-MICRO MINI REED SWITCHES, 1" long, for alarms, relays, etc., (#1258)	1.29	12 for 1.30
10-TANTALUM ELECTRODS, asst'd mini, axial, hermetically sealed, (#5848)	1.29	20 for 1.30
50-DISC TYPE CAPS, incl; NPO, hi-Q, mylar, ceramics, asst'd values, (#437)	1.29	100 for 1.30
60-COILS & CHOKES, asst'd RF, OSC, IF, parasitic types, (#35A297)	1.29	120 for 1.30
6-SWITCHCRAFT PHONO JACKS, hi-Q, chassis mount, teflon base, (#5119)	1.29	12 for 1.30
1-TO-3 HEAT SINK, heavy duty aluminum, prepunched for TO-3, (#4083)	1.29	2 for 1.30
65-MOLEX SOCKETS, "on-a-strip", for multiple pin dips, (#1609)	1.29	130 for 1.30
6-PAIRS 9V BATTERY CLIPS, w/ired & black color-coded leads, (#2852)	1.29	12 for 1.30
1-UHF TUNER, 3 gang, uhf TV unit, 300 ohm, pos. direct drive, (#2927)	1.29	2 for 1.30
15-HUMBUCKER CONTROLS, assorted values, manufacturers dump, (#3807)	1.29	30 for 1.30
30-SUBMINI IF TRANSFORMERS, slug tuned, shielded, (#35A9)	1.29	60 for 1.30
40-ADJUSTABLE FERRITE CORES, center cut for hex adjust, (#5701)	1.29	80 for 1.30
3-1.5V MINI LAMPS, only 3/32" dia., draws 15mA, w/1" wire leads, (#5693)	1.29	6 for 1.30
30-FT. WIRE-WRAP WIRE, 30 gauge, insulated, continuous length, (#3803)	1.29	60 for 1.30
4-MONO TAPE HEADS, may incl; cassette, 8-track, reel to reel too! (#5789)	1.29	8 for 1.30
5-DUAL DIGIT "BUBBLE" READOUTS, HP5082 style, red, dip type (#5748)	1.29	10 for 1.30
40-METAL & PLASTIC TRANSISTORS, asst'd sizes (#1965)	1.29	80 for 1.30
2-HI PWR. TRANSISTORS, Motorola type, M3201, NPN 15W, TO-66, (#2797)	1.29	4 for 1.30
60-GERM. GLASS DIODES, similar to 1N34, axial leads, untested, (#642)	1.29	120 for 1.30
40-1N914 SWITCHING DIODES, silicon, 4nS, glass, untested, (#143)	1.29	80 for 1.30
4-AM/FM VARIABLE COND., 2 bands, "poly-con" 1/2" square, (#2924)	1.29	8 for 1.30
3-MICRO SWITCHES, SPST, NO contacts, plunger style, solder tabs, (#5785)	1.29	6 for 1.30
10-MULTI-GANG POTS, audio 2 gangs and up, asst'd types and values, (#5326)	1.29	20 for 1.30
10-MAN-3's, 7 segment, w/bubble magnifier, 100% material, (#3842)	1.29	20 for 1.30
3-PL-259 COAX PLUG, mates to SO-239, Amphenol, (#5221)	1.29	6 for 1.30
1-LITE SENSITIVE UNIJUNCTION TRANSISTOR, programmable, (#5719)	1.29	2 for 1.30

**FOREIGN AND CANADIAN POSTAGE**  
 CANADIANS ADD \$5.00 (U. S. Funds)  
 FOREIGN ADD \$10.00  
 EXCESS WILL BE RETURNED

**we accept**

**"SKINNY-TRIMS" POTENTIOMETERS**  
 3/8" square! Single turn style. Screw driver adjust. 20% tolerance. 0.5 Watt ratings. cermet construction. PC leads. ORDER 92CU3866 AND VALUE

Type-86	SINGLE TURN FLAT
10 100 1K 5K 25K 200K	
20 200 2K 10K 50K 500K	
50 500 2.5K 20K 100K 1 Meg	

**6 for \$2.49**  
**12 for \$2.50**

**"TIE-PIN" CONDENSER MIKE**  
 It's a little giant in sound quality. Metal encased, and omnidirectional. Frequency response 20-20,000 Hz. Less tie pin or lapel clip. 600 ohm impedance. 1.5 VDC. Cat. No. 5730

**\$3.95**  
**2 for \$3.96**

**HOW TO ORDER** When ordering, always use catalog number, type no., the name of the magazine you are ordering from and the month.

**POLY PAKS®**  
 P.O. BOX 942-A12  
 SO. LYNNFIELD, MA 01940

**Terms:** Add Postage  
**Phone:** (617) 245-3828  
**Retail:** 16-18 Del Carmine St.  
**MINIMUM ORDER: \$8** Wakefield, MA

**Rated: Net 30**

7294 N.W. 54 STREET  
MIAMI, FLORIDA 33166

# SURPLUS ELECTRONICS CORP. ✓ S43

PHONE: (305) 887-8228

TWX: 810-848-6085

WHOLESALE - RETAIL

<p><b>PL259 or SO239</b> Quality American Made 10/\$5.00      100/\$35.00 50/\$20.00      1000/\$300.00</p>	<p><b>CB SPECIAL</b> Brand new printed circuit board assembly. Used in all HyGain 40 Channel CB transceivers. Fits many other manufacturers' units also. Squelch pot/volume control/channel selector switch not included. Board Dimensions 6" x 6 1/2" 1-9 - 7.50 ea.      50-99 - 6.00 ea. 10-49 - 6.50 ea.      100-up - 5.50 ea.</p>		<p><b>TRIMMER CAPS</b> Can fit in your watch 3.5-20 pF &amp; 5-30 pF \$.75 ea., 2/\$1.25 5/\$3.00</p>
<p><b>E. F. Johnson NICAD</b> 12.0 V. 1.2 AH @ 10 hr rate 4 1/2" x 1 7/8" x 1 3/4" \$1495ea.</p>	<p>CB SPECIAL W/40 ch SW same as above 1-9 \$10.50 ea.      50-99 \$9.00 ea. 10-49 \$9.50 ea.      100-up \$8.50 ea.</p>		<p><b>POLY FOAM COAX</b> <b>50 Ohm</b> Low Loss = to RG174 \$.95/100' \$3.00/50'</p>
<p><b>E. F. Johnson S Meter</b> Edge Meter 250 UA. Fits in 5/8" x 1-3/8" hole. MTG holes on each end 1-1/4" behind panel. Black scale 0-5 bottom 1-20 top \$1.25 ea.      5/\$5.00</p>	<p><b>Serviceman Special</b> New Hy-Gain 40ch CB Less Case. Speaker &amp; Knobs (as is) \$14.95 ea</p>		<p><b>ULTRASONIC TRANSDUCER</b> Detects sound above the range of human hearing! Transmits &amp; receives \$2.50 ea. 5/\$10.00</p>
<p><b>E. F. Johnson Signal Strength Meter</b> 200 UA 2 1/2" x 2 1/2" Sq. mounts in 1 3/4" hole 1" behind panel. Scale: 1-30 db top 0-5 bottom. \$4.95ea      5/\$20.00</p>	<p><b>NEW Hy-Gain Remote 40ch CB</b> Less Case. Speaker &amp; Control Mic (as is) \$14.95 ea</p>	<p><b>NEW E.F. Johnson Power Mic/Less Cord.</b> Desktop Style \$19.95 ea</p>	<p><b>MAGNETIC PICK UP TRANSDUCER</b> Converts motion to ac voltage without mechanical linkage 3/8" x 2" w/6' shielded cable \$4.95 ea.</p>
<p><b>PANEL METERS</b> \$4.00 ea      2 for \$7.00  25-0-25 dc volts } 2 1/4" x 3" 0-20 dc volts } 0-25 dc volts } 2 1/4" x 2 1/4" 0-50 ac volts } -Shunt Required-</p>	<p><b>ASTATIC T-UG8-D104</b> PREAMP Desktop microphone w/crystal element 3 Pin Plug \$35 ea.</p>	<p><b>CRYSTAL FILTERS</b> 10.7 3/Lead Can Type \$3.00 ea.</p>	<p><b>CERAMIC IF FILTERS</b> EFC L455K \$3.50 ea.</p>
<p><b>Double Row/Wire Wrap .100</b> 25 pins \$3.49 ea      10/\$30.00 30 pins \$3.96 ea      10/\$32.00 50 pins \$5.43 ea      10/\$45.00</p>	<p><b>E. F. Johnson</b> 40ch. CB Selector Switch \$3.50ea</p>	<p><b>2 SIDED .062 Copper Clad Board</b> 9 1/4" x 10 1/4" \$2.00ea      3/\$5.00</p>	<p><b>Sony RK64A</b> 2 conductor mini phono plug w/patch cord 36" long \$2.00ea</p>
<p><b>Double Row/Solder Eyelet .156</b> 6 pins \$1.10 ea      10/\$ 9.00 15 pins \$1.55 ea      10/\$12.50 22 pins \$2.08 ea      10/\$17.00 43 pins \$3.66 ea      10/\$30.00</p>	<p><b>12 Vdc RELAY</b> <b>SPST 35 Amp Contacts</b> Open Frame Rugged, great for mobile use \$4.50 ea      5/\$20.00</p>	<p><b>12 Vdc RELAY</b> SPST Open Frame 5 Amp Contacts Mfg-Magnecraft \$1.50 ea      4/\$5.00</p>	<p><b>SOLDERLESS TEST PROD (BLACK)</b> Threaded type, molded handle \$.40 ea. 5/\$3.50</p>
<p><b>C &amp; K SWITCHES</b> PART # MOVEMENT 7101 ON/NONE/ON SPST 7103 ON/OFF/ON SPST 7107 ON/NONE/ON SPST 7108 ON/NONE/(ON) SPST 7201 ON/NONE/ON DPDT \$1.00 EA      6 FOR \$5.00</p>	<p><b>22 pins/Double Row/Dipped Solder</b> .156 \$2.08 ea      10/\$17.00</p>	<p><b>22 pins/Double Row/Wire Wrap</b> .156 \$2.44 ea      10/\$19.00</p>	<p><b>USED MUFFIN FANS</b> 3 blades, 110VAC, 4 3/4" sq. \$5.95</p>
<p>6 TV GAMES ON (1) CHIP Gen Instr AY-3-8500-1 28 Pin Plastic Case EVERYDAY LOW PRICE \$7.50 ea</p>	<p><b>RECEIVER FRONT ENDS</b> Made by EFJ 132-174 MHz \$12.00 ea.</p>	<p><b>100 ASSORTED DISC CAPS</b> (FULL LEADS) 20 EA OF 5 DIFFERENT VALUES \$2.00 PER PACK</p>	<p><b>CW MINI SLIDE SW</b> DPDT .15 ea. 10/\$1.25</p>
<p><b>ASSORTED ELECTROLYTICS</b> VALUE/MFD      VOLTS      DIA      LENGTH      PRICE 250,000 @ 5V 3" x 53/4" \$4.00 ea 30,000 @ 15V 3" x 4 1/2" 4.00 ea 63,000 @ 15V 3" x 5 1/2" 4.00 ea 10,000 @ 20V 1 1/2" x 53/4" 3.00 ea 2,700 @ 25V 1 1/4" x 2 1/4" 2.00 ea 2,900 @ 25V 1 1/4" x 2" 2.00 ea 3,000 @ 25V 1 1/2" x 4 1/2" 2.00 ea 18,000 @ 25V 2" x 4" 3.00 ea 21,000 @ 25V 2 1/2" x 3" 3.00 ea 39,000 @ 45V 3" x 53/4" 3.00 ea 1,000 @ 50V 1 1/4" x 3 1/4" 2.50 ea 34,800 @ 50V 3" x 5 1/2" 3.00 ea 450 @ 75V 1 1/4" x 2 1/4" 2.00 ea 500 @ 100V 1 1/2" x 3 1/2" 2.00 ea 240 @ 300V 1 1/4" x 3 1/4" 2.00 ea 50 @ 450V 1 1/4" x 2" 2.00 ea 140 @ 450V 1 1/4" x 3" 2.00 ea</p>	<p><b>STANCOR TRANSFORMERS</b> STEP-DOWN AUTO (3) COND LINE CORD W/RECPT GSD 200 (230V In/115V Out @ 200 Va) \$12.00 ea GSD 400 (230 In/115 V Out @ 400 Va) \$14.50 ea</p>	<p><b>White Porcelain Egg Insulator</b> 1 1/2" x 1" 50¢ ea.      3 for \$1.25</p>	<p><b>ALL STAR AIR VARIABLE</b> 24-275 pF .75 ea.</p>
<p><b>MODEM CABLE</b> 50' cable contains 13 # 22 ga. wire DB-25p with DB-51226-1 cover on one end \$6.50 ea      10/\$50.00</p>	<p><b>100 ASSORTED DISC CAPS</b> (FULL LEADS) 20 EA OF 5 DIFFERENT VALUES \$2.00 PER PACK</p>	<p><b>CAPS RADIAL LEADS</b> 2200 uF @ 16V .25 ea. 10/\$2.00</p>	<p><b>RED SEVEN SEGMENT DISPLAY</b> TIL 322P \$1.00 ea.</p>
<p><b>TERMS:</b> All material guaranteed • If for any reason you are not satisfied, our products may be returned within 10 days for a full refund (less shipping). Please add \$3 for shipping and handling on all orders. Additional 5% charge for shipping any item over 5 lbs. COD's accepted for orders totaling \$50.00 or more. All orders shipped UPS unless otherwise specified. Florida residents please add 4% sales tax. Minimum order \$15.00.</p>	<p><b>MODERN CABLE</b> 50' cable contains 13 # 22 ga. wire DB-25p with DB-51226-1 cover on one end \$6.50 ea      10/\$50.00</p>	<p><b>SOLDER LUG-TYPE CAPS</b> 50 UF @ 350V 1" D x 3" L 50 UF @ 450V 1" D x 2 1/2" L 50 UF @ 450V 1" D x 3" L 60¢ EA.      5 FOR \$2.50</p>	<p><b>BOURNS' EDGE MOUNTING</b> 5K pot single turn 3345W series \$1.50 ea.</p>
<p><b>EQUIPMENT / COMPONENTS / WIRE &amp; CABLE / ACCESSORIES</b></p>	<p><b>IC SOCKETS</b> <b>Cambion</b> <b>Gold Plated Wire Wrap</b> 14 pin .35 ea      10/\$3.00 16 pin .38 ea      10/\$3.30</p>	<p><b>EFJ CRYSTAL OVENS</b> 6V/12V 75° \$5.00 ea.</p>	<p><b>12 VOLTS @ 1/2 AMP</b> Filament transformer 1 1/2" x 2" x 1" \$1.50 ea.</p>
<p><b>EQUIPMENT / COMPONENTS / WIRE &amp; CABLE / ACCESSORIES</b></p>	<p><b>Coax Connectors</b> UG-273/U BNC-F/UHF-M 2.50 UG-255/U BNC-M/UHF-F 3.00 UG-146A/U N-M/UHF-F 4.50 UG-83B/U N-F/UHF-M 4.50 UG-175 RG-58 Adapt. .20 UG-176 RG-59 Adapt. .20</p>	<p><b>1N4148 SIGNAL DIODE</b> \$5.00 per 100 or 15 for \$1.00</p>	<p><b>CTS DP6P ROT SWITCH</b> .50 ea. 5/\$2.00</p>
<p><b>EQUIPMENT / COMPONENTS / WIRE &amp; CABLE / ACCESSORIES</b></p>	<p><b>AXIAL LEAD ELECTROLYTIC CAPACITORS</b> 2 uF @ 15V } 10 uF @ 15V } 20 uF @ 15V } 50 uF @ 15V } 2.2 uF @ 25V } 3.3 uF @ 25V } 1 uF @ 35V } 2 uF @ 150V } 25 uF @ 25V } 3 uF @ 50V } 5 uF @ 50V } 10 uF @ 50V } 250 uF @ 25V } 100 uF @ 50V } 50 uF @ 75V } 12 ea. for \$1.00 15 ea. for \$2.00 10 ea. for \$2.00</p>	<p><b>Coax Connectors</b> UG-273/U BNC-F/UHF-M 2.50 UG-255/U BNC-M/UHF-F 3.00 UG-146A/U N-M/UHF-F 4.50 UG-83B/U N-F/UHF-M 4.50 UG-175 RG-58 Adapt. .20 UG-176 RG-59 Adapt. .20</p>	<p><b>AXIAL LEAD ELECTROLYTIC CAPACITORS</b> 2 uF @ 15V } 10 uF @ 15V } 20 uF @ 15V } 50 uF @ 15V } 2.2 uF @ 25V } 3.3 uF @ 25V } 1 uF @ 35V } 2 uF @ 150V } 25 uF @ 25V } 3 uF @ 50V } 5 uF @ 50V } 10 uF @ 50V } 250 uF @ 25V } 100 uF @ 50V } 50 uF @ 75V } 12 ea. for \$1.00 15 ea. for \$2.00 10 ea. for \$2.00</p>

**TERMS:** All material guaranteed • If for any reason you are not satisfied, our products may be returned within 10 days for a full refund (less shipping). Please add \$3 for shipping and handling on all orders. Additional 5% charge for shipping any item over 5 lbs. COD's accepted for orders totaling \$50.00 or more. All orders shipped UPS unless otherwise specified. Florida residents please add 4% sales tax. Minimum order \$15.00.



# Low Cost...High Performance

## DIGITAL MULTIMETER



**\$99.95 WIRED**

Low cost, high performance, that's the DM-700. Unlike some of the hobby grade DMMs available, the DM-700 offers professional quality performance and appearance at a hobbyist price. It features 26 different ranges and 5 functions, all arranged in a convenient, easy to use format. Measurements are displayed on a large 3 1/2 digit, 1/2 inch high LED display, with automatic decimal placement, automatic polarity, and overrange indication. You can depend upon the DM-700, state-of-the-art components such as a precision laser trimmed resistor array, semiconductor band gap reference, and reliable LSI circuitry insure lab quality performance for years to come. Basic DC volts and ohms accuracy is 0.1%, and you can measure voltage all the way from 100  $\mu$ V to 1000 volts, current from 0.1  $\mu$ A to 2.0 amps and resistance from 0.1 ohms to 20 megohms. Overload protection is inherent in the design of the DM-700, 1250 volts, AC or DC on all ranges, making it virtually goof proof. Power is supplied by four 'C' size cells, making the DM-700 portable, and, as options, a nicad battery pack and AC adapter are available. The DM-700 features a handsome, jet black, rugged ABS case with convenient retractable tilt bail. All factory wired units are covered by a one year limited warranty and kits have a 90 day parts warranty.

Order a DM-700, examine it for 10 days, and if you're not satisfied in every way, return it in original form for a prompt refund.

### Specifications

DC and AC volts: 100  $\mu$ V to 1000 Volts, 5 ranges  
 DC and AC current: 0.1  $\mu$ A to 2.0 Amps, 5 ranges  
 Resistance: 0.1  $\Omega$  to 20 megohms, 6 ranges  
 Input protection: 1250 volts AC/DC all ranges fuse protected for overcurrent  
 Input impedance: 10 megohms, DC/AC volts  
 Display: 3 1/2 digits, 0.5 inch LED  
 Accuracy: 0.1% basic DC volts  
 Power: 4 'C' cells, optional nicad pack, or AC adapter  
 Size: 6"W x 3"H x 6"D  
 Weight: 2 lbs with batteries

### Prices

DM-700 wired + tested ..... \$99.95  
 DM-700 kit form ..... 79.95  
 AC adapter/charger ..... 4.95  
 Nicad pack with AC adapter/charger ..... 19.95  
 Probe kit ..... 3.95

TERMS: Satisfaction guaranteed or money refunded, COD, add \$1.50. Minimum order \$6.00. Orders under \$10.00, add \$.75. Add 5% for postage, insurance, handling. Overseas, add 15%. NY residents, add 7% tax.



## 600 mHz COUNTER



**\$99.95 WIRED**

The CT-70 breaks the price barrier on lab quality frequency counters. No longer do you have to settle for a kit, half-kit or poor performance, the CT-70 is completely wired and tested, features professional quality construction and specifications, plus is covered by a one year warranty. Power for the CT-70 is provided by four 'AA' size batteries or 12 volts, AC or DC, available as options are a nicad battery pack, and AC adapter. Three selectable frequency ranges, each with its own pre-amp, enable you to make accurate measurements from less than 10 Hz to greater than 600 mHz. All switches are conveniently located on the front panel for ease of operation, and a single input jack eliminates the need to change cables as different ranges are selected. Accurate readings are insured by the use of a large 0.4 inch seven digit LED display, a 1.0 ppm TCXO time base and a handy LED gate light indicator.

The CT-70 is the answer to all your measurement needs, in the field, in the lab, or in the ham shack. Order yours today, examine it for 10 days, if you're not completely satisfied, return the unit for a prompt and courteous refund.

### Specifications

Frequency range: 10 Hz to over 600 mHz  
 Sensitivity: less than 25 mv to 150 mHz  
 less than 150 mv to 600 mHz  
 Stability: 1.0 ppm, 20-40°C; 0.05 ppm/°C TCXO crystal time base  
 Display: 7 digits, LED, 0.4 inch height  
 Input protection: 50 VAC to 60 mHz, 10 VAC to 600 mHz  
 Input impedance: 1 megohm, 6 and 60 mHz ranges 50 ohms, 600 mHz range  
 Power: 4 'AA' cells, 12 V AC/DC  
 Gate: 0.1 sec and 1.0 sec LED gate light  
 Decimal point: Automatic, all ranges  
 Size: 5"W x 1 1/2"H x 5 1/2"D  
 Weight: 1 lb with batteries

### Prices

CT-70 wired + tested ..... \$99.95  
 CT-70 kit form ..... 75.95  
 AC adapter ..... 4.95  
 Nicad pack with AC adapter/charger ..... 14.95  
 Telescopic whip antenna, BNC plug ..... 7.95  
 Tilt bail assembly ..... 3.95

**ramsey electronics**

✓R8 BOX 4072, ROCHESTER, N.Y. 14610  
 PHONE ORDERS CALL  
 (716) 271-6487

# BULLET ELECTRONICS

B8 P.O. Box 401244-E Garland, Texas 75040 (214) 278-3553

## AY3-8910 PROGRAMMABLE SOUND GENERATOR

The AY3-8910 is a 40 pin LSI chip with three oscillators, three amplitude controls, programmable noise generator, three mixers, an envelope generator, and three D/A converters that are controlled by 8 BIT WORDS. No external pots or caps required. This chip hooked to an 8 bit microprocessor chip or Buss (8080, Z80, 6800 etc.) can be software controlled to produce almost any sound. It will play three note chords, make bangs, whistles, sirens, gunshots, explosions, bleets, whines, or grunts. In addition, it has provisions to control its own memory chips with two IO ports. The chip requires +5V @ 75ma and a standard TTL clock oscillator. A truly incredible circuit.

**\$14.95** W/Basic Spec Sheet (4 pages)  
60 page manual with S-100 interface instructions and several programming examples, **\$3.00 extra**

## SE-01 SOUND EFFECTS KIT

• 76477 CHIP IS INCLUDED. EXTRA CHIPS \$2.95 EACH

• **\$16.95** LESS SPEAKER & BATTERY



The SE-01 is a complete kit that contains all the parts to build a programmable sound effects generator. Designed around the new Texas Instruments SN76477 Sound Chip, the board provides banks of MINI DIP switches and pots to program the various combinations of the SLF Oscillator, VCO, Noise, One Shot, and Envelope Controls. A Quad Op Amp IC is used to implement an Adjustable Pulse Generator, Level Comparator and Multiplex Oscillator for even more versatility. The 3 1/4" x 5" PC Board features a prototype area to allow for user added circuitry. Easily programmed to duplicate Explosions, Phasor Guns, Steam Trains, or almost an infinite number of other sounds. The unit has a multiple of applications. The low price includes all parts,

assembly manual, programming charts, and detailed 76477 chip specifications. It runs on a 9V battery (not included). On board 100MW amp will drive a small speaker directly, or the unit can be connected to your stereo with incredible results! (Speaker not included).

ALLOW 3 WKS. FOR DELIVERY

## A RARE FIND! LAMBDA HIGH POWER REGULATOR 3205 MODULE

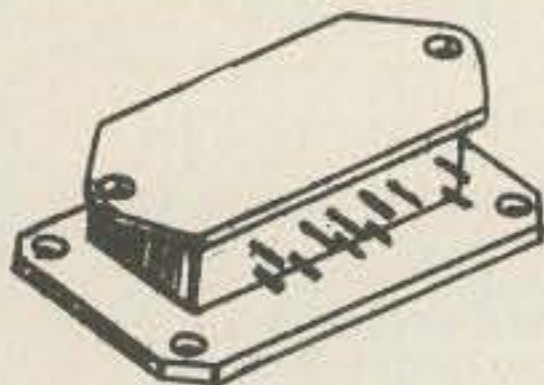

**\$12.95** W/SPECS LIMITED QTY.

- 5V @ 10A with 8-30VDC input.
- Current limiting, thermal shutdown and short protection.
- .2% Load regulation.
- Only 2 external components needed.

All you need to add is a transformer, rectifier, heatsink and filter cap to have a super regulated supply for 5 volts at 10 amps!

**SPECIAL BONUS!** Order the 3205 Module and get **FREE** a LAMBDA L-20-5 overvoltage protector that triggers at 6.6 volts up to 20 amps.

**LAS15U - 1.5A Four Terminal Adjustable Regulator.** 3-30V W/current limiting, short protection and thermal shutdown. TO-3 style. All units are prime. Spec sheets included. **\$2.50**

- ★ NO C.O.D.'s
- ★ SEND CHECK M.O. OR CHARGE CARD NO.
- ★ PHONE ORDERS ACCEPTED ON VISA AND MASTERCARD ONLY. (214) 278-3553 9:00 AM - 6:00 PM CST
- ★ ORDERS OVER 1 LB. SHIPPED VIA UPS

POLICIES

**4 DIGIT 1/2 INCH CHARACTER LED DISPLAY**  
Bowmar readout stick with colons. COMMON CATHODE ONLY. 100% Prime. All segments and colons brought out to edge pads. With pinout. LIMIT 5 PER CUSTOMER



**SPECIAL \$1.90**

From T.I.: **TL490 BAR/DOT DRIVER IC.** Drives 10 LED's with adjustable analog steps. Units are cascadable up to 10 (100 steps). Drives LED's directly. Great for **voltage, current, or audio displays.** Similar in features to LM3914 with specs and circuit notes.

**2.95**

**NEW!**



## XAN SUPER DIGITS

.6" JUMBO LED  
7 SEGMENT  
RED

**99¢**

6640 COMMON ANODE  
6920 COMMON CATHODE

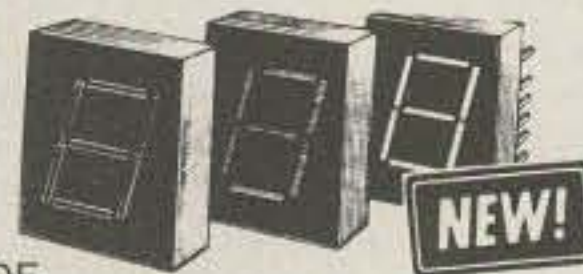

**NOW A SUPER READOUT AT A SUPER BUY!** These are **factory fresh prime** LED readouts, not seconds or rejects as sold by others. Compare our price and send for yours today, but hurry, the supply is limited!

**SPECIFY: COMMON ANODE OR COMMON CATHODE**

## NEW ITEMS

LM3046	(CA3046) Transistor Array	.75
LM3909	Led Flasher	.50
CA3086	RCA Transistor Array	.80
MC1438R	Power Op Amp/Driver	.50
1N4148	Prime, Full Lead	100/2.50
LM3302	Quad Comparator	.89
2SC1849	High Freq NPN TO-92	6/1.00

## POTENTIOMETER ASSORTMENT

A mix of new, panel mount 3/8" bushing pots in various values. Some dual, some with switches.

10/2.00

## 1/2W RESISTOR ASSORTMENT

A good mix of 5% and 10% values in both full lead and PC lead devices. All new, first quality.

(Asst.) 200 pieces/ 2.00

## SLIDE SWITCH ASSORTMENT

An outstanding bargain. Includes miniature and standard sizes and multiposition units. All new first quality, name brand switches. Try one pack and you'll reorder more: **SPECIAL - 12 for \$1.20** (Assortment)

- ★ ADD 5% FOR SHIPPING
- ★ TX. RES. ADD 5% STATE SALES TAX
- ★ FOREIGN ORDERS ADD 10% (EXCEPT CANADA) (20% AIRMAIL) U.S. FUNDS ONLY.
- ★ SORRY WE CANNOT SHIP INSURED TO MEXICO PRICES SUBJECT TO CHANGE WITHOUT NOTICE.

9500@75V Computer Grade Filter Cap 2"x5 1/2" 2.95

## ZENER GRAB BAG

A very nice assortment of 1/4, 1/2 & 1W zeners. Voltage ranges are from 2.7 to 30 VDC. Most have house # but we provide a cross over list to standard numbers. A great buy for any shop. **12 different types.**

**.50 ea.**

## MC1469R POSITIVE VOLTAGE REGULATOR

1/2 AMP COMPLETE SPECS AND APPLICATIONS SHOW HOW TO BUILD FIXED OR VARIABLE POWER SUPPLIES FROM 3 TO 30VDC. DRIVE EXTERNAL SERIES PASS FOR CURRENT TO 20 AMPS!

1.25 EA.  
10/10.00  
HOUSE #



## QUAD MATCHED DIODES

4 1N914 type diodes that have been closely matched for use in bridge and balanced modulator circuits.

50¢ ONE SET (4)

## PARTS

301 OP AMP 8 LEAD CAN	3/1.00
723 VOLT REG. 10 LEAD CAN	.50
*13741 FET INPUT 741 MINI DIP	3/1.10
30.000 @ 15V COMPUTER GRADE	2.10
2N4400 NPN GEN. PURPOSE	8/1.00
2N4402 PNP COMPLIMENT	8/1.00
2N6028 P.U.T. W/SPECS	.50
LM380 2W AUDIO IC W/SPECS	1.09
LM377 DUAL LM380 W/SPECS	2.50
*7815 VOLT REG. 1A 15V	.89
*725 LOW NOISE OP AMP	.99
IL-1 OPTO ISOLATOR MINI DIP	.60
*MEM 631 DUAL GATE MOSFET. DIODE PROTECTED. SIMILAR TO 40673	.50
MV1624 VARICAP DIODE 10 PFD	.49
1N4003 1A 200V DIODE	15/1.00
TIP30 TAB PNP POWER	3/1.00
*MC1351P FM IF. DISC IC	.50

\*INDICATES ITEM IS "HOUSE NUMBERED"

## LED'S

JUMBO GREEN	4/.89
JUMBO RED	5/.89
MEDIUM RED (1/8")	.15
MEDIUM GRN OR YELLOW	.16

## 7 WATT AUDIO AMP KIT

SMALL SINGLE HYBRID IC AND COMPONENTS FIT ON A 2" x 3" PC BOARD (INCLUDED). RUNS ON 12 VDC. GREAT FOR ANY PROJECT THAT NEEDS AN INEXPENSIVE AMP. LESS THAN 3% THD @ 5 WATTS. COMPATIBLE WITH SE-01 SOUND KIT. **\$5.95**

## 6 DIGIT AUTO/VAN CLOCK

- LARGE 1/2" CHARACTERS (LED)
- QUARTZ XTAL TIMEBASE
- ALARM & SNOOZE OPTIONS
- NOISE FILTERING
- EASY TO ASSEMBLE
- 4 1/2" x 3" x 1 1/2"
- DRILLED & PLATED PC BOARDS

COMPLETE KIT 12 VDC **\$16.95**

## ULTRASONIC RELAY KIT

INVISIBLE BEAM WORKS LIKE A PHOTO ELECTRIC EYE. USE UP TO 25 FT. APART. COMPLETE KIT. ALL PARTS & PC BOARDS.

**\$21.50**

Does Your Shiny New Rig Really Have:

# "STATE-OF-THE-ART" SELECTIVITY

**EXCITING  
NEW RADIO  
ACCESSORIES**



Add an Autek.

## QF-1A Active Filter

For SSB & CW  
PATENT PENDING

Only \$65 ppd. U.S.A.

115 VAC supply built-in. Filter by-passed when off.

**SUPER-RANGE**  
Auxiliary Notch rejects 80 to 11,000 Hz! Covers signals other notches can't touch.

Four main filter modes for any QRM situation.

Continuously variable main selectivity (to an incredible 20 Hz!)

Continuously variable main frequency. (250 to 2500 Hz, all modes.)

AUTEK pioneered the ACTIVE AUDIO FILTER way back in 1972. Today, we're still maintaining that engineering leadership. Our QF-1A evolved from suggestions from thousands of owners, and years of dedication to making the "ultimate" filter. No gimmicks — just something that really "works" like the ad says. You're in for a treat!

Autek filters gained their reputation by using a costly INFINITELY VARIABLE design. Yet, mass-production (we sell only ONE MODEL — the best) makes it a tremendous bargain. You're not limited by a few fixed positions. You vary selectivity 100:1, and vary frequency over the entire usable audio range. PEAK CW (or voice) with an incredible 20 HZ

BANDWIDTH, but also variable all the way to "flat." Imagine what the NARROWEST CW FILTER MADE will do to QRM! Reject whistles with the most flexible NOTCH you've heard. Wide or narrow. Depth to 70 dB. LOWPASS helps you cope with SSB hiss and splatter. Skirts exceed 80 dB. Most above features were in the popular QF-1 (See excellent review in March, 1977 QST.) The new "A" model is more selective, adds a HIGHPASS mode for SSB, and a great AUXILIARY NOTCH (35 to 60 dB) to give TWO NOTCHES, NOTCH/PEAK, NOTCH/LOWPASS, or NOTCH/HIGHPASS! If this doesn't convince you, please ASK ON THE AIR. Owners are our best salesmen!

Due to cost and panel-space limitations, even the latest rigs only include a fraction of the QF-1A features. We recommend you buy the best rig you can afford, spend \$3,000 or more, then add a QF-1A and listen to the improvement! WORKS WITH Yaesu, Kenwood, Drake, Swan, Atlas, Tempo, Collins, Heath, S/1, etc., ANY RIG!

Hooks up in minutes. Plug into your rigs phone jack, or attach to speaker wires. Plug speaker or phones into QF-1A rear-panel jack. That's it! Filter supplies 1 watt to fill a room. No batteries reqd. (+12 VDC hookup possible.) 6 1/2 x 5 x 2 1/2". Handsome light/dark grey styling. Get yours today!

## CMOS PROGRAMMABLE KEYSER MAKES CW FUN!



Calls CQ while you relax.

Also remembers name, QTH, contest exchanges.

Record anything you want in seconds!

Model MK-1 \$99.50 ppd. U.S.A.

Our classic MK-1 should make you wonder why anyone would buy an ordinary keyer, when memory costs so little! Records 4 messages. Just select "record," tap the A, B, C, or D message, and start sending at any speed! Record over old messages as easily. Playback by tapping the same button. Each message holds about 25 characters (letters, numbers). Total 100 characters. Handy repeat switch repeats message forever until reset. Very useful for CQ's. YOU SIT BACK AND WAIT FOR A CALL! Another switch combines two messages for 50

characters. "Memory-saver" feature standard.

This "state-of-the-art" keyer pleases beginners and CW "pros" alike. DOT AND DASH MEMORIES. TRIGGERED CLOCK. IAMBIC. SELF COMPLETING. JAM PROOF. 5 to 50+ WPM. LATEST CMOS FOR LOW CURRENT. Built-in monitor, speaker. Widely adjustable tone, volume. Perfect weighting at all times. No fiddling with an adjustment that varies with speed. NEW: DUAL TRANSMITTER OUTPUTS key ANY modern (post

1963) ham rig directly without a battery or relay, including difficult-to-key solid-state rigs. 115VAC supply built in, or connect 9-14 VDC to rear panel. Use with ANY paddle. 6x3 1/2 x 5". Burned-in and tested. Sockets for IC's. Full instructions.

NOW AVAILABLE. 4096 BIT MEMORY EXPANDER (ME-1) allows 16 messages, 400 chars. & "combine" for longer messages. Plugs into memory socket of ANY MK-1 ever made. Installs in 10 to 30 mins. Full instructions. Buy your MK-1 now and easily add memory later if you wish!

**FLASH! MK-1 used to set new world's CW record. A single operator worked 3992 DXQSO's & 275 band-countries in only 48 hours! Get the choice of champions — AUTEK.**

**ORDER WITH CONFIDENCE. NO LONG DELAYS HERE. We ship 95% of orders from stock. 1 year limited parts & labor warranty. Try our great service! VISA & MC Welcome.**

Order by mail or call our TOLL FREE order operator:

NATIONWIDE CALIF.

1-800-854-2003 ext. 842

1-800-522-1500 ext. 842

CALL 24 HOURS, 7 DAYS A WEEK.

Important: Operator can only take your order. For other information, you must write.

**Autek Research**

Box 5127F  
Sherman Oaks, Ca.  
91403

✓ A100

ORDER BLANK (Or Use Separate Sheet of Paper)

Please Rush ppd. via Speedy UPS.  QF-1A Filter at \$65.00  MK-1 Keyer at \$99.50  ME-1 Expander for MK-1 at \$40 (factory installed)  ME-1 Owner installed at \$30 (save \$10)

Add 6% tax in Calif. Add \$3 each to Canada, Hawaii and Alaska. \$2 for UPS air. Add \$15 each elsewhere (shipped air).

Enclosed is \$ \_\_\_\_\_  
VISA or MC# \_\_\_\_\_ Exp. date \_\_\_\_\_  
NAME \_\_\_\_\_

ADDRESS \_\_\_\_\_

CITY \_\_\_\_\_ STATE \_\_\_\_\_ ZIP \_\_\_\_\_

Send to Autek Research, Box 5127F, Sherman Oaks, Ca. 91403.

# VARIABLE POWER SUPPLY KIT \$11<sup>95</sup>

- Continuously Variable from 2V to over 15V
- Short-Circuit Proof
- Typical Regulation of 0.1%
- Electronic Current Limiting at 300mA
- Very Low Output Ripple
- Fiberglass PC Board Mounts All Components
- Assemble in about One Hour
- Makes a Great Bench or Lab Power Supply
- Includes All Components except Case and Meters



ADD \$1.25 FOR POSTAGE/HANDLING

## SPECIALS—THIS MONTH ONLY

1N34A	Germanium Diode 60V 10mA	10/\$1	LM308H	Low Bias Current Op Amp-Super 709	\$0.84
1N270	Germanium Diode 80V 200mA	4/\$1	LM309K	5 Volt Regulator TO-3	.84
1N914	Silicon Diode 100V 10mA	25/\$1	LM317K	Adjustable Voltage Regulator 2-37V	3.50
1N6263	Hot Carrier Diode (HP2800, etc.)	\$1.00	LM380N	2 Watt Audio Power Amplifier DIP	.94
F7	Power Varactor 1-2W Out @ 432MHz (Specs & Circuits included with F7)	\$2.00	NE565A	Phase Locked Loop DIP	.94
DIODE GRAB BAG—Mixed zeners, rectifiers, etc.			LM723CN	Precision Voltage Regulator DIP	3/\$1
2N706	NPN High-Speed Switch 75ns	4/\$1	LM747	Dual 741 Compensated Op Amp DIP	2/\$1
2N918	UHF Transistor—Osc/Amp up to 1 GHz	4/\$1	2102	1024-Bit Static RAM (1024 x 1) DIP	\$1.75
2N2609	P-Channel FET Amplifier 2500 $\mu$ mhos	\$1.09	Z740DE	FET-Input Op Amp-like NE 536/ $\mu$ A740	1.95
2N2920	NPN Dual Transistor 3mV Match $\beta$ 225	2.95	CA3018A	4-Transistor Array/Darlington	.99
2N3904	NPN Amp/Switch $\beta$ 100 40V 200mA	8/\$1	CA3028A	RF/IF Amplifier DC to 120MHz	1.45
2N4122	PNP RF Amplifier & Switch	3/\$1	CA3075E	FM IF Amp/Limiter/Detector DIP	1.45
2N4869E	N-Channel Audio FET Super Low Noise	2/\$1	RC4558	Dual High Gain Op Amp mDIP	3/\$1
2N4888	150 Volt PNP Transistor for Keyer	2/\$1	N5558V	Precision Fast Op Amp mDIP	2/\$1
E112	N-Channel FET VHF RF Amp	3/\$1	N5558V	Dual Hi Gain Op Amp-Comp. mDIP	3/\$1
TIS74	N-Channel FET High-Speed Switch 40 $\Omega$	3/\$1	8038	Function Generator/VCO with circuits	\$3.75
			LP-10	LOGIC PROBE kit—TTL, CMOS, etc. Machined case included— $\frac{1}{8}$ hr. assembly	\$7.85

SEND FOR ADVA'S NEW 1979 CATALOG  
NEARLY 1000 SEMICONDUCTORS, KITS, CAPACITORS, ETC.—SEND 25¢ STAMP.

### OTHER ADVA KITS:

LOGIC PROBE KIT—Use with CMOS, TTL, DTL, RTL, HTL, HINIL and most MOS IC's. Built-in protection against polarity reversal and overvoltage. Draws only a few mA from circuit under test. Dual LED readout. Complete kit includes case and clip leads. ONLY \$7.85

FIXED REGULATED POWER SUPPLY KITS—Short-circuit proof with thermal current limiting. Compact size and typical regulation of 0.5% make these ideal for most electronic projects. Available for 5V @ 500mA, 6V @ 500mA, 9V @ 500mA, 12V @ 400mA, 15V @ 300mA. Specify voltage when ordering. \$8.95 ea.

These easy-to-assemble kits include all components, complete detailed instructions and plated fiberglass PC boards. Power supply kits do not include case or meters. Add \$1.25 per kit for postage and handling.

MAIL NOW! FREE DATA SHEETS supplied with many items from this ad. FREE ON REQUEST—741 Op Amp with every order of \$5 or more—749 Dual Op Amp or two E100 FET's with every order of \$10 or more, postmarked prior to 12/31/78. One free item per order. ORDER TODAY—All items subject to prior sale and prices subject to change without notice. All items are new surplus parts—100% functionally tested.

WRITE FOR FREE CATALOG #79 offering over 700 semiconductors carried in stock. Send 25¢ stamp.

TERMS: Send check or money order (U.S. funds) with order. Add 5% postage for U.S., Canada and Mexico. \$1.00 handling charge on orders under \$10. Calif. residents add 6% sales tax. Foreign orders add 10% postage. COD orders—add \$1.00 service charge.

### MORE SPECIALS:

RC4195DN  $\pm$ 15V @ 50mA VOLTAGE REGULATOR IC. Very easy to use. Makes a neat Highly Regulated  $\pm$ 15V Supply for OP AMP's, etc. Requires only unregulated DC (18–30V) and 2 bypass capacitors. With Data Sheet and Schematics. 8-pin mDIP \$1.25

RC4136 Quad 741 Low-Noise Op Amp mDIP \$0.95

LM1304 FM Multiplex Stereo Demodulator DIP 0.99

LM2111 FM IF Subsystem (IF Amp, Det., Limiter) DIP 0.99

1N6263 Hot Carrier Diode 0.4V @ 1mA 0.1ns DO-35 1.00

ZENERS—Specify Voltage 3.3, 3.9, 4.3, 5.1, 6.8, 8.2, 400mW 4/\$1.00

9.1, 10, 12, 15, 16, 18, 20, 22, 24, 27, or 33V ( $\pm$ 10%) 1 Watt 3/\$1.00

- MONEY-BACK GUARANTEE
- ALL TESTED AND GUARANTEED

**ADVA** ELECTRONICS  
BOX 4181 GB, WOODSIDE, CA 94062  
Tel. (415) 328-1500

# FREE

IC or FET's WITH  
\$5 & \$10 ORDERS.+  
DATA SHEETS  
WITH MANY ITEMS.

DIODES	TRANSISTORS		TRANSISTORS		TRANSISTORS		LINEAR IC's	
ZENERS & RECTIFIERS	2N706	\$0.24	2N4091	3/\$1	2N5638	2/\$1	LM240K-5	\$1.20
1N456 to 1N458	2N718	.24	2N4092	\$0.75	2N5640	2/\$1	LM340T-5	1.20
1N463 to 1N466	2N720	.48	2N4121	3/\$1	CP643	\$4.00	LM340T-6	1.20
1N746 to 1N759	2N918	3/\$1	2N4122	3/\$1	CP650*	\$5.00	LM340T-12	1.20
1N914*	2N1613	\$0.29	2N4124	5/\$1	CP651	\$4.00	LM340T-15	1.20
1N962 to 1N974	2N1711	.28	2N4248	5/\$1	E100	4/\$1	LM340T-24	1.20
1N3064	2N1890	.38	2N4249	5/\$1	E101	3/\$1	LM376N*	.55
1N3600	2N1893	.38	2N4250	4/\$1	E102	3/\$1	LM377N	2.50
1N4001*	2N2219	.24	2N4274	5/\$1	E175	3/\$1	LM380N	1.29
1N4003	2N2222	6/\$1	2N4302	\$0.29	MPF102 to*	3/\$1	NE555V*	2/\$1
1N4004	2N2222A	5/\$1	2N4303	.29	MPF104	3/\$1	NE556A	\$0.90
1N4005	2N2369	5/\$1	2N4338	5/\$1	MPF112	4/\$1	LM709CH	.29
1N4006	2N2606 to	\$2	2N4360M	2/\$1	MPS6515	3/\$1	LM709CN	.29
1N4007	2N2609	\$0.24	2N4391	5/\$1	SE1001	4/\$1	LM723H	2/\$1
1N4008	2N2905	\$0.24	2N4392	\$0.90	SE1002	4/\$1	LM723N*	3/\$1
1N4009	2N2906A	.24	2N4416	2/\$1	SE2001	4/\$1	LM739N	\$1.00
1N4010	2N2907*	5/\$1	2N4416A	\$0.80	SE2002	4/\$1	LM741CH	3/\$1
1N4015	2N3553	\$1.50	2N4856 to	\$1	SE5001 to	3/\$1	LM741CN*	4/\$1
1N4016	2N3553	6/\$1	2N4861	5/\$1	SE5003	3/\$1	LM741CN14	3.21
1N4017	2N3554	4/\$1	2N4867E	2/\$1	SE5020	\$3.00	LM747CN	.65
1N4148	2N3555 to	6/\$1	2N4868E	2/\$1	TIS73 to	3/\$1	748C DIP	.35
1N4154*	2N3568	6/\$1	2N4881	\$2.50	TIS75		749C DIP	1.00
1N4370 to	2N3638	6/\$1	2N4888	\$1	DIGITAL IC's		844CP mDIP	.80
1N4372	2N3638A	5/\$1	2N4905	3/\$1	MM5738N	\$2.95	LM1304N	1.15
1N4454	2N3641	5/\$1	2N5087	4/\$1	SN7400N	.16	LM1498N*	3/\$1
1N4728 to	2N3642	5/\$1	2N5088	4/\$1	SN7410N	.16	LM2111N	\$1.40
1N4753	2N3643	6/\$1	2N5126 to	6/\$1	SN7420N	.16	KR2556CP	1.55
1N5231 to	2N3644	4/\$1	2N5135	5/\$1	SN7440N	.16	Z740DE	1.95
1N5236	2N3646	4/\$1	2N5138	5/\$1	SN7440N	.16	CA3028A	1.75
			2N5139	5/\$1	SN7451N	.18	CA3046	.64
			2N5163	3/\$1	SN7473N	.36	LM3075CN1	1.45
			2N5167	2.50	SN7475N	.48	CA3066	.62
			2N5197	\$5.00	SN7476N	.35	LM3900N	.55
			2N5199	2.50	SN7490N	.44	RC4194D	1.50
			2N5210	3/\$1	LINEAR IC's		RC4194TK*	2.50
			2N5208	2/\$1	LM100H	\$7.50	RC4195DN*	1.25
			2N5307	3/\$1	LM301AN	.27	RC4195TK*	2.25
			2N5307	3/\$1	LM307H	.27	LM4250CN	2.00
			2N5457	3/\$1	LM308N	.88	RC4558DN	.55
			2N5458	\$0.38	LM309K	.94	N5558V	.95
			2N5484	3/\$1	LM309K	.94	N5558V	.95
			2N5486	2/\$1	LM311N	.90	N5558V	.95
			2N5487	3/\$1	LM320K-5	1.35	$\mu$ A7805UC	1.25
			2N5543	3.00	LM320K-12	1.35	8038 DIP*	3.75
			2N5544	2.50	LM320K-15	1.35	DM7549Z	.89
			2N5561	12.00				

### \*SUPER SPECIALS:

1N34	Germanium Diode	10/\$1	FSA2501M Diode Array	2/\$1
1N914	100V/10mA Diode	20/\$1	MPF102 200MHz RF Amp	3/\$1
1N4001	50V/1A Rectifier	15/\$1	40673 MOSFET RF Amp	\$1.75
1N4154	30V 1N914	25/\$1	LM324 Quad 741 Op Amp	.94
BR 1	50V 1/2A Bridge Rec.	4/\$1	LM376 Pos Volt Reg mDIP	.55
2N2222	NPN Transistor	6/\$1	NE555 Timer mDIP	.38
2N2907	PNP Transistor	6/\$1	LM723 2-37V Reg DIP	3/\$1
2N3055	Power Xistor 10A	\$0.75	LM741 Comp Op Amp mDIP	6/\$1
2N3904	NPN Amp/Sw $\beta$ 100	6/\$1	LM1458 Dual 741 mDIP	3/\$1
2N3906	PNP Amp/Sw $\beta$ 100	6/\$1	CA3086 5 Trans Array DIP	.62
CP650	Power FET 1/2Amp	\$5	RCA29 Pwr Xistor 1A 30W	.70

RF391	RF Power Amp Transistor 10-25W @ 3-30MHz TO-3	\$5.00
555X	Timer 1 $\mu$ s-1hr Different pinout from 555 (w/data)	3/\$1
RC4194TK	Dual Tracking Regulator $\pm$ 0.2 to 30V @ 200mA TO-66	\$2.50
RC4195TK	Dual Tracking Regulator $\pm$ 15V @ 100mA (TO-66)	\$2.25
8038	Waveform Generator $\square$ $\Delta$ $\nabla$ $\wedge$ Wave With Circuits & Data	\$3.75

## NEW SPECIALS

LM318CN	High Speed Op Amp 50V/ $\mu$ s mDIP	\$0.94	1N270	Germanium Diode 80V 200mA	4/\$1
LM318D	High Speed Op Amp 50V/ $\mu$ s DIP	.90	1N823	Temp Comp Reference	
LM339N	Quad Comparator Single or Dual Supply	.79	6.2V $\pm$ 5% $\pm$ .005%/°C \$0.60		
LM380N-8	1/2W Audio Power Amplifier 8-22V	.90	1N914	Silicon Diode 100V 10mA	25/\$1
NE567V	Tone Decoder (PLL) 0.01Hz to 500kHz	.99	1N3044	100V Zener 1W—Better than an OB3	.75
XR567CP	Tone Decoder (PLL) 0.01Hz to 500 kHz	.99	1N3045	110V Zener 1W—Better than an OB2/OC3	.75
LM723CN	Precision Voltage Regulator 2-37V DIP	3/\$1	1N3071	200V 100mA Switching Diode 40ns	.30
LM747CN	Dual 741 Compensated Op Amp	2/\$1			
SAD1024	Dual 512 Stage (1024) Audio Delay Line "Bucket Brigade" Appl. Data included	\$18.95	2N2915	NPN Dual Transistor 3mV Match $\beta$ 100	\$1.95
XR2206CP	Function Generator with applic. data	4.40	2N3819M	N-Channel RF FET 100MHz Amp	.35
XR2242CP	Long-Range Precision Timer $\mu$ s to days	1.50	2N4020	PNP Dual Transistor 5mV Match $\beta$ 250	5.00
1 YEAR TIMER Kit-2 XR2242's and Applic. Note		3.00	2N4445	N-Channel FET 5 $\Omega$ Switch	3.50
LM2901N	Quad Comparator +5V or 2 to 36VDC	\$1.20	2N5394E	Ultra-Low Noise J-FET Audio Amp	\$1.25
CA3018A	4-Transistor Array/Darlington	.99	2N5912	Dual J-FET RF Dif Amp to 800MHz	2.90
CA3028A	RF/IF Amplifier DC to 120MHz	1.25	2N6028	Programmable Unijunction Transistor	.45
RC4558	Dual High Gain Op Amp mDIP	3/\$1	2N6449	300 Volt N-Channel J-FET Amp/Sw	2.00
SPACER Kit - 4 ea of 5 assorted size spacers		\$1.00	CP640	Broadband FET RF Amp 140dB Dyn Range	\$4.50
$\pm$ 15 VOLT Regulated Power Supply Kit-Easy assembly, 5mV regulation, 100mA, fully protected. Includes all components and hardware, no PCB or case—Add \$1.50 for shipping		\$13.95	E304	N-Channel RF FET 3.8dB NF @ 400MHz	.50
			MPSA12	NPN Darlington Transistor $\beta$ 20,000	.75
			TIS88	N-Channel FET 400MHz RF Amp	.60
			RESISTOR Kit—150 pcs 1/4W, 20 most common values, individually packaged, 5 to 20 pcs each		\$4.95
			PC BOARD Mounting Kit—8 ea spacer, screw, nut and washer—32 pcs total		\$1.00

SEND FOR ADVA'S NEW 1979 CATALOG  
NEARLY 1000 SEMICONDUCTORS, KITS, CAPACITORS, ETC.—SEND 25¢ STAMP.

**ADVA** ELECTRONICS

BOX 4181 GB  
WOODSIDE, CA 94062  
Tel.(415) 328-1500

# M-M Electronic Sales

U8

A division of **united products Corporation**  
 Corp. Hdqts., 2300 1st Ave. — Seattle, WA 98121 • (206) 682-5025

# FREE

## FREE 5 FUNCTION L.C.D. MENS WATCH

SECONDS-MINUTES-HOURS-DAY-MONTH  
 If your order totals \$50.00 or more we will send you this national semiconductor L.C.D. Watch, valued at \$29.95  
**FREE!**

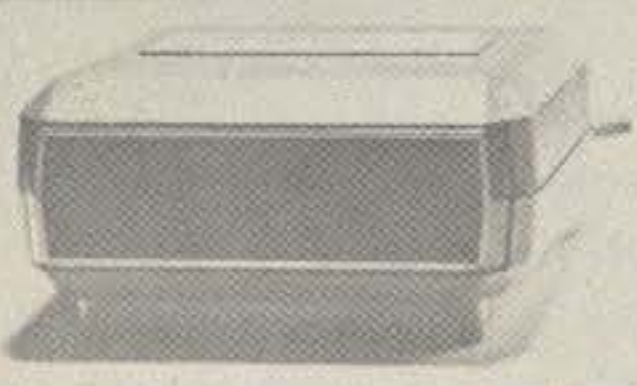

**INSTRUMENT CLOCK CASE KIT**  
 A real jewel for those small projects. Hinged top door allows you to hide your control area. O.D. 4 1/2" x 4" x 1 3/4".  
**\$1.99 each.**



**ANTENNA SELECTING SWITCH D.P.D.T.**  
 Long through slide switch providing correct isolation for 300 OHM Twin Lead. 35¢ ea. 4 for ONLY \$1.00



**FERROX CUBE TORROID CORE** 95¢  
 9/16" I.D.



**DIP SPACED FLEX JUMPER** Pre-cut 1 1/2" L. and pre-stripped. Pkg. 20 **\$1.99**

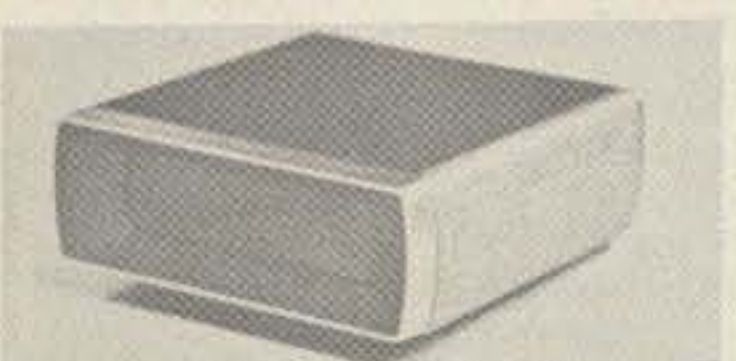

**INSTRUMENT/CLOCK CASE KIT**  
 Perfect for your opto projects. Solid aluminum construction with real walnut sides. O.D. 5-3/8" by 5-3/8" by 2". **\$6.95 ea.**



**NAUGAHYDE ZIPPER POUCH**  
 O.D. Approx. 4"X7" Brand new and of the finest quality. It even has a convenient belt loop. **95¢**

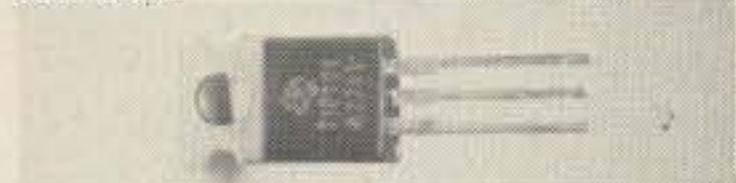

**TIP 121 (RCA121)**  
 NPN Darlington  
 60 Watt 8 Amp  
 HFE 1000 TO-220  
**\$0.95 ea.**  
**2/\$1.50**



**TRANSFORMER** Pri. 110 VAC Sec. 11.2 and 5 VCT @ .1 amp **\$.95 ea.**



**ROTRON WHISPER FAN #WR2H1**  
 75CFM, 115VAC. Net \$17.00 Meas. 4" diam. NOTE: These are not pull outs, these are new. **YOUR PRICE \$9.95**



**L.E.D. WATCH GUTS** (untested)  
 All take 2, 1.5V Bat. Mens size 75¢ ea. 2 for **\$1.00**



**CRYSTAL 3.579545 MHZ**  
 This is the one you need for your time base. Reg. Price \$4.95 **YOUR PRICE \$2.50** (while they last)



**SOLDERLESS CRIMP ON TERMINAL ASSORTMENT**  
 50 Pieces of the most popular sizes in a convenient plastic storage box. (bulk available on request) **ONLY \$1.49**

**1/4 WATT 5% DEPOSITED CARBON FILM RESISTOR ASSORTMENTS**

ASST. A	10 ea 1 OHM 1.5 OHM 2 OHM 2.7 OHM 3 OHM 3.6 OHM 4.7 OHM 5.6 OHM 6.8 OHM 8.2 OHM	100 pcs \$2.40
ASST. B	10 ea 10 OHM 12 OHM 15 OHM 18 OHM 22 OHM 27 OHM 33 OHM 39 OHM 47 OHM 56 OHM	100 pcs \$2.40
ASST. C	10 ea 68 OHM 82 OHM 100 OHM 120 OHM 150 OHM 180 OHM 220 OHM 270 OHM 330 OHM 390 OHM	100 pcs \$2.40
ASST. D	10 ea 470 OHM 560 OHM 680 OHM 820 OHM 1K 1.2K 1.5K 1.8K 2.2K 2.7K	100 pcs \$2.40
ASST. E	10 ea 3.3K 3.9K 4.7K 5.6K 6.8K 8.2K 10K 12K 15K 18K	100 pcs \$2.40
ASST. F	10 ea 22K 27K 33K 39K 47K 56K 68K 82K 100K 120K	100 pcs \$2.40
ASST. G	10 ea 150K 180K 220K 270K 330K 390K 470K 560K 680K 820K	100 pcs \$2.40
ASST. H	10 ea 1M 1.2M 1.5M 1.8M 2.2M 2.7M 3.3M 3.9M 4.7M 5.6M	100 pcs \$2.40
ASST. A-H	INCLUDES ALL RESISTOR ASSORTMENTS (800 pcs)	\$14.95 ea

## THE GOODIE BOX

- 1000 uf 25VDC P-C ..... \$ .25
- 2000 uf 25VDC AXIAL ..... .50
- 18 ga. LINE CORD 6' ..... .25
- Trimmer Cap. 3-30pf VERT. P-C ..... .50
- RCA Jack, Right Angle P-C ..... .25
- TINI-JAX ..... 50¢ ea. 3/1.00
- TO-220 Clip on Heat Sink ..... .20
- #30 Kynar (any color) 100' Spool ..... 1.00
- Speaker Terms ..... 15¢ ea. 10/1.00
- 10K Lin. 2 watt Pot ..... .50
- AAA Rechargeable NI-CAD ..... .95
- Mini-Plug ..... .50
- S.P.D.T. min. Slide Switch ..... 25¢ ea. 5/1.00



**SYNCHRONOUS STEPPING MOTOR**  
 SLO-SYN #MO62-FD09  
 1 7V  
 200 steps per rev  
 65 oz in torque  
**Net Cost \$42.28** **Your Cost \$29.95**



22VDC @ 140 MA Adapter ..... \$1.95  
 4.5 VDC @ 265 MA Adapter ..... \$1.95



**MM 5766 PROGRAMMER**  
 • Dynamic Key Sequence Programmer  
 • Remembers any combination of key entries in the load mode.  
 • Automatically plays them back in the run mode  
 • Stores up to 102 characters.  
 Experimenters will have a lot of fun with this clip as it is possible to build many projects with it. We will supply pin outs and specs with your order.  
**Net Price \$20.00** **Your Cost ONLY \$4.95 ea**

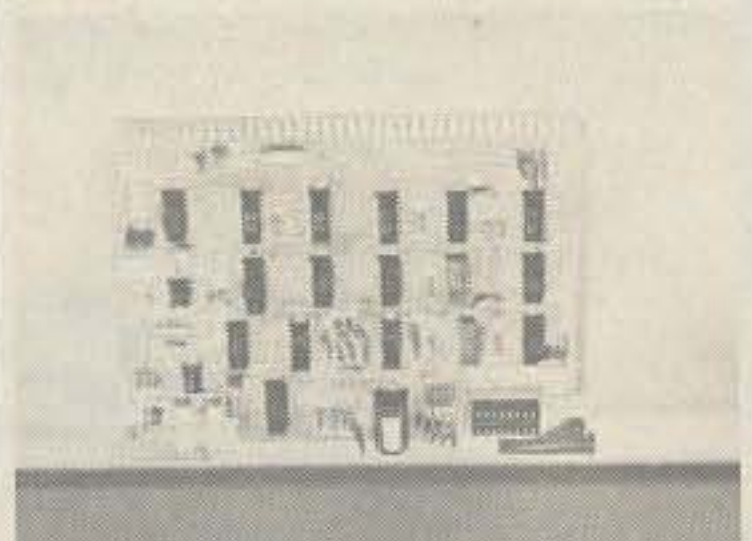

**PARTS BOARDS** A great way to buy parts on a budget. We guarantee your money's worth. **ONLY \$1.00 ea.**

**L.C.D. DISPLAYS**  
 SMALL SIZE  
**45¢ EA. 3 FOR \$1.00**  
 (UNTESTED)

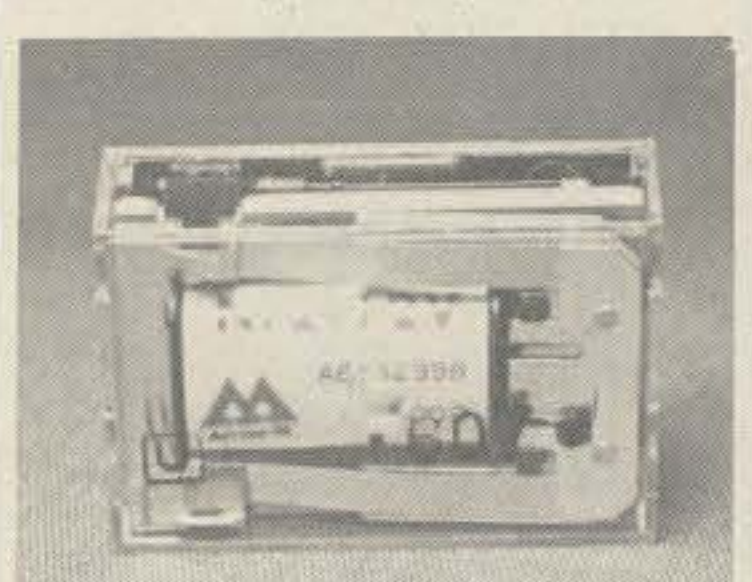

**MINIATURE D.P.D.T. 12VDC RELAY**  
 500 OHM Coil 1-1/8" X 3/4 X 3/8"  
 ARROW-M #NF2-12V **ONLY \$2.99 ea.**  
 P-C Mount



**XMAS STOCKING STUFFERS**  
 National Semiconductor  
 L.C.D. Men's watches  
 • DEAWBO5T  
 • 5 Function Tritium Night Watch  
 • Hours: Minutes: Month: Day: Seconds:  
 • Silver with Metal Band  
**Your Price ONLY \$22.95**



• DABYBO4T  
 • 5 Function Tritium Night Watch  
 • Hours: Minutes: Seconds: Calender Date: and Day of the Week Pointer  
 • Gold with Metal Band  
**Your Price ONLY \$29.95**

**TRITIUM WATCHES:**  
 A Tritium Watch produces it's own night light. No more button pushing!

**Terms:** All orders shipped promptly. Minimum order \$5.00. Telephone orders accepted. All orders shipped UPS or PP. Add 5% extra for shipping & handling. Washington state residents add additional 5.3% sales tax. Master Charge & Visa cards accepted. Money orders & your personal or company check are welcome. Funds made payable in U.S. currency only. No C.O.D. orders. Your satisfaction guaranteed on all merchandise purchased. All merchandise subject to prior sale. Open account to govt. agencies & publicly funded schools.

**Store Hours**  
 M-F 9-6 • SAT 9-5  
**O.E.M.'s WELCOME**

For Master Charge/Visa Orders use our **TOLL FREE HOT LINE: 1-800-426-0634** for areas outside Washington (incl. Alaska & Hawaii)

**NEW!**



**Tunable 420 MHz Fast Scan TV Converter**

Receive Fast Scan Amateur TV in the 420 to 450 MHz Band with any TV set. Low noise, high gain rf Amp with Varactor tuned input and outputs. Built in AC supply. Comes in two tone walnut & beige cabinet measuring 1-7/8" x 4-1/4" x 4-1/8". Factory wired with 2-year guarantee. ATVC-10 \$59.95

Basic Varactor Tuner & PS Kit w/instructions  
ATVC-10K \$39.95

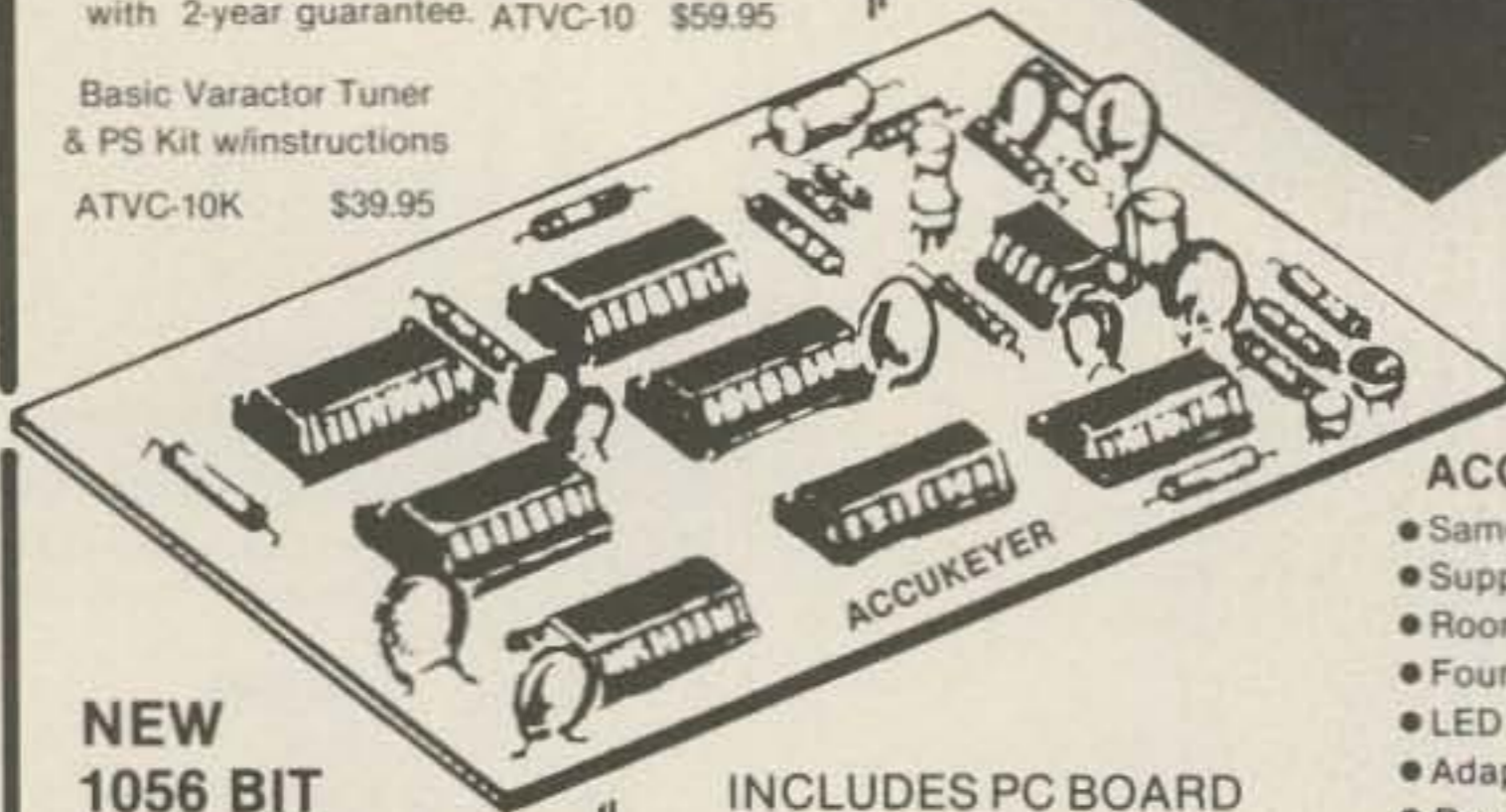

**NEW 1056 BIT EXPANDABLE MEMORY KIT**

INCLUDES PC BOARD AND PARTS STILL ONLY  
**\$19.95**

**ALDELCO ELECTRONIC COMPANY**

**THE VERY POPULAR**

**TOPE ACCUKEYER KIT**

- Self Completing Dots & Dashes
- Iambic Operation
- Single Dot & Dash Memories
- Provision for Attachment of Memory for DX or Contest Work

Revised version of the Accukeyer featured in the ARRL Handbook. Has more logical IC Layout and ON Board sidetone Oscillator. Includes PC Board, TTL ICs, 555 Timer, IC Sockets, Switch, Speaker, Transistors, capacitors and resistors. Requires 5 VDC. **\$19.95**  
Use our PS-5 Power supply kit to power keyer & Memory only \$7.95

**MEMORY ADD ON KIT**

3 each: 2102, Push Button Switch, Led, 16 Pin Socket \$6.00

OV-12 Crow Bar Overvoltage Protection Circuit. Triggers App. 16 to 18 volts \$8.95  
5 to 8 volts 9.95

**ACCUKEYER MEMORY KIT**

- Same size PC Board as Accukeyer
- Supplied with one 2102 Memory Chip
- Room on the board for three more
- Four chips will total 4224 BITS
- LED indicator for Programming
- Adaptable to other keyers
- Requires 5 volts DC

**BUILD A 6 DIGIT 500 MHz FREQUENCY COUNTER**



**COMPLETE LUNCH COUNTER KIT \$79.95**  
Includes a reprint of a six-page construction article from Dec. 1978, 73 Magazine.

Aldelco can supply 3 PC boards. Silk screened front panel and complete instructions for only \$12.50 & shipping.

**SOME PARTS USED IN COUNTER**

11C90 Prescaler	\$19.95
74C925 Multiplex	12.95
F9368 Driver (2)	12.90
1 MHz XTAL	7.95
10.60 pF trim cap	.60
Resistor kit	1.75
Capacitor kit	5.50

See six page construction article in Dec. 1978 73 Magazine

RF TRANSISTORS											
SD1018-4	40W	4.5db	450MHz	380-4LFL	15.25	2N3375	3.0W	400 MHz TO60	5.60		
SD1074	50W	11db	30MHz	500-6LFL	21.15	2N3553	2.5W	175 MHz TO39	1.40		
SD1076	75W	13	50	500-6LFL	24.00	2N3866	1.0W	400 MHz TO39	1.25		
SD1088	25W	6	450	500-6LFL	23.25	2N4427	1.0W	175 MHz TO39	1.35		
SD1089	40W	5	450	500-6LFL	27.15	2N5589	3.0W	175 MHz MT71	4.75		
SD1143	10W	10	200	MT72	10.95	2N5590	10W	175 MHz MT72	7.80		
SD1158	12W	5.3	200	TO117	12.30	2N5591	25W	175 MHz MT72	10.25		
SD1272	30W	6	220	MT72	9.60	2N5913	1.75W	175 MHz TO39	1.70		
SD1278	50W	10	50	MT72	16.30	2N6080	4.0W	175 MHz MT72	5.40		
SD1416	70W	6.7	175	500-6LFL	26.80	2N6081	15W	175 MHz MT72	8.45		
SD1428	45W	6.5	175	500-6LFL	22.65	2N6082	25W	175 MHz MT72	11.70		
SD1433	8W	7.5	450	MT90	9.50	2N6083	30W	175 MHz MT72	11.70		
SD1434	50W	5	450	500-6LFL	34.00	2N6084	40W	175 MHz MT72	13.50		
SD1451	50	14	50	500-6LFL	18.10	2N6094	4.0W	175 MHz X106	6.60		
SD1477	100W	6	175	500-6LFL	52.85	2N6095	15W	175 MHz X106	8.50		
2N5945	4W	8	450	MT90	10.75	2N6096	30W	175 MHz X106	10.35		
2N5946	10W	6	450	MT90	13.00	2N6097	40W	175 MHz X106	20.00		

**TELCO COMMANDER SERIES RF POWER AMPLIFIERS**



Model	Watts input	Watts output	144-148 MHz
125	1	25	\$99.00
180	10	80	\$149.00
250	25	100	\$199.00
256	25	160	\$249.00
258	1-25	25-180	\$299.00
ULTRA 430 MHz III	3-5	up to 50	\$379.00

other UHF models in production

**FMMC 1**



Dynamic  
Touch  
Tone Mic  
**\$39.95**



**FM2016A** New Yorkers must pay sales tax  
**144 to 149 MHz 1000 CHANNELS**  
SHOWN WITH OPTIONAL µP-800 MICRO PROGRAMMER



All the features of the 2015R and now with adjustable sine wave PL 60 Hz to 203 Hz. Adjustable low power position 1 Watt to 16 Watts.

**Low, Low Price**  
**\$299**

Buy your KDK from Aldelco and we'll pay UPS shipping and insurance in the 48 states. Sorry no charge cards accepted

Regulated AC/PS Model FMPS-4R... \$39.95

**ALARM CLOCK KIT**

6 Big 0.5 LED Displays • On Board AC Transformer • 12 Hour Format with 24 Hour Alarm • Snooze Feature • Elapsed Timer. Timer feature makes this Popular in Broadcast Stations. It's a natural for cars, boats and campers when used with optional crystal time base. Fits our standard cabinet. \$21.95  
Crystal time base when purchased with clock. \$3.95

**12 or 24 HOUR DIGITAL CLOCK KIT**

Uses 0.5 Display LED. 5314 Clock Chip. Freeze feature for accurate set. fits our standard cabinet. ONLY \$19.95

**CLOCK CABINETS**

Woodgrain or black leather ea. \$4.95

**CRYSTAL TIME BASE KIT**

Includes PC Board, Crystal, all parts and instructions. \$4.95

**ALDELCO KITS**

**DUAL DIGITAL 12/24 HOUR CLOCK KIT NOW WITH A NEW WALNUT GRAIN WOOD CABINET**

**ONLY \$49.95**

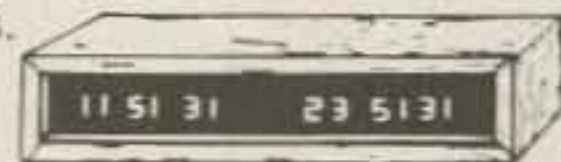

**BIG MODEL ALD 5-W 0.5 LEDS**

- Features:
- 12 or 24 Hour Operation on either clock
  - Each Clock separately controlled
  - Freeze feature for time set
  - Easy assembly for clock and cabinet

**ADJUSTABLE POWER SUPPLY KITS**

5-15 Volts 500 MA Model PS5	\$7.95
12-20 Volts 500 MA Model PS12	7.95

**ALDELCO**

2789A MILBURN AVE, BALDWIN, N.Y. 11510  
516-378-4555

Add 6% shipping. Add \$1.00 for orders under \$10.00. Out of U.S.A. add 15% shipping and certified check or money order in U.S. funds.

# Radio Bookshop

## LICENSE STUDY GUIDES & TAPES

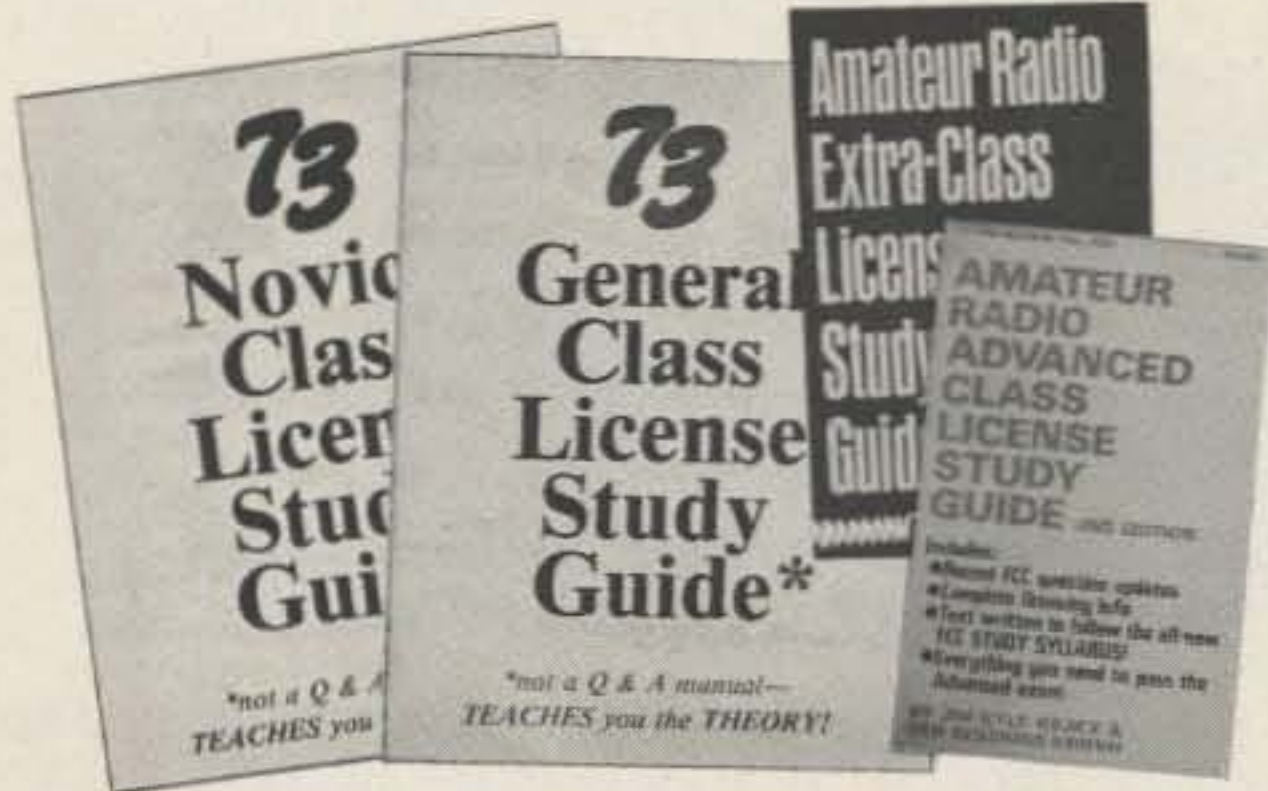

● **NOVICE STUDY GUIDE—SG7357**—Here is a completely new study guide and reference book for the potential ham. This is not a question/answer memorization course. Electronic and radio fundamentals are presented and explained in an easy-to-understand fashion, preparing the beginner for the Novice exam. Includes the latest FCC amateur regulations, as well as application forms. Easily the best path into the exciting world of ham radio! \$4.95.\*

● **GENERAL CLASS STUDY GUIDE—SG7358**—A complete theory course for the prospective General or Technician. This reference explains transistor, amplifier, and general radio theory, while preparing the Novice for the "big" ticket. After getting your ticket, you'll use this guide again and again as an electronic reference source. Not a question/answer guide that becomes dated when the FCC updates the amateur exams. \$5.95.\*

● **ADVANCED CLASS STUDY GUIDE—SG1081**—Ready to upgrade your license? To prevent retaking the FCC theory exam, you need the 73 Advanced theory guide. SSB, antenna theory, transmitters, and electronics measuring techniques are covered in detail in this easy-to-follow study guide. Special modes and techniques, such as RTTY, are also treated. An engineering degree is not necessary to master Advanced theory—try this book before visiting the examiner's office! \$5.95.\*

● **EXTRA CLASS LICENSE STUDY GUIDE—SG1080**—Before going for your 1 × 2 call, it pays to be a master of the Extra class electronic theory. This study guide is the logical extension of the 73 theory course. All the theory necessary to pass the exam is presented. Antennas, transmission lines, swr are discussed, as well as noise, propagation, and specialized communication techniques. This book is not a classroom lecture or memorization guide, but rather a logical presentation of the material that must be understood before attempting the Extra exam. Save yourself a return trip to the FCC and try the 73 method first! \$5.95.\*

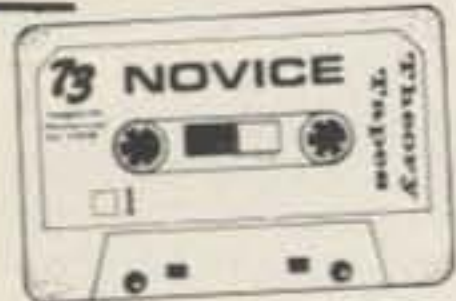

## NOVICE THEORY TAPES Startling Learning Breakthrough



● **NOVICE THEORY TAPES—CT7300**—Startling Learning Breakthrough. You'll be astounded at how really simple the theory is when you hear it explained on these tapes. Three tapes of theory and one of questions and answers from the latest Novice exams give you the edge you need to breeze through your exam. 73 is interested in helping get more amateurs, so we're giving you the complete set of our tapes for the incredibly low price of **ONLY \$15.95.\***

Scientists have proven that you learn faster by listening than by reading because you can play a cassette tape over and over in your spare time—even while you're driving! You get more and more info each time you hear it.

You can't progress without solid fundamentals. These four hour-long tapes give you all the basics you'll need to pass the Novice exam easily. You'll have an understanding of the basics which will be invaluable to you for the rest of your life! Can you afford to take your Novice exam without first listening to these tapes? Set of 4—\$15.95.\*

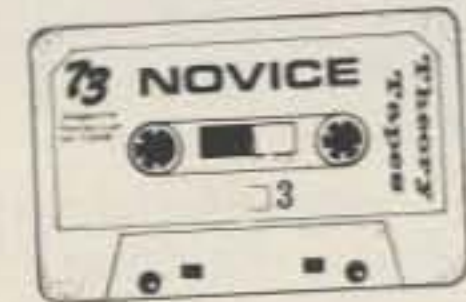

## SSTV

● **SLOW SCAN TELEVISION TAPE—CT7350**—Prize-winning programs from the 73 SSTV contest. Excellent for Demo! \$5.95.\*

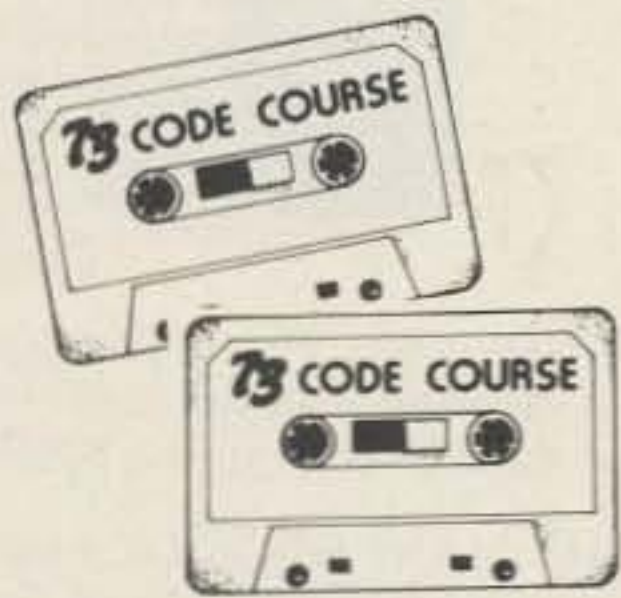

## 73 CODE SYSTEM TAPES

code, sent at the official FCC standard (no other tape we've heard uses these standards, so many people flunk the code when they are suddenly—under pressure—faced with characters sent at 13 wpm and spaced for 5 wpm). This tape is not memorizable, unlike the zany 5 wpm tape, since the code groups are entirely random characters sent in groups of five.

### "COURAGEOUS"

20+ WPM—CT7320—Code is what gets you when you go for the Extra class license. It is so embarrassing to panic out just because you didn't prepare yourself with this tape. Though this is only one word faster, the code groups are so difficult that you'll almost fall asleep copying the FCC stuff by comparison. Users report that they can't believe how easy 20 per really is with this fantastic one hour tape.

Any Four Tapes For \$15.95!  
\$4.95 Each!\*

### "GENESIS"

5 WPM—CT7305—This is the beginning tape for people who do not know the code at all. It takes them through the 26 letters, 10 numbers and necessary punctuation, complete with practice every step of the way using the newest blitz teaching techniques. It is almost miraculous! In one hour many people—including kids of ten—are able to master the code. The ease of learning gives confidence to beginners who might otherwise drop out.

### "THE STICKLER"

6+ WPM—CT7306—This is the practice tape for the Novice and Technician licenses. It is made up of one solid hour of

### "THE CANADIAN"

10+ WPM—CT7310—73 hasn't forgotten the Canadian hams—our 10 WPM tape prepares you to breeze through your country's licensing exams. Like the other code groups, the tape is not memorizable and, once mastered, provides a margin of safety in the actual text situation.

### "BACK BREAKER"

13+ WPM—CT7313—Code groups again, at a brisk 13 per so you will be at ease when you sit down in front of the steely-eyed government inspector and he starts sending you plain language at only 13 per. You need this extra margin to overcome the panic which is universal in the test situations. When you've spent your money and time to take the test, you'll thank heavens you had this back-breaking tape.

### "OUTRAGEOUS"

25+ WPM—CT7325—This is the tape for that small group of overachieving hams who wouldn't be content to simply satisfy the code requirements of the Extra Class license. It's the toughest tape we've got and we keep a permanent file of hams who have mastered it. Let us know when you're up to speed and we'll inscribe your name in 73's CW "Hall of Fame."



Use the order card in the back of this magazine or itemize your order on a separate piece of paper and mail to:  
73 Radio Bookshop • Peterborough NH 03458. Be sure to include check or detailed credit card information.  
\*Add \$1.00 handling charge. Note: Prices subject to change on books not published by 73 Magazine.

**FOR CUSTOMER SERVICE CALL (603) 924-7298**

# Radio Bookshop

## 73 TECHNICAL LIBRARY

● **BEHIND THE DIAL**—BK7307—By Bob Grove. Get more fun out of shortwave listening with this interesting guide to receivers, antennas, frequencies and interference. \$4.95.\*

● **THE CHALLENGE OF 160**—BK7309—is the newest book in the 73 technical library, dedicated to 160 meter operating. Si Dunn provides all necessary information to get started on this unique band. The all-important antenna and ground systems are described in detail. The introduction contains interesting photos of Stew Perry's (the King of 160) shack. This reference is a must for new and experienced "Top Band" operators. Price: \$4.95.\*

● **IC OP-AMP COOKBOOK**—BK1028—by Walter G. Jung. Covers not only the basic theory of the IC op amp in great detail, but also includes over 250 practical circuit applications, liberally illustrated. 592 pages, 5½ × 8½, softbound. \$12.95.\*

● **THE POWER SUPPLY HANDBOOK**—BK7305—Need a power supply for a gadget you're building? In the **POWER SUPPLY HANDBOOK** there are dozens ready-to-build, plus detailed steps for designing your own. There are circuits and parts lists for all kinds of supplies, ranging from simple DC types to highly stable regulated versions. If you need a circuit to convert a DC voltage to a higher or lower voltage, turn DC into AC, or AC to DC—then this is the book you need. With more than 400 pages, you should be able to find just the circuit you need. Without a doubt one of the best power supply source books available, compiled by the editors of 73. \$7.95.\*



● **INTRODUCTION TO RTTY**—BK7380—A beginner's guide to radioteletype including teletypewriter fundamentals, signals, distortion and RTTY art. You can be a RTTY artist! A 73 publication. \$2.00.\*

● **THE NEW RTTY HANDBOOK**—BK7347—is a new edition and the only up-to-date RTTY book available. The state of the art has been changing radically and has made all previous RTTY books obsolete. It has the latest circuits, great for the newcomer and expert alike. \$5.95.\*

● **PROPAGATION WIZARD'S HANDBOOK**—BK7302—by J. H. Nelson. When sunspots riddled the worldwide communications networks of the 1940's, John Henry Nelson looked to the planets for an answer. The result was a theory of propagation forecasting based upon interplanetary alignment that made the author the most reliable forecaster in America today. The book provides an enlightened look at communications past, present, and future, as well as teaching the art of propagation forecasting. \$6.95.\*

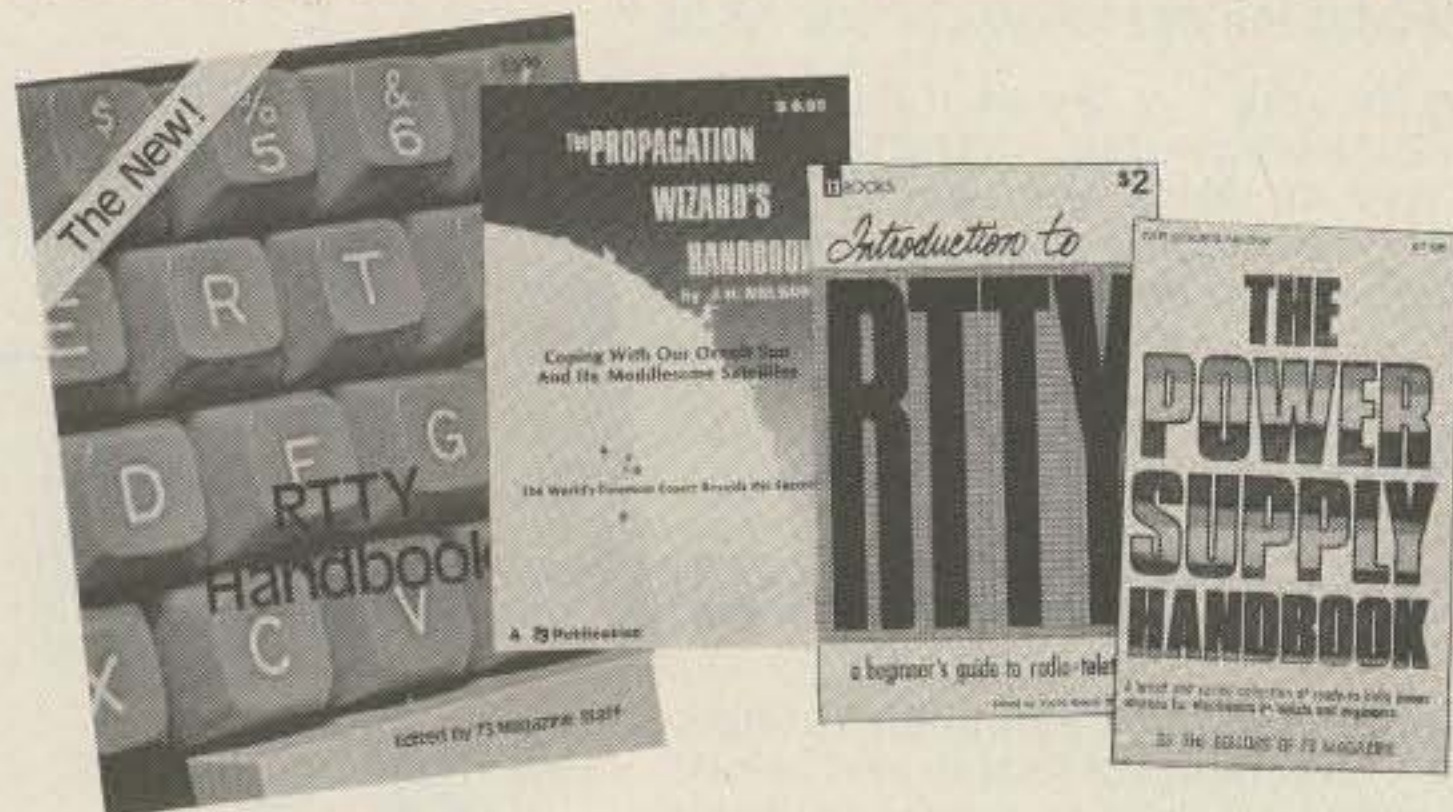

● **SSB . . . THE MISUNDERSTOOD MODE**—BK7351—by James B. Wilson. Single Sideband Transmission . . . thousands of us use it every day, yet it remains one of the least understood facets of amateur radio. J. B. Wilson presents several methods of sideband generation, amply illustrated with charts and schematics, which will enable the ambitious reader to construct his own sideband generator. A must for the technically-serious ham. \$5.50.\*

● **SSTV HANDBOOK**—BK7354(hardcover), BK7355(softcover)—This excellent book tells all about it, from its history and basics to the present state-of-the-art techniques. Contains chapters on circuits, monitors, cameras, color SSTV, test equipment and much more. Hardbound \$7.00, softbound \$5.00.\*

● **WEATHER SATELLITE HANDBOOK**—BK7370—Simple equipment and methods for getting good pictures from the weather satellite. Antennas, receivers, monitors, facsimile you can build, tracking, automatic control (you don't even have to be home). Dr. Taggart WB8DQT. \$4.95.\*

● **73 DIPOLE AND LONG-WIRE ANTENNAS**—BK1016—by Edward M. Noll W3FQJ. This is the first collection of virtually every type of wire antenna used by amateurs. Includes dimensions, configurations, and detailed construction data for 73 different antenna types. Appendices describe the construction of noise bridges, line tuners, and data on measuring resonant frequency, velocity factor, and swr. \$5.50.\*



● **THE GIANT BOOK OF AMATEUR RADIO ANTENNAS**—BK7304—With the **GIANT Book of Amateur Radio Antennas** by your side, antennas will become the least of your worries. Over 450 pages of design ideas, theory and reference data make this book live up to its title. The 7 chapters cover everything from basic antenna theory through designs for DIY accessories, as well as dozens of antenna designs. Whether planning to build or buy, design or admire, test or enjoy a ham antenna—this is the book for you. From the editors of 73; published by Tab Books. \$12.95 Hardback.\*

● **73 VERTICAL, BEAM AND TRIANGLE ANTENNAS**—BK1069—by Edward M. Noll W3FQJ. Describes 73 different antennas for amateurs. Each design is the result of the author's own experiments covering the construction of noise bridges and antenna line tuners, as well as methods for measuring resonant frequency, velocity factor, and standing-wave ratios. 160 pages. \$5.50.\*

● **VHF ANTENNA HANDBOOK**—BK7368—The **NEW VHF Antenna Handbook** details the theory, design and construction of hundreds of different VHF and UHF antennas . . . A practical book written for the average amateur who takes joy in building, not full of complex formulas for the design engineer. Packed with fabulous antenna projects you can build. \$4.95.\*



Use the order card in the back of this magazine or itemize your order on a separate piece of paper and mail to:  
73 Radio Bookshop • Peterborough NH 03458. Be sure to include check or detailed credit card information.  
\*Add \$1.00 handling charge. Note: Prices subject to change on books not published by 73 Magazine.

**FOR TOLL FREE ORDERING CALL 1-800-258-5473**



# Radio Bookshop

## TEST EQUIPMENT

● **RF AND DIGITAL TEST EQUIPMENT YOU CAN BUILD**—BK1044—Rf burst, function, square wave generators, variable length pulse generators—100 kHz marker, i-f and rf sweep generators, audio osc, af/rf signal injector, 146 MHz synthesizer, digital readouts for counters, several counters, prescaler, microwave meter, etc. 252 pages. \$5.95.\*

● **VOL. I COMPONENT TESTERS**—LB7359—... how to build transistor testers (8), diode testers (3), IC testers (3), voltmeters and VTVMs (9), ohmmeters (8 different kinds), inductance (3), capacity (9), Q measurement, crystal checking (6), temperature (2), aural meters for the blind (3) and all sorts of miscellaneous data on meters... using them, making them more versatile, making standards. Invaluable book. \$4.95.\*

● **VOL. II AUDIO FREQUENCY TESTERS**—LB7360—... jam packed with all kinds of audio frequency test equipment. If you're into SSB, RTTY, SSTV, etc., this book is a must for you... a good book for hi-fi addicts and experimenters, too! \$4.95.\*

● **VOL. III RADIO FREQUENCY TESTERS**—LB7361—Radio frequency waves, the common denominator of Amateur Radio. Such items as SWR, antenna impedance, line impedance, rf output and field strength; detailed instructions on testing these items includes sections on signal generators, crystal calibrators, grid dip oscillators, noise generators, dummy loads and much more. \$4.95.\*

● **VOL. IV IC TEST EQUIPMENT**—LB7362—Become a troubleshooting wizard! In this fourth volume of the 73 TEST EQUIPMENT LIBRARY are 42 home construction projects for building test equipment to work with your ham station and in servicing digital equipment. Plus a cumulative index for all four volumes of the 73 TEST EQUIPMENT LIBRARY. \$4.95.\*



## THE WELL-EQUIPPED HAM SHACK

● **73 MAGAZINE BINDERS**—Preserve and protect your collection for your lifetime! There's no excuse for lost issues when you have these handsome red binders with gold lettering. Order 1—BN1001—for \$6.50\*; 2 or more—BN1002—for \$6.00 each.\* (specify 1978 or 1979 binders)

● **QSL CARDS**—73 turns out a fantastic series of QSL cards at about half the cost of having them done elsewhere because they are run as a fill-in between printing books and other items in the 73 Print Shop. 250 Style W—QW0250—for \$8.95\*; 500 Style W—QW0500—for \$13.95\*; 250 Style X—QX0250—for \$8.95\*; 500 Style X—QX0500—for \$13.95\*; 250 Style Y—QY0250—for \$8.95\*; 500 Style Y—QY0500—for \$13.95.\* Allow 2-4 mos. for delivery.



● **HOW TO BUILD A MICROCOMPUTER—AND REALLY UNDERSTAND IT**—BK7325—by Sam Creason. The electronics hobbyist who wants to build his own microcomputer system now has a practical "How-To" guidebook. Sam Creason's book is a combination technical manual and programming guide that takes the hobbyist step-by-step through the design, construction, testing and debugging of a complete microcomputer system. \$9.95.\*

● **1979 WORLD REPEATER ATLAS**—BK7346—With a new easy-to-use format, the 1979 World Repeater Atlas is the largest ever published by 73. More than 230 pages of repeaters, listed by both location and frequency, together with over 50 location maps—make this the best repeater atlas ever! Nearly 2000 separate repeater locations are shown on the maps, with greater accuracy than ever before. \$4.95.\*

● **BACK ISSUES**—Complete your collection; many are prime collectables now, classics in the field! A full collection is an invaluable compendium of radio and electronics knowledge!



Style X



Style W

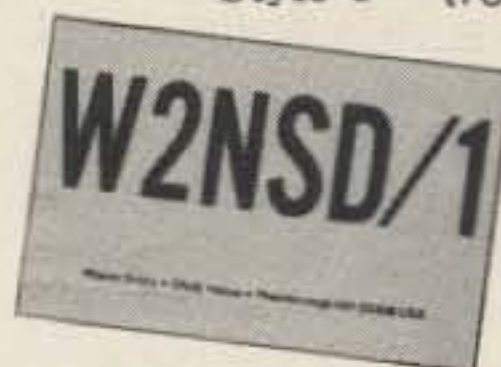

Style Y

Single back issue—ST0000—\$3.00\*;  
25 your choice—ST2500—\$12.00\*;  
25 your choice—ST2501—\$25.00\*;  
5 your choice—ST0500—\$8.75\*;  
10 your choice—ST1000—\$14.00\*.

● **OWNER REPAIR OF AMATEUR RADIO EQUIPMENT**—BK7310—Frank Glass shares over 40 years of operating, servicing, and design experience in this book. There are several books and numerous articles available on the subject of repairs to electronic equipment. The information within these books ranges from the elementary to the highly technical written for the top engineers in the field. But this book stands out from the rest in that it is written in narrative style aimed at conveying the concept of electronic servicing. A written discussion of how components work and how they are combined to provide communication equipment is used to help the reader understand the concepts required to service station equipment. \$7.95.\*

● **A GUIDE TO HAM RADIO**—BK7321—by Larry Kahaner WB2NEL. What's Amateur Radio all about? You can learn the basics of this fascinating hobby with this excellent beginner's guide. It answers the most frequently asked questions in an easy-going manner, and it shows the best way to go about getting an FCC license. A Guide to Ham Radio is an ideal introduction to a hobby enjoyed by people around the world. \$4.95.\*

● **LIBRARY SHELF BOXES**—These sturdy white, corrugated, dirt-resistant boxes each hold a full year of 73 or Kilobaud Microcomputing. With your order, request self-sticking labels for any of the following: 73, Kilobaud Microcomputing, CQ, QST, Ham Radio, Personal Computing, Radio Electronics, Interface Age, and Byte. Order 1—BX1000—for \$2.00\*; order 2-7—BX2002—for \$1.50 each\*; order 8 or more—BX1002—for \$1.25 each\*.

Use the order card in the back of this magazine or itemize your order on a separate piece of paper and mail to: 73 Radio Bookshop • Peterborough NH 03458. Be sure to include check or detailed credit card information.

\*Add \$1.00 handling charge. Note: Prices subject to change on books not published by 73 Magazine.

FOR CUSTOMER SERVICE CALL (603) 924-7298

# 19 years of 73 magazine

**The world's most  
comprehensive  
guide to the subject  
of ham radio.**



The back issues of 73 are a gold mine of interesting articles. Unlike the other magazines, which fill their pages with activity reports, there's little to go stale in 73. You'll find pioneering articles on SSTV, FM, repeaters, ICs, and computers. Even the editorials are fun as Wayne Green's dire predictions, like the debacle of incentive licensing, have come to pass.

Clip the coupon below and send for 73's new back issue catalogue. Treat yourself (or a friendly ham) to some fun, and a fantastic bargain to boot.

YES! Rush me 73's FREE Back Issue Catalogue!

Name \_\_\_\_\_

Address \_\_\_\_\_

City \_\_\_\_\_

State \_\_\_\_\_ Zip \_\_\_\_\_

73 Magazine • Peterborough NH 03458 • USA

## NEW FROM 73



Tools and Techniques for Electronics (BK7348) is a comprehensive guide to the tools and construction practices used by today's electronics hobbyist. This new 73 Magazine publication should be a part of the library of anyone who has ever built or fixed any electronic gear. The text and numerous pictures and illustrations provide an easy-to-understand description of the safe and correct way to use the basic and specialized tools needed for electronics work.

The first part of Tools and Techniques for Electronics covers the basic tools that will assist the amateur Novice, CB operator, or beginning computer kit builder. It is also an excellent review for more experienced hobbyists. The second portion of the text will be of interest to the advanced tool user. It explains specialized metal working tools as well as the chemical aids that are used in repair shops. The final chapters of Tools and Techniques for Electronics discuss the construction skills that result in a professional-looking project.

Handy reference data on English/metric conversions, machine screw data, and the like will be found in the appendices. The contents of basic and advanced tool kits are outlined, and the book includes a list of suppliers.

Whether you are interested in working with tubes or the latest wire-wrap techniques, a great deal of pride and satisfaction can be gained by building or repairing your own equipment. 73's Tools and Techniques for Electronics shows you the way.

**Order your copy today! Only \$4.95 from the Radio Bookshop. Use the handy order form on the Reader Service Card at the back of the magazine or phone toll free 1-800-258-5473.**

## ALL NEW 1979 REPEATER ATLAS OF THE WORLD



The all new 1979 Repeater Atlas is now available as a result of the cooperation of hundreds of individuals, repeater groups, and coordinators. This is the largest atlas available anywhere. It includes 234 pages, 50 location maps, over 4,500 stations, and 9,000 entries, in a new, easy-to-use format indexed by location and frequency. Call Toll Free (800) 258-5473; have your credit card handy and order your 1979 Repeater Atlas (BK 7346) today. \$4.95

# 73 magazine

Peterborough NH 03458

# MOVING?

Let us know 8 weeks in advance so that you won't miss a single issue of 73 Magazine.

Attach old label where indicated and print new address in space provided. Also include your mailing label whenever you write concerning your subscription. It helps us serve you promptly. Write to:

# 73 magazine

Subscription Department  
P.O. Box 931  
Farmingdale NY 11737

- |   |   |
|---|---|
| <input type="checkbox"/> Address change only    | <input type="checkbox"/> Payment enclosed |
| <input type="checkbox"/> Extend subscription    | (1 extra BONUS issue)                     |
| <input type="checkbox"/> Enter new subscription | <input type="checkbox"/> Bill me later    |
| <input type="checkbox"/> 1 year \$18.00         |   |

If you have no label handy, print OLD address here.

Name \_\_\_\_\_ Call \_\_\_\_\_

Address \_\_\_\_\_

City \_\_\_\_\_ State \_\_\_\_\_ Zip \_\_\_\_\_

print NEW address here:

Name \_\_\_\_\_ Call \_\_\_\_\_

Address \_\_\_\_\_

City \_\_\_\_\_ State \_\_\_\_\_ Zip \_\_\_\_\_

89DBXX

# PROPAGATION

by  
J. H. Nelson

## EASTERN UNITED STATES TO:

	00	02	04	06	08	10	12	14	16	18	20	22
ALASKA	14	14	7	7	7	7	7	7	14	14A	21A	21
ARGENTINA	14	7A	7	7	7	7	14	21	21A	21A	21A	21
AUSTRALIA	21	14	7B	7B	7	7	7B	14	21	21	21	21A
CANAL ZONE	14	14	7	7	7	7	14	21	21A	21A	21A	21
ENGLAND	7	7	7	7	7	7B	14	21A	21A	21	14B	7
HAWAII	21	14	7B	7	7	7	7	7	14	21	21A	21A
INDIA	7	7	7B	7B	7B	7B	14	14A	14	7B	7B	7
JAPAN	14A	14	7B	7B	7	7	7	7B	7B	7B	7B	14
MEXICO	14	14	7	7	7	7	7	14	21A	21A	21A	21
PHILIPPINES	14A	14B	7B	7B	7B	7B	7	7	7B	7B	7B	14
PUERTO RICO	14	7	7	7	7	7	14	21	21A	21A	21	14
SOUTH AFRICA	14	7B	7	7	7B	14	21	21A	21A	21A	21	21
U. S. S. R.	7	7	7	7	7	7B	14	21A	14	7B	7B	7
WEST COAST	21	14	7	7	7	7	7	14	21A	21A	21A	21A

## CENTRAL UNITED STATES TO:

ALASKA	21	14	7	7	7	7	7	7	14	21	21	21A
ARGENTINA	21	14	7A	7	7	7	14	21	21	21A	21A	21A
AUSTRALIA	21A	14	14B	7B	7	7	7B	7B	14	21	21	21A
CANAL ZONE	21	14	7A	7	7	7	14	21	21A	21A	21A	21A
ENGLAND	7	7	7	7	7	7B	7B	14	21A	21	14B	7B
HAWAII	21A	14	14B	7	7	7	7	7	14	21	21A	21A
INDIA	7	7	7B	7B	7B	7B	7B	14	14	7B	7B	7B
JAPAN	21	14	7B	7B	7	7	7	7	7B	7B	7B	14A
MEXICO	14	14	7	7	7	7	7	14	21	21A	21A	21
PHILIPPINES	21	14	7B	7B	7B	7B	7	7	7	7B	7B	14
PUERTO RICO	14	14	7	7	7	7	14	21	21A	21A	21A	21
SOUTH AFRICA	14	7B	7	7	7B	7B	14	21	21A	21A	21	21
U. S. S. R.	7	7	7	7	7	7B	7A	14A	14	7B	7B	7B

## WESTERN UNITED STATES TO:

ALASKA	21	14	7	7	7	7	7	7	7	14	21	21A
ARGENTINA	21	14	14	7A	7	7	7B	14	21	21A	21A	21A
AUSTRALIA	21A	21	14A	7B	7	7	7B	7B	14	21	21	21A
CANAL ZONE	21	14	7A	7	7	7	14	21A	21A	21A	21A	21A
ENGLAND	7B	7	7	7	7	7B	7B	14B	21A	21	14B	7B
HAWAII	21A	21	14	7A	7	7	7	7	14	21	21A	21A
INDIA	14	14	14B	7B	7B	7B	7B	7	7	7B	7B	7B
JAPAN	21A	14A	14B	7B	7	7	7	7	7	7B	14	21A
MEXICO	21	14	7	7	7	7	7	14	21	21A	21A	21
PHILIPPINES	21A	21	14B	7B	7B	7B	7B	7	7	14B	14B	21
PUERTO RICO	21	14	7	7	7	7	7	14	21A	21A	21A	21
SOUTH AFRICA	21	14B	7	7	7B	7B	7B	14	21	21A	21	21
U. S. S. R.	7B	7	7	7	7	7B	7B	7B	14	7B	7B	7B
EAST COAST	21	14	7	7	7	7	7	14	21A	21A	21A	21A

- A = Next higher frequency may also be useful
- B = Difficult circuit this period
- F = Fair
- G = Good
- P = Poor
- SF = Chance of solar flares

## december

sun	mon	tue	wed	thu	fri	sat
						<b>1</b> F
<b>2</b> G	<b>3</b> G	<b>4</b> G	<b>5</b> G	<b>6</b> G	<b>7</b> G	<b>8</b> G
<b>9</b> F	<b>10</b> F	<b>11</b> G	<b>12</b> G/SF	<b>13</b> F/SF	<b>14</b> P/SF	<b>15</b> F
<b>16</b> G	<b>17</b> G	<b>18</b> F	<b>19</b> G	<b>20</b> G	<b>21</b> G	<b>22</b> G
<b>23</b> <b>30</b> G/G	<b>24</b> <b>31</b> G/G	<b>25</b> G	<b>26</b> G	<b>27</b> F/SF	<b>28</b> P/SF	<b>29</b> G

# READER SERVICE

A46	ABC Communications.....	156	D23	Dovetron.....	191	M8	MHZ Electronics.....	234, 235	U2	Unarco-Rohn.....	190
A1	Adirondack Radio Supply.....	190	D25	DSI Instruments.....	205-210	M69	Micro Control Specialties.....	215	U8	United Products.....	251
A24	Adva Electronics.....	250	*	Eagle Electronics.....	143	M55	Microlog Corp.....	29, 157, 201	V24	Vibroplex.....	69, 189, 199
A94	Advanced Electronics Appli- cations.....	65	E40	Electra.....	219	M92	J W Miller Div. Bell Industries		V29	VoCom Products Corp.....	145
A60	AED Electronics.....	141	F5	Flesher Corporation.....	57			171	W15	Wacom.....	175
A92	AHF Antennas.....	177	G27	Gemini Instrument Co.....	193	M72	M & M RF Distributors.....	151	W18	Western Electronics.....	145, 173
A107	AJT Enterprises.....	145	G12	Germantown Amateur Supply		M57	Monroe Electronics.....	147, 175	W2	Wilson Electronics.....	3
A2	Aldelco.....	252			194	N4	William M. Nye Co., Inc.....	86	W33	Wilson Systems, Inc.	
A40	Amateur Radio Supply of Nashville, Inc.....	159	G26	G & G Electronics.....	143	O5	OK Machine & Tool.....	103			121-125, 218
A21	Amateur-Wholesale Elec- tronics.....	232, 233	G22	G.I.S.M.O.....	175	O3	Optoelectronics, Inc.....	23	X3	Xitex Corp.....	120
A106	AMC Engineering.....	173, 175	G4	Godbout Electronics.....	242	*	Palomar Engineers.....	15	Y1	Yaesu Electronics Corp.	
A26	Amidon.....	173	*	Hal Communications.....	21, 48, 49	P41	P.C. Electronics.....	189, 217			CIII, 17, 77
*	Amsat.....	69	H24	Hal-Tronix.....	43	P44	Pickering Codemaster Co.....	194	From 73.....		34, 47, 195, 198, 253-258
A6	Apron Laboratories.....	177	H2	Ham Radio Center.....	31	P2	Poly Paks.....	245	From 80 Microcomputing.....		115
A105	AR Technical Products.....	194	H16	Hamtronics, NY.....	222, 236	Q3	Quest Electronics.....	231			
*	Associated Radio.....	244	H8	Hamtronics, PA.....	147	R1	Radio Amateur Callbook.....	190			
A100	Autek.....	249	H3	Henry Radio.....	CII, 97, 149	*	Radio World.....	161, 173			
B23	Barker-Williamson.....	145, 173	H44	HFT, Inc.....	193	R8	Ramsey Electronics.....	237, 247			
B8	Bullet Electronics.....	248	*	ICOM.....	79	R27	RF Power Labs, Inc.....	75			
*	Burstein-Applebee.....	143	I45	Info-Tech, Inc.....	147	S16	Selectronics.....	215			
C162	Castle Publishing.....	141	I32	Instant Software.....	116, 117	S63	Semiconductors Surplus				
C3	Clegg.....	87, 131, 219	I48	International Crystal Mfg. Co.....	221	S33	S-F Amateur Radio Services				
C21	Coakit.....	141	I27	IRL.....	53			65, 217			
C58	Communications Center, NE		J1	Jameco Electronics.....	243	S125	Sherwood Engineering Inc.....	215			
		91, 155	J2	Jan Crystals.....	147	S4	Slep Electronics Co.....	143, 193			
C115	Communications Electronics Specialties.....	57, 177, 191	*	Kantronics.....	177	S117	Spacecoast Research.....	114			
C6	Communications Specialists		*	Kenwood.....	CIV, 7-14	S81	Spectronics, Inc.....	240, 241			
		26, 27	K14	Key Electronics.....	141, 193	S8	Spectrum Communications				
C124	Cost Effective Computer Ser- vices.....	114, 193	*	Kb Microcomputing.....	99-102			36, 37			
C90	Curtis Electro Devices.....	222	K4	KLM Electronics.....	25	S43	Surplus Electronics.....	246			
*	Dade County Radio Club.....	90	L25	The Logic Store.....	114	S44	Swan Electronics.....	32, 33			
D6	Peter W. Dahl Company.....	194	L9	Long's Electronics.....	162-167	T64	Technical Clinic.....	143			
D29	Dielectric Communications.....	57	L17	Lunar Electronics.....	136	T52	Tele-Tow'r Mfg. Co.....	191			
*	Digital Research Computers.....	238	M48	Macrotronics.....	141	*	Ten-Tec, Inc.....	19, 203			
*	Digital Research Parts.....	239	M35	Madison Electronics Supply		T34	Thomas Communications.....	52, 98			
D68	Debco.....	221			43, 56, 59, 64, 83, 98, 189, 217	T18	Trac Electronics Corp.....	114, 221			
			M36	Maggiore Electronic Lab.....	193	T3	Tufts Radio Electronics				
			M100	Metz.....	137			57, 94, 95			
			M52	MFJ Enterprises		U10	UDM Enterprises.....	193			
					15, 47, 142, 215, 233	U9	Unadilla/Reyco Division.....	173			

\*Reader Service inquiries not honored.  
Please contact advertiser directly.

# BOOKS, ETC.

BK1016	73 DIPOLE & LONG WIRE ANTENNAS.....	\$ 5.50	BK7305	POWER SUPPLY HANDBOOK.....	\$ 7.95
ST0000	73 BACK ISSUE.....	\$ 3.00	BK1015	PRACTICAL ANTENNAS FOR THE RADIO AMATEUR.....	\$ 9.95
ST2500	73 BACK ISSUES - 25 OUR CHOICE.....	\$12.00	BK7302	PROPAGATION WIZARD'S HANDBOOK.....	\$ 6.95
ST0500	73 BACK ISSUES - 5 YOUR CHOICE.....	\$ 8.75	QW0250	QSL CARDS - STYLE W - 250.....	\$ 8.95
ST1000	73 BACK ISSUES - 10 YOUR CHOICE.....	\$14.00	QW0500	QSL CARDS - STYLE W - 500.....	\$13.95
ST2501	73 BACK ISSUES - 25 YOUR CHOICE.....	\$25.00	QX0250	QSL CARDS - STYLE X - 250.....	\$ 8.95
BK7307	BEHIND THE DIAL.....	\$ 4.95	QX0500	QSL CARDS - STYLE X - 500.....	\$13.95
BN1001	BINDER - 73 - 1.....	\$ 6.50	QY0250	QSL CARDS - STYLE Y - 250.....	\$ 8.95
BN1002	BINDER - 73 - 2 AND UP.....	\$ 6.00	QY0500	QSL CARDS - STYLE Y - 500.....	\$13.95
BK7309	CHALLENGE OF 160.....	\$ 4.95	BK7346	1979 WORLD REPEATER ATLAS.....	\$ 4.95
CT7305	CODE TAPE - 5 WPM.....	\$ 4.95	BK1044	RF DIGITAL TEST EQUIPMENT.....	\$ 5.95
CT7306	CODE TAPE - 6 + WPM.....	\$ 4.95	BK7347	RTTY HANDBOOK.....	\$ 5.95
CT7310	CODE TAPE - 10 + WPM.....	\$ 4.95	BX1000	SHELF BOX - 1.....	\$ 2.00
CT7313	CODE TAPE - 13 + WPM.....	\$ 4.95	BX1001	SHELF BOXES - 2.....	\$1.50 each
CT7320	CODE TAPE - 20 + WPM.....	\$ 4.95	BX1002	SHELF BOXES - 8 AND UP.....	\$1.25 each
CT7325	CODE TAPE - 25 + WPM.....	\$ 4.95	BK7351	SSB THE MISUNDERSTOOD MODE.....	\$ 5.50
CT7394	CODE TAPES (ANY FOUR ABOVE).....	\$15.95	BK7354	SSTV HANDBOOK (HARDCOVER).....	\$ 7.00
BK7308	THE CONTEST COOKBOOK.....	\$ 5.95	BK7355	SSTV HANDBOOK (SOFTCOVER).....	\$ 5.00
BK7321	GUIDE TO HAM RADIO.....	\$ 4.95	CT7350	SSTV TAPE.....	\$ 5.95
BK7304	GIANT BOOK OF AMATEUR RADIO ANTENNAS.....	\$12.95	SG1081	STUDY GUIDE - ADVANCED CLASS.....	\$ 5.95
BK7325	HOW TO BUILD A MICROCOMPUTER & REALLY UNDERSTAND IT.....	\$ 9.95	SG1080	STUDY GUIDE - EXTRA CLASS.....	\$ 5.95
BK1028	IC OP AMP COOKBOOK.....	\$12.95	SG7358	STUDY GUIDE - GENERAL CLASS.....	\$ 5.95
BK7380	INTRO TO RTTY.....	\$ 2.00	SG7357	STUDY GUIDE - NOVICE CLASS.....	\$ 4.95
CT7300	NOVICE THEORY TAPES.....	\$15.95	LB7359	TEST EQUIP LIB V1 - COMP TESTERS.....	\$ 4.95
BK7310	OWNER REPAIR OF AMATEUR RADIO EQUIPMENT.....	\$ 7.95	LB7360	TEST EQUIP LIB V2 - AUDIO TESTERS.....	\$ 4.95
			LB7361	TEST EQUIP LIB V3 - RADIO EQUIP.....	\$ 4.95
			LB7362	TEST EQUIP LIB V4 - IC TEST EQUIP.....	\$ 4.95
			BK7348	TOOLS & TECHNIQUES.....	\$ 4.95
			BK1069	VERTICAL BEAM & TRIANGLE ANTNS.....	\$ 5.50
			BK7368	VHF ANTENNA HANDBOOK.....	\$ 4.95
			BK7370	WEATHER SATELLITE HANDBOOK.....	\$ 4.95

# SOMETHING DIFFERENT

## The FT-107 Series with "DMS"\*

*"It's A Cut Above The Rest"*

\* **OPTIONAL DIGITAL MEMORY SHIFT ("DMS")**  
12 discrete memories. Stores individual frequencies or use as 12 full coverage VFOs (500 kHz each)

- Solid State
- 240 watts DC SSB/CW
- 160-10 meters, WWV  
(2 auxiliary band positions are available for future expansion)
- RF Speech Processor
- SSB, CW, AM, FSK
- Built-in SWR Meter
- Excellent Dynamic Range
- Audio Peak/Notch Filter
- Variable Bandwidth
- Full Line of Accessories



The FT-107 has been created as a result of a blending of technologies — computer, solid state and RF design. By careful utilization of these disciplines and the experience gained from our FT-301 series, YAESU has achieved an HF transceiver which offers unique features (e. g. "Digital Memory Shift"), efficient operation and a level of performance that has been previously unattainable.

### RECEIVER:

- Sensitivity:** 0.25  $\mu$ V for 10dB S/N, CW/SSB, FSK  
1.0  $\mu$ V for 10dB S/N, AM
- Image Rejection:** 60dB except 10 meters (50dB)
- IF Rejection:** 70dB
- Selectivity:** SSB 2.4 kHz at -6dB, 4.0 kHz at -60dB.  
CW 0.6 kHz at -6dB, 1.2 kHz at -60dB.  
AM 6 kHz at -6dB, 12 kHz at -60dB  
Variable IF Bandwidth
- 20dB RF Attenuator**
- Peak/Notch Audio Filter**
- Audio Output:** 3 watts (4-16 ohms)
- Accessories:** FV-107 VFO (standard not synthesized)  
FTV-107 VHF (UHF Transverter)  
FC-107 Antenna Tuner  
SP-107 Matching Speaker  
FP-107 AC Power Supply

### TRANSMITTER

- Power Input:** 240 watts DC SSB/CW  
80 watts DC AM/FSK
- Opposite Sideband Suppression:** Better than 50dB
- Spurious Radiation:** -50dB.
- Transmitter Bandwidth** 350-2700 hz (-6dB)
- Transmitter:** 3rd IMD -31dB neg feedback 6dB
- Transmitter Stability:** 30 hz after 10 min. warmup  
less than 100 hz after 30 min.
- Antenna Input Impedance:** 50 ohms
- Microphone Impedance:** 500 ohms
- Power Required:** 13.5V DC at 20 amps  
100/110/117/200/220/234V AC at 650 VA

**YAESU**  
**The radio.**



Price And Specifications Subject To  
Change Without Notice Or Obligation

# KENWOOD'S TR-2400

...synthesized, BIG LCD,  
10 memories,  
scanning...and more!

Kenwood TR-2400...It's a synthesized 2 meter hand-held transceiver...the answer to any Amateur's operating requirements! Its many advanced features include:



## CONVENIENT TOP CONTROLS

- **LCD digital readout**
  - Readable in direct sunlight (better than LEDs)
  - Readable in the dark (with lamp switch)
  - Virtually no current drain (much less than LEDs) and display stays on
  - Shows receive and transmit frequencies and memory channel
- **10 Memories** (always retained with battery backup)
- **Automatic memory scanning** (for "busy" or "open" channels)
- **Mode switch for the following operations:**
  - Simplex
  - Standard repeater by offsetting the transmit frequency + 600 kHz or - 600 kHz
  - Repeater with nonstandard splits by offsetting the transmit frequency to any frequency stored in memory 10
- **REVERSE** momentary switch for the following applications:
  - Checking signals on the input of a repeater
  - Determining if a repeater is "upside down"
- **Built-in Touch-Tone generator** using 16-button keyboard
- **Keyboard selection** of 5-kHz channels from 144.000 to 147.995 MHz
- **UP/DOWN manual scanning** and operation from 143.900 to 148.495 MHz in single or fast continuous 5-kHz steps. Even operates on MARS repeaters within this range by using memory 10 for transmit offset frequency.
- **LCD "arrow" indicators**
  - "ON AIR"
  - Memory recall
  - Battery status
  - Lamp switch on
- **Two lock switches** to prevent accidental frequency change and accidental transmission
- **Subtone switch** (subtone module not Kenwood-supplied)
- **BNC antenna connector**
- **1.5 watts RF output**

## The TR-2400 comes with the following standard accessories:

- Flexible rubberized antenna with BNC connector
- Nicad battery pack
- Battery charger

## Optional accessories include:

- Leather case
- Base Stand (for quick charge and easy base-station operation)
- DC (automobile) quick charger



ST-1 BASE STAND (OPTIONAL)



SEE YOUR AUTHORIZED  
KENWOOD DEALER FOR MORE  
INFORMATION ON THE TR-2400.



**KENWOOD**

...pacesetter in amateur radio

TRIO-KENWOOD COMMUNICATIONS INC.  
1111 WEST WALNUT/COMPTON, CA 90220