



73 Magazine

for Radio Amateurs

- 34 Power Line DXCC (Distant Control Circuit)**
—the ac lines are already there... why not use 'em for remote control?
..... W9CGI
- 42 Blueprint for Biofeedback Experimentation**
—fertile ground for pioneers
..... WD5BNL
- 44 The History of Ham Radio**
—part X..... W9CI
- 48 Maximum Security for the 22S**
—remote control puts your Icom in the trunk..... K8KW
- 50 The Big Blinker**
—a visual signal for the deaf... AD5X
- 52 Morse Converter for DMMs**
—super gadget for blind hams
..... WA6AXE/3
- 56 How to Home-Brew Your Own Crystal Filters**
—the series-string method..... Staff
- 60 Four Bands on a Bamboo Pole**
—try a Chinese vertical slanter on 10 through 40..... W0VM
- 64 The Triton IV Goes QRP**
—simply and efficiently..... W1FK
- 68 Experimenter's Corner: The MM5369N**
—how many uses can you find for this one-chip crystal oscillator?... Patten
- 72 Digital Readout Rotator Control**
—can the microcomputer connection be far behind?..... K8TMK
- 80  Build the KIM Keyer**
—with a 3-message memory
..... K0EI
- 96  No More TRS-80 Cassette Woes**
—E-Z Loader does the trick
..... WA9PUL, K9POX
- 100 The Incredible Shrinking Transceiver**
—build it on two tiny PC boards
..... K4DHC
- 106 In Quest of Perfect Break-In**
—well... almost perfect
..... WB7CMZ
- 116 The Amazing Audio Elixir**
—this limiting amp is a cure-all
..... N6WA
- 118 No More Rotary Switches**
—gadget freaks will love these solid-state replacements..... WA2FPT
- 122 Confessions of a Teenage HFer**
—the world between channel 40 and 28 MHz..... Peter
- 128 70-Watt Shoes for the IC-502**
—put some punch in that 6m signal
..... WA1PDY
- 136 The Big Bopper**
—a 5-band phased vertical array
..... W0VDJ



We're convinced...we've built the world's finest amplifier in its class!



HENRY RADIO'S 1KD-5

THE NEWEST MEMBER OF THE FAMOUS HENRY RADIO FAMILY OF FINE AMPLIFIERS

The 2KD-5 and 2K-4A linear amplifiers completely fulfill the needs of discriminating amateurs who want the very best and are willing to pay the price. But we have long felt that many amateurs would be satisfied with less power if they could still have the same high quality and dependability.

The 1KD-5 fulfills that need beautifully.

- Quality that is unmatched in any other linear in its class. The same high standards of engineering and construction as the 2KD-5 and 2K-4A. Heavy duty components guarantee years of trouble free, dependable performance.
- Smaller and lighter. Weighs about 27 pounds less... easier to take along on vacation trips and DXpeditions.
- Less expensive. If your budget is limited, but you still want a GOOD quality linear to kick your signal way up, with sharp, clear signals, the 1KD-5 will give you just about everything you want... and without sacrificing quality.

GENERAL INFORMATION

The 1KD-5 is a 1200 watt PEP input (700 watt PEP nominal output) RF linear amplifier, covering the 80, 40, 20 and 15 meter amateur bands. (10 meters on units shipped outside the U.S.)

Tube Complement: Eimac 3-500Z glass envelope triode operating in a grounded grid circuit.

ALC Circuit: ALC Circuit to prevent overdrive from high power exciters, also boosts average talk power.

Type of Emission: SSB, CW, RTTY or AM

Antenna Relay: DC relay system for hum-free operation, requires shorting contact to ground during transmit to key amplifier into transmit.

Power Output Indicator: Self-contained relative RF power meter.

Tank Circuit: Pi-L place circuit with a rotary silver plated tank coil for greatest efficiency and maximum attenuation of unwanted harmonics.

Input Circuits: Cathode Pi input matching circuits for maximum drive and linearity.
Power Supply: Conservative power supply with solid state rectifiers for reliable, long term operation.

Dimensions: 8.75" high x 14" wide x 15" deep.

Weight: 48 pounds.

Price \$695.00

2K-4A floor console linear amplifier... still the "workhorse" of Amateur Radio. Engineering, construction and features second to none. Provides a long life of reliable service while its heavy duty components allow it to loaf along at full legal power. **\$1195.00**

2KD-5 desk model linear amplifier... lighter, more compact and less expensive, but still a heavy duty, high quality linear that will operate at full legal power month after month for years to come. **\$945.00**

Tempo 2002 amplifier for 2-meter operation. 2000 watts PEP input on SSB or 1000 watts input on FM or CW. **\$795.00**

Tempo VHF/UHF solid state power amplifiers for use in most land mobile applications. Call or write for list of models available.

Tempo 100AL10 VHF linear amplifier. Power output of 100 watts (nom.) with only 10 watts (nom.) in. **\$209.00**

3K-A linear amplifier (for export and military use only) Superior quality, extremely reliable. At least three kilowatt PEP input on SSB... 2000 watt PEP output. **\$1595.00**

4K-ULTRA linear amplifier (for export and military use only) For the most demanding operation... SSB, CW, FSK or AM. For general coverage operation from 3.0 to 30 MHz, but can be modified for operation on frequencies up to 100 MHz. 100 watts drive delivers 4000 watts PEP input. **\$3450.00**

All of the above except the 2002, 3K-A & 4K-ULTRA are available at Tempo dealers throughout the U.S.

11240 W. Olympic Blvd., Los Angeles, Calif. 90064 213/477-6701
931 N. Euclid, Anaheim, Calif. 92801 714/772-9200
Butler, Missouri 64730 816/679-3127

Henry Radio

Prices subject to change without notice.

Wilson...

has your needs well in hand.

Today's Amateur demands rugged, rapid and accurate communications between Hams in the know. That's why they choose the Wilson Mark Series of hand-held radios. With exceptional qualities like these . . . why not choose the most popular radio available for yourself?

FEATURES

Advantages such as solid state circuitry, rugged Lexan® case, removable rear panel (enabling easy access to battery compartment) and compact mini-size enhance the Mark Series portable radio's versatility. In addition, Wilson carries a full line of accessories to satisfy almost any of your requirements.

SPECIFICATIONS

The Mark radios offer: • 144-148 MHz range • 6 Channel operation • Individual trimmers on TX and RX xtals • Rugged Lexan® outer case • Current drain: RX; 15 mA, TX; Mark II: 500 mA, Mark IV: 900 mA • A power saving Hi/Lo Switch • 12 KHz ceramic filter and 10.7 monolithic filter included • 10.7 MHz and 455 KHz IF • Spurious and harmonics, more than 50 dB below quieting • Uses special rechargeable Ni-Cad battery pack • LED battery condition indicator • Rubber duck and one pair Xtals 52/52 included • Weight: 19 oz. including batteries • Size: 6" x 1.770" x 2.440".

OPTIONS

Options available, include Touch Tone Pad, CTCSS, Leather Case, Chargers for Desk Top, Travel or Automobile, Speaker Mike and large capacity, small size batteries.

For more details and/or the name of your nearest dealer, contact: Consumer Products Division, Wilson Electronics Incorporated, 4288 So. Polaris Ave., P. O. Box 19000, Las Vegas, Nevada 89119. Phone 702/739-1931.



**Wilson Electronics
Incorporated**

A Subsidiary of REGENCY ELECTRONICS, INC.

✓ W33

**ACTUAL
SIZE!!!**

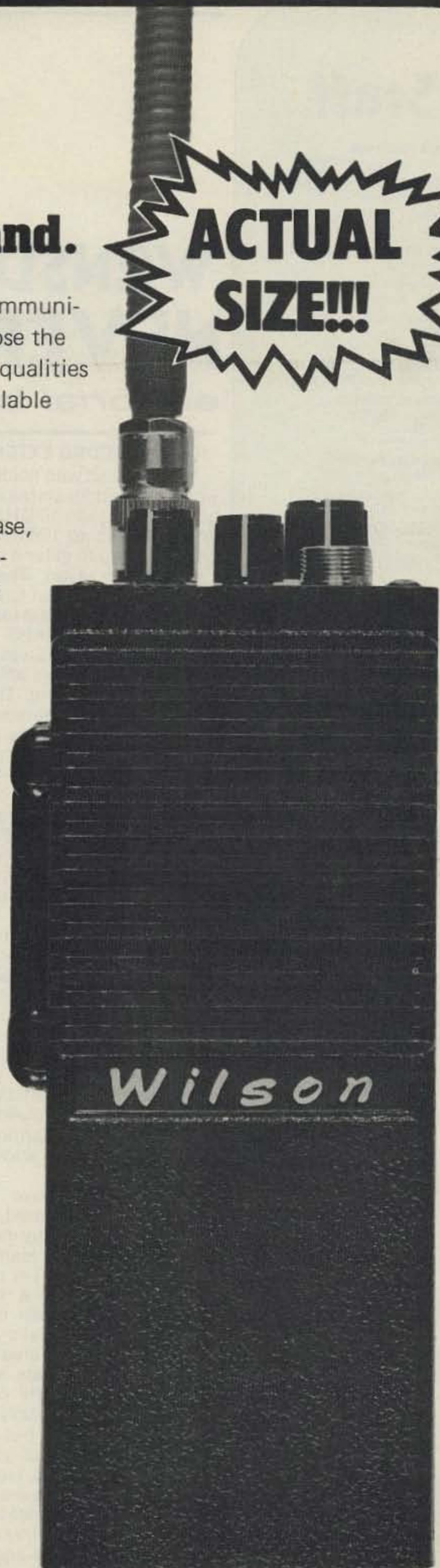

Prices and specifications subject to change without notice.

Staff

EDITOR/PUBLISHER
Wayne Green W2NSD/1

EXECUTIVE VICE PRESIDENT
Sherry Smythe

ASSISTANT PUBLISHER
Jeffrey D. DeTray WB8BTH

ADMINISTRATIVE ASSISTANT
Dotty Gibson

MANAGING EDITOR
John C. Burnett

ASSISTANT MANAGING EDITOR
Susan G. Philbrick

NEWS EDITOR
Gene Smarte WB6TOV/1

EDITORIAL ASSISTANTS
Elisabeth Blackmore
John Mitchell
Richard Phenix

BOOK PUBLICATIONS
Jim Perry

PRODUCTION MANAGER
Noel R. Self WB1ARP

ART DEPARTMENT
Cathleen Callahan
Bob Drew
James H. Gray II
Bruce Hedin
Chip Jackson
Dion Owens
Patrice Scribner
Robin M. Sloan
John W. White

PRINTING
Gary Steinbach, Mgr.
Robert Holden
Vinoy Laughner

PHOTOGRAPHY
Bill Heydolph
Tedd Cluff

TYPESETTING
Barbara J. Latti
David Dawe
Sandie Gunseth
Holly J. Walsh

BOOKKEEPER
Knud E. M. Keller KV4GG/1

CIRCULATION
Pauline Johnstone

DATA ENTRY
Cathy DeSilva
Margaret Sheldon

DIRECTOR OF MARKETING AND CIRCULATION
Robert R. LaPointe

ASSISTANT CIRCULATION MANAGER
Mary Beth Stanek

BULK SALES MANAGER
Judy Waterman

SHIPPING
Mark Dendy, Mgr.
Bill Barry

RECEPTIONIST
Beth Smith

ASSOCIATES
Robert Baker WB2GFE
E. H. Barnett WB0IIX
Schley Cox WB9LHO
Tom DiBiase WB8KZD
Terry Fox WB4JFI
W. Sanger Green
Dave Ingram K4TWJ
Larry Kahaner WB2NEL
Joe Kasser G3ZCZ
Bill Pasternak WA6ITF
John Schultz W4FA
Waller Scott K8DIZ
Peter Stark K2OAW
Chuck Stuart N5KC
Bill Turner WA0ABI

COMPUTER PROGRAMMING
Richard J. Dykema

CUSTOMER SERVICE
Florence Goldman

ADVERTISING
Aline Coutu, Mgr.
Bill York
Kevin Rushalko
Nancy Ciampa
Marcia Stone
Gaye Halberg
Lori Mugford
Rita Rivard

W2NSD/1 NEVER SAY DIE

editorial by Wayne Green



10-GHZ RECORD EXTENDED

Not satisfied with holding the world's record for states worked on the amateur 10-GHz band (five), the record holders have been working to extend it to six ... perhaps seven. The sixth was worked, I'm glad to report.

It all started out last fall when Chuck Martin WA1KPS got interested in the Microwave Engineering Gunnplexers and got a pair of them perking. The first contact from New Hampshire to eastern Massachusetts was relatively easy. Oh, it took us about fifteen minutes to find each other while tuning one unit and sweeping the general direction of the hill a bit over 50 miles away. Eventually, we lucked on to both the right frequency and bearing and the contact was solid.

Later, Chuck made an expedition to a mountain in southern Maine, also well over 50 miles away. Again it took a lot of tuning and turning of the two transceivers before the contact was made. Both have to be on the right channel and pointed very close to the right direction. No dishes were involved at this time—just the Gunnplexers, with their little waveguide antennas.

Chuck then drove to Mt. Ascutney in Vermont, again over 50 miles from my mountain in southern New Hampshire, Pack Monadnock. It is no accident that I have a drive-up mountain within four miles of the 73 offices ... that's what attracted me to this area when I moved here, 17 years ago. I've been a VHF and UHF nut right from the earliest days of my hamming, starting out on 2½ meters, for those of you who remember that band. I ran a pair of 76s with their bases slotted for "efficiency" and was the terror of Troy (NY). That was before WWII ... forty years ago!

Next we needed to work New Hampshire, so Chuck drove to the top of Mt. Washington and we made it ... but that one was

tough. We were both freezing in the cold winds, clouds were swirling around Washington, and the transceivers were not working well at all. In the light of later improvements, they had never been working more than marginally! But we did make it for an exchange of callsigns and signal reports ... whew! That was 106 miles, with faulty transceivers and no antennas to boost the signal.

It took two tries to get Rhode Island, and we had several frustrating failures with Connecticut. Just as Chuck had the transceivers working better and a two-foot dish ready to use, snow finally blanketed my mountain and that was that for the winter. When spring finally arrived, we tried to make it to Connecticut again, with Chuck even climbing trees to try and get the few extra feet of height needed. No go. Then we tried to make it through from the New York border ... again a failure. There was no strain when we tested the system out between the Pack and Mt. Greylock in western Massachusetts, but the path to New York was just not there.

Bigger problems call for sterner measures. The Pack is about 2,500 feet high and is usually excellent for VHF contests. It has the benefit of a toll road to the top ... the very top ... plus a fire lookout tower for a few added feet. About 12 miles away is Mt. Monadnock, a 3,500-foot lump whose top half is all rock. This mountain has a slight problem in that it is a 2½-mile hike to the top and the going is not easy. I'm almost 60 years old, my primary exercise is sitting at a typewriter all day, and I have no business climbing a 3,500-foot rock mountain. A few days of skiing during the winter helps a bit, but does in no way prepare one for hard mountain climbing.

Put into perspective, world records call for that extra effort, so I agreed to make the climb.

That was not one of my better decisions. Chuck rounded up his team of Steve K1KEC and Eric WA1HON and headed for the best possible location in Connecticut ... near Somers. I rounded up our summer tech, Tim Daniel N8RK, and Sherry and we headed for Mt. Monadnock.

The first half was easy ... a dirt road. The second half was a pain. There was no scaling of rock faces—it was just a grueling climb up rocks for over a mile. It seemed to go on forever. We'd see what looked like the top just above us maybe 500 feet, but when we got there we would see another peak beyond that. Sherry, who is used to mountain climbing being like walking up Stone Mountain in Atlanta, said that this was between ten and a hundred times as difficult. Tim? At 17 years old, he went up like a mountain goat.

When I finally arrived, panting and a bit worse for wear at the top, I was greeted by a couple hams and a three-element six-meter beam! They'd packed 40 pounds apiece up there for some DXing on six meters, only to find a maximum of six contacts to be made. It was Sunday afternoon, with very little activity on six meters. There were a couple dozen hikers, all looking disgustingly fresh and rested.

Tim and I set up the 10-GHz rig and aimed it in the direction of Connecticut, coordinating the effort on 220-MHz simplex and, on occasion, on two-meter simplex. This was the easiest of them all ... contact was made almost immediately. Chuck's group was using a two-foot dish on top of a fire tower and we had the plain Gunnplexer, but mounted on a tripod this time for stability. The signal strength pin went right over full scale and then off scale! The voice was just like the other team was right with us. We did get some interference from the six-meter team breaking through on our

TR-7600

TR-7625



RM-76



TS-700SP

Compact in size...
big on performance!

TR-7625

Featuring 25 watts RF output (switchable to 5 watts low power), the TR-7625 is a high-performance 2-meter FM transceiver with memory, and is designed to permit multi-channel (800-channel) operation. Compact and perfect for mobile or ham shack use. When used with optional RM-76 Microprocessor Control Unit, the TR-7625 offers a whole new dimension in channel memory and scanning capability.

TR-7600

Looks the same as the TR-7625, but offers 10 watts RF output (switchable to 1 watt low power). Also uses RM-76 Microprocessor Control Unit. For the Amateur Operator who's looking for optimum versatility in a 2-meter FM transceiver!

RM-76

Combined with either the TR-7600 or TR-7625, this optional Microprocessor Control Unit allows the operator to store frequencies in six memories (simplex/repeater); scan all memory channels; automatically scan up the band in 5-kHz steps; manually scan up or down in 5-kHz single or fast continuous steps; set lower and upper scan limits; clear scan (for transmitting); stop scan (with HOLD button); scan for busy or open channel; select repeater mode (simplex); transmit frequency offset (± 600 kHz or ± 1 MHz), or one memory transmit frequency. Operates on 143.95 MHz simplex (MARS) and is adaptable to all MARS frequencies. Display indicates frequency (even while scanning) and functions (such as autoscans, lower scan frequency limit, upper scan limit, and error, i.e., transmitting out of band).

TS-700SP

Here's an outstanding 2-meter all-mode transceiver that provides an extra dimension of versatility over the entire 2-meter band. Feature-packed and equipped for SSB, FM, CW and AM. Complete with built-in digital frequency readout, receiver preamplifier, VOX, sidetone, and microphone.

SPECIFICATIONS	Models TR-7600/TR-7625*	Model TS-700SP	Model TR-8300
Frequency Range:	144.00 to 147.995 MHz	144.0 to 148.0 MHz	TX: 445.0 to 450.0 MHz RX: 442.0 to 447.0 MHz
Mode:	FM	SSB (USB, LSB), CW, AM, FM	FM
Dimensions:	161mm (6-5/16") wide 61mm (2-3/8") high 230mm (9-1/16") deep	278mm (10-7/8") wide 124mm (4-7/8") high 320mm (12-5/8") deep	180mm (7-1/16") wide 60mm (2-3/8") high 240mm (9-7/16") deep
Weight:	1.75kg (3.85 lbs) Approx.	11.0kg (24.2 lbs)	2.3kg (5.1 lbs)
RF Output Power:	High: 10(25) watts (min.) Low: 1(5) watt approx. (adjustable to 10 watts)	SSB, FM, CW—10 watts AM—3 watts FM (Low)—Approx. 1 watt	High: 10 watts Low: 1 watt Approx.
Modulation:	Variable reactance direct shift	SSB: Balanced modulation FM: Variable reactance frequency shift AM: Low power modulation	Variable reactance phase shift
Microphone:	Dynamic microphone with PTT switch, 500 Ω	Low-impedance microphone (500 Ω)	Low-impedance microphone (500 Ω) with PTT switch
Sensitivity:	Less than 0.4 μ V for 20 dB quieting	Less than 0.4 μ V for 20 dB quieting SSB & CW: 0.25 μ V for 10 dB (S+N)/N AM: 1.0 μ V for 10 dB (S+N)/N	1 μ V for 30 dB (S+N)/N 0.5 μ V for 20 dB noise quieting
Squelch Sensitivity:	Less than 0.25 μ V	0.25 μ V	0.3 μ V
Selectivity:	More than 76 dB at 30 kHz of adjacent channel	SSB, CW & AM: 2.4 kHz/-6 dB, 4.8 kHz/-60 dB FM: 12 kHz/-6 dB, 24 kHz/-60 dB	20 kHz/-6 dB 40 kHz/-70 dB
Image Rejection:	More than 70 dB	Better than 70 dB	

ACCESSORIES— VFO-700 remote VFO; SP-70 external speaker; KPS-7 power supply; MC-50 base microphone; MC-30S mobile noise-cancelling microphone, and MC-45 Touch-Tone microphone.

See your Authorized Kenwood Dealer for more details.



TR-8300

Designed for use in the 70-cm amateur band. Unique design of the TR-8300 makes it a great choice for mobile or fixed-station use. This FM transceiver is capable of F3 emission on 23 crystal-controlled channels (three supplied). Transmitter output is 10 watts.



KENWOOD
...pacesetter in amateur radio

TRIO-KENWOOD COMMUNICATIONS INC.
1111 WEST WALNUT COMPTON, CA 90220

INFO.

Manuscripts

Contributions in the form of manuscripts with drawings and/or photographs are welcome and will be considered for possible publication. We can assume no responsibility for loss or damage to any material. Please enclose a stamped, self-addressed envelope with each submission. Payment for the use of any unsolicited material will be made upon acceptance. All contributions should be directed to the 73 editorial offices. "How to Write for 73" guidelines are available upon request.

Editorial Offices:

Pine Street
Peterborough NH 03458
Phone: 603-924-3873, 924-3874

Advertising Offices:

Eim Street
Peterborough NH 03458
Phone: 603-924-7138, 924-7139

Circulation Offices:

Phone: 603-924-7296

Subscription Rates

In the United States and Possessions:

One Year (12 issues) \$18.00
Two Years (24 issues) \$30.00
Three Years (36 issues) \$45.00
Lifetime subscription \$240.00

Elsewhere:

Canadian subscriptions—add \$2.00 per year unless paid with U.S. currency.

All other foreign—one year only—\$26.00 payable in U.S. currency through a U.S. bank (surface mail).

To subscribe, renew or change an address:

Write to 73 Magazine, Subscription Department, PO Box 931, Farmingdale NY 11737. For renewals and changes of address, include the address label from your most recent issue of 73. For gift subscriptions, include your name and address as well as those of gift recipients. Postmaster: Send change of address information to 73 Magazine, PO Box 931, Farmingdale NY 11737.

Subscription problem or question:

Write to 73 Magazine, Subscription Department, PO Box 931, Farmingdale NY 11737. Please include an address label.

73 Magazine (ISSN 0098-9010) is published monthly by 73, Inc., Peterborough NH 03458. Second class postage is paid at Peterborough NH 03458 and at additional mailing offices. Copyright (c) 1979 by 73, Inc. All rights reserved. No part of this publication may be reprinted or otherwise reproduced without written permission from the publisher. Microfilm Edition—University Microfilm, Ann Arbor MI 48106.

link. RFI, even on top of Monadnock!

The climb down was not much easier than going up. It didn't take as much grunting and straining up through the rough places, but it took a lot of care and knee-shaking jumps to rocks. I was lame for several days afterward with knee-cap shock. The thought that Chuck and his group might want to do this all over again for another try for the New York-New Hampshire path went through my mind with each and every rock that I climbed down... all one damned mile and a quarter of them.

Fortunately, the day was reasonably cool... perhaps around 80°... and beautifully sunny. Visibility was only about 30 miles in the haze, but then it was a natural haze caused by the trees and not smog. There is never anything but clean air in New Hampshire.

The team down in Connecticut didn't have to cope with climbing a rock mountain, but they did have their problems. Being considerably south of us, they had much hotter weather and suffered greatly from sunstroke and heat prostration. Steve became completely prostrated in the back of their van when the time came to disassemble their setup and carry it down the tower. Oh, the agonies we have to go through to become world champs.

BITING THE LIFERS

A recent letter from Chapman (ex-New England director) to ARRL life members on ARRL Foundation letterhead asked for donations to set up a \$100,000 slush fund for HQ to spend at Geneva this year.

For some reason, nothing was mentioned of the \$100,000 fund which has already been set up for just this type of use. I'm reminded of the League saving money for years to buy a new headquarters building... money taken from the members as dues... and then, when they finally had enough money, running a building fund and collecting the same money a second time. And to cap that, they sold their old building for almost the cost of the new building. That's mainly how they built up that \$2 million-plus they have in securities and banks.

It seems to me that this begging for more money calls for some whistle-blowing. They seem to be trying to make up for the recent bad management of the League by asking for donations in the name of WARC.

The \$100,000 is still carried on the balance sheet of the League in their latest annual report... it is for "the defense of amateur frequencies." That would seem to cover WARC like

a glove. The fund was set up years ago and has been used for undisclosed purposes and then refunded by the League at the end of each year. It would seem that members of the League are entitled to a detailed accounting of the money spent from this fund down through the years. Any publicly held corporation would have to account to the shareholders for such a mysterious fund... particularly when there is a serious question about it being used for the personal benefit of League officials. IRS, please note.

I think I join many members in hoping that the League will be more prudent at Geneva this year. At the last WARC, they had a huge suite in one of the most expensive hotels in town and entertained lavishly. Throwing money around like that is the Ugly American way and we need friends, not resentful enemies.

To sum it up... the ARRL Foundation is in disgrace over the resignation of most of its directors... a fact which HQ has refused to discuss or even let members know about. They already have \$100,000 in cash set aside for just such an event as WARC, so the begging for \$100,000 more stinks. If you have money to pour down rat holes, I'm sure you can find better charities than this one.

ARRL PROBLEMS

I see that the ARRL's Central Division convention was a monumental flop... eight exhibitors and about 400 in attendance. The magic seems to have gone out of ARRL conventions, and the active hams are staying away in record numbers. Compare this to the Atlanta Hamfest, where, in spite of the severe gasoline shortages, the attendance was only down a bit from last year and the exhibit hall was packed solid with exhibits and people. Compare it with the St. Louis hamfest, where a first-time show filled the exhibit hall and packed the hall with attendees.

What were the differences? One was a matter of promotion, where Atlanta and St. Louis got extensive promotion in both 73 and MICROCOMPUTING magazines... ads and editorial. Another difference was the speaker program, where one had no one of a controversial nature... not even of any significance... and the others had speakers who packed 'em in. I suspect that the day is past when you can pull in a good crowd at a hamfest just by listing it in QST.

OUTLAW RADIOS

A recent attempt to amend a New Jersey law which prohibits the use of radios in cars

capable of receiving police channels so that it would exempt amateurs was vetoed by Governor Byrne. Someone should make it a point to acquaint the governor with the facts of radio life and the ridiculousness of the whole charade.

Maybe a few years ago something like this could be legislated, but with the modern scanners there is no way to keep anyone who wants to from receiving police channels. Like guns, the laws only have an effect on the honest person. Criminals carry guns and are quite capable of buying and using radios which will receive police channels... and how can a policeman know? With just about every other car sporting some sort of special antenna, a car can be set up for CB, for hamming, for any of a hundred special services... or to illegally receive police channels.

If the police are looking for just one more rap to lay on a criminal once he has been caught, the ramifications for hams and other honest users of radios are much too great a penalty to pay. Virtually every mobile ham rig for VHF is quite capable of being tuned to a police channel. The scanners, which are being sold by the tens of thousands, can get just about every police channel there is, high- or lowband... and they are 12-volt jobs, just fine for mobile use.

Will someone please bring Governor Byrne up out of the 1950s? And perhaps someone should alert the New Jersey legislature that making it illegal to have radios capable of receiving police channels in cars is not going to have any effect on criminals... it will only harass non-criminals.

SPREADING THE WORD

One of the jobs that I feel a national amateur radio organization should do is lobby for us on a national level. This means organizing campaigns which will get amateur radio favorably into the media... articles in national magazines... demonstrations which are covered by television... promotion of ham activities during emergencies, etc. In case there is any doubt, we are not getting such a service from any of our national amateur radio organizations.

Individual clubs, in a few instances, have been doing a fine job of getting publicity, but unless you are terribly isolated from the general public, you must be aware that most people have no idea of the difference between CB and ham radio. We do need PR and we need it badly

Continued on page 148



COAKIT

P.O. Box 101-A, Dumont, N.J. 07628
RF ASSORTMENT
NUMBER ONE

CONNECTOR ASSORTMENT

\$25.00 **\$23.50** each

Postpaid lots of three

Includes: 5- PL259, 5- SO239, 5- UG175, 5- UG176, 2- PL258, 1- DM, 1- M358, 2- M359, 1- UG255, 1- UG273, 2- PL259PO, 1- 1021-20, 1- Lightning Arrestor.

Master Charge & Visa accepted / Send for Free Catalog

COAKIT ✓ C21

P.O. Box 101-A Dumont, N. J. 07628

Circle C21 on Reader Service Card

NEW ELECTRONIC PARTS

Brand name, first line components. Stocked in depth. 24 hour delivery. Low prices and money back guarantee on all products we carry.

STAMP BRINGS CATALOG

SPECIALS

KEYBOARD ENCLOSURES

SIX SIZES	W	D	H	PRICE
	14"	8.3"	3"	\$15.20
	17"	8.3"	3"	18.35
	20"	8.3"	3"	19.25
	14"	11.3"	3"	16.50
	17"	11.3"	3"	18.80
	20"	11.3"	3"	20.75



Blue base, specify white or black top.

MAGNA-LITE JR

ONLY
\$5.79



IDEAL FOR:

- Printed Microcircuit reading
- Electronics — Design, Production & Inspection
- Industrial — Engineers, Technicians, Draftsmen
- Laboratory & Research

RTTY

UT4 SPEED CVTR BOARD
KIT \$109.95
BOARD ALONE \$18.95
AUTO CW ID KIT \$37.90



SHIPPING
INCLUDED
IN PRICE

Daytapro Electronics, Inc.

Formerly NuData Electronics — ✓ D35

3029 N. WILSHIRE LN., ARLINGTON HTS. ILL. 60004
PHONE 312-870 0555

Key Electronics

**AUTOMATIC DIALING
TOUCH TONE
MICROPHONE**

CES Model 235

- Stores 5 eleven digit and 5 seven digit phone numbers
- Programs and operates entirely from keyboard
- Programmable dialing rate
- Stores last manually dialed number
- Built-in speaker for tone monitor
- Programmable 2 second pause
- Automatic PTT 5 second before first tone



69⁹⁵

INTEGRATED CIRCUITS:

SN76477N	Complex sound generator	\$2.95
TL489C	Analog level detector	\$1.25
LM317T	Adj. volt. reg. 1.5 amp.	\$2.75
ICM7555	Low pwr. CMOS Timer	\$1.25
LF351N	High speed JFET Op Amp	.75
NE565	PLL	\$1.10

FREE: CA3140 with orders of \$5.00 or more.

Please include \$1.00 for postage and handling

N.Y.S. Residents Add 4% Sales Tax

Send to: **Key Electronics**
P.O. Box 3506

Schenectady, NY 12303 ✓ K14

**FOR BEST PRICE AND
FAST DELIVERY
CALL
1-800-325-3636**

TOLL FREE



HAM RADIO CENTER *arma*

8340-42 Olive Blvd. P.O. Box 28271 St. Louis, MO 63132

✓ H2



Radio equipment
not included

Floor Space: 39" Wide 30" Deep

4384 KEystone AVENUE • CULVER CITY, CALIF. 90230 — PHONE (213) 837-4870

... at last ...

your shack organized!

A beautiful piece of furniture — your XYL will love it!

\$149.95 S-F RADIO DESK

Deluxe - Ready to Assemble

Designed with angled rear shelf for your viewing comfort and ease of operation.

FINISHES: Walnut or Teak Stain.

Also available in Unfinished Birch, \$134.95

Additional Information on Request.

Checks, Money Orders, BankAmericard
and Master Charge Accepted.

F.O.B. Culver City. (In Calif. Add 6% Sales Tax.)

S-F AMATEUR RADIO SERVICES

✓ S33

SCANNERS:

KDK 2015R, KDK 2016A

MIDLAND 13-510, 13-513, CLEGG FM-28

YAESU FT227R, ICOM IC22S, KENWOOD TR7400A

- AED continues to expand its line of quality scanners. All of the above scanners are custom designed for their respective rigs.
- All scanners install completely inside the rig. No obtrusive external connections.
- All are easy to assemble and come complete with a detailed instruction manual.
- Scanned frequency displayed on digital readout (except IC22S).
- In the scanner OFF mode the rig operates normally. In the scanner ON mode the scanner locks on an occupied frequency, pauses for a preset time (about 5 secs.) and then resumes scanning.
- This gives you the ability to eavesdrop all over the band without lifting a finger. When you hear something interesting, you flip the switch to the LOCK mode and the rig is ready to transmit.

AED SCANNER SPECIFICATIONS

	KDK 2015R	KDK 2016A	KENWOOD TR7400A	YAESU FT227R	MIDLAND 13-510 13-513	CLEGG FM-28	ICOM IC22S
SCAN RATE	Adjustable 100kHz/sec-1MHz/sec		50kHz/sec	200kHz/sec	100kHz/sec	100kHz/sec	100kHz/sec
SWEEP WIDTH	144-148	142-149.995	complete band or mHz you want	adjustable eg. 146-148 144-146 146-147	scans the mHz seg. selected by the mHz switch	same as Midland	145.35-147.99
SCAN CONTROLS	2 mini toggle switches mounted on rig — LOCK switch may be mounted on mic.		2 mini toggle switches mounted on rig.	1 mini toggle switch mounted on mic or rig.	2 mini toggle switches mounted on rig.	same as Midland	1 mini toggle switch mounted on mic or rig.
PRICE FOR KIT	\$39.95		\$39.95	\$34.95	\$39.95	\$39.95	\$34.95
PRICE PRE-ASSEMBLED	\$59.95		\$59.95	\$54.95	\$59.95	\$59.95	\$54.95

DEALER INQUIRIES
INVITED

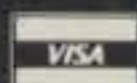

**AED
ELECTRONICS**

750 LUCERNE RD., SUITE 120
MONTREAL, QUEBEC, CANADA H3R 2H6
TEL. 514-737-7293

Add \$1.50 for postage & handling



✓ A60

A Knob with a new twist "VRS™"

Swan Astro 150 Exclusive Microprocessor Control w/memory gives you over 100,000 fully synthesized frequencies, and more!

- VRS — Variable Rate Scanning, a dramatic new technique for unprecedented tuning ease and accuracy
- POWER — 235 watts PEP and CW on all bands for that DX punch
- Advanced microcomputer technology developed and manufactured in the U.S.A.
- Price? See your authorized SWAN dealer for a pleasant surprise!



Dual Meter
Reads PEP output in watts and receive "S" units.

Full Break-in CW
(or semi, switch selected)

Wide Frequency Coverage

- 10M — 28.0-30.0 MHz
 - 15M — 20.8-23.0 MHz
 - 20M — 13.8-16.0 MHz
 - 40M — 6.0-8.3 MHz
 - 80M — 3.0-4.5 MHz
 - 160M — 1.8-2.4 MHz*
- *in lieu of 10M band on Model Astro 151

Mike Tuning
For accurate 100 Hz steps or fixed rate scan.

PSU-5 Power Supply with Speaker



ASTRO 150 Transceiver

ST-3 Antenna Tuner

THE MOST ADVANCED HF SSB TRANSCEIVER AVAILABLE.

FULLY SOLID-STATE **SWAN ASTRO 150**



SWAN
ELECTRONICS

A member of the Cubic Corporation family of companies

305 Airport Road / Oceanside, CA 92054 / 714-757-7525

Discover the unrivaled ASTRO 102BX with Dual PTO's

Plus IF Passband Tuning/Full Band Coverage, Speech Processing, 235 Watts PEP All Bands and Much More.

4-Function Meter
reads "S" units in receive, and selects forward power, reflected power, or ALC in transmit.

Visual Display of Passband Tuning
A series of 8 LED's indicate the equivalent band width and position of the passband from 0.6 to 2.7 KHz as the passband tuning knob is rotated.

300Hz Crystal CW Filter
Cascaded with the passband filters and tunable through the passband. Combined with notch filter yields unrivaled CW performance.

Full or Semi CW Break-in
A must for the avid CW operator!

2 Position CW Wave Shaping
Your choice of soft or hard CW rise and decay time!



Variable AGC Decay
Continuously variable to suit your preference.

Passband Tuning with 16 Pole Filters
Two 8-pole crystal filters in cascade provides a 1.4:1 shape factor at -100dB! The ultimate in selectivity.

Tunable Notch Filter
Provides the ability to "notch out" QRM. When used in conjunction with the passband tuning, provides the ultimate in removing interference.

Dual PTO's
Two independent high stability PTO's provide true split band operation. The digital counter reads the PTO selected, or in split band reads the PTO used for receive, then switches to the transmit frequency selected when the mic is keyed.

All Band Coverage using PLL and Synthesizer for Band Selection
Full coverage of 160 meters through all of 10 meters in 9 ranges . . . diode matrix programmed for now — or for the future!



The ASTRO 102BX with it's companion PSU-6 Power Supply, 1500Z Linear Amplifier and ST-2A Antenna Tuner provides a matched and highly efficient 1500 watt PEP or 1000 watt CW complete station to be complemented by a great Swan antenna.

All Solid State Quality American Construction

ASTRO 102BX

SWAN
ELECTRONICS

A member of the Cubic Corporation family of companies

305 Airport Road / Oceanside, CA 92054 / 714-757-7525

Looking West

Bill Pasternak WA6ITF
24854-C Newhall Ave.
Newhall CA 91321

The last time I went on a Field Day outing was in the early sixties. I was a member of an organization known as the Flatbush Radio Club of Brooklyn, New York, and we took to the hinterlands of New York City. The place was Prospect Park, which sits in the center of Brooklyn. OK... so it wasn't really the hinterlands. It was fun, but through the years the memories of that outing grew faint.

Since moving to California, the closest I have come to taking part in a Field Day outing was the time I went from club to club showing the PARC Field Day film, *Field Day 1972*. In the seven and one-half years I have been here, something has always come up to make me miss Field Day. One year I was out of town, another time I had to work... you know the story. Well, this year it all clicked. The San Fernando Valley Amateur Radio Club was holding its Field Day operation on a hill not twenty minutes from my house. I had film in my Polaroid in addition to 600 feet of Super 8 film. Most important, I had the time and the opportunity to attend. The lure was overwhelming...

If you have never experienced a real Field Day operation, you've missed something important. This is true gut-level amateur radio operation at its

best. It's you the amateur versus the bands, the elements, and the odds. To me, the whole idea of Field Day is not whether I win or lose, but rather the camaraderie that is shown among amateurs during such an event. The San Fernando Valley Amateur Radio Club is an excellent example of such fellowship.

Let me tell you a bit about the SFVARC. It is a true amateur radio club with members whose interests go in many diverse directions. Unlike most clubs of this era, the SFVARC does not own or operate a repeater, nor does it ever plan to. In fact, a few years back I offered them such a device and it was rejected. It is not that SFVARC members don't like repeaters — far from it. Most of the members can be found operating the myriad of two-meter and 220-MHz systems that abound in this locality. However, to the SFVARC, a repeater is nothing but a way of extending the communications range; with over 300 operational 2-meter repeaters in southern California, there is no need for yet another. So, while most members do operate VHF or 2-meter FM, they do so using the existing relay facilities.

Rather than worry about running a repeater, the SFVARC looks in other directions. It does such things as provide communications for March of Dimes walk-a-thons and work with

"Santa" at Christmas to help bring joy to children in hospitals. The best way to describe the SFVARC is to say that they epitomize the concept of an amateur radio club in the truest and broadest sense. Perhaps that is why Field Day with SFVARC was so much fun. There were about a dozen dedicated people from the club spending almost thirty-six hours on a remote California hilltop enjoying each other's company and their amateur radio hobby. They were fulfilling a dream that could only be fulfilled once a year. Being together enjoying the experience was the point of their hilltop excursion. I could only spend Sunday with them, but it was well worth it. My memories of the past were rekindled and somehow I felt more like a "real ham."

A NEW MOVIE

Hollywood, which has brought you such epics as *The Poseidon Adventure*, *Two For the Seesaw*, *Charlie*, and other great moments in cinema, is now proud to announce another achievement. *The World of Amateur Radio* was produced by a man I consider to be a true cinema artist, Dave Bell W6AQ. I am writing this only an hour after leaving Dave's Hollywood studio. We just screened the first answer print of this new film and the consensus is that it is a superior work. With Dave Bell as the film's producer, the results were not surprising. In my opinion, he is a genius in his chosen profession. He knows his business, knows how to get a job done properly the first time out, and has the ability to lead others in the proper direction. Being able to work with someone like Dave has been a

real honor and a truly rewarding experience.

The World of Amateur Radio is fast-paced, relevant, and covers most aspects of our amateur radio world. NBC-TV News correspondent Roy Neal K6DUE is the film's host and chief narrator. There are contributions from Senator Barry Goldwater K7UGA, Arthur Godfrey K4LIB, and Stu Gilliam WD6FBU, and special appearances by Dick Van Dyke and His Majesty King Hussein of Jordan JY1. The film was produced by Dave Bell Associates for the American Radio Relay League and it will soon be available from the ARRL. I am happy to say that this is one time when the League is truly serving the amateur community; it should be applauded for its fine work on our behalf. Through the cinematic expertise of Dave Bell, the ARRL is providing us with the type of visual vehicle we need in order to explain what amateur radio is all about. As this is written, the film print is en route to Geneva, Switzerland, to be presented to those who will be deciding our future — the delegates to the World Administrative Radio Conference.

The World of Amateur Radio is our world, and now, thanks to Dave Bell and the ARRL, we will be able to share it with virtually everyone. All who worked on the project sincerely hope that you will enjoy the film. I have one request: At present, only one print of the film exists, and that print is in Geneva. It will be a few weeks before distribution prints are available. Please do *not* contact Dave Bell Associates or the ARRL requesting the film. Instead, keep watching for ARRL official bulletins, *HR Report*, the Westlink Amateur Radio News, and this column. All these sources will let you know the moment the film is ready for release. While we wait, readers of this column may want to start recruiting non-amateur groups for introductory talks about amateur radio, using the film as the focal point of the meetings. While we amateurs will enjoy viewing it, it's far more important that the film be seen by the non-amateur general public. It is time for the rest of the world to discover us and our service capabilities. Therefore, it is extremely important that the film reach as wide an audience as possible. Public schools, public television, civic groups, and church groups can all be approached. This is where you come in. The film will do no good sitting on a shelf. To be effective, it must be seen. Any takers?

Ever wonder how a film is produced? Here's the secret... teamwork! (Photo by Bill Orenstein KH6IAF.)



Continued on page 153

New OMNI/SERIES B Filters The Crowd

The new OMNI/SERIES B makes today's bands seem less crowded. By offering a new i-f selection that provides up to 16 poles of filtering for superior selectivity. And a new Notch Filter to remove QRM. No other amateur transceiver we know of out-performs it.

NEW I-F RESPONSE SELECTION. OMNI comes equipped with an excellent 8-pole 2.4 kHz crystal ladder i-f filter which is highly satisfactory in normal conditions. But when the going gets rough, the new OMNI/SERIES B, with optional filters installed, provides two additional special purpose i-f responses.

The 1.8 kHz crystal ladder filter transforms an unreadable SSB signal in heavy QRM into one that gets the message through. The 0.5 kHz 8-pole filter provides extremely steep and deep skirts to the CW passband window which effectively blocks out even the very strong adjacent signals.

Both of these filters can be front-panel switched in series with the standard filter to provide up to 16 poles of filtering for near-ultimate selectivity. In addition, the standard CW active audio filters have three bandwidths (450, 300, and 150 Hz) to give even further attenuation to adjacent signals. In effect, OMNI/SERIES B has six selectivity curves—three for SSB and three for CW. That's true state-of-the-art selectivity.

NEW NOTCH FILTER. A variable frequency notch filter in OMNI/SERIES B is placed inside the AGC loop to eliminate interfering carriers and CW signals without affecting received signals. Attenuation is more than 8 "S" units (over 50 db) for any frequency between 0.2 kHz and 3.5 kHz.

OMNI/SERIES B RETAINS ALL THE FEATURES THAT MADE IT FAMOUS.

All solid-state; 160-10 meters plus convertible 10 MHz and AUX band positions; **Broadband design** for band changing without tuneup, without danger;

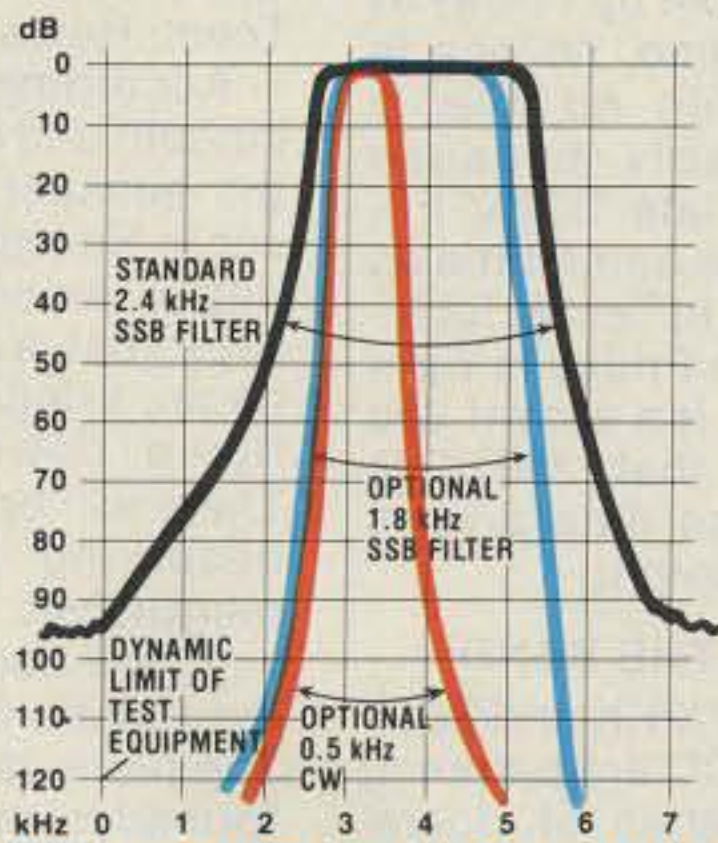

OMNI/SERIES B I-F RESPONSES WITH STANDARD AND OPTIONAL FILTERS.

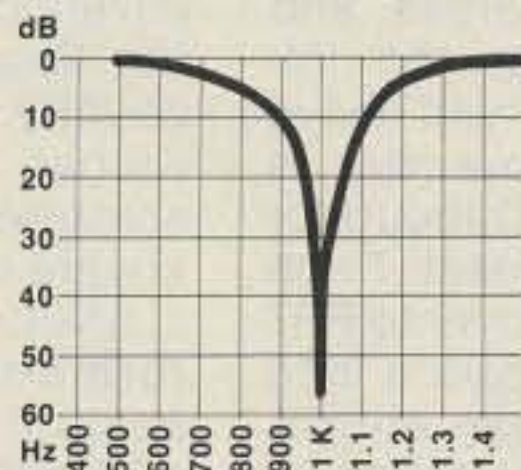

NOTCH FILTER PERFORMANCE ADJUSTED TO 1 kHz POINT.

TEN-TEC, INC.
SEVIERVILLE, TENNESSEE 37862
EXPORT: 5715 LINCOLN AVE., CHICAGO, ILL. 60646

Choice of readouts — OMNI-A for analog dial or OMNI-D for digital dial; **Built-in VOX and PTT** facilities; **Selectable Break-in**, instant or delayed receiver muting; **Dual-Range Receiver Offset Tuning**, ± 5 kHz or ± 0.5 kHz; **Wide Overload Capabilities**, dynamic range typically exceeds 90 dB and a PIN diode switched 18 dB attenuator is also included; **Phone Patch Interface Jacks**; **Adjustable ALC**; **Adjustable Sidetone**; **Exceptional Sensitivity**; **200 Watts** input to final with full warranty on final transistors for first year, pro-rata for 5 years; **100% Duty Cycle** for RTTY, SSTV or sustained hard usage; **12 VDC Circuitry** for mobile use, external supplies for 117/220 VAC operation; **Front Panel Microphone and Key Jacks**; **Built-in 25 kHz Calibrator** in analog dial model; **Zero-Beat Switch**; **"S"/SWR Meter**; **Dual Speakers**; **Plug-In Circuit Boards**; **Functional Styling**, black textured vinyl over aluminum "clamshell" case, complementary non-reflective warm dark metal front panel; **Complete Shielding**; **Easier-to-use size**: 5 $\frac{3}{4}$ "h x 14 $\frac{1}{4}$ "w x 14"d; **Full Options**: Model 645 Keyer \$85; Model 243 Remote VFO \$139; Model 252MO matching AC power supply \$139; Model 248 Noise Blanker \$49; Model 217 500 Hz 8-pole Crystal Ladder CW Filter \$55; Model 218 1.8 kHz 8-pole Crystal Ladder SSB Filter \$55;

OMNI owners note: Your OMNI can be converted to a SERIES B model at the factory for just \$50 (plus \$5 for packing and shipping). The notch filter replaces your present squelch control and provision is made for the two additional optional filters; a partial panel with new nomenclature is provided. Contact us for details.

Model 545 Series B OMNI-A \$949
Model 546 Series B OMNI-D \$1119

Experience the uncrowded world of OMNI/SERIES B. See your TEN-TEC dealer or write for full details.



Chuck Stuart N5KC
5115 Menefee Drive
Dallas TX 75227

ARRL INTRUDER WATCH

Our recent comments concerning the "woodpecker" and other unauthorized encroachments into the amateur bands seem to have unintentionally opened a Pandora's Box of complaints directed at the ARRL-sponsored "Intruder Watch" program. Now, before you groan and say, "Won't those guys at 73 Magazine ever get tired of blasting the ARRL?", let me assure you that Dallas is a long way from Peterborough and that the editor of this column has been a League member for over twenty years and has no axe to grind with the ARRL. The purpose is to simply find out what is going on in the Intruder Watch program and to determine if it is doing the job it was created to do.

If you have had any recent experience with the Intruder Watch program, either good or bad, let us know. Since negative opinions are most often voiced, we are especially interested in receiving reports of positive results as a direct result of this program. To keep everything aboveboard, letters postmarked Newington or Peterborough will not count.

If you're wondering what all this has to do with DX, try working some on 40 meter SSB.

NOVICE CORNER

Now that you have switched to UTC time for logging DX contacts and making out QSLs (you have switched, haven't you?), it is important to remember to always advance the date at 2400 UTC. QSL managers report that the most common mistake made in filling out QSL cards is neglecting to advance the date at the proper time.

That same error can easily cause you to miss a sked of a DX net. Suppose you read in this column that a station you need has a schedule with his QSL manager at 0000Z on Fridays, but when you show up Friday at the scheduled time, no one is there. The reason no one is there is probably because you're 24 hours late. 0000Z Friday is exactly the same time as 2400Z Thursday. In Texas, for instance, 0000Z on Friday is 7 pm Thursday CDST. It's easy if you just remember that 2400Z is midnight and the date always advances at midnight.

HEARD ON THE BAND

Dave Schoen N2KK and Scotty Meadows K5CO are planning an extensive series of operations later this year in the Indian Ocean and African areas. The plan is to operate independently from some areas and then join forces for the important ones. Dave will leave the States in mid-November in time to set up in J28 Djibouti for the CQ WW CW Contest. From Djibouti he will head over to FR7 Reunion Island to begin a long series of Indian Ocean efforts. Initial plans call for stops at 3B8, 3B7, and 3B9. He is also looking at possible FH8, D68, FR7/G, and FR7/J operations, as well as some of the more rare East African countries. Dave is a professional photographer and his assignment will be to photograph the area for tourism promotion. Scotty, who has operated from TT8, 5A, 7P8, and 9H1, will join up with Dave after their plans have firmed up. Early hopes are for better than 100,000 QSOs total for the operation. We should have more news on this one next month along with the suggested QSL routes.

Reports continue to surface on some really big gun efforts

later this fall aimed at one or more of the following areas: 7O1 Yemen, VS9K Kamaran, 8Z4 Neutral Zone, or SY1 Mt. Athos. Mt. Athos and the Neutral Zone seem to be the betting favorites.

KH6LW showed as expected from Kure Island with a good signal to stateside. QSL to Richard Senones KH6JEB, 95-161 Kauopae Place, Mililani Town, Hawaii 96789.

According to the McNish-Lincoln and Sargen predictions, the sunspot maximum will occur in November of this year hitting a smoothed high of 156. After that, a gradual decline will begin, bringing the June, 1980, figure down to around 145. There will be good times for the deserving DXer for several months yet.

A new country emerged from the Pacific Ocean on July 12th. The name is Kiribati and it was formed from, among others, the Gilbert Islands, the Line Islands, and the Phoenix Islands. Christmas Island, covering 124 square miles, is the largest island in the new country. The total land area of Kiribati is 264 square miles scattered across two million square miles of Pacific Ocean.

5N0DOG is Dave Guthrie, formerly K4QX/5N0. Dave's setup there in Nigeria includes a TS-820, an Alpha linear, and a TA-33 up 60'. He also has SSTV equipment and has promised unlimited activity. Dave has moved around quite a bit, having formerly signed HS1ADV, OX3BQ, KG1FR, KG6AOU, KL7ARL, TF2WBV, and KC6BO, to name a few. QSL to W4FRU, 4640 Ocean View Avenue, Virginia Beach VA 23455. SASE, of course.

Slim recently advised us of his upcoming itinerary. He will be signing RG8U from the Belden Congo (QSL to C0AX), and then is off to the Indian Ocean where he will be signing FR0ZE with C0LD handling the confirmations. I hope you will be able to add these new ones

to your list.

The nonprofit Northern California DX Foundation elected new officers recently and the results were as follows: President—John Troster W6ISQ, VP—Bob Ferrero W6RJ, Secretary—Merle Parten K6DC, and Treasurer—Vince Chinn. Don Schliesser K6RV, who has headed the Foundation for several years, stepped down as President but will continue on the Board of Directors.

Lem Nash WA4YVG, who previously signed /VQ9 and VQ9IN, is now signing /KH2 and has settled in for an 18-month stint on Guam. Any of these calls can be QSLed via W4XQ, 102 Schoolfield Drive, Danville, Virginia 24541.

The following bit of editorial comment was recently making the rounds on twenty meters. You CW types will probably have to explain it to your SSB brothers. "DX lists, DX lists, DX lists, RAH. Three dits, four dits, two dits, DAH."

W1OUN was in India recently and visited the Bangalore Radio Club. He reports that hopes there still run high for some possible Laccadive action before the year is out.

IG9BVS and IG9DMK were on Lampedus Island. QSL to I2BVS and I2DMK.

8J3ITU ran off some 20,000 contacts during ITU week. The QSLs are oversize and will be going out via the bureau. If you're in a hurry, you might try sending a large SASE to JH3DPB.

From time to time you will hear an overseas station complain that IRCs are not accepted in his country. Just because a post office clerk does not recognize an IRC, it does not mean they are invalid there. IRCs are legally good in all countries, with no exceptions. If you are having problems getting IRCs accepted, write to the local postal authorities. Do not take the word of a minor window

Continued on page 152



Kris FB8XV and his station on Kerguelen Island. Kris has handed out many new country contacts from this rare QTH.



Scenic view of lush Kerguelen Island. FB8XV says there is no lack of feminine companionship as there is a girl behind every tree.

WHEN QUALITY COUNTS.....

COUNT ON OPTOELECTRONICS FOR STATE-OF-THE-ART,
TOP QUALITY FREQUENCY COUNTERS AT PACE SETTING PRICES.

NEW Model K-7000 [Kit]	7 Digits	550 MHz	\$ 79.95
NEW Model 7010	9 Digits	600 MHz	\$145.00
NEW Model 8010	9 Digits	1 GHz	\$325.00

Note: Model K-7000 is available "KIT FORM" only, other models factory assembled only. Model K-7000 requires #AC-70 Adapter (\$4.95) for 115VAC Operation, AC Adapters are included with the other models. See chart below for NI-CAD Battery Pack Option, etc.

ALL MODELS HAVE MANY STANDARD QUALITY FEATURES INCLUDING:

- ANODIZED ALUMINUM CASES - PROVIDING RF SHIELDING
 - 1 MEG AND 50 OHM INPUTS - WITH EXCELLENT SENSITIVITY
 - AUTO DECIMAL PLACEMENT AT Hz AND MHz
 - AC-DC or NI-CAD BATTERY PORTABLE OPERATION
 - FULL YEAR 100% GUARANTEE [PARTS ONLY ON K-7000 KIT]
 - NBS TRACEABLE CALIBRATION
- MADE IN U.S.A.
- COMPACT SIZES: 8010 = 3" H x 7½" W x 6½" D
K-7000/7010 = 1¾" H x 4¼" W x 5¼" D



MODEL	\$ PRICE	RANGE 10Hz to	LED DIGITS	SENSITIVITY			HI-Z INPUT 10Hz - 60 MHz	GATE TIMES	RESOLUTION			TCXO TIME BASE		EXT CLOCK INPUT	NI-CAD BATT PACK
				25-250 MHz	250-450 MHz	450 MHz-1GHz			12 MHz	60 MHz	MAX FREQ	20°-40°C	FREQ.		
K-7000 kit	79.95	550 MHz	7	5-20 mV	10-30 mV	20-50 mV to 550 MHz	1-10 mV	(2).1,1 SEC	10 Hz	10 Hz	100 Hz 550 MHz	1.6 PPM	5.24288 MHz	NO	YES OPTION \$15.
7010 * 7010.1	145.00 225.00	600 MHz	9	5-20 mV	10-30 mV	20-40 mV to 600 MHz	1-10 mV	(3).1,1,10 SEC	.1Hz	1 Hz	10 Hz 600 MHz	1 PPM 0.1 PPM	10 MHz	YES OPTION \$25.	YES OPTION \$15.
8010 * 8010.1	325.00 405.00	1 GHz	9	1-10 mV	5- 20mV	10-35 mV	1-10 mV	(8).01-20 SEC	.1 Hz	1 Hz	10 Hz 1 GHz	1 PPM 0.1 PPM	10 MHz	YES STD	YES OPTION \$39.

*Has precision (0.1PPM) TXCO Time Base

Enjoy the great looks and ruggedness of the RF shielded metal case. Discover unsurpassed quality throughout for years of trouble free operation. Call or write for additional information or quick delivery of your order.

OPTOELECTRONICS, INC. ✓03
5821 N.E. 14th Avenue, Fort Lauderdale, Florida 33334

PHONE ORDERS
(305) 771-2050

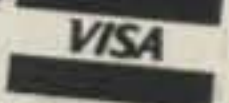

TERMS: Orders to U.S. and Canada, add 5% for shipping, handling and insurance, to a maximum of \$10.00. All other orders, add 10%.
C.O.D. collection fee \$1.00. Orders under \$15.00 add extra \$1.00 handling. Regular checks must clear before order is shipped. Florida residents add 4% sales tax.

ou goons don't ever pro...
lousy manuscripts from...
bur...
you...
I insist that you print ev...
tell Ma Bell that she sho...

LETTERS

INTERESTING METHODS

The article by Jerrold Swank W8HXR, "Compact Beams for 20 or 15," in the July, '79, issue provides some interesting methods of compacting HF beams.

Swank's method of feeding, however, may cause considerable exasperation to anyone who attempts to duplicate his results, or who picks up the tid-bit about using a quarter wavelength of RG-59/U as a quarter-wave transformer providing a 2:1 step-up ratio and later attempts to apply the principle to a similar feed problem.

Swank states, "I used a quarter wavelength of RG-59/U as a matching section from the driven element to the RG-8/U coax lead-in. I guessed that the beam impedance would be about 20 Ohms, and this would raise it to 40 Ohms."

His first guess was probably close, but his guess about what the quarter-wave RG-59/U matching transformer would do missed by a country mile. The 20-Ohm feedpoint agrees closely with published data in several books by Orr and the ARRL *Antenna Book*, where driven element-to-director spacing approximates 0.11 wavelength spacing. Swank's 20-meter beam with an 8-ft. boom would provide this condition.

However, a quarter-wave matching transformer of RG-59/U (73 Ohms), will only provide a 2:1 step-up ratio where $Z_S = 106.07$ Ohms and $Z_R = 53.035$ Ohms. These conditions are not met, since he estimates Z_R to be 20 Ohms.

Given that his feedpoint resistance does, in fact, conform to textbook data, what his quarter-wave matching transformer of 73-Ohm coax will do is transform the 20-Ohm Z_R up to 266.45 Ohms, presenting then a 5.124:1 mismatch to the 52-Ohm RG-8/U feeder.

This can be proven mathematically by the standard quarter-wave transformer equations: $Z_S = Z_0^2/Z_R$ and $Z_0 = \sqrt{Z_R Z_S}$, where Z_0 = characteristic Z of line, Z_R = resistive termination, and Z_S = input Z of the line.

From the equations, we can also calculate the correct Z_0 to provide the desired match between 20 Ohms (Z_R) and 52

Ohms (Z_S), the nominal Z of the RG-8/U feeder. For these impedances, the Z_0 should be 32.2 Ohms, which is not a standard coaxial line. It can, however, be accomplished by using parallel quarter-wave sections of RG-59/U or RG-59B/U, connecting both braids and both center conductors in parallel. This will provide an equivalent line with Z_0 of 36.5 Ohms ($75 \div 2$), a value close to the ideal. To calculate the mismatch into the RG-8/U using such a transformer, it is necessary to refer again to the equation: $Z_S = Z_0^2/Z_R$; $Z_S = 66.6$ Ohms.

Impedance mismatch between the RG-8/U (52 Ohms) and the quarter-wave transformer Z_S (66.6 Ohms), being a function of the ratio of these two values, then becomes 1.28:1, obviously a very acceptable value and a substantial improvement over the mismatched condition presented by Swank's quarter-wave of RG-59/U.

This then raises a question about how Swank obtained an swr measurement of 1.5:1 at the lowest point. This would make it appear as though the quarter-wave of RG-59/U was transforming a Z_R of 68.32 Ohms to a Z_S of 78 Ohms, since RG-8/U terminated in a 78-Ohm load would operate with the 1.5:1 swr he indicates. With a parasitic element spaced only 0.11 wavelength from the driven element, a feedpoint resistance of 68.32 Ohms would be much higher than normal, unless the elements were severely detuned. While this is possible, it is much more likely that his indicated 1.5:1 swr is simply incorrect. This can be verified by adding another length of RG-8/U between the feeder and swr bridge. The chances are that the swr will then change, indicating that neither the 1.5:1 value nor the second value obtained present a true picture of what the mismatch actually is.

My purpose in writing this is twofold—first to correct the error in the article, since Swank's assumptions about the quarter-wave transformer were totally incorrect and may lead someone astray, and second, to demonstrate that his original guess of a 20-Ohm feedpoint resistance may also have been in error.

Before applying any method of improving the impedance

match, it would seem logical to actually measure the feedpoint resistance. Two of the regular advertisers in 73 offer economical equipment for this purpose: MFJ's MFJ-202 RF Noise Bridge and Palomar Engineers' RX Noise Bridge. Both will indicate feedpoint resistance in addition to the resonant frequency, eliminating the need to "guess" what these critical characteristics might be. To hang a matching system on an unknown feedpoint resistance is kind of like scooping a handful of pennies into a bag, then saying that by removing 20, only 52 will remain.

Robert G. Wheaton W5XW
San Antonio TX

The chances are that my feedline was not a real half-wave multiple. Anyway, the simplest solution would be to use a pair of 59/U coax cables in parallel, which would be 37.5 Ohms. The length required is only about 10' 10", and this would give a match of 1.4:1.

The alternative would be to use no matching section, which would give a match of 2.6:1, and, if necessary, trim the feedline for a match or use a small L network.

I wrote the article mainly to give hams ideas on how to make beams with the materials at hand. I apologize for the error.

Jerrold Swank W8HXR
Washington Court House OH

MINUTES

A little research of the Minutes of the ARRL Board meetings the past six years has turned up a few interesting facts and raised a few questions, all of which might be the subject of a future editorial: expense accounts of the Directors and the President of the ARRL.

Naturally, being in the Hudson Division, I took a look at the expense account of this Division Director. It looks like this:

	Authorized	Increase	Total Received
1979	\$4,000.	\$(note)	\$4,000. + ?
1978	3,500.	300.01	3,800.01
1977	3,000.	204.30	3,204.30
1976	3,000.	none	3,000.00
1975	3,000.	36.23	3,036.23
1974	2,500.	none	2,500.00

Note: The increase in authorization to a Director comes at the Board meeting the following year.

Now, I work for the State of New York, traveling extensively throughout the state (not just the Hudson Division), with an occasional extra trip to Harrisburg PA or to Washington DC. My expenses include lodging, subsistence, plane fare, airport limos, taxis, and car rentals. My expenses for any year haven't come anywhere near the Hudson Division Director's ex-

penses authorized for 1974, the minimum of those checked!

Another very interesting fact turns up when looking for the expense accounts authorized to the President. The 1979 Board (1st) meeting authorized Mr. Harry Dannals an amount not to exceed \$10,000 "for 1979." Looking at the Minutes again, I can't find any authorization for Mr. Dannals for the years 1978 and 1977. (Isn't that strange?) He was authorized \$7,500, "for 1976," though. Apparently nothing was authorized for 1975 and 1974. Question: If, indeed, as I suspect, the President *did* receive expense authorizations for the years 1978, 1977, 1975, and 1974, where were they hidden???

The above "gravy trains" are being financed by the membership through an increase in dues in 1977 to \$12 a year, and again in 1979 to \$18 a year. It is no wonder that they are finding it difficult to increase the membership in the ARRL at these rates.

A most significant item (Minute #74) in the Minutes of the January, 1979, Board meeting, makes me very suspicious of financial finagling in Newington. Mr. Holladay made this motion that the General Manager (Baldwin) be directed to publish the League's audited financial statements in QST. This motion was amended by Mr. Price (at whose instigation?) to have the editor of QST directed to remind members through "League Lines" of the availability upon request of the League's audited financial statements. The amended motion was adopted, over the opposition of Mr. Holladay.

It is no wonder, with all the "lulus" available, that the Directors and the President are not desirous of rocking the boat by asking for an investigation of blatant dictator management of the ARRL in Newington.

Byron H. Kretzman W2JTP
Huntington NY

SACRIFICE

With mixed feelings, I wish to inform you that, in a drive to cut down my subscription list to something commensurate with my time to read, I am renewing your magazine and sacrificing the comparably laudable *Scientific American* and *Mother Earth News*. Yours has more circuits.

I have successfully resisted becoming a ham for some 35 years, and now that I am partially deaf (the National Semiconductor LM389 makes a dandy hearing-aid amplifier chip, though), it's unlikely that I'll ever succumb. I'm a longtime

Continued on page 156

HAVE YOU SEEN THE **VIBROPLEX**[®]



225 SL?

You can see it by writing: The Vibroplex Company, Inc.
476 Fore St., P.O. Box 7230, Portland, Maine 04112.

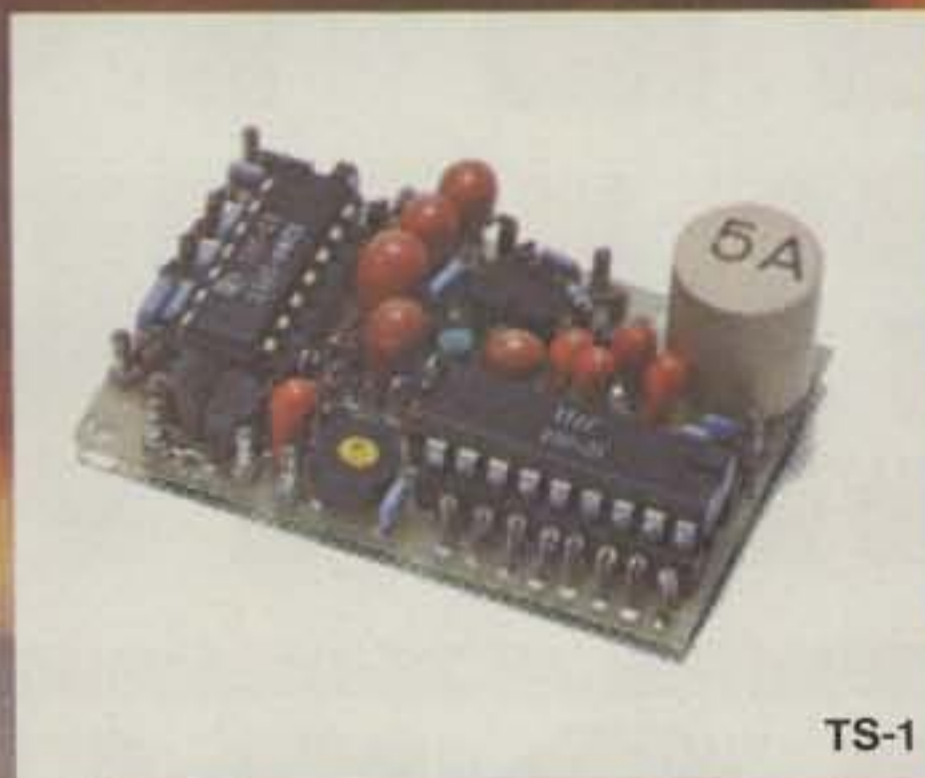

TS-1

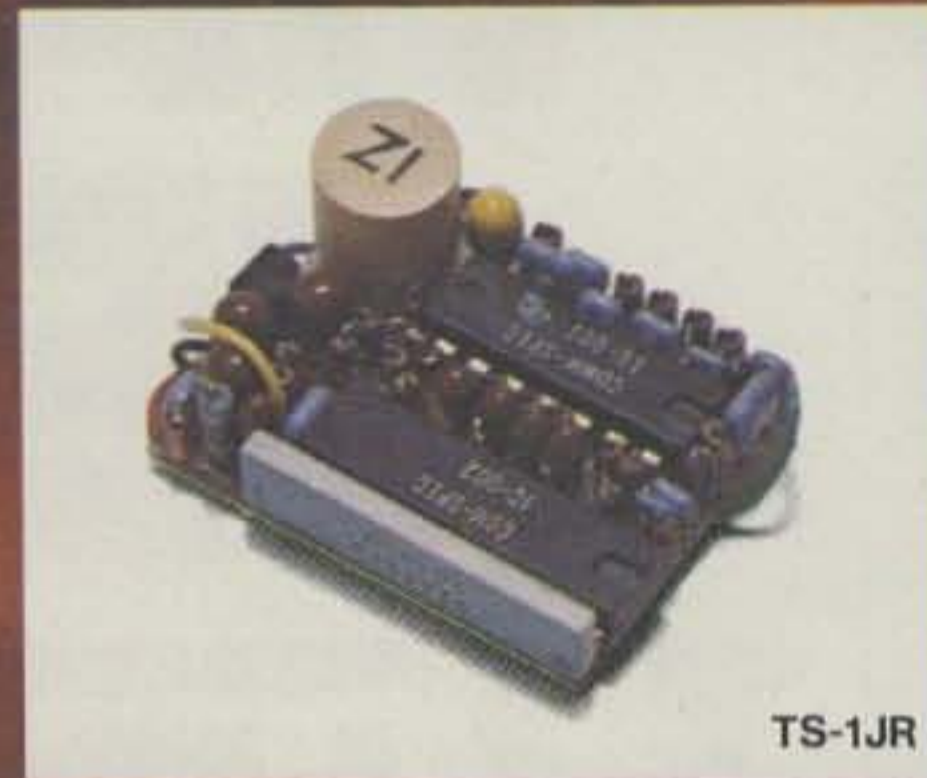

TS-1JR

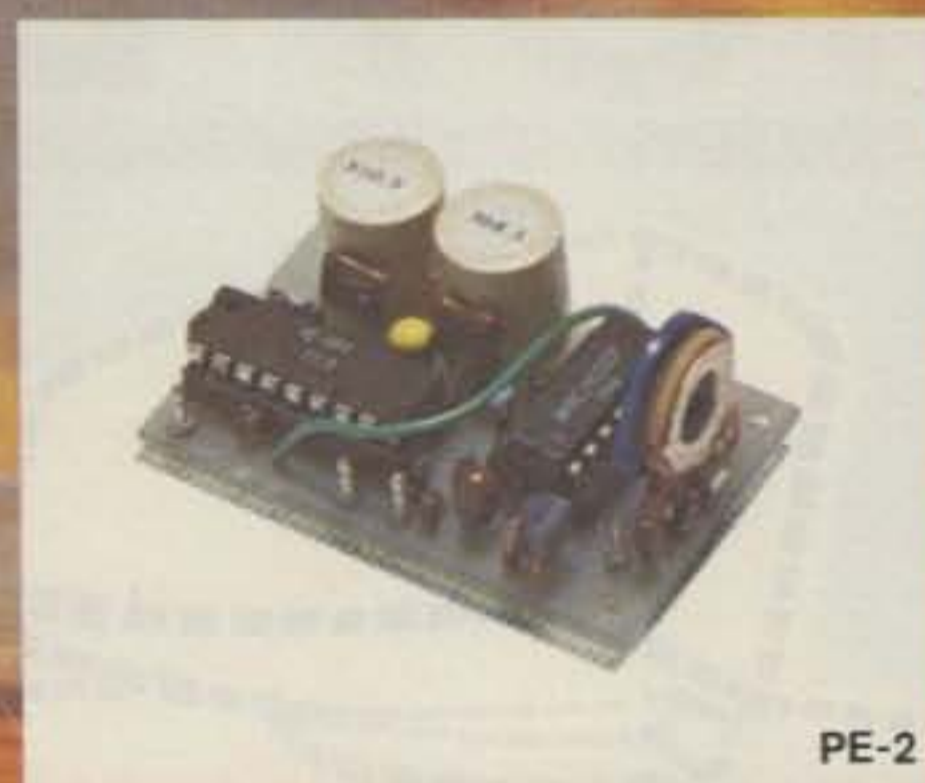

PE-2



SD-1

THE DAWNING

The age of tone control has come to Amateur Radio. What better way to utilize our ever diminishing resource of frequency spectrum? Sub-audible tone control allows several repeaters to share the same channel with minimal geographic separation. It allows protection from intermod and interference for repeaters, remote base stations, and autopatches. It even allows silent monitoring of our crowded simplex channels.

We make the most reliable and complete line of tone products available. All are totally immune to RF, use plug-in, field replaceable, frequency determining elements for low cost and the most accurate and stable frequency control possible. Our impeccable 1 day delivery is unmatched in the industry and you are protected by a full 1 year warranty when our products are returned to the factory for repair. Isn't it time for you to get into the New Age of tone control?



ME-3



TE-8



TE-12

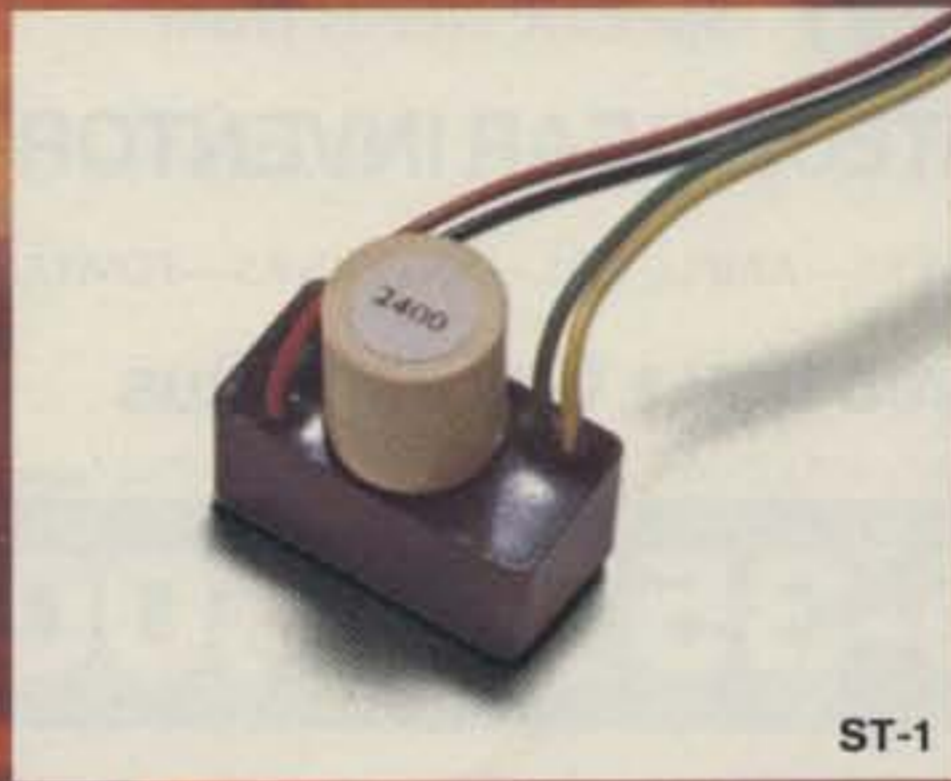

ST-1

OF A NEW AGE.

TS-1 Sub-Audible Encoder-Decoder • Microminiature in size, 1.25" x 2.0" x .65" • Encodes and decodes simultaneously • **\$59.95** complete with K-1 element.

TS-1JR Sub-Audible Encoder-Decoder • Microminiature version of the TS-1 measuring just 1.0" x 1.25" x .65", for hand-held units • **\$79.95** complete with K-1 element.

ME-3 Sub-Audible Encoder • Microminiature in size, measures .45" x 1.1" x .6" • Instant start-up • **\$29.95** complete with K-1 element.

TE-8 Eight-Tone Sub-Audible Encoder • Measures 2.6" x 2.0" x .7" • Frequency selection made by either a pull to ground or to supply • **\$69.95** with 8 K-1 elements.

PE-2 Two-Tone Sequential Encoder for paging • Two call unit • Measures 1.25" x 2.0" x .65" • **\$49.95** with 2K-2 elements.

SD-1 Two-Tone Sequential Decoder • Frequency range is 268.5 - 2109.4 Hz • Measures 1.2" x 1.67" x .65" • Momentary output for horn relay, latched output for call light and receiver muting built-in • **\$59.95** with 2 K-2 elements.

TE-12 Twelve-Tone Sub-Audible or Burst-Tone Encoder • Frequency range is 67.0 - 263.0 Hz sub-audible or 1650 - 4200 Hz burst-tone • Measures 4.25" x 2.5" x 1.5" • **\$79.95** with 12 K-1 elements.

ST-1 Burst-Tone Encoder • Measures .95" x .5" x .5" plus K-1 measurements • Frequency range is 1650 - 4200 Hz • **\$29.95** with K-1 element.



**COMMUNICATIONS
SPECIALISTS**

426 W. Taft Ave., Orange, CA 92667
(714) 998-3021

FOR BEST PRICE AND
FAST DELIVERY
CALL

1-800-325-3636

TOLL FREE



HAM RADIO CENTER
8340-42 Olive Blvd. P.O. Box 28271 St. Louis, MO 63132

H2

HAMTRONICS, INC.

WHERE THE HAM IS KING



FOR OVER 30 YEARS

H8

Let Us Fill Your

Specific Needs From

OUR \$2,000,000.00 AMATEUR GEAR INVENTORY

ALL THE FAMOUS NAMES—TRANSCIVERS—AMPLIFIERS—ANTENNAS—TOWERS

Give us a try before you buy • Call Jim Titus

a Division of TREVOSE ELECTRONICS, INC/ 4033 Brownsville Road, Trevoise, PA 19047

FREE UPS SHIPPING
ON PREPAID ORDERS



215-357-1400

THE SMART CHOICE IN

REPEATER CONTROL

Now with three exciting new features:

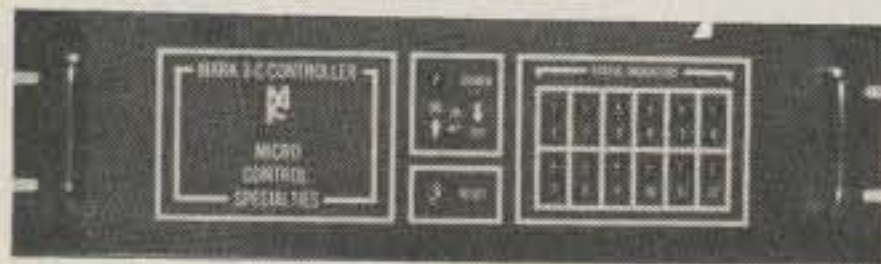

- Long Distance Calling
- Autodialing
- Remotely selectable timeout limits

IMAGINE A CONTROLLER —
SO VERSATILE It provides four different classes of output functions in addition to autopatch and reverse autopatch.
SO RESPONSIVE It sends thirteen Morse coded messages to keep you fully informed. Messages like BZ if you try to access a busy autopatch line.
SO ADVANCED It uses microprocessor technology and non-falsing digital tone decoding.
SO PERSONALIZED that many features are custom programmed to accommodate your unique needs.
SO EASY it can be installed in minutes with only five essential connections.

NOW imagine automatic dialing of emergency telephone numbers, long distance autopatch calling under control op supervision, plus remotely commandable timeout limits to match various operating conditions and you've just imagined the MARK 3C.

The MARK 3C is a complete control system with all audio and logic circuitry, status display, and power supply in one handsome cabinet. Its third generation design can replace racks of hardwired equipment while giving vastly expanded capability.

Get the field-proven power that only a MARK 3C can give at \$995. (100% factory assembled and tested)

M69

Call or Write for specifications

MICRO CONTROL SPECIALITIES (617) 372-3442
23 Elm Park, Groveland, Ma. 01834

Radio Shack DEALER

MICRO MANAGEMENT SYSTEMS



Up To 15% Discount
on
TRS-80's
BUSINESS SOFTWARE

MICRO-COMPUTER SPECIALIST
LARRY OWENS
COMPUTER CENTER

MINI MALL—DOWNTOWN SHOPPING CENTER
CAIRO, GEORGIA 31728
912-377-7120



Bearcat® 250

Only \$269.00 plus \$5.00 U.P.S. shipping.
Quantity discounts available!
Order toll free (800) 521-4414
or (313) 994-4444. Circle C5 on reader's service card for a free catalog or write us at Box 1002, Ann Arbor, Michigan 48106

COMMUNICATIONS ELECTRONICS™ C5

PASS FCC EXAMS



The Original FCC Tests-Answers Exam manual that prepares you at home for FCC First & Second class Radio-telephone licenses. You get the complete set of 15 newly revised multiple-choice examinations—covering all areas tested on the actual FCC exam. Also included—helpful study tips, short cuts, and "Self-Study Ability Test." These updated FCC Tests-Answers take the mystery out of preparing for current FCC exams. Practical proven Material. \$9.95 postpaid. Unconditional Moneyback Guarantee.

COMMAND PRODUCTIONS
RADIO ENGINEERING DIVISION C106
P.O. BOX 26348-F SAN FRANCISCO, CA 94126
Please rush me Tests-Answers for FCC First and Second Class Commercial License. My \$9.95 is enclosed.

Name _____
Address _____
City _____ State _____ Zip _____

ICOM squeezes optimum performance into even the tightest spaces.

Detachable control head of the IC-280, remotely mountable 2 meter mobile transceiver



ICOM Performance comes in full feature, multi-mode fixed station transceivers and also in the diminutive IC-280, designed to fit the most cramped modern vehicle. This heavily endowed performer is microprocessor controlled with the most sophisticated program of any of the ICOM radios. Small size means big performance with ICOM.



IC-280 control head mounted in Datsun 280Z

Touchtone capacity for the IC-280 is provided by the optional TT1215 which plugs into the 280's mic socket with no modification to mic or radio (no battery).

A 25 watt output module is available on special order from ICOM East or ICOM West. (Optional at extra cost; installation extra.)

The totally detachable small front section of the IC-280 houses the microprocessor for frequency control and memory. The IC-280's control head can store three frequencies of your choice which are selected by a four position front panel switch; and these frequencies are retained for as long as power is applied to the radio's memory pin... even when the front panel switch is turned off or power from the ignition is interrupted. And when power is completely removed from the IC-280 the ± 600 KHz splits are still maintained!

Frequency coverage of the IC-280 is in excess of the 2 meter band and its performance can easily accommodate the 144-145 (20 KHz/step) band plan. The main section uses the latest innovations in large signal handling FET front ends to provide excellent intermodulation character and good sensitivity at the same time. The IF filters are crystal monolithics in the first IF and ceramic in the second, providing narrow band capacity for today and tomorrow's crowded conditions. The IC-280 will be providing ICOM Performance for years to come.

ICOM Performance: Nobody Does It Better.

All ICOM radios significantly exceed FCC regulations limiting spurious emissions.
Specifications subject to change without notice.

HF/VHF/UHF AMATEUR AND MARINE COMMUNICATION EQUIPMENT



ICOM

ICOM WEST, INC.
Suite 3
13256 Northrup Way
Bellevue, Wash. 98005
(206) 747-9020

ICOM EAST, INC.
Suite 307
3331 Towerwood Drive
Dallas, Texas 75234
(214) 620-2780

ICOM CANADA
7087 Victoria Drive
Vancouver B.C. V5P 3Y9
Canada
(604) 321-1833

ICOM INFORMATION SERVICE
3331 Towerwood Dr., Suite 304
Dallas, Texas 75234

Please send me a full-color ICOM Product Line Catalog and a list of Authorized ICOM Dealers.

NAME _____ CALL _____

ADDRESS _____

CITY _____ STATE _____ ZIP _____

You may send a machine copy of this form.

RTTY Loop

Marc I. Leavey, M.D. WA3AJR
4006 Winlee Road
Randallstown MD 21133

Occasionally, a letter comes in which is so far afield from an idea I was trying to get across that I feel I must have made too many assumptions in the presentation. Such is the case this month.

Pete Buyaki K5GV is having trouble understanding my presentation of hexadecimal arithmetic. Pete writes, "[I]... hit a snag when I came to \$5F, etc. This seems odd since these numbers are in the middle of the ASCII table, because it's in the middle of the alphabet table... Looking up in the ASCII tables:

\$	0100100	
5	0110101	
F	1000110	
\$	0100100	Subtracting this
2	0110010	group from the
0	0110000	group above
the	0000000	space ?
difference	0000011	ETX (end text)
	0110000	SYN (synchronous idle)

"I'm sorry, but I don't understand the relation as to how the Baudot will remain in the capital letter format when ASCII is putting out lowercase letters."

Okay, Pete, there are two items of note here. First off, the convention representing one eight-bit byte in hexadecimal is "dollar sign—left nybble—right nybble." In other words, 01001110 in binary corresponds

to 4E in hexadecimal. So, when I say \$4E, what I mean is 01001110. Now, in ASCII, that \$4E corresponds to "N". Lowercase "n" is \$6E, which is \$20 more than \$4E. That is, \$4E + \$20 = \$6E. Another way to look at that is by converting the hexadecimal to decimal. \$4E is 78 decimal, and \$20 is 32. Thus, 78 + 32 = 110, and 110 decimal is \$6E hexadecimal.

If everything is clear so far, I'll throw in one more loop. The ASCII we have been talking about is a seven-bit code, but the hexadecimal representation is eight bits. The most significant bit is frequently called the "parity bit," and we have assumed it is set to zero. Some references assume a parity bit of "1". In that case, add \$80 (1000000 binary) to the ASCII values as represented. For example, carriage return becomes \$8D rather than \$0D, and that "N" becomes \$CE rather than \$4E.

One final note before I move on. I said that the dollar sign is used to preface hexadecimal numbers. You might wonder if other bases have similar labels. They do! Binary is denoted by a percent sign, and decimal either by no sign or an ampersand. Thus, %01011010 = \$5A = &90.

Another item in the mailbag this month is from D. A. Scott W4AKQ in Cape Coral, Florida. Scotty is looking for information on "silent RTTY," that is, RTTY using video terminals or computers. Sorry to say, I know of no book devoted exclusively to the subject. More articles have been published here in 73 than just about anywhere on that topic, however, and Fig. 1 is a compilation of articles I have noted within the last several years. Little information on any of the commercial RTTY video terminals has been received by this column, despite promises and offers from several sources. I would encourage you to ask around your area and see what

8080-based systems:

- "A Very Cheap I/O—The Model 15," 73, May, 1976, p. 77.
- "Digital Group RTTY Micro," 73, September, 1977, p. 98.
- "Baudot Interface Cookbook," *Kilobaud*, September, 1978, p. 66.

6800-based systems:

- "Baudot To ASCII," 73, November, 1976, p. 172.
- RTTY Loop, 73, June and July, 1978 (receiving).
- RTTY Loop, 73, June and July, 1979 (transmitting).

6502-based systems:

- "RTTY With The KIM," 73, September, 1977, p. 110.
- "Try Your KIM-1 On RTTY," 73 October, 1977, p. 88.
- "KIM-1 Can Do It," 73, February, 1978, p. 68.
- "RTTY With The KIM," 73, December, 1978, p. 170.
- "RTTY Transceive For The KIM-1," 73, May, 1979, p. 78.

Other systems:

- "Build This Exciting New TVT," 73, March, 1976, p. 76.
- "ASCII/Baudot With A PROM," 73, June, 1976, p. 114.
- "A RTTY/Computer Display Unit," 73, July, 1976, p. 118.
- "The XITEX Video Terminal," 73, December, 1978, p. 132.

Fig. 1. Articles on silent RTTY.

people are using. Be sure to write the manufacturers of any equipment you contemplate buying prior to investing in a unit, for information and literature. There apparently have been some problems with rf sensitivity and interfacing difficulties with some widely advertised equipment.

Another note received in the mail is from Art Santella K1VKO in East Norwalk, Connecticut. Art is using a Model 28-KSR Teletype and has added outboard paper tape equipment to provide the features of the "ASR" set. What he wants to be able to do is punch a reply tape while receiving.

I presume that you have the common Model 14 tape equipment, Art, although this will apply to any standard equipment. The tape punch you have is called a "reperforator," because it punches off of an active TTY line. Data is fed into it via the standard 60 mA [R]TTY Loop (don't mind the plug!). From what you tell me, you are using a HAL ST-6 demodulator as both the source of data and the loop supply. I assume your station hookup is something like Fig. 2.

There are many ways of hooking equipment up together, switches, tie lines, and the like, but the way that many RTTY enthusiasts have come to love over the years is with a patch panel. Diagrammed in Fig. 3, this is a series of phone jacks which are connected in series, so that any equipment plugged

into the strip is in series with anything else. Equipment may thus be switched from loop to loop with a minimum of effort. The key to the system is that the jacks are all shorted if nothing is plugged in. Thus one jack or all may be in the system at any time. Such a plug/jack system may be just what you need.

If you look into your Model 28, you should find a terminal strip, diagrammed in RTTY Loop, October, 1978, page 20, upon which are represented the leads for the keyboard. You should find a black and a brown wire on terminals seven and eight of TB-751. Bring these wires out to a plug and the terminal connections to a shorting jack. When you plug the keyboard leads into this jack, all will be as original. However, when you plug the keyboard into an auxiliary loop, which also supports the reperforator, you will be able to punch tape independent of the printer. Fig. 4 diagrams this system.

If you are going to do this, be sure that your keyboard contacts are clean and bypassed for rf. You normally do not receive while typing, and thus are unaware of the arcing that takes place on many keyboard contacts. If not conditioned, this arcing can generate severe hash in the received signal. A simple loop supply to use to run the auxiliary loop is shown in Fig. 5. Please don't forget that current-limiting resistor. Fried selector magnets do not smell very good.

That's about it for this month. With autumn approaching, conditions should be changing on many of the HF bands, and I hope to be on more and QSO many of you who have written.

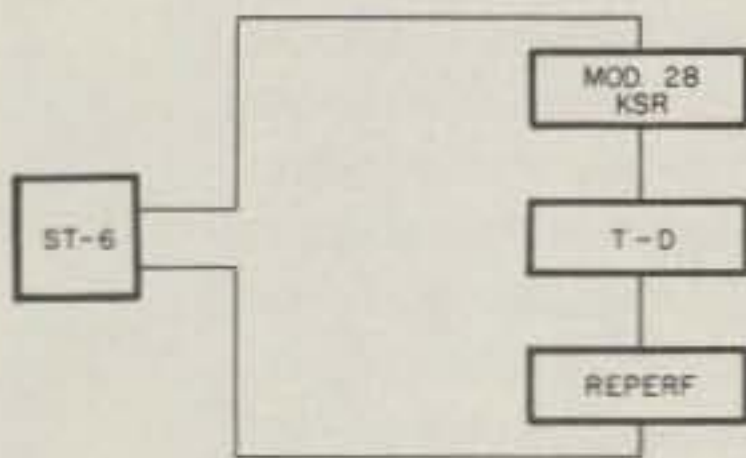

Fig. 2.

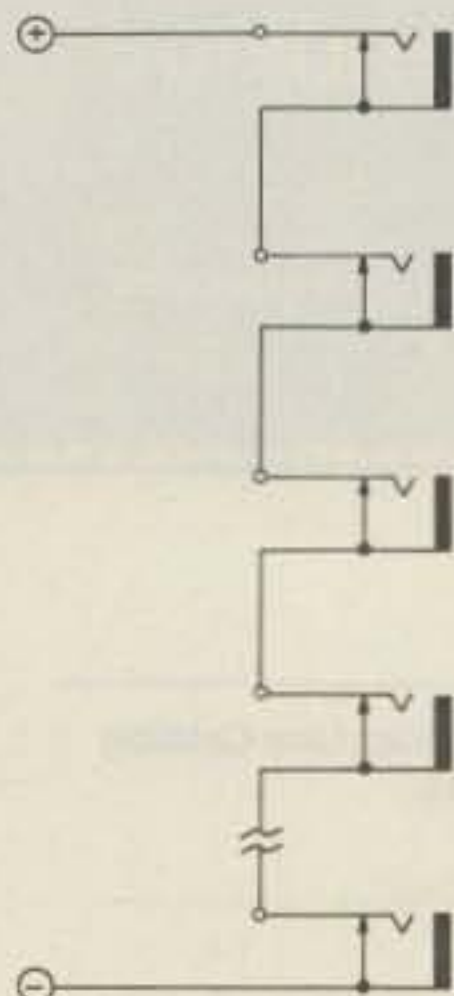

Fig. 3. Jack strip wiring.

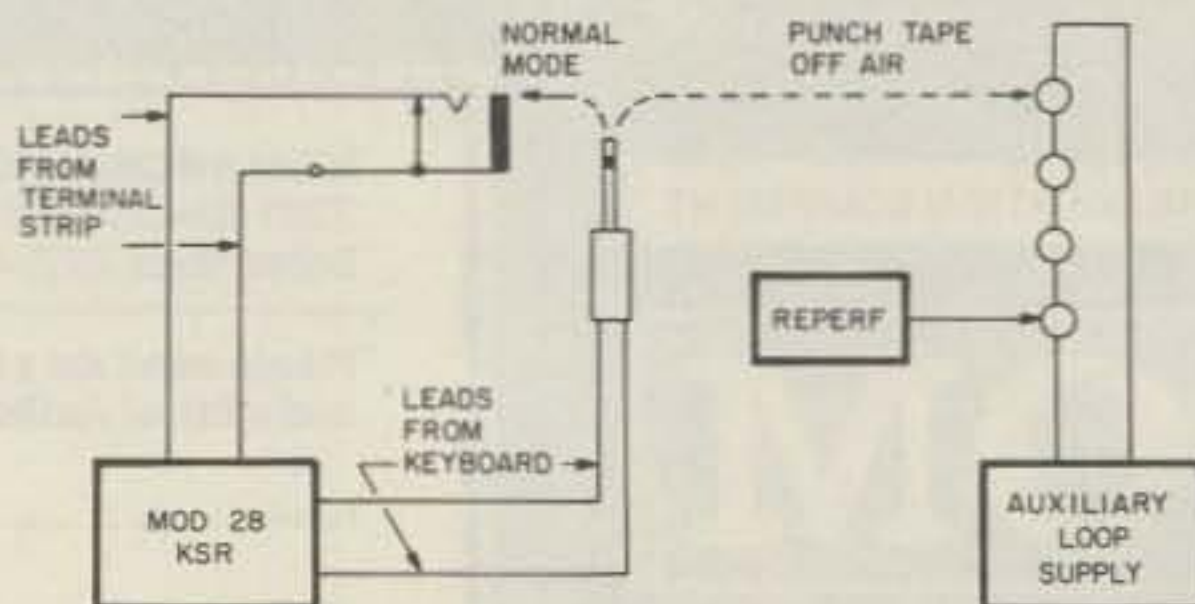

Fig. 4. Sample station wiring.

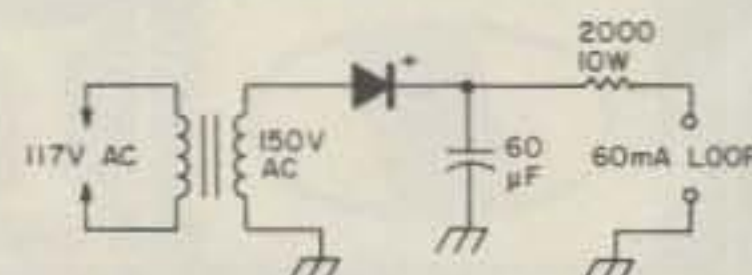

Fig. 5. Simple loop supply.

NOW YOU CAN HAVE BOTH

HIGH QUALITY & LOW COST!

The DS2000 KSR FROM HAL

HAL design experience now makes it possible to offer you an efficient, reliable, and cost effective terminal for your RTTY or CW station. Investigate the new DS2000 KSR from the people who KNOW HOW to build RTTY and CW equipment. See how you can get great performance and save money too!

- Integrated keyboard and video generator
- 72 character line
- 24 line display
- 2 programmable "Here Is" messages
- Automatic carriage return and line feed
- QBF and RY test messages
- Word mode operation, full screen buffering
- All 5 standard Baudot speeds
- 110 and 300 baud ASCII
- CW identification at the touch of a key
- Morse code transmit
- Morse code receive (optional)
self tracking speeds from 1-175 wpm on a separate plug-in circuit board (Available June, 1979)
- All in a convenient, small cabinet (14.1" x 9.25" x 4.35")

Price: \$449.00

Optional Morse Receive Board: \$149.00

Optional 9" monitor: \$150.00

BIG PERFORMANCE SMALL SIZE. . . SMALL PRICE

If you're looking for an RTTY demodulator with great performance on both the HF and VHF bands, take a look at the ST-5000 from HAL. The use of active filters with no phase-lock loop or 'single-tone' short-cuts assure the kind of performance you expect. Full features in an attractive and conveniently small package make this demodulator a value that's hard to beat!

Hard limiting front end

Active discriminator

Active detector

Wide and Narrow shift

(850hz and 170hz)

Normal and Reverse sense

Autostart

Self-contained high voltage loop supply

RS-232C voltage output (direct FSK)

Audio tone keyer (AFSK)

Provision for external tuning scope

Attractive, small cabinet

(2.75" H x 8" D x 12" W)

Fully assembled and tested

Price: \$225.00

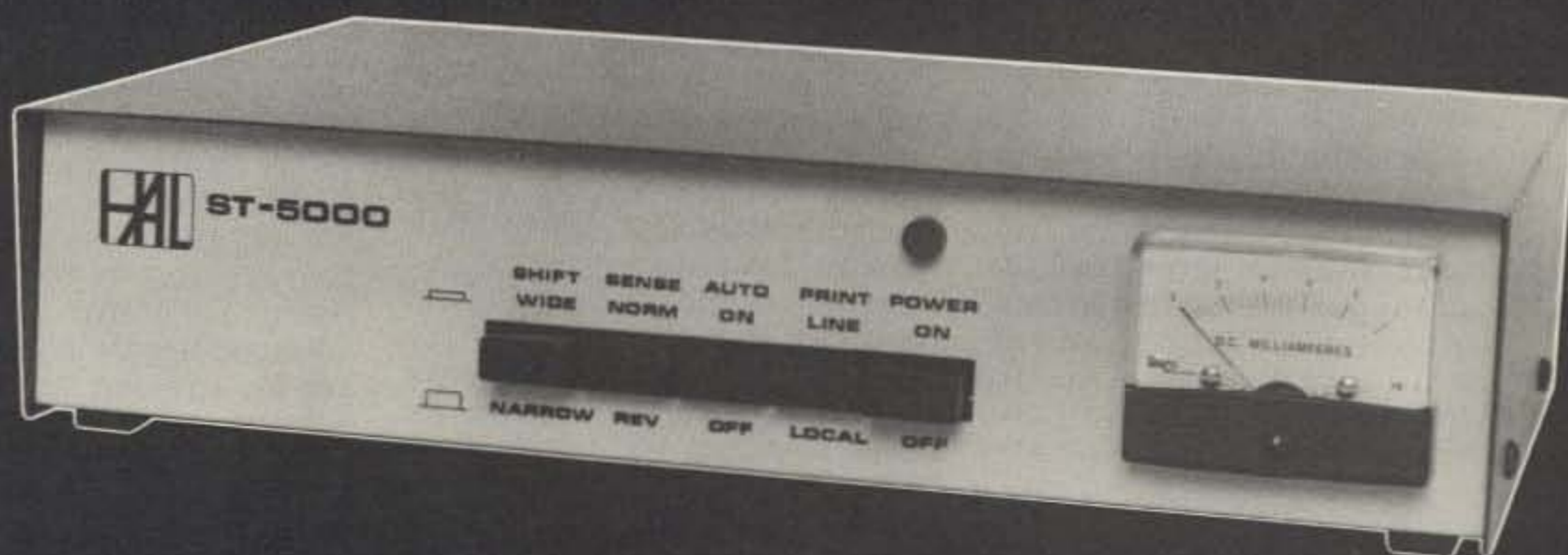

For more information call or write us at:

HAL COMMUNICATIONS CORP.

P.O. Box 365

Urbana, IL 61801

Phone: 217-367-7373

In Europe contact:

Richter & Co.; Hannover

I.E.C. Interelco; Bissone



New Products

SON OF THE QF-1

The recently introduced Autek Research QF-1A active audio filter is a unique selectivity-enhancing accessory that should be of interest to many amateurs, not only because of its quality and features, but also because of its moderate price tag (\$65 at this writing).

The QF-1A is the latest in a line of receiving filters that Autek has marketed since 1972. One could probably trace the lineage of the QF-1A and its competitors to the popular National Radio "Select-o-Ject" audio filter that was the apple of many a ham's eyes in the fifties. The current breed of solid-state filters offers a lot of improvements over the "S-o-J" and its vacuum tubes; the QF-1A, I found, has a number of special features that make it of great interest to CW and SSB operators alike.

Among these features are four filter modes of operation (peak, notch, lowpass, and highpass), continuously variable selectivity or bandwidth from "flat" down to 20 Hz, a main frequency adjustment that can be set anywhere from 250 to 2500 Hz in any of the four modes, and a *second* notch frequency adjustment control (added since the QF-1—more on this feature later). The filter is housed in a 6½" × 5" × 2½" gray-finish case and is designed to be plugged into the headphone or external speaker jack of the transceiver or receiver with which it is to be used. It contains a well-filtered 115-V ac power supply and a one-Watt audio power amplifier, so it does not require any additional connections to the rig for power or audio tap-in.

I have used the earlier QF-1 model filter for more than two years and have found it to be an essential station accessory—and, I might add, one which has required no maintenance at all. And, despite the

reasonably sharp 600-Hz CW and 2400-Hz SSB i-f filters which my Tempo 2020 has built in as standard equipment, I have found that the QF-1 has made the transceiver's selectivity a great deal sharper. The continuously variable filter characteristics allow a much greater flexibility in combating QRM and in eliciting "armchair copy" in an extremely crowded band.

The original QF-1, written up in *QST* in March, 1977, is similar in design to the newer version but is simpler and has fewer front-panel controls. The QF-1 has selectivity and frequency controls, a three-position mode switch, a speaker/headphone jack, and an ac on/off switch. The QF-1A, apparently drawing on user suggestions and throwing in some "nice to have" features, has five switches and controls on the front panel: (1) an ac on/off switch, which automatically bypasses the filter when turned off; (2) a four-position mode switch; (3) a calibrated selectivity control; (4) a frequency control; and (5) an auxiliary notch frequency control. The headphone/speaker jack is now mounted on the rear panel.

After unpacking the QF-1A from its shipping carton and reading the instructions (which were carefully prepared and complete), I hooked the unit up to my 2020, replacing the faithful QF-1. I found that overall performance was similar, although audio quality was somewhat "cleaner." Like the QF-1, the filter allowed superior "single-signal" reception of very closely spaced CW stations. The filter also worked nicely on SSB, having a very definite impact on signal readability by reducing sideband chatter, static crashes, background noise, and receiver hiss. By using the adjustable notch feature, heterodynes (beats) could be reduced or

eliminated on both CW or SSB with no trouble.

So far, there was little difference between the units. I found, however, that the newer filter provided a few operating features not found in the QF-1. For example, the on/off switch now automatically bypasses the filter when it is turned off. When using the QF-1, you had to unplug the speaker or headphones and plug them back into the transceiver or receiver when you were not actually using the filter, a minor but not insignificant annoyance. The older model's controls were adjustable over a comparable frequency range, but they were not calibrated; the QF-1A's controls are calibrated at key points, a factor which is useful in resetting the filter to the "flat" position when casually tuning the band or in trying to remember "which way to go" with a control in a pileup. The controls also have a somewhat improved "feel" and band-spread. The auxiliary notch control even allows a second heterodyne to be nulled out should the occasion arise (it will!). It's also possible to use this auxiliary feature to combine operating modes so that you can simultaneously notch/peak, notch/lowpass, or notch/highpass to your heart's content; the instructions tell just how to set up the controls to perform all this "black magic."

The new filter, I found, really comes into its own in serious CW work under crowded contest weekend or DXpedition conditions where weak, in-the-grass signals can often be brought up to effective "599" levels even in the presence of close-by rock-crushing signals which would ordinarily obliterate them. The desired signal can be peaked with an effective bandwidth of as little as 20 Hz with minimal ringing (although such narrow bandwidths are not usually necessary and can be fatiguing to the operator). Using the notch mode, very pronounced rejection (up to 70 dB) can be attained with very little tinkering with the controls. I find that operating in the lowpass mode doesn't produce excessive "booming" and is perfectly adequate for casual CW work used in tandem with the Tempo's 600-Hz filter. When the QRM gets rough, I switch to the peak mode and use the selectivity and frequency controls to zero-in on the desired signal. It's interesting to note that even with the transceiver's sharp CW filter, it's possible to actually "tune through" the Tempo's 600-Hz bandwidth and bring up three or four *separate* CW signals to solid copy that were unreadable without the filter in the circuit.

My use of both filters has indicated that SSB reception is also normally best in the low-pass mode and allows one to easily cope with adjacent-signal splatter and QRM; I like to run with this mode engaged at all times, as it enhances overall audio quality. The auxiliary notch control is effective in nulling out heterodynes, and when the SSB sledding gets rough, all one has to do is to slightly "sharpen up" the selectivity by tweaking the selectivity and frequency controls.

While the QF-1A and other active audio filters work best with receivers and transmitters that have narrow, steep-skirted internal i-f filters, I have found that the filter also does a surprisingly good job on sets that have poor i-f selectivity characteristics. For example, I found that I could dramatically improve the *effective* selectivity of my Yaesu FRG-7 general coverage receiver. The FRG-7, as supplied from the factory, is much too broad for good SSB and CW work. It's mainly an AM-type SWL receiver, and a good one for that purpose. Its basic i-f selectivity is listed as ±3 kHz at 6 dB down, and a built-in *fixed* audio filter allows selection of either 3-kHz, 2500-Hz, or 1500-Hz bandwidths. When hooked into the QF-1A, I could tell little *practical* difference in overall CW and SSB selectivity characteristics between the FRG-7 and the Tempo 2020 with its excellent internal filters! CW signals which were completely unreadable on the barefoot FRG-7 were now a solid Q-5 copy with the filter switched in, and the improvement in SSB reception, though not quite as dramatic, was nevertheless impressive. Of interest to SWLs, I found that the filter also improved AM selectivity on both the shortwave and AM broadcast bands and allowed stations just a few kHz apart to be separated nicely with little cross-channel chatter. This ability would be of special help to the medium-wave DXer in trying to sort out split-channel AM broadcast stations (those operating between the standard 10 kHz U.S. channels), as well as foreign broadcast stations which are often but 3 or 4 kHz apart on the shortwave bands. (If you use the QF-1 with the FRG-7 or another receiver with a built-in fixed audio filter, run with the internal filter *out* for best results.)

Being an inquisitive sort, I tried out the new filter with some other equipment and was surprised by the results. For example, I used it quite effectively with a converted Johnson 4740 SSB transceiver on ten meters. When operated in the



Autek's QF-1A.

lowpass mode, the filter did a great deal to reduce channel "bleedover" effects and crosstalk. Also, the notch feature was handy in suppressing annoying heterodynes from the many AM stations now on the band that use converted AM CB transceivers.

I also experimented with the filter on my KLM-2800. The 2700 is designed for two meter all-mode work, though the primary emphasis—as in most other "all-mode" transceivers—is on FM; it is somewhat lacking in good CW selectivity, and there are no provisions to add optional i-f filters to reduce bandwidth. Hooking up the QF-1A had much the same beneficial effect as it did when it was worked with the Tempo 2020—only more so. The filter added a great deal of selectivity to an otherwise broad set for serious CW work, and it made a difference on SSB as well. As expected, it didn't do much for FM reception.

The original QF-1 design was a good one. Most of the QF-1A's changes are convenience features and minor improvements, such as the addition of the automatic bypass, the auxiliary notch control, and the calibration marks on the selectivity/frequency controls. Also, the newer version's selectivity goes down to 20 Hz, as opposed to a "mere" 50 Hz on its predecessor. Both designs are thoroughly bypassed and filtered to prevent rectified rf from your transmitted signal from getting back into the audio circuitry and causing problems; I had no difficulty from rf feedback even when running a full kilowatt on 80 through 10 meters.

When working with very narrow selectivity, you may find it convenient to connect a Y-cord adapter in the output line and run an output to an oscilloscope or ham-type monitor-scope (such as the Heath SB-610 or similar Yaesu and Kenwood versions) to visually help in determining exact audio peaking. Also, one feature that could have been added to the QF-1A but wasn't is a set of switches to allow its use with two audio sources (two receivers, or a transceiver and a receiver) and two outputs (a headphone and a speaker). As it stands now, the unit must be manually plugged in and out of the equipment with which it is to be used, and the speaker and headphones must be plugged and unplugged by hand.

Also, I have found it expedient to feed the filter's output to a small "wireless FM rebroadcaster" module (I use the Ramsey module @ \$3) used in conjunction with a pair of cordless FM headphones. Doing so

eliminates the need for clumsy headphone coiled cords and has the side benefit of allowing you to monitor the band anywhere in your home or yard by tuning in the rebroadcaster's signal on a nearby FM radio. You may not want to try this, but I mention it to point out the possibilities and advantages of hands-off, cord-free hamming.

Some suggestions I had for enhancing the versatility of the basic QF-1 were described in my May, 1978, *73 Magazine* article, "The Super Select-o-Ject." Many of the changes I made to the QF-1, such as the switching arrangement, can be adapted to the new filter.

One caution: The QF-1 and its successor tend to emphasize any residual ac hum present in the transceiver's or receiver's audio output. This is normally caused by insufficient ac filtering in the rig and not in the audio filter. I have found this condition to be noticeable mainly when operating in the lowpass mode and feeding low-impedance, hi-fi type headphones, which normally have a heavy bass response. This problem can be minimized by adding a 50-to-150-Ohm, ½-Watt resistor in series with the headphone lead to cut down the phones' sensitivity and low frequency response.

In my opinion, the QF-1A is a real jewel well worth the modest price tag. While I have not as yet made an in-shack comparison between the Autek filter and its competition, I can say that the quality of construction (steel case) and circuitry board is excellent and reflects care in design and manufacture. The QF-1A makes a modest receiver or transceiver "come alive" in the selectivity department and allows the average set—so often lacking in *real* CW performance—to become a winner. For further information, contact *Autek Research, Box 5127, Sherman Oaks CA 91403*. Reader Service number A100.

**Karl T. Thurber, Jr. W8FX/4
Ft. Walton Beach FL**

Notes

1. There are a large number of audio communications filters on the market today. These include some highly competitive designs by MFJ, Waneco Radio, Dynamic Electronics, Datong, Kantronics, Electronic Research Corporation of Virginia, and others. These filters range in price from about \$30 to \$200 and more. If you are interested in building your own, a very good active filter design is shown by Donald Morar W3QVZ in the December, 1978, issue of *73*. His article, "Build the Flexi-Filter—A Very Active Device," is on page 222.

References

1. Product review, Autek Research QF-1 R-C Active Filter, *QST*, March, 1977, p. 44.
2. Thurber, Karl T., Jr. W8FX/4, "The Super Select-o-Ject," *73 Magazine*, May, 1978, p. 116.



Non-Linear System's MS-215 Miniscope.

MISSION IMPOSSIBLE? NOT WITH THE MS-215!

The manufacturer's service information reminded me of that TV series "Mission Impossible," and for that matter, what I had to do could very well have been a script for the show. It was nothing exciting—I just had to identify one bad chip on a circuit board containing 36 chips, located in a cabinet with an access door about 18 inches square. But, not to worry, according to the manufacturer—just get into the cabinet with a dual-trace 10-MHz scope, triggered, and look for the inputs and outputs on each chip. When you don't find both conditions, you've found the bad chip. I did omit one minor consideration—the board was a part of a computer-based central station monitor at our hospital, was hardwired in, and had to remain operational during the entire test procedure.

Not to be thwarted, I reached into my tool set and removed just what the "doctor" ordered, the Non-Linear System's MS-215 15-MHz dual-trace scope. Besides being self-contained and self-powered by nicads, the Miniscope measures a mere 2.9" x 6.4" x 8.0". Its vertical bandwidth extends from dc to 15 MHz, with ac, dc, or ground coupling switch-selectable. Deflection is 10 mV/div to 50 V/div in 12 calibrated ranges (with a stated accuracy of 3% of full scale with the vernier in the full clockwise position). The horizontal characteristics include: internal timebase or external horizontal switch-selectable mode with a timebase of 0.1 usec/div to 0.5 sec/div in 21 calibrated ranges. The maximum input voltage for both horizontal and vertical sections is 350 V dc and peak ac, providing that the dc component does not exceed 250 volts. A switch-selectable trigger permits + or -, with modes of internal, external, and line (line is non-functional when operating

off the nicads). A trigger-level control permits continuous adjustment of the trigger point.

While all of these technical specifications will impress a number of you, why should you or any ham want a scope this tiny? The answer is quite simple: The MS-215 Miniscope can go to the work when the work can't go to the scope! Maybe that's an oversimplification of the issue, but how many times in the last six months have you wished that you could have a piece of test equipment which was scaled down in size to the IC circuitry being examined, be it a computer CPU or the innards of a synthesized 2-meter ham rig? Better yet, how many jobs could you have done with little or no sweat if you and your scope could have been right there—on the spot rather than tied to a large scope with equally large probes further hindered by an ac power cord.

I acquired an MS-215 because with it we could locate the defective chip and remove and replace it at a total cost of perhaps \$2.00 in parts, while the new board would have cost somewhere in the area of \$1200. Considering that the MS-215 sells for around \$400 from a number of advertisers in *73*, purchasing it was a very wise move in terms of dollars and cents!

What can't you do with the MS-215? Well, to be honest, very little—unless you want to display a waveform to more than two close friends. We have literally used the scope for everything and anything you could imagine—from probing the interior works of a piece of hospital gear to troubleshooting the somewhat sickly departmental HT. In all cases, it performed as well as one of the larger and considerably higher-priced scopes in the department. Considering that the small package even included a calibrator which provides a square-wave signal of 1 volt peak-to-peak, and a graticule



Nye Viking's Model 250-0046-001 phone patch.

which (while small like the CRT) is easy to read — what more can you ask for in a package you can comfortably stuff into a coat pocket?

If you are interested in what you've read thus far and want more information about the MS-215 Miniscope, drop Mr. Allan Kay a line at *Non-Linear Systems, Inc., Dept. 73, Box N, Del Mar CA 92014*. Be sure to tell him that you read about their products in *73 Magazine*. Reader Service number N22.

Elliot S. Kanter W4PGI
Savannah GA

**NYE VIKING RECEIVES
FCC REGISTRATION
FOR PHONE PATCH**

Approval by the Federal Com-

munications Commission for official registration under Part 68 of the FCC Regulations has been granted to the Wm. M. Nye Company, Bellevue WA. This allows the Nye Viking phone patch to be plugged directly into the telephone line without the need (or cost) of a telephone company-supplied coupling device. It should be noted that users must still notify the telephone company that they are connecting the phone patch to the telephone line, and must furnish the company the official registration number and the ringer equivalence number (which are printed on an attached label).

Telephone patches may not legally be connected to party lines or pay telephone lines.



Lunar's LT-1 modular tower.

Users are cautioned that they must comply with all other requirements of the FCC pertaining to amateur radio communications.

The Nye Viking phone patch comes in two models: the 250-0046-001, without speaker, which provides connection to your own external speaker, and the 250-0046-003, with built-in loudspeaker, for use with most transceiver installations.

Nye Viking phone patches manufactured prior to official FCC approval and registration can be upgraded to approved status with the necessary changes, which include a 7-foot cord and a plug to connect into the telephone company line socket. Units returned for modification should be carefully packed and contain the sender's name and address. For further information, contact the *Wm. M. Nye Company, Inc., 1614 130th Ave. NE, Bellevue WA 98005*. Reader Service number N4.

LIGHT-DUTY VISE

The new Model VV-1 from OK Machine and Tool Corporation is a unique vacuum-based light-duty vise for precision handling of small components and assemblies. Featuring rugged ABS construction, it has 1½" wide jaws and 1¼" travel for maximum versatility. Also featured are an oversize knob for precise positioning and screw lugs for permanent installation. For further information, contact *OK Machine and Tool Corporation, 3455 Conner Street, Bronx NY 10475*. Reader Service number O5.

**LUNAR'S MODEL LT-1
MODULAR TOWER**

Lunar Electronics has announced a new line of towers. Manufactured in Lunar's San Diego plant, these towers are all-aluminum angle pieces, which bolt together to form a

sturdy structure capable of supporting considerable antenna arrays. The modularity of the six-foot sections makes them a natural for site surveys, field operations, and portable communications tests of all sorts, including amateur radio EME (moonbounce) operations.

Taking advantage of a building's height, they readily mount on rooftops, flat or peaked. The use of a length of 2 x 4 under leg pairs provides a simple yet effective mount for the tower. Since it must be guyed, no bolts, nails, or other requirements are necessary. The 2 x 4s additionally serve to distribute the weight over several roof joists.

These portable units are readily UPS shipped, and may also be carried as luggage on any airline. The construction is not unlike a childhood toy erector set, with each module bolted together with supplied hardware. Optional stainless steel hardware is also available (S suffix). Rotor and thrust bearing mounting plates are included in the basic tower package (Model LT-1), which yields an 11-foot structure when erected. The 6-foot add-on modular sections (Model LT-2) increase the height up to nearly 30 feet.

Since the tower is built from angle pieces, it forms its own ladder when erected and guyed. The base is 43 inches square, and the tower sections are 9.5 inches square. For further information, contact *Lunar Electronics, 2785 Kurtz Street, Suite 10, San Diego CA 92110; (714)-299-9740*. Reader Service number L17.

INSTA-PAC

Something new has come upon the scene which promises ease and efficiency for the QSL fan. Its name is "Insta-Pac," and it affords the ham the oppor-

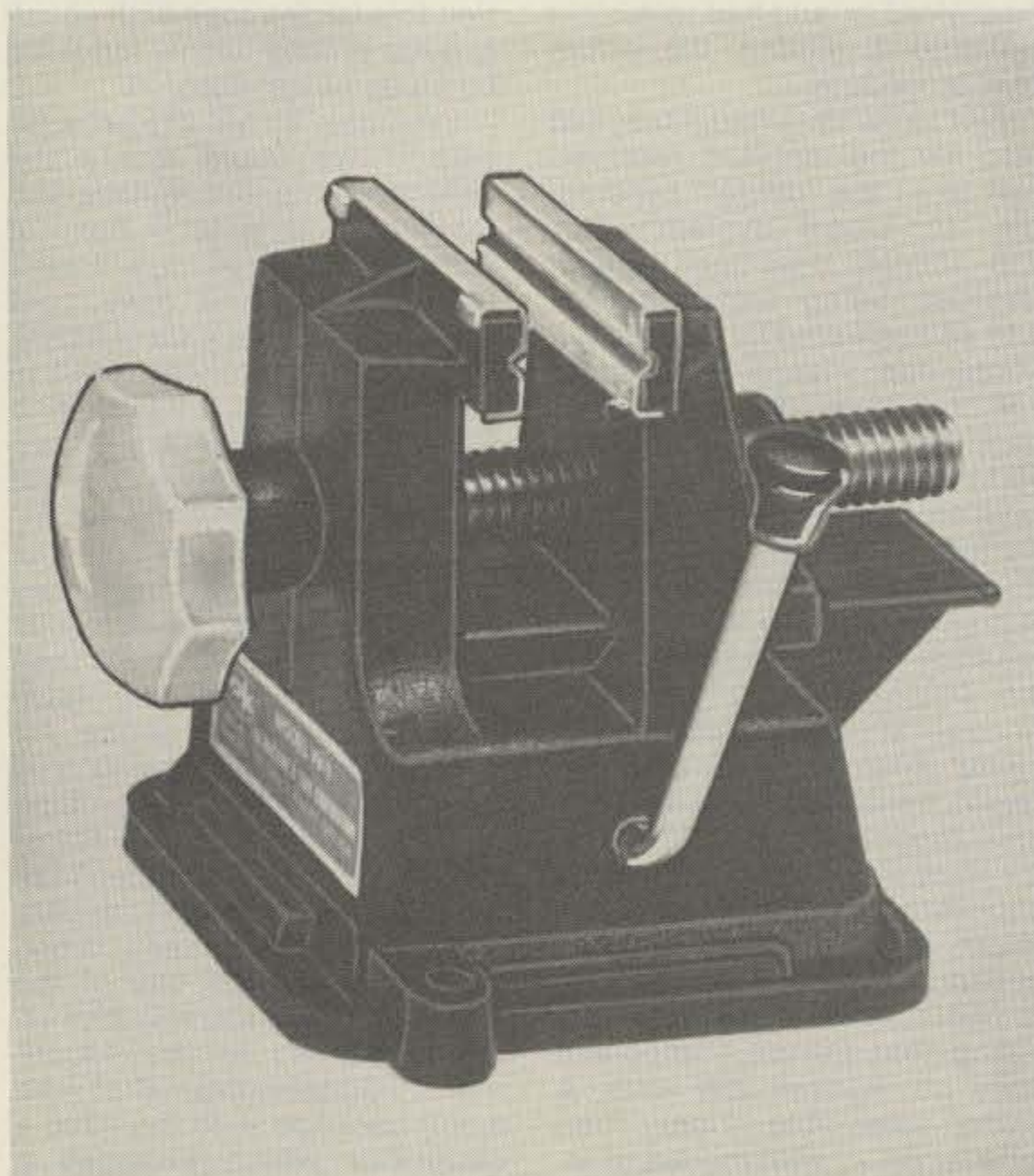

OK Machine and Tool's new VV-1 vise.

Continued on page 40

This NEW MFJ Versa Tuner II . . .

has SWR and dual range wattmeter, antenna switch, efficient airwound inductor, built in balun. Up to 300 watts RF output. Matches everything from 1.8 thru 30 MHz: dipoles, inverted vees, random wires, verticals, mobile whips, beams, balanced lines, coax lines.

MFJ LOWER PRICES!

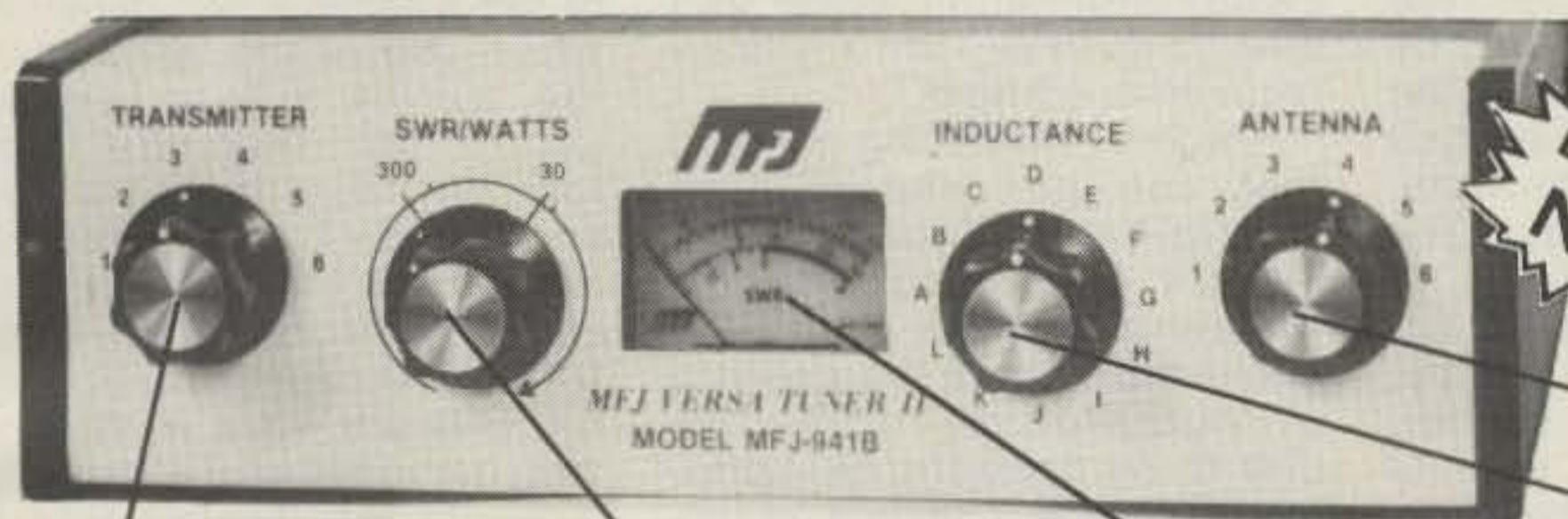

NEW, IMPROVED MFJ-941B HAS . . .

- More inductance for wider matching range
- More flexible antenna switch
- More sensitive meter for SWR measurements down to 5 watts output

NEW LOWER PRICE

\$79⁹⁵

Transmitter matching capacitor. 208 pf. 1000 volt spacing.

Sets power range, 300 and 30 watts. Pull for SWR.

Meter reads SWR and RF watts in 2 ranges.

Efficient airwound inductor gives more watts out and less losses.

Antenna matching capacitor. 208 pf. 1000 volt spacing.

Only MFJ gives you this MFJ-941B Versa Tuner II with all these features at this price:

A SWR and dual range wattmeter (300 and 30 watts full scale) lets you measure RF power output for simplified tuning.

An antenna switch lets you select 2 coax lines direct or thru tuner, random wire/balanced line, and tuner bypass for dummy load.

A new efficient airwound inductor (12 positions) gives you less losses than a tapped toroid for more watts out.

A 1:4 balun for balanced lines. 1000 volt capacitor spacing. Mounting brackets for mobile installations (not shown).

With the NEW MFJ Versa Tuner II you can run your full transceiver power output — up to 300 watts RF power output — and match your



ANTENNA SWITCH lets you select 2 coax lines direct or thru tuner, wire/balanced line, dummy load.

transmitter to any feedline from 160 thru 10 Meters whether you have coax cable, balanced line, or random wire.

You can tune out the SWR on your dipole, inverted vee, random wire, vertical, mobile whip, beam, quad, or whatever you have.

You can even operate all bands with just

one existing antenna. No need to put up separate antennas for each band.

Increase the usable bandwidth of your mobile whip by tuning out the SWR from inside your car. Works great with all solid state rigs (like the Atlas) and with all tube type rigs.

It travels well, too. Its ultra compact size 8x2x6 inches fits easily in a small corner of your suitcase.

This beautiful little tuner is housed in a deluxe eggshell white Ten-Tec enclosure with walnut grain sides.

S0-239 coax connectors are provided for transmitter input and coax fed antennas. Quality five way binding posts are used for the balanced line inputs (2), random wire input (1), and ground (1).

NEW 300 WATT MFJ VERSA TUNER II'S: SELECT FEATURES YOU NEED.

NEW MFJ-945 HAS SWR AND DUAL RANGE WATTMETER. NEW LOWER PRICE

\$69⁹⁵

BRAND NEW



Same as MFJ-941B but less 6 position antenna switch.

NEW MFJ-944 HAS 6 POSITION ANTENNA SWITCH ON FRONT PANEL. NEW LOWER PRICE

\$69⁹⁵

BRAND NEW



Same as MFJ-941B but less SWR/Wattmeter.

NEW MFJ-943 MATCHES ALMOST ANYTHING FROM 1.8 THRU 30 MHz. NEW LOWER PRICE

\$59⁹⁵

BRAND NEW



Same as MFJ-941B, less SWR/Wattmeter, antenna switch, mounting bracket. 7x2x6 in.

ULTRA COMPACT 200 WATT VERSA TUNERS FOR ALL YOUR NEEDS.

MFJ-901 VERSA TUNER MATCHES ANYTHING, 1.8 THRU 30 MHz. NEW LOWER PRICE

\$49⁹⁵

BRAND NEW



Efficient 12 position air inductor for more watts out. Matches dipoles, vees, random wires, verticals, mobile whips, beams, balanced lines, coax. 200 watts RF, 1:4 balun, 5x2x6 in.

MFJ-900 ECONO TUNER MATCHES COAX LINES/RANDOM WIRES. NEW LOWER PRICE

\$39⁹⁵

BRAND NEW



Same as MFJ-901 but less balun for balanced lines. Tunes coax lines and random lines.

MFJ-16010 RANDOM WIRE TUNER FOR LONG WIRES. NEW LOWER PRICE

\$29⁹⁵



1.8 thru 30 MHz. Up to 200 watts RF output. Matches high and low impedances. 12 position inductor. S0-239 connectors. 2x3x4 inches. Matches 25 to 200 ohms at 1.8 MHz. Does not tune coax lines.

For Orders **Call toll-free 800-647-1800**

✓ M52 Order any product from MFJ and try it. If not delighted, return within 30 days for a prompt refund (less shipping). Order today. Money back if not delighted. One year unconditional guarantee. Add \$2.00 shipping/handling. For technical information, order/repair status, in Mississippi, outside continental USA, call 601-323-5869.

Order By Mail or Call TOLL FREE 800-647-1800 and Charge It On

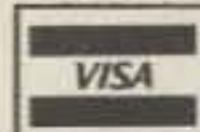

MFJ ENTERPRISES, INC.

P. O. BOX 494
MISSISSIPPI STATE, MISSISSIPPI 39762

Microcomputer Interfacing

Peter R. Rony
Jonathan A. Titus
Christopher A. Titus
David G. Larsen

MULTIPLEXED LED DISPLAY

Regardless of their application, most microcomputers need peripheral I/O devices for the input and output of data. The more common output devices included seven-segment displays, 5 x 7 dot matrix displays, teletypewriters, and cathode-ray tube (CRT) displays. We shall discuss several methods that can be used to interface seven-segment displays, as well as several different programs that are typically used to "drive" such displays, which are widely used in electronic games, calculators, point-of-sale (POS) terminals, gasoline pumps, children's toys, and taxi meters.

One of the simplest methods that can be used to interface a seven-segment display to a microcomputer consists of latching the appropriate data values from the data bus under software control (Fig. 1). The latch's inputs (7475) are wired to the

microcomputer's bidirectional data bus and the latch's outputs are wired to a seven-segment decoder/driver (7447). The decoder's outputs (current sinking) are wired to the seven-segment display with 220-Ohm current-limiting resistors. When an OUT 125 instruction is executed, the content of the 8080's A register is latched by the display interface and the two BCD numbers represented by D7-D4 and D3-D0 are illuminated on the two displays. The instructions listed in Fig. 2 cause a 39 to be displayed.

To display a 10-digit number using this method, ten latches, ten decoder/drivers, seventy resistors, and ten seven-segment displays will be required. One method of reducing the "parts count" for this interface would be to use a device such as the 8255 Programmable Peripheral Interface (PPI) integrated circuit.¹ This device can be used as three independent eight-bit output ports, so it is the equivalent of six 7475 latches. Therefore, two 8255 PPI chips, along with 10 decoder/drivers, seventy resistors,

and ten seven-segment displays would be required in the interface. One obvious disadvantage of this interfacing method is the large number of integrated circuits required. However, one advantage is that the software required to drive this interface is relatively simple. Also, the microcomputer only has to output this information once to the interface for the information to be continuously displayed. This, of course, is due to the latches or the 8255 chips in the interface. Thus, the microcomputer can output numeric information once and then go on to perform any other required operations.

Another interfacing method that can be used is digit multiplexing. Multiplexing reduces the display interface electronics (number of parts) to a minimum, but at the expense of longer and more complex display driver software. Multiplexing a display consists of enabling or turning on one particular digit with a *digit enable code* and providing the BCD numeric information for that digit to a multi-digit display interface. In this way, each digit is turned on, one at a time, as the actual BCD data for each digit is provided. Multiplexing is usually only used with multi-digit displays. As an example, suppose that the number 237 is to be displayed on a three-digit multiplexed display. To display this number, the BCD value for the digit seven would be output to the interface, along with the digit enable code for the right-hand display. After a short period (1 to 10 ms), the BCD value for the three would be output, along with the digit enable code for the middle digit. Again, after a short delay, the BCD

value for the two and the digit enable code for the left-hand display would be output to the interface. By performing this sequence fifty or more times every second, each digit in the display appears to be on all of the time. This same display method is used in hand-held calculators. Even though the digits are being turned on and off, it is happening too fast for the eye to see. The interface for a 10-digit multiplexed display is shown in Fig. 3.

When an OUT 125 instruction is executed, bits D3 through D0 of the A register will determine which one of the ten digits in the display will be enabled (turned on). Therefore, these four bits constitute the digit enable code. Bits D7 through D4 are latched (7475) and are decoded with a one-of-ten decoder (7442). The decoded outputs of the 7442 are wired to the common cathodes of the individual digits in the display. Bits D7 through D4 will provide the BCD code of the value to be displayed (0 through 9). These bits are also latched (7475) and are decoded by a seven-segment decoder/driver (DS8857, National Semiconductor Corporation, Santa Clara CA). The DS8857 supplies the current required to turn on the various segments (A-G) within the enabled digit selected by the 7442 decoder chip.

A relatively simple program can be written in which five packed BCD words (two BCD digits per word) are output to the display so that a 10-digit number is displayed (Fig. 4). This program has to unpack the BCD words stored in memory, combine the BCD digits with a

Continued on page 150

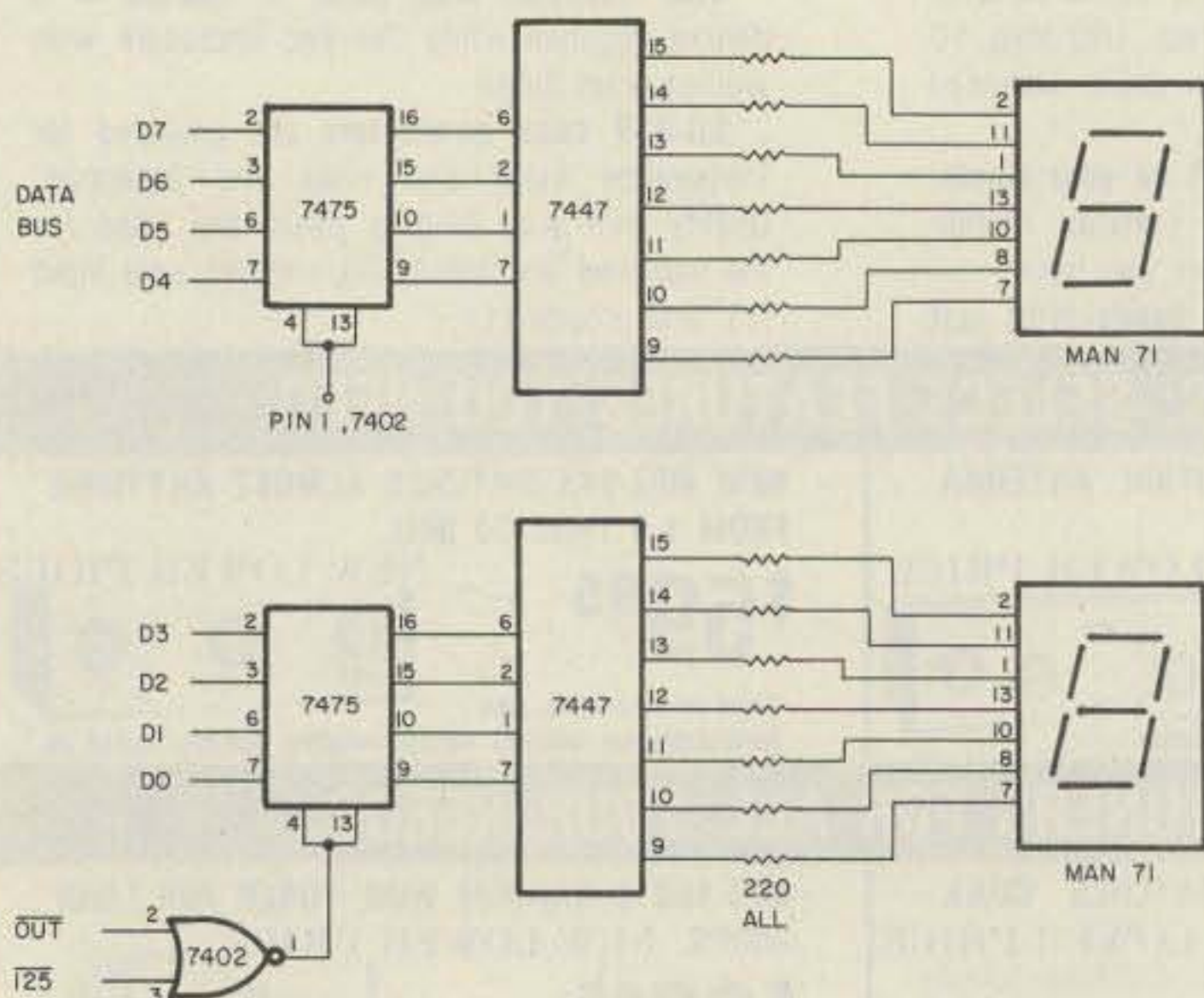

Fig. 1. A simple two-digit LED display interface.

```

/THIS SECTION OF A PROGRAM OUTPUTS THE
/BIT PATTERN 00111001 (OCTAL 071, HEX 39)
/TO AN OUTPUT PORT EQUIPPED WITH TWO
/SEVEN-SEGMENT DISPLAYS.

```

```

.
.
MVI A, 071 /LOAD A WITH THE FOLLOWING IMMEDIATE
OUT A /DATA BYTE (HEX 39, BINARY 00111001)
OUT 125 /OUTPUT IT TO THE TWO SEVEN-SEGMENT
DISPLAYS EQUIPPED WITH LATCHES
. /CONTINUE WITH THE REMAINDER OF THE
. /PROGRAM

```

Fig. 2. Displaying a 39 on the two-digit display.

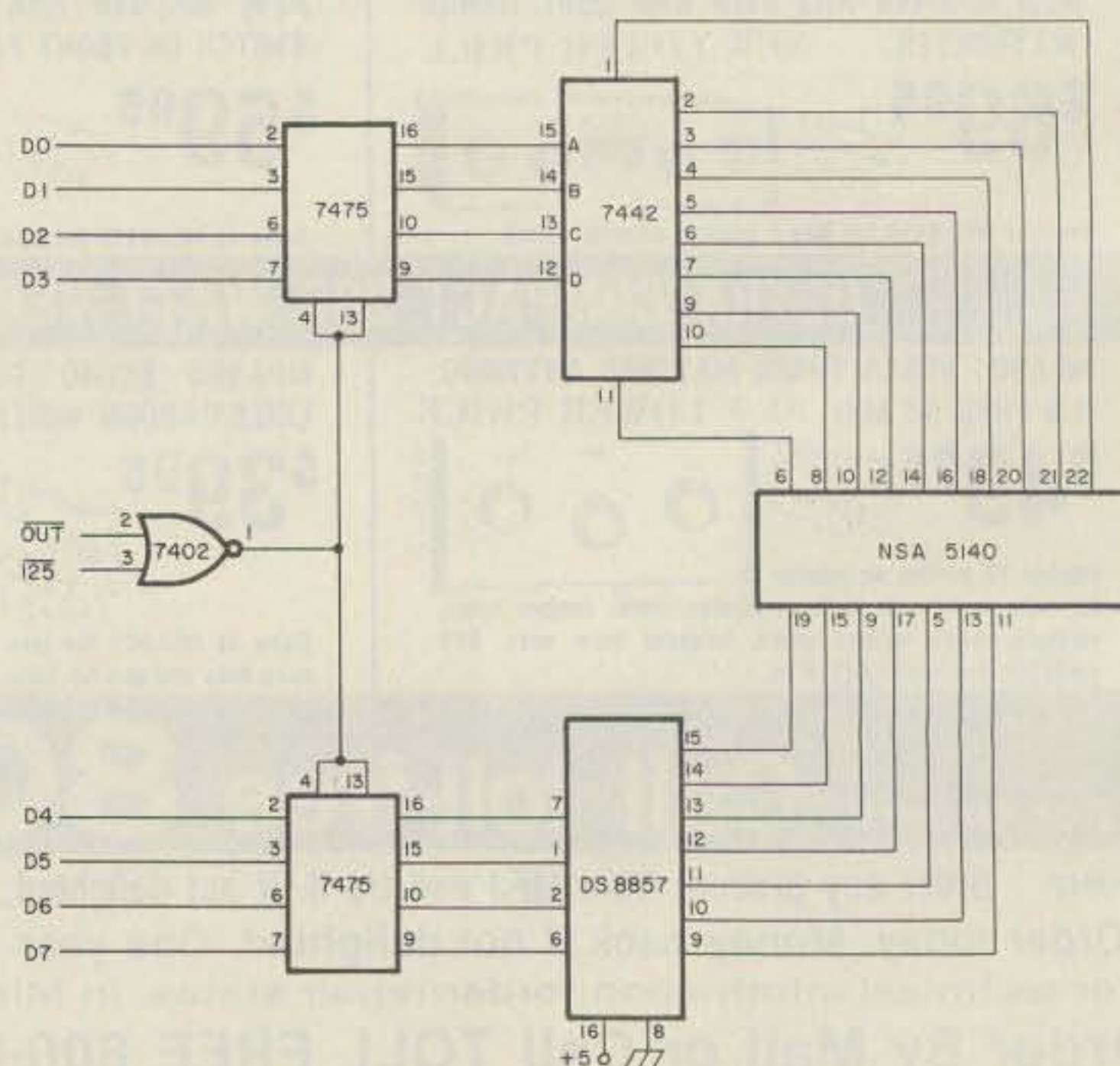
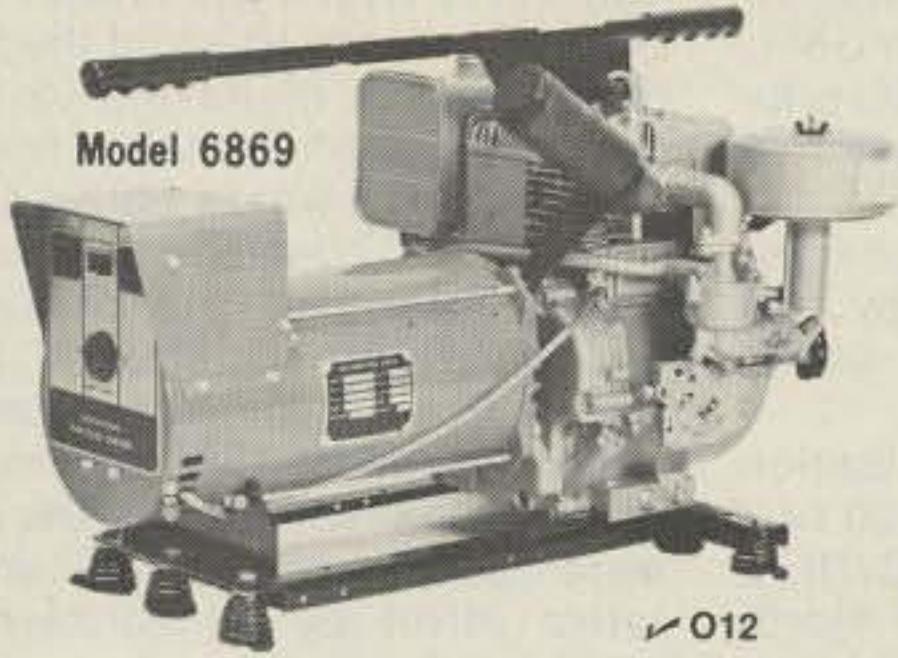

Fig. 3. A 10-digit multiplexed LED display interface.

AUXILIARY POWER
for Emergency or Portable Operation



Light wt. Portable Alternator. Stand-by power for Ham Equipment, household needs during power outages or operation in remote areas. Operates lighting, refrigerators, heating systems or other appliances including freq. sensitive loads such as TV sets, induction motors and fluorescent lights. Solid-State voltage regulation. 3750W rating; 25% surge capacity. 120/240V at 31.3/15.6A. 8 HP/3600 RPM B&S engine. Alternator draws just enough engine output to meet load resulting in up to 25% fuel savings. Low interference. Advanced design. Drip-proof construction protects windings from rain and dirt assuring long life. One year warranty by manufacturer. 30"L x 18"W x 19"H. 128 lbs. Shipped via Truck PREPAID (No extra charges) **\$659.95**

Electric Start **\$110.00**
Battery Charging, **11.00**
Spark Arrest Muffler **21.00**

Models available with 1350 to 7000 watt ratings. Write for our quote and additional information.

Mastercharge or VISA accepted

OUTDOOR OUTFITTERS

705 Elm Ct. Waukesha, WI 53186
Ph. 1-414-542-7772 • Ken, N9KS - Mgr.

FANTASTIC!!!

**FANTASTIC TRANSCEIVERS BY
DRAKE • TEN-TEC • YAESU**

<p>DRAKE "7" SYSTEM Buy your TR-7/DR-7 & PS-7 from Clegg for \$1644.00 and we'll allow you \$225 towards any Drake accessories! (VFO/FILTERS/TUNER etc.)</p>	<p>TEN-TEC OMNI Buy your OMNI-D from Clegg for \$1069.00 and we'll give you the matching 252 PS and 215P Microphone at no extra cost! SAVE \$148.95</p>	<p>YAESU FT-202R Buy your 202R HT from Clegg for \$199.00 and we'll give you a free set of NICADS plus a vinyl holster!! SAVE OVER \$28.00</p>
---	--	---

FANTASTIC PACKAGES BY CLEGG!!!

LIMITED TIME OFFER. ACT NOW!
We pay UPS on orders accompanied by Certified Check, cash or money order. Or order on VISA/MASTER CHARGE via 1-(800)-233-0250 (orders only)

Clegg ^{✓C3}
Communications Corp.
1911 Old Homestead Lane
Greenfield Industrial Park East
Lancaster, PA 17601
(717) 299-7221

MADISON

DOUBLE YOUR WARRANTY POLICY

Any large piece of gear we sell you (average \$300 or up) we will **double** your warranty period!

FOR EXAMPLE: A 3 month warranty = 6 months from date of purchase. 1 year = 2 years from date of purchase.

(OUR RELIABLE SERVICE DEPARTMENT REPAIRS NON-WARRANTY GEAR, TOO!)

Simply send your rig in a good shipping carton, postage prepaid, with a copy of your receipt showing date of purchase. We will repair promptly and return by best way.

NOTE: Manufacturers do not cover final in most cases, but we will try!

Try Our Competitive Prices, Too!

You, the customer, can only benefit from the **Madison Double Your Warranty Policy.**

Call **Don - K5AAD** or **Mike - W5VVM** for specific warranty claim questions.

*POLICY SUBJECT TO CHANGE WITHOUT NOTICE
DOES NOT COVER SPECIALS OR CLOSEOUTS.*



MADISON
Electronics Supply, Inc.

1508 McKinney, Houston, TX 77002, 713/658-0268

Lunar's Linearized Power Amps Save Energy.

To be "Linear," an amplifier output signal must be an exact reproduction of the input signal, with only the power level changed. We are the originators of the Linearized process. Our amplifiers exhibit this in transmit operation by the very small amount of side-splatter produced when compared to most other amps.



Model 2M10-80P \$199.95
10 Watt in, 80 W out.

You use 2 to 3 times less energy for the same power output with a Lunar power amplifier, because our amps are 2 to 3 times more efficient.

Another innovation is our pre-amp capability which improves signal reception on those circuits where signals are weak or dead.

Thus the station transmitting to you requires less energy, because his signal is strengthened at your receiver with Lunar's pre-amp capability. Again, this saves energy.

To paraphrase the August '78 QST review of our preamps... "no other commercially available preamplifiers can match or beat (the Lunar)." Don't waste your money or energy with high priced inefficient amplifiers. Get a Lunar power amp with pre-amp capability. They're really efficient.

SEE OUR PRODUCTS AT YOUR NEAREST LUNAR DEALER, OR DROP US A LINE FOR OUR LATEST BROCHURE.



^{✓L17}
2785 Kurtz Street
Suite 10
San Diego,
CA 92110
(714) 299-9740

Awards

Bill Gosney WB7BFK
2665 North 1250 East
Whidbey Island
Oak Harbor WA 98277

After months of planning and careful consideration, I'm particularly proud to announce this 73 exclusive—the 73 Magazine Awards Portfolio. Consisting of four domestic award incentives and four DX achievement programs, the awards portfolio promises to be a challenge and capture the interest of almost everyone on the band, whether you are a casual rag chewer or a big-time contester.

Read through the various award rules with caution. The requirements are not as easy as one might first imagine. We want our award recipients to know they had to earn their recognition and therefore designed each award to be somewhat of a challenge.

I will present each award in detail—the DX-oriented awards will be in the spotlight this month, and next month I will focus on the domestic ones.

Each of the sponsored awards will offer its own degree of difficulty. None was designed to be an overnight accomplishment, nor were any meant to duplicate any other awards in existence today.

So tune up those QRP rigs, kick in the blower on the kilowatt, rotate those beams, and fine-tune that dipole, as time's a wastin'; you've got some contacts to make and some awards to win! I plan to feature a special profile of the winner of the first award issued in each category. Subsequent recipients will be recognized in a monthly award summary.

73 DX COUNTRY CLUB AWARD

1. Sponsored by the editors of 73 Magazine.

2. Available to licensed amateurs throughout the world.

3. To be valid, all contacts claimed must be made in a single calendar year (January 1 through December 31), beginning January 1, 1979, and after.

4. This award is available for all phone, CW, and mixed modes.

5. To qualify, a minimum of 73 DX countries must be worked and confirmed from the 73 Magazine WTW (Work the World) DX Listing. All contacts must be made in the same calendar year.

6. Annual endorsement stickers are available for each succeeding year in which a minimum of 73 DX countries are worked.

7. To apply, prepare a list of

claimed contacts in prefix order. Include each station's full callsign, date and time in GMT, mode, and band of operation.

8. Do not send QSL cards! Have your list of contacts verified by two local amateurs, a local club secretary, or a notary public.

9. Enclose your verified list and award fee of \$3.00 or 8 IRCs for each award or endorsement. Send to: Bill Gosney WB7BFK, 73 Awards Editor, 2665 North 1250 East, Oak Harbor, Whidbey Island, Washington 98277 USA.

DX CAPITALS OF THE WORLD

1. Sponsored by the editors of 73 Magazine.

2. Available to licensed amateurs throughout the world.

3. To be valid, all claimed contacts must be made January 1, 1979, or after. There are no mode or band restrictions.

4. To qualify, applicants must work and confirm fifty (50) different national capital cities located in DX countries shown on the WTW (Work the World) DX Listing.

5. To apply, make a self-prepared list of contacts made in prefix order indicating the station worked, date and time in GMT, band of operation, and the name of the capital city and DX country.

6. Do not send QSL cards! Have your list of contacts verified by two amateurs, a local club secretary, or a notary public.

7. Enclose your application list and award fee of \$3.00 or 8 IRCs to: Bill Gosney WB7BFK, 73 Awards Editor, 2665 North 1250 East, Oak Harbor, Whidbey Island, Washington 98277 USA.

TEN METER DX DECADE AWARD

1. Sponsored by the editors of 73 Magazine.

2. Available to licensed amateurs worldwide.

3. All contacts must be made on the 10 meter band using only channelized converted Citizens Band equipment or similar type commercial units operating a maximum of 15 Watts PEP output. External amplifiers may not be used.

4. To be eligible for award credit, all contacts must be made October 1, 1978, or after, on AM, SSB, CW, or FM. Mixed mode contacts are not valid.

5. To qualify, applicant must work and confirm at least ten (10) DX countries from the WTW (Work the World) DX Listing. Endorsements will be given for 25, 50, 75, and 100 countries confirmed.

6. To apply, make a self-prepared list of contacts claimed, giving the callsign of each station worked in prefix order. Include the date and time in GMT, band, mode, and a brief description of the equipment used in making each contact.

7. Do not send QSL cards! Have your list verified by two amateurs, a local club secretary, or a notary public.

8. Forward your application list and award fee of \$3.00 or 8 IRCs to: Bill Gosney WB7BFK, 73 Awards Editor, 2665 North 1250 East, Oak Harbor, Whidbey Island, Washington 98277 USA.

WORK THE WORLD AWARD

To enhance the enjoyment of working DX, the editors of 73 Magazine take special pleasure in introducing what we feel will be one of the most sought-after awards in existence today—the Work the World Award.

1. Sponsored by the editors of 73 Magazine.

2. Available to licensed amateurs throughout the world.

3. To be valid, all contacts must be made January 1, 1979, or after. There are no band or mode restrictions. Only DX countries shown on the WTW (Work the World) DX Listing qualify.

4. The ultimate goal of this award program is the Work the World (WTW) Award, signifying excellence in DX communications. However, to qualify for WTW, applicants must first meet the requirements of the six Continental Awards, each of which is a worthy goal in itself.

5. Requirements for Continental Awards: North American Award—work 13 North American countries; South American Award—work 12 South American countries; European Award—work 12 European countries; African Award—work 12 African countries; Asiatic Award—work 12 Asiatic countries; Oceanic Award—work 12 Oceanic countries.

6. The Work the World Award is issued at no cost to any applicant who meets the requirements of all six Continental Awards. The operator who earns WTW has truly "worked the world."

7. To apply for any of the six Continental Awards, prepare a separate list of claimed contacts for each continent, listing all callsigns in prefix order. Include date, time in GMT, and band.

8. Do not send QSL cards! Have your list(s) verified by two amateurs, a local club secretary, or a notary public.

9. Enclose your verified list(s) and award fee of \$3.00 or 8 IRCs for each award applied for. Forward to: Bill Gosney WB7BFK, 73 Awards Editor, 2665 North 1250 East, Oak Harbor, Whidbey

Island, Washington 98277 USA.

Throughout this column, reference has been made to the new WTW (Work the World) DX Listing. In order to avoid the impossible task of having to decide what is and what is not a country, the awards editor and the staff at 73 decided to accept the decisions of the national amateur radio societies of the world. Special care has been taken to ensure that no single organization will dictate the criteria used; instead, an accumulative effort by all concerned will be recognized.

Thus, as the basis for all the DX awards sponsored by 73 Magazine, the official WTW DX Listing will be categorized by continents of the world. Within each continent, DX countries will appear in order of their call-sign prefix.

Additional copies of the WTW DX Listing or rules of the various award programs are available on request. Please be sure to enclose a 4½" x 9" SASE with all inquiries. Forward your inquiry to my home address which appears throughout this column.

If DX isn't your cup of tea, then the domestic awards featured next month will interest you for sure.

Keep the cards and letters coming. Your comments concerning this column have been well received and appreciated. Should you learn of an awards program being featured in your city, state, province, or country, please forward this information on to me. Together we can share the many achievements being offered our readers throughout the world.

WTW DX LISTING

NORTH AMERICA

C6	Bahamas
CO	Cuba
FG	Guadeloupe
FG, FS	Saint Martin
FM	Martinique
FO	Clipperton Is.
FP	St. Pierre & Miquelon
HH	Haiti
HI	Dominican Republic
J3, VP2G	Grenada & Dependencies
KC4, KP1	Navassa Is.
KG4	Guantanamo Bay
KL7	Alaska
KP4	Desotoe
KP4	Puerto Rico
KS4, KP3, HK8	Serrana Bank and Roncador Cay
KV, KP2	Virgin Islands
OX, XP	Greenland
PJ6, 8	Saba Is.
VE	Canada
VE1	Sable Is.
VE1	St. Paul Is.
VO	Newfoundland, Labrador
VP2A	Antigua, Barbuda
VP2D	Dominica
VP2E	Anguilla
VP2K	St. Kitts
VP2L	St. Lucia
VP2M	Montserrat
VP2S	St. Vincent & Dependencies
VP2V	British Virgin Islands
VP5	Turks and Caicos Islands
VP9	Bermuda
W, K, N, A	United States of America
XE	Mexico
XF4	Revillagigedo Islands
ZF	Grand Cayman Islands
4U	HQ, United Nations
8P	Barbados

Continued on page 155



ANTENNA SYSTEMS

Multi Band Beam Super DX Series

NEW HIGH PERFORMANCE TRI-BAND BEAMS AS GOOD AS FULL-SIZE MONO BAND ANTENNAS. These beams employ hybrid system which is a combination of separated full-size driven element for each band individually and Hi-Q trap parastic elements. These feature result high radiation efficiency, high power rating and excellent VSWR in entire band width.

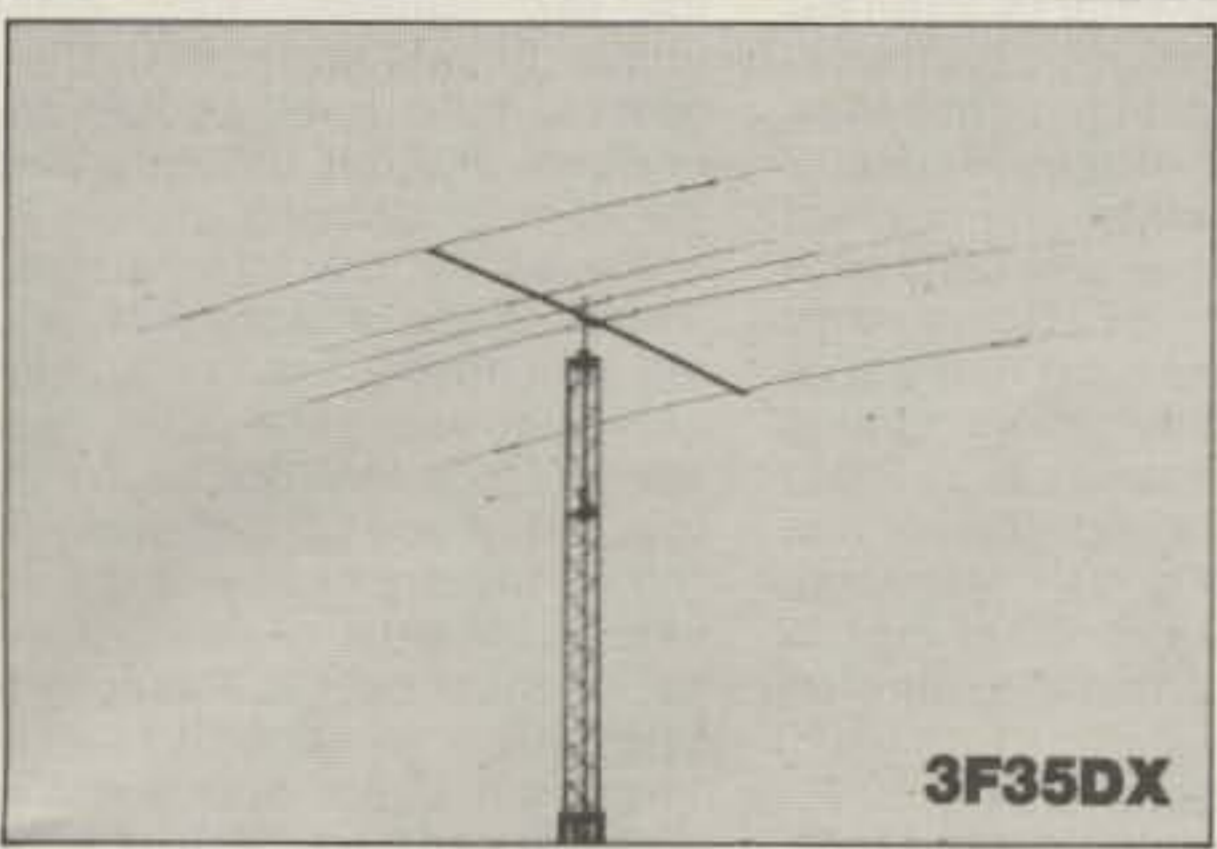

3F35DX

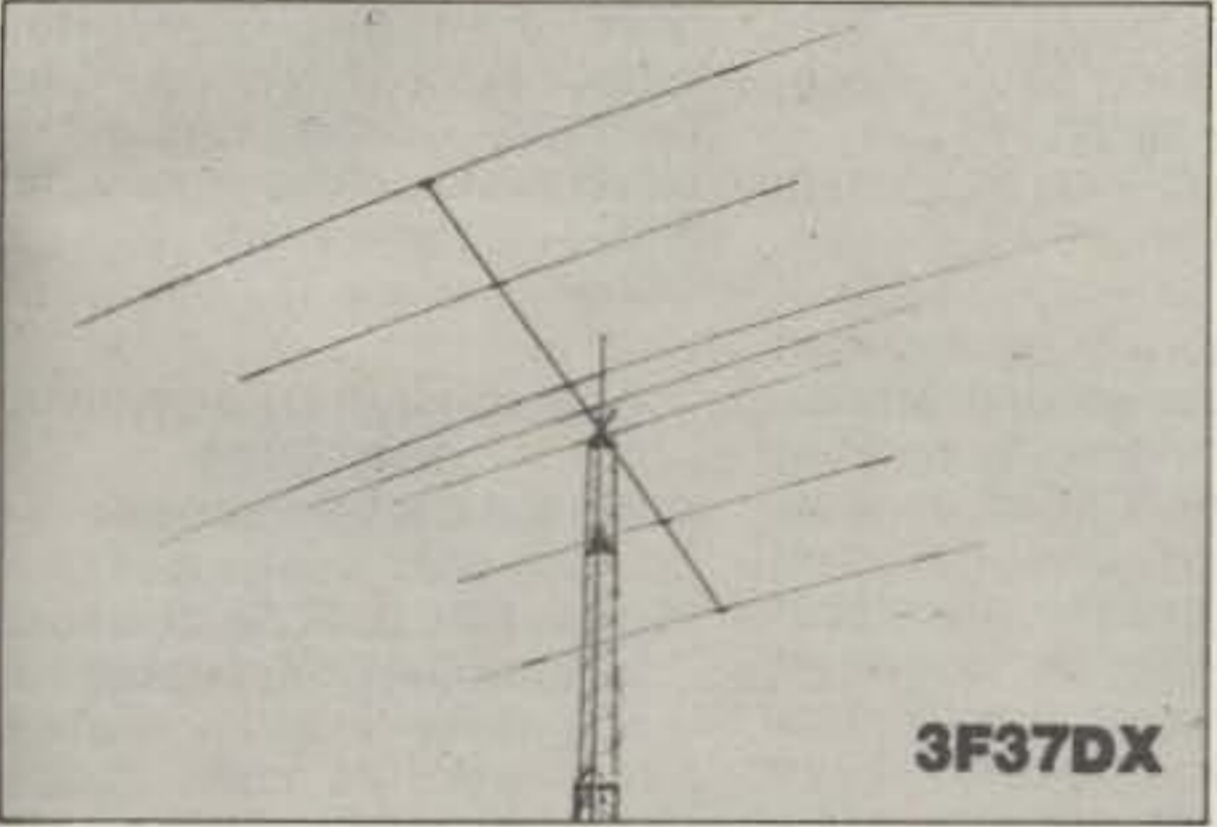

3F37DX

MODEL	3F37DX	3F35DX
BAND	14 21 28	14 21 28
ELEMENTS	7	5
ELEMENTS PER BAND	20m 3 15m 5 10m 5	3 3 3
ANTENNA GAIN	20m 8.5dB 15m 10dB 10m 10dB	8.0dB 8.5dB 8.0dB
FRONT BACK RATIO	25dB	20-25dB
MAX. POWER INPUT	3kw	3kw
VSWR	1.5 BETTER	1.5 BETTER
IMPEDANCE	50 Ω	50 Ω
MAX. ELEMENT L.	10.5m	10.5m
BOOM LENGTH	7.5m	5.0m
BOOM DIAMETER	50mm	50mm
TURNING RADIUS	5.3m	5.25m
WIND RATING	40m/sec.	40m/sec.
SUITABLE MAST	50mm	50mm
WEIGHT	23kg	17kg

MULTI BAND BEAM DX SERIES model 3F35DX

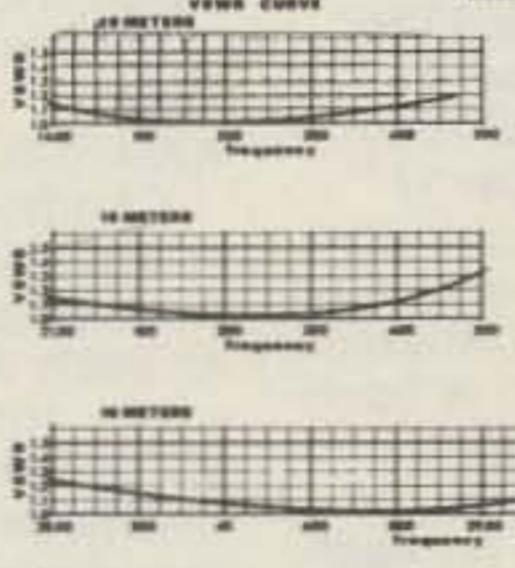

MULTI BAND BEAM DX SERIES model 3F37DX

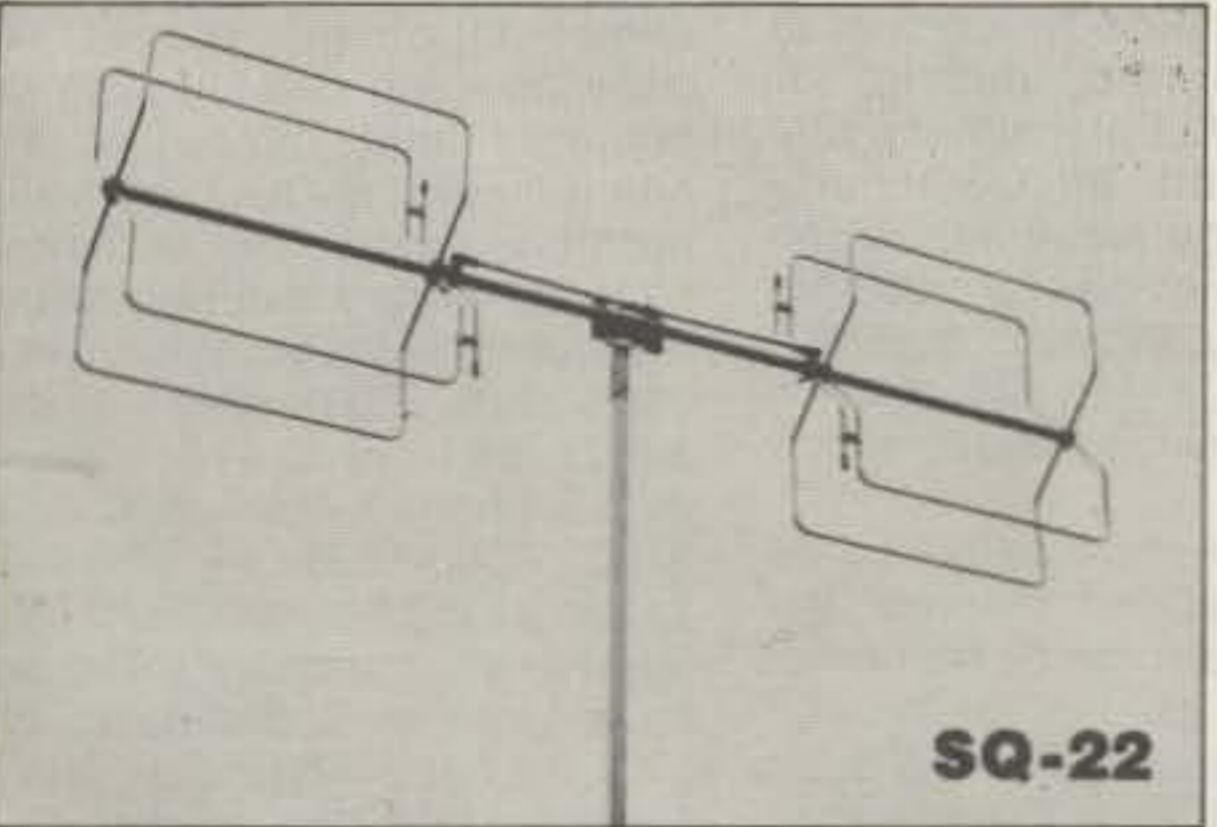
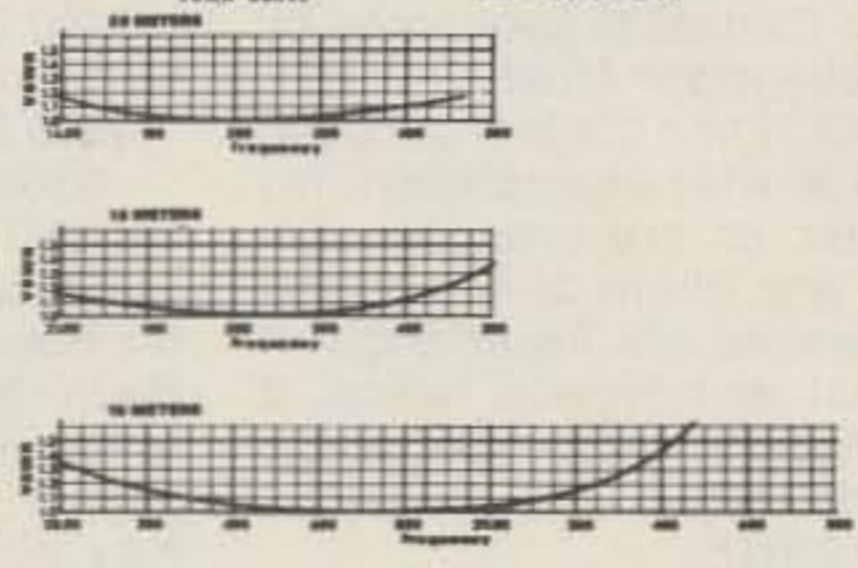

SQ-22

"SWISS QUAD VHF SERIES"

SQ-22 TWO METER DUAL QUAD

ANTENNA GAIN AND FRONT TO BACK RATIO ARE WELL IMPROVED WHEN TWO ELEMENTS ARE DRIVEN AT ONE TIME WITH PHASE DIFFERENCE COMPARED TO A SINGLE DRIVEN ELEMENT SUCH AS A CONVENTIONAL QUAD OR YAGI. THE SQ-22 PROVIDES THE OWNER WITH SUCH FEATURES SIMPLE ASSEMBLY AND LIGHT WEIGHT.

KEN PRO ROTATORS



KR-2000



KR-600



KR-400



KR-500

425 Highland Parkway, Norman, Oklahoma 73069

Tel (405) 360-6410

T55

TET U.S.A.

Contests

Robert Baker WB2GFE
15 Windsor Dr.
Atco NJ 08004

Please note that with this issue all award and contest announcements are being split into their respective separate columns. Please forward all information directly to the individual responsible for the particular column. Any information sent via 73 Magazine headquarters in Peterborough NH is only delayed and may not be received by the appropriate editor in time to appear in the magazine. Also, to the organizations sponsoring a contest, don't forget to send an abbreviated copy of the results for possible publication. They will be printed as space permits.

KENTUCKY QSO PARTY

Starts: 0001 GMT September 15
Ends: 2359 GMT September 16

This contest is sponsored by the Bluegrass Amateur Radio Club. Only one contact per band or mode with each station. No repeater or pre-arranged contacts are allowed. Suggested frequencies are lower edge of General and Novice bands, 2 meter simplex and SSB, and 6 meters.

EXCHANGE:

RS(T), county, and consecu-

tive QSO number; non-KY stations substitute state, country, or province for county.

SCORING:

Score 1 point per QSO. KY stations multiply by number of states, countries, and provinces worked. Non-KY stations use number of KY counties worked. Final multipliers are: 1.5 for all 10 meter contacts between 0200 and 1000 GMT; 2.0 for input of 15 Watts or less; 1.5 for input of 200 Watts or less; 2.0 for all VHF simplex QSOs. Novices or Technicians may take an additional 2.0 multiplier for CW only.

ENTRIES:

Mail logs by October 5 to: Donald Page WD4HPL, 309 Pocahontas Trail, Georgetown KY 40324.

WASHINGTON STATE QSO PARTY

Contest Periods:

0100 to 0700 GMT September 15
1300 GMT September 15 to 0700 GMT September 16
1300 GMT September 16 to 0100 GMT September 17

The 14th annual Washington State QSO Party sponsored by the Boeing Employees' Amateur Radio Society (BEARS) is open to all amateurs. All bands and modes may be used. Stations may be worked once on each band and mode for contact

points and more than once each band/mode if they are additional multipliers.

EXCHANGE:

QSO number, RS(T), county or state/province/country.

SCORING:

Washington stations score two points for each phone contact and 3 points for each CW contact, including contacts with other WA stations. Then multiply by the total of different states, Canadian provinces, and other foreign countries worked. All others score 2 points for each phone contact and 3 points per CW QSO with Washington stations and multiply by the total number of different Washington counties worked (39 maximum). There will be an extra multiplier of one for each group of 8 contacts with the same Washington county for all non-Washington stations.

FREQUENCIES:

CW—1805, 3560, 7060, 14060, 21060, 28160.

Phone—1815, 3925, 7260, 14305, 21380, 28580.

Novice—3725, 7125, 21150, 28160.

AWARDS:

Certificates will be awarded to the highest-scoring station (both single- and multi-operator) in each state, Canadian province, foreign country, and Washington county. Additional certificates may be issued at the discretion of the Contest Committee. Worked Five BEARS Awards are also available to anyone working 5 club members before, during, or after the QSO Party unless previously issued. All QSO Party entries will be screened by the Contest Committee for possible awards. The Worked 3 BEAR Cubs Award is also available for working 3 Novice members.

ENTRIES:

Logs must show dates, times in GMT, stations worked, exchanges sent and received, bands and modes used, and scores claimed. Include a dupe sheet for entries with more than 100 QSOs. Each entry must include a signed statement that the decision of the Contest Committee will be accepted as final. No logs can be returned. Results of the QSO Party will be mailed to all entrants; an SASE is not required. Log sheets and summary sheets must be postmarked no later than October 17 and sent to: Boeing Employees' Amateur Radio Society, c/o Contest Committee, Willis D. Propst K7RS, 18415 38th Ave. S., Seattle WA 98188.

89'ers RUN

Contest Periods:
Run #1: Saturday,
September 15,
1400 to 1800 GMT
Run #2: Saturday,

September 22,
2100 to 0100

(September 23) GMT

The object of this QSO party sponsored by the Sooner Chapter of Ten-Ten International is to collect as many 89'ers' numbers as possible and you do not have to have an 89'er number to enter. All contestants, other than local and charter members, may operate *only one* of the two four-hour runs listed above. Locals and charters will operate both runs. Locals and charters will not be competing for awards. Scoring will be the same as for the 89'er awards, except that contacts with people who have a Ten-Ten number only shall count one point. Send contest logs to WD5CSK by October 31. If you wish to apply for the certificate or any of the advanced awards, separate application must be made directly to WB5TKD. If you would like an information sheet and a list of awards, send an SASE to contest manager Ron Reid WD5CSK, 8832 NW 80, Yukon OK 73099. Contest logs will not be returned unless an envelope and sufficient postage is enclosed.

SCANDINAVIAN ACTIVITY CONTESTS

CW: 1500 GMT September 15 to 1800 GMT September 16
Phone: 1500 GMT September 22 to 1800 GMT September 23

Non-Scandinavian stations try to work as many Scandinavian stations as possible. The same station may be worked once on each band during the contest. Only CW-to-CW and phone-to-phone QSOs are valid, no cross-mode. Use all bands, 80 to 10 meters, but only within the following sections: CW—3505-3575, 7005-7040, 14010-14075, 21010-21125, 28010-28125; phone—3600-3650, 3700-3790, 7050-7100, 14150-14300, 21200-21350, 28400-28700 (as legal in your country!). The prefixes used in Scandinavia are: LA/LB/LG/LJ—Norway; JW—Svalbard and Bear Island; JX—Jan Mayen; OF/OG/OH/OI—Finland; OH0—Aaland Island; OJ0—Market Reef; OX—Greenland; OY—Faroe Island, OZ—Denmark; SJ/SK/SL/SM—Sweden. All these prefixes are geographically not in Scandinavia, but they are considered so for the contest. Operator classes include: a) single operator; b) multi-op/single transmitter; c) multi-op/multi-transmitter. Club stations, even if operated by one operator during the contest, are in the multi-operator class. Multi-op/multi-transmitter entries are to use separate series of serial numbers for each band.

EXCHANGE:

Calendar

Sept 8*	DAFG Short Contest—VHF
Sept 8-9	North American Sprint ARRL VHF QSO Party WAE—Phone
Sept 9*	DAFG Short Contest—SW
Sept 15-16	CAN-AM Contest—CW Kentucky QSO Party Scandinavian Activity—CW
Sept 15-17	Washington State QSO Party
Sept 15 & 22	89'ers Run
Sept 22-23	Scandinavian Activity—Phone
Sept 29-30	Delta QSO Party CAN-AM—Phone
Sept 30-31	College Radio Scrimmage
Sept 30-Oct 1	Fall Classic Radio Exchange
Oct 6-7	QRP Annual October QSO Party Arrowhead 50th Anniversary QSO Party
Oct 13-14	ARRL CD Party—CW
Oct 20-21	ARRL CD Party—Phone
Oct 28	Crazy Eight Net QSO Party
Nov 3-4	ARRL Sweepstakes—CW
Nov 10-11	CQ-WE Contest IPA Contest
Nov 11	OK DX Contest
Nov 17-18	ARRL Sweepstakes—Phone
Nov 24*	DAFG Short Contest—SW
Nov 25*	DAFG Short Contest—VHF
Dec 1-2	ARRL 160 Meter Contest
Dec 1-3	Connecticut QSO Party North Carolina QSO Party
Dec 8-9	ARRL 10 Meter Contest

* = described in June issue



FT-207R

in stock at

TOWER ELECTRONICS

24001 Alicia Pky.
Mission Viejo, CA 92691
(714) 768-8900



PERSONALIZED LICENSE PLATE FRAMES

YOUR NAME, QTH, 73 ETC. IN RAISED, WHITE LETTERS ON A BLACK BACKGROUND.

- DURABLE, DIE CAST METAL FRAME
- TRIPLE CHROME PLATED
- LETTERS CHEMICALLY FUSED
- FITS ALL AUTOMOBILES
- ACCOMMODATES ALL LICENSE PLATES
- EXCITING NEW GIFT ITEM!

\$ 8⁹⁵

PER FRAME
POSTPAID

✓ A107



WHEN ORDERING, SPECIFY TOP LINE COPY (12 LETTERS MAX. INCLUDING SPACING). "AMATEUR RADIO" APPEARS AS BOTTOM LINE ON ALL FRAMES UNLESS OTHERWISE SPECIFIED (12 LETTERS MAX.)

AJT ENTERPRISES

4442 VINTON AVENUE CULVER CITY, CA. 90230 (213) 836-2223

SATISFACTION GUARANTEED OR MONEY REFUNDED

CHECKS AND MONEY ORDERS ACCEPTED. CALIF. RESIDENTS ADD 6% SALES TAX

THE BIG^{SIGNAL}

UNADILLA^{U9}

"W2AU" Baluns

Still
Only
\$14⁹⁵

DEMANDED BY
PROFESSIONALS
WORLD-WIDE
OVER 12 YEARS

- The Original Lightning Arrest
- 650⁺ Strength
- Stainless Hardware
- Sealed
- GUARANTEED

ASSISTANCE?

Call: HUGH GUNNISON, WA2ZOT

Toll-Free 800-448-1666

[NYS Collect 315-437-3953]



FULL-POWER, QUALITY HAM ANTENNA PARTS

AT YOUR DEALER

- BALUNS · TRAPS · INSULATORS
- QUAD PARTS · ANTENNA KITS
- BOOM/MAST MOUNTS · WIRE
- CABLE · CONNECTORS

1:1 OR 4:1
2,000 W
PEP

WRITE FOR FULL CATALOG
[Enclose 30c Stamps]

IMCROWAVE
FILTER
FC COMPANY, INC.

6743 KINNE STREET, EAST SYRACUSE, NEW YORK, 13057

UNADILLA/REYCO DIVISION [Dept. 73]

DEALERS WANTED - OVER 300 WORLD-WIDE

RADIO EQUIPMENT DOESN'T GROW ON TREES

*But the C & A ELECTRONICS Warehouse Sale
Will Make You Think It Does!*

AEA
ALDA
ANTENNA SPECIALISTS
ARRL
ATLAS
ASTRON
ASTATIC
AMERICAN ELECTRONICS
ALEXANDER MFG.
BIRD ELECTRONICS
BEARCAT
BK PRODUCTS
CRAIG
CUSHCRAFT

COMMUNICATIONS SPECIALISTS
DVE
DSI INSTRUMENTS
DRAKE
DYCOMM
GOLDLINE
HY-GAIN
HUSTLER
ICOM
INTERNATIONAL CRYSTALS
KDK
KLM ELECTRONICS
KENWOOD
KRIKET

LUNAR
LARSEN
MAXRAD
MIRAGE
MIDLAND
MOTOROLA
NON-LINEAR SYSTEMS
PACE
PIPO
POWER INC.
ROYCE
REGENCY
RUSSELL
REDCO COUNTERS

STANDARD
SANYO
SHAKESPHERE
TPL
TRIX
TAYLOR
TRISTAO
TRINETICS
VHF ENGINEERING
WILSON
WESTCOM
YAESU

Call 213-834-5868

FOR YOUR BEST VALUES ON THESE FINE LINES

Be Sure To Check Our SUPER SAVER

Cash & Carry Specials



CGA Electronic Enterprises

Distributors of Commercial and Amateur Radio Equipment

22010 S. Wilmington Ave., Suite 105
Carson, CA 90745

SUB-DEALERS!

CHECK-OUT OUR FABULOUS SUB-DEALER PROGRAM!

You will be pleased by our prices, policies, promotional tips, technical service and personal attention to your individual needs.

We provide an elaborate, up-to-date, computerized listing of all major lines. We offer BIGGER QUANTITY DISCOUNTS as your volume increases!

Increase your sales volume with the Famous "Thomas Touch."

Send letterhead for *complete* Sub-Dealer Package.



SUB-DEALER
DIVISION DEPT. 12

95 Kitts Lane, Newington, Conn. 06111
1-800-243-7765 or Conn. Res. 203-667-0811

Call Toll Free 1-800-243-7765

FREE

- Monthly Used Equipment / New Specials List
- ★ New 1979 Retail Catalog!
- Courteous, Personalized Service



New Equipment — All new equipment on display is operating for actual "on the air" QSO's. We really know our gear!



Used Equipment — We recondition and guarantee all our used equipment. We make sure it satisfies you!



Service Shop — You've probably heard of our fine service reputation — using Cushman CE4B signal generators, Hewlett Packard oscilloscopes, Bird wattmeters — we fix it right!



Inventory Warehouse — Our large volume assures you the best prices!

PARTIAL USED EQUIPMENT LIST (Guaranteed 30 Days — 7 Days Refund Policy)

COLLINS RADIO

75S3 Receiver With CW FILTER	\$ 479.00
75S1 Receiver	299.00
75S3B Receiver	685.00
KWM-2 With 516F2 (Round Emblem)	1299.00
30L-1 Amplifier	495.00
32S1 Transmitter	349.00

DRAKE

R-4 Receiver & T4 Reciter	449.00
RV4-C VFO	89.00
R4-B Receiver	349.00
T4-X With Drake Desk Mic.	359.00
2NT Transmitter	99.00
2-C Receiver W/2CQ Multiplier	219.00
ML-L 2M FM Transceiver	128.95

HEATHKIT

Digital Multimeter SM-1210	80.00
SB-650 Digital Display	139.00
HW-16 XCVR W/VFO	159.00
SB104 W/H.P. 1146 P.S.	599.00
SB102 W/H.P.23B & SP-600	443.00
Freq Counter IB-1103	100.00
HR-10B Receiver	69.00
SB-630 Console	99.00
SB-303 Receiver W/CW Filter	259.00
SB-300 Receiver W/SP600 Speaker	219.00
DX-60B Transmitter	69.00

KENWOOD

R-599 Receiver	299.00
TR-7200 FM XCVR	189.00

SBE

SB-36 Transceiver	449.00
-------------------------	--------

ICOM

22-S FM XCVR	209.00
--------------------	--------

TEMPO

VHF One Plus	299.00
Tempo I W/AC-1	399.00
Henry 2K-4 Amplifier	899.00

ATLAS

210X W/NB & DMK & Mobile Mount	679.00
--------------------------------------	--------

HAMMARLUND

HQ-170A RX	189.00
------------------	--------

NATIONAL

NC-300 RX	129.00
-----------------	--------

HALLICRAFTERS

SX-111 Receiver	142.95
SX-115 Receiver	299.00

CLEGG

FM-27B FM XCVR 2M	179.00
-------------------------	--------

AUTHORIZED DEALER . . .

FOR OVER 50 MAJOR LINES .

NEW AND USED EQUIPMENT "Get on our used equipment mailing list."

TRADES WELCOME "The best allowances anywhere" "We buy good used SSB gear"

OUR EVERYDAY LOW PRICES "remain the same for cash or trade-ins!"

SAME DAY U.P.S. SHIPPING "Just a phone call away"

COMPLETE RADIO SERVICE SHOP "Mail Order Repair Service"

- Fast Efficient Service
- We Repair All Brands
- All Work Guaranteed
- Most Repairs Done and Shipped Within 7 Days
- Amateur Extra / First Class Licenses
- Include Manuals and Power Supply
- Send Us Your Defective Equipment Prepaid Shipping

OUR FINE REPUTATION SPEAKS FOR ITSELF . . . "YOU SHIP IT — WE FIX IT"

We Sell and Service the following New Equipment:

Alda	B & W	Drake	JW Miller	Mosley	SST Electronics	Vibroplex
Alliance	Callbook	DSI	KDK	Murch	Swan	Wilson
Ameco	CDE	ETO Alpha	KLM	PIPO	Telex	Wilson Commercial
ARRL	CES	Ham Key	Larsen	Robot	Ten Tec	Yaesu
Atlas	Covercraft	Hustler	MFJ	Rohn	Trac	
Benchner	Cushcraft	Hy-Gain	Microlog	Saxton Wire	Unadilla	
Bird	Dentron	ICOM	Mirage	Shure	VHF Engineering	

"We want your used gear! We Buy or Trade!"

✓ T34

THOMAS COMMUNICATIONS

95 Kitts Lane, Newington, Conn. 06111
"Near ARRL Headquarters"

Connecticut Residents Call: 203-667-0811
OPEN MON.-FRI. 10-6 • THURS. 10-8 P.M. • SAT. 10-4
EASY DIRECTIONS: Rt. 15 South — 2 blocks past McDonald's (Berlin Turnpike)

Call or Write for your super quote today!



WE EXPORT (Sub-Dealers wanted in foreign countries)

Sub-Dealer Inquiries Invited (Send Letterhead for Complete Package).

Power Line DXCC (Distant Control Circuit)

— The ac lines are already there . . .
why not use 'em for remote control?

Dave Brown W9CGI
RR5, Box 39
Noblesville IN 46060

I must first apologize somewhat for stealing this article's title from J. H. Everhart N2CX. His article, in the August, 1978, 73 Magazine, was entitled

"Power Line DX." But, I did not stop there! I stole even his circuits, almost intact. That, too, I must explain.

My intent is to praise him highly. The original ar-

ticle dealt with control of distant (DX) objects by remote control, via existing 60-Hz lines. He helped me by solving my worst problem in controlling my EME array, located on a tower building some 150 feet (by wire and zig-zag routing) from my basement ham shack. First, I built his circuits, and they worked—very well! Then I decided to lay out a PC board to speed matters up if I wanted more than one copy (I did). And then, I decided to do an article just for the PC boards, just to encourage others to try his methods—using his circuits—which, as I said, work very well indeed.

While laying out the first board and mulling over his idea for remote monitoring of his ham receiver, the way of laying out the PC boards shown in Figs. 1(a) and 2(a) evolved. Figs. 1(b) and 2(b) are just loading diagrams to hasten things along for you.

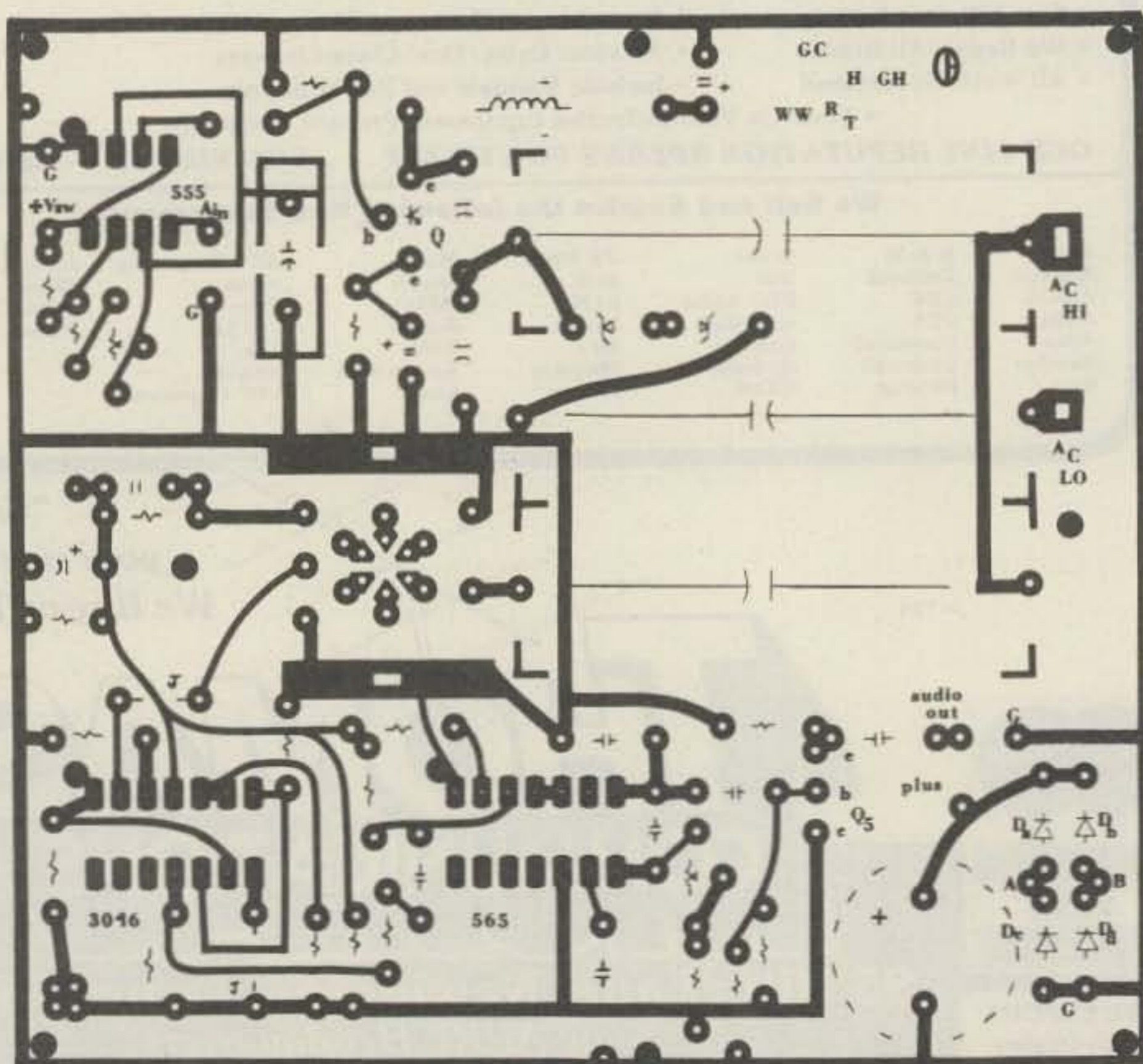

Fig. 1(a). PC layout, R/T board.

Fig. 1(a) is the PC board

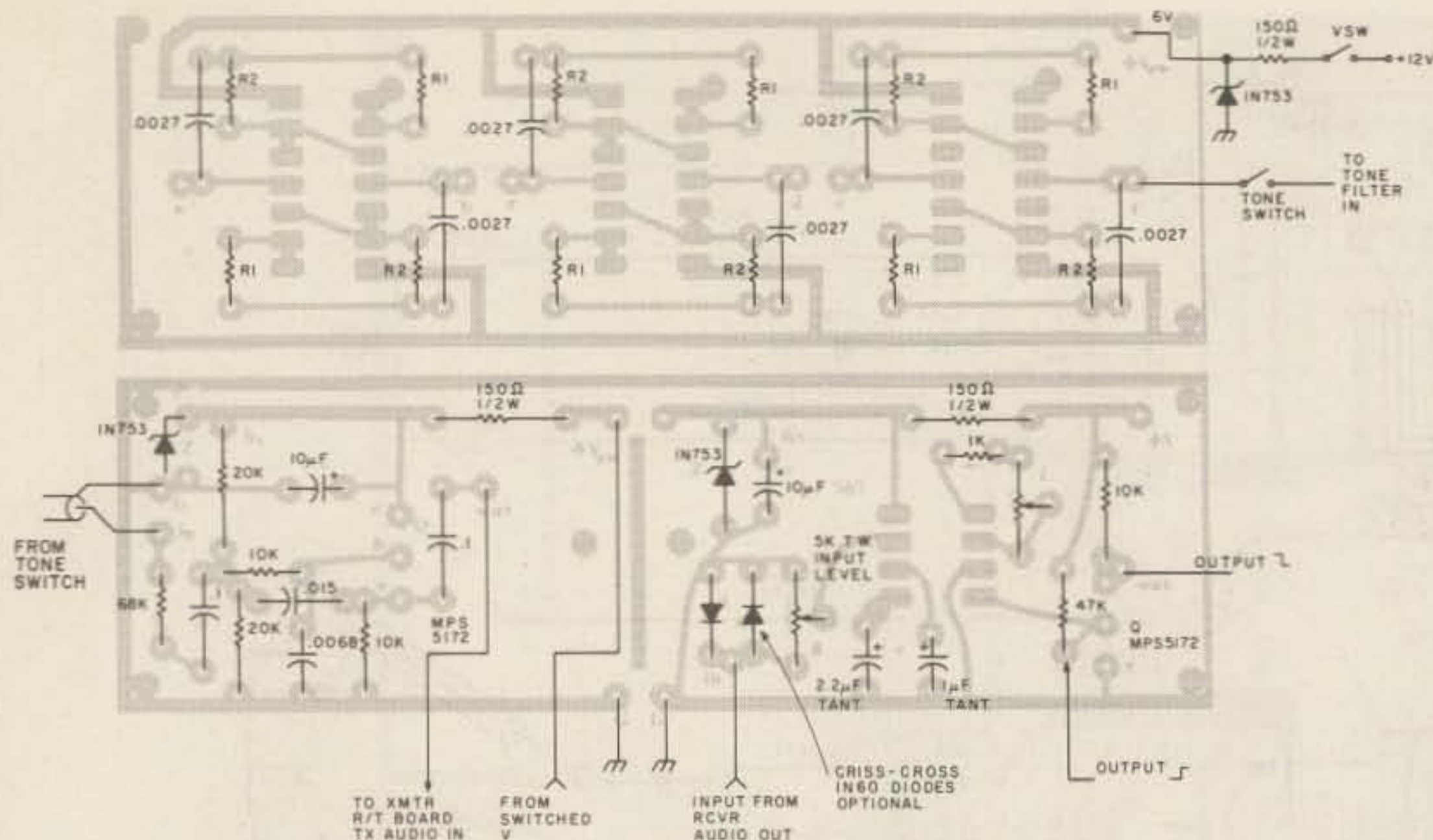

Fig. 2(b). Component layout, tone generator and audio amplifier/decoder-buffer boards (foil side view).

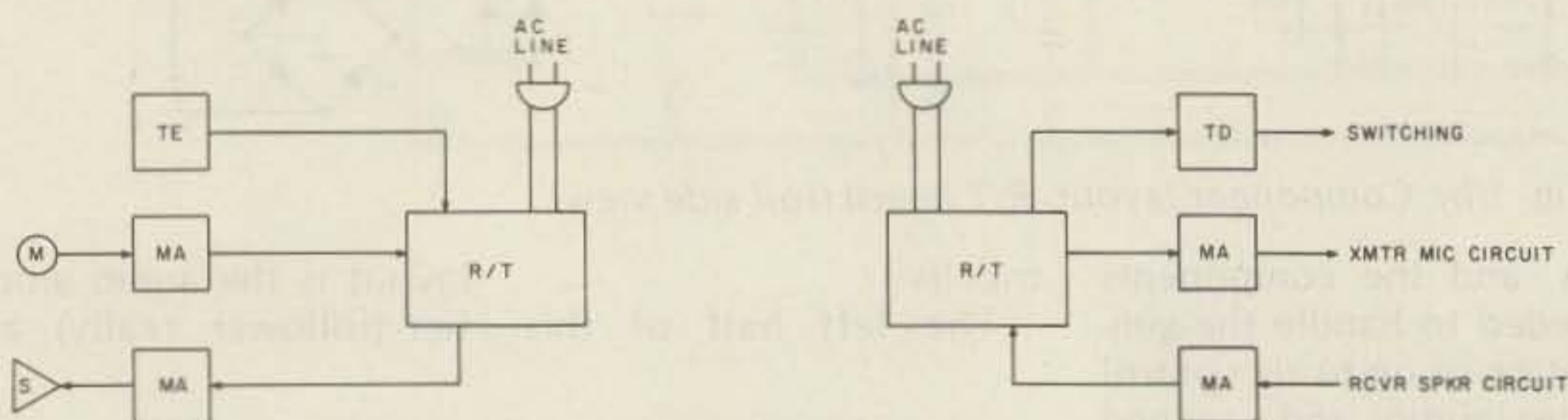

Fig. 3(a). M = microphone. S = speaker. MA = amplifier and matching transformer, if required. TE = tone encoder. TD = tone decoder. R/T = receiver/transmitter board (Fig. 1).

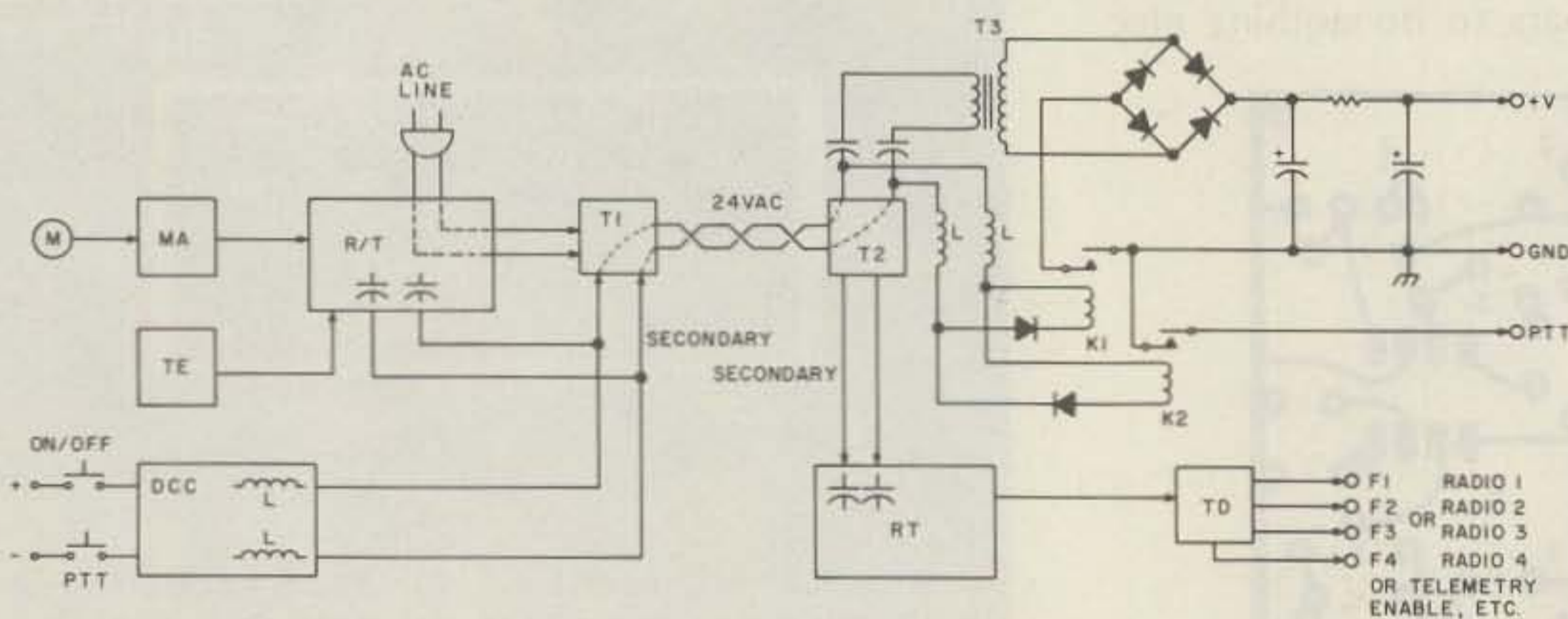

Fig. 3(b). DCC = dc control unit (as required).

X#	Tone	X#	Tone
L 1	69.7 kHz	H 1	120.9 kHz
L 2	77.0 kHz	H 2	133.6 kHz
L 3	85.2 kHz	H 3	147.7 kHz
L 4	94.1 kHz	H 4	163.3 kHz

Fig. 3(c).

the low-pass filter to follow the tone generators. It is shown as an MPS5172 in Everhart's article, Fig. 2, page 53. The right half of the board is all the circuitry to decode and/or buffer/invert a received tone. It

is the same type MPS5172 (Q6) and NE567 shown in his Fig. 5.

Once these Figs. 1 and 2 of my PC layout have been done in the photo negative stage, they may be cut apart and boards made in any combination or quantity. The PC board layout removes all the headaches and a lot of the work of this job, so I hope more of you will try N2CX's ideas.

I planned Fig. 1, the R/T

board, as a transceiver-type item, because I, too, would like to be able to monitor gear in the ham shack while I am in other parts of the house. I thought it would be nice to be able to have it a two-way circuit, as I'm sure many hams would. The end result of my efforts can be built into a small, attractive case with a carrying handle on it. This allows use anywhere in the house

or outbuildings where there is a wall outlet.

Build up two complete R/T units like that and you have one wireless intercom that can be carried about from room to room and plugged in, while the second unit babysits your child or your ham gear for you. The R/T board contains all the necessary components to take audio in and give rf output ready for, and attached to, the power line in transmit—and the same in reverse, in receive. All that is needed in addition is some obvious switching and an audio amplifier. This would boost up a microphone level that is too low (1.4 V required at the NE555 input) and a received audio that may be lower than you want. Then get the speaker and microphone of your choice.

I got around the latter by using an older Motorola speaker-microphone in one unit, with a coiled cord like those used on the FM handie-talkies. Use the small transformers shown to match up impedances where and when required by what you use. My audio amplifier was a 1- to 2-Watt per channel, with one IC that you often see in a child's record player of the less expensive variety.

To give you an example of how I use all this—I sample a small amount of audio from the speaker output lines through a shielded cable and feed it over to the one R/T board I have built into my audio control unit in my console. The audio unit allows me to add tones, touch-tones™, and the like to my rigs, and also has decoding for the receive side of things. By adding the R/T board to the unit, I now can place any of these tones, voice from the station microphone, or audio from the receivers into the transmitter portion of the R/T board and ship it anywhere on my property

where 120 V ac, 60 Hz is run.

Out on the remote end, where you have taken the R/T unit, this audio is taken back off the power line, decoded if required, and/or amplified up to speaker level. It has been a ham shack-to-garage and tower-house intercom, a control unit from shack to tower house for EME array control (a 150-foot unwired blessing), and even a two-way setup back to the woods almost half a mile away—where all I run out there is a low voltage, 24-V ac line to avoid electrical code (and cost) problems. See Fig. 3(b).

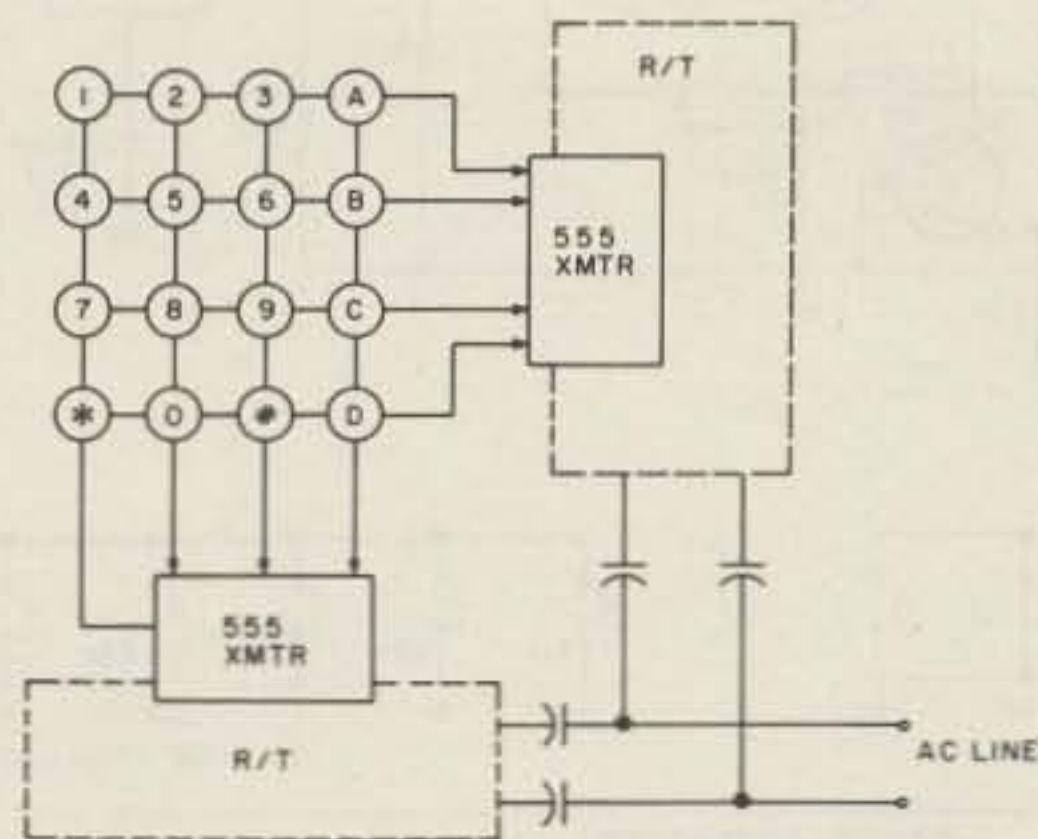

The two R/T units, in that case, are merely coupled into the 24-V ac secondary of the ham shack end and decoupled at the 24-V ac primary of the woods end. The woods-end transformer then transforms back up (to the 48 V ac I needed for a 30 V dc and allowing for line drop from the ham shack to the woods). Direct current control is sent down the same two wires for a one pair/three duties system.

My only concession in the R/T use was to utilize different rf frequencies each way, so that I can override receiver audio coming my way when I want to transmit either audio or a control tone. For monitoring the local repeater from anywhere in your house, it is great! A single tone is sent along with the microphone audio while you are transmitting. After the audio is demodulated from the rf carrier and leaves the R/T board at the ham shack end, it goes two ways. The audio goes through a parallel trap to reject the tone, to a one-stage audio amplifier (later found to be unnecessary), and, via a pot, to the microphone input circuit. The pot allows me not to have to change levels in

the radio or station microphone setup.

The second audio direction is for the tone; it is through a series pass filter, to reject audio and pass tone, and back to the one-tone filter and decoder you see in Fig. 2. That, in turn, when sensed and decoded, pulls in a relay and keys the transmitter. In the other direction, the audio mentioned earlier, from a receiver-speaker circuit, is coupled into the transmitter half of the ham-shack-end R/T board and put on the ac power lines. Back where I am (remote), the receiver portion of my R/T board demodulates the audio from the rf carrier, amplifies the audio, and presents it to me at the speaker.

I have added some complications since I want to monitor more than one radio and I don't just want to listen to noise at the remote end. On FM, that is not bad, as the radio has a squelch that keeps the audio off the transmitter input line of the ham shack R/T board, but I also monitor 50.125 MHz on SSB. To get around this, I have an audio-type squelch in the audio console that, when the radio speaks, keys a tone along with the audio

(sort of continuous-tone squelch style). When this tone gets to my unit (remote), it is handled just like the other direction, by splitting the audio and tone. The tone also lights an LED corresponding to what tone is controlled by which radio spoke. By using more than one tone at the remote end, I can control which radio I am putting the microphone audio into and keying. That about sums up one of my dandy uses, one of the reasons for writing this article, and the prime reason for my expanding it beyond just the PC board layouts.

I have changed some of the pin numbers of the ICs due to my board layout, so I have re-drawn the entire R/T board schematic as Fig. 4. The numbering on Fig. 4 and the layout now agree.

In the original article—in case they are not caught in the reader's column—let me say that there were a few errors and omissions. The pins on the "B" tone oscillator in Fig. 2 were omitted. I completely changed these, due to my layout, but in the original article, the left part should have inputs of 8 and 9 and an output of pin 10, and the right part, inputs of 12 and 13 and an output of 11.

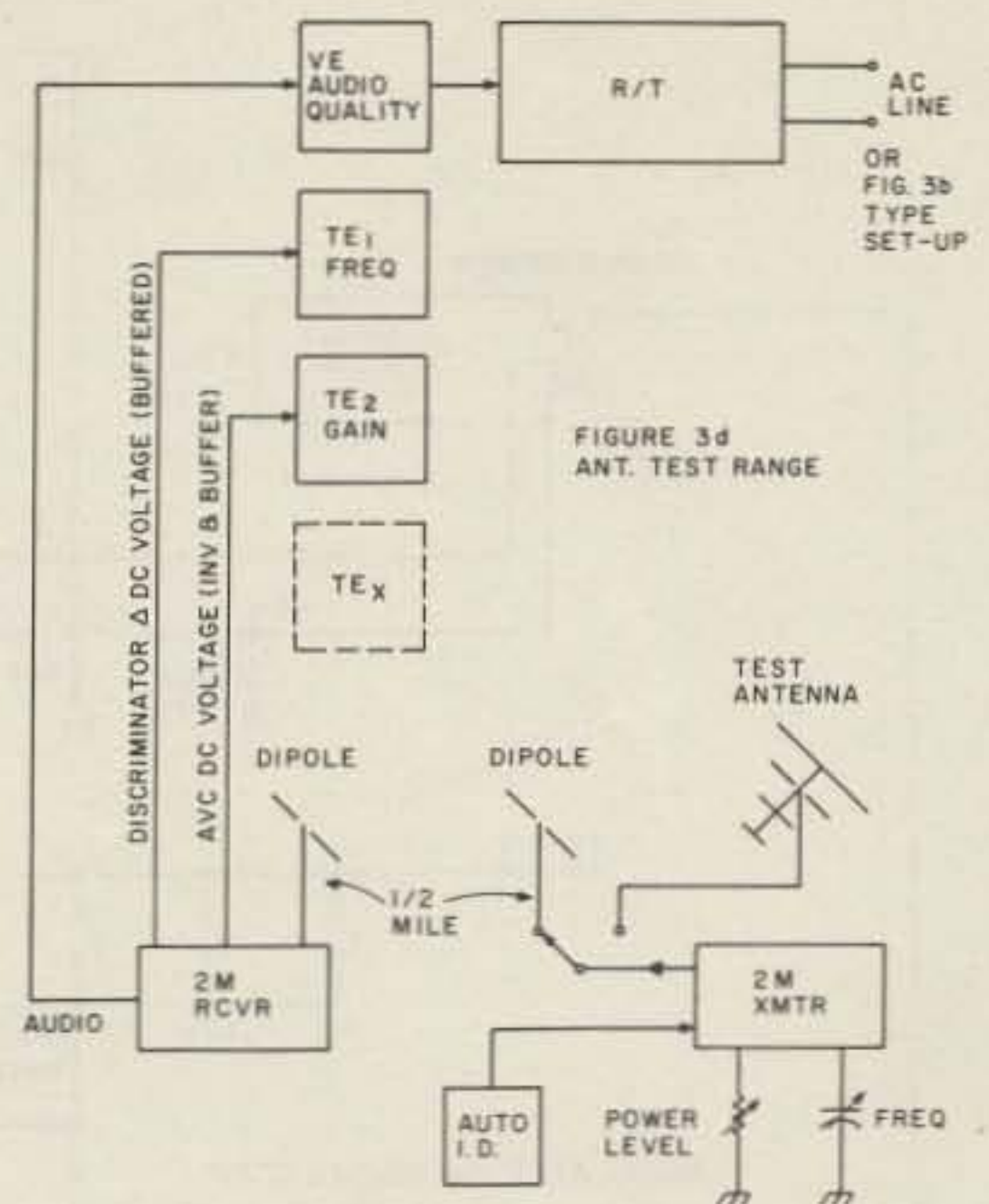

Fig. 3(d).

Left for right numbering can be traded, if it makes your wiring easier, but don't accidentally trade inputs for outputs.

The four parts of the IC are identical in operation. In the original Fig. 5, the ICs were labeled incorrectly as 576s. They are the familiar 567s. And while I am on the 567s, beware of too much tone input. 50 mV should be maximum, if you want to preserve any narrowband characteristics. Q5, in Fig. 4, can supply much more than that. I have added limiter diodes to the circuits and a level pot that you can adjust on the PC board. If you have tone-falsing and -failing problems, act accordingly.

One other comment on the original article. Fig. 6 shows how to re-wind the rf transformer. While this worked well, it was a lot of work. I allowed, on the PC layout, for you to use a much more common coil form put out by many vendors through most supply houses. Wind the transformer on it in exactly the same manner as shown in the original article, cover with a matching small i-f coil shield, and the results will be the same. I also left the coil pinout the same, so don't forget the jumper

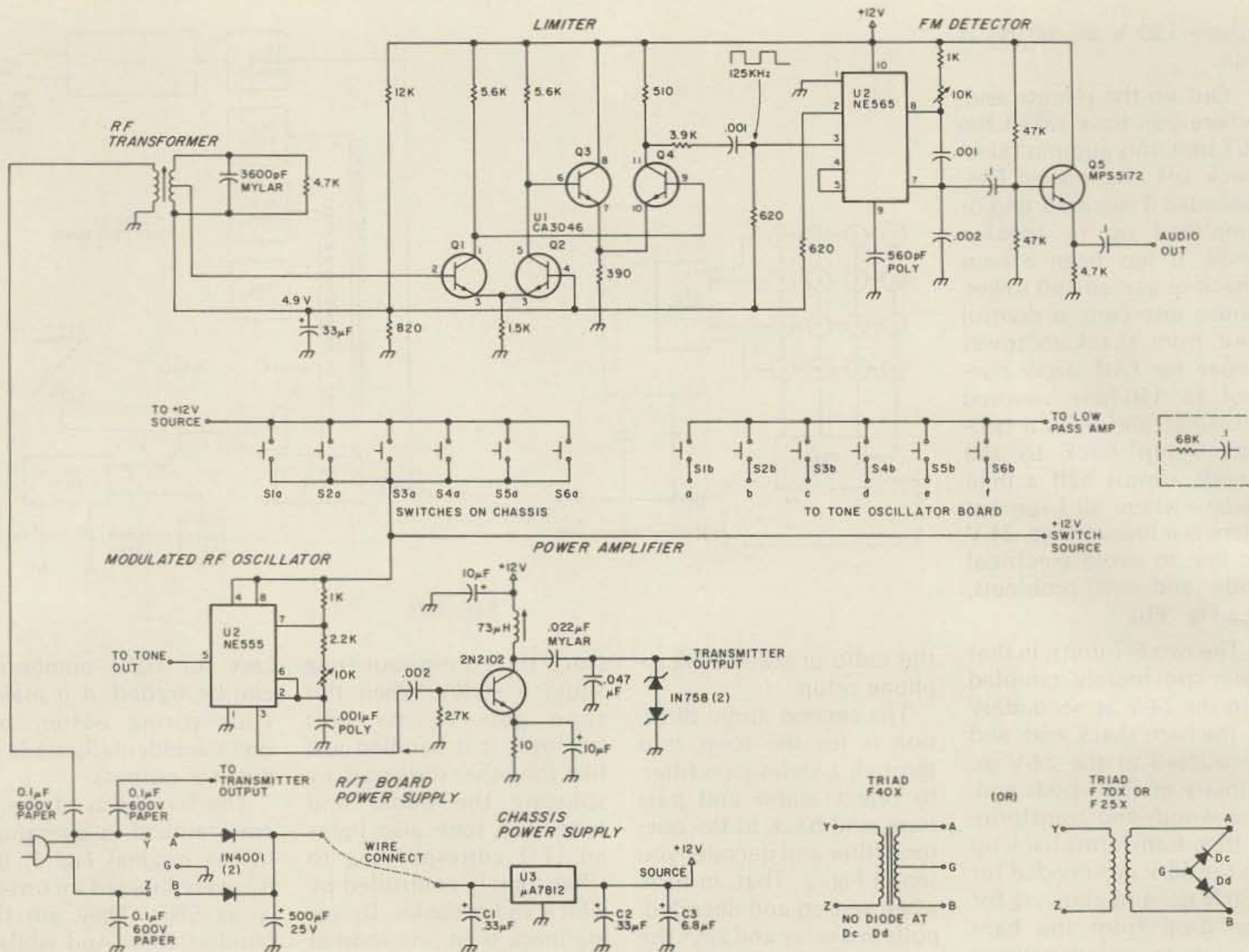

Fig. 4. Mount 7812 to chassis heat sink. Choose R2 and CX for desired tone. Recommended values are R2 = 100k pot and CX = .001 to .0047. Trim pot around center and change CX for coarse range.

wires (five are required) from the transformer base to each circuit. If any of the jumpers have to cross, be sure they are insulated wire.

I'll add in here a few useful notes on Fig. 3 concerning the hookups and the parts to use. Fig. 3(a) shows the simple form of wireless intercom unit used as a transceiver extension or remote. The mA units should be whatever matching transformers the microphone and speaker require to properly couple to the R/T board. The ham shack mA units are handled the same way, properly matching your rig with respect to microphone input and audio output (phones or speaker). Since this will vary so widely, I have chosen only to block-diagram it. Keep it as sim-

ple as possible at first, until you see what you really must have. For example, use a .1 capacitor from the speaker line to the R/T unit and from the radio audio gain-control to control-level. Add a pot for level later, and/or come off ahead of the rig gain control, to allow a quiet rig in the house with the XYL while you monitor from out in the garage or wherever you might be. Then add the audio amplifiers where required. There are many cases where audio amplifiers might not be needed at all.

Fig. 3(b) is a special case. I have found it very useful to reduce wiring between two points when there is *not* already a 120-V ac, 60-Hz line. See Fig. 3(b). If you run a safe wire, like rotor cable with good

insulation, not many codes would prohibit such an installation. If 120-V ac wiring were run, all kinds of codes, regulations, electricians, and costs get into the act!

Skipping over Fig. 3(c) for a few paragraphs, since it is really a part of Fig. 3(d), Fig. 3(d) concerns a special situation not covered in Fig. 3(b). It allows a simple, remote transmitter-receiver pair to be located remotely from the ham shack/antenna location. The remote site then forms the heart of my antenna test range. Provisions are made for voice to return back over the wired circuit for both checking audio quality and intercom use when someone is at the remote site. Next, one channel (rf) of the wired remote is wired to use the

buffered dc voltage from the receiver's discriminator (the VHF receiver). The buffer also shifts the level to allow direct use with the 555-modulation pin (all positive voltages), by shifting the discriminator minus 6 - 0 - plus 6 V dc (approx.) over to a 9- to 11-V dc shift. When the receiver is right on, the 10 volts then represent 0 V at the discriminator. Since the transmitter end (VHF) is where you are, the frequency is used to be sure you are sending right in the center of the receiver's (VHF) passband, where the receiver has been aligned, calibrated, and measured. That is, uV antenna strength equals some arbitrary avc reading, recorded. You use your reference dipole—see Fig. 3(d)—to

TONE LOW PASS AMP

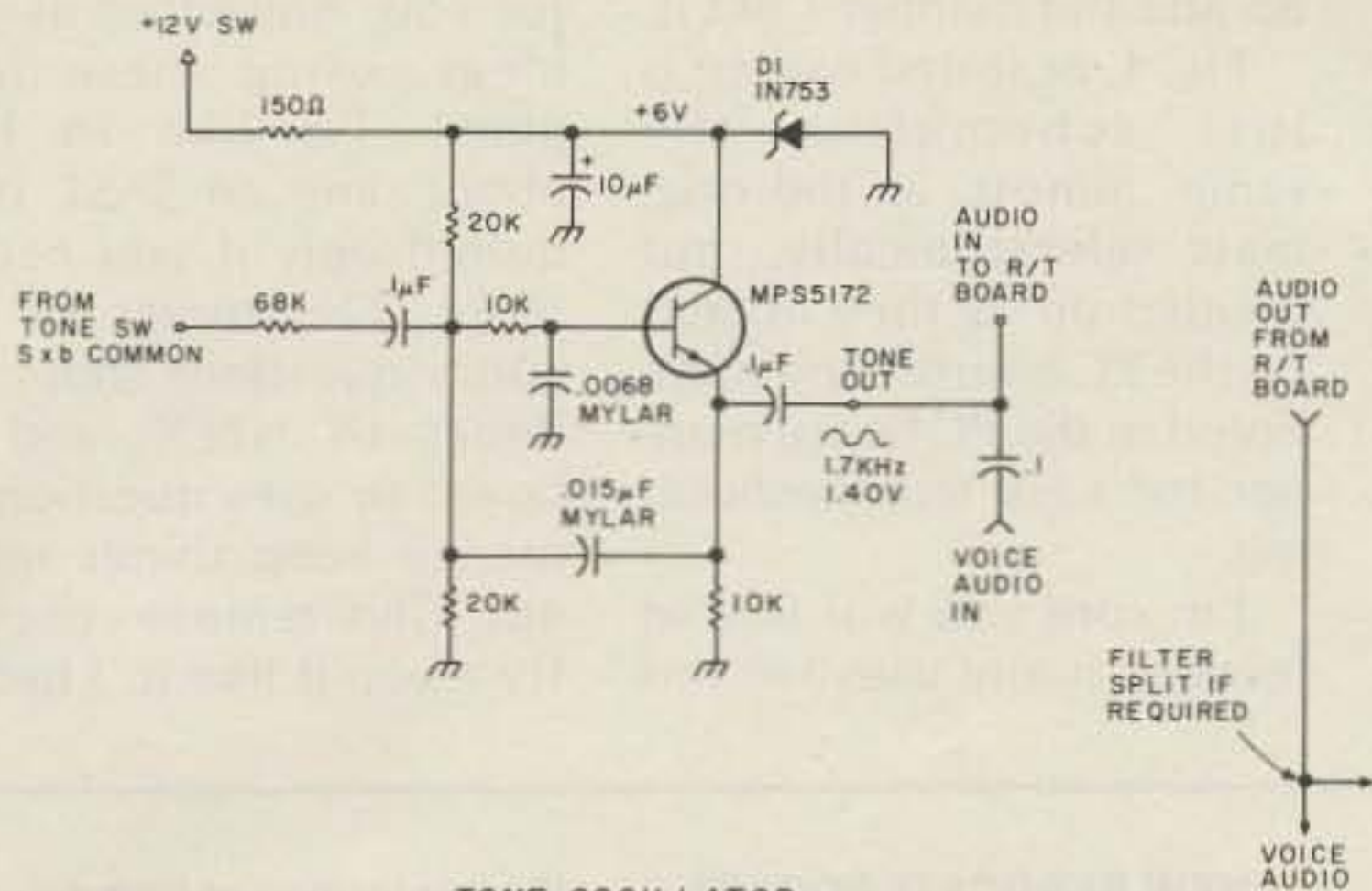

TONE DECODER

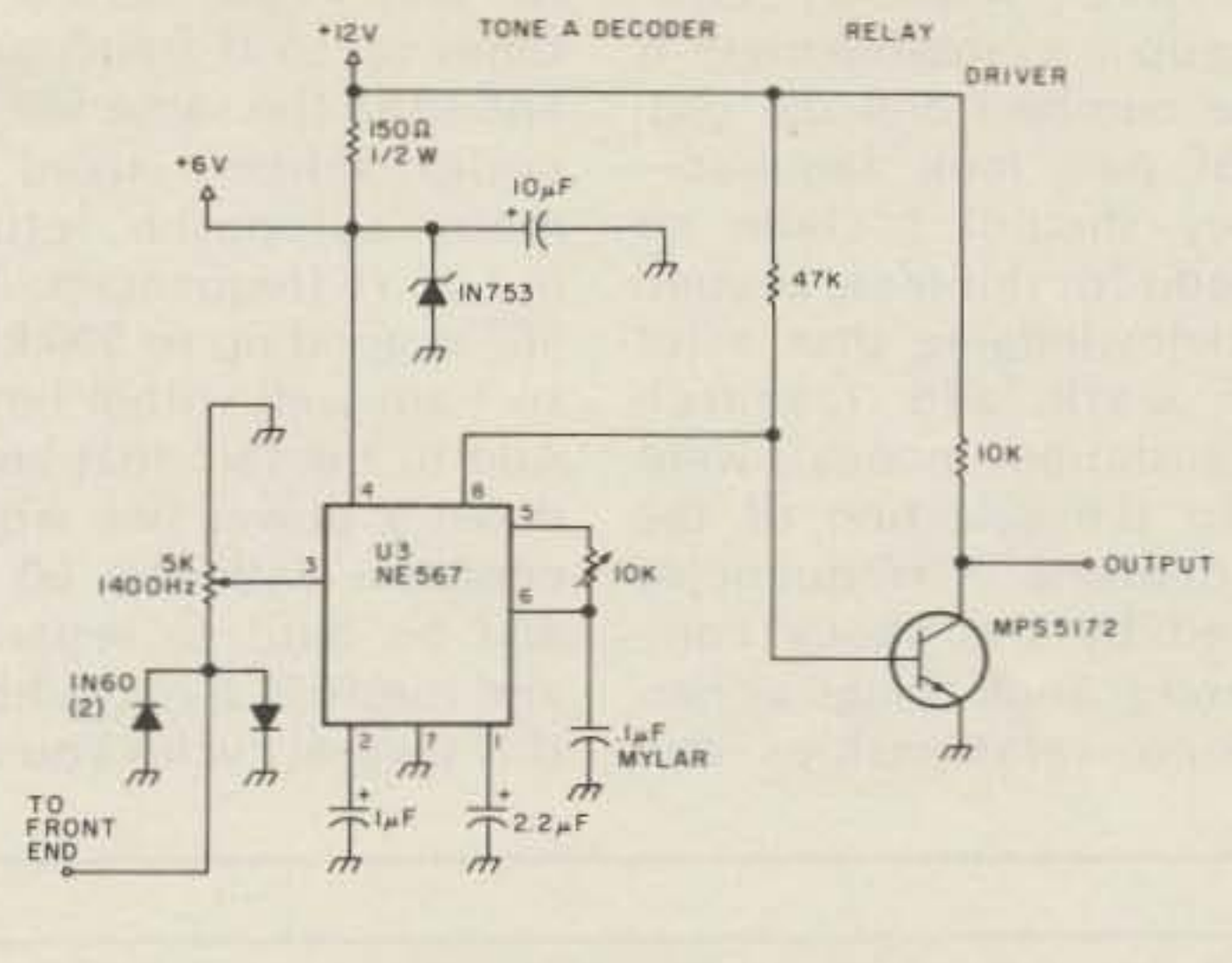

TONE OSCILLATOR

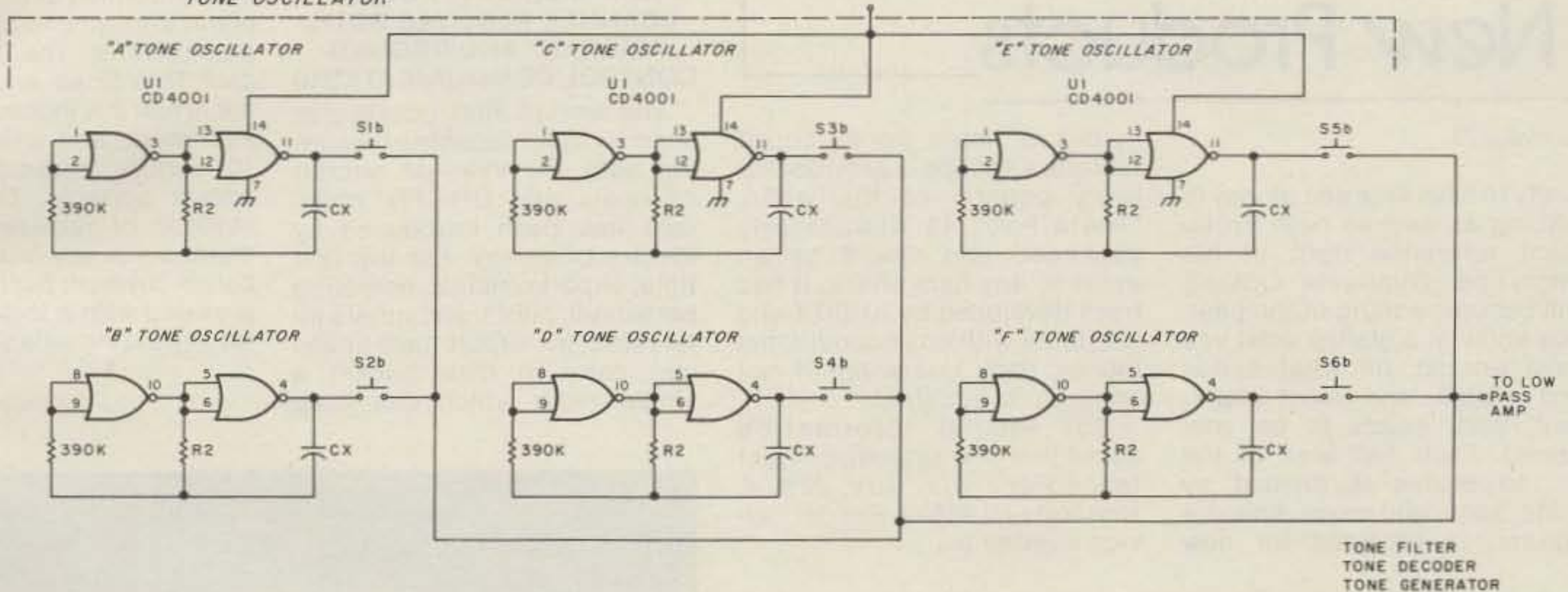

the remote-site dipole first each time, and if the frequency reads all right, then any differences should be in the path (not likely at 1/2 mile, but weather affects it some) or in the receiver itself, due to some factor such as temperature or aging. Then you proceed with your test antenna, compared to previous antennas, and the reference dipole using the avc voltage reading on a separate rf-wired channel.

Using the separate wired channels of rf allows continuous monitoring of all, simultaneously. I intend actually to monitor three voltages (plus frequency) in this measurement, along with a low-power transmitter whose output I can both accurately measure and vary continuously from 1 to 10 Watts. The remote receiver can be any FM unit on the frequency

of your antenna interest, but preferably solid state to reduce power consumption on your 24-V ac line out to the site. Then you measure and send back (by three rf channels) the two limiter and avc readings.

By varying the transmitter level, you can keep the receiver down out of limiting where the avc is linear or, at least, repeatable. Remember, you are not trying to recover audio from the VHF transmitter at this point, but only to compare the signal strength of two antennas: the reference dipole vs. your new model. The range is approximately 1/2 mile, or 2640 feet, or 417 wavelengths on two meters, and gets better as you go up in frequency. This keeps reflections and stray ground clutter to a minimum, as

well as allowing you to plot your antenna, and any stray lobes, accurately. You require only a well-calibrated antenna rotor and readout. My remote site is due east (90 degrees) from me; that becomes 0 degrees on the antenna plot. The north rotor stop is a pain you live with, but I avoid extra work by starting at 270 degrees plot (due north—compass) and plotting around through straight at the site and through 360 degrees in 5-degree increments.

If you try this kind of work, always allow a full 360 degrees around—and then back in 5 degree increments. Trying two or three such trips and averaging the results is even better. This allows for any rotor over-travel or coast when stopping. Whatever you do when comparing antennas, or how you do it, never—

repeat *never*—believe the reports of signal strength changes from antenna to antenna that you get from another station. Modulation, keying, etc., is all right, but unless you like to climb towers, changing antennas back and forth and never seeming to get anywhere, stick with a measured system. This is not to say you can never have another amateur whose setup and serious attitude matches your own or the level of confidence you want, but to suggest you don't buy the casual-type observer. He may have changed rigs, antennas, and use his deaf ear for an S-meter! Why do you think I went to the trouble of a range?

Fig. 3(c) was thrown in to show how I can control 16 channels of rf using only eight frequencies and up to as many audio tones as you

can discriminate between or use without ending up in a crossfire mess. If the numbers and the control pad look familiar—they should! I claim no credit for this idea, beyond acknowledging that a lot of work and research (translation: money!) went into the selection of the touchtone™ frequencies used by the phone companies. Such things as harmonic relationships and

beats were all thought out for me; I just shifted the tones up to rf frequencies and used the same 567 decoder scheme used by many autopatch setups, but at rf frequencies. The 567 is good up to 500 kHz, so I am well within limits. Add to the fact that audio down a power line would compete with the 60 Hz and be hard to separate, and the 10% bandwidth at rf is several cycles you can

easily zero in on versus a few cycles at audio, and you realize why the shift up and the manner I did it.

Fig. 4, as stated earlier, is just schematics—the same, almost, as the originals electronically, but divided up as they appear on the PC boards and numbered in the PC board manner for easy troubleshooting.

I'm sure you will find at least as many uses for this

terrific circuit combination as I did, so I hope the PC boards make it a lot easier for you. Any other uses or ideas using these little gems I'd like to hear about, and an SASE is required only if you need a reply. Electronics or circuitry questions should go direct to N2CX, and PC board or uses questions to me, to keep things sorted out. Give remote control a try—you'll like it, I bet! ■

New Products

from page 24

tunity to save time and money in QSLing as well as have an instant reference right at his fingertips. Duplicate QSLing will become a thing of the past. You know at a glance what you have worked, on what bands and modes, and, most important, what needs to be confirmed. Each call area of the United States is divided by state, band, and mode. An extra column is provided for new

modes or notes. As an added feature, a section is provided for every country of the world. "Insta-Pac" is attractively packaged and would be an asset to any ham shack. It has been developed by KH6ITY and is offered with an unconditional money back guarantee if not completely satisfied.

For further information about this new system, contact Insta-Pac, PO Box 22974, Honolulu HI 96822. Reader Service number 143.

NEW BEARCAT® POCKET SCANNER RECEIVES BOTH AIRCRAFT AND GROUND-CONTROL COMMUNICATIONS

The world's first pocket-size scanner radio capable of receiving both the VHF-AM aircraft channels and UHF-FM channels has been introduced by Electra Company. For the first time, airport officials, operating personnel, pilots, and others interested in airport operations can carry in their pocket a single radio which can keep

them informed of both tower-to-plane and ground-control communications. The new "Bearcat® Thin Scan Aircraft" scanner is just 2¾ inches wide and 1 inch thick, and weighs a mere 10 ounces, making it a true pocket portable. The radio is capable of receiving up to 4 channels in any mix of the two bands covered. Each channel is provided with a lockout control for bypassing when desired.

Continued on page 157

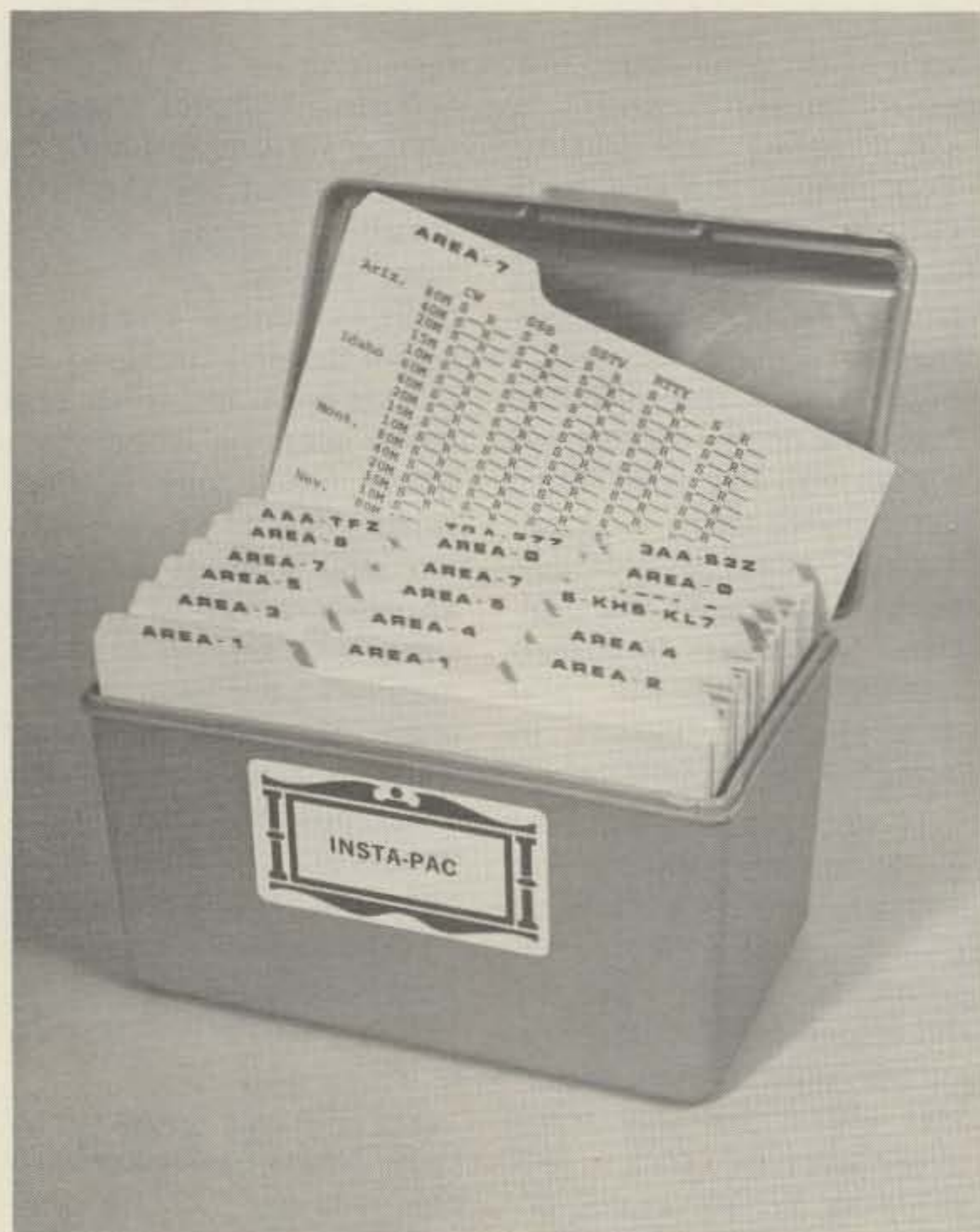

The Insta-Pac.



The Bearcat® Thin Scan Aircraft scanner.

The **FIRST** choice by amateurs the world over!

Vhf engineering **REPEATERS**

4 MODELS TO CHOOSE FROM:

RPT 50	50 - 54 MHz
RPT 144	144 - 148 MHz
RPT 220	220 - 225 MHz
RPT 432	420 - 450 MHz



AVAILABLE ONLY AT THESE AUTHORIZED DEALERS

CALIFORNIA

C & A Electronic Enterprises, Carson, CA 90745, Ph. 213-834-5868
Tele-Com Electronics, San Jose, CA 95124, Ph. 408-377-4479
Westcom, San Marcos, CA 92069, Ph. 714-744-0700
Zackit Corporation, Vallejo, CA 94590, Ph. 707-644-6676

COLORADO

A.E.S. Communications, Wes-Com, Colorado Springs, CO 80909,
Ph. 303-475-7050

CONNECTICUT

Thomas Communications, Newington, CT 06111, Ph. 203-667-0811

FLORIDA

Amateur Electronic Supply, Orlando, FL 32803, Ph. 305-894-3238
N & G Distributing, Miami, FL 33126, Ph. 305-592-9685
VHF/JAX, Orange Park, FL 32073, Ph. 904-264-7176

GEORGIA

Repeaters Unlimited, Div. of Creative Electronics, Marietta, GA
30065, Ph. 404-971-2122

ILLINOIS

Klaus Radio, Peoria, IL 61614, Ph. 309-691-4840
Spectronics, Oak Park, IL 60304, Ph. 312-848-6777

IOWA

Bob Smith Electronics, Fort Dodge, IA 50501, Ph. 515-576-3886

MARYLAND

The Comm Center, Inc., Laurel, MD 20810, Ph. 301-953-9541

MASSACHUSETTS

Tufts Radio Electronics, Medford, MA 02155, Ph. 617-395-8280

MICHIGAN

Harry Crofts Electronics, Northville, MI 48167, Ph. 313-349-0176
The Ham Shack, Kentwood, MI 49508, Ph. 616-531-1976

MINNESOTA

PAL Electronics, Minneapolis, MN 55412, Ph. 612-521-4662

MISSOURI

Alpha Electronic Labs, Columbia, MO 65201, Ph. 314-449-1362

NEBRASKA

Communications Center, Lincoln, NE 68504, Ph. 402-466-3733

NEVADA

Communications Center West, Las Vegas, NV 89106, Ph. 702-647-3114

NEW JERSEY

C. H. Electronics, Inc., Clifton, NJ 07011, Ph. 201-478-9700

NEW YORK

Barry Electronics, New York, NY 10012, Ph. 212-925-7000
Com-Tech Electronics, Rensselaer, NY 12144, Ph. 518-477-8461
Delmar Electronics, W. Babylon, LI, NY 11704, Ph. 516-420-1234
VHF Communications, Jamestown, NY 14701, Ph. 716-664-6345

OHIO

Universal Amateur Radio, Reynoldsburg, (Columbus) Ohio 43068,
Ph. 614-866-4267

OKLAHOMA

Derrick Electronics, Broken Arrow, OK 74012, Ph. 918-251-9923

PENNSYLVANIA

LaRue Electronics, Scranton, PA 18509, Ph. 717-343-2124

SOUTH CAROLINA

G.I.S.M.O., Rock Hill, SC 29730, Ph. 803-366-7157

SOUTH DAKOTA

Burghardt Amateur Center, Watertown, SD 57201, Ph. 605-886-7314

TEXAS

AGL Electronics, Dallas, TX 75234, Ph. 214-241-6414
Madison Electronics Supply, Houston, TX 77002, Ph. 713-658-0268

VIRGINIA

Radio Communications, Roanoke, VA 24016, Ph. 703-342-8513

WASHINGTON

A-B-C Communications, Seattle, WA 98155, Ph. 206-364-8300

WISCONSIN

Amateur Electronic Supply, Milwaukee, WI 53216, Ph. 414-442-4200

CANADA

Bytown Marine Ltd., Ottawa, Ontario, Can. K2H 7V1, Ph. 613-820-6910
Traeger Distributors, Richmond, BC, Can. V6X 2A7, Ph. 604-278-1541

Vhf engineering
DIVISION OF BROWNIAN ELECTRONICS CORP.

✓V5

Blueprint for Biofeedback Experimentation

— fertile ground for pioneers

The idea for this article came from an experiment into the capabilities of human movement and control. The main question was how it would be possible for a person to control electrical devices and effectively communicate without movement of any kind. This restriction included the use of speech, sound, or any alteration of respiration.

Upon first consideration it seemed an impossible task, as the only apparent control would be over thought. This is where the idea of control by brain-wave came to mind. No, I'm not talking about ESP or psychokinesis, but biofeedback. Biofeedback is the process of monitoring and controlling certain body functions... in this case, alpha brain waves.

The main purpose of biofeedback is to provide greater relaxation and

creativity by controlling certain types of brain waves. In this article, we will be concerned with alpha waves.

A device called a "biofeedback monitor" is used to amplify and detect alpha waves in much the same way as an electroencephalograph. A band containing electrodes is fitted around the head, and when the brain is producing an abundance of alpha waves, the monitor gives indication with a tone or light. By learning to control the tone or light, you learn to control your alpha waves.

At this point, I'm sure you are beginning to see the *modus operandi* of the alpha control. Fig. 1 shows a simple block diagram demonstrating the basic principles involved. In this diagram, a photocell light and its counterpart, a tone-voice-operated micro-

phone, are used to show a working system in its simplest form.

While the system described would work, it was not made to replace electronic switching and logic circuits, which would be more accurate. Schematics for an actual control circuit have been omitted, as the design and construction would vary greatly with the type of monitor output.

There are three major types of outputs used in the majority of monitors. They are: threshold tone, frequency-modulated tone, and light or LED indicator.

As for the monitor itself, you can get it pre-assembled or in kit form. There are models with simple one-mode outputs and ones with more complex multi-mode outputs. The range of control can be increased by the addition of a transmitter connected to the

monitor and a receiver connected to the actual control circuit. A wireless microphone and receiver would work nicely, and possibly allow the utilization of existing equipment.

The next logical step would seem to be to develop a means of controlling more than one device. One possible but untested idea would be the use of a row of lights that would flash in sequence, somewhat like a public band scanner. By having the lights represent controlled devices, or letters, any number of appliances might be controlled simply by stopping the scan on the desired light and device it represents. Of course, the speed in which one could control his alpha waves would be a factor in the speed of the scan. In such a manner, a person totally paralyzed could communicate and, to some extent, control his environment.

It has been my honest effort to present these ideas in more than the light of a laboratory or scientific curiosity, and I now leave further experimentation and development to your able ingenuity. ■

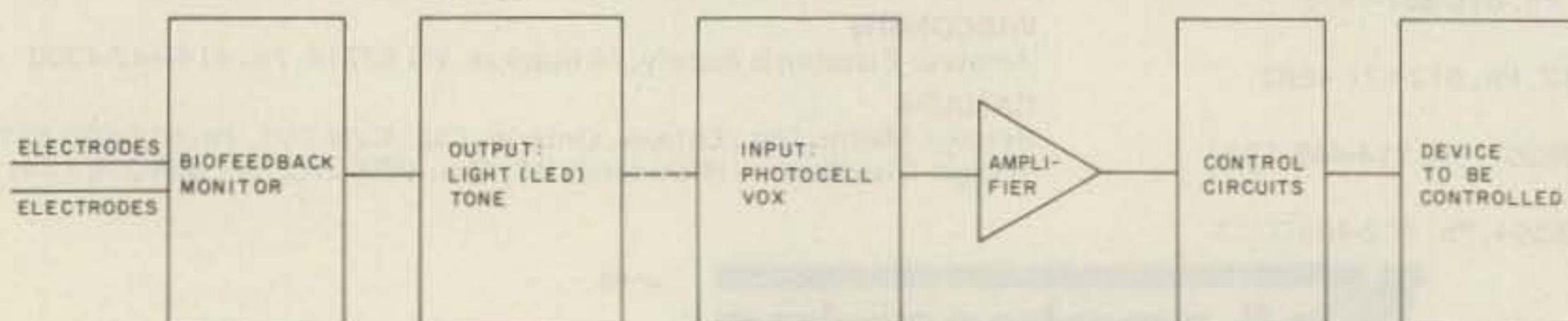

Fig. 1.

The Scanning Memorizers



FT-127RA
(220 MHz)

FT-227RB
(144 MHz)

FT-627RA
(50 MHz)

The FT-127RA, FT-227RB and FT-627RA, FM transceivers, allow scanning and expanded memory coverage for the demanding VHF FM operator. All feature up/down scanning capability with control from the microphone; the scanner will also search for a busy or clear channel. Four memory channels are available — two for simplex, three for repeater channels, one for a split of up to 4 MHz. Other performance features are similar to those of the renowned FT-227R.

OPTIONAL EQUIPMENT

Keyboard Microphone: YM-22 for FT-127RA and FT-627RA
(YM-22 standard feature with FT-227RB)
Squelch Unit • FP-4 AC Power Supply

CPU-2500R/K 2 M FM Transceiver with Central Processing Unit

The age of computers has entered the amateur scene with the announcement of the CPU-2500R/K 2-meter FM transceiver. Controlled by a 4-bit central processing unit (CPU), the CPU-2500R/K contains a scanner, 4 memory channels, manual or automatic tone burst, an optional sub-audible tone squelch, and 25 watts output.

The keyboard microphone allows two-tone input for autopatch or control purposes, as well as remote programming of dial or memory frequencies.

Automatic ± 600 kHz repeater split, or program a split up to 4 MHz using the memory. Keyboard microphone allows remote programming of odd splits.

CPU scanner will search for a busy or clear channel, upon your command.

Four memory channels for simplex or repeater use, plus another memory channel for a split of up to 4 MHz.



879

YAESU ^{Y1}
The radio.



YAESU ELECTRONICS CORP., 15954 Downey Ave., Paramount, CA 90723 • (213) 633-4007
YAESU ELECTRONICS Eastern Service Ctr., 9812 Princeton-Glendale Rd., Cincinnati OH 45246

The History of Ham Radio

— part X

Reprinted from QCC News, a publication of the Chicago Area Chapter of the QCWA.

The Second Radio Telephone Conference, called by Secretary Hoover, convened on March 20, 1923, to solve the deplorable situation brought about by the controversy over wavelength assignments. Broadcasters, the amateurs, the Army and Navy, the ship operators, and the commercial interests could not come to a common agreement as to wavelength allocations and thereby avoid woeful interference. Clearly, from an administrative standpoint alone, the broadcast listeners were desperate. The impasse which existed required a solution.

After several months of meetings, serious discussions, and lengthy deliberations, not even the amateurs had guidance or a clear go-ahead on how to interpret their standing with the Commerce Department. The American Radio Relay League had made a series of suggestions. The amateurs in all parts of the

country, now almost 21,000 in number and licensed to operate in the narrow 200-meter range, found solace in the fact that they had pooled their ideas and suggestions through their re-

spective district directors.

The ARRL Board of Directors based high hopes on all of these inputs. So, when recommendations were issued on June 28, 1923, by the Department of

Commerce in the form of General Letter #252, directed to all government district radio inspectors, they read as follows:

General Letter #252

"General and Restricted Amateur Radio Station Licenses will be issued permitting the use of any type of transmitter (CW, spark, ACCW, ICW, SC, and phone) with the restriction that when using pure CW, they are authorized to use wavelengths from 150 to 200 meters. When using spark, ACCW, ICW, unfiltered SC, and phone, the wavelengths from 175 to 200 meters only can be used. The types of transmitters must be specified in the application and the license.

"Special Amateur Radio Station Licenses will be issued permitting the use of pure continuous wave transmitters only, authorizing the use of wavelengths from 150 to 220 meters.

"For the purpose of application of Amateur Stations, pure CW is defined as follows: A system of telegraphing by continuous oscillations in which the power supply is substantially direct current as obtained

C.W. Licenses

DO you fellows know that your station license provides that the apparatus described in the application shall not be changed without permission? And that a license granted a spark station is not good for the use of C.W. equipment? It sounds queer, considering that any complaint ought to prefer a tube set to a spark, but if anybody wants to "get" you on it they can.

A broadcast listener recently filed a complaint with a radio inspector against a well known eastern spark amateur, alleging the use of an illegally broad and too-long wave. Called upon the carpet, there was no evidence that his spark, which was good as such animals go, was not entirely legal. But he volunteered the information that he was experimenting with C.W. anyway and the interference probably would be still further reduced. Whereupon, altho his spark set was O.K., he was informed that the use of C.W. was in violation of his license, and it was suspended for three months.

Moral: If the equipment you are using is greatly different from that for which your license was issued, take up the matter with your Inspector and "get right."

QST - March, 1923

from (1) a generator, (2) a battery, or (3) a rectifier with an adequate filter. (A filter is not deemed adequate if the supply modulation exceeds five percent.)

"On licenses issued for Amateur Stations you will include the following: 'This station is not licensed to transmit between the hours of 8:00 and 10:30 p.m., local standard time, nor Sunday morning during local church service.'

"Special Amateur Stations must be operated by persons holding an extra first class grade Amateur operator's license, or a commercial extra first class operator's license. Applicants must also meet the requirements of Regulation 63.

"A new class of Amateur operator's license is hereby established, to be known as 'Amateur Extra First Grade.' Licenses of this grade will be issued to persons passing the required special examination with a percentage of at least seventy-five and code speed in sending and receiving at least twenty words per minute, five characters to the word; who have had at least two years experience as a licensed radio operator; and have not been penalized for violation of the radio laws subsequent to the date of these regulations."

The government supervisors, located in the several United States radio districts, upon receiving the new regulations, were requested to notify all amateur radio licensees, general and restricted, to submit their respective license papers to the supervisor's office and have them modified in accordance with the new regulations. After they were so certified with a copy of the new rules appended, they were returned, officially endorsed, extending the wavelengths range and specifying the quiet hours. No changes

were made in their expiration date.

All amateurs who held special licenses were notified that their licenses were cancelled and new licenses would be issued in accordance with the new permits now granted. Up to the present, all amateur licenses were issued specifying the wavelength of the operating transmitter to be used. From this date on, a license permitted a station to change the operative wavelength to accord with the bandwidth permitted and as the type of emission specified.

Variable frequency transmitter circuits were not generally known among amateurs. The progress of the art and the know-how was still lacking in 1923 in this respect. Even the well-informed and up-to-date amateur solved the changing frequency problem by having more than one transmitter available, usually a pure CW of low power and another with either ICW or ACCW plate supply. Every license issued by the Commerce Department required that the licenses specify not only the wavelength limits of the transmitter, but also the emission type and the apparatus to be used including the antenna length and construction. If an amateur qualified as an extra grade operator, he could apply for two licenses, a special and a general. The special was then given a "Z" call.

The ARRL had recommended that the amateur with two years of experience and a twenty-words-per-minute code speed be issued an extra first grade amateur operator's license using a wave transmission length up to 220 meters. (Even at this date all authorities assumed that this stipulation was a decided advantage for DX.)

It also was understood that transmissions on wave-

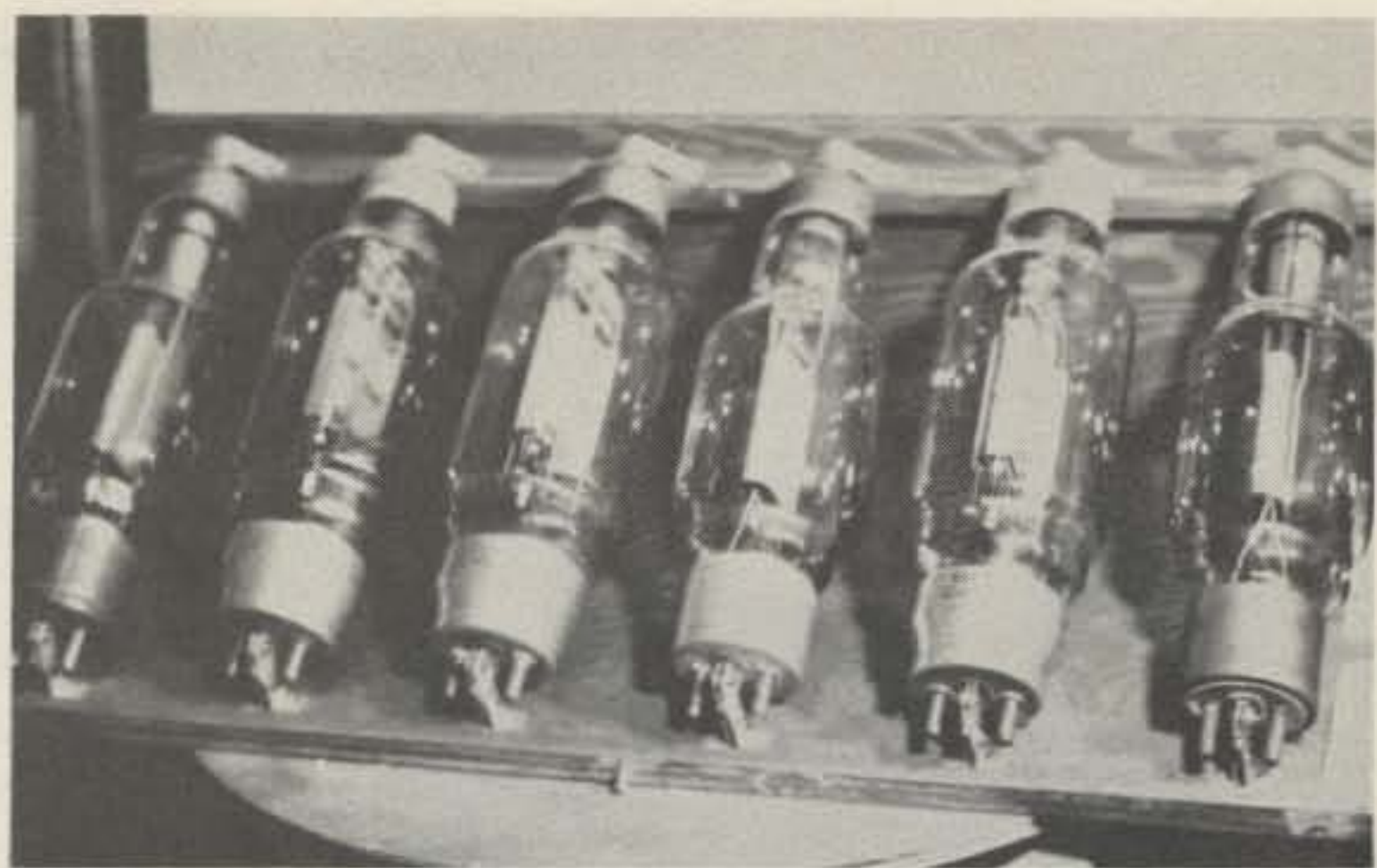

Fig. 1. The 250-Watt UV204.

lengths other than 200 meters by the amateurs could be allowed on the issuance of a license specifically noted on the application. A second wavelength, perhaps somewhere between 175 to 180 meters, could be granted. The 150 to 220 meter band specified in the 1923 Regulations gave the Secretary authorization to grant licenses upon request provided the amateur could meet the stipulated requirements and so requested in his application.

How the Need for "Plate" Power Was Met

In the early wireless days, the conversion from simple spark coil to high voltage rotary-gap transmission was not difficult. But going over to the vacuum tube for CW operation was by no means an overnight accomplishment. To put continuous wave power into the antenna, the amateur initially had available a small amplifier tube and a larger five-Watter, known as the UV202. Subsequently the fifty-Watt 203 was available, followed soon by the 250-Watt UV204, a real "power-house" for most DXers (Fig. 1).

With the introduction and development of the power tubes, there naturally was need for a direct current supply to energize the plate circuit. Much of the spark gear the amateur had accumulated and used for

a power source was now destined for the surplus stockpile. The new regulations specified pure CW or nearly so, and this necessitated some type of direct current source, often up to several thousand volts. Various methods to obtain this voltage were outlined in the ham literature: (1) a motor generator, or (2) a battery, or (3) a type of rectifier with filter. Much experimenting took place. This voltage was referred to as the "B" voltage supply.

The Motor Generator

Although not the most practical source of high voltage dc nor the least expensive, a generator was the easiest and simplest way to quickly come up with plate power of one- to two-thousand volts. The ESCO machine from Electric Supply Co., of Stamford CT, could be found in many ham shacks. Early commercial broadcasters also used this equipment. However, the supply required filtering to reduce the ripple modulation to a point where it would meet the specified five percent. Using a motor generator required ac starting controls, considerable power wiring, and usually a remote and out-of-the-way installation of the entire unit to reduce hum and noise when operating voice modulation. Weight and expense were

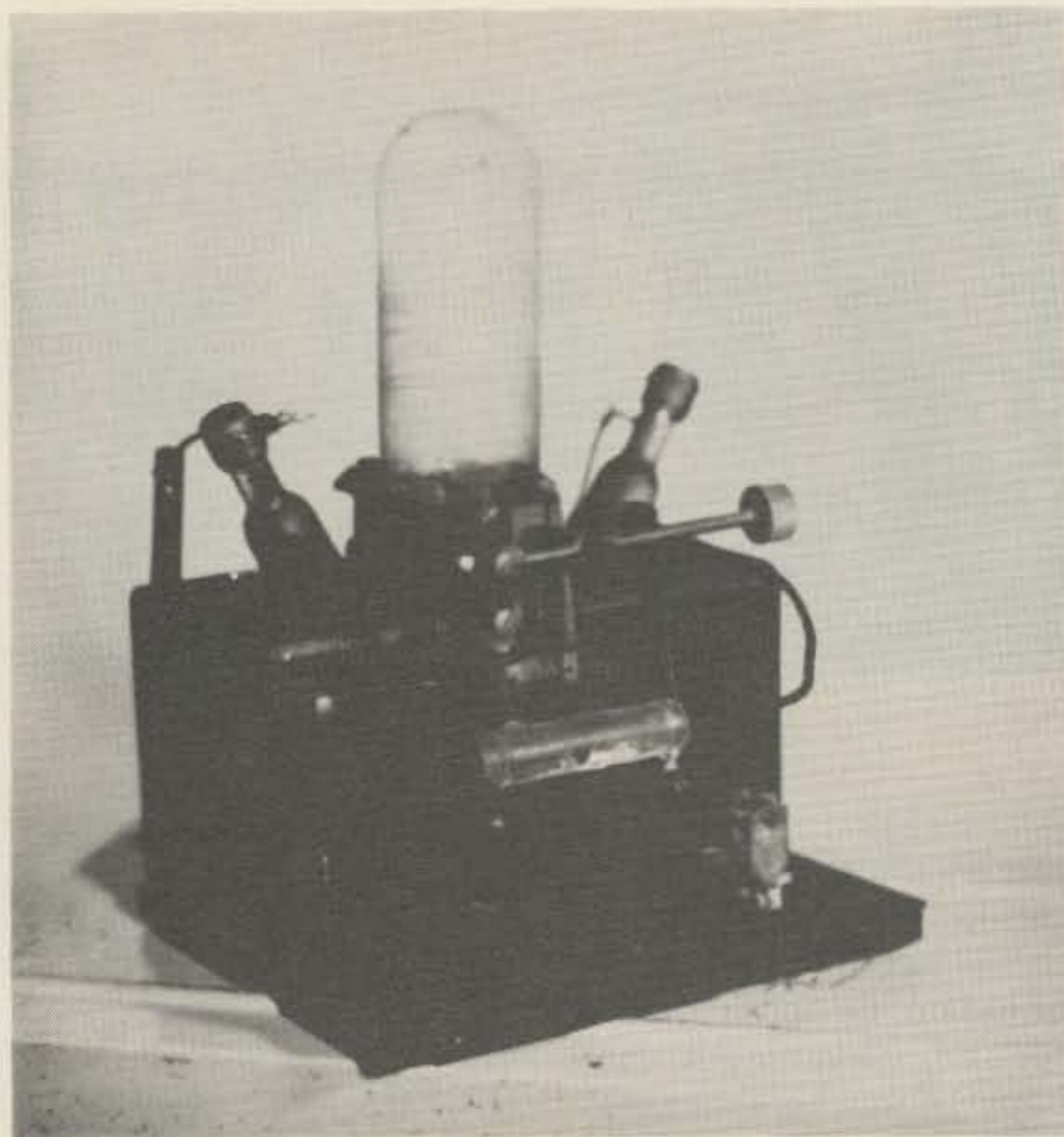

Fig. 2. A one-kilowatt transmitter.

responsible for the few installations of this kind.

Edison and Lead-Acid Batteries

Edison-type batteries were available built in small but compact units.

They were kept charged with a Tungar charger-rectifier connected to house current. The lead cells could be obtained in compact assemblies giving sufficient wattage for the smaller transmitting tubes.

All these units were messy and, besides giving off a gas odor, ruined many floors and carpets.

Typical of what certain amateurs were capable of and determined to build is illustrated by the enviable installation of radio NU9BHT. This beautiful layout required assembling and building one thousand individual lead-acid cells. They were contained in $4\frac{1}{2}'' \times 5\frac{1}{2}''$ hard rubber cases, with one positive and two negative plates per cell. Hard rubber trays contained 25 cells each and were treated with acid-resistant paint to provide protection and longevity. With each bank delivering 50 volts, separate switches were used to make appropriate connections for charging each bank, either separately or in four bank series of 200 volts. A motor generator battery charger delivering 250 volts kept the batteries fully charged.

Installations of this type necessitated adequate ventilation, care, considerable

service, and a separate building to house the equipment. The circuit diagram of the station transmitter adapted itself to frequent modifications and changes to keep it up-to-date.

With the development of crystal control and other experimental features added from time to time, NU9BHT established an enviable record while in service. Operating primarily on 40 meters CW and occasionally on 20, as an official ARRL relay station, it contacted all Australian districts, making five-continent QSOs in one evening. This was an exceptional accomplishment back in 1923. Not many installations of this type prevailed in hamdom. With a battery voltage source, no filtering was required. This was pure dc!

The Rectifiers, Mostly Chemical

Over the next few years, the various amateur publications carried a series of suggestions for methods of building rectifying equipment for the B supply.

How did the amateur go about putting together a chemical rectifier? He was on the lookout for—item one: chemically pure aluminum sheets; item two: chemically pure sheet lead; item three: a quantity of pint-sized jars; item four: several pounds of borax; item five: plenty of distilled water.

For each cell assembly he figured that approximately 40 volts could be rectified from a 60 cycle source. This translated to about 50 cells required for a 2000-volt output. Forming and placing such a home-built rectifier initially into operation required a great deal of experimenting to overcome a whole series of mishaps. Rectified ac output of this type was always accompanied by a 60-cycle ripple hum, which

THE SUPER-SYNC

The synchronous rectifier that can be filtered

The Super-Sync is the only rectifier that delivers a pure D.C. tone and gives 100% rectification at all times.

It is the only rectifier that is adaptable to either high or low power sets as it easily handles up to 4,000 V. at 250 M.A.

The commutator on the Super is eight inches in diameter and is driven by a $\frac{1}{4}$ H.P. 110 V. 60 cycle 1800

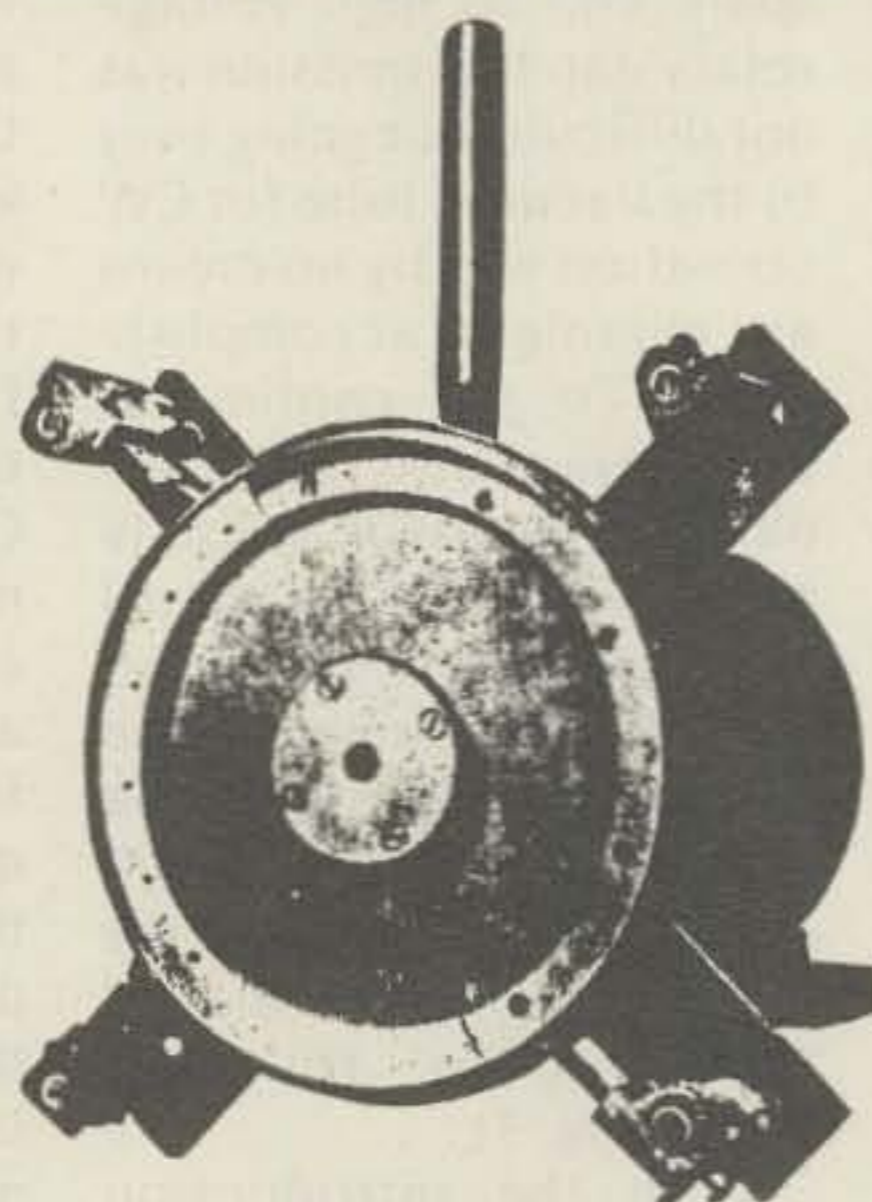

PAT. PENDING
PRICE \$75.00 F. O. B.

R P M synchronous motor.

With the Super there are no materials to change—just connect the motor and high voltage leads and forget about it as the only attention required is an occasional oiling of the bearing.

The Super practically eliminates interference caused by other types of synchronous rectifiers.

Write for descriptive literature.

MARLO ELECTRIC CO., 5241 Botanical Ave., St. Louis, Mo.
Just an Efficient and Reliable Form of Rectification

Fig. 3. A synchronous rectifier.

With a half inch spark coil a hard receiving tube may be used; either the Cunningham C.301 or the Radiocorp U.V.201 is suitable. For larger coils the 5-watt C.302 or U.V.202 may be used but less filament power is consumed by the Western Electric "E" or VT-1 tube. No 50-watt tube with proper plate insulation for spark-tube work is available just now but the C.303 or U.V.203 can be made to do.

Various circuits have been described in our pages in a paper called "A Spark Coil C.W. set," by Samuel Kopelson of 2BCF (May 1922—p. 66), and in "A Spark Coil C.W. Transmitter," by F. J. L. Duffy (March 1922—p. 28). In *The Modulator* for January 1923 there appeared on page 17 a concise paper by M. Joffe describing his spark-tube set at 2BYO.

The best plan of all is to remove the secondary entirely and re-wind the coil with wire 6 or 8 sizes larger. Robert Kraus of 2CEI finds that for a Ford spark coil the best secondary is one having 5000 turns of number 32 A.W.G. (B&S) double-cotton-covered wire. When the secondary is re-wound in this fashion no shunt condenser is needed in Fig. 4 and even for the other circuits it can be reduced to .001 microfarad. Three sheets of 4 x 5 tinfoil between 5 x 7-inch glass sheets $\frac{1}{8}$ inch thick is more than enough.

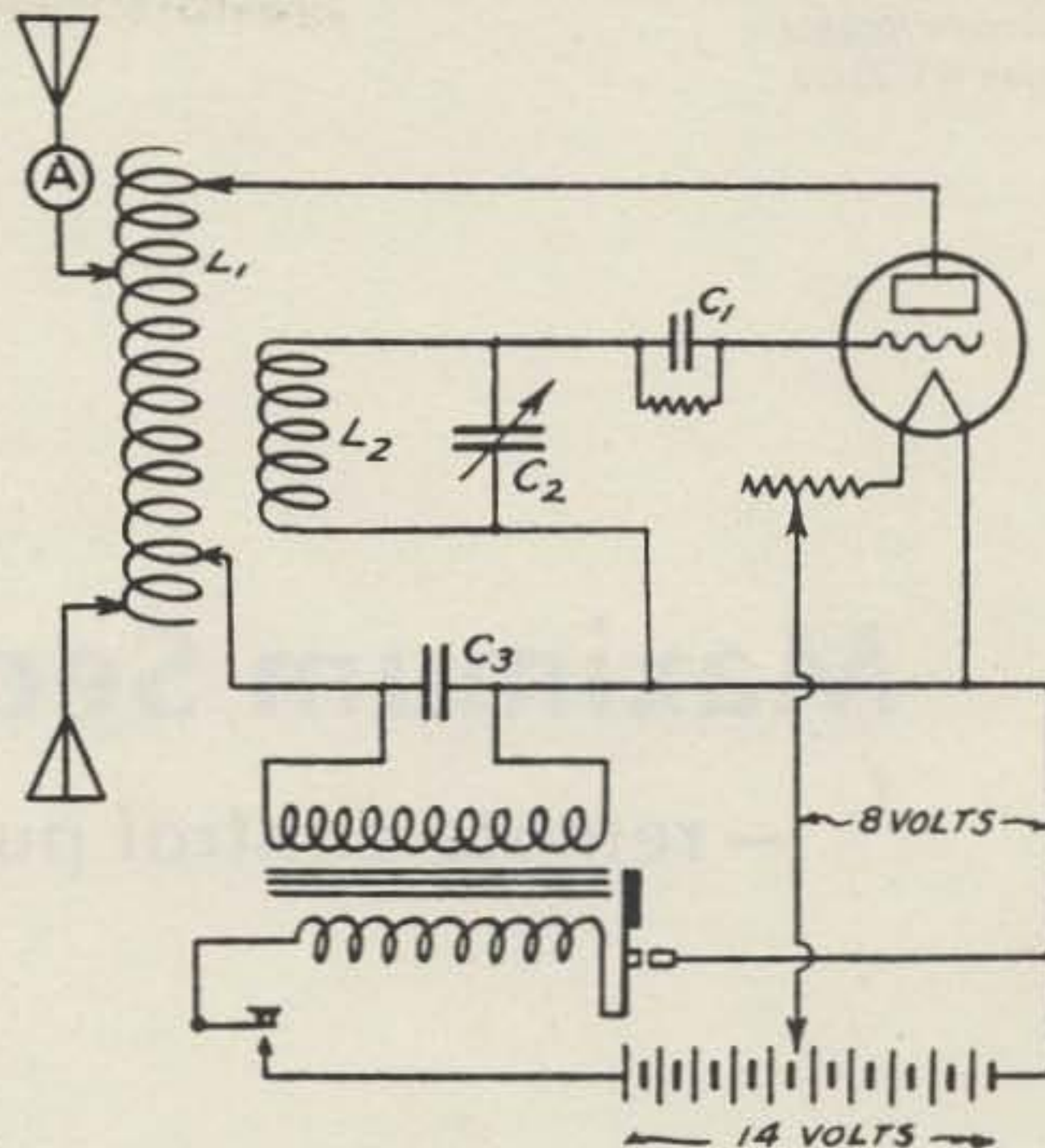

- L1—25 turns bare No. 10 wire on a 5-1/2 inch tube.
- L2—20 turns No. 18 S.C.C. copper wire on a 3 inch tube.
- C1—Mica condenser of .00025 to .0005 microfarads capacity.
- C2—Variable condenser, .0005 microfarads.
- C3—Glass or other sending condenser.

Fig. 4. Specially-wound spark coils.

had to be adequately filtered before it could meet the prescribed specifications—especially if it was to be used for a near-pure CW purpose. Filters were needed to eliminate key clicks. With batteries, there was complete absence of blinking lights, buzzing, whining, vibrating generators, and many ac growls on the air.

Other Substitutes For B Supplies

A convenient and inexpensive unit known as the mercury arc rectifier, equipped with an electrolytic "keep-alive" mechanism, was extensively used to give up to 3000 volts of B supply power. Both voltage and current outputs satisfied a one-kilowatt transmitter (Fig. 2).

Also available was a synchronous rectifier, as shown in Fig. 3. A synchronous motor, 1800 rpm, carried a large-diameter split

wheel, with which two husky commutator brushes made contact. In this way, the 60-cycle current was rectified and the pulsating directional output then filtered. These units were marketed under the name of Super-Sync and provided plate energy rated at up to 4,000 volts.

Some of the early plate supplies were obtained from specially-wound spark coils—see Fig. 4. Such transmitter assemblies put out an ICW signal, were extensively used, and solved the high-cost problem. It was necessary to adjust the vibrator frequently to obtain a smooth tone, the pitch being immaterial but often adjusted to satisfy the contacted operator at the other end.

Radio amateurs in the early 1920s were an experimental and ingenious lot. They solved their problems in the best amateur tradition. ■



"THESE NEW TONE UNITS ARE ELEMENTARY, MY DEAR WATSON!"

SELECTONE announces an "elementary" way to add tone control to your radio system. Now you can control repeaters, add selective calling to your system, or

protect remote base stations and autopatches from intermod and interference. All SELECTONE units are fully tunable to any desired frequency (no reeds, resistors, or frequency elements required), sub-miniature in size to fit almost any radio, and carry a full 2 year warranty. Call us TOLL FREE for more information on these exciting new products.

- ST-100 Sub-audible Encoder • Fully tunable from 67.0Hz to 250.3 HZ • Measures only 1"x.86"x.38" • \$24.95
- ST-101 Sub-audible Encoder/Decoder • Tunable from 67.0 Hz to 250.3 Hz • Measures 1.67"x1.19"x.38" • \$49.95
- ST-110A Burst Tone Encoder • Choice of 3 burst durations • Tunable from 800 Hz to 3000 Hz • Measures only 1.26" x1"x.38" • \$27.50
- ST-111 Burst Tone Decoder • Will decode single tone frequency from 800 Hz to 300 Hz • Both timed and latched outputs • Measures only 1.25"x1.9"x.38" • \$54.95

Selectone

26203 Production Ave., Suite 6
Hayward, California 94545 ✓ S110

CALL TOLL FREE
(800) 227-0376
In CA Call (415)887-1950
VISA & M.C. accepted

Maximum Security for the 22S

— remote control puts your Icom in the trunk

Probably one of the most versatile and easily modified radios on the market today is the Icom 22S. A multitude of frequency combinations can be selected simply by soldering inexpensive diodes into one of the 22 matrix board divisions.

The purpose of this article is to look at a few easy and inexpensive modifications which can be done to allow either greater frequency selection flexibility or remote control of the Icom "Mobile Marvel."

Upon examining the Icom 22S, one of the first things one usually notices is that, although the radio is advertised as a 22-channel rig, the programming matrix

board and selector switch have 23 positions. To initiate 23-channel operations, all one need do is connect a short piece of wire from switch lug 23 to the 23rd diode row and program the row with appropriate diodes for the extra frequency of your choice.

The second easy modification is the use of the 23rd position in conjunction with a few diodes and a DIP switch to allow the selection of any combination of available frequencies. Articles in the 73 Magazine issues of June, 1977 (p. 152), and May, 1978 (p. 158), showed DIP switch mounting methods which required external components subject to easy

breakage, or required defacing the cabinetry of the radio. An alternate method which allows easy DIP switch programming without defacing the exterior of the radio, while providing a secure and strong DIP switch mount, is shown in Fig. 1.

All one needs to do is simply (1) remove the 24-pin accessory plug from its holder, cover it with tape to prevent shorts, and push it inside the case, and (2) glue a section of perfboard on the accessory plug support bracket, mount your DIP switch on the perfboard, and wire as shown in Fig. 2. At this point, your 22-channel radio can be programmed for any of the frequencies

listed in the owner's manual, without resoldering diodes.

The final modification I will describe was inspired as much by my laziness as by security needs. Often I find myself needing to stop in town for some small item. As in most urban areas, this requires that either you remove your radio from the car or trust fate that it will be there when you return.

Not being one who enjoys disconnecting my rig and placing it in the trunk four or five times a day, I conceived the idea of remote controlling the Icom and mounting it in the trunk.

To my great surprise, this modification is both easy

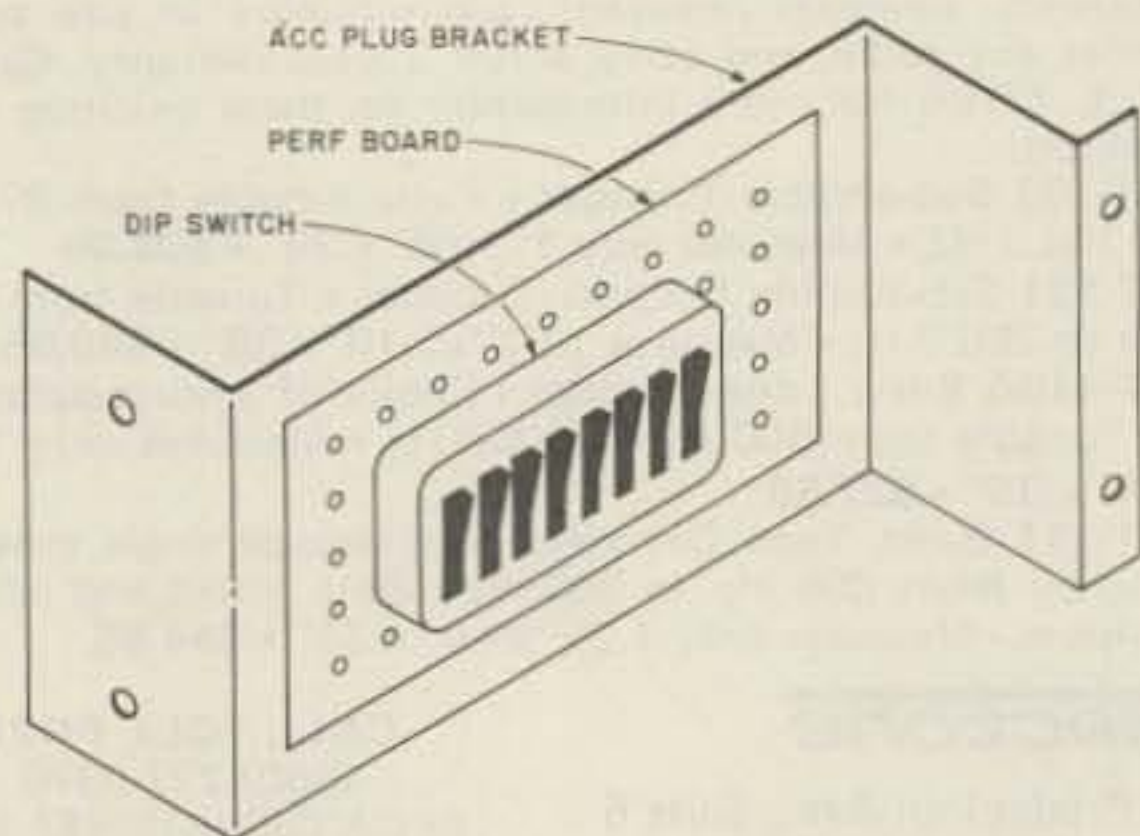

Fig. 1.

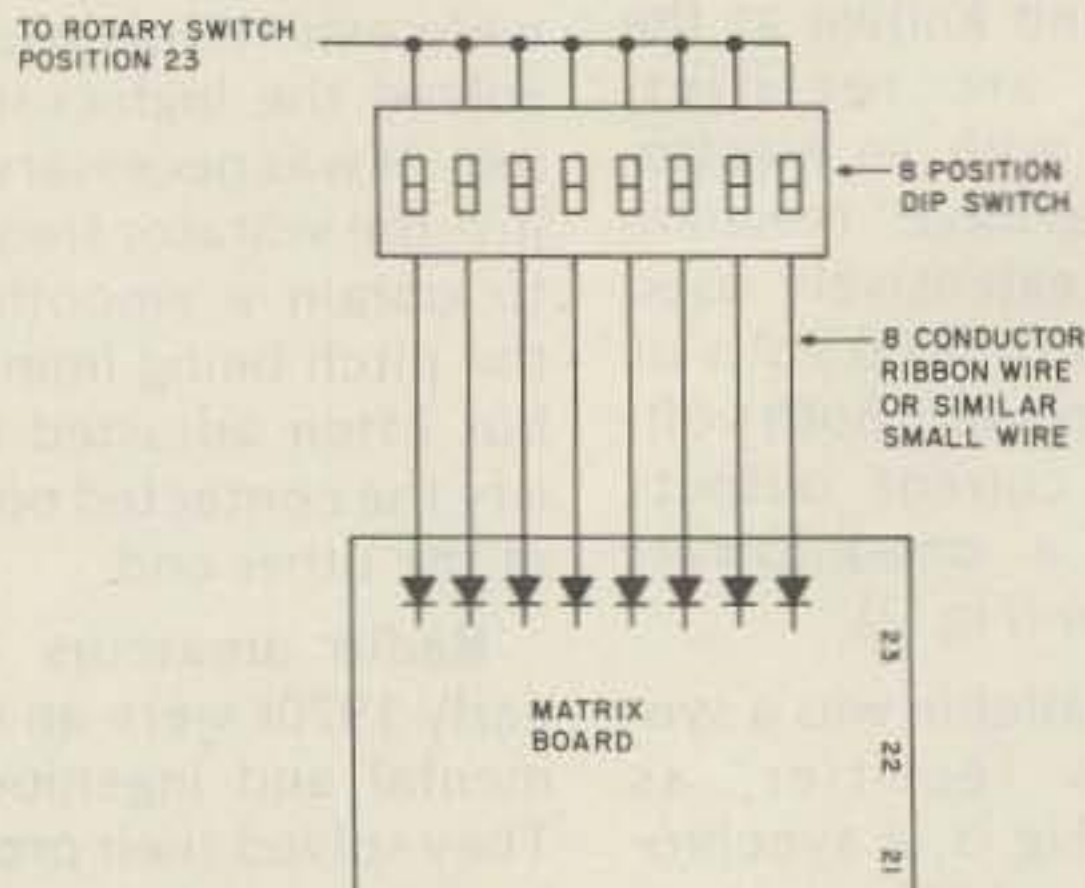

Fig. 2.

and inexpensive. All that is required is some wire, two potentiometers, two knobs, one male and one female 4-pin mike jack, a speaker and miniature phone jack, a rotary switch, and a small box, such as the Radio Shack #270-236.

To accomplish remote frequency selection, run a wire from an unused channel position on the matrix board (Point A in Fig. 3) to the common of the remote 23-channel selector switch, via the accessory jack, as shown in Fig. 3. Note that the previously-mentioned DIP switch location cannot be used with remote control. It will be necessary to mount your DIP switch elsewhere (see Leon Baldwin's article in the May, 1978, issue of 73 Magazine). Next, run your return leads from the rotary switch back to the matrix board via the accessory jack. All 22 previously-programmed channels cannot be remotely selected due to the use of the accessory jack to carry volume, squelch, and duplex controls.

If you do not have a 23-position rotary switch, an alternate method may be to use a double-ganged, 12-position rotary switch and toggle switch combination, as shown in Fig. 4.

To vary the volume and squelch level, simply install a pot in parallel with the wiper on the original controls, as shown in Fig. 3. Slight problems may arise in the volume control circuit. Usually, this is due to a pot which will not adjust to a low enough value. It may be necessary to substitute a pot other than the one specified.

Duplex-simplex control also is accomplished as shown in Fig. 3. Power for the unit is delivered from switch 1 in the control panel.

To operate remote, install the unit with the power switch on the radio

in either high or low position. Turn the squelch controls on the radio to maximum, and the volume to about mid-point. Place the channel selector in position 23, and control as usual from the remote unit.

I hope that this article will stimulate interest in Icom owners to build the remote unit, and possibly to try other remote control modifications to which this versatile little unit might well be suited. ■

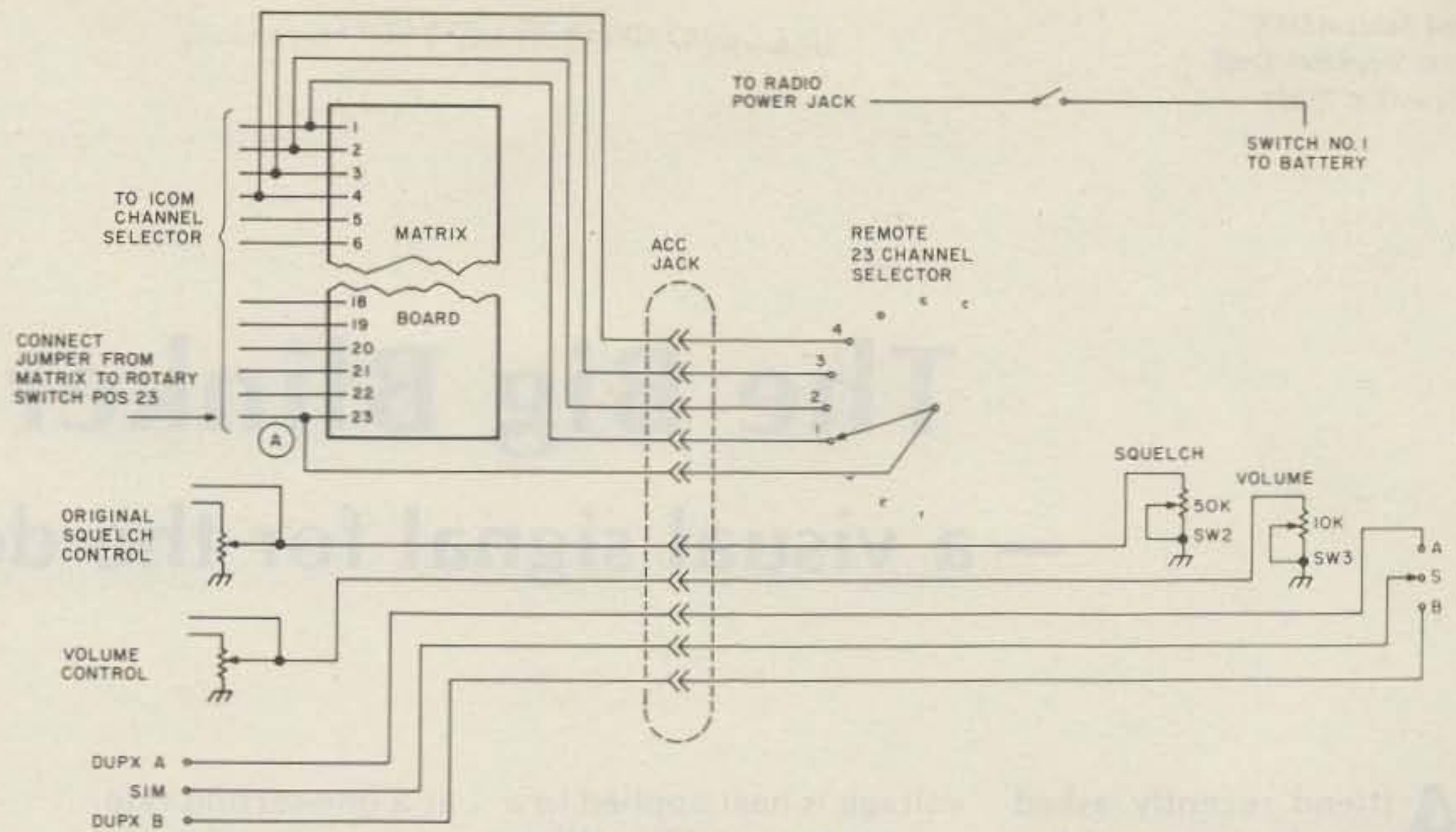

Fig. 3.

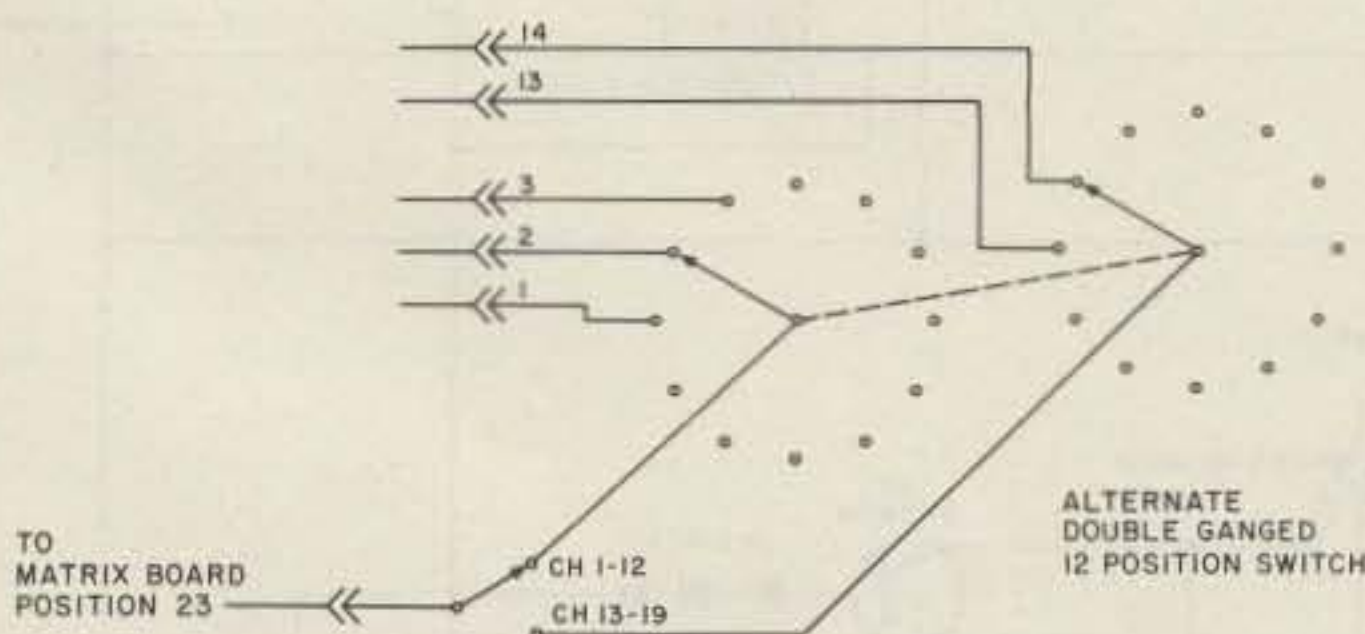

Fig. 4.

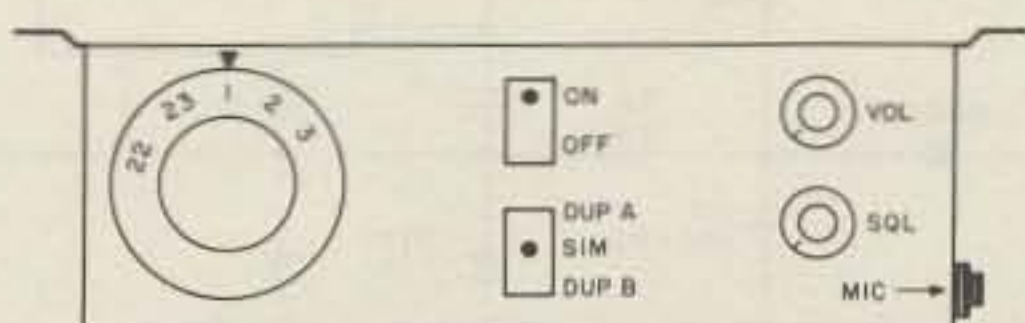

Fig. 5.

We Sell The Best HAM RADIO Programs For The TRS-80!

Send \$1.00 (refundable with order) for a catalog of all our programs!

SoftSell Unlimited

P.O. Box 145 • Lithonia, Georgia • 30058

The Big Blinker

— a visual signal for the deaf

A friend recently asked me for something which could be used in conjunction with an alarm clock in order to awaken his deaf nephew in the morning. The circuit which I finally came up with is shown in Fig. 1.

Basically, it works as follows: The sound of the alarm is picked up by a crystal microphone element, amplified by U1A and U1B, and detected by the full-wave rectifier consisting of U1C and diodes D1 and D2. The rectified

voltage is next applied to a comparator (U1D). When the input signal is loud enough and of a long enough duration, the rectified voltage on the inverting input of U1D exceeds the reference on the non-inverting input, causing the output of U1D to go to Vee. This turns on transistor Q1, which then enables U2, a 555 timer operating as a one-second oscillator. The output of the 555 drives a triac, which in turn causes a lamp plugged into the ac socket to flash

at a one-second rate.

For best results, tape the microphone to the alarm clock and adjust the comparator threshold so that only the alarm clock sound triggers the unit. Transient noises will not enable the circuit due to the RC time-constant at the detector output.

All of the parts are readily available at your local Radio Shack. I used an LM324 quad op amp, but any quad, two dual, or four single op amps can be

used. The pin numbers shown were for my particular layout but, of course, any of the op amps can be interchanged.

This unit performs quite well, and is certainly more of an attention-getter than the original timer used. The original timer was used to simply turn on a light. The triac used can handle up to 6 Amps, so several lamps can be plugged into the unit. The lamps will continue to flash as long as the alarm is sounding. ■

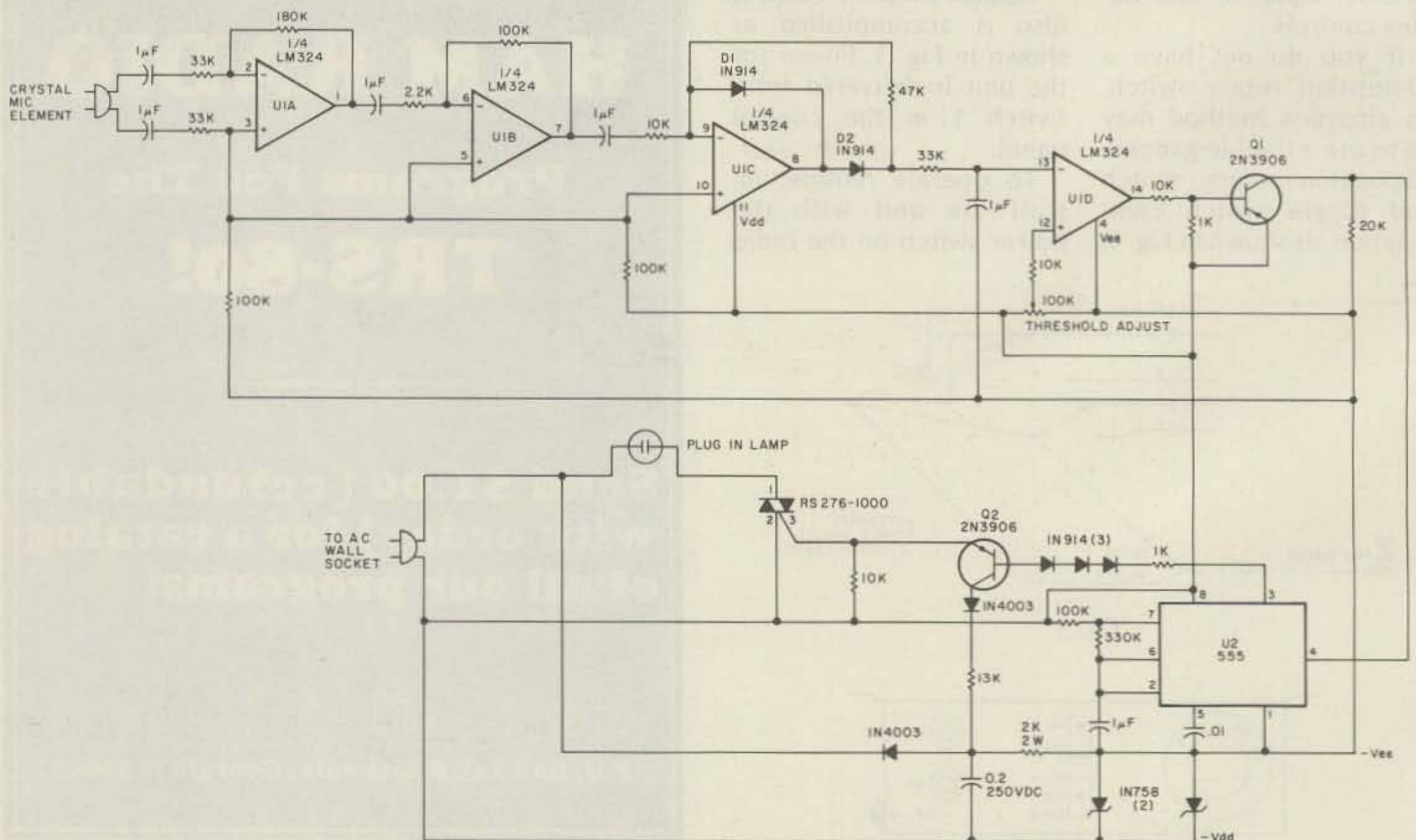
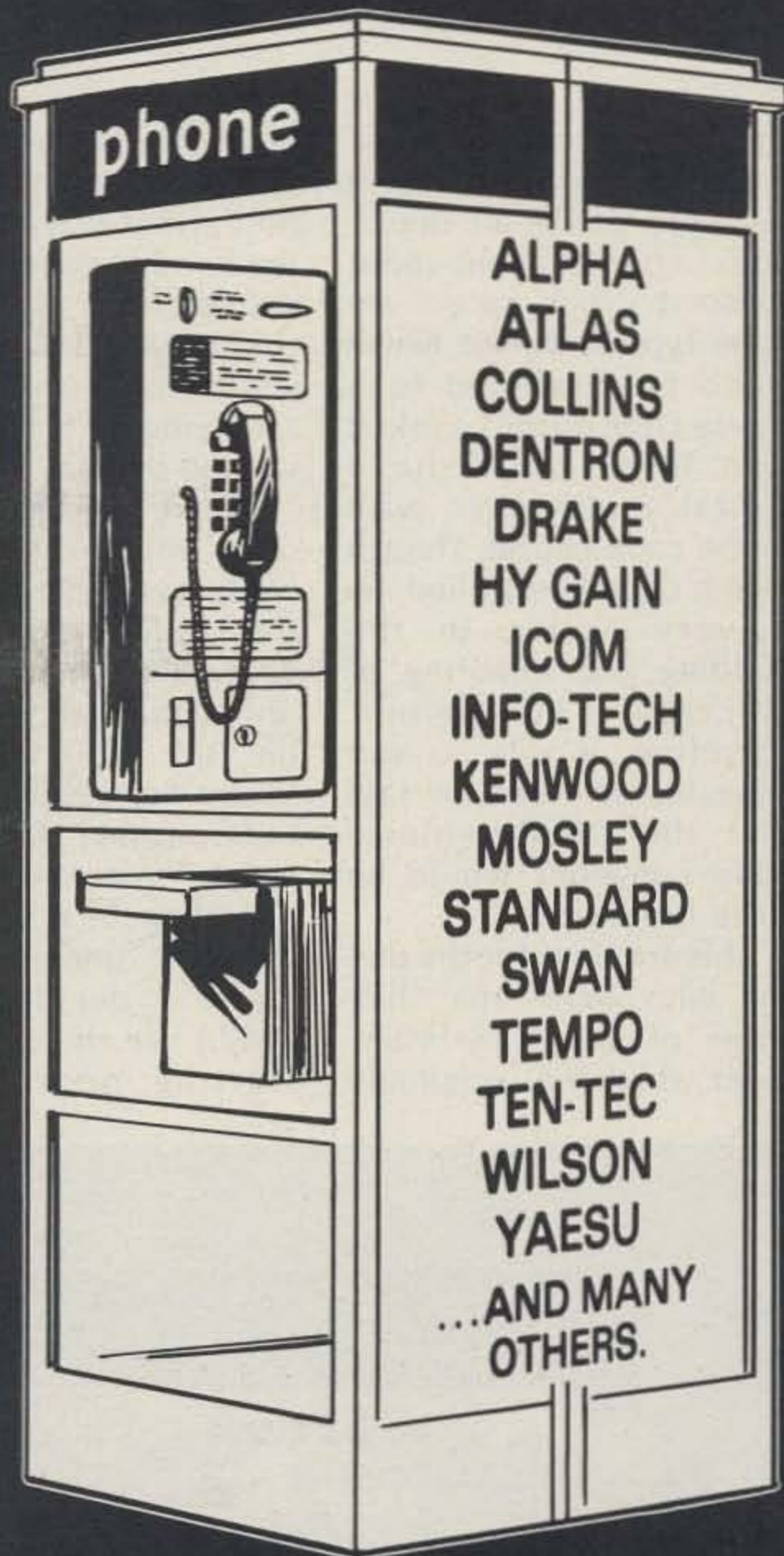

Fig. 1.

Ham Radio Center has a Branch Store on the corner.



**CALL
TOLL
FREE**

**BEST
PRICE**

**FAST
DELIVERY**

NEW!
HAM-KEY*

*TM trade-mark



**Model
HK-3M**

With anti-tip bracket even a heavy-handed key pounder cannot tip. All the features of the HK-3.

- Deluxe straight key
- Heavy base
- Navy type knob

\$19⁹⁵

Add \$2.00 shipping & handling per unit (USA)

1-800-325-3636

HAM RADIO CENTER

8340-42 Olive Blvd. • P.O. Box 28271 • St. Louis, MO 63132



Morse Converter for DMMs

— super gadget for blind hams

A digital converter which will take the binary coded decimal (BCD) output of a digital multimeter (DMM) and convert it to Morse code would surely be an asset to any blind or partially blind person's workshop.

After graduating from a CREI home study course in electronics engineering technology (minicomputers and microprocessors as the major elective), I had a strong desire to make some practical use of the knowledge.

Shortly after finishing the home study course, I was talking with my dear friend of nine years, W6LZV. He was mention-

ing that a Morse clock could be helpful to him in his daily on-the-air operations. After thinking about a Morse clock versus another type of device which could be converted to a Morse code output, I asked Jean if he could use a digital multimeter with Morse code output. Though Jean is completely blind, he is very active in the building and repairing of electronic equipment. Therefore, it was no surprise to me when he said that the DMM-to-Morse code converter would be more functional.

This article is for the person who wants the challenge of using an instrument which was originally

made for the sighted person. This article can open doors that have inhibited the handicapped person in delving into a world of technical discovery—a world which can be just as satisfying for him as for the sighted person.

While researching what chips might be commercially available to handle the BCD-to-Morse code conversion in a very simplified manner, I ran across the July, 1977, issue of *73 Magazine*, which has an article entitled "The Morse Clock." After reading and rereading the article, trying to fully understand the logic, I decided that I would use the article as a starting point for my

design of the DMM-to-Morse code converter.

The digital multimeter used for this prototype project was the Sabtronics 2000 DMM. At first, I had only a schematic of the DMM to work from, but it was apparent that converting the output of the MC14433 A/D converter chip into Morse code would not be too difficult. After building the DMM and seeing how the MC14433 chip worked, I decided that since the position of the decimal point depends only upon the function button and range button selected and upon whether the X10 range switch is used, I would disregard the decimal point. Only the minus sign and the 3½ digits were dealt with.

Features of the DMM-to-Morse Code Converter

The converter was designed to provide the following:

1. Morse code output of the 3½ digits.
2. Morse code character "m", which signifies that a minus sign is present.
3. An audible over-range indicator.
4. A method by which the user can perform "continuity tests."
5. Three selectable code speeds.
6. A Morse code zero (0) for a "blanked" first digit.



The converter at work. The DMM indicates -108.5 Ohms. (The minus sign is peculiar to the Ohms reading on this DMM.) When the INI button is pushed, the converter will respond with --(minus)

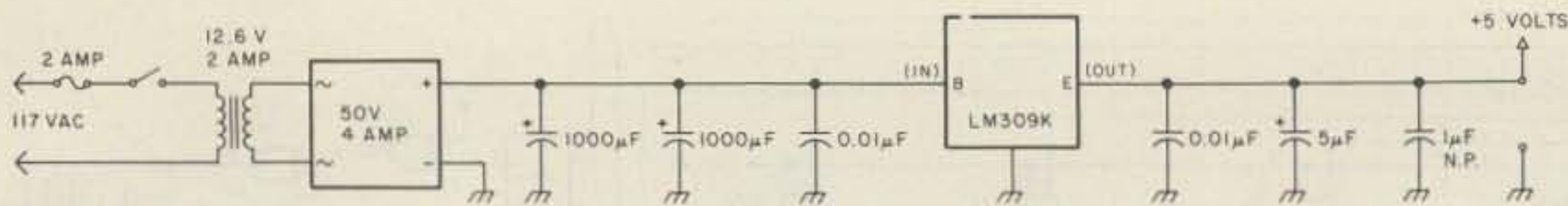
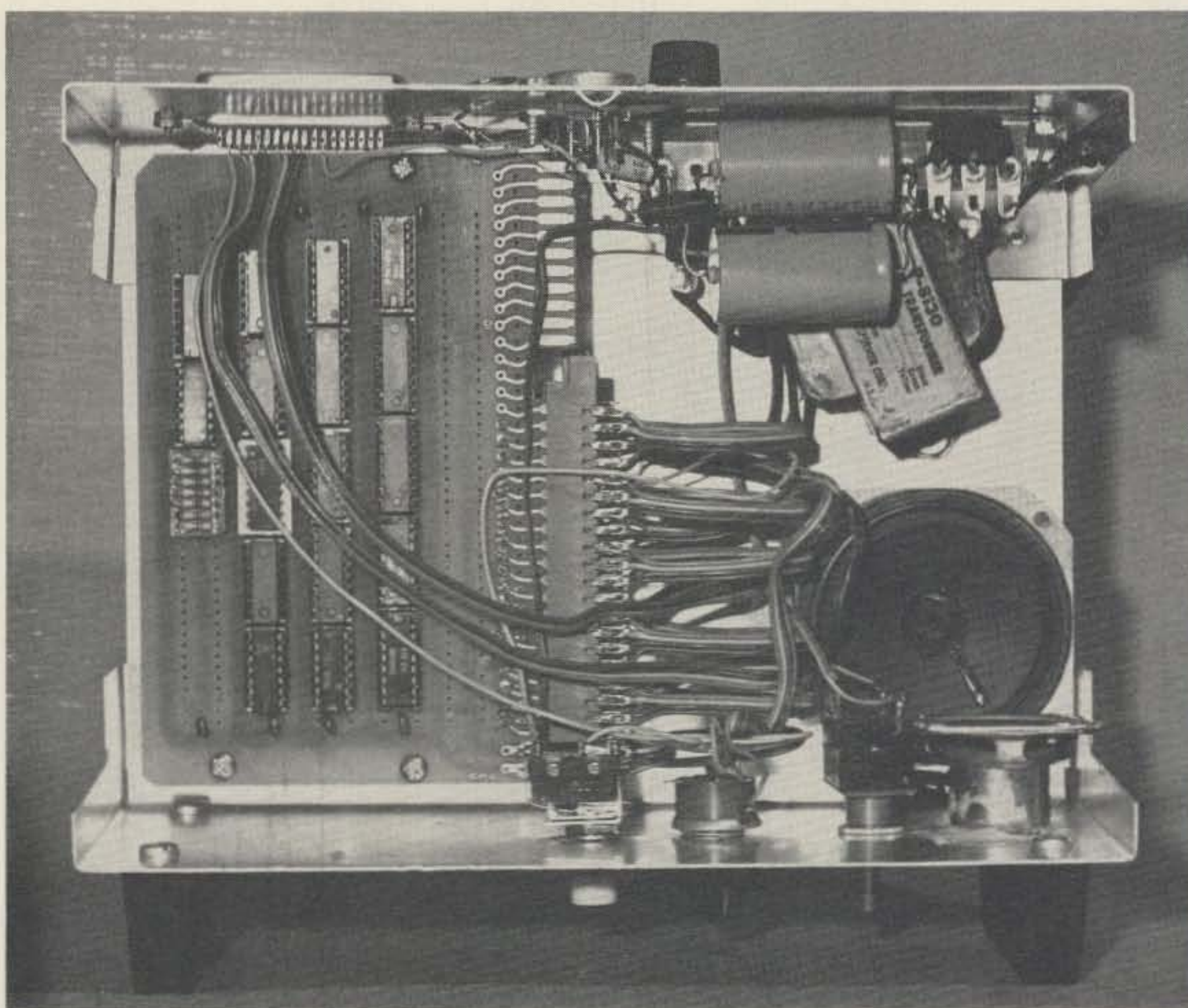

Fig. 2.

State	IRENABLE (+), U13D/pin 13	MINUS SAMPLING, U15D/pin 12	IRENABLE (-), U13C/pin 10	74153 (enable), U8/pin 1	74153 (B), U9/pin 2	74153 (A), U9/pin 14	DIGIT LOCK-UP, U7D/pin 12	Remarks
0000	X	X	X	X	O	O	X	Wait for "next instruction"
0001	X	O	X	X	O	O	O	Address (-) Minus sign
0010	X	X	O	X	O	O	O	Send (-) Minus sign
0011	X	X	X	X	O	O	O	Clear BCD-Morse code converter
0100	X	X	X	O	O	O	O	Address 1st digit
0101	O	X	O	O	O	O	O	Send 1st digit
0110	X	X	X	X	O	X	O	Clear BCD-Morse code converter
0111	X	X	X	O	O	X	O	Address 2nd digit
1000	O	X	O	O	O	X	O	Send 2nd digit
1001	X	X	X	X	X	O	O	Clear BCD-Morse code converter
1010	X	X	X	O	X	O	O	Address 3rd digit
1011	O	X	O	O	X	O	O	Send 3rd digit
1100	X	X	X	X	X	X	O	Clear BCD-Morse code converter
1101	X	X	X	O	X	X	O	Address 4th digit
1110	O	X	O	O	X	X	O	Send 4th digit
1111	X	X	X	X	O	O	O	Clear BCD-Morse code converter

Table 1. Contents of the "control" ROM (U20).



Top view of completed unit.

output line (IRENABLE -) from the state-machine ROM; 2. Selects the appropriate logic used for giving the "space" between the Morse code characters; 3. Disables the BCD-to-Morse code ROM. When this ROM is disabled, all of its outputs are driven HIGH, thus providing the needed output for making the Morse code character "m"; 4. Signals the input multiplexer (U18, 74150) that the "m" and the "space" between characters has been sent (no-code condition). Spacing between the Morse character "m" and the first digit is longer than between "each" digit. This characteristic provides a distinguishable pause between the "m" and the start of the first digit.

The First Digit

The 1/2 (first) digit demultiplex and storage circuitry is made up of U10B and U1 (respectively). Since the 1/2 digit is only a zero (0) or a one (1), I tied the binary 2, 4, and 8 inputs of U1 to ground (binary zero) and let the output of the 7474 dual D flip-flop (U10B) determine whether a zero or a one is showing in the 1/2 digit's place.

The Over-range Indicator

A 7493 counter (U23), wired as a divide-by-10 counter, is used to provide the counter-states which make up the "ditters" when an over-range condition exists. The 7493 counter-states of 2 and 7 are decoded and driven to a 7400 SR flip-flop, which provides the ditter sensation.

Besides providing the user with an indication of an over-range condition, the over-range indicator circuitry can also be used to provide a continuity test. When the DMM is placed in the OHM function and an OPEN condition exists between the input terminals, all digits are

blanked (to the sighted user) and the over-range ditters are HEARD. With this condition in mind, the user takes the test leads and makes the necessary connections for determining if there is an open or a shorted condition. After making the connections, if the ditters persist, an open condition exists (verified by pressing the "initiate" button and hearing "m" 1999). If the ditters cease, the user either has a shorted condition or some actual value of resistance. A shorted condition can be verified by pressing the "initiate" button and hearing either "m" 0000 or just 0000.

When the function switch is in the OHM position, the user must ignore the "m" (minus sign) which is active due to the design of the DMM. During the OHM function, the minus sign shows up (for the sighted person) to tell the user that the input jack (positive jack) is in fact the negative probe, and that the DMM is in fact turned ON.

Construction/Miscellaneous Notes

Excluding the MC14433 in the DMM, the prototype project has a chip count of 31. All ICs used in the project were of the commonly-available type. All parts were either obtained locally or through various electronic parts catalogues.

I used the wire-wrap technique because it gave the amount of versatility in construction that I wanted. I was able to build each

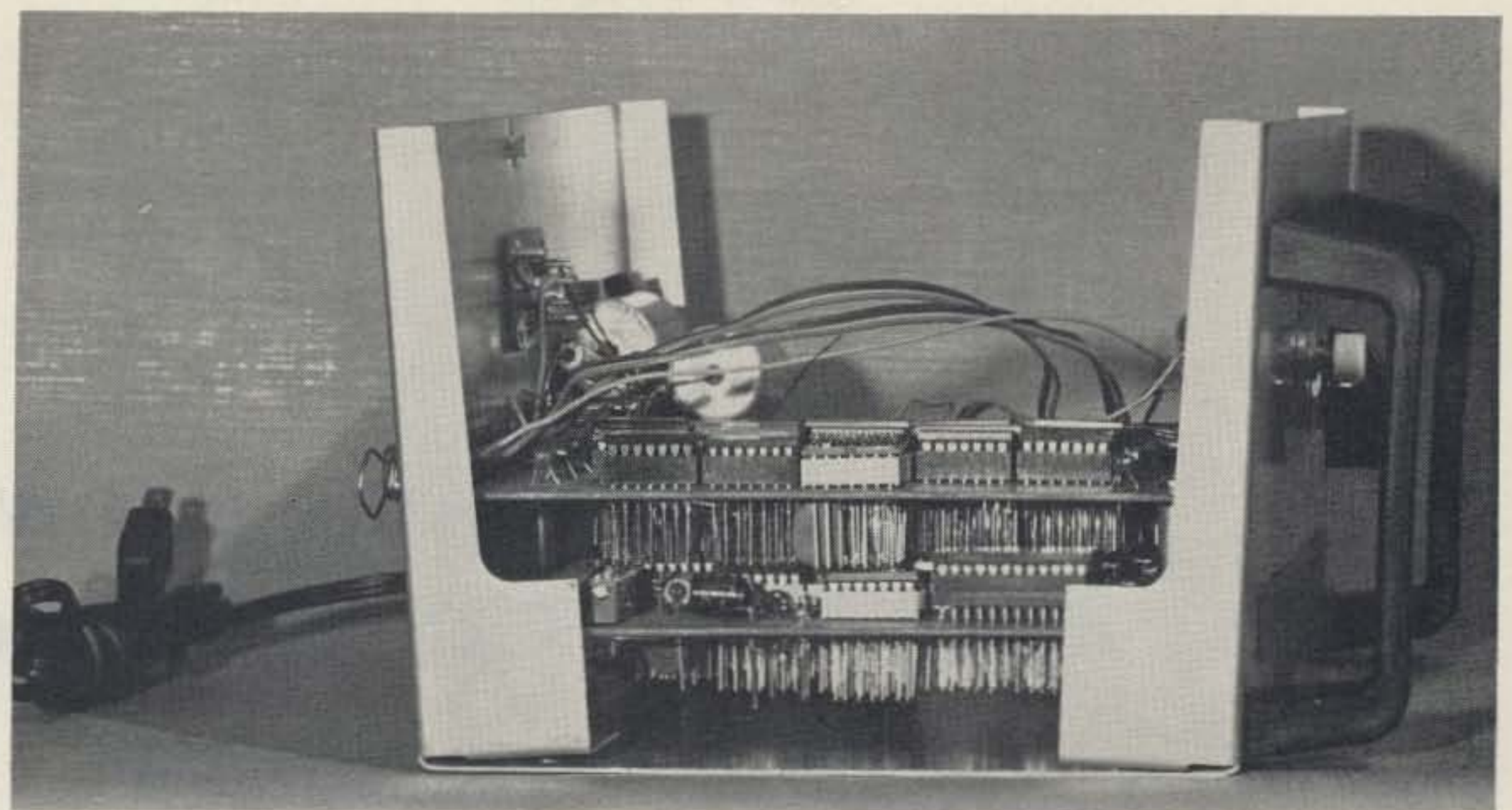

Side view of completed unit.

functional section bit-by-bit.

Interfacing of the CMOS 14433 with the TTL 7475 and 7408 was achieved by using two CD4050s (hex buffers).

I am sure that there are many alterations which can be made to my present design. These could include feeding the Morse code output and the over-range output through a "summing" op amp amplifier, thereby needing only one speaker. Also, U5 and U6 could be deleted if we dealt with CMOS technology throughout the converter.

The cost of the converter parts (including the cabinet and wire-wrap PC boards) was approximately \$120.00, but the cost could be brought down easily to approximately \$60.00 if the builder has a well-stocked junk/spare-parts box and if

he shops around.

My sincere thanks to WB3EVS for his technical assistance, to WA6DLI for his superb photographic shots of the converter, and to WA1MXV and WA5VQK for their very enlightening articles. ■

References

1. Robert J. Souza, "The Morse Clock... Timely Repeater ID," *73 Magazine*, July, 1977, p. 54.
2. Tim Ahrens, "Super DVM... Uses the MC14433 and LCD," *73 Magazine*, August, 1977, p. 108.
3. Don Lancaster, *TTL Cookbook*, Sams Publication.

Digit	ROM Address	ROM Contents
0	0000	11111
1	0001	11110
2	0010	11100
3	0011	11000
4	0100	10000
5	0101	00000
6	0110	00001
7	0111	00011
8	1000	00111
9	1001	01111
blank	1111	11111

Table 2. Contents of the "code conversion" ROM (U11).

CUSTOM TRANSFORMERS



HEAVY-DUTY

REPLACEMENT TRANSFORMERS

BTLK-2000 Plate	\$135	HEATH HA-10 Plate	\$115
COLLINS 30S-1 Power	\$215	HEATH HX-10 Power	\$95
COLLINS KWS-1 Plate	\$135	HEATH SB-220 Plate	\$125
COLLINS 516F-2 Power	\$95	HENRY 2K Plate	\$150
DENTRON 160-10L Power	\$125	HENRY 2K-2 Power	\$155
DRAKE L4B Plate	\$165	HENRY 2K-4 Power	\$165
GONSET GSB-100 Power	\$95	HENRY 3K-A Plate	\$165
GONSET GSB-201 Power	\$135	HENRY 3K-A DC Choke	\$85
H-CRAFTERS HT-32 Power	\$95	EFJ T-BOLT Plate	\$125
H-CRAFTERS HT-37 Power	\$95	EFJ 500 Modulation	\$95
HEATH DX-100 LV Power	\$95	EFJ 500 DC Choke	\$75
HEATH DX-100 Modl	\$95	NATL NCL-2000 Plate	\$125

OFF-THE-SHELF SPECIALS

PLATE XFMR:	3000 VAC @ 3.0A CCS 230 PRI-120LB	\$450
PLATE XFMR:	2400 VAC @ 1.5A ICAS 220/240 PRI-41LB	\$150
PLATE XFMR:	3000 VAC @ 1.5A CCS 230 PRI-60LB	\$195
PLATE XFMR:	3000 VAC @ 0.7A ICAS 115/230 PRI-27LB	\$115
PLATE XFMR:	3500 VAC @ 1.0A ICAS 115/230 PRI-41LB	\$150
PLATE XFMR:	4000/4600 VAC @ 1.5A ICAS 230 PRI-60LB	\$195
PLATE XFMR:	6000 VCT @ 0.8A CCS 115/230 PRI-41LB	\$150
FILMT XFMR:	5.0 VCT @ 30A 117 PRI-9.5LB	\$30
FILMT XFMR:	7.5 VCT @ 21A 117 PRI-9.5LB	\$30
FILMT XFMR:	7.5 VCT @ 55A 115/230 PRI-14.6LB	\$65
FILMT XFMR:	7.5 VCT @ 75A 115/230 PRI-20.2LB	\$95
FIL CHOKE:	30 AMP Bifilar Wound on 1/2"x7" rod	\$9
DC CHOKE:	8.0 Henries @ 1.5 AMP DC 41LB	\$150
SWG CHOKE:	5-30 Henries @ 1.0 AMP DC 23LB	\$100

ALL TRANSFORMERS & CHOKES GUARANTEED FOR 24 MONTHS

Many others also available. Write for free list or quote on any custom transformer, choke, or saturable reactor.

Peter W. Dahl Co.

4007 Fort Blvd. • El Paso, Texas 79930

Telephone (915) 566-5365



How to Home-Brew Your Own Crystal Filters

— the series-string method

73 Magazine Staff

One of the prime limitations that discourages many amateurs from pursuing various interesting projects is the cost of good crystal filters. One example is with the construction of rf speech processors or clippers. Clippers are relatively easy to build and very effective, but they require the use of a good SSB filter.

One of the simplest forms yet of a good home brew crystal filter was recently discovered. Hopefully, it will allow many amateurs to pursue some of those projects they have been putting aside because of the expense of commercial filters.

The crystal filter to be described can be built around a group of almost any commonly available MHz-range crystals of the

same frequency. The crystals which are manufactured for TV games or color TV sets are particularly suitable since they are manufactured to close tolerances and are inexpensive. For instance, the 3.579545 MHz crystals for color TV set circuits are readily available for only around \$1.00 because they are mass produced in such quantities. In fact, with a bit of hunting through sales flyers, one often can find them on sale at 6 for \$5.00.

As the title of this article implies, the circuit for the crystal filter is nothing more than a series-connection of the crystals, as shown in Fig. 1. The input and output of the filter are terminated by 1k-Ohm resistors. The trimmer capacitors are used to obtain the overall desired response. The type of response that can be obtained is shown in Fig. 2.

The frequency scale has been expanded somewhat on the graph, so at first glance the filter response may seem rather broad. Actually, it is quite good if one studies the response in a bit more detail. The -60-dB bandwidth is about 8 kHz. The ultimate out-of-passband rejection

could not be measured much beyond -60 dB with the equipment available, but the ultimate rejection is probably -80 dB or better. Just for comparison, the response of a medium-priced (\$40 range) imported filter is shown by the dot-dash lines inside the series-string filter

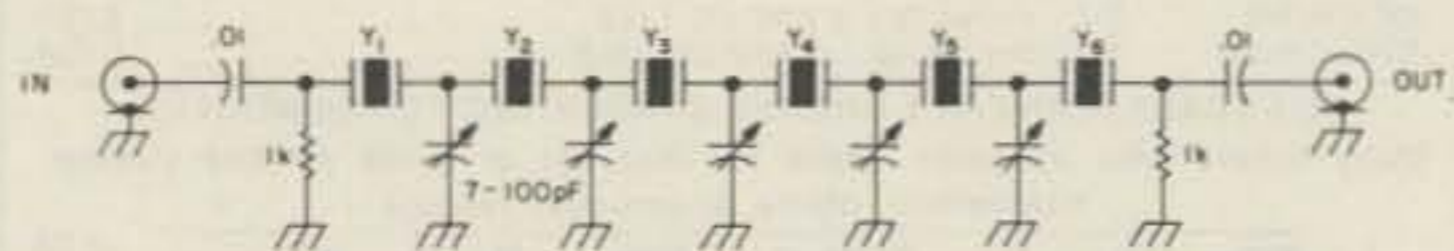

$Y_{1-6} = 3.579545 \text{ MHz}$

Fig. 1. The series-string crystal filter.

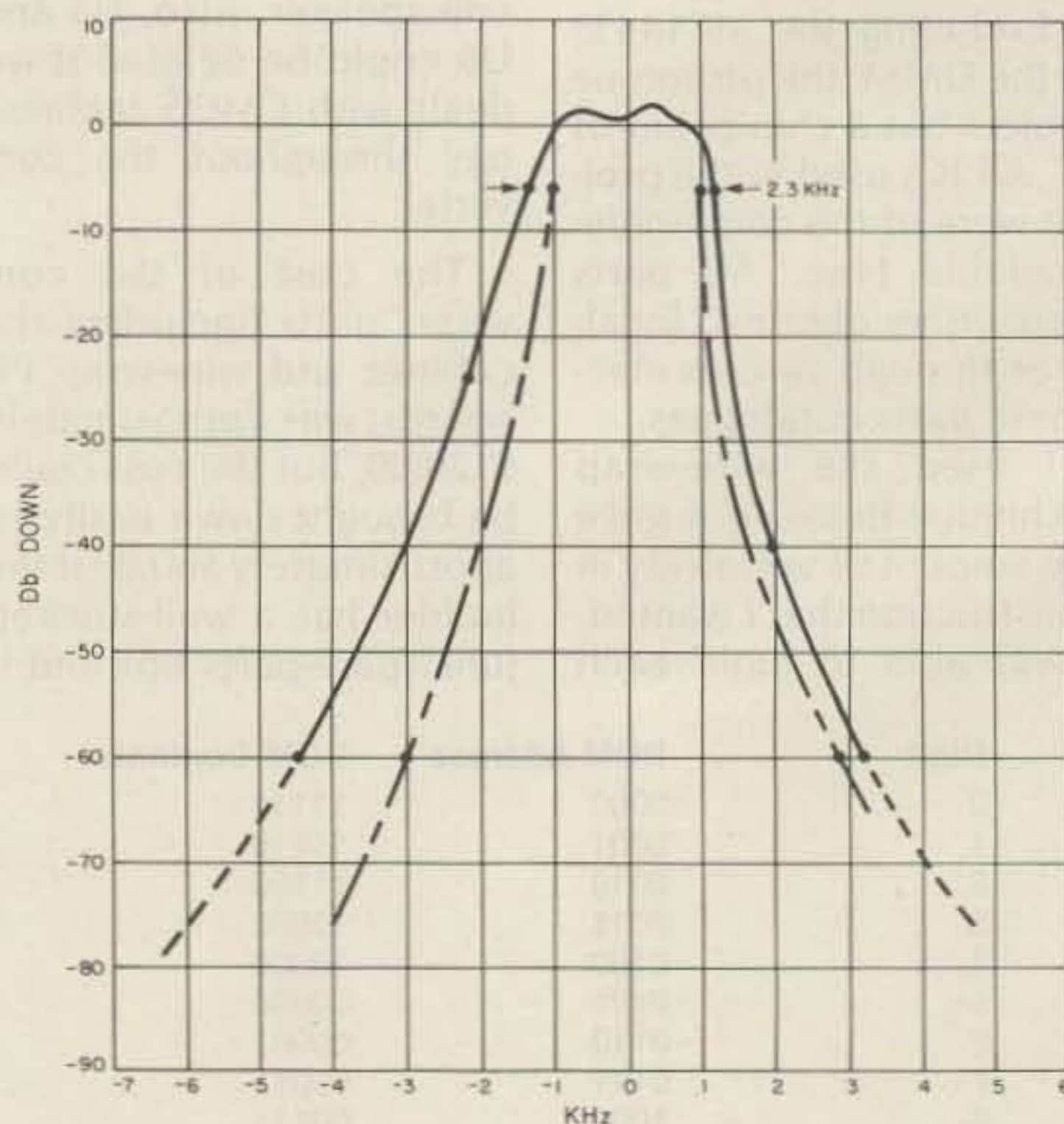

Fig. 2. Response of the series-string crystal filter (outer curve) compared to that of a moderately-priced commercial filter (inner curve).

The LEADER In the Northwest!



ATLAS • ICOM • KENWOOD • YAESU

Come to **ABC Communications** today for the best solution to your particular communication requirements, whether they be Amateur, Two-way Business Band, VHF Marine or Police Scanner.



Kenwood 7625
2m FM Transceiver

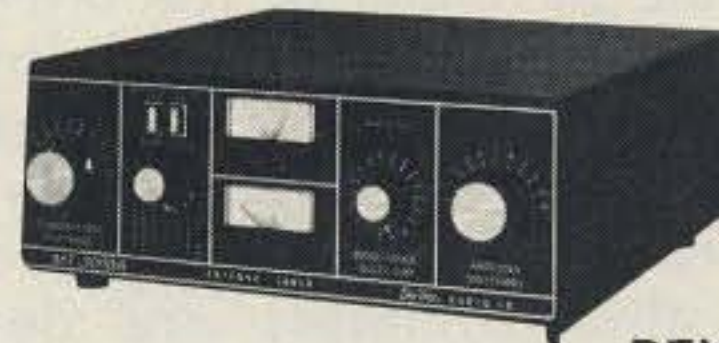

DENTRON MT-3000A
Deluxe Tuner

DENTRON 160-10 AT (not shown)
Super Tuner



TS 180S

TS 120S



Kenwood 7600
2m FM Transceiver

NATIONWIDE NUMBER

Call 206-364-8300 to place your order.

We will pay for call when order is shipped.

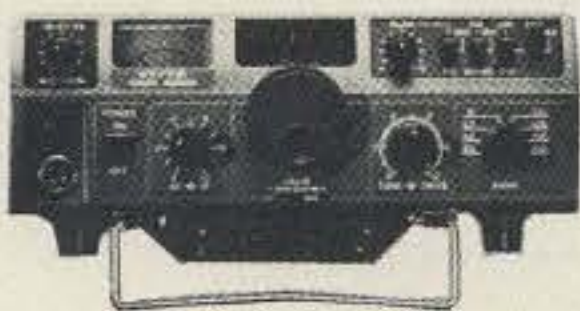

FT7B



FT-207R



YAESU 901 DM



Yaesu FT101ZD



A46

17550 15TH AVE. N.E. • SEATTLE, WASH. 98155 • (206) 364-8300

We also handle Wilson, Cushcraft, Hy-Gain, Antenna Specialists, KLM, etc.

Attention Washington residents: Come on in for excellent service in our complete Communications Repair Shop.

Write or call for SPECIAL tower, rotor, antenna package! Tri-Ex, Rohn, Wilson Towers. Shipping info: F.O.B. Seattle via UPS, truck, or parcel post.

Washington residents add sales tax.

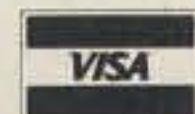

Other locations: (Walk-in customers only) • Bellevue — 12001 N. E. 12th • Everett — 4610 Evergreen Way • Open Mon. thru Sat.

response. The commercial filter is better, of course, and one will notice some difference on receiving, but it is a moot point as to whether any difference would be noticed when SSB filtering is considered for transmitting purposes or when rf speech processing equipment is being considered.

In order to achieve the response described, the filter must be constructed carefully, although this is not a tedious task. The filter is constructed basically as shown in Fig. 1, so the input-output terminals are as far apart as possible. Fig. 3 shows the layout used on an approximately 1½" x 5¼" piece of copperclad (single-side) PC board. There is no need to do any etching unless one just prefers to do this. The isolated-pad type of construction works very well, where a small hole is drilled for each crystal lead or pin (depending on the type of crystal used). The copper around the hole is removed for a small radius with an isolated-pad tool or with a sharp knife. The crystals are simply interconnected, and the few components required are soldered directly to the crystal leads or pins. The input-output cables are connected to any form of isolated terminal post. The trimmer capacitors used are Arco 423 units which have a range of 7-100 pF, but any similar units can be used. In fact, if one doesn't devote a little effort to finding reasonably-priced trimmer capacitors, they can cost more than the crystals!

The adjustment of the five trimmer capacitors will have a great deal of influence on the bandpass shape of the crystal filter. If one has fancy test gear available, such as spectrum display units, the work is, of course, relatively simple. But, even if one

has only relatively simple test equipment—rf generator and a suitable oscilloscope or a receiver—the filter can be adjusted easily enough.

First, set up the filter so the middle trimmer-capacitor is at minimum value, and the other capacitors are at maximum value. Then, as one goes through the passband of the filter with the rf generator, note how the response changes as the center trimmer is increased in value and the other trimmers are decreased. If one keeps a record of the responses for each adjustment of the trimmers, it will not be difficult to discern the pattern that develops. No attempt was made to adjust the trimmers by ear when the filter was used in a receiver, but possibly, with enough patience, it could be done.

The application of the filter to a piece of equipment, or the use of the filter in an accessory item, can follow the scheme shown in Fig. 4. This little setup made use of various International Crystal Company modular mixer and oscillator units to translate the crystal filter response to another i-f frequency that was of interest. However, this setup, or one similar to it that is suitable for the frequencies involved, can be used for many applications.

For instance, one can use it just to improve the i-f selectivity in an older piece of equipment, or those who are a bit more advanced in circuit construction can build a complete outboard rf speech processor for an SSB transmitter, using two crystal filters. (See Fig. 5.) A DSB signal is first generated, and one filter used to produce an SSB signal. The signal is then clipped and passed through the second filter to clean up the distortion products. The product

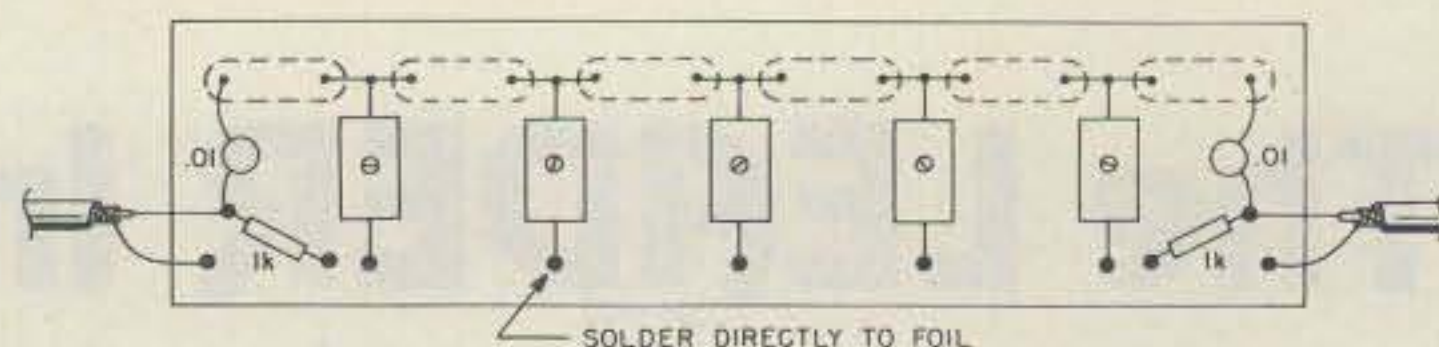

Fig. 3. Layout of a crystal filter board, foil side up. (Crystals are on the non-foil side.)

detector is used to obtain the final af signal. In this application, the two crystal filters should have identical passband responses—but this should not be difficult to achieve if they are constructed and adjusted together. During the adjustment process, one should note where the 20- to 30-dB down points are, on either the upper or lower side of the crystal filters, since either one of the two frequencies can be used as the carrier oscillator frequency.

Construction has been started on such a project, but it is not yet completed. Even using a modular approach as much as possible, by using kit-type modules of the kind shown in Fig. 4, the total cost for the project seems to be coming out in the \$25-\$30 range. That is not bad at all when one considers that it

includes the cost of two crystal filters, and one can pick up several dB of extra intelligibility under QRM conditions. Even if one does not achieve the full theoretical improvement possible with rf clipping, one can easily do better than by using an outboard audio compression or clipping accessory, and at nearly the same cost.

It is possible to use the crystal filter also as part of an adapter to add rf clipping to an SSB transmitter, by connecting it into the SSB generation chain. Unfortunately, one cannot generalize on how this can be done, since the response of the filter in the outboard adapter as compared to the response of the filter in the transmitter, along with the carrier oscillator frequencies, all have to be taken into account for a specific transmitter. ■

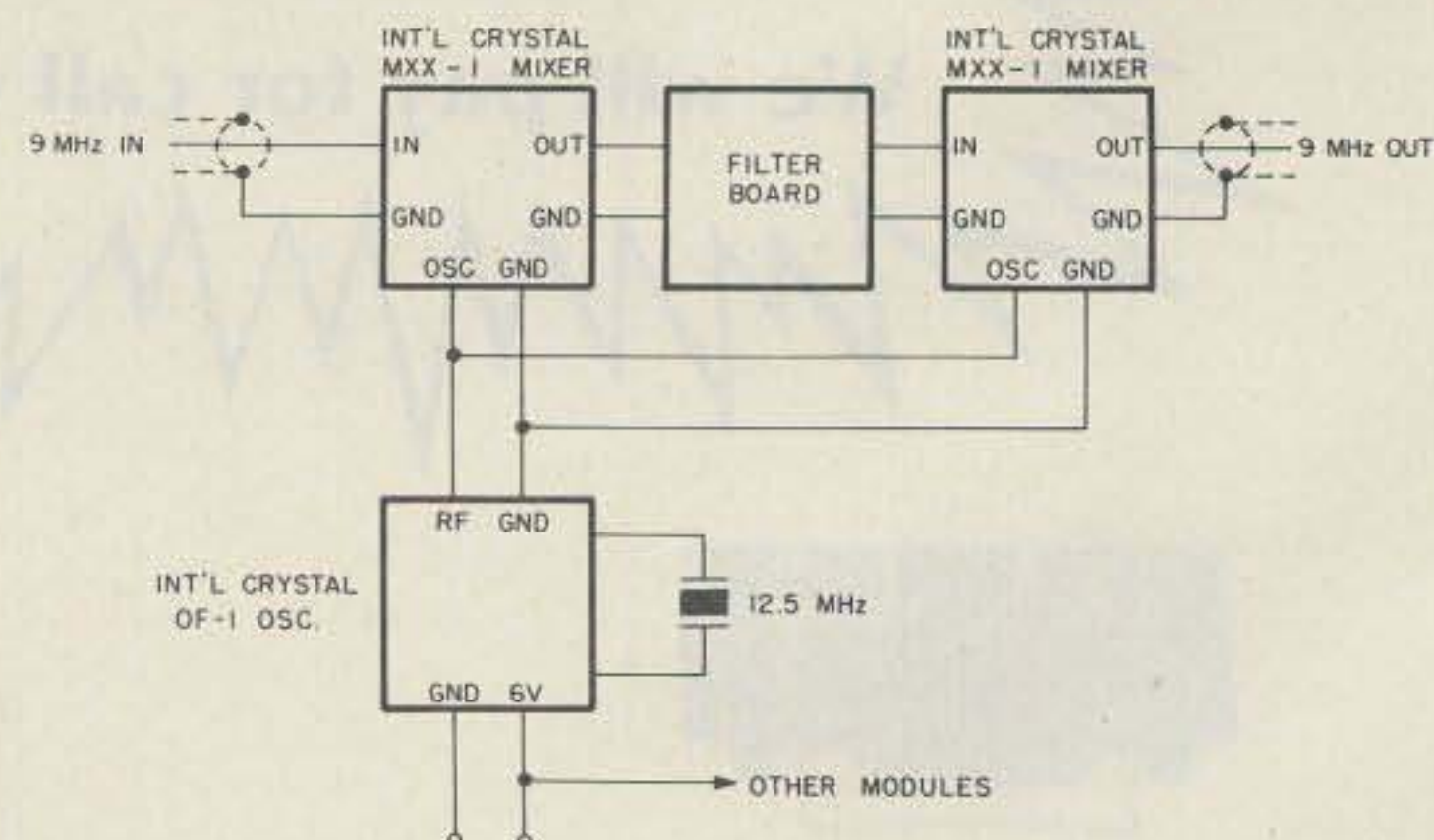

Fig. 4. One example of how the filter can be used in an i-f chain by frequency translation, using readily-available mixer/oscillator modules.

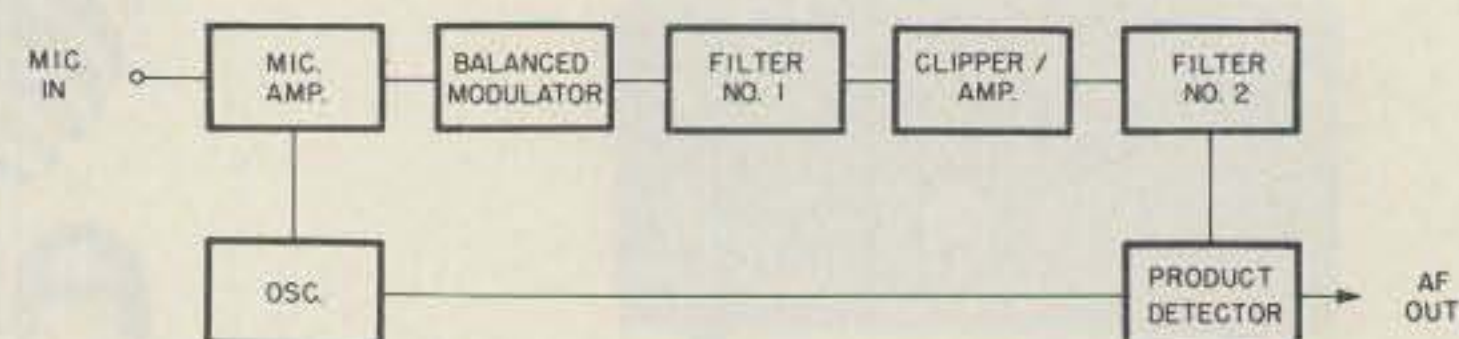

Fig. 5. Block diagram of a separate rf speech processor which now can be built at low cost using two series-string filters.

**When a DXer really wants to break through the pile-up...
He goes with G.I.S.M.O. & Dentron.**

The DTR-2000L



SPECIFICATIONS:

- Frequency Ranges:
 - 160 Meter Band 1.8 -2.5 MHz
 - 80 Meter Band 3.45-4.6 MHz
 - 40 Meter Band 6.00-9.0 MHz
 - 20 Meter Band 11.00-16.00 MHz
 - 15 Meter Band 20.95-23.50 MHz
- The DTR-2000L will cover most MARS frequencies just outside the Amateur Bands. (With proper coil tap changes and band switch modification, the unit will also cover the 10 meter amateur band.)
- Modes: USB, LSB, CW, RTTY, SSTV
- Power Requirements: 234/117 VAC 50/60 Hz
- RF Drive Power: 125 Watts maximum, and 65 Watts RMS minimum for 1 KW DC input.
- DC Plate Voltage: SSB (Idle + 2600V approximate), CW (Idle + 1800 V approximate)
- Duty Cycle: 100%
- Input Impedance: 50 Ohms nominal
- Input VSWR: 1.5 to 1 average
- Output Impedance: 50 Ohms nominal
- Antenna load VSWR: 3 to 1 maximum
- ALC: negative going, adjustable from rear panel.
- Spurious Emissions: IMD — greater than 30 db down, Harmonics — greater than 40 db down
- FCC Type Accepted
- Size: H 7¼" x W 14½" x D 14½"
- Weight: (including 8877) 54 pounds

The CLIPPERTON L



SPECIFICATIONS

- NEW FEATURE: HI-LO power switching
- 160 thru 15 meters
- 2000 watts PEP input on SSB
- 1000 watts DC input on CW, RTTY, or SSTV
- Forced air cooling
- Self contained continuous duty power supply 2500 V idle SSB — 1800 V idle CW approx.
- 4-572 B Triodes operating in grounded grid.
- Covers most MARS frequencies just outside Ham bands.
- 50 ohm input impedance unbalanced at better than 1.5 to 1 VSWR
- 50 ohm output impedance
- Harmonic Suppression: meets or exceeds FCC requirements
- Built-in ALC (adjustable)
- Easily changed 117V or 234V AC 50-60 hz
- Meter (illuminated) for plate voltage or plate current
- Size: 6" H x 14½" W x 14½" D Weight: 42 lbs.

The GLA-1000



SPECIFICATIONS

- Size: H. 5¾" W. 11" D. 11"
- Weight: 24 lbs.
- Electrical Power Consumption:
 - 117 VAC 50/60 Hz 12.5 Amps.
 - Factory fused at 15 Amps.
 - 234 VAC 50/60 Hz 7 Amps.
 - Recommended fuse 10 Amps.
- Frequency Coverage
 - 80 Mtrs: 3.45 to 4.3 MHz
 - 40 Mtrs: 6.950 to 7.5 MHz
 - 20 Mtrs: 13.950 to 14.5 MHz
 - 15 Mtrs: 20.950 to 21.350 MHz
 - 10 Mtrs: With Modification by Licensed Amateur (Covers most MARS frequencies just outside the Amateur Bands.)
- RF Drive: Maximum 135 Watts
- DC Input: 1 KW CW and 1200 Watts PEP SSB
- Input Impedance: 50 ohms 1.5: 1 VSWR APX.
- Spurious Emissions:
 - Ind better than 30 dB
 - Harmonics down better than 40 dB
- Components:
 - 4 — D-50A tubes (6LQ6)
 - 6 — Diodes
- FCC Type Accepted

The MLA-2500B



SPECIFICATIONS

- NEW FEATURE Hi-Lo power switching
- 160 thru 15 meters
- 2000 watts PEP input on SSB
- 1000 watts DC input on CW, RTTY, or SSTV Continuous Duty
- Variable forced air cooling system
- Self contained continuous duty power supply 2250 V idle SSB - 1575 V idle CW approx.
- Two EIMAC 8875 external-anode ceramic/metal triodes operating in grounded grid.
- Covers most MARS frequencies just outside Ham bands.
- 50 ohm input impedance unbalanced at better than 1.5 to 1 VSWR
- Harmonic Suppression: meets or exceeds FCC requirements
- Built-in ALC (negative going)
- Built in RF wattmeter
- Easily changed 117V or 234V AC 50-60 hz
- Third order distortion down better than 30 db
- Frequency Range: 1.8 Mhz (1.8-2.5) 3.5 Mhz (3.5-4.2) 7 Mhz (6.8-8.0) 14 Mhz (13.5-15.0) 21 Mhz (20.0-22.0)
- 65 watts minimum drive for 1 KW DC input
- Rack mounting kit available (standard 19" rack)
- Size: 5½" H x 14" W x 14" D
- Weight: 47 lbs.

✓ G22

G.I.S.M.O. 1-800-845-6183

In S. C. call 1-366-7157
2305 Cherry Road, Rock Hill, S.C.
29730 (Exit 66-B off I-77)

Four Bands on a Bamboo Pole

— try a Chinese vertical slanter on
10 through 40

*William R. Stocking WØVM
1030 Weidman Road
Manchester MO 63011*

Many of us hams like to work DX. My friend, Harry, who lives down the street, had worked many DX stations. I had worked no DX at all! I asked Harry what I could do to work DX.

"Get a long, bamboo fishpole and build a vertical J like mine," he replied. "Get the bottom of the antenna higher than the electric light wires. Get the thing resonant, and you'll work across the big pond."

Harry was my "consulting engineer," and taking his advice usually brought good results. I purchased a 23-foot bamboo fishpole and mounted it high on the house using some lightweight 1 by 2 lumber. A vertical J

antenna was suspended from the top of the fishpole. The matching stub was tuned to frequency, and the 600-Ohm open-wire feedline was attached and adjusted for the best transfer of rf energy into the antenna system. As usual, Harry was right. I got a big thrill the next day when I worked my first European station!

Seeing the big bamboo fishpole, one of my friends called it a "Chinese antenna." When I mentioned this to Harry, he laughed and remarked, "Maybe we can shanghai some DX." Since that time, bamboo fishpoles have been used in most of my vertical antennas, and the "shanghaiing" has been very good. (Fiberglass fishpoles 20 feet long also work well in antenna construction, but they are more expensive and are hard to find.)

This article will present information from some books and a magazine arti-

cle and explain how this information was applied in making a four-band "Chinese vertical slanter" antenna system that is the best non-beam DX antenna that I have ever used.

In the December, 1978, *73 Magazine*, antenna axioms were presented.¹ Among these were: (1) The antenna system should be resonant at the frequency being used. (2) The rf from the antenna must be effectively put into the antenna. (3) There is no substitute for height; the higher the antenna, the better. (4) At easy-to-attain heights, vertical antennas have lower angles of radiation than do horizontal antennas. This makes them good for DX.

Because of their lower angles of radiation, vertical antennas have been known to outperform horizontal beams in making DX contacts, especially in cases where the horizontal beam was not any higher off the ground than the

center of the vertical antenna. The value of low-angle radiation in working DX is beautifully explained in Capt. Paul Lee's book in Chapter 1, "Optimum Design For DX."² This chapter also contains other valuable information useful to antenna designers.

Vertical antennas longer than a quarter wavelength radiate rf at lower angles to the horizon than do quarter-wavelength ground-plane antennas. The angles of a quarter-wavelength ground-plane antenna are from 10 to 55 degrees. For a 3/8-wavelength vertical antenna, the angles are from 8 to 40 degrees. A half-wavelength vertical's angles are from 5 to 35 degrees. The angles of a 5/8-wavelength vertical are from 3 to 27 degrees.² For 3/4-wavelength verticals, "there is some slight deterioration of the low angle vertical pattern, but this is not serious."³

Vertical antennas longer

than a quarter wavelength also have power gain as compared with a quarter-wavelength ground-plane antenna.⁴ A half-wavelength vertical antenna has a power gain of 1.8 dB as compared with a quarter-wavelength ground-plane antenna. A 5/8-wavelength vertical antenna has a power gain of 3 dB as compared with a quarter-wavelength ground-plane antenna. One can surmise also that a 3/4-wavelength antenna has some power gain as compared with the ground-plane antenna.

From this information, it is clear that vertical antenna lengths between 1/4 and 3/4 wavelengths will be better for making DX contacts than the popular coax-fed ground-plane antenna. To use these ideas in a multiband vertical antenna, tuned feeders must be used to take the rf from the transmitter to the radiating wires. When tuned feeders are used, balanced antennas can be built with wires almost any length, provided that *the length each side of the tuned feeders is the same*. Furthermore, such an antenna can be "loaded up" and used on several bands.

My friend Harry was somewhat impressed with this information. He suggested, "Why don't you make a chart comparing a tuned-feeder vertical with the popular trap vertical that is about 22 feet tall? After you get that one figured out, figure out what length of wires would make the best all-around DX antenna for 40, 20, 15, and 10 meters."

My "figuring" was as follows. For all practical purposes, the trap vertical is a quarter-wavelength ground-plane antenna on all bands, with the highest frequency radiators closest to the ground. As such, the angles of radiation with respect to the horizon are from 10 to 55 degrees on

all bands. Except for the 40-meter band, on which all 21½ feet radiate, the trap vertical does not have its radiating antennas as high in the air as does a 22-foot "vertical slanter." (Axiom No. 3: "There is no substitute for height.")

With the vertical slanter, all 22 feet radiate on all bands. With respect to power gain and angles of radiation, the vertical slanter has the following as compared with the ¼-wavelength ground-plane antenna with its 10 to 55 degrees angles of radiation on all bands: On 10 meters, the vertical element is 5/8 wavelengths with a gain of 3 dB and angles of 3 to 27 degrees. On 15 meters, the vertical element is 1/2 wavelength with a gain of 1.8 dB and angles of 5 to 35 degrees. On 20 meters, the vertical element is a bit shorter than 3/8 wavelength, would have some gain as compared with the trap vertical, and the angles of radiation would be somewhat lower than those of the trap vertical.

With a ground-plane antenna using 4 equally-spaced radials, the radials do not radiate because the fields of the radials cancel out each other. Drooping the radials increases the gain of the ground-plane antenna.⁵ Therefore, it is logical that a vertical-slantant tuned doublet, or a one-radial tuned ground-plane antenna might have some gain compared with a quarter-wavelength ground-plane antenna because there are no other radials to cancel radiation from the lower half of the antenna.⁶

Another great advantage of a vertical-slantant tuned doublet is that it can be tuned to exact resonance at any frequency, phone or CW, on any band, 10, 15, 20, or 40 meters. This means that the antenna will load up equally well on phone and CW in all of

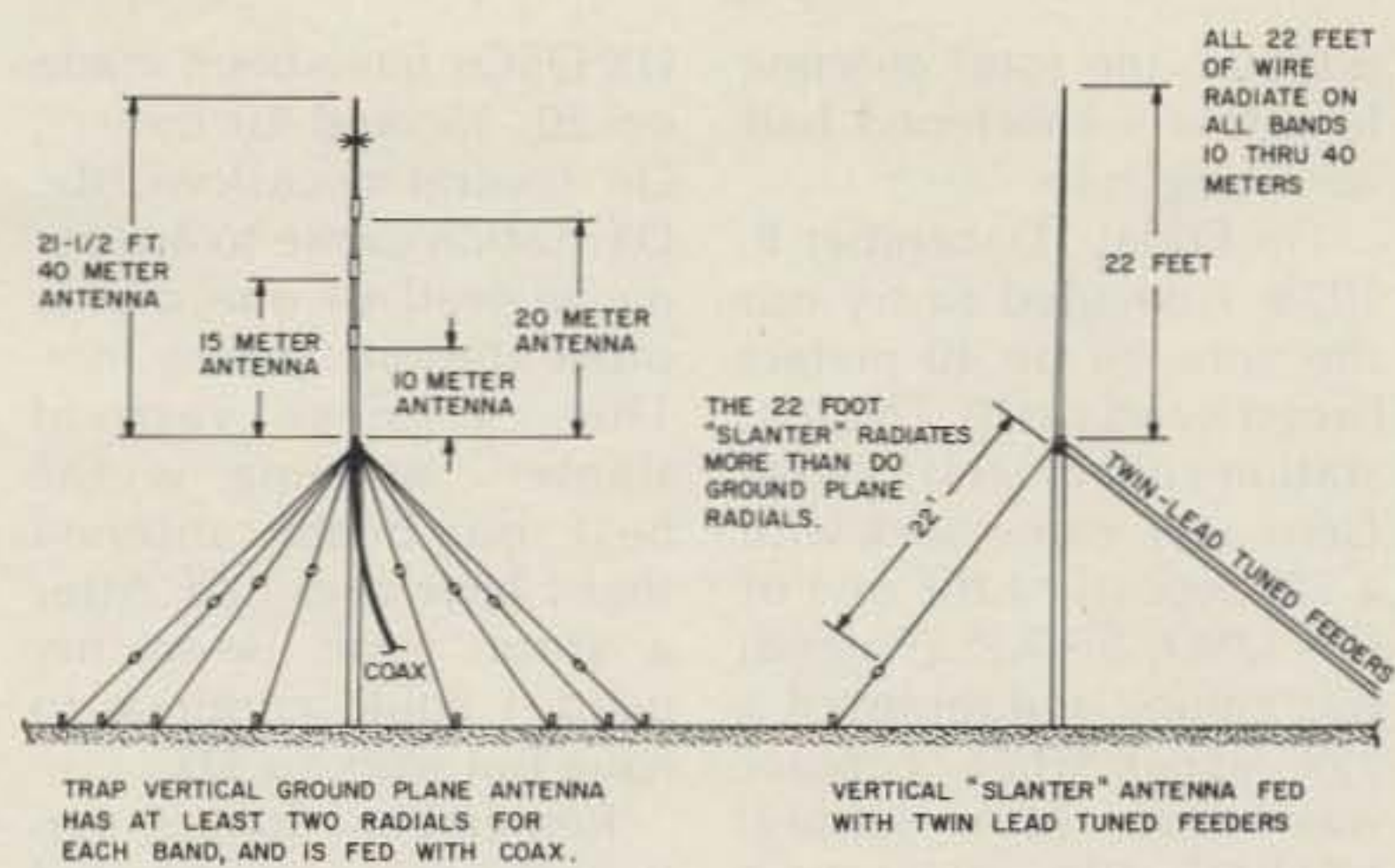

Fig. 1. Typical trap vertical and "vertical-slantant" four-band antenna fed with tuned feeders. The bottom of each vertical element is 20 feet above the ground.

these bands.

Harry made this suggestion: "When you figure the best wire lengths for your four-band DX vertical slantant, make the wires as long as you can without degrading the performance on 10 meters. Of course, if you want better performance on 40 and 20 meters and don't care about 10 meters, you could make your wires as long as possible without degrading the 15-meter performance."

With this in mind, I chose 26 feet as the wire-length for the best performance on 10, 15, 20, and 40 meters. Twenty-six feet is 3/4 wavelength for 10 meters. If I did not care to work 10 meters, I would have chosen 33 feet, 3/4 wavelength for 15 meters.

The gain and angles of radiation for the 26-foot wire vertical-slantant antenna are conservatively stated as follows: 10 meters (3/4 wavelength), "guesstimated" 2.5 dB, with angles 5 to 35 degrees; 15 meters (5/8 wavelength), 3 dB, with angles 3 to 27 degrees; 20 meters (.39 wavelength), "guesstimated" 1.4 dB, with angles somewhat less than the 10-50 degrees of a quarter-wavelength ground-plane antenna. On 40 meters, 26-foot-long wires would work better than 22-foot-long wires.

Since in theory a vertical-slantant antenna fed with tuned feeders seemed to be much better than a four-band trap vertical, I decided to build one and try it out. I had an old, used piece of no. 12 Romex, 25' 8" long. This was very close to 26 feet, so I took out the two wires and used them in the antenna. A bicycle whip taped to a bamboo fish-pole clamped to a small sailboat mast supported by two 8' two-by-fours clamped to a fence post was used to support the vertical part of the antenna. The black wire was taped to the supporting structure as the vertical element. (The black color helped to absorb heat and melt the ice after an ice storm.) The white wire was used as the slantant which was drooped down and out towards the south. 300-Ohm twinlead was used for the tuned feedline. The "Chinese vertical slantant" antenna looked interesting, but would it really work?

I thought that 40 meters would be the band on which the antenna would be least effective. (If thought of as a one-radial tuned ground-plane antenna, the vertical element is less than a quarter wavelength long. If thought of as a center-fed tuned

doublet, the total antenna length is a shortened half wavelength.)

On Friday, December 8, 1978, I decided to try out the antenna on 40 meters (worst band first!). The first station called, DJ4IT (West Germany), came back with a 579 report. At the end of this QSO, SP7EJS (Poland) was calling and reported a 559 signal when contact was made. After supper, LZ1KUF (Bulgaria) was called, but he did not come back. (I was not sure whether or not he had called CQ.) The next two calls resulted in QSOs. DL7PR (West Germany) reported 569, and YU1QFX (Yugoslavia) reported 599. (I suspect that this report was exaggerated for the sake of international goodwill. Hi!) These QSOs convinced me that the antenna worked well on 40 meters. Since that time, with very little time on the air, many

DX QSOs have been made on 20, 15, and 10 meters. On several occasions, the DX station chose to answer me instead of one of the other stations calling him. This "Chinese vertical slanter" antenna is the best non-beam antenna that I have ever had. After a storm took down my quad, I could continue to have fun working DX.

Remember that a vertical slanter fed with tuned feeders will load up equally well on both CW and phone frequencies. The above-described antenna even loaded up and made a few contacts on 80 meters. However, the wires are much too short for good performance on the 80-meter band.

For even better performance, a system of radials each about 35 feet long, buried in the ground, could be added to the antenna system. The center of the

radials should be under the vertical element. The more radials, the better. However, the antenna works well without radials as the above information indicates.

I have no trap vertical with which to compare the "Chinese vertical slanter" using on-the-air contacts. Certainly DX can be worked using trap verticals and other coax-fed ground-plane antennas. However, antennas with more gain, lower angles of radiation, and more effective feed systems will certainly outperform any comparable coax-fed ground-plane antenna when it comes to making DX contacts.

I think you'll enjoy the "Chinese vertical slanter antenna." Build one, use it, and find out for yourself how good a non-beam antenna can be for working DX. ■

References

1. "Tuned Feeders and Other Good Stuff," William R. Stocking W0VM, *73 Magazine*, December, 1978, p. 118.
2. Capt. Paul H. Lee (USNR) K6TS, *The Amateur Radio Vertical Antenna Handbook*, p. 13.
3. Edward M. Noll, *73 Vertical, Beam, and Triangle Antennas*, p. 35.
4. William I. Orr W6SAI and Stuart D. Cowan W2LX, *Simple, Low-Cost Wire Antennas for Radio Amateurs*, p. 43.
5. William I. Orr W6SAI and Stuart D. Cowan W2LX, *The Radio Amateur Antenna Handbook*, pps. 88 and 92.
6. This idea does not take into consideration ground losses. It might be that four drooping radials, each the same length as the vertical element, would enhance the performance of the antenna because there would be less ground loss. Radials buried in the ground under the vertical-slant antenna might improve its performance, and they are suggested near the end of the article.

**IT'S NEW!
IT'S HERE...**



Size: 9" x 14"

The QSL Organizer

File, preserve and display
240 QSL Cards
in this handsome **FREE** Album.

Tired of cluttering up your walls, stuffing QSL's in drawers and boxes? A great new way to organize, preserve and display your QSL cards is in clear vinyl pocket pages. Each specially designed crystal clear heavy duty page, holds 6 cards (back to back). The roomy 4" x 6" pockets even hold those extra large Japanese QSL's. With every 40 pages (minimum) ordered, you'll receive a Free handsome 9" x 14" sturdy 3-ring album, fully padded, in durable 'Brown-Hide' vinyl.

As gifts for friends, as valuable club prizes, or as a treat for yourself — the QSL Organizer is a must, for every ham shack. Fill in and mail the handy order form . . . today!

Try it for 30 days. If you're not delighted, return it for full refund.

HANDY ORDER FORM

Please send: Larger quantities, ask for quote.

1 FREE Album and 40 pages (min) at .47 each Total *\$18.80

2 FREE Albums and 80 pages at .45 each Total *\$36.00

3 FREE Albums and 120 pages at .44 each Total *\$52.80

* Postage & Handling • 40 Pages add \$1.95 • 80 Pages add \$3.45 • 120 Pages add \$4.75

Check or Money Order enclosed (No COD) \$ (CA residents add 6% tax)

Ship to: (Please Print) Mail to: M109

Name **MIL INDUSTRIES**

Address Dept 3

City State Zip P. O. Box #44457

Panorama City, CA 91402

LUMITIME

CC-24 Digital Alarm Clock

U.L. APPROVED



\$27.95

24 hour numerals and 24 hour alarm. The illuminated orange bar numerals are 1 5/8" high. Also featured are new slim line styling, catnap control and an illuminated constantly changing kaleidoscopic pattern to indicate continuous operation. Available in Beige or Charcoal-Brown case colors.

Size: 2 1/4" x 4 1/8" x 8 3/4"

MADISON

ELECTRONICS SUPPLY, INC.

1508 McKINNEY • HOUSTON, TEXAS 77002
713/658-0268

MASTERCHARGE • VISA

W5GJ, W5MBB, K5AAD, N5JJ, AG5K, W5VVM, W5EGP,
WA5TGU, WB5AYF, K5BGB.

DLA!

CALL TOLL FREE
1-800-228-4097



Hy-Gain 3806
 2-Meter Hand-Held Amateur Transceiver

SPECIALLY PRICED ONLY \$119.⁹⁵

- Low cost, 6-channel hand-held provides superb voice transmission over short to medium distances
- Sharply tuned on-frequency selectivity in the RF amplifier stages plus FET's in the 1st and 2nd mixers for virtual immunity to out-of-band signals intermodulation distortion and cross-modulation
- Separate microphone and speaker elements for enhanced audio
- Internally adjustable mic preamp—a Hy-Gain exclusive
- Specially gasketed case seals out water, dirt and corrosive salt air
- Watertight, high-impact ABS plastic case—ribbed for non-slip grip
- Top-mounted controls for instant access

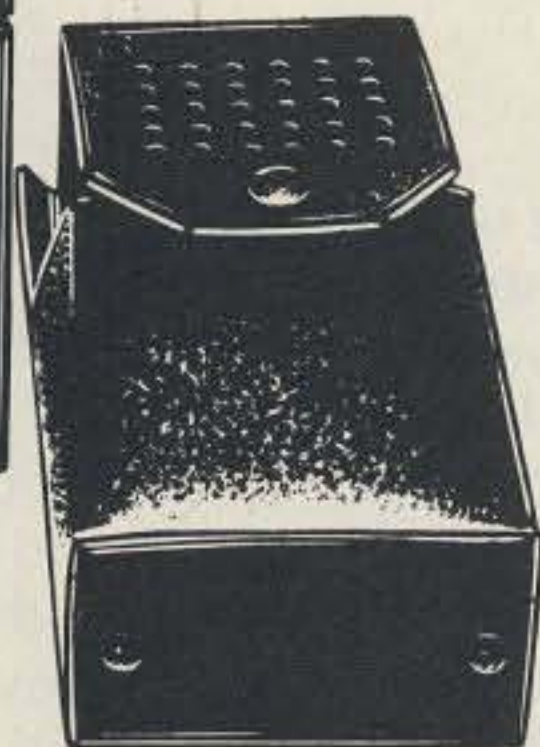

Accessories:

Model No.	Description	Price
3807	Nicad Battery Pack	\$31.95
1104	Touch Tone Pad	\$44.95
1106	AC Battery Charger	\$ 9.95
1107	Cigarette Lighter Adaptor Cord	\$ 9.95
1108	Antenna Adaptor Cord	\$ 9.95
1110	Carrying Case (Leather)	\$17.85
1111	Carrying Case (Vinyl)	\$ 9.95
269	Rubber Duck Antenna	\$ 5.95
	Crystal Certificates	\$ 3.95

PLEASE ENCLOSE \$2.50 FOR SHIPPING AND HANDLING PER UNIT

CALL TOLL FREE
1-800-228-4097

for Quality Ham Radio Products at Discount Prices

YAESU
 KENWOOD
 DRAKE
 ICOM
 STANDARD
 EDGE COM
 KDK
 PANASONIC

DENTRON
 HY-GAIN
 MOSLEY
 CUSHCRAFT
 WILSON
 HUSTLER
 LARSEN
 BENCHER
 ROBOT

TAYLOR
 SWAN
 TEMPO
 TEN-TEC
 MIDLAND
 CDE
 AUTEK
 MIRAGE
 AEA

E.T.O. ALPHA
 VHF ENGINEERING
 BERK-TEK CABLE
 CONSOLIDATED TOWER
 SAY
 SHURE
 TELEX
 ROBOT-SSTV
 BENCHER

Our Mail Order Hours (CST)

M-F 8 am to 12 Midnight
 Saturday 8 am to 6 pm
 Sunday 12 Noon to 8 am

Call and Talk to

Don	WBØYEZ	Ken	WDØEMR
Denny	WØQR	Eli	KAØCEJ
Bill	WBØYHJ	John	WBØMTS
Joe	WAØWRI	Blaine	WBØQLH
Jim	KAØCRK	Bob	WBØRQZ



C58

Communications Center

443 N. 48th, Lincoln, Nebraska 68504

In Nebraska Call (402) 466-8402



The Triton IV Goes QRP

— simply and efficiently

C. Stewart Gillmor W1FK
Spencer Road
Higganum CT 06441

My last tube rig (I sold it 20 years ago) had something like 1400 volts at 300 mA on the plates of the final tubes. It amuses me, while getting good reports on 20 meters, to glance at a meter and see that I am running 3½ volts on the finals of my Triton IV! Basically, this is a good way to run the popular Ten-Tec Triton transceiver efficiently at very low power input levels. In this article, I will show how you can modify the Triton IV for such operation and yet drill no holes and make no changes which could not easily be redone to put the rig back into original specifications. This idea

originated with Mac Harper W1FYM, who made the same modifications to his Triton IV and suggested I modify mine so that our two rigs could form the basis for the portable QRP station at W1FYM/1 for Field Days 1977 and 1978. The Field Day setup was battery-powered, including our computer logging and TV monitor equipment, and it has performed quite well through 2 Field Days. But the computerized QRP Field Day station is another story . . . one that W1FYM must write.

The modifications described here allow the Triton IV not only to operate very efficiently at 10 Watts input for Field Day, but also they allow such operation any time you wish, merely with the changing of the 6-connec-

tor power plug to the transceiver. The design idea could easily be altered to suit other solid-state rigs as well. Now you may say, "But my solid-state rig is easily capable of QRP operation as is. I just back down the drive to the finals until I'm drawing about 0.8 Amps at 12 volts and I'm running about 10 Watts input." "Ah, yes," I reply, "10 Watts input, but very little output!" Instead of 1 or 2 Watts out, your rig could be putting 6 or 7 Watts out for the same 10 Watts input if you ran the finals more efficiently. A good way to do this is to run them at much lower voltage. A very satisfactory choice for the 5-to-10-Watt power class is about 3.5 volts. The necessary modifications for this are described in two parts: modifications to the Triton IV and construction of an integrated circuit variable voltage regulator.

Modifying the Triton IV

Basically, what we want to do here is allow the driver and final amplifier transistors to have their own voltage feed separate from that which feeds the rest of the transceiver and auxiliary equipment. Ten-Tec uses a 6-connector

power plug and socket to run power leads and ac switching from the model 252 and 262 power supplies to the transceiver. Pins 1 and 2 are for ac switching and need not be altered. Pins 3 and 4 are grounded and likewise may be left untouched. Pins 5 and 6 are for +12 V dc. This pair is originally soldered together at the power plug to reduce pin resistance. To modify the Triton IV, proceed as follows (refer also to Fig. 1): Separate pins 5 and 6 at the power plug at the left rear of the Triton IV. Resolder the red #14 stranded wire onto pin 6 alone. Follow this red wire to its other end, through the AGC 20-Amp fuse to the cathode end of the 1N3492R diode (diode D1), at the 3-terminal strip. Disconnect this red #14 wire from diode D1 and run it in a 2-turn loop through the ferrite bead directly to the "+12 Final" terminal on the back of the final amplifier metal box; solder it securely. The "+12 Final" terminal is the large one with the solder lug. What you have now done is make pin 6 on the power plug of the Triton dedicated to providing dc solely to the driver and final amplifier transistors. For

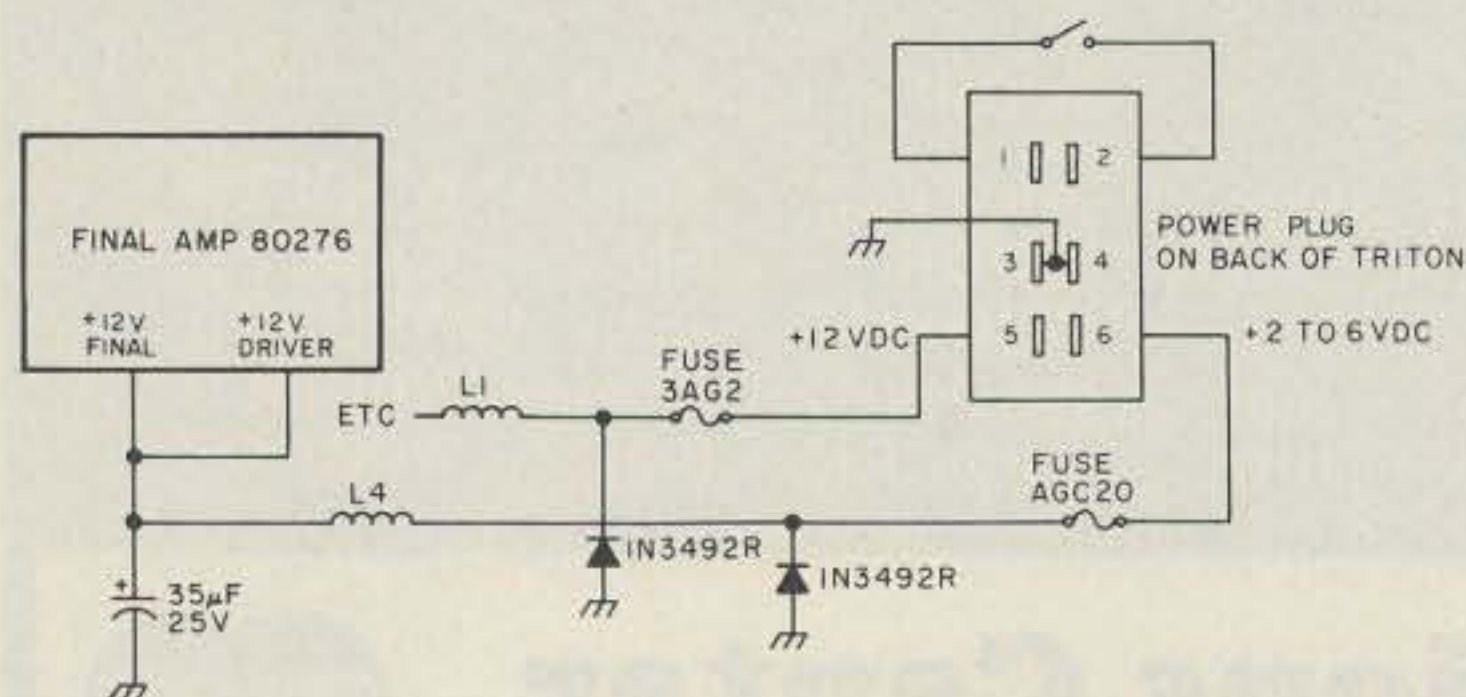

Fig. 1. Schematic of Triton IV as modified for efficient QRP operation.

Amateur Radio Supply of Nashville, Inc.

615 South Gallatin Road - Madison, Tennessee 37115

CALL A.R.S.O.N. NOW!

615 868-4956

for the Best DEALS

Sure, we take trades on new equipment! Call or write.

We're Burning to make "HOT" Deals!!

✓ A40



Accepted at slightly higher prices!

YAESU

NEW!
NOW IN STOCK!
FT1012D
Digital 160M-10M Deluxe Features
Check the others then get our price!

YAESU FT 901 DM
Call for yours today!

NEW! **YAESU FT207R**
Synthesized Handi-Talkie.
2 Watts

CALL NOW FOR OUR PRICE!
We stock the complete YAESU line!

Dentron

Dentron GLA 1000
1 KW DC INPUT!
1200 W. PEP!
LOW PRICES!

NEW!
Dentron HF 200A
Fixed or Mobile!
200 WATTS P.E.P.

We have the New Dentron AF-1A Audio Processor, Dentron Antenna Tuners, Antennas and SWR Meters.
CLIPPERTON L • MLA 2500 B • DTR 2000L
CHECK OUR LOW PRICES!

MIRAGE MP2 VHF SWR MTR
B108 2M AMP • MP1 HF SWR MTR
IN STOCK! Call or write for prices!

BW ANTENNA SWITCHES in stock!

DAIWA
J. W. Miller

Call or write for SUPER LOW prices!

USED EQUIPMENT? OUR STOCK TURNS FAST. WRITE OR CALL YOUR SPECIFIC NEEDS.

KENWOOD

NEW!
TS 180S
All Solid State with Digital Frequency Control. 200W P.E.P. Memory. Best Price Anywhere!

NEW! **TS 120S**
ALL SOLID STATE HF TRANSCEIVER PLUS A FULL LINE OF ACCESSORIES!

TR 7600
TR 7625
10 or 25 Watt FM 2 meter xcvr synthesized with memory. Get our best price!

NEW! **TS 520 SE**
A new version of the FAMOUS STANDARD!
Call or write for our price!

IN STOCK! Ask about the RM 76 Micro Processor for the 7600/7625.

We stock the full KENWOOD line and provide warranty and after-warranty service. BUY WITH CONFIDENCE!

DRAKE

TR/DR-7
Now in stock!
Full 7 line of accessories!

MFJ ENTERPRISES, INC.
... TUNERS - FILTERS - CLOCKS
WE GOT 'EM - CHECK US FIRST!

ALLIANCE

Rotor Special
ALLIANCE HD-73

SPECIAL OFFER!!
\$105.00 Including Shipping in U.S.A.
HD-73 with 100 feet rotor cable \$120.00
HD73 with 100 feet rotor cable and 100 feet RGPU \$150.00
Cashiers check or M.O. please.

CDE ROTOR SPECIALS
The NEW HAM IV Rotor
Shipping included

HAM IV Rotor \$147.00
HAM IV Rotor with 100 ft. rotor cable \$162.00
HAM IV Rotor plus 100 ft each - rotor cable and first grade RGPU \$185.00
Send cashiers check or M.O. please.

SEND FOR OUR PINK SHEET SPECIALS! USED AND CLEARANCE GEAR!

SWAN ELECTRONICS

NEW!
ASTRO 150
HF SSB Transceiver featuring "VRS"
Fully Synthesized 235 Watts PEP & CW. See the Swan ads and Call us or write for BEST PRICES ANYWHERE!

NEW! **102BX**
Dual PTO's SYNTHESIZED 1.8-30 MHZ 235 Watts PEP

SWAN 100 MX
P.S. and ANT. TUNER.
Call or write for quote - ideal for home QTH or mobile!

DATONG
We have in stock the amazing Datong FL-1 active audio filter. Also now have the ASP, Automatic speech processor... plus the Code tutor... Fantastic additions to your station. Call or write for information and prices.

ICOM Compare our PRICES!
701, 211, 215, 280, 30A - All in stock!

ROBOT

SSTV - ROBOT
PUT YOURSELF IN THE PICTURE!
Get in on the latest in Ham Radio!
CALL OR WRITE NOW FOR PRICES!

DSI Counter Semi-kit
Get On Frequency!
WRITE OR CALL FOR SPECIAL PRICE!

TEN-TEC **OMNI**
D&A
UNBEATABLE PRICES
Full TEN-TEC Line in stock!

ANTENNAS CUSHCRAFT - HYGAIN
LARSEN - HUSTLER - AVANTI

avanti antennas

The fantastic new Avanti 2 meter Mobile Antenna - mounts on your car window glass! 3 DB gain. Neat and compact installation - GET OUR LOW PRICE NOW!!!

Fast UPS Delivery. Place your order then STAND BACK! We ship your order the same day we get it. Best prices and quick handling of your order.

SUMMER STORE HOURS - Monday thru Friday - 9 AM - 5 PM

Amateur Radio Supply of Nashville, Inc.

safety, in case you mistakenly reverse your battery polarity, it might be wise to buy another 1N3492R high-power diode and install it across the line to ground in reverse-bias polarity position. This can be mounted on the opposite end of the 3-terminal strip from the other 1N3492R diode. Solder the cathode end (marked with a bar) to the #14 red wire going to the final amplifier transistors and the anode end to ground. Then, should you goof and reverse the battery leads (such as happened at 3:00 am in the middle of Field Day to yours truly), the diode will conduct, blow the 20-Amp fuse, and save your rig.

Now, take a new (say, orange-colored) piece of #14 stranded insulated wire and solder it to pin 5 of the Triton power plug. Push it through one of the cable holes in the metal shielding around the low-pass filter section and leave a few inches extra. Now take a small screw-mounting 3AG fuse holder and mount this to the outside of the low-pass filter shield. There is a screw very near coil L4 on the low-pass filter board which holds the board to the shield. The fuse holder can be mounted very easily on the back side of this aluminum shield. No holes need be drilled. Note: The toroid-core coil, L4, on the low-pass shield board is not the same coil as "L4" in my Fig. 1. The latter is a ferrite bead through which the final dc supply line is wound for 2 turns of rf shielding.

Now that you have mounted the 3AG fuse holder, connect your orange wire to one end and install a small, 2-Ampere fuse in the holder. From the other end of the fuse holder, run the same size orange wire along parallel

to the back of the final-amplifier metal box until it reaches the 3-terminal strip where diode D1 is mounted. Solder the orange wire to the near end of the terminal strip; this is the same point where the cathode end of diode D1 and also 2 small #24 red wires are soldered. You have now completed the Triton modification. The orange wire from pin 5 of the power plug runs through a 2-Amp fuse and continues on to supply +12 V dc to all of the rig except the driver and final stages. Your regular 6-connector power socket from your model 252 or 262 power supply will work the same as before except that now you have the option to supply pins 5 and 6 on the power plug with different dc voltages if you choose. A way to supply different voltages is described below.

Variable-Voltage Regulation Using an IC Regulator

All you really need to do to supply the Triton final transistors with low voltage for highly efficient QRP operation is provide dc at from 2 to 6 volts at anywhere from 1 to 5 Amps. If you already have a small multi-voltage dc supply, fine. Or you can consult one of the ham handbooks and find a circuit which supplies dc at only a single voltage level. This would work perfectly well, for you can vary power input of the Triton using the drive control. I will describe here a variable-voltage regulated supply which provides 2 to 6 volts out and easily handles 5 Amperes (see Fig. 2). This was constructed in W1FYM's shack in one evening using some purchased and some scrap parts. The circuit was mounted on PC board. I purchased a heat sink somewhat larger than necessary, and the pass transistor (HEPS7004) is rat-

ed at 15 Amps! Since the case of this large power transistor is not at ground potential but at +12 V dc, we mounted the circuit board on the heat sink, which in turn was mounted on 2 insulating pieces of nylon scrap. The μ A723 IC was mounted in a socket rather than being soldered. I always avoid soldering IC chips, if possible, because everybody ends up frying a chip now and then and it's a lot easier to test or change a chip which is socket-mounted.

Ten-Tec sells a small accessory 625-mV meter (ammeter model 207) which plugs into the various power supplies of their 250 and 260 series, using a phono plug. We wanted to monitor our current input during Field Day and other QRP operation but didn't want to buy or permanently install a meter, so we put a phono jack on the board and wound a wire shunt of about 0.7 Ohms value so that the meter reads 5 Amps full scale. Of course, you could use a different meter movement with a different shunt value. The 1k pot is an Ohmite ANP 102K or similar and its value, as well as that of the 330-Ohm $\frac{1}{2}$ -Watt resistor, is not critical. The IC used by us was a Fairchild μ A723, but equivalents are available from firms including Motorola (MC1723), National (LM723), and Signetics (μ A723). Q1 is a

1-Ampere-rated pass transistor, Texas Instruments TIP29B or equivalent; Q2 is the 15-Ampere-rated HEPS7004. We used #12 stranded copper wire with large battery clips to supply the 12 V dc from the battery to the regulator power plug (pin 5 and pins 3-4). I would recommend using #14 or #16 stranded copper wire from the emitter of Q2 to the shunt and on to pin 6 of the power socket.

The construction and use of the regulator is straightforward. The 1k pot can easily be adjusted for output voltages from about 2 to 6 volts. W1FYM has had only to replace one fried IC chip in a year and a half of occasional use and I have had absolutely no troubles at all. Believe it or not, I've often had 579 and 599 reports on both CW and SSB into Europe and South America on 20 meters. Those reports aren't due only to the Triton IV QRP... I use long vee-beams 6 to 8 wavelengths on a leg and multi-element wire colinear beams at my QTH. Still, I've described a fairly-easy-to-make modification to the Triton IV and the construction of a modest voltage regulator which not only makes for a competitive Field Day rig, but also allows one to use a medium-powered solid-state rig such as the Triton in highly efficient QRP operation. ■

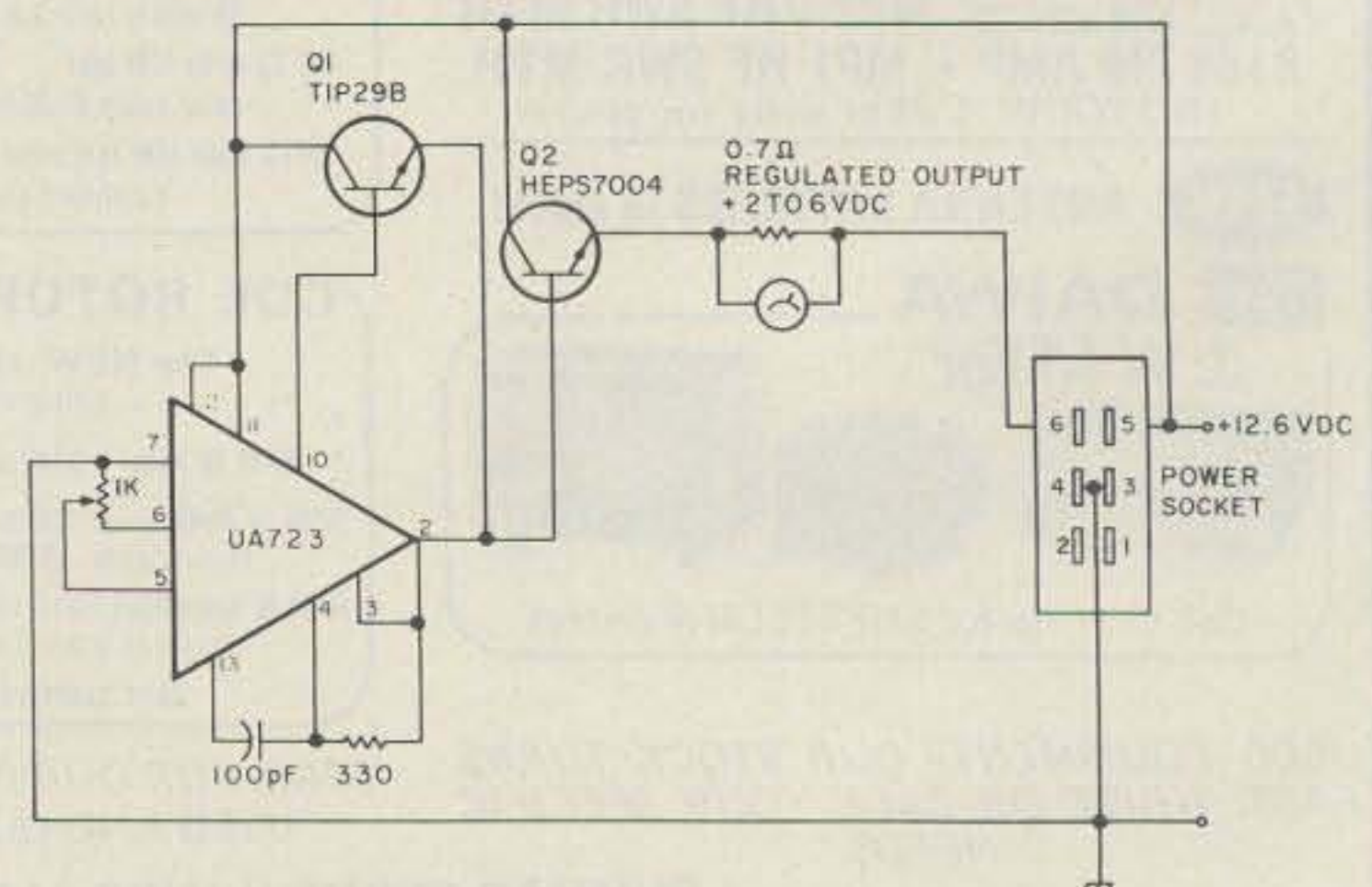

Fig. 2. QRP voltage regulator for the Triton IV.

new

SCR 4000

The Super-Deluxe 450MHz Repeater!

Features

- 30W. Output
- Low Noise/Wide Dynamic Range Front End for Excellent Sensitivity & Rejection of IM's & Spurious Responses.
- Sensitivity: 0.35uV Typ.
- 8 Pole 21.4 MHz IF Crystal Filter for Super Selectivity & Image Rejection.
- Receiver Discriminator & Deviation Meter Functions!
- Ultra-High Stability Transmitter Crystal Oscillator/Oven.
- Plus—All of the Many Other Features Found in the SCR1000 VHF Repeater—Full Metering, Lighted Status Indicators/Control Push-buttons, Btry. Pwr. Input, AC Pwr. Supply, CW IDer, etc., etc.!



180 Day Warranty!

Shown in optional cabinet

Spec Comm is proud to announce the new SCR4000 UHF FM Repeater! This unit incorporates all of the many desirable repeater control, test and operating features which have been requested by our customers over the past 2½ years. The SCR4000 includes completely new transmitter and receiver boards which were specifically designed for this new repeater. The rest of the unit is basically the same as our tried and proven SCR1000 VHF Repeater which has an excellent reputation for performance and reliability throughout the world!

Of course, the SCR1000 VHF unit is still available in 2 Mtr. and 220 MHz versions along with a complete line of options and accessories for all versions of our repeaters ... such as: Full Autopatch/Reverse Patch/Land-Line Control; Touch-Tone Control of various repeater functions; "PL" - CTCSS; "Emergency Pwr. I.D."; various Courtesy Tone and Timer units, etc. PLUS—the finest Duplexers, Cabinets, Antennas, Cables, etc.

The SCR4000 and SCR1000 are sold factory direct only or through Foreign Sales Reps—at prices which are only about ½ that of the "big two" names in 2-way radio! Get your order in A.S.A.P.!

Spec-Comm Repeater Boards & Sub-Assemblies

2M & 220 MHz!

- FL-6 Preselector. Rcvr. Front-End Filter/Preamp. Exc. rejection of strong "out of band" sigs. -60dB @ ±6 MHz. \$85.00
- SCR100 Receiver Board w/xtal & 8 Pole IF Filter. \$139.95
- SCR100 Receiver Assembly. SCR100 mounted in shielded housing. \$205.00
- SCT110 Xmtr./Exciter Bd. 7 or 10 Wt. bd. \$139.95 w/xtal. BA-10 30 Wt. Amp. bd. & Ht. Sink. \$55.95
- SCT110 Transmitter Assembly. SCT110 mounted in shielded housing. \$205.00 (30 Wt. Amp. + \$69.95)
- CTC100 COR/Timer/Control Bd. \$36.00
- ID250 CW ID/AF Mixer Bd. Programmed. \$75.00
- SCAP Autopatch Bd. \$235.00
- RPCM "Reverse Patch" & Control Bd. \$79.95
- TTC100 Touch Tone Control Bd. 3 or 2 digit control, 1 or 2 functions. \$85.00
- TRA-1 Timer Reset Annunciator Bd. \$20.95
- TMR-1 Timer Bd. \$20.95
- OS-18 TX Xtal Osc. Joven. w/xtal. \$85.00

(Add \$3.75 ship/handling. PA residents add 6% tax.)

new COMMERCIAL MOBILE & BASE TRANSCEIVERS

Spec Comm "Professional Communications Line"

- 136-174 MHz & 220-240 MHz (450 soon)
- 6 channels
- 0.35 uV Rcvr.
- 6 or 8 Pole Crystal Ftr.
- Beautiful Audio—RX & TX
- Very Reasonable Price!

• Very attractive woodgrain housing



SC 250 25 wt. Mobile unit

• "Super Rugged" Housing

SC 300 25-30 wt. Base station

- Built-in AC Power Supply
- Front Panel Status Indicator Lights
- Optional Rcvr. Scanning Function Available



SPECTRUM COMMUNICATIONS

Write or call for Data Sheets, prices, etc. • Export orders—Contact our International Dept.

1055 W. Germantown Pk., Dept. S9 • Norristown PA 19401 • (215) 631-1710

Experimenter's Corner: The MM5369N

—how many uses can you find
for this one-chip crystal oscillator?

Charles B. Patten
4641-4 Chicago Drive
Andrews AFB MD 20335

Would you like a simple, versatile, crystal-controlled oscillator? Would you like it to operate from below 500 kHz to over 16 MHz, with rich harmonic content, simply by changing crystals? Too good to be true? Read on, it gets better!

The MM5369N—see Fig. 1(a) and (b)—is a CMOS integrated circuit that is configured to provide a crystal oscillator (you supply the crystal) with a buffered output (maximum avail-

able load about 500 μ A) and an internally-connected divide-by-59659 (or 215.864452175) divider chain which provides, in the manufacturer's intended use, a 60 Hz output for dc-operated digital clocks when used with an inexpensive 3.579545 MHz crystal. This, and numerous other uses, will be mentioned as we proceed.

How It Works

The crystal oscillator is biased by a crystal and RC network (Fig. 2) consisting of R1, C1, and C2. R1 is nominally 20 megohms to bias the oscillator stage for class A operation.¹ Capacitor C1 provides the nec-

essary parallel capacitive load, which, with R1, causes the oscillator to start reliably. C2, in parallel across X1-C1, permits the oscillator output to be trimmed to an accuracy of ± 100 ppm of the desired operating frequency with an accuracy of ± 2 ppm obtainable with careful component selection.

The buffered oscillator output frequency is available at pin 7 of the IC which gives you a convenient point to monitor the oscillator output without loading, while trimming to the desired operating frequency. The buffered output is at CMOS levels, and for that reason must drive only CMOS-compatible circuits. If other than CMOS levels are required, it will

be necessary to provide the needed digital or analog buffers. Several CMOS-to-digital-level buffers are available from many of the suppliers listed in the advertisements in this magazine; additionally, all parts called for in this article are available from Surplus Electronics, 9600 Baltimore Blvd. (rear), College Park MD 20740. The CMOS-to-analog-level buffer is not available as a single chip, but may be constructed in the form of a one- or two-transistor amplifier to allow the oscillator to be used in just about any circuit configuration you can imagine. These can include local oscillators, QRP transmitters, frequency counters, and so on. Note that the output

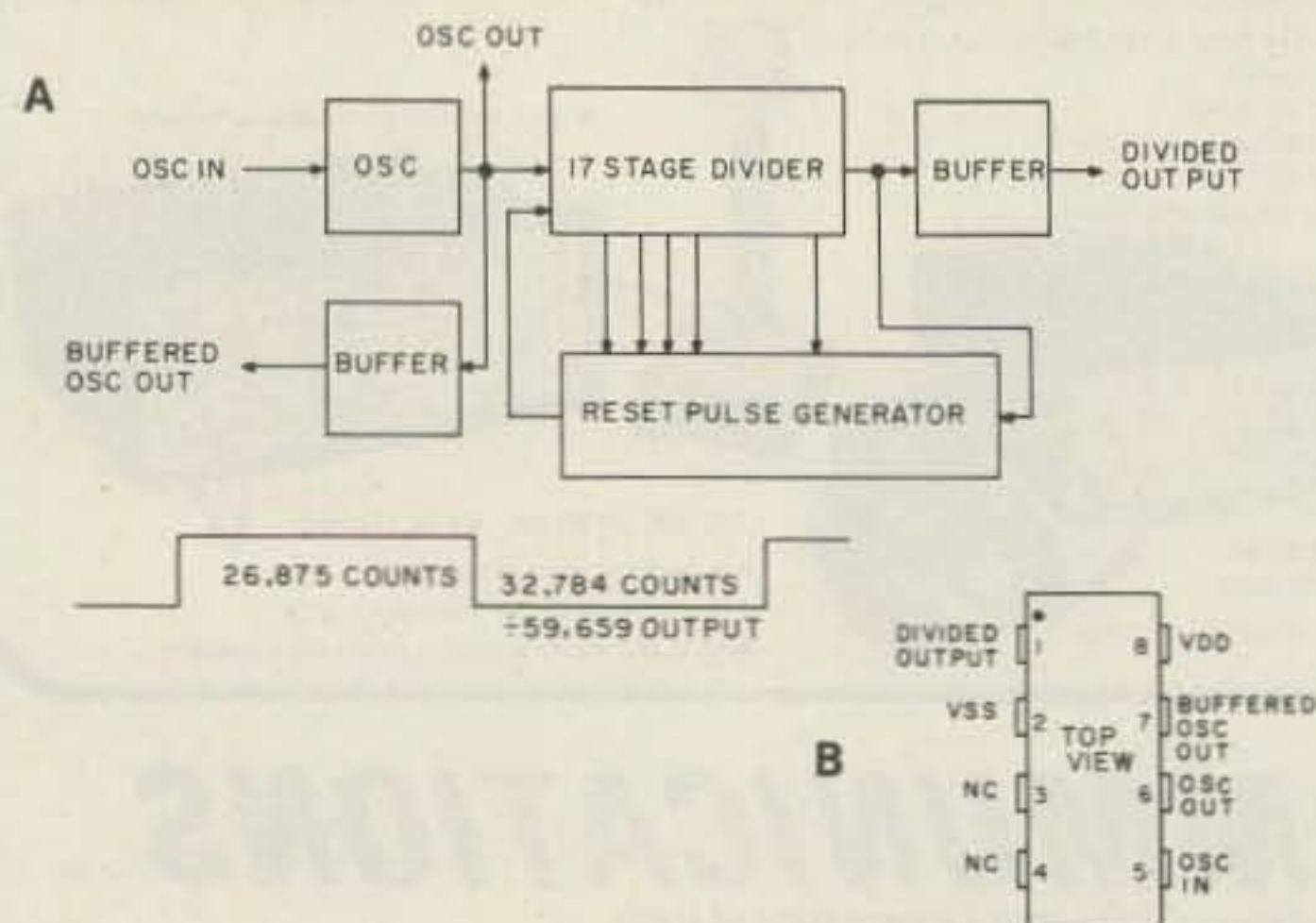

Fig. 1. (a) MM5369N block diagram and timing.¹ (b) MM5369N pinout.¹

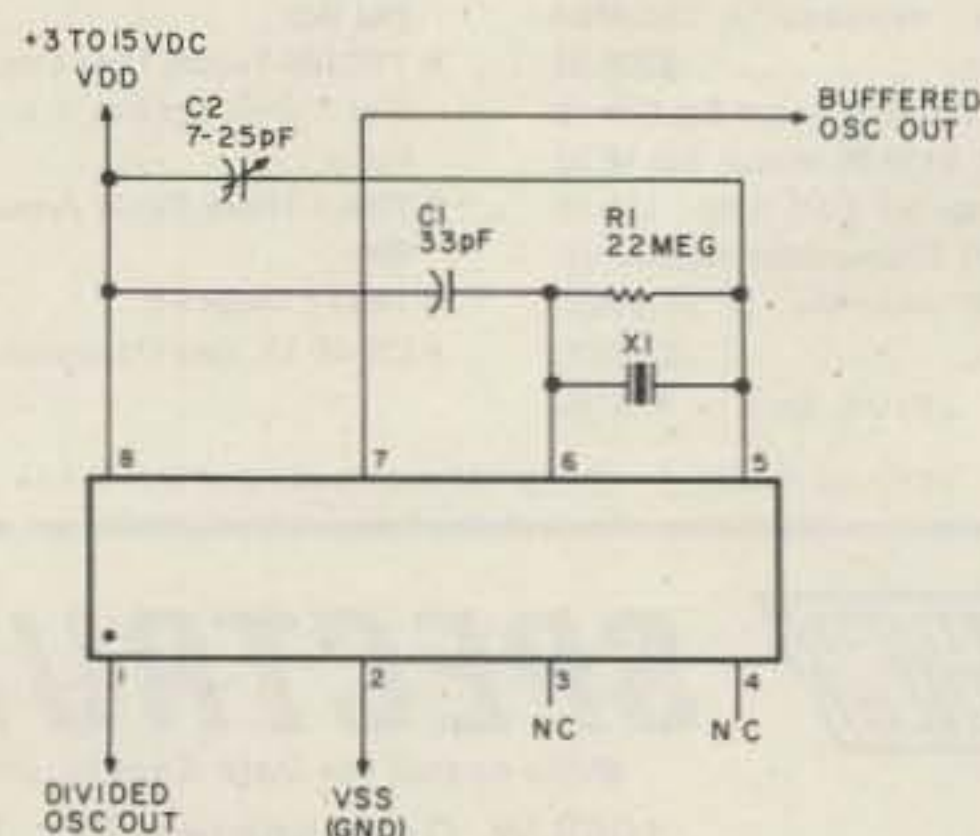

Fig. 2. Basic operating circuit.

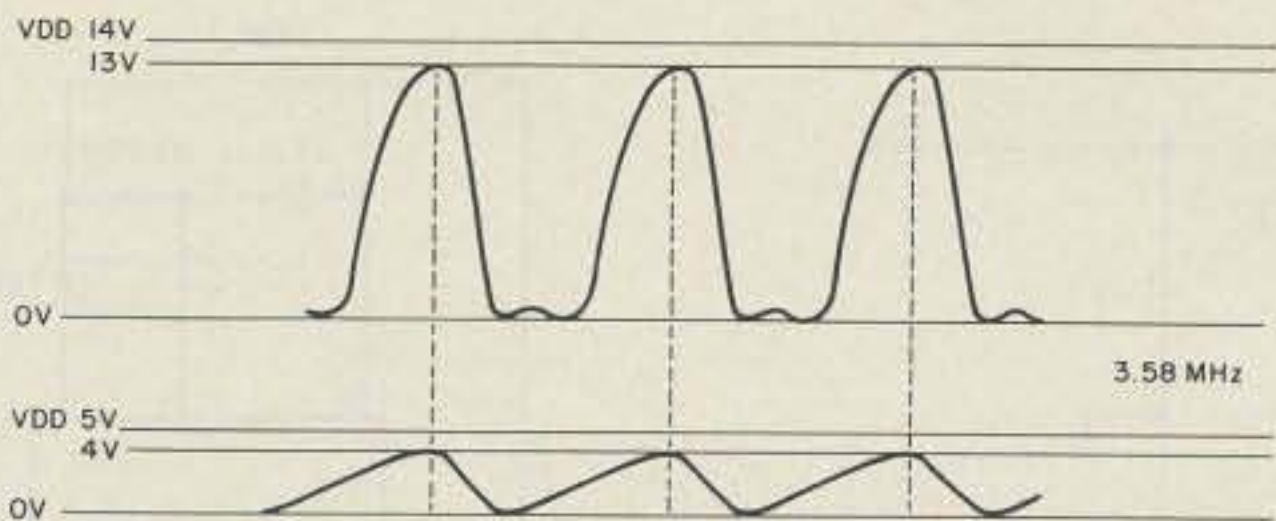

Fig. 3. Output waveforms taken at 3.58 MHz from pin 7. (Note loss of rise and fall times at very reduced V_{dd}.)

load on the buffered oscillators output must be kept below 500 μ A to avoid exceeding the manufacturer's specifications.

The divider section in the standard MM5369N is a mask-programmed, 17-stage divider set to divide the input frequency by 59659. This is accomplished in conjunction with a six-input reset pulse generator which, by virtue of its mask programming, sets the internal divisor length. The MM5369 is also available with custom mask programming. Should you have the need and the bucks (kilo, no doubt), National Semiconductor would, most likely, happily mask-program a few thousand for you with any divisor from 10000 to 98000. The divided output duty cycle stays very close to 50% for a V_{ss} of 8-15 volts and can drop as low as 20% for a V_{ss} of 3 volts at the same frequency. The current drain is nominally 2-4 mA for frequencies of 500 kHz to about 6 MHz, with up to 20 mA drawn for frequencies up to 16 MHz.

Operational Considerations

The MM5369N is a versatile crystal oscillator chip requiring a bare minimum of supporting parts for proper operation. The oscillator is very tolerant of supply voltage variations, and the only noticeable effect of an abnormal voltage change is a possible loss of duty cycle and a degradation of the rise and fall times of the output waveform (see Fig. 3). Although the MM5369N is

specified to operate from dc to 2 MHz at 6 V dc and dc to 4 MHz at 10 V dc, I have found that the oscillator will run reliably in excess of 16 MHz at 10-15 V dc with a very good sine-type output.¹ Also, if you are inclined to experiment, you will find that the crystal can be replaced by an inductor and the circuit operating range extended to about 40 MHz. But you will pay the price—not too exorbitant—in the loss of crystal stability and output voltage level.

Although the output of the oscillator is already buffered, I feel it is advisable when using this circuit in any application to add at least an additional stage of isolation, whether it is digital or analog, to avoid undue loading of the oscillator. The output load should be limited to less than 500 μ A and be as low as possible for best stability. This is not difficult to obtain with a one- or two-transistor buffer amplifier (Fig. 4). The amplifier was adapted from "Brew Up a Signal Generator" (73, January, 1978). The circuit as shown has been tested from 500 kHz to 16.5 MHz, operates quite reliably, and adds only an additional 20-25 mA to your power supply requirements. If you are planning to operate this buffer amplifier exclusively under 5 MHz, you can omit the 30 pF capacitor across R3.

Stand-Alone Crystal-Controlled Calibrator

So far you have been presented with a bunch of

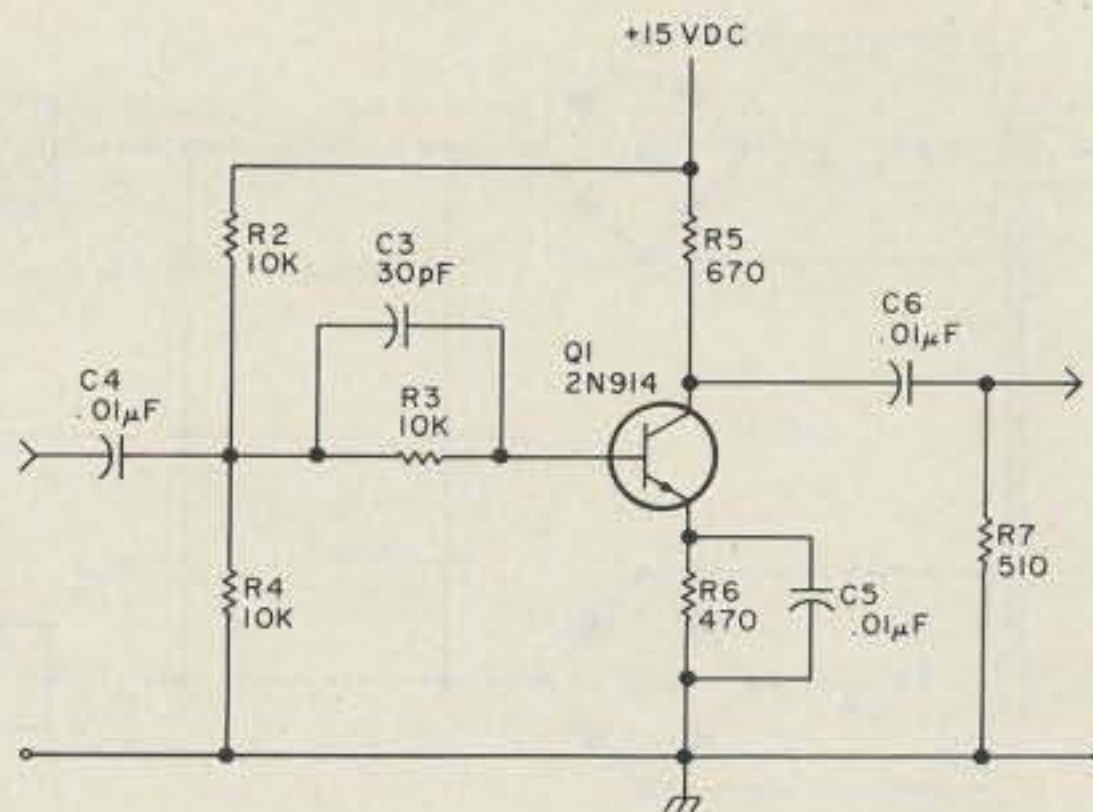

Fig. 4. Modified buffer amplifier for CMOS-to-analog level translation.³

theory and "how to" and little else. Here's your chance to include all of the above plus a little more and have a reliable test instrument standard for your lab. First dig out that old 1- or 10-MHz rock you bought at the last hamfest. We're going to combine it with the MM5369N, a TTL buffer amp, a few ICs, and end up

with a crystal calibrator with multiple divided outputs. It will serve you well when the time comes to calibrate your scope, and, in between, serve as the timebase for a frequency counter, if you wish. The output of pin 7 on the MM5369N (Fig. 5) is fed to the TTL buffer amp and then to the first 7490; each

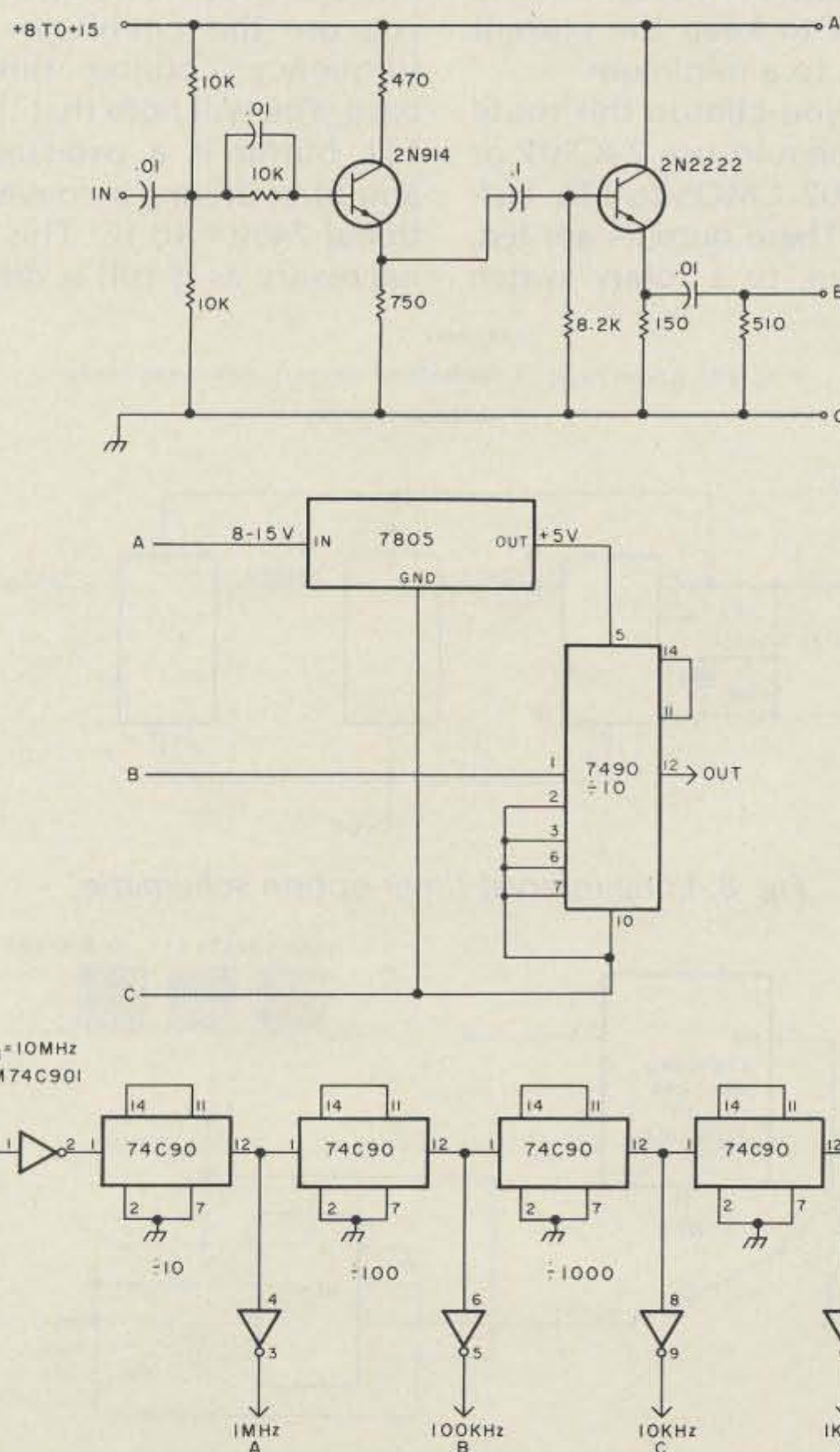

Fig. 5. TTL digital interface and divider chain.

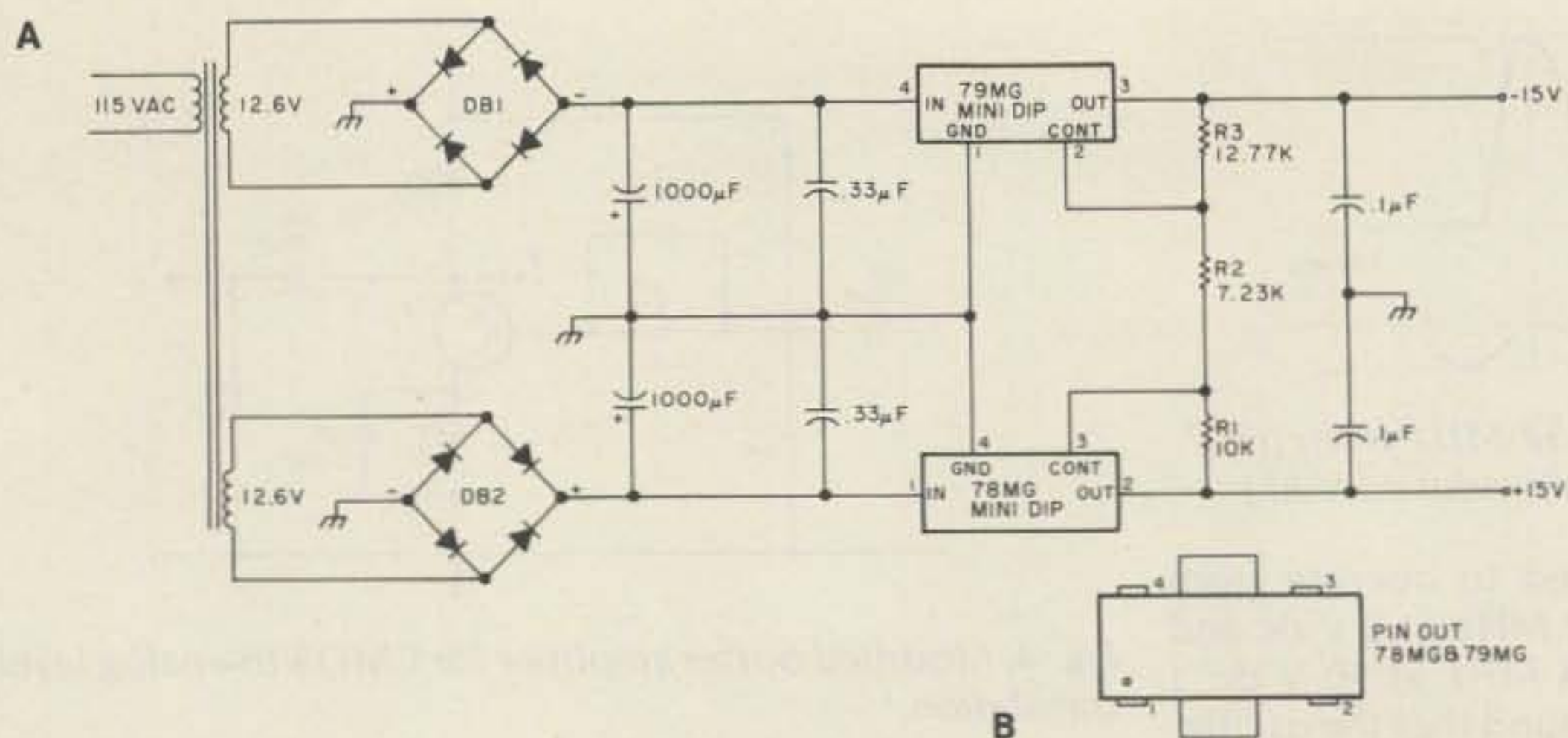

Fig. 6. (a) UA78MG and UA79MG power supply. The negative portion of the supply is not required for this project. It is provided to allow the user greater latitude in using the power supply in other projects as well. (b) UA78MG and UA79MG pinout.

divided signal is then fed to the following IC stage in turn. At each 7490 output, the signal is brought out to a TTL buffer chip where it is available for use as you please. At approximately 100 kHz you may wish to substitute 74C90s for the 7490s to keep the current drain to a minimum.

If you choose this route you should use 74C901 or 74C902 CMOS-to-TTL buffers. These outputs are fed, in turn, to a rotary switch

and from there to the output. There is also a signal provided that has been divided by 59659 that is available at pin 1 of the MM5369N. This also can be buffered and used as a known signal source for a press-to-test function if you use this circuit for a frequency counter time-base. You will note that the TTL buffer is a two-stage amplifier driving a conventional 7490 ÷ 10 IC. This is necessary as it still is diffi-

cult to find 74C90s that operate at 16 MHz. So far we have touched on the parts required to have a crystal oscillator but we don't have a source of power to run it—yet.

The Power Source

The power source—see Fig. 6(a) and (b)—is a simple voltage-regulated source that will help eliminate the aforementioned "abnormal voltage drop." It consists of the usual transformer, full-wave diode bridge, and capacitor arrangement followed by a really neat voltage regulator chip, the UA78MG, made by Fairchild Semiconductor. The UA78MG is a 4-terminal positive voltage regulator (UA79MG is the negative version) which is adjustable from 5 to 30 volts at a current of 500 mA. This versatile device can be used with a series pass transistor for higher output currents when needed.² For those who are interested in the gory details of how to design power supplies with this chip, a few of the basic rules I have found to be useful are set forth below:

1) Set the control current through R1, R2, and R3 to 1 mA.

2) The UA78MG control voltage is 5 V, the UA79MG is 2.23 V. $R2 = 7.23/1 \text{ mA} = 7.23 \text{ k Ohms}$. If the power

Fig. 7. Crystal checker schematic.

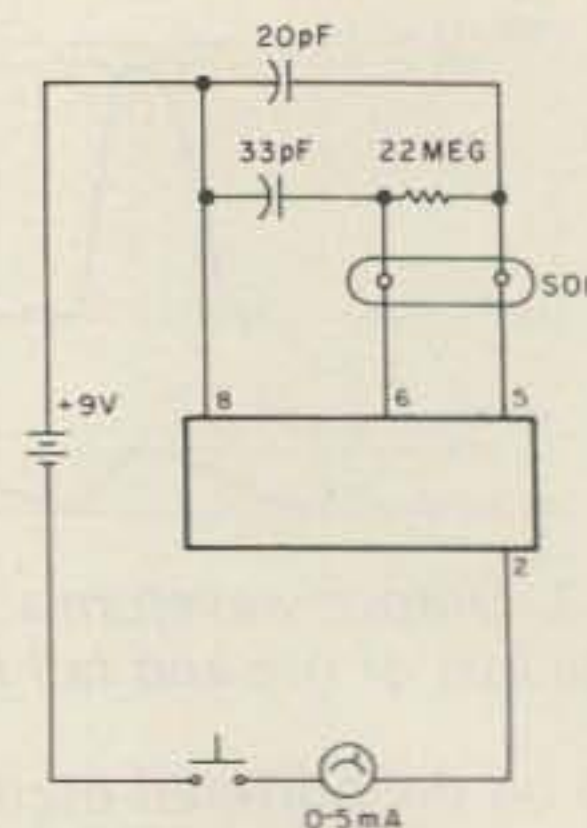

supply is just plus or just minus, then that respective leg is referenced to ground, and R2 is the control voltage divided by the control current.

3) The value of R1 and R3 is found by $R_x = V_{out}(\text{desired}) - V_{control} / I_{control}$.

4) If you prefer an adjustable supply, R1 and R3 can be replaced by trim pots and their respective voltages set independently.

5) Include a .33-µF input and a .1-µF output capacitor for each circuit to improve the circuit's output transient response time.

If you wish, a 25-volt center-tapped transformer may be modified to provide the dual output voltages called for by Fig. 6. Take a sharp knife and carefully follow the c-t lead through the paper until you find the point where the lead is soldered to the output winding. When you find this point, carefully unsolder and split the two winding wires, attach separate output wires, and cover the connections with the proper size heat shrink or tape. Re-wrap the transformer with tape, check for shorts—and you're done.

Other Nonstandard Uses

Other nonconventional uses include a portable crystal checker (Fig. 7). Just add a 0-5-mA meter, and replace the power supply with a 9-volt transistor battery. Note and mark the

$$f_1 = 8.381 \text{ Hz}$$

$$\text{IF } f_0 = 500,000 \text{ Hz THEN: } f_2 = .0001405 \text{ Hz OR } 1 \text{ Hz / EVERY } 13.466 \text{ YEARS!}$$

$$f_3 = .000000002355 \text{ Hz}$$

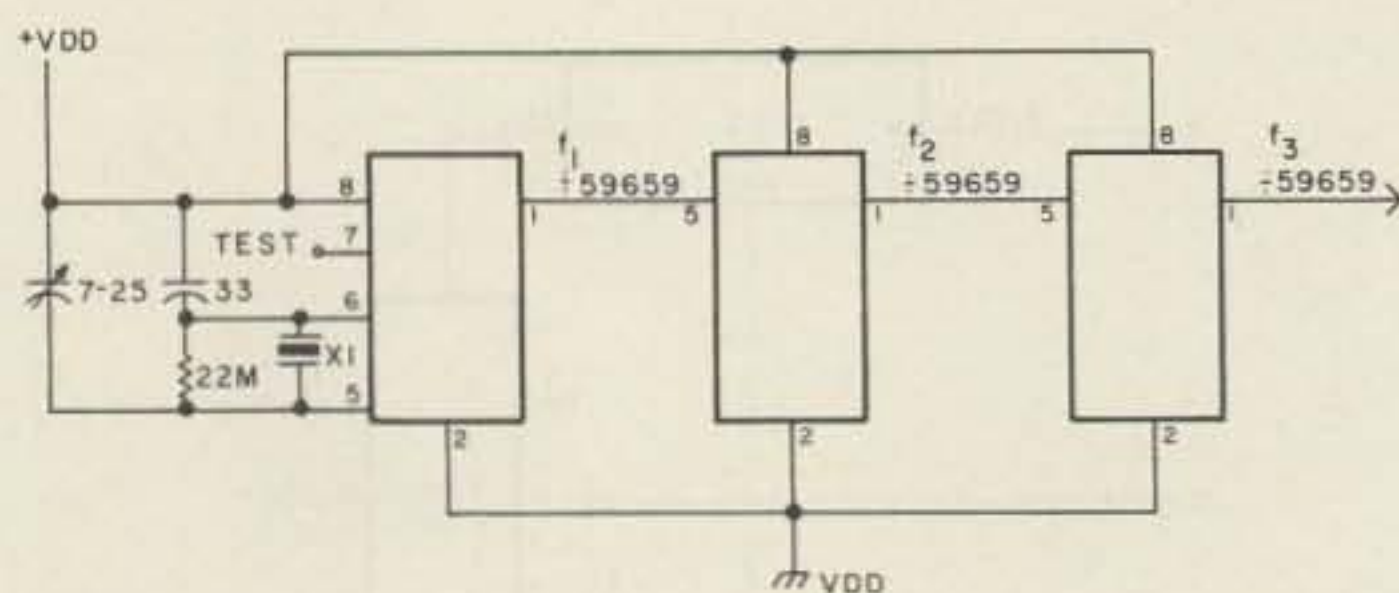

Fig. 8. Long-interval timer-option schematic.

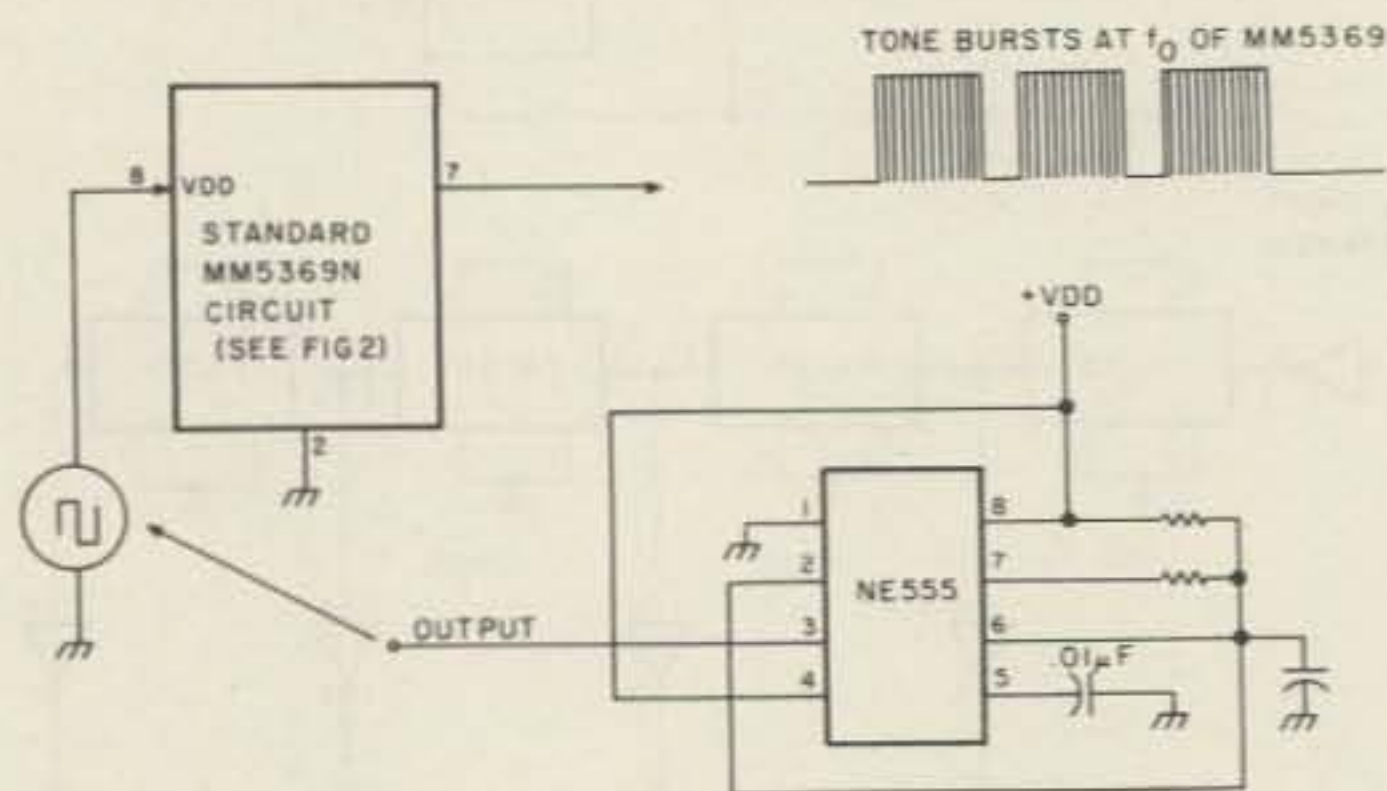

Fig. 9. MM5369N tone or frequency burst schematic and block diagram.

current drawn without a crystal in the circuit and mark this on the face of the meter. Crystals that operate at 5 MHz and below will cause a current drop from the mark, while 7 MHz and above will cause the current to increase. If there is no change in the amount of current drawn, then the crystal is open, or very close to 6 MHz.

The MM5369N also can be used as a long-interval timer. You can cascade the MM5369N without using the active oscillator part of the IC by feeding the output of the first oscillator (pin 1) to the input of the next oscillator (pin 5). (See Fig. 8.) By this scheme, you select the desired output period and multiply by 59659 or multiple thereof, and find the inverse to get the operating frequency needed. If you wish to have 1 Hz every 1.88 years you have to use an operating frequency of 3.579545 MHz and divide it through 3 MM5369N dividers to obtain the desired output.

Another option is to use the MM5369N as part of a tone or frequency burst oscillator (Fig. 9). The NE555 timer provides a low frequency square wave that is used to supply power to the V_{DD} pin of the MM5369N. Every time the square wave goes positive, the oscillator is gated on for the duration of the positive portion of the pulse. The oscillator will produce whatever frequency has been selected for it by its crystal.

Construction

These circuits can be wired either point-to-point or by printed circuits. Although my circuit debugging is started on perfboard or breadboarding strips, I have always found it more enjoyable, in the long run, to make all my test equipment on printed circuit board. Not only does it make assembly easier, but

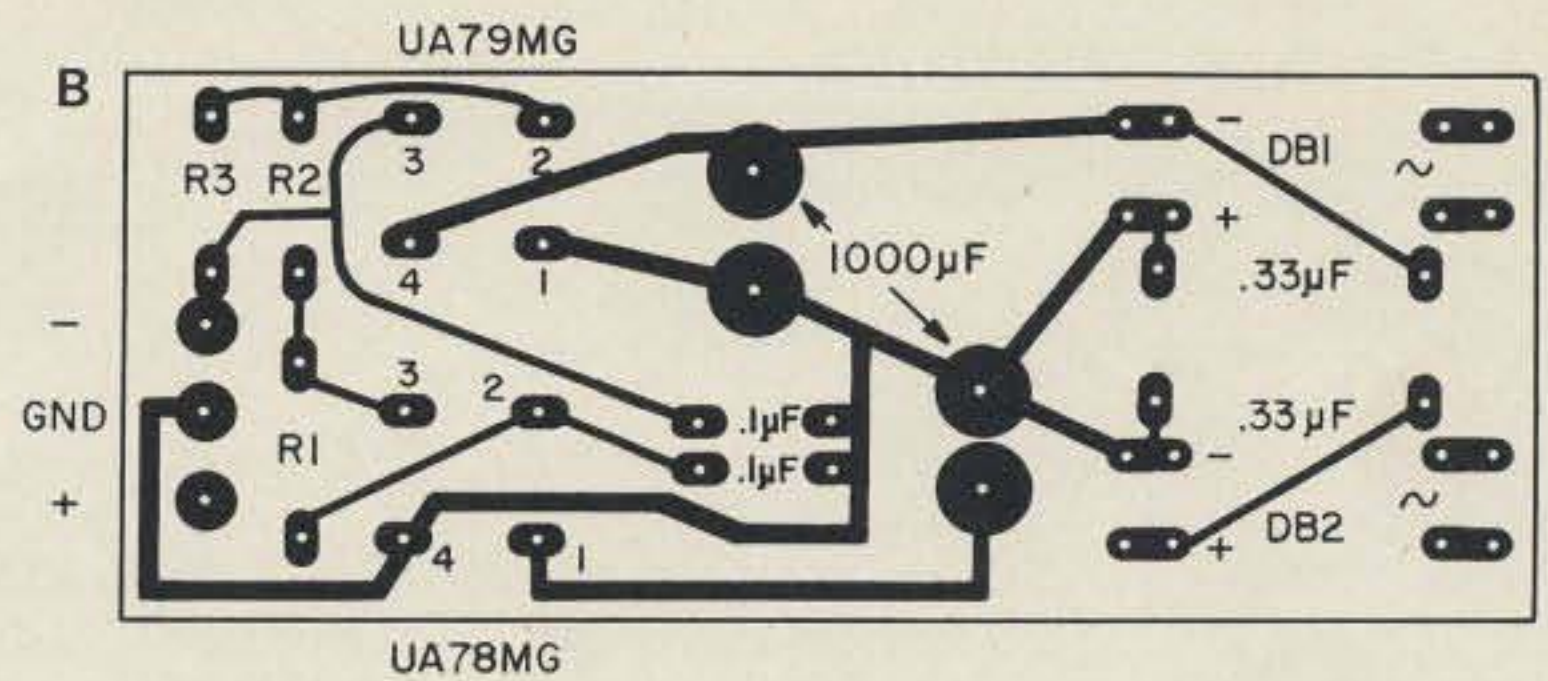
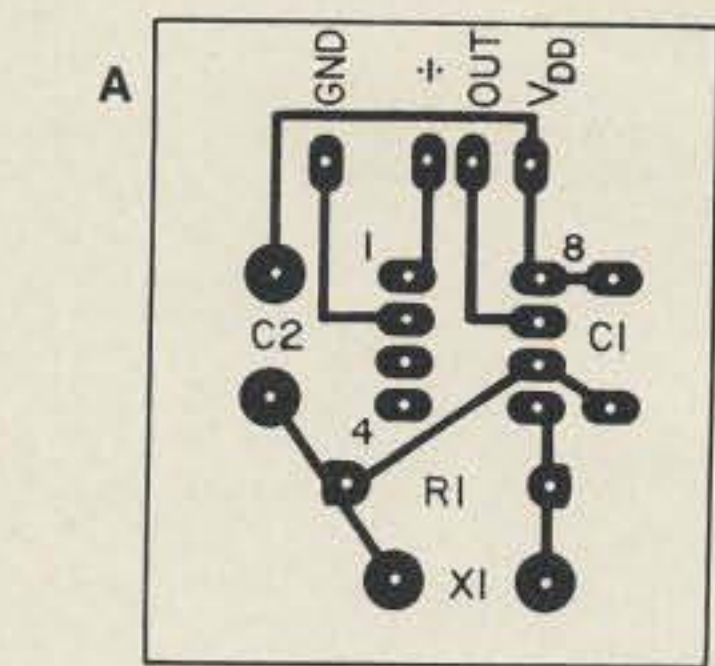

Fig. 10. (a) MM5369N PC board layout for basic circuit and crystal checker. (b) UA78MG and UA79MG power supply PC board layout. Both PC board layouts are shown from the component side.

when properly accomplished, can add to the usefulness and longevity of a circuit. Should you also find this to be the case, PC layouts have been included (Fig. 10).

Calibration

Calibration of the MM5369N output frequency is a relatively simple matter and can be accomplished with a bare minimum of fuss. Hook the output of pin 7 on the MM5369N to an oscilloscope or frequency counter and trim C2 until the desired frequency is obtained. Do this slowly as the trim cap is small and it's easy to overshoot the desired frequency. If you opt for the counter method of calibration and your counter drifts very little, you can record the oscillator output over a period of time while recording the ambient temperature, and make a frequency vs. temperature chart that will allow you to temperature-compensate your oscillator. This is done by finding the rate of frequency drift with temperature and selecting a replacement capacitor for C1 that has the opposite coefficient of the temperature curve. To select the proper capacitor, note the frequency and temperature at several points. Divide the difference in frequencies (desired and actual) by the desired frequency, then divide the result by the number of degrees that have

changed from your ambient setting and you should have your temperature coefficient in parts per million/degree. This is what capacitor temperature coefficients are expressed in. Simply choose the one that is closest to the opposite of your recorded findings and you will be on your way to maximum stability.

Conclusion

This article is intended to present the experimenter with a versatile, crystal-controlled building block

that proves to be useful in a wide range of circuits and is functional as a general-purpose crystal-controlled frequency standard that is not limited to such a mundane chore as a digital clock timebase. ■

Bibliography

1. *CMOS Databook*, National Semiconductor, 1977, pp. 4-3 to 4-5.
2. *UA Linear Integrated Circuits Data Book*, Fairchild Semiconductor, 1976, pp. 14-36 to 14-43.
3. "Brew Up a Signal Generator," *73 Magazine*, January, 1978.

Call or Write for Delivery or Quote

KENWOOD TS180S



LEAVE A MESSAGE & WE'LL CALL YOU BACK!

MADISON ELECTRONICS SUPPLY, INC.

1508 McKINNEY • HOUSTON, TEXAS 77002

713/658-0268 M35

MASTERCARD • VISA

All prices fob Houston, except where indicated. Prices subject to change without notice, all items guaranteed. Some items subject prior sale. Send letterhead for Dealer price list . . . Texas residents add 6% tax . . . please add postage estimate, \$1.00 minimum. W5GJ, W5MBB, K5AAD, N5JJ, AG5K, W5VVM, WD5EDE, K5ZD, WA5TGU, WB5AYF, K5RC, K5BGB, WB5USV.



Digital Readout Rotator Control

— can the microcomputer connection
be far behind?

Modernize your TR-44.

Randy Kaeding K8TMK
222 Jamesway
Benton Harbor MI 49022

With almost everything switching to digital readout these days,

I decided to design a new control box for my TR-44 rotator. For my own per-

sonal use, the new control box would have to: use LED displays, be relatively simple, interface directly to the rotator with no internal modifications, remain accurate during ac line variations, and match my other station equipment.

Research

Fig. 1 shows the schematic of the TR-44's unmodified sensing circuit. This circuit is a simple voltage divider, which causes more or less current to flow through the meter as the sensing potentiometer (inside the rotator) changes position. When the potentiometer is at the bottom end of its range (rotator fully counterclockwise, as viewed from the top of the rotator), no current flows through the meter, and the meter needle remains in the resting position. When the rotator is at the top end of its range (rotator fully



Photograph of the new control box. (The display was enhanced so that it would stand out better.)

New MFJ 3 & 1.5 KW Versa Tuners

Run up to 3 KW or 1.5 KW PEP and match everything from 1.8 thru 30 MHz: coax, balanced line, random wire. Built-in balun.

3 KW VERSA TUNER IV's

1.5 KW VERSA TUNER III's



NEW MFJ KW VERSA TUNERS HAVE THESE FEATURES IN COMMON

These 6 new MFJ KW Versa Tuners let you run up to 3 KW or 1.5 KW PEP (depending on the model) and match any feedline continuously from 1.8 to 30 MHz: coax, balanced line or random wire. Gives maximum power transfer. Harmonic attenuation reduces TVI, out of band emissions.

All metal, low profile cabinet gives RFI protection, rigid construction, sleek styling. Black. Rich anodized aluminum front panel. 5x14x14 inches.

Flip down stand tilts tuner for easy viewing.

Efficient, encapsulated 4:1 ferrite balun. 250 pf, 6000 volt capacitors. 18 position dual inductor, 17 amp, 3000 V ceramic rotary switch (3 KW version). 12 position inductor, ceramic rotary switch (1.5 KW version). 2% meters. SO-239 coax connectors, ceramic feedthru for random wire and balanced line. One year limited warranty. Made in U.S.A.

3 KW VERSA TUNER IV's

1 MFJ-984 3 KW VERSA TUNER IV

\$299⁹⁵ *EXCLUSIVE RF AMMETER insures maximum power to antenna at minimum SWR. Built-in dummy load.*

This is MFJ's best 3 KW Versa Tuner IV. The MFJ-984 Deluxe 3 KW Versa Tuner IV gives you a combination of quality, performance, and features that others can't touch at this price.

An exclusive 10 amp RF ammeter insures maximum power to antenna at minimum SWR. A separate meter gives SWR, forward, reflected power in 2 ranges (2000 and 200 watts).

Versatile antenna switch lets you select 2 coax lines thru tuner and 1 thru or direct, or random wire, balanced line or dummy load.

A 200 watt 50 ohm dummy load lets you tune your exciter off air for peak performance. Efficient, encapsulated 4:1 ferrite balun.

2 MFJ-981 3 KW VERSA TUNER IV

\$199⁹⁵ *Accurate meter gives SWR, forward and reflected power in 2 ranges: 2000 and 200 watts. 4:1 ferrite balun.*

The MFJ-981 3 KW Versa Tuner IV is one of MFJ's most popular Versa Tuners. An accurate meter gives you SWR, forward and reflected power in 2 ranges: 2000 and 200 watts. Encapsulated 4:1 ferrite balun.

3 MFJ-982 3 KW VERSA TUNER IV

\$199⁹⁵ *Antenna switch lets you select 1 coax thru tuner and 2 coax thru tuner or direct, or random wire and balanced line.*

The MFJ-982 3 KW Versa Tuner IV gives you a versatile 7 position antenna switch that lets you select 1 coax thru tuner and 2 coax thru tuner or direct, or random wire and balanced line. Encapsulated 4:1 balun.

If you already have a SWR/wattmeter, the MFJ-982 is for you.

4 MFJ-980 3 KW VERSA TUNER IV

\$169⁹⁵ *Heavy duty encapsulated 4:1 ferrite balun for balanced lines.*

The MFJ-980 is MFJ's lowest priced 3 KW Versa Tuner IV but has the same matching capabilities as the other 3 KW Versa Tuner IV's.

Features an efficient, encapsulated 4:1 ferrite balun for balanced lines.

1.5 KW VERSA TUNER III's

5 MFJ-962 1.5 KW VERSA TUNER III

\$169⁹⁵ *SWR, dual range forward and reflected power meter, 6 position antenna switch, encapsulated 4:1 ferrite balun.*

The MFJ-962 1.5 KW Versa Tuner III is an exceptional value. An accurate meter gives SWR, forward and reflected power in 2 ranges (2000 and 200 watts).

A versatile six position antenna switch lets you select 2 coax lines thru tuner or direct, or random wire and balanced line. Encapsulated 4:1 balun. Black front panel has reverse lettering.

6 MFJ-961 1.5 KW Versa Tuner III

\$149⁹⁵ *6 position antenna switch lets you select 2 coax lines thru tuner or direct, or random wire and balanced line.*

The MFJ-961 1.5 KW Versa Tuner III gives you a versatile six position antenna switch. It lets you select 2 coax lines thru tuner or direct, or random wire and balanced line. Encapsulated 4:1 ferrite balun.

If you already have a SWR/wattmeter, the MFJ-961 is for you.

Black front panel has reverse lettering.

FOR YOUR NEAREST DEALER OR FOR ORDERS

CALL TOLL-FREE **800-647-1800**

Why not visit your dealer today? Compare these 3 KW and 1.5 KW Versa Tuners to other tuners. You'll be convinced that its value, quality and features make it a truly outstanding value. If no dealer is available, order direct from MFJ and try it. If not delighted, return it within 30 days for a prompt refund (less shipping). Charge VISA, MC. Or mail check, money order plus \$10 shipping/handling.

For technical information, order/repair status, in Mississippi, outside continental USA, call 601-323-5869.

Order By Mail or Call TOLL FREE 800-647-1800 and Charge It On

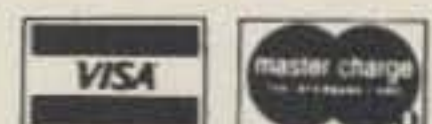

MFJ ENTERPRISES, INC.

P. O. BOX 494 M52

MISSISSIPPI STATE, MISSISSIPPI 39762

clockwise), approximately one milliampere flows through the meter, and the needle indicates full scale.

With the above ideas in mind, I decided that a simple dc voltmeter, with proper voltage scaling, could be used to indicate the position of the rotator potentiometer. If you apply a voltage to the potentiometer so the wiper-voltage changes from 0 to 3.6 volts during a complete

revolution, you have a voltage which changes at the

rate of .01 volts per degree. A preliminary data sheet

for the Motorola MC14433 integrated circuit, which is

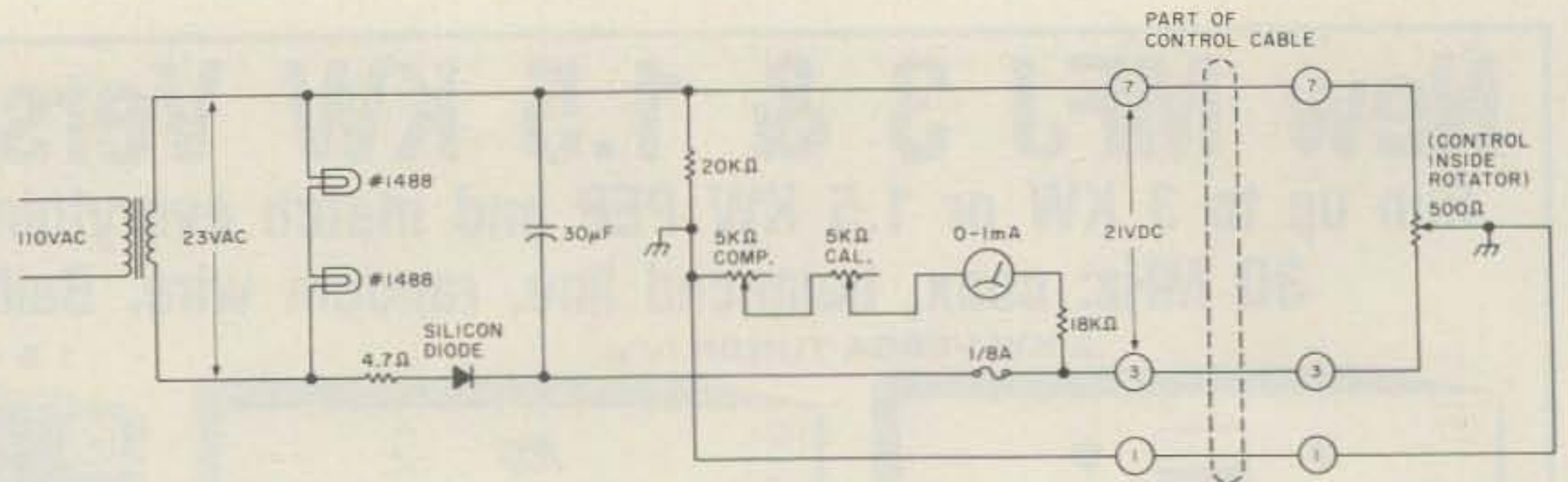

Fig. 1. Unmodified sensing circuit for the TR-44 rotator.

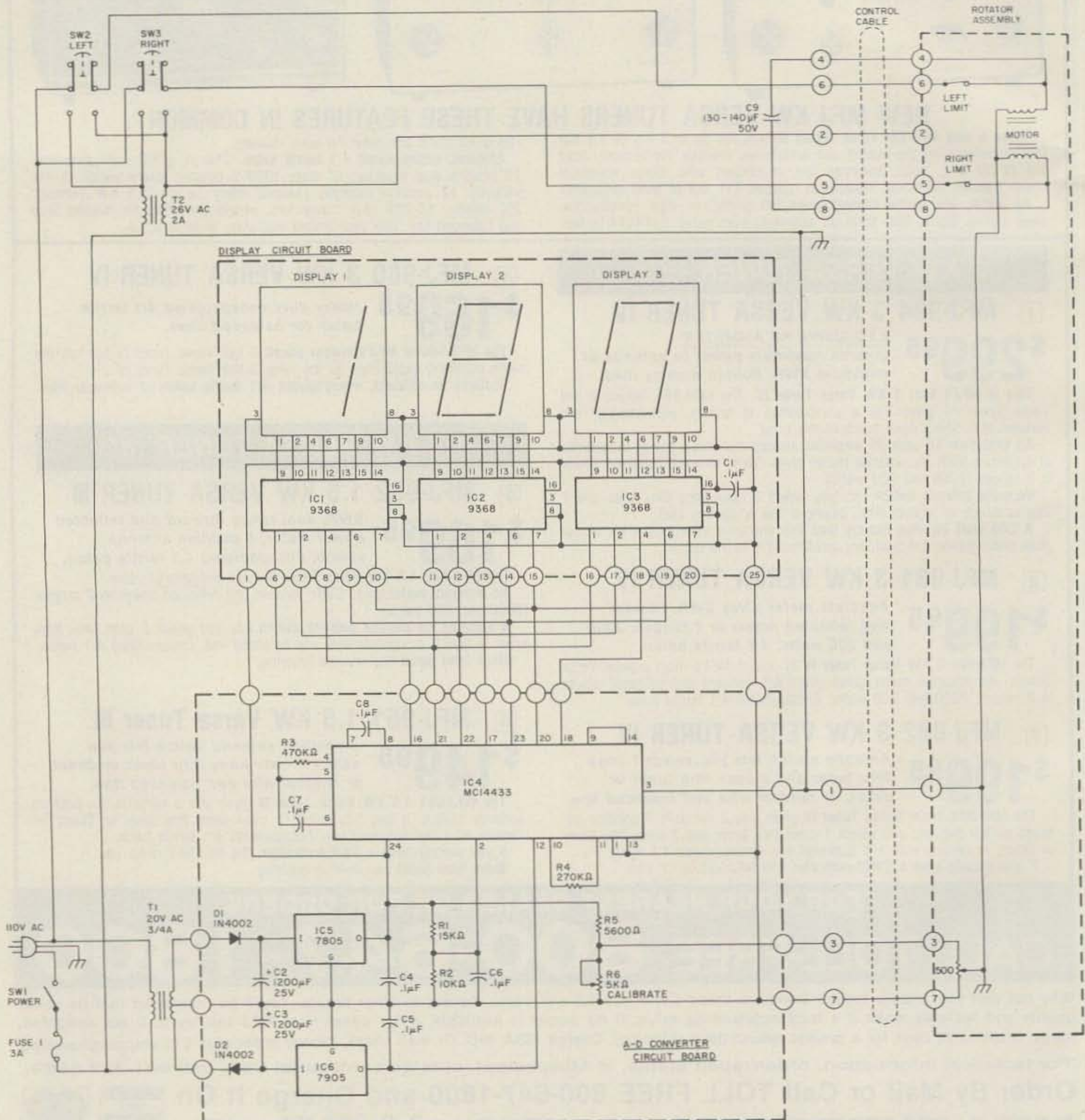
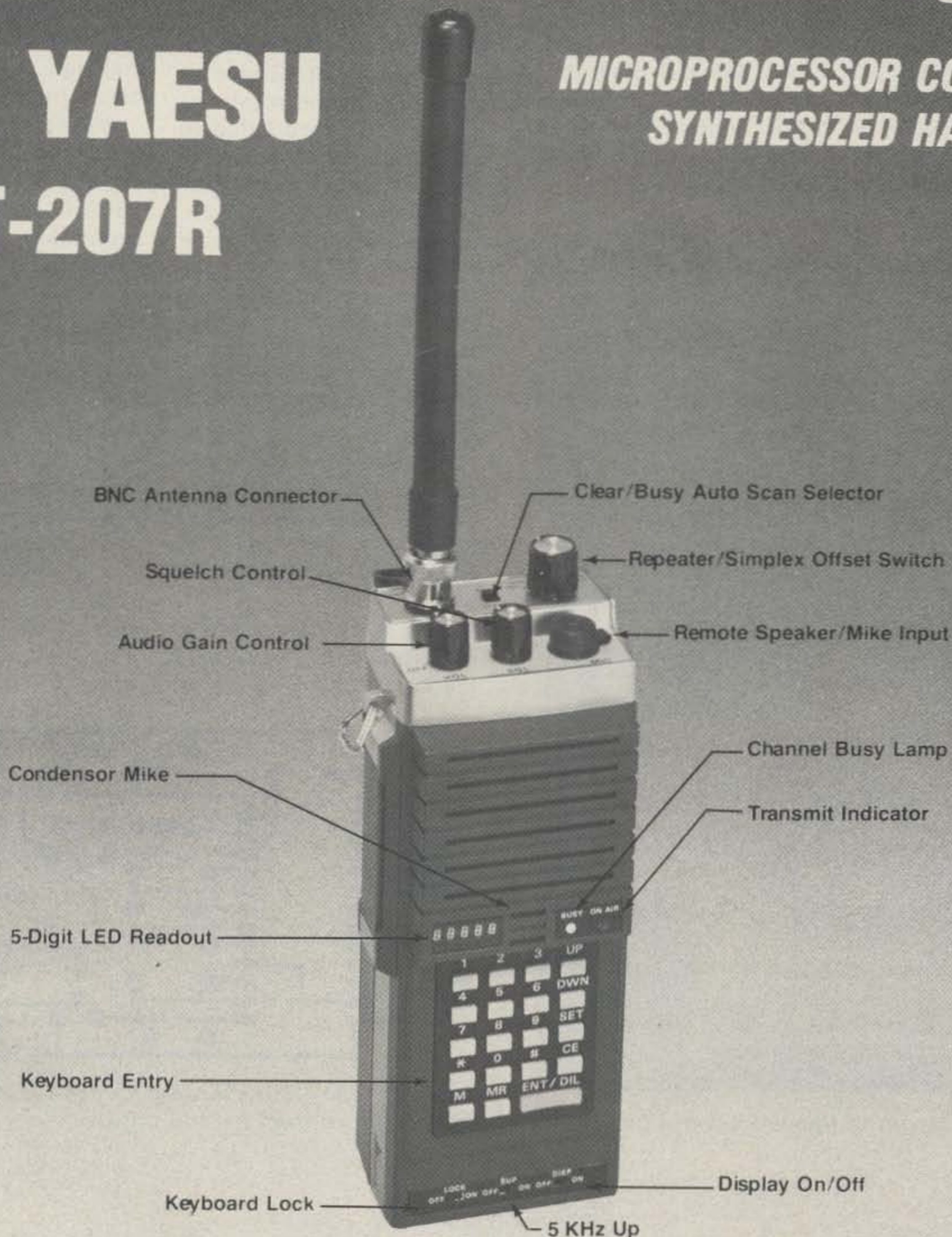

Fig. 2. Schematic diagram of the new control box (shown connected to the original rotator assembly).

A Breakthrough In Technology!

THE YAESU FT-207R

MICROPROCESSOR CONTROLLED SYNTHESIZED HANDIE



**The Yaesu FT-207R Synthesized Handie
has all the features you could want in a very compact package**

- 144-148 MHz Range
- 10 KHz Steps
- 3 Watts Output
- 4 Memories plus Programmable Offset
- Priority Channel
- Memory and Band Auto Scan
- Optional Equipment:
 - Tone Squelch, Speaker/Mike, Nicads, Battery Charger
- Keyboard Encoded Frequency Entry
- 2 Tone (Touchtone®) Input from Keyboard
- Keyboard Lock guards against accidental frequency change
- Odd Splits Can Be Programmed from Keyboard
- Automatic Battery Saver Feature for LED Display
- Rubber Flex Antenna



Price And Specifications Subject To
Change Without Notice Or Obligation

YAESU *The radio.*



979X

YAESU ELECTRONICS CORP., 15954 Downey Ave., Paramount, CA 90723 ● (213) 633-4007

YAESU ELECTRONICS Eastern Service Ctr. 9812 Princeton-Glendale Rd. Cincinnati, OH 45246

a 3½-digit analog-to-digital converter, contained the schematic of a simple 3½-digit digital voltmeter. To suit my particular requirements, I deleted the overrange and polarity sensing circuitry to further simplify the circuit. I then

modified the circuit to work with some decoder-driver ICs and LED displays that I already had. Fig. 2 is the schematic diagram of the completely redesigned rotor control box (shown connected to the rotator assembly).

Construction

With one minor exception, construction of the control box is not critical. Since the potentiometer wiper inside the rotator is mechanically grounded to the case (control cable wire #1), you must take care to keep all other circuit points isolated from ground.

If you use the same +5-volt regulator as I did, heat-sink it to the chassis. Be sure to use an insulator between the IC and the chassis to keep it electrically isolated from the chassis. The -5-volt regulator IC does not need a heat sink and may be mounted on the circuit board.

Figs. 3, 4, 5, and 6 show the foil and component layout of the two circuit

boards. Although the two circuit boards could have been combined into one, I used separate boards so that they could be used on future projects.

Be sure the power transformer you use in the sensing circuit has at least an 18-volt, center-tapped, secondary winding. This will allow the regulator ICs to remain within acceptable operating parameters with varying ac line voltages. With a 20-volt, center-tapped transformer, you should be able to keep an accurate display indication while the ac line voltage varies between 90 and at least 130 volts.

I mounted an extra push-button switch on the left side of the front panel to help balance the appearance of the panel. You

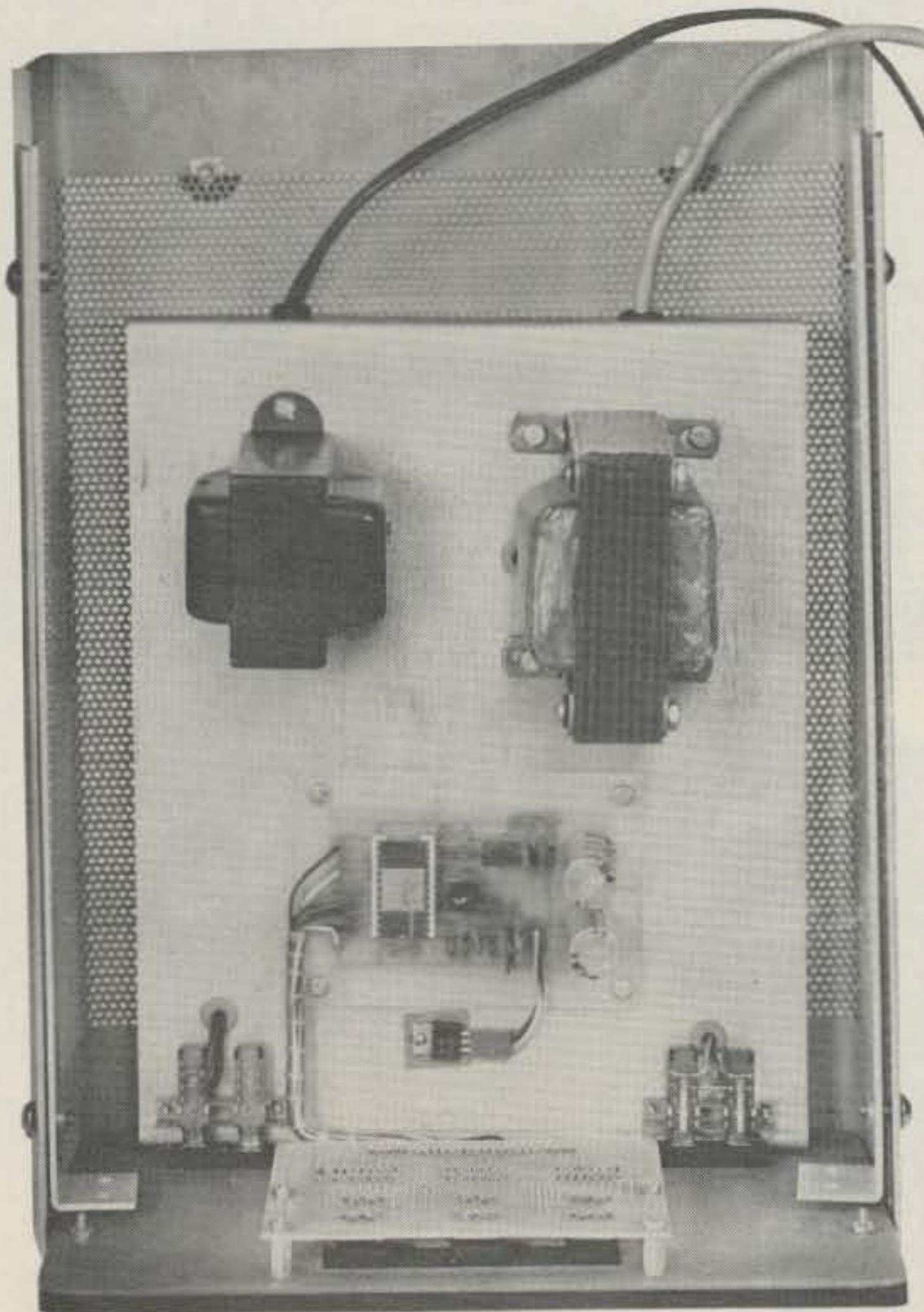

Internal layout of the new control box.

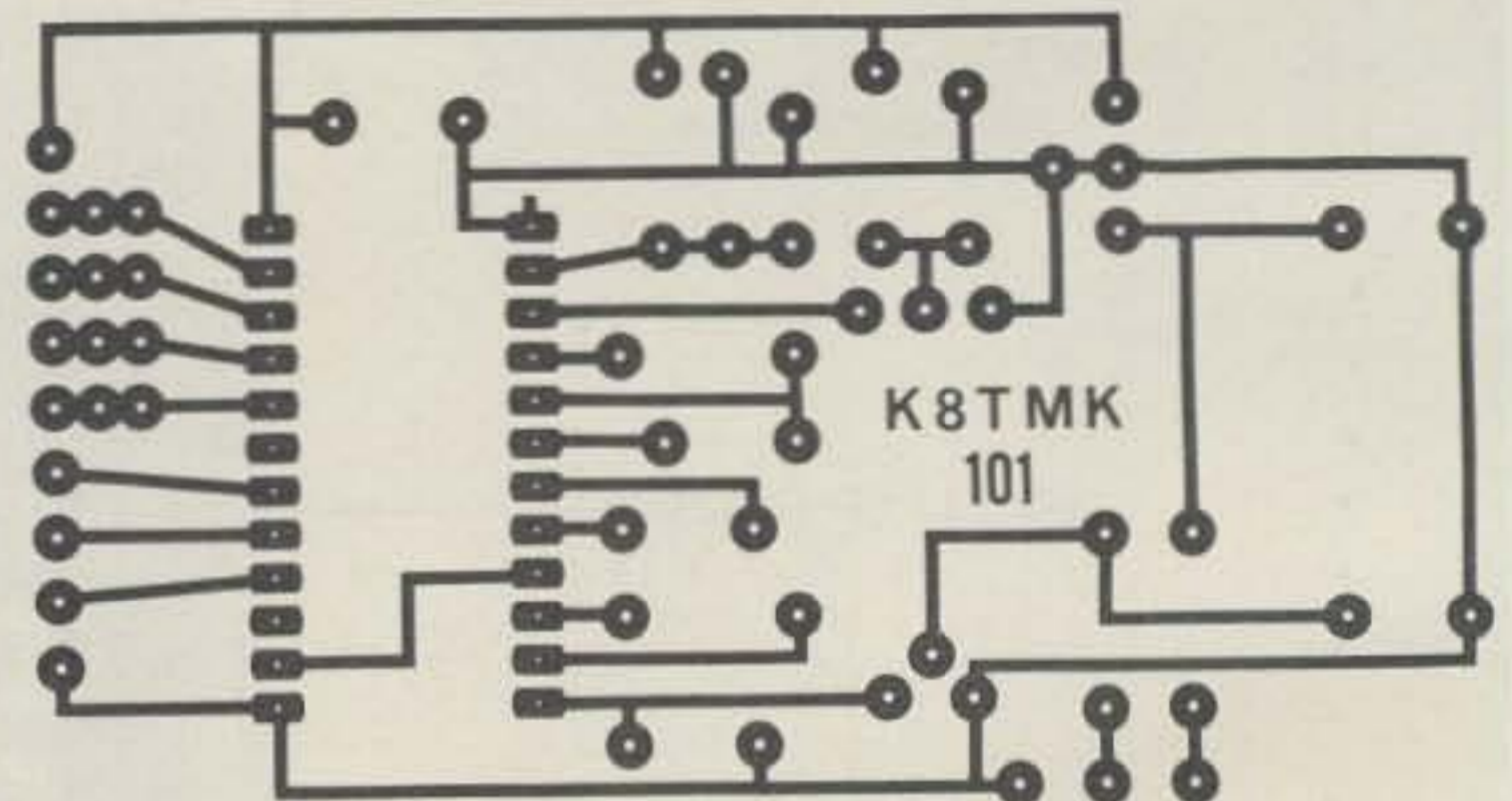

Fig. 3. Actual size foil pattern for the A-D converter circuit board (shown from the foil side).

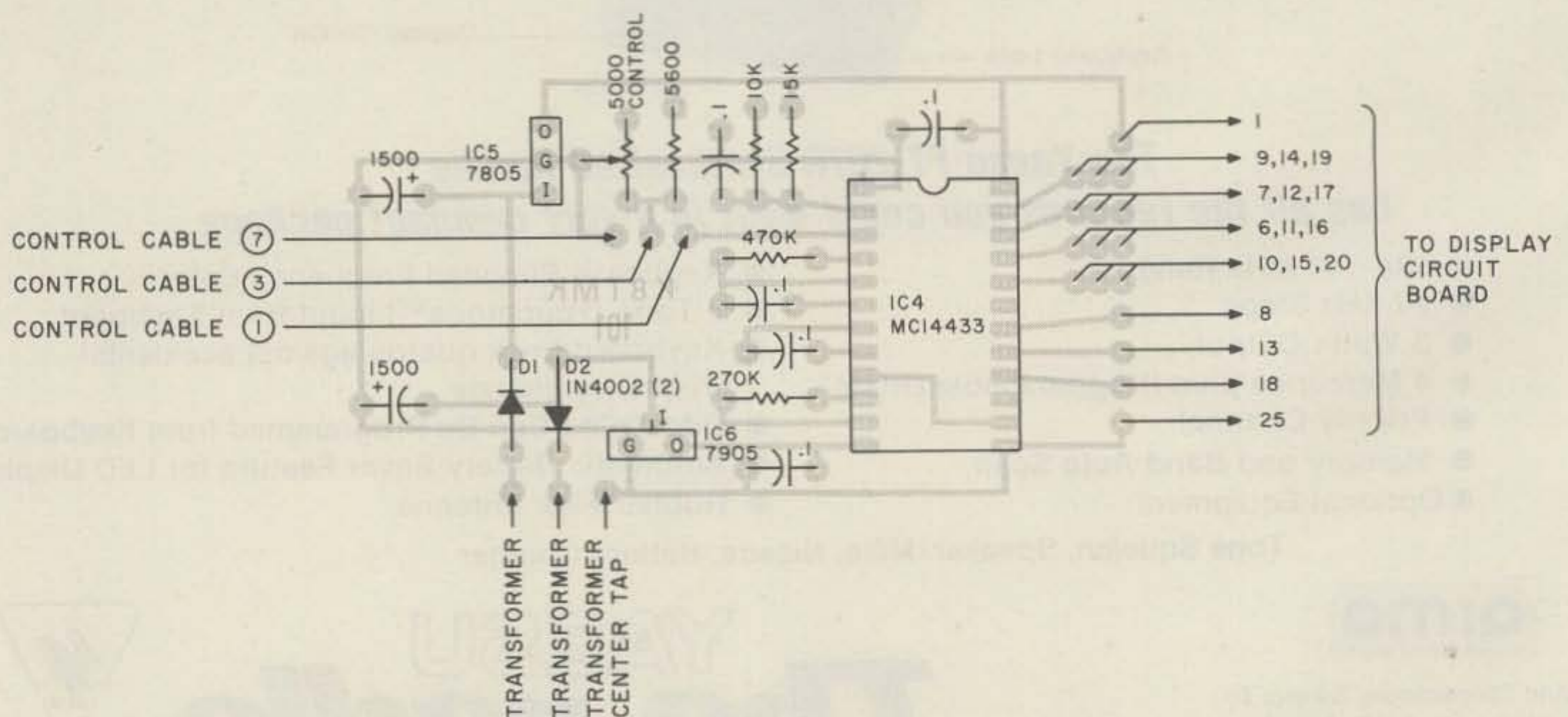

Fig. 4. Component layout for the A-D converter circuit board (shown from the component side).

MESSAGE MEMORY KEYS

"BRAND NEW"



Model # TE201

\$69.95

Features:

- Advanced CMOS message memory
- Two (50 char each) message storage
- Repeat function
- Records at any speed—plays back at any speed
- Longer message capacity
Example: send CQ CQ CQ DX de WB2YJM WB2YJM X—then play second message on contact—de WB2YJM QSL NY NY 579 579 Paul Paul K
- Use for daily QSOs or contests

PLUS:

- State-of-the-art CMOS keyer
- Self completing dots and dashes
- Both dot and dash memory
- Iambic keying with any squeeze paddle
- 5-50 wpm
- Speed, volume, tone, tune and weight controls
- Sidetone and speaker
- Low current drain CMOS battery operation—portable
- Deluxe quarter-inch jacks for keying and output
- Keys grid block and solid state rigs
- WIRED AND TESTED FULLY GUARANTEED—LESS BATTERY

"BRAND NEW"



Model # TE144

59.95

- State-of-the-art CMOS circuitry
- Self completing dots and dashes
- Both dot and dash memory
- IAMBIC keying with any squeeze paddle
- 5-50 wpm
- Speed, weight, tone, volume tune controls & sidetone and speaker

- Semi-automatic "bug" operation & straight keying—rear panel switch
- Low current drain CMOS battery operation—portable
- Deluxe quarter inch jacks for keying and output
- Keys grid block and solid state rigs
- Wired and tested—fully guaranteed—less battery



TRAC - KEY

FEATURES:

- Twin paddle squeeze key
- Extra heavy base—non-skid feet
- Adjustable contact spacing
- Touch tension—comfort keying
- Smooth friction free paddle movement
- Handsome crinkle finish base and rich red paddles
- Five way binding posts
- Use with Trac CMOS keyer or any keyer

\$25.95

plus \$2.00 s/h
NY res. add tax

AT YOUR DEALER OR SEND CHECK OR MONEY ORDER.

TRAC ELECTRONICS, INC
1106 RAND BLDG. T18
BUFFALO NY 14203

How You Can Convert Your Rohn 25G Tower to a FOLD-OVER

CHANGE, ADJUST OR JUST PLAIN WORK ON YOUR ANTENNA AND NEVER LEAVE THE GROUND.

If you have a Rohn 25G Tower, you can convert it to a Fold-over by simply using a conversion kit. Or, buy an inexpensive standard Rohn 25G tower now and convert to a Fold-over later.

Rohn Fold-overs allow you to work completely on the ground when installing or servicing antennas or rotors. This eliminates the fear of climbing and working at heights. Use the tower that reduces the need to climb. When you need to "get at" your antenna . . . just turn the handle and there it is. Rohn Fold-overs offer unbeatable utility.

Yes! You can convert to a Fold-over. Check with your distributor for a kit now and keep your feet on the ground.

AT ROHN YOU GET THE BEST

Do not attempt to raise antenna or antenna support near power lines— You can be KILLED.

Unarco-Rohn
Division of Unarco Industries, Inc.
P.O. Box 2000, Peoria, Illinois 61601

U2



could use this switch for brake release, if you use the control box with the Ham-M rotator.

Calibration

Calibration of the new control box is quite simple. You should not have to repeat it unless the ac line voltage changes drastically or the length of the control cable changes.

Connect the new control box to your rotator control cable and depress the POWER button. Use the RIGHT push-button to turn the rotator to its fully-clockwise position. The display will stop changing when you come to the end of travel. Note: If the display goes toward zero as you turn the rotator in a clockwise direction, interchange control cable wires 3 and 7. Now adjust the control on the A-D converter circuit board until the display indicates 360. The display should automatically indicate 0 when you turn the rotator to the left end of travel.

Operation

To determine the position of your antenna, simply depress the POWER button. The display will indicate the position in degrees. If you desire, you can leave the POWER button depressed for a continuous indication.

If you wish to turn the rotator to a new position, simply push the LEFT or RIGHT button until the display indicates the desired position.

Conclusion

I have been using the new control box for a few months with no noticeable problems. It is a great pleasure to hear a DX station, look up his bearing in a table, and turn the rotator to the exact position without having to interpolate between the lines on an analog meter.

In the future, I plan to

Component Number	Parts List Description
C1, C4, C5, C6, C8	.1 uF disc ceramic capacitors
C2, C3	1200 uF, 25-V electrolytic capacitors
C7	.1 uF mylar™ capacitor
C9	130-140 uF, 50 V, non-polarized capacitor
D1, D2	1N4002 silicon diode
DISP 1, DISP 2, DISP 3	FND-500 LED displays
F1	3-Ampere, 3AG fuse
IC1, IC2, IC3	9368 7-segment decoder-driver-latch ICs
IC4	MC14433 3½ digit A-D converter IC
R1	15k Ohm, ¼-Watt, 5% resistor
R2	10k Ohm, ¼-Watt, 5% resistor
R3	470k Ohm, ¼-Watt, 5% resistor
R4	270k Ohm, ¼-Watt, 5% resistor
R5	5600 Ohm, ¼-Watt, 5% resistor
R6	5k Ohm linear control
SW1	DPDT locking push-button switch
SW2, SW3	DPDT momentary-contact push-button switch
T1	Power transformer (20 V ac center-tapped, ¾-Ampere secondary)
T2	Power transformer (26 V ac, 2-Ampere secondary)

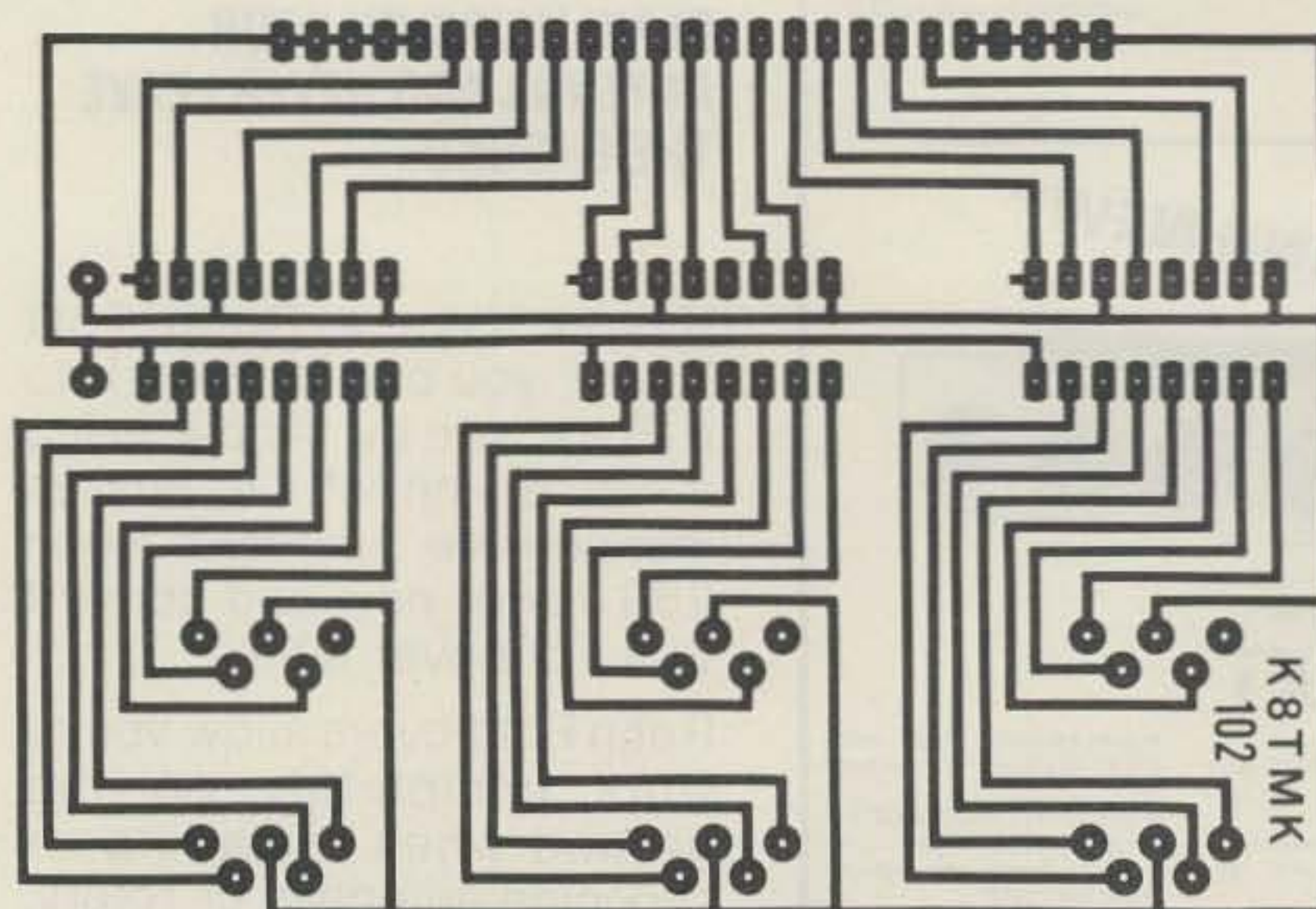

Fig. 5. Actual size foil pattern for the display circuit board (shown from the foil side).

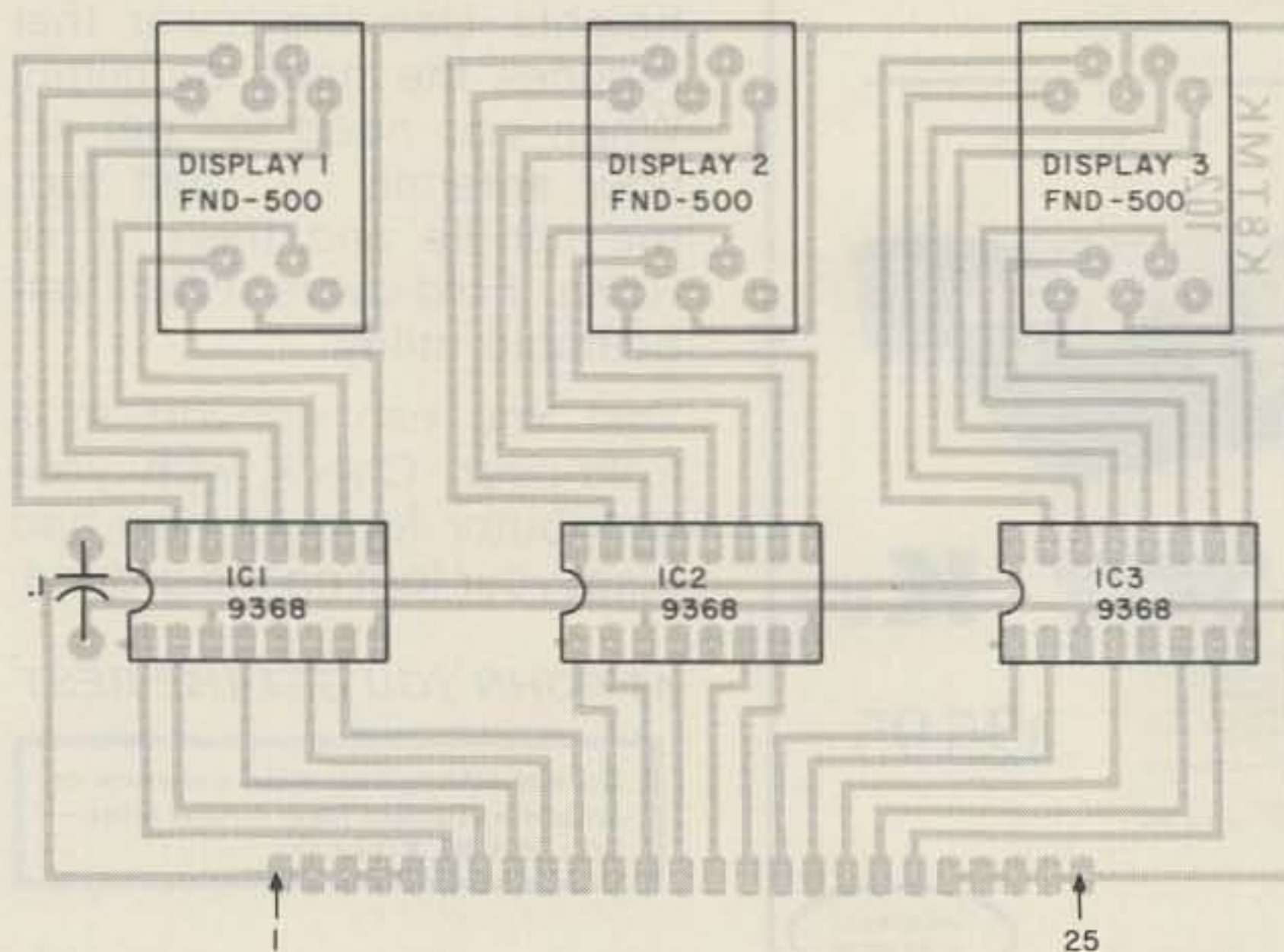
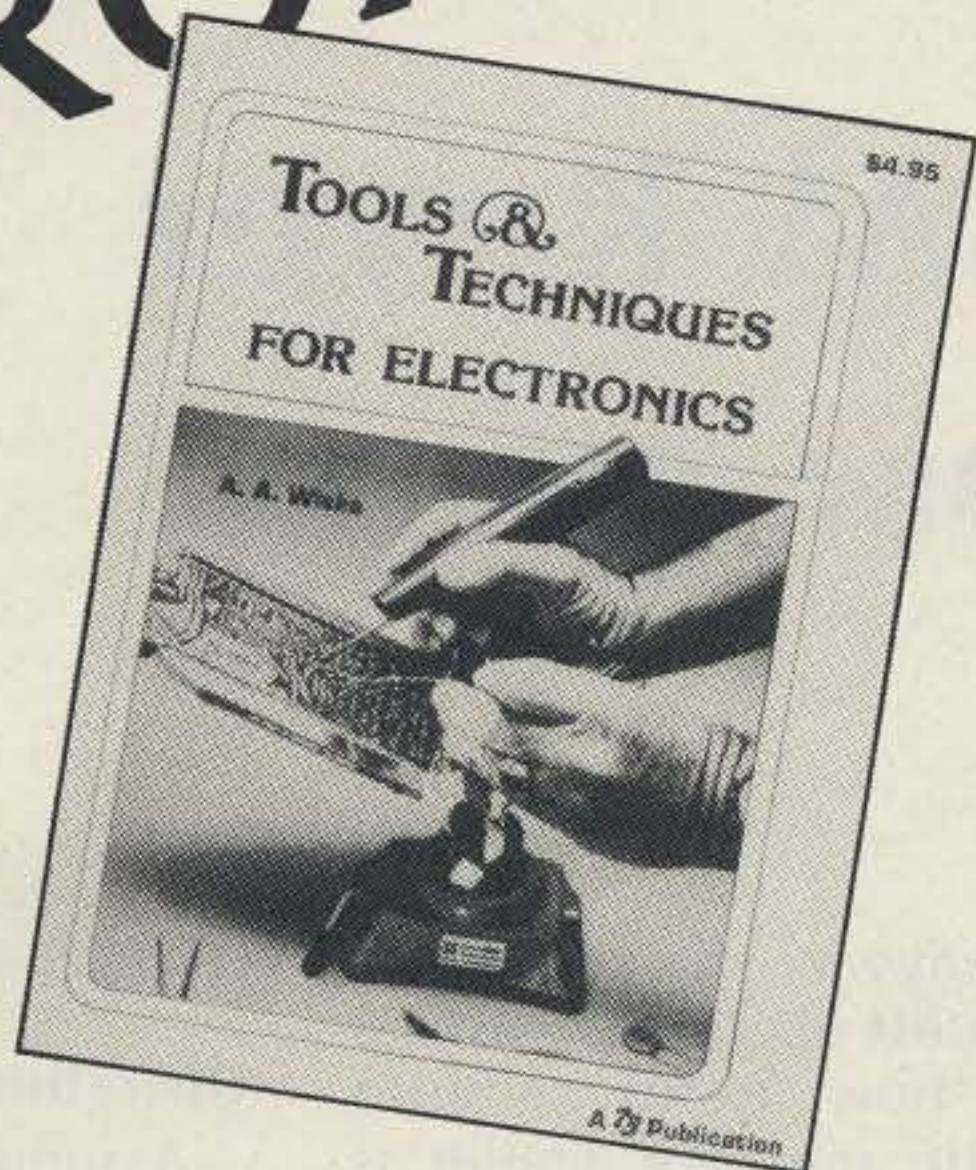

Fig. 6. Component layout for the display circuit board (shown from the component side).

redesign the control box for use with a microprocessor. This will allow me to punch in a prefix on a keyboard, for example, and then simply wait for the rotator to reach the correct position automatically. ■

NEW FROM 73



Tools and Techniques for Electronics (BK7348) is a comprehensive guide to the tools and construction practices used by today's electronics hobbyist. This new 73 Magazine publication should be a part of the library of anyone who has ever built or fixed any electronic gear. The text and numerous pictures and illustrations provide an easy-to-understand description of the safe and correct way to use the basic and specialized tools needed for electronics work.

The first part of Tools and Techniques for Electronics covers the basic tools that will assist the amateur Novice, CB operator, or beginning computer kit builder. It is also an excellent review for more experienced hobbyists. The second portion of the text will be of interest to the advanced tool user. It explains specialized metal working tools as well as the chemical aids that are used in repair shops. The final chapters of Tools and Techniques for Electronics discuss the construction skills that result in a professional-looking project.

Handy reference data on English/metric conversions, machine screw data, and the like will be found in the appendices. The contents of basic and advanced tool kits are outlined, and the book includes a list of suppliers.

Whether you are interested in working with tubes or the latest wire-wrap techniques, a great deal of pride and satisfaction can be gained by building or repairing your own equipment. 73's Tools and Techniques for Electronics shows you the way.

Order your copy today! Only \$4.95 from the Radio Bookshop. Use the handy order form on the Reader Service Card at the back of the magazine or phone toll free 1-800-258-5473.

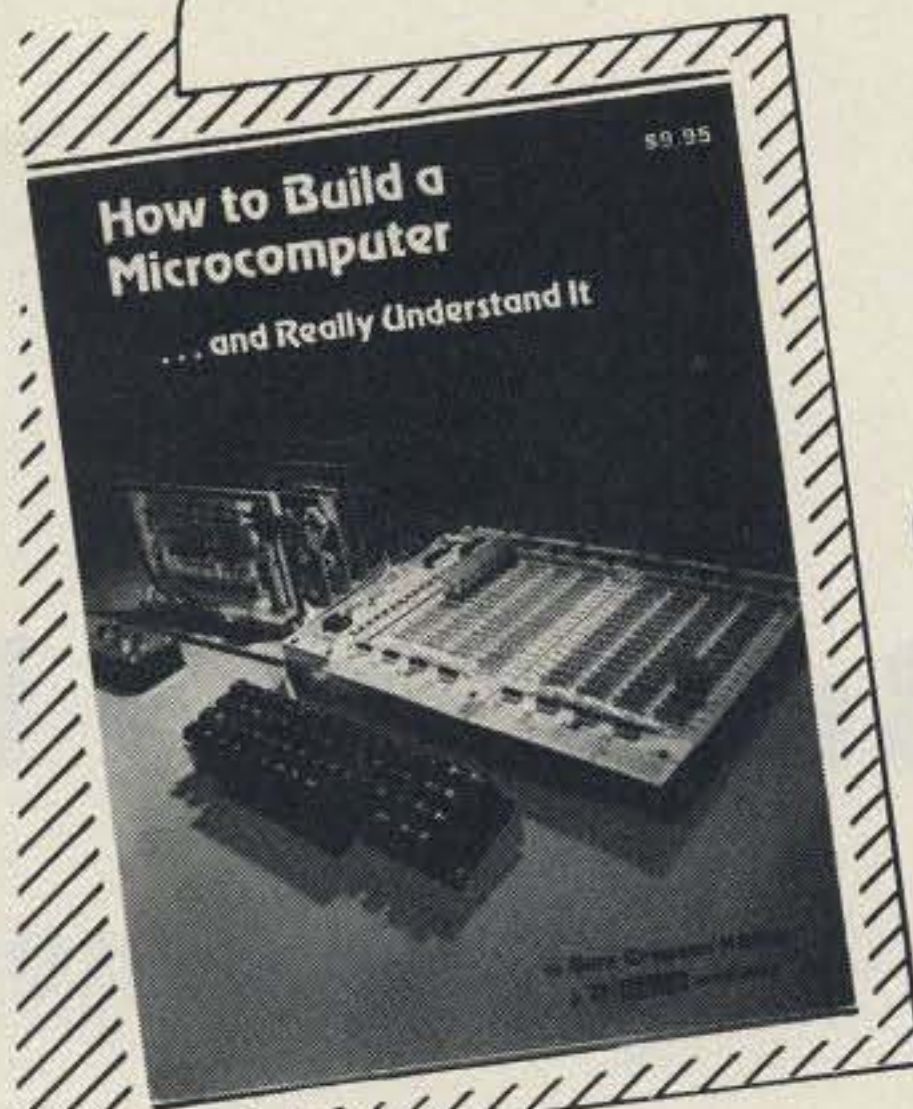

How to Build a Micro-computer

... and Really Understand It

\$9.95

- ★ **Complete circuit board layouts included**
- ★ **Ready-made boards available**
- ★ **Uses the popular 6502 chip (same as the KIM, PET, APPLE)**
- ★ **Uses readily-available parts**
- ★ **Component kits available**

While considerable information is available on the generalities of how a microcomputer works or how to program a microcomputer, you'll be hard pressed to find information concerning the construction of a single, specific system.

Finally, electronic hobbyists are able to build their own microcomputer system with Sam Creason's book, "How To Build A Microcomputer and Really Understand It." Creason's book is a combination technical manual and programming guide that takes the hobbyist step-by-step through the design construction, testing, and debugging of a complete microcomputing system.

Once your computer has been properly programmed, it can be a powerful tool for use in the amateur radio station. Examples include a CW generator, a digital voltmeter, and a programmable signal generator. This book is must reading for anyone desiring a true understanding of small computer systems.

To order, write 73 Magazine Mail-Order Dept. #S95 Peterborough NH 03458. Include name and address and \$10.95 (\$9.95 plus \$1.00 shipping and handling).

Please rush my copy of "How To Build A Microcomputer" (BK7325)

Name _____

Address _____ Apt# _____

City _____ State _____ Zip _____

I enclose \$10.95 (\$9.95 plus \$1.00 shipping and handling)

Bill my credit card

Visa

Master Charge

Credit Card# _____ Exp. date _____

Signature _____

73 Magazine Mail-Order Dept. #S95
Peterborough NH 03458

Build the KIM Keyer

— with a 3-message memory

Marvin L. De Jong KØEI
 Dept. of Math-Physics
 The School of the Ozarks
 Pt. Lookout MO 65726

The short application program listed in Table 1 allows the KIM-1 to send any of three messages by pressing one of three keys (A, B, or C) on the KIM-1 keyboard, and, with the interface circuit shown in Fig. 1, the KIM-1 becomes an electronic keyer as well. Any microcomputer with a

650X microprocessor and one of the MOS Technology PIA or VIA chips may be used with only minor modifications to the program. An important feature of the program is the ability to precisely set the code speed between 5 and 99 words per minute by entering the speed, in decimal, at storage location 0000 in memory. The program converts this decimal number to hexadecimal, then does a division routine to convert the speed to a time duration of the basic dot element, and the interval timers on the 6530 PIA do the rest.

Anyone who does much contest operating will realize how useful an automatic message sender is. Even the casual CW operator can use it for sending CQ or other routine messages. Code tests for Novices can be programmed and sent at precisely 5 wpm by storing the entire test in memory. At 5 wpm, at least 5 minutes of code may be sent. For Field Day (1977), we used a similar program to send CQ CQ CQ FD DE KØEI KØEI K as message A, then when a station responded, we sent () DE KØEI UR 599 MO 599 MO K, where the blank was the call of the station to be keyed by the operator, after which he hit key B to give the remainder of the message. It worked very smoothly with no discernible pause between the call letters and the message. (Don't try to look up our score, because KØEI was not the call we used.) The operation of the keyer is exactly like most electronic keyers; holding the paddle in the dot position will cause a series of dots and spaces to be sent. Dashes occur with the paddle in the dash position, and the timing of all the characters is controlled by the program and the crys-

tal on the microcomputer.

Operation

Assuming the program has been loaded and the interface circuit connected, operation proceeds as follows. The code speed at which you wish to operate is loaded into storage location 0000. Any decimal number from 05 to 99 may be put into this location. Next, the starting and ending addresses of each message must be loaded into memory. Since all three messages are in page 2 of memory, only the low-order bytes of the starting and ending addresses need be given. Suppose message A starts at 0200 and ends at 0251, message B starts at 0252 and ends at 0265, while message C starts at 0266 and ends at 0278. (These are completely weird numbers chosen at random from my skull and have absolutely no other significance.) Then one would load 00, the starting address of message A, at location 0001; 52, the starting address of message B goes in at 0002; and 66 is entered at 0003. The respective ending addresses go into memory locations 0004 to 0006, that is, 51 into 0004, 65 into 0005, and 78 into 0006.

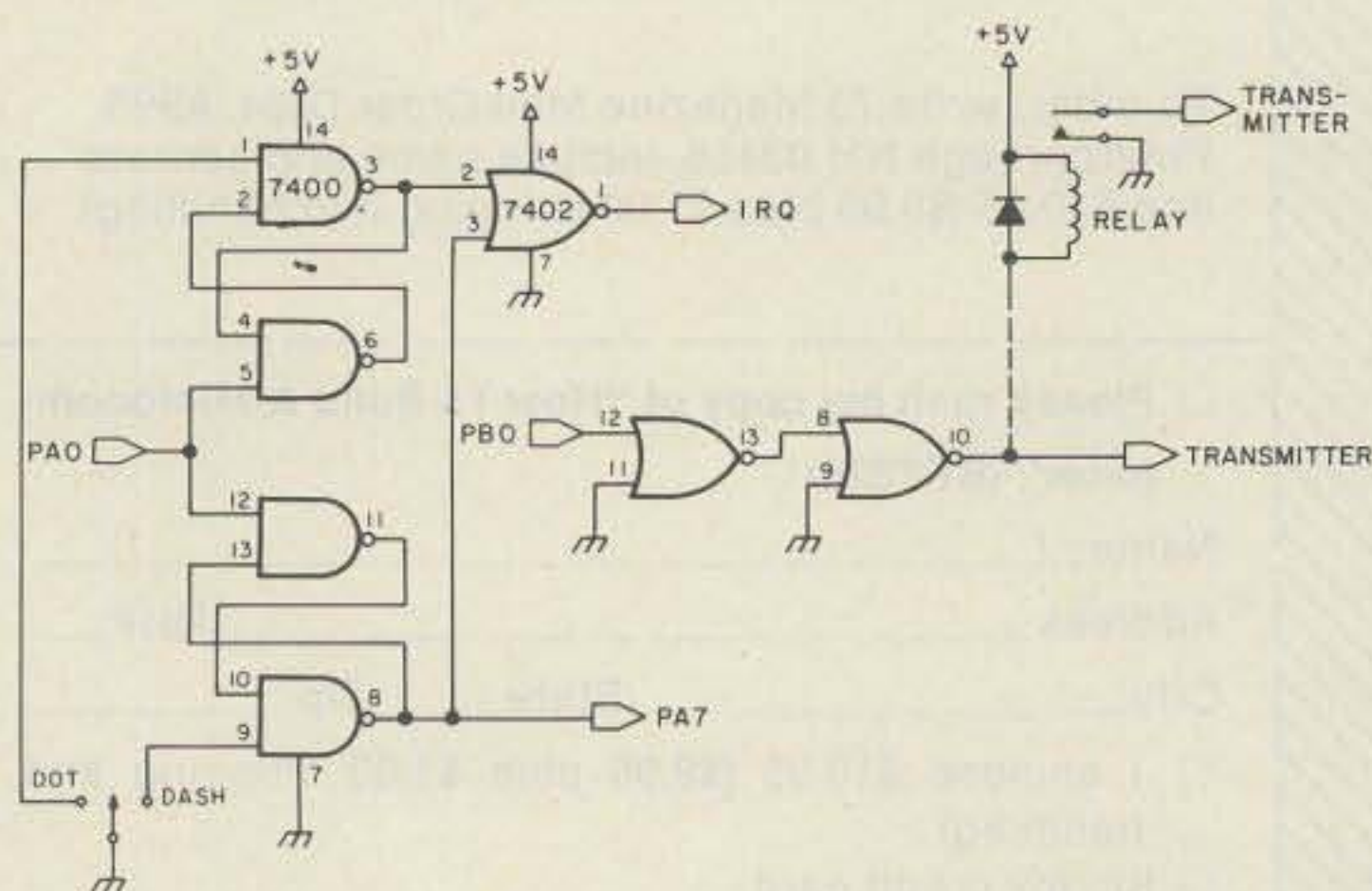

Fig. 1. Interface circuit. Some transmitters may require the optional relay for keying, with a 1N914 diode across the coil for protection against transient voltages. The Triton IV may be keyed directly from pin 10 of the 7402. All grounds should be the same as the KIM-1 ground, and the 5 volts may be stolen from the KIM-1 power supply.

How do you load the messages themselves? For each character you want to send, you must load the corresponding hex number shown in Table 2. Suppose, for no reason whatsoever, message A is to be "DE KØEI K" and is to start at 0200. You then load the hex numbers 90 40 00 B0 FC 40 20 00 B0 from locations 0200 through 0208; 00 goes into 0001 and 08 into 0004.

Probably the best way to proceed is to first load the three messages including spaces, noting the starting and ending addresses of each message on a piece of paper. Then go back to page 0 and put the starting and ending addresses in their proper locations. Go to location 0300 and hit the GO button to start the program running. Test to make sure everything is working before you put the thing on the air.

Programming Details

The flowchart shown in Fig. 2 and the comments in the program should give the reader a good feeling

for the structure of the program. It consists of three principle parts: the main program, subroutine SEND, and the interrupt routine, all of which have individual flowcharts shown. Minor components are subroutine DIT (which holds PBØ at logic 0 for the dot length followed by a logic 1 for the space length), subroutine DAH (which holds PBØ at logic 0 for three dot lengths—1 dah = 3 dits—followed by a space), and subroutine TIMER (which loads the timer on the KIM-1 with the precise length of 1 dot and then waits for this time to elapse).

We now look at some specific details of the program. The speed in words per minute must be converted to hex before the computer can do any further calculations with it. This conversion may best be explained with an example. Suppose we wish to operate at 20 wpm, so 20 is entered into location 0000. What we mean by 20 is 2 in the tens place and 0 in the

ones place, but what the computer thinks this means is 2 in the sixteens place and 0 in the ones place. At least we agree on the ones place, so initially we mask the ones place out with an AND statement; later we retrieve it and simply add it to the result of our decimal-to-hex conversion of the 2. To trick the computer into thinking the 2 in the sixteens place is the 2 in the tens place we intended it to be, we change the sixteen to a ten with this trick: $10 = 16/2 + 16/8$. The sixteens place divided by two is accomplished by one shift-right statement (LSR), while the sixteens place divided by 8 is accomplished by three shift-right statements. So, the 2 in the sixteens place is shifted right once, stored, shifted right two more times, and these two results are added. We now have 2×10 in the computer (in hex, of course) rather than 2×16 . Adding the results from the ones place completes the conversion.

Using the keying speed definitions from *The Radio Amateur's Handbook*, one can calculate that the dot length in milliseconds is $1200/S$, where S is the code speed in words per minute. If the divide-by-1024 timer on the KIM-1 is used, 1 count corresponds to 1.024 milliseconds. Converting the dot length to timer counts gives $TIME = (1172/S)$ base 10 = $(494/S)$ hex, where TIME is the number to be loaded into the divide-by-1024 timer to give a code speed of S wpm. So, the computer must divide S into 494. This is determined by successively subtracting S from 494 until the result becomes negative. The number of subtractions is the quotient of $494/S$.

Pin PBØ on the KIM-1 is used as the keying output from the computer. When power is applied to the computer and the reset button is depressed, PBØ comes up in a logic 1 state. This dictates that logic 1 corresponds to the transmitter being off. Consequently, PBØ is buffered and inverted twice by the NOR gates. Inverters such as the 7404 would work, but since I needed a NOR gate in the keyer interface, I simply used the other NOR gates on the same

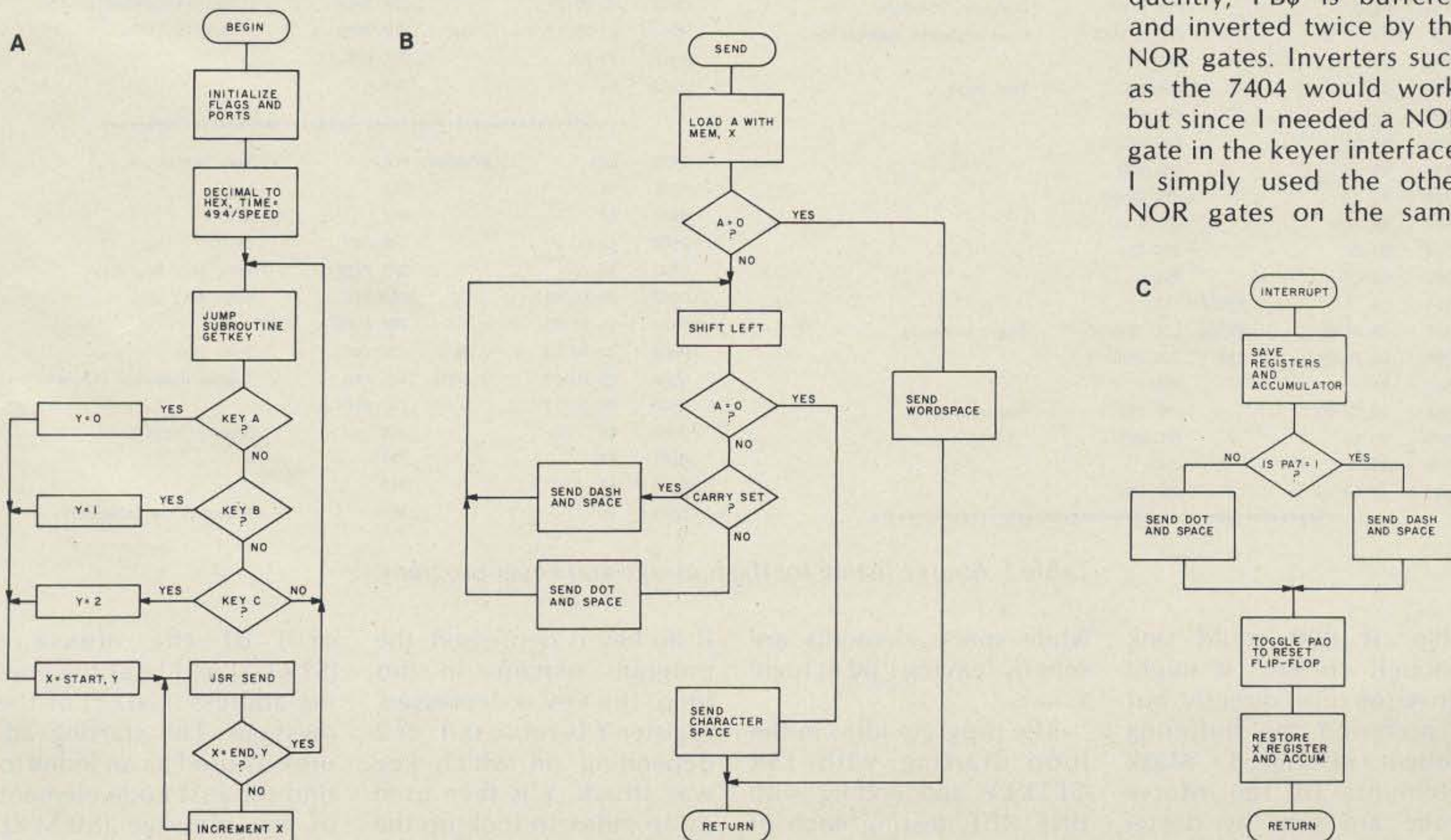

Fig. 2. Flowchart for the keyer and message sender. (a) Main program. (b) SEND subroutine. (c) Interrupt routine.

Address	Instruction	Label	Op Code	Operand	Comments	Address	Instruction	Label	Op Code	Operand	Comments	
0300	78	BEGIN	SEI		Prevent interrupts.	0376	8A		SEND	TXA		
0301	D8		CLD		Binary mode.	0377	48			PHA		
0302	A9 C9		LDA \$C9		Set interrupt vectors.	0378	BD 00 02		LDA	MEM,X	Get code element.	
0304	8D FE 17		STA IRQL			037B	FO 1E			BEQ	WDSP	
0307	A9 03		LDA \$03			037D	0A	HERE		ASL	A	
0309	8D FF 17		STA IRQH			037E	FO 10			BEQ	FINSH	
030C	A9 01		LDA \$01		Initialize I/O Ports A and B.	0380	48			PHA		
030E	8D 02 17		STA PBD			0381	BO 06			BCS	DASH	
0311	8D 03 17		STA PBDD		PB0 is output pin.	0383	20 A0 03			JSR	DIT	Send dot.
0314	8D 01 17		STA PADD		PA0 is output pin.	0386	4C 8C 03			JMP	ARND	
0317	8D 00 17		STA PAD			0389	20 B9 03		DASH	JSR	DAH	Send dash.
031A	CE 00 17		DEC PAD		Toggle PA0 to reset debounce circuit.	038C	68		ARND	PLA		
031D	EE 00 17		INC PAD			038D	4C 7D 03			JMP	HERE	
0320	A5 00		LDA SPEED		Get decimal value of speed from location 0000 and convert it to hex.	0390	A2 02		FINSH	LDX	\$02	
0322	48		PHA			0392	20 BE 03		AGN	JSR	TIMER	Character space.
0323	29 FO		AND \$FO			0395	CA			DEX		
0325	4A		LSR A		Multiply tens digit by ten.	0396	DO FA			BNE	AGN	
0326	85 10		STA SCRATCH			0398	68			PLA		
0328	4A		LSR A			0399	AA			TAX		
0329	4A		LSR A			039A	60			RTS		
032A	18		CLC			039B	A2 04		WDSP	LDX	\$04	Word space.
032B	65 10		ADC SCRATCH			039D	4C 92 03			JMP	AGN	
032D	85 10		STA SCRATCH		Result of multiplication here.	*****						
032F	68		PLA		Get SPEED again.	03A0	A2 01		DIT	LDX	\$01	
0330	29 OF		AND \$OF		Add ones digit to SCRATCH.	03A2	CE 02 17		BACK	DEC	PBD	
0332	65 10		ADC SCRATCH			03A5	20 BE 03		SPA	JSR	TIMER	
0334	85 10		STA SCRATCH		Decimal to hex complete.	03A8	CA			DEX		
0336	38		SEC		Division routine begins here.	03A9	DO FA			BNE	SPA	
0337	A2 00		LDX \$00			03AB	AD 02 17			LDA	PBD	
0339	A9 94		LDA \$94			03AE	4A			LSR	A	
033B	85 08		STA LO			03AF	BO 07			BCS	DONE	
033D	A9 04		LDA \$04			03B1	EE 02 17			INC	PBD	
033F	85 09		STA HI			03B4	E8			INX		
0341	A5 08	UP	LDA LO			03B5	4C A5 03			JMP	SPA	
0343	E5 10		SBC SCRATCH			03B8	60		DONE	RTS		
0345	85 08		STA LO			*****						
0347	A5 09		LDA HI			03B9	A2 03		DAH	LDX	\$03	
0349	E9 00		SBC \$00			03BB	4C A2 03			JMP	BACK	
034B	85 09		STA HI			*****						
034D	E8		INX			03BE	A5 07		TIMER	LDA	TIME	Delay for the number of
034E	BO F1		BCS UP			03C0	8D 07 17			STA	TIMER	1,024 millisecond units
0350	86 07		STX TIME		Division Complete.	03C3	2C 07 17		CHK	BIT	TIMER	stored in TIME.
0352	20 6A 1F	RPT	JSR GETKEY		Read keyboard subroutine.	03C6	10 FB			BPL	CHK	
0355	58		CLI			03C8	60			RTS		
0356	A0 00		LDX \$00		Test keys.	*****						
0358	C9 0A		CMP \$0A			03C9	48		INTERRUPT	PHA		Save registers.
035A	FO 0A		BEQ MESSA			03CA	8A			TXA		
035C	C9 0B		CMP \$0B			03CB	48			PHA		
035E	FO 05		BEQ MESSB			03CC	AD 00 17			LDA	PAD	Is PA7 = logic 1?
0360	C9 0C		CMP \$0C			03D0	30 06			BMI	PAST	Yes, dah. No, dit.
0362	DO EE		BNE RPT			03D2	20 A0 03			JSR	DIT	Send dot.
0364	C8		INY			03D5	4C DA 03			JMP	ACRS	
0365	C8	MESSB	INY			03D8	20 B9 03		PAST	JSR	DAH	Send dash.
0366	BE 01 00	MESSA	LDX STRT,Y		Start message.	03DB	CE 00 17		ACRS	DEC	PAD	Toggle debounce circuit.
0369	20 76 03	CNT	JSR SEND			03DD	EE 00 17			INC	PAD	
036C	8A		TXA			03E0	68			PLA		Restore registers.
036D	D9 04 00		CMP END,Y		End message?	03E1	AA			TAX		
0370	FO EO		BEQ RPT			03E2	68			PLA		
0372	E8		INX			03E3	40			RTS		Return from interrupt.
0373	4C 69 03		JMP CNT			*****						

Table 1. Source listing for the message and keyer program.

chip. If PB0 could sink enough current, it might drive the relay directly, but I preferred the buffering shown in Fig. 1. Mark elements of the Morse code are sent by decrementing (DEC) PB0 for the appropriate length of time,

while space elements are sent by leaving PB0 at logic 1.

The program idles in the loop starting with JSR GETKEY and ending with BNE RPT, testing each of three keys (A, B, and C) to see if they were depressed.

If no key is depressed, the program remains in this loop. If a key is depressed, register Y is set to 0, 1, or 2 depending on which key was struck. Y is then used as an index to look up the starting address (low-order byte of page two of mem-

ory) of the message (STRT,Y) and later the ending address (END,Y) of the message. The starting address is used as an index to find the first code element of the message (MEM,X), and it is incremented until the ending address is en-



ENTER A WHOLE NEW WORLD with KILOBAUD MICROCOMPUTING

... and get your first issue FREE!

Hardly a day passes without the computer having some effect on millions around the world. The world of microcomputing is changing every day, and there's one way you can keep up to speed in this dynamic field: Subscribe to Kilobaud **MICROCOMPUTING**. **MICROCOMPUTING** magazine is the forerunner in small business and home computing, loaded with articles on the most popular microcomputers available: the TRS-80, Apple, PET, Heathkit, Imsai and Altair, to name a few. In addition, the articles cover a whole range of subjects, from business applications to educational uses, from product reviews to the latest in software.

As a special limited offer to new subscribers, we'll send you your first issue absolutely free! You'll receive 13 issues for the price of 12. And we're offering you a year's subscription at half the newsstand price . . . only \$15 (it's \$30 a year on the newsstand), and the only difference between a subscriber copy and a copy of **MICROCOMPUTING** on the newsstand is \$1.25. Send in the card today and we'll deliver your first copy in 4-6 weeks.

ENTER A WHOLE NEW WORLD WITH KILOBAUD MICROCOMPUTING And Get Your First Issue Free!

- Send me my first issue of **MICROCOMPUTING** free and start my subscription into the new world of **MICROCOMPUTING**.
- One year (12 issues) at half the cover price—\$15.
- I prefer the additional savings of 3 years (36 issues) for \$45. I understand that I'll still receive my first issue free.
- Payment Enclosed Bill Me Later
- Bill my Master Charge Visa

Card # _____ Exp. Date _____
 Signature _____
 Name _____
 Address _____
 City _____ State _____ Zip _____

Offer good in U.S.A. and possessions only. Canadian subscriptions add \$2.00 per year. All foreign, one year only—\$23 payable in U.S. currency only.
 MICROCOMPUTING Subscription Department ●
 P.O. Box 997 ● Farmingdale NY 11737 739B

ENTER A WHOLE NEW WORLD WITH KILOBAUD MICROCOMPUTING And Get Your First Issue Free!

- Send me my first issue of **MICROCOMPUTING** free and start my subscription into the new world of **MICROCOMPUTING**.
- One year (12 issues) at half the cover price—\$15.
- I prefer the additional savings of 3 years (36 issues) for \$45. I understand that I'll still receive my first issue free.
- Payment Enclosed Bill Me Later
- Bill my Master Charge Visa

Card # _____ Exp. Date _____
 Signature _____
 Name _____
 Address _____
 City _____ State _____ Zip _____

Offer good in U.S.A. and possessions only. Canadian subscriptions add \$2.00 per year. All foreign, one year only—\$23 payable in U.S. currency only.
 MICROCOMPUTING Subscription Department ●
 P.O. Box 997 ● Farmingdale NY 11737 739B

Morse Character	Hex	V	18
A	60	W	70
B	88	X	98
C	A8	Y	B8
D	90	Z	C8
E	40	1	7C
F	28	2	3C
G	D0	3	1C
H	08	4	0C
I	20	5	04
J	78	6	84
K	B0	7	C4
L	48	8	E4
M	E0	9	F4
N	A0	0	FC
O	F0	Word space	00
P	68	\overline{SK}	16
Q	D8	\overline{BT}	8C
R	50	\overline{AR}	54
S	10	/	94
T	C0	.	56
U	30	?	CE
			32

Table 2. Morse character to hex conversion.

Location	Contents
0000	Speed in decimal (words per minute)
0001	Starting address of message A (low-order byte)
0002	Starting address of message B
0003	Starting address of message C
0004	Ending address of message A (low-order byte)
0005	Ending address of message B
0006	Ending address of message C
00F1	04 (Prevents interrupts while in monitor)

Table 3. Storage locations to be loaded by the operator.

countered.

The conversion of an 8-bit word of memory to a Morse code character has been described in other references in detail and will not be repeated here. There are a number of

schemes available,^{1,2} but the most efficient schemes appear to be those in references 3 and 4, and those were the techniques used here.

The keyer is implemented by the interrupt routine,

which in turn uses subroutines DIT, DAH, and TIMER. It will send at exactly the same speed as the messages. The keyer interface circuit is simply debouncers which are reset at the end of an interrupt. If the key is still in the dot or dash position, the reset has no effect and another interrupt occurs. The flowchart indicates that the state of PA7 determines which element is to be sent.

One last thought: If you want to be able to key in a few characters in the middle of a message, just load a few word spaces there and key the characters in

when the blank occurs. This is handy for giving signal reports and also in some contests where the number of contacts is updated after each QSO. ■

References

1. Pollock, James W., "1000 WPM Morse Code Typer," 73, January, 1977, p. 100.
2. De Jong, Marvin L., "A Complete Morse Code Send/Receive Program for the KIM-1," MICRO, April-May, 1978, p. 7.
3. Pollock, James W., "A Microprocessor Controlled CW Keyboard," Ham Radio, January, 1978, p. 81.
4. Ockers, Stan, "Code Test," The First Book of KIM, ORB, Argonne, Illinois, 1977, p. 56.

EXTEND YOUR RANGE...

With the **RPT-1B Repeater**. Backed by Standard Communications' years of experience in producing quality repeaters for the commercial and amateur market, this superior 10 watt VHF repeater operates on a single pair of channels in the 143-149 MHz range. It contains separate transmitter and receiver assemblies for the re-transmission of signals and a COR/TIMER for control of the switching/timing/monitoring functions of the system. In addition, an optional private channel unit may be installed as an accessory. It may be operated in either a repeat or duplex mode. Priced under \$850 from your dealer.

Write today for a FREE Catalog Sheet or see your nearest Standard Communications Dealer.



Standard Communications

P.O. Box 92151, Los Angeles, California 90009

FAST SCAN ATV

ALL YOU NEED IN ONE BOX



Show the shack, home movies, computer games, etc. Connect to the ant. terminals of any TV set, add a good 450 antenna, a camera, and you are there...

- 10 Watts peak RF output. Specify 434.0 or 439.25 MHz
- Subcarrier sound with plenty of mic gain for distance pick-up.
- 8 MHz bandwidth, high resolution necessary for computer alphanumerics and color.
- Tuneable converter covers 420 to 450. (Covers CH 2, 3)
- Contains AC to 12VDC regulated 3 AMP power supply.
- Only \$399.00 direct mail. Check, Money Order, VISA. Send S.A.S.E. for catalog of ATV Modules and PC Boards.



HITACHI HV-62U TV CAMERA \$239 ppd.

- Better than 500 line resolution. 7 watts on 117VAC.
 - Small 4x25/8x8 inches. Can run on 12vdc @ 230ma.
 - 10,000:1 automatic light compensation. Lens included.
- Send SASE for catalog of ATV and UHF products VISA or MC orders call (213) 447-4565.

P.C. ELECTRONICS

Maryann
WB6YSS

2522 PAXSON
ARCADIA, CA 91006

Tom
W6ORG

FOR BEST PRICE AND FAST DELIVERY CALL

1-800-325-3636

TOLL FREE



HAM RADIO CENTER

8340-42 Olive Blvd. P.O. Box 28271 St. Louis, MO 63132

H2

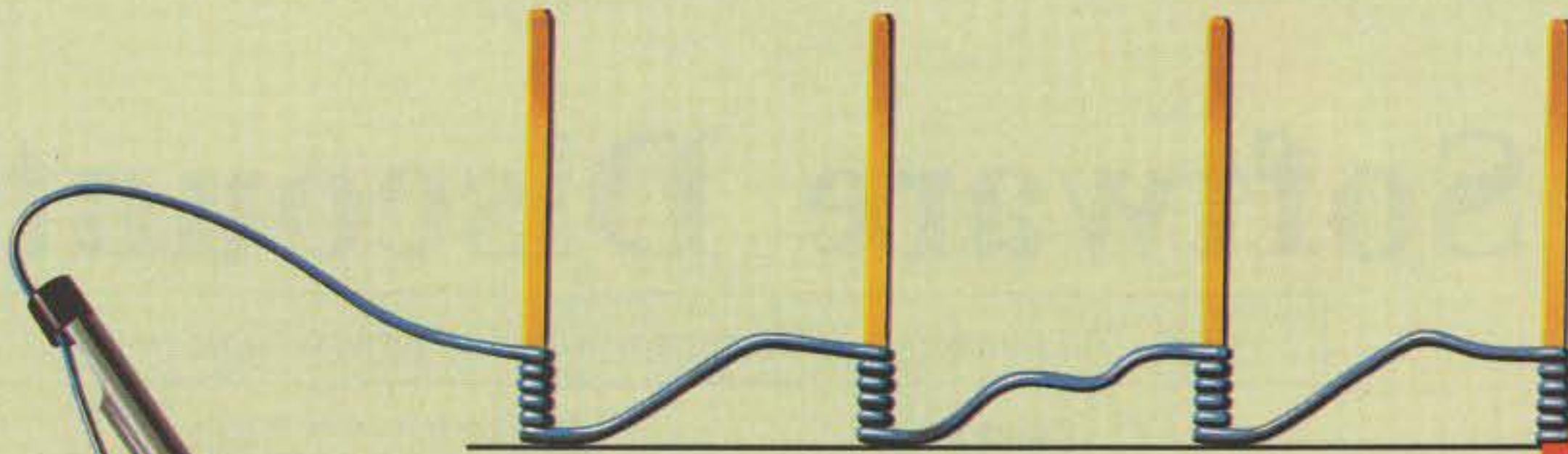

WHY CUT? WHY STRIP? WHY SLIT?
WHY NOT...

NEW

JUST WRAP™

WIRE WRAPPING TOOL

- AWG 30 Wire
- .025" Square Posts
- Daisy Chain or Point To Point
- No Stripping or Slitting Required
- ...JUST WRAP™...
- Built In Cut Off
- Easy Loading of Wire
- Available Wire Colors: Blue, White, Red & Yellow

traditional Wire-Wrapping

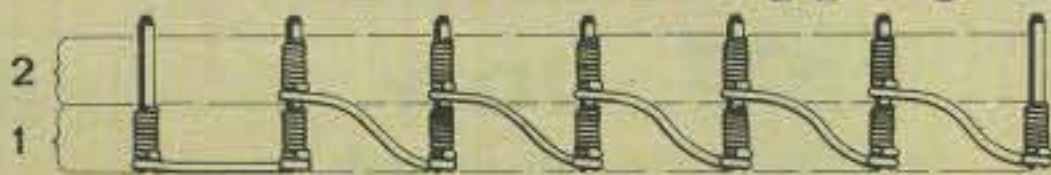

JUST WRAP Wire-Wrapping

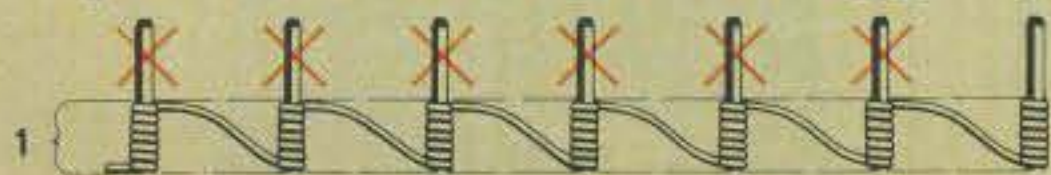

U.S.A., FOREIGN PATENTS PENDING

JUST WRAP TOOL WITH ONE 50 FT. ROLL OF WIRE		
COLOR	PART NO.	U.S. LIST PRICE
BLUE	JW-1-B	\$ 14.95
WHITE	JW-1-W	14.95
YELLOW	JW-1-Y	14.95
RED	JW-1-R	14.95
REPLACEMENT ROLL OF WIRE 50 FT.		
BLUE	R-JW-B	\$ 2.98
WHITE	R-JW-W	2.98
YELLOW	R-JW-Y	2.98
RED	R-JW-R	2.98
JUST WRAP-UNWRAPPING TOOL		
	JUW-1	\$ 3.49



OK MACHINE & TOOL CORPORATION 3455 CONNER ST.,
BRONX, N.Y. 10475 (212) 994-6600/TELEX 125091

*MINIMUM BILLING \$ 25.00/ADD SHIPPING CHARGE \$ 2.00/NEW YORK CITY/STATE RESIDENTS ADD APPLICABLE TAX.

Get a Software Discount!

TRS-80* Level I

Knights Quest/Robot Chase/Horse Race
16K; Order No. 0003R.

Cave Exploring/Yacht/Memory 16K; Order No. 0010R.

Car Race/Rat Trap/Antiaircraft 4K; Order No. 0011R.

Status of Homes/Auto Expenses 4K; Order No. 0012R.

BUSINESS PACKAGE I Keep the books for a small business with your TRS-80 Level I 4K. The six programs included are:

- **General Information**—The instructions for using the package.
- **Fixed Asset Control**—This will give you a list of your fixed assets and term depreciation.
- **Detail Input**—This program lets you create and record your general ledger on tape for fast access.
- **Month and Year to Date Merge**—This program will take your monthly ledger data and give you a year to date ledger.
- **Profit and Loss**—With this program you can quickly get trial balance and profit and loss statements.
- **Year End Balance**—This program will combine all your data from the profit and loss statements into a year end balance sheet.

With this package, you can make your TRS-80 a working partner. **Order No. 0013R \$29.95.**

Demo I 4K; Order No. 0020R.

Destroy All Subs/Bomber/Gunboats 4K; Order No. 0021R.

PERSONAL FINANCE I Let your TRS-80 handle all the tedious details the next time you figure your finances:

- **Personal Finance I**—With this program you can control your incoming and outgoing expenses.
- **Checkbook**—Your TRS-80 can balance your checkbook and keep a detailed list of expenses for tax time. This handy financial control package for the home requires only a TRS-80 Level I 4K. **Order No. 0027R**

Doodles and Displays I 16K Order No. 0030R.

Space Trek III 4K; Order No. 0031R.

Fun Package I 16K; Order No. 0037R.

Hex Pawn/Shuttle Craft Docking/Space Chase/Sea Battle
16K; Order No. 0041R.

BUSINESS PACKAGE III This package can change your TRS-80 into a full working partner for any businessman:

- **Inventory**—Maintain a computer based inventory for a constant inventory system.
- **Discount and Commission Percentages**—Let your computer figure out mark up and discount calculations, sales tax and more. This is a perfect time saving package for any small business.

For the TRS-80 Level I 4K. **Order No. 0061R**

Level I and II

Basic and Intermediate Lunar Lander
4K; L.I, 16K L.II; Order No. 0001R.

Space Trek II 4K L.I, 16K L.II; Order No. 0002R.

Backgammon and Keno 4K L.I, 16K L.II; Order No. 0004R.

Ham Package 4K L.I, 16K L.II; Order No. 0007R.

Electronics I 4K L.I, 16K L.II; Order No. 0008R.

Golf/Crossout 4K L.I, 16K L.II; Order No. 0009R.

Air Flight Simulation 4K L.I, 16K L.II; Order No. 0017R.

Oil Tycoon 4K L.I, and L.II; Order No. 0023R.

Bowling 4K L.I, 16K L.II; Order No. 0033R.

SANTA PARAVIA AND FIUMACCIO The year is AD 1400, and you are the ruler of a tiny Italian city-state. You are ambitious by nature and intend to build your little city-state into a powerful kingdom.

So begins Santa Paravia and Fiumaccio, where you and your fellow players compete as rulers of neighboring cities. You control the grain harvest, feed your people, set tax rates, exercise justice, invest in public works and, of course, try to stay on the good side of the church.

Life was short back then, and you'll have only a limited amount of time in which to build your kingdom. The lives of your serfs will depend on your decisions. If they are wise, then your city-state will grow and you will acquire loftier titles. If your rule is incompetent, your people will starve and your city-state may be invaded by your neighbors.

You can play the game yourself, or set up the tournament version, which allows up to six players at a time to compete. Either way, you're sure to find your route to the throne a challenging and rocky road.

How will you rule your kingdom? Will you be a benevolent ruler—an iron fist in a velvet glove—or will you become unscrupulous and follow the example set by Niccolo Machiavelli in his book on government, *The Prince*? Only you can answer that question—with Santa Paravia and Fiumaccio. **Order No. 0043R**

All Packages \$7.95 except where otherwise indicated.

Level II

Model Rocket Analyzer and Pre-Flight Check
16K; Order No. 0024R.

RAMROM PATROL

The Ramrom probe ships are steadily advancing. You've only a limited amount of power, and you're a long way from home, but as a member of the Ramrom Patrol, your mission is clear: Destroy the Ramrom probes at any cost. Manage your ship efficiently and effectively, and you just might complete your mission and still have enough fuel to reach your base. If, on the other hand, your "shot" leaves something to be desired, you're sure to wind up in the hands of the dreaded Ramromians—whoever they are. But don't worry—getting there is all the fun!

• **Klingon Capture**—Your mission is to capture a Klingon battle cruiser intact—no mean feat by anyone's standards. In fact, the only known way to bring it home alive is to destroy any stars that happen to surround the cruiser, thereby rendering it incapable of moving. But don't expect the cruiser to sit in one place and allow itself to be caught. You'll have to keep a watchful eye on your screen for the scanner reports and keep your fingers crossed.

• **Tie Fighter**—The object of the game in this simulation of a battle between an X-wing and Tie fighters is to shoot down as many of the enemy as possible within the allotted 200 time units. You fly the X-wing fighter, and if you aim carefully and shoot quickly, who knows... you just might wind up as the next hero of the revolution—or at least your living room! **Order No. 0028R**



TRS-80 UTILITY II The second in a series of programs designed to help the programmer. Utility II will add unprecedented flexibility to your BASIC programs, by allowing you to combine them with other BASIC programs or with machine-language programs or routines.

• **CFETCH**—After you have renumbered your programs using RENUM (see Utility I) you can use the CFETCH program to merge your consecutively numbered BASIC programs. CFETCH also allows you to search a program for its file name, without merging it with the resident BASIC program.

• **CWRITE**—This powerful program allows you to merge one or more machine-language programs with other machine-language programs or with a BASIC program. Merged programs can then be loaded with a single command. CWRITE also makes it possible for you to obtain a general checksum (impossible to do when CLOADING a BASIC program) and also allows you to load programs in non-consecutive locations within the memory. **Order No. 0076R**

TRS-80 UTILITY I

Tired of having your best programming efforts frustrated by the lack of tools? These two powerful TRS-80 utility programs should be stock equipment in every programmer's "toolbox."

• **RENUM**—Never again will you have to leave out that new routine or feature because you lack available line numbers. RENUM will renumber your Level I or Level II programs by whatever increments you specify—including all GOTOs and GOSUBs!

• **DUPLIK**—One of the first laws of computer programming is to retain duplicate copies of all of your programs. With DUPLIK, you'll be able to make and/or compare copies of BASIC, source assembler, and machine-language programs. If you have more than one program on a cassette, DUPLIK will enable you to load and save them all by using a single command—without merging. And all of the above can be performed on your Level I cassettes while you're using your Level II machine! **Order No. 0081R**



Space Trek IV 16K; Order No. 0034R.

Doodles and Displays II 16K; Order No. 0042R.

Bowling League Statistics System
16K; Order No. 0056R. \$24.95

Cards 16K; Order No. 0063R.

Teacher 16K; Order No. 0065R. \$9.95

Household Accountant 16K; Order No. 0069R.

Financial Assistant 16K; Order No. 0072R.

PET**

Personal Weight Control Biorhythms 8K; Order No. 0005P.

MORTGAGE WITH PREPAYMENT OPTION/FINANCIER

These two programs will more than pay for themselves if you mortgage a home or make investments:

• **Mortgage with Prepayment Option**—Calculate mortgage payment schedules and save money with prepayments.

• **Financier**—Calculate which investment will pay you the most, figure annual depreciation, and compute the cost of borrowing, *easily and quickly*.

All you need to become a financial wizard with an 8K PET. **Order No. 0008P**

Casino I 8K; Order No. 0014P.

Casino II 8K; Order No. 0015P.

Checkers/Baccarat 8K Order No. 0022P.

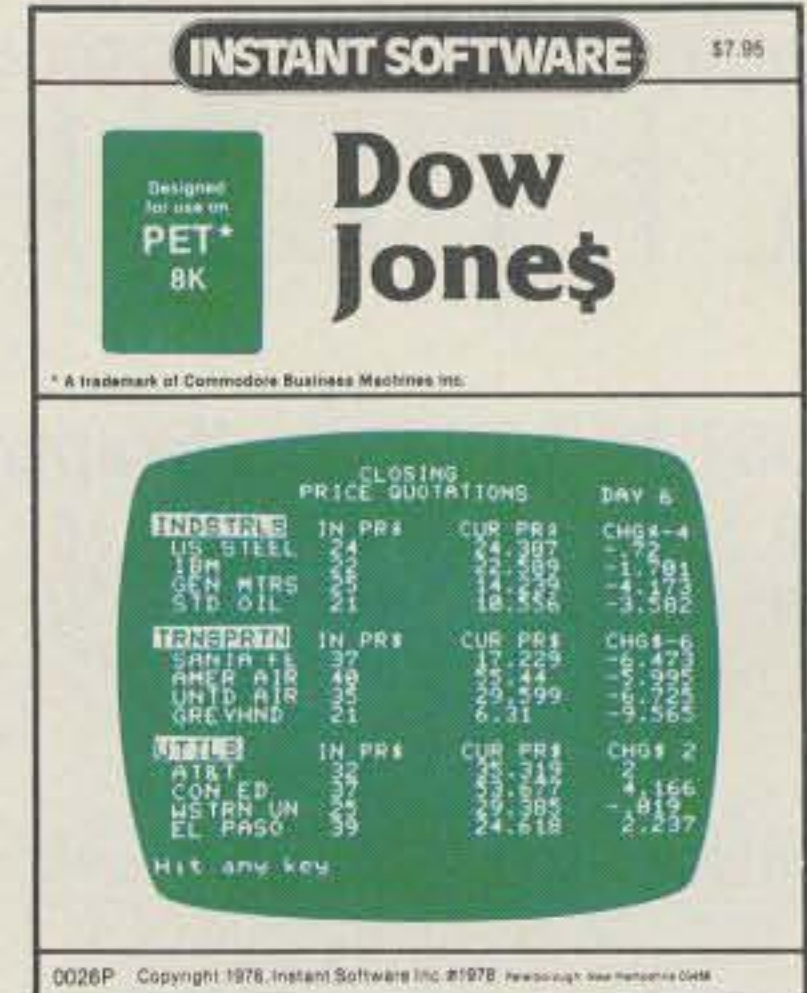

DOW JONES Up to six players can enjoy this exciting stock market game. You can buy and sell stock in response to changing market conditions. Get a taste of what playing the market is all about. Requires a PET with 8K. **Order No. 0026P**

Tangle/Supertrap 8K; Order No. 0029P.

Trek-X 8K; Order No. 0032P.

Qubic-4/Go-Moku 8K; Order No. 0038P.

MIMIC

How good is your memory? You can find out with the Mimic program, and for a fraction of the price of similar games being offered on the market today.

Your PET will flash a sequence of figures on the screen and ask you to repeat them in the same order. It may sound easy, but there are five different programs, one of which is sure to keep you going until you're ready to throw in the towel. It's fun, it's bound to improve your memory, and it's even programmed for optional sound effects; all you need is an amplifier and a speaker. **Order No. 0039P**

Penny Arcade 8K; Order No. 0044P.

Arcade II 8K; Order No. 0045P.

Baseball Manager 8K; Order No. 0062P. \$14.95.

Dungeon of Death 8K; Order No. 0064P.

Arcade I 8K; Order No. 0074P.

Digital Clock 8K; Order No. 0083P.

Turf and Target 8K; Order No. 0097P.

*A trademark of Tandy Corporation

**A trademark of Commodore Business Machines Inc.

***A trademark of Apple Computer Inc.

Now you can get the best for less! Just clip out the coupon below, bring it to your local computer store, and you'll get \$1.00 off the list price of any program package from Instant Software!

Apple***

Golf Applesoft II + 20K Order No. 0018A.

Bowling/Triology 20K; Order No. 0040A.

MATH TUTOR I The Math Tutor I package is designed to help younger children learn the concepts of mathematics. It uses the technique of positive, immediate reinforcement. When the child enters a correct answer, he or she is rewarded with the opportunity to move a spaceship, cast a magic spell, or rescue a man from a most unfortunate fate. By using this method of positive reinforcement, children will learn to associate mathematics

with pleasant experiences, as opposed to the stark reality of numbers that has driven so many pupils to an early dislike of math. The program also provides the opportunity for parents to indulge in a unique learning experience with their children, while introducing them to the exciting world of microcomputing. Teachers can also use the program in a classroom setting to provide that extra incentive. Math Tutor I contains the following programs:

• **Hanging**—A variation of the traditional game of Hangman. In Hanging, students must spare the graphic character's "life" by correctly answering the questions posed by the computer.

• **Spellbinder**—The student is cast as a magician competing against another magician who's controlled by the computer. He must answer the questions about frac-

tions correctly in order to cast magic clouds, fireballs, and other spells at his rival.

• **Whole Space**—Students are given the opportunity to lead an attack on an evil planet. Every time a correct answer is given to a math problem posed by the computer, he can move his ship closer to his goal. Every wrong answer gives the enemy an opportunity to fire back.

Note: the Hanging program requires Applesoft II BASIC. The Whole Space and Spellbinder programs can run in integer BASIC. **Order No. 0073A**

Math Tutor II Applesoft II + 20K Order No. 0098A.

Dealer Inquiries Invited

Ask for Instant Software at a computer store near you.

<p>Alabama</p> <p>The Computer Shack 913 Shadyview Lane, Adamsville</p> <p>Computerland of Huntsville 3020 University Dr. Huntsville</p> <p>Mittels TV & Radio 621 East Broadway, Mesa</p> <p>California</p> <p>Byte Shop of Mt. View 1063 West El Camino Real, Mt. View</p> <p>Byte Shop of Sacramento 6041 Greenback Ln. Citrus Heights</p> <p>Capital Computer Systems 3396 El Camino Ave. Sacramento</p> <p>Computer Components of South Bay 15818 Hawthorne Blvd. Lawndale</p> <p>Computer Components Inc 6791 Westminster Ave. Westminster</p> <p>Computerland 16720 S. Hawthorne, Lawndale</p> <p>Computerland of San Francisco 117 Fremont St. San Francisco</p> <p>Computerland of W. LA 6840 La Cienga Blvd. Englewood</p> <p>Microsun Computer Center 2989 North Main St. Walnut Creek</p> <p>Opamp/Technical Books 1033 N. Sycamore Ave. Los Angeles</p> <p>Radio Shack 8250 Mira Mesa Blvd. San Diego</p>	<p>Silver Spur Elect. Comm. 13552 Central Ave. Chino</p> <p>The Computer Store 820 Broadway, Santa Monica</p> <p>Colorado</p> <p>Byte Shop 3464 S. Acoma St. Englewood</p> <p>Connecticut</p> <p>Bridgeport Computers Inc. 3876 Main St. Bridgeport</p> <p>The Computer Store 43 South Main St., Windsor Locks</p> <p>D.C.</p> <p>Computer Cablevision 2617 42nd St. NW, Wash. DC</p> <p>Florida</p> <p>AMF Electronics 11146 N. 30th St. Tampa</p> <p>Computer Center 6578 Central Ave., St. Petersburg</p> <p>Computerland of Ft. Lauderdale 3963 N. Federal Hwy., Ft. Lauderdale</p> <p>Heath Kit Electronic 4705 W 16th Ave. Center, Hialeah</p> <p>Sound Ideas 2201-C N.W. 13th Gainesville</p> <p>Georgia</p> <p>Atlanta Computer Mart Atlanta</p>	<p>Hawaii</p> <p>Computerland of Hawaii 567 N Federal Hwy.</p> <p>Radio Shack 1712 S. King St. Honolulu</p> <p>Illinois</p> <p>Computer Station 3659 Nameoki Rd. Granite City</p> <p>Midwest Micro Computers, Inc. 708 S. Main St., Lombard</p> <p>Louisiana</p> <p>Computer Shoppe Inc. 3225 Danny Park Suite 222, Metairie</p> <p>Maryland</p> <p>The Comm Center 9624 Ft Meade Rd. Laurel</p> <p>Massachusetts</p> <p>Computer Packages Unlimited 99 Reservoir St. Holden</p> <p>The Computer Store 120 Cambridge St. Burlington</p> <p>Tufts Radio & Electronics 206 Mystic Ave. Medford</p> <p>Michigan</p> <p>Computerland of Grand Rapids 2927 28th St. S.E. Kentwood</p> <p>Computerland of Rochester 301 S. Livernois Rochester</p>	<p>Computerland of Southfield 29673 Northwestern Hwy. Southfield</p> <p>Computer Mart 560 W. 14 Mile Rd. Clawson</p> <p>Hobby House 1035 W. Territorial Rd. Battle Creek</p> <p>Nebraska</p> <p>Omaha Computer Store 4540 S. 84th St. Omaha</p> <p>New Jersey</p> <p>Radio Shack/J&J Electronic Mansfield Shopping Ctr. Hackettstown</p> <p>New Mexico</p> <p>South West Computer Center 121 Wyatt Drive, Suite 7, Las Cruces</p> <p>New York</p> <p>Aristo Craft 314 Fifth Ave. NYC</p> <p>Computer Corner 200 Hamilton Ave. White Plains</p> <p>Computer Factory 485 Lexington Ave. NYC</p> <p>Key Electronics Schenectady</p> <p>Ohio</p> <p>Astro Video Electronics 504 E. Main St. Lancaster</p> <p>Computer Store of Toledo 18 Hillwyck Dr. Toledo</p>	<p>21st Century Shop 16 Convention Way, Cincinnati</p> <p>Oregon</p> <p>Computerland of Portland 12020 SW Main St. Tigard</p> <p>Pennsylvania</p> <p>Artco Elect. 302 Wyoming Ave. Kingston</p> <p>Erie Computer Co. 1253 West 8th St., Erie</p> <p>Personal Computer Corp. Frazer Mall, Lancaster Ave. Frazer</p> <p>South Carolina</p> <p>Seely Communications 1084 Broad St., Sumter</p> <p>Tennessee</p> <p>Computerlab 671 S. Menden Hall Rd. Memphis</p> <p>Texas</p> <p>Computercraft Inc. 3211 Fondren, Houston</p> <p>Computer Port 926 N. Collig, Arlington</p> <p>Interactive Computers 7620 Dashwood Rd. Houston</p> <p>K.A. Elect. 1220 Majesty Dr. Dallas</p> <p>Ram Micro Systems 6353 Camp Bowie Blvd. Ft. Worth</p>	<p>Virginia</p> <p>Home Computer Center 2927 Virginia Beach Blvd. Virginia Beach</p> <p>Washington</p> <p>Personal Computers S 104 Freva, Spokane</p> <p>Ye Old Computer Shop 1301 G. Washington, Richland</p> <p>Wisconsin</p> <p>Byte Shop Of Milwaukee 6019 West Layton Ave. Greenfield</p> <p>Wyoming</p> <p>Computer Concepts 617 W 16th St., Cheyenne</p> <p>Canada</p> <p>Compumart Station J. Ottawa, Ontario</p> <p>Computer Mart, Ltd. 1055 Yonge St. Suite 208 Toronto</p> <p>Micro Shack of W. Canada 333 Park Street, Regina, Sask.</p> <p>Orthon Holdings Ltd. 12411 Stony Plain Road Edmonton, Alberta</p> <p>Total Computer Systems Ajax, Ontario</p> <p>West Germany</p> <p>Reinhard Nedela Markstr. 3, 7778 Markdorf</p>
--	---	--	---	---	--

Make a great buy even better . . .

Why pay full price? Take this coupon to the store nearest you and get \$1.00 off on any of our software. If the store nearest you doesn't stock Instant Software, don't call the manager names—there's still hope. Just tell him which programs you want, and he'll order the software for you. If you're so wealthy that saving a buck means nothing to you—not to mention the added dollar handling charge—then use the order blank at right to order your software direct, or call Toll-Free 1-800-258-5473.

INSTANT SOFTWARE

\$1

Discount Coupon

This coupon good for one dollar off any Instant Software program when purchased through your local computer store.

Limit one coupon per package. Offer void where prohibited by law.

ATTENTION DEALER: Include coupons with your next order. Credit will be applied toward purchase. If you are not as yet selling Instant Software, write: **Instant Software, Dealer Sales, Peterborough NH** for catalog and dealer net price schedule, or call our marketing department at 1-603-924-7296 for more information.

Expires 12-31-79.

Name _____

Address _____

City _____

State _____ Zip _____

Check Money order

VISA AMEX Master Charge

Card No. _____

Expiration Date _____

Signed _____ Date _____

Order your Instant Software today!

Quantity	Order No.	Unit Cost	Total Cost
Handling			\$1.00
Total Order			

Instant Software Inc. Dept. 73-915
Peterborough, N.H. 03458 USA

DSI HAS DONE IT AGAIN

QUIK-KIT II®

INCLUDES PROPORTIONAL OVEN TIME BASE

- DC-BATT-AC (W-AC9)
- 95% Factory Assembled
- 100% Factory Tested
- .2 PPM 10° to 40° C Accuracy
- 9 Digits .5 Inch LED's
- 0.1 HZ Resolution
- Auto Zero Blanking

\$149⁹⁵
MODEL 5600A KIT



WHY BUY A 5600A: Because 95% of the assembly is completed by DSI and you are only one hour away from solving all those difficult bench problems, from setting the frequency of a audio signal to within 1/10 of a HZ, to checking the frequency of a 486 MHz mobile radio. Whether you are servicing a VTR, trouble shooting a PLL circuit, the 5600A is the right counter with accuracy that will meet any FCC land mobile, broadcast, or telecommunications requirements. On the bench or in the field the 5600A will do the job you need. The 5600A includes a self contained battery holder providing instant portability or we offer a 10 hour rechargeable battery pack option. Other options include a audio multiplier which allows you to resolve a 1/1000 of a HZ signal and finally a 25db preamplifier with an adjustable attenuator making the 5600A perfect for communications, TV servicing, industrial testing or meeting your QSO on the correct frequency every time.

FACTS ARE FACTS: With the introduction of the 5600A, The sun has set on the competition. This may sound like a bold statement on the part of DSI BUT FACTS ARE FACTS. No counter manufacturer except DSI offers a Full Range 50 HZ to 600 MHZ counter with — 9 Digits — 0.1 HZ resolution — .2 PPM 10° to 40° C proportional oven — RF pre-amp — 600 MHZ prescaler — three selectable gate times — oven ready, standby and gate time indicator lights as standard features — For only \$149.95 kit and \$179.95 factory wired. In fact the competition doesn't even come close unless you consider \$200.00 to \$800.00 close. With DSI having the best price to quality features ratio in the industry, no wonder we've become one of the world's largest manufacturers of high quality frequency counter instrumentation.

FOR INFORMATION — DEALER LOCATION — ORDERS — OEM
CALL 800-854-2049 CALIFORNIA RESIDENTS CALL 800-542-6253

Model	Price	Frequency Range	Accuracy Over Temperature	Sensitivity			Number of Readouts	Size of Readouts	Power Requirements	Size		
				@ 100Hz-25MHz	@ 50-250MHz	@ 250-450MHz				H	W	D
5600A-K	\$149.95	50Hz-600MHz	Proportional Oven .2 PPM 10° - 40° C	10MV	10MV	50MV	9	.5 Inch	*115 VAC or 8.2-14.5 VDC	3 1/4" x 9 1/2" x 9"		
5600A-W	\$179.95											
3550	99.95	50Hz-550MHz	TCXO 1 PPM 17° - 40° C	25MV	25MV	75MV	8	.5 Inch	*115 VAC or 8.2-14.5 VDC	2 1/4" x 8" x 5"		
500HH	\$149.95	50Hz-550MHz	TCXO 1 PPM 17° - 40° C	25MV	20MV	75MV	8	.4 Inch	*115 VAC or 8.2-14.5 VDC or NICAD PAK.	1" x 3 1/2" x 5 1/4"		

5600A wired factory burned in 1 year limited warranty, 5600A kit 90 day limited warranty. Prices and/or specifications subject to change without notice or obligation.

*With AC-9 Adaptor



3550 OWNERS
You can add the
35P.2 .22 PPM
10° to 40° C
proportional oven
to your
existing 3550



DSI INSTRUMENTS, INC.
7924 Ronson Road
San Diego, California 92111

TERMS: MC - VISA - AE - Check - M.O. - COD in U.S. Funds. Please add 10% to a maximum of \$10.00 for shipping, handling and insurance. Orders outside of USA & Canada, please add \$20.00 addition to cover air shipment. California residents add 6% Sales Tax.

5600A Kit \$149.95
5600A Wired 179.95
AC-9 AC Adaptor 7.95
T600 BNC Ant. 7.95

BUILT-IN OPTIONS

BA56 Rechargeable
10 Hr. Bat. Pack 24.95
AM56 Audio Multiplier
.001Hz Resolution 34.95
PA56 25dB Preamplifier
with Attenuator 59.95

T101 Ant. \$3.95
AC-9 AC Adaptor 7.95
35P.2 29.95
Factory Installed 49.95

NEW FROM DSI!

50 Hz — 500 MHz 8 DIGITS

1 Meg INPUT — 1 Hz RESOLUTION — 1 PPM TCXO

- AC—DC Operation
- BNC Inputs 1 Meg Direct 50 Ohms Prescaled
- 8 Large .4" LED Readouts
- Auto Decimal Point & Zero Blanking
- 1 Year Limited Warranty Parts & Labor
- 100% Factory Assembled in U.S.A.

\$149⁹⁵

MODEL 500 HH
50 Hz — 500 MHz
Without Battery Capability

MODEL 100 HH
50 Hz — 100 MHz

\$99⁹⁵

Without Battery Capability

SAVE \$5⁰⁰

With Battery Capability

MODEL 500 HH .. \$169.95

MODEL 100 HH .. \$119.95

Includes AC-9 Battery Eliminator

The 100 HH and 500 HH hand held frequency counters represent a significant new advancement, utilizing the latest LSI design . . . and because it's a DSI innovation, you know it obsoletes any competitive makes, both in price and performance. No longer do you have to sacrifice accuracy, ultra small readouts and poor resolution to get a calculator size instrument. Both the 100 HH and 500 HH have eight .4 inch LED digits — 1 Hz resolution — direct in only 1 sec. or 10 Hz in .1 sec. — 1 PPM TCXO time base. These counters are perfect for all applications be it mobile, hilltop, marine or bench work. **CALL TODAY TOLL FREE: (800—854-2049) Cal. Res. CALL (800—542-6253) TO ORDER OR RECEIVE MORE INFORMATION ON DSI'S FULL PRODUCT LINE OF FREQUENCY COUNTERS RANGING FROM 10 Hz TO 1.3 GHz.**

FREQUENCY COUNTER CONSUMER DATA COMPARISON CHART

MANUFACTURER	MODEL	SUG. STD. LIST PRICE	FREQUENCY RANGE	TYPE OF TIME BASE	ACCURACY OVER TEMPERATURE		SENSITIVITY			DIGITS		PRE-SCALE INPUT RESOLUTION	
					17° - 40°C	0° - 40°C	100 Hz - 25 MHz	50 MHz - 250 MHz	250 MHz - 450 MHz	No.	SIZE IN INCHES	.1 SEC	1 SEC
DSI INSTRUMENTS	100 HH	\$ 99.95	50Hz-100MHz	TCXO	1 PPM	2 PPM	25 MV	NA	NA	8	.4	100 Hz	10 Hz
DSI INSTRUMENTS	500 HH	\$149.95	50Hz-550MHz	TCXO	1 PPM	2 PPM	25 MV	20 MV	30 MV	8	.4	100 Hz	10 Hz
CSC‡	MAX-550	\$149.95	1kHz-550MHz	Non-Compensated	3 PPM @ 25°C	8 PPM	500 MV*	250 MV	250 MV	6	.1	NA	1 kHz
OPTOELECTRONICS	OPT-7000	\$139.95	10Hz-600MHz	TCXO	1.8 PPM	3.2 PPM	NS	NS	NS	7	.4	1 kHz	100 Hz

* 1 KHz - 50 MHz ‡ Continental Specialties Corp.

The specifications and prices included in the above chart are as published in manufacturer's literature and advertisements appearing in early 1979. DSI INSTRUMENTS only assumes responsibility for their own specifications.

100 HH...\$ 99.95 W/Battery Pack...\$119.95
500 HH...\$149.95 W/Battery Pack...\$169.95

Prices and/or specifications subject to change without notice or obligation.

These prices include factory installed rechargeable NiCad battery packs.



DSI INSTRUMENTS, INC.
7924 Ronson Road, Dept. G
San Diego, California 92111

T-500 Ant. \$ 7.95
AC-9 Battery Eliminator \$ 7.95

TERMS: MC - VISA - AE - Check - M.O. - COD in U.S. Funds. Please add 10% to a maximum of \$10.00 for shipping, handling and insurance. Orders outside of USA & Canada, please add \$20.00 addition to cover air shipment. California residents add 6% Sales Tax.

CALL TOLL FREE

1-800-228-4097
Communications Center

443 N 48th Street
 Lincoln, Nebraska 68504
 In Nebraska Call (402)466-8402

✓ C58

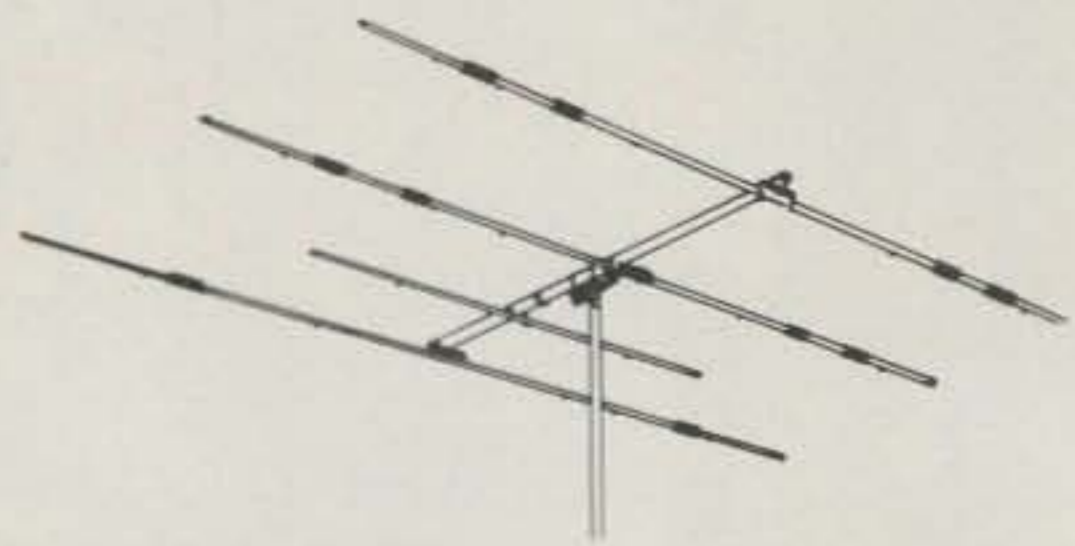

Antenna Sale!

HY-GAIN

		Regular	Special			Regular	Special
TH6DXX	Super Thunderbird	\$299.95	\$239.95	18HT	Hy-Tower 80-10M vertical	299.95	239.95
TH3MK3	3 el. 10-15-20M beam	229.95	179.95	18AVT/WB	80-10M Trap vertical	99.95	79.95
TH3JR	3 el. 10-15-20M beam	149.95	129.95	14AVQ/WB	40-10M Trap vertical	69.95	57.00
Hy-Quad	2 el. 10-15-20M Quad	229.95	179.95	12AVQ	20-10M Trap Vertical	39.95	32.95
205BA	5 el. "Long John" 20M beam	289.95	229.95	14RMQ	Roof Mounting kit (verticals)	33.95	29.95
155BA	5 el. "Long John" 15M beam	169.95	139.95	5BDQ	80-10M Trap doublet	89.95	69.95
105BA	5 el. "Long John" 10M beam	119.95	99.95	2BDQ	80-40M Trap doublet	49.95	39.95
204BA	4 el. 20M beam	219.95	179.95	66B	6 el. 6M beam	119.95	99.95
204MK5	5 el. conversion kit	99.95	79.95	203	3 el. 2M beam	15.95	
153BA	3 el. 15M beam	79.95	69.95	205	5 el. 2M beam	17.95	
103BA	3 el. 10M beam	54.95	44.95	208	8 el. 2M beam	25.95	
402BA	2 el. 40M beam	209.95	169.95	214	14 el. 2M beam	31.95	
BN-86	Balun for beam antennas	15.95	15.95	LA-1	Deluxe lightning arrestor	59.95	49.95
TH2MK3	2 el. 10-15-20M beam	149.95	119.95				

MOSLEY

		Regular	Special
Classic 33	3 el. 10, 15, 20 Mtr. beam	304.75	209.95
Classic 36	6 el. 10, 15, 20 Mtr. beam	392.75	269.95
TA-33	3 el. 10, 15, 20 Mtr. beam	264.00	189.95
TA-36	6 el. 10, 15, 20 Mtr. beam	392.75	269.95
TA-33 Jr.	3 el. 10, 15, 20 Mtr. beam	197.00	149.95
TA-40KR	40 Mtr. Add On	119.95	89.95

CUSHCRAFT

ATB-34	4 ele. 10, 15, 20 Mtr. beam	289.95	219.95	A147-11	11 ele. 146-148 Mhz. beam	36.95	30.95
ATV-4	10, 15, 20, 40 Mtr. Vertical	89.95	69.95	A147-22	22 ele. Power Pack	109.95	89.95
ATV-5	10, 15, 20, 40, 80 Mtr. Vertical	109.95	89.95	A144-10T	2 Mtr. "Twist" 10 ele.	42.95	34.95
ARX-2	2 Mtr. Ringo Ranger	39.95	32.95	A144-20T	2 Mtr. "Twist" 20 ele.	62.95	52.95
AR-6	6 Mtr. Ringo	36.95	32.95	A147-20T	2 Mtr. beam	62.95	52.95
ARX-220	220 Mhz. Ringo Ranger	39.95	32.95	A430-11	432 Mhz. 11 ele. beam	34.95	29.95
ARX-450	435 Mhz. Ringo Ranger	39.95	32.95	A432-20T	430-436 Mhz. Beam	59.95	49.95
A144-11	11 ele. 144-146 Mhz. beam	36.95	30.95				

HUSTLER

3-TBA	3 ele; 10, 15, 20 Mtr. beam	259.95	189.95
4-BTV	10-40 Mtr. Vertical	99.95	79.95
5-BTV	10-80 Mtr. Vertical	134.95	99.95
RM-75	75 Meter Resonator	16.95	14.50
RM-75S	75 Meter Super Resonator	31.95	27.50
G6-144B	2 Mtr. Base Colinear	79.95	59.95
G7-144	2 Mtr. Base Colinear	119.95	89.95

WILSON

System One	5 ele. 10, 15, 20, Mtr. Beam	\$299.95	\$239.95
System Two	4 ele. 10, 15, 20 Mtr. Beam	249.95	199.95
System Three	3 ele. 10, 15, 20 Mtr. Beam	199.95	159.95
WV-1	10-40 Mtr. Vertical	79.95	69.95

TAYLOR

HQ 1040AV	10-40 Mtr. Trap vertical	59.95	49.95
-----------	--------------------------	-------	-------

ROTORS

HamIII \$125.00 T2X Tailtwister \$199.95 Alliance HD 73 \$109.95

Call for prices on rotor cable, Coax, Towers, and Accessories. All prices do not include shipping.

We carry all major brands of ham radios AT DISCOUNT PRICES

Yaesu — Kenwood — Drake — ICOM — Dentron —
 Ten-Tec — Swan — Tempo — Midland — E.T.O. — Wilson



ATTENTION:

TO: All Amateurs
FROM: Wilson Systems, Inc.

Inflation . . . gas shortages . . . etc., all leading to higher prices each week, and cutting into the amount that we have to spend on our hobby. And face it, our hobby is what keeps us sane in this runaway inflation period, our escape from the hustle and hectic grind of working to make a living. We know — we see the same price increases at the grocery store, the same increases in the gas prices. Wilson Systems, Inc., is going to do something to help ease the purchase of your new tower and antenna.

As you may know, in January of 1979, Regency Electronics, Inc., purchased Wilson Electronics Corp. What you may not know is that in August, 1979, Jim Wilson purchased back the antennas and towers. There is now a new name to look for — WILSON SYSTEMS, INC. — With the new name and new company comes new ideas, methods, products and prices. Yes, prices. But not what you might expect. Wilson Systems is LOWERING the prices to where you will find it hard to believe. Check them out in the following pages of this issue. You will be surprised and pleased at what you will find.

What are we doing that will enable us to lower the prices? Well, we are Hams, too. We like to pay the lowest price possible and will spend much time assuring ourselves this is accomplished. We feel the same higher demands on our money for the house, food, and bills. And as this demand increases, the amount of money left for our hobby decreases. So when money is spent, we want the best quality for the best price.

There are a number of ways to bring the cost of a product down. By using a cheaper grade of material, buying raw materials in larger quantities to obtain a better discount, by cutting the profit ratio, and by eliminating the middle man. Wilson Systems will not lower the quality of the product. In fact, we have improved the strength and quality of almost every antenna in the line. The newly designed monobanders will stay up under heavy icing conditions when others are falling apart. Wilson Systems is currently purchasing at the lowest price possible from the aluminum companies, so these methods of cost reduction are eliminated. The third method mentioned is one that we have decided to consider as a part of the overall cost reduction plan, yet leaving room for research and development expense, so we may bring you the products you want and at a price you will like.

The last method mentioned is always a risky one. The dealers do not want their profits cut back just as you do not want your pay check cut. If you cut the dealers' profits back, some of them will just push the product that will tend to give them the most profit, rather than the one that will be the best performing for you. A rather drastic form of this method is the one that Wilson Systems will be choosing. You will not be able to find the Amateur products of Wilson Systems in stock at the dealers, nor will they probably recommend them. (After all, as long as they're not handling them and making a profit, why should they promote or even recommend them?) No, you will only be able to enjoy the most product for the least money by dealing with Wilson Systems factory direct. We will be offering you the amateur antennas and towers at prices that are below, in most cases, what the dealers pay for the products of other companies. And to make it even easier, we have a toll-free number for you to place your order. Now isn't this what you've been looking for? The best product for the least money!

Just remember these four points:

1. Highest Quality
2. Lowest Price
3. Toll-Free Order Number

The fourth point? Remember the name . . . WILSON SYSTEMS, INC.

Yours Truly,
Jim Wilson
Wilson Systems, Inc.

**W S I WILSON
SYSTEMS, INC.**
4286 S. Polaris Ave., Las Vegas, Nevada 89103
(702) 739-7401 — Toll-Free Order Number 800-634-6898

WILSON SYSTEMS INC. MULTI-BAND ANTENNAS

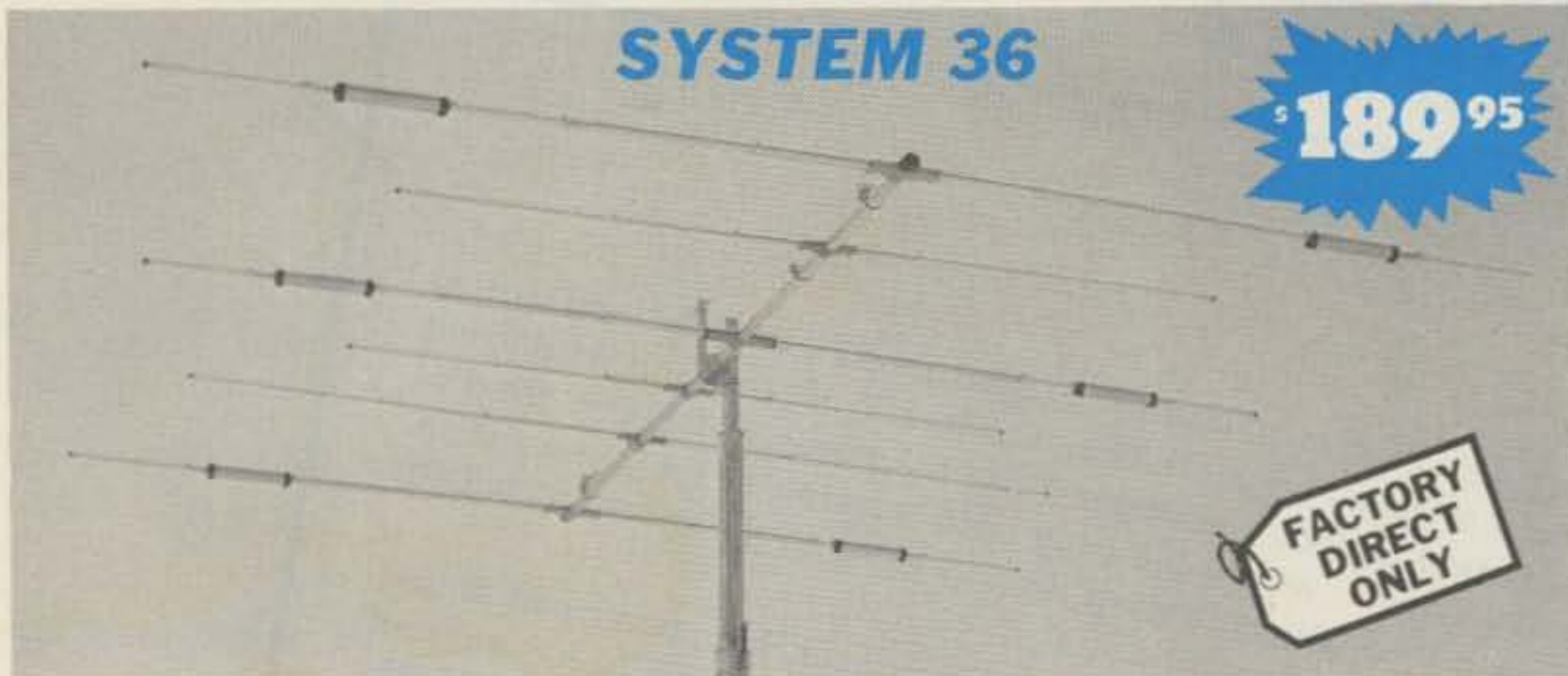

A trap loaded antenna that performs like a monobander! That's the characteristic of this six element three band beam. Through the use of wide spacing and interlacing of elements, the following is possible: three active elements on 20, three active elements on 15, and four active elements on 10 meters. No need to run separate coax feed lines for each band, as the

bandswitching is automatically made via the High-Q Wilson traps. Designed to handle the maximum legal power, the traps are capped at each end to provide a weather-proof seal against rain and dust. The special High-Q traps are the strongest available in the industry today.

SPECIFICATIONS

Band MHz	14-21-28	Boom (O.D. x Length)	2" x 24'2 1/2"	Wind loading @ 80 mph	215 lbs.
Maximum power input	Legal limit	No. of elements	6	Maximum wind survival	100 mph
Gain (dBd)	Up to 9 dB	Longest element	28'2 1/2"	Feed method	Coaxial Balun (supplied)
VSWR @ resonance	1.3:1	Turning radius	18'6"	Assembled weight (approx.)	53 lbs.
Impedance	50 Ω	Maximum mast diameter	2"	Shipping weight (approx.)	62 lbs.
F/B ratio	20 dB or better	Surface area	8.6 sq. ft.		

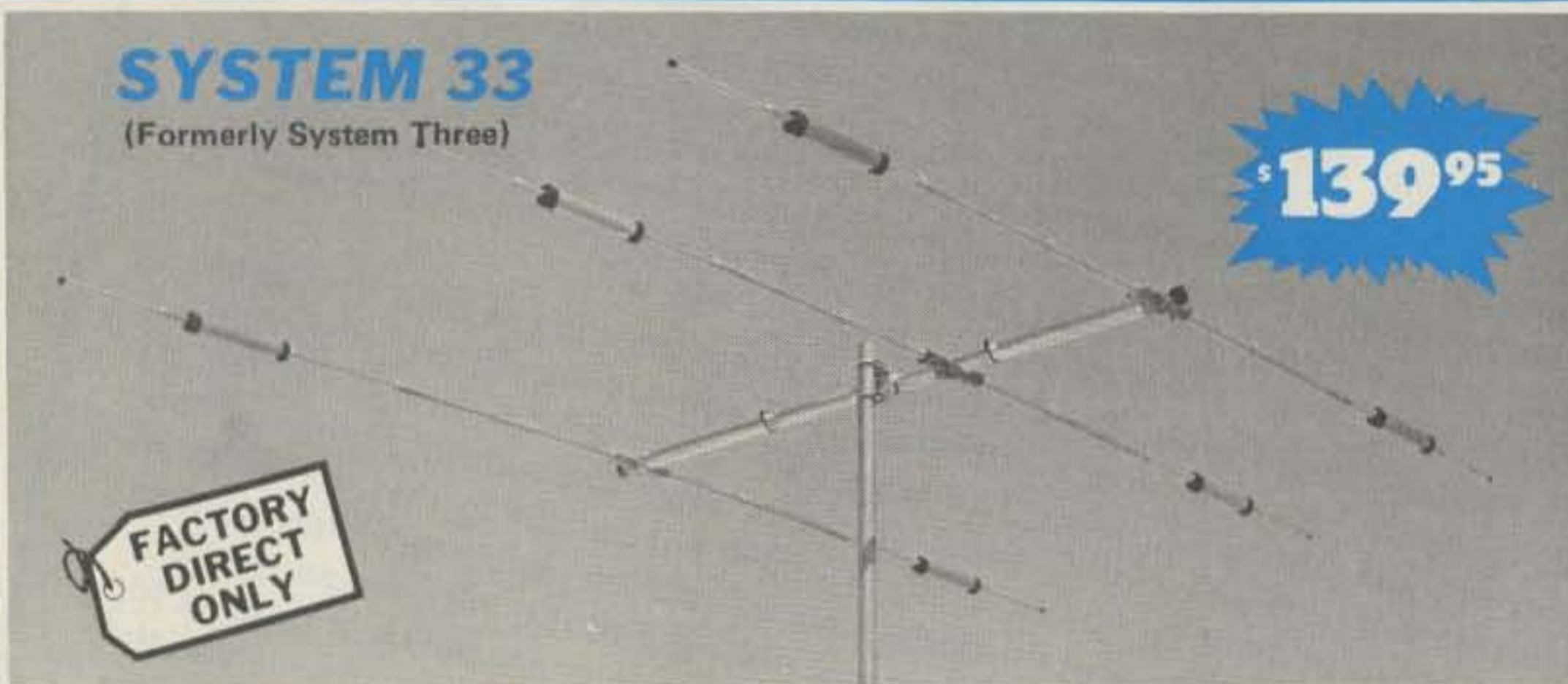

Capable of handling the Legal Limit, the "SYSTEM 33" is the finest compact tri-bander available to the amateur.

Designed and produced by one of the world's largest antenna manufacturers, the traditional quality of workmanship and materials excels with the "SYSTEM 33".

New boom-to-element mount consists of two 1/8" thick formed aluminum plates that will provide more clamping and holding strength to prevent element misalignment.

Superior clamping power is obtained with the use of a rugged 1/4" thick aluminum plate for boom to mast mounting.

The use of large diameter High-Q Traps in the "SYSTEM 33" makes it a high performing tri-bander and at a very economical price.

A complete step-by-step illustrated instruction manual guides you to easy assembly and the lightweight antenna makes installation of the "SYSTEM 33" quick and simple.

SPECIFICATIONS

Band MHz	14-21-28	Boom (O.D. x length)	2" x 14'4"	Wind loading at 80 mph	114 lbs.
Maximum power input	Legal limit	No. elements	3	Assembled weight (approx.)	37 lbs.
Gain (dbd)	Up to 8 dB	Longest element	27'4"	Shipping weight (approx.)	42 lbs.
VSWR at resonance	1.3:1	Turning radius	15'9"	Direct 52 ohm feed—no balun required	
Impedance	50 ohms	Maximum mast diameter	2" O.D.	maximum wind survival	100 mph
F/B ratio	20 dB or better	Surface area	5.7 sq. ft.		

\$44.95
WV-1A

4 BAND TRAP VERTICAL (10 - 40 METERS)

No bandswitching necessary with this vertical. An excellent low cost DX antenna with an electrical quarter wavelength on each band and low angle radiation. Advanced design provides low SWR and exceptionally flat response across the full width of each band.

Featured is the Wilson large diameter High-Q traps which will maintain resonant points with varying temperatures and humidity.

Easily assembled, the WV-1A is supplied with a hot dipped galvanized base mount bracket to attach to vent pipe or to a mast driven in the ground.

Note:

Radials are required for peak operation. (See GR-1 below).

SPECIFICATIONS:

- Self supporting—no guys required.
- Input Impedance: 50 Ω
- Powerhandling capability: Legal Limit
- Two High-Q Traps with large diameter coils
- Low Angle Radiation
- Omnidirectional performance
- Taper Swaged Aluminum Tubing
- Automatic Bandswitching
- Mast Bracket furnished
- SWR: 1.1:1 or less on all Bands

GR-1

\$9.95

The GR-1 is the complete ground radial kit for the WV-1A. It consists of: 150' of 7/14 stranded copper wire and heavy duty egg insulators, instructions. The GR-1 will increase the efficiency of the GR-1 by providing the correct counterpoise.

W S I WILSON SYSTEMS, INC.

4286 S. Polaris Avenue
Las Vegas, Nevada 89103
(702) 739-7401

Factory Direct Toll Free 1-800-634-6898

Prices and specifications subject to change without notice.

New, Improved Wilson Towers



Hinged Base Plate - Concrete Pad, Heavy Duty Winch



Mounting the House Bracket



The Hinged Base Plate allows tower to be tilted over for access to antenna and rotor from the ground.

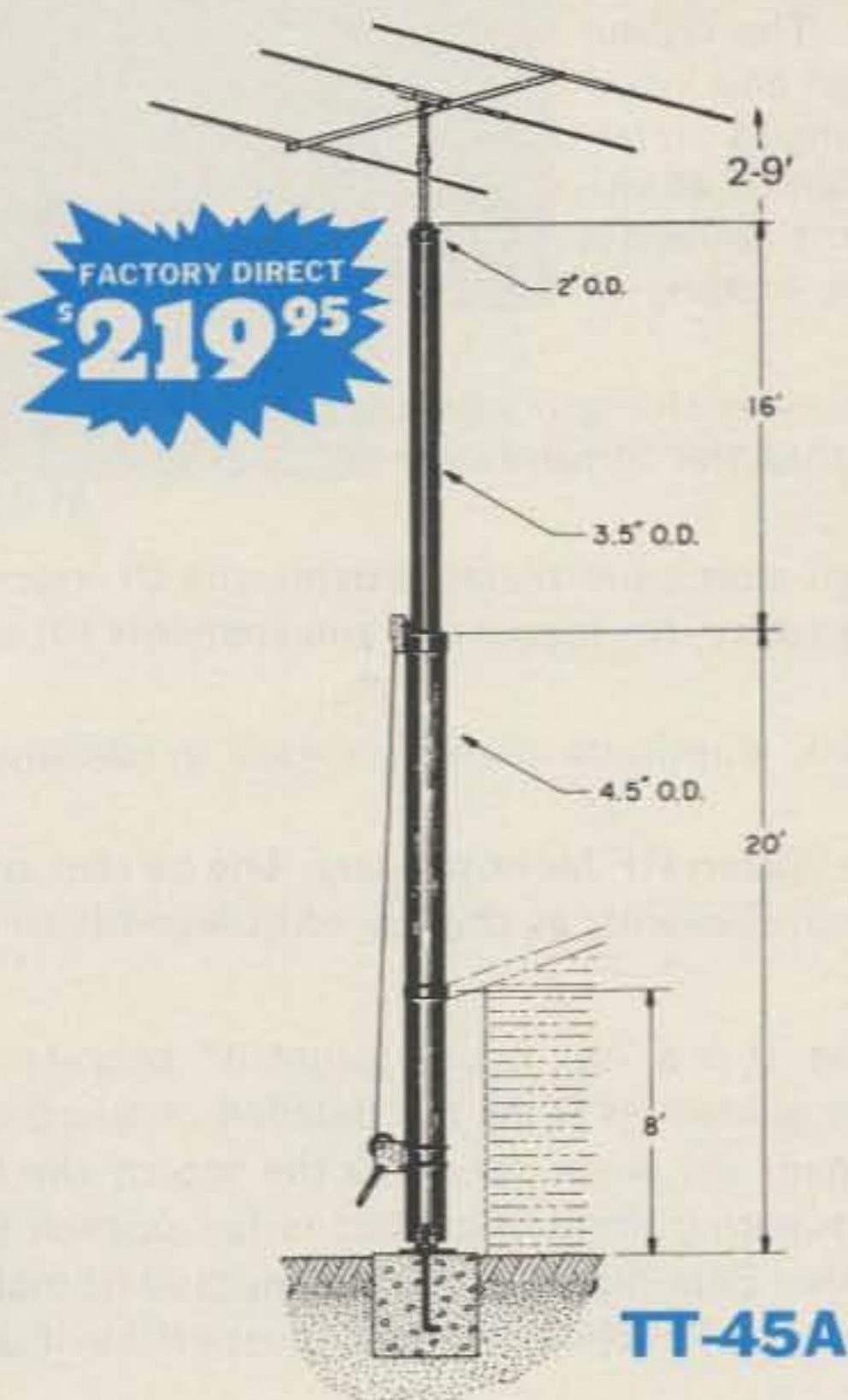

FEATURES:

- Maximum Height 45' (will handle 10 sq. ft. at 38') @ 50 mph
- 800 lb. winch
- Totally freestanding with proper base
- Total Weight, 189 lbs.

The TT-45A is a freestanding tower, ideal for installations where guys cannot be used. If the tower is not being supported against the house, the proper base fixture accessory must be selected.

GENERAL FEATURES

All towers use high strength heavy galvanized steel tubing that conforms to ASTM specifications for years of maintenance-free service. The large diameters provide unexcelled strength. All welding is performed with state-of-the-art equipment. Top sections are 2" O.D. for proper antenna/rotor mounting. A 10' push-up mast is included in the top section of each tower. Hinge-over base plates are standard with each tower. The high loads of today's antennas make Wilson crank-ups a logical choice.

FACTORY DIRECT
\$399.95

NEW IMPROVED FEATURE

Heavier wall tubing greatly increases the stress capabilities over the older TT-45 and MT-61.

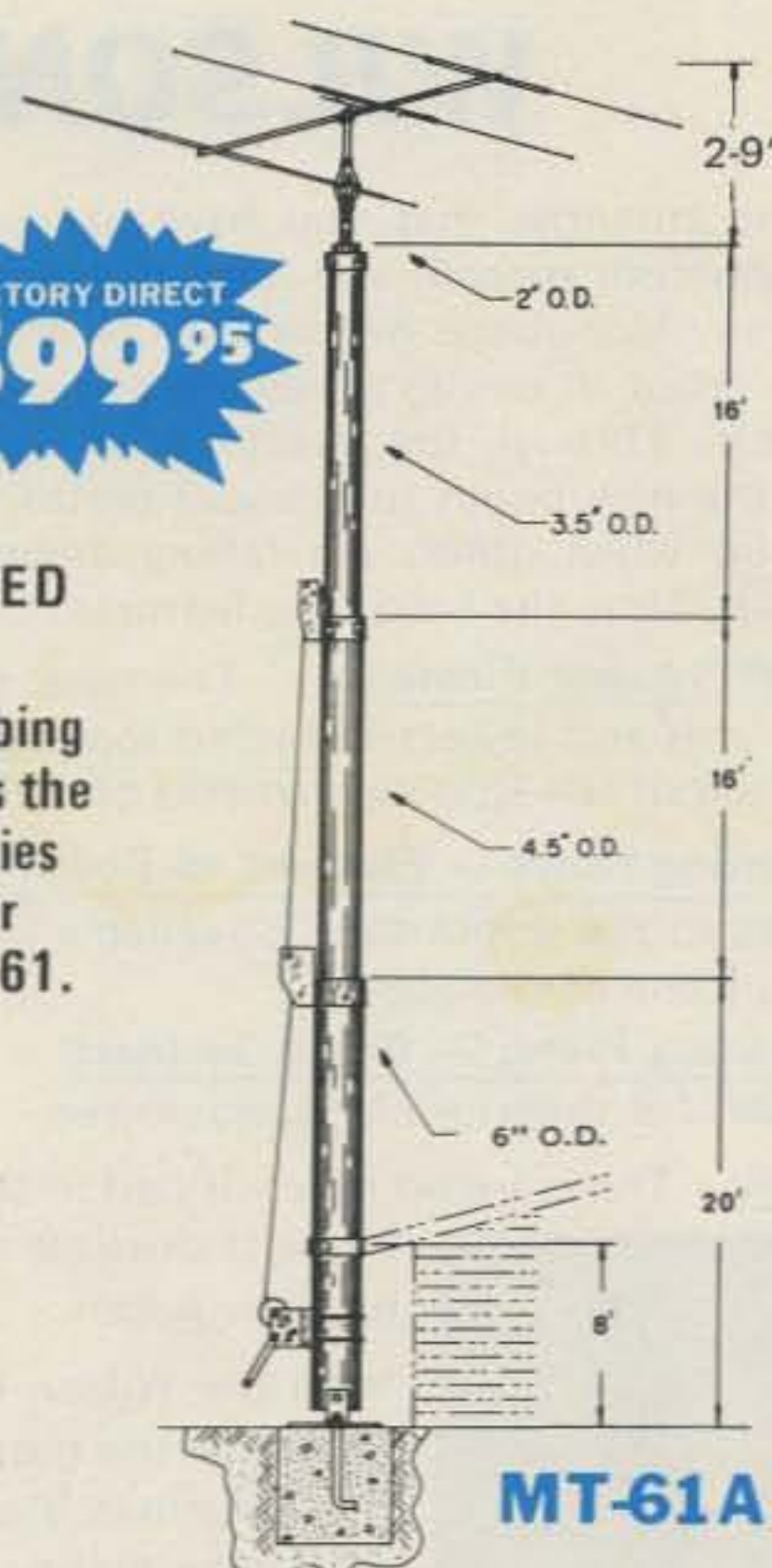

FEATURES:

- Is freestanding with use of proper base
 - Maximum Height is 61' (will handle 10 sq. ft. at 53') @ 50 mph
 - 1200 lb. brake winch
 - 4200 lb. raising cable
 - Total Weight, 350 lbs.
- Recommended base accessory: RB-61A, FB-61A.

The MT-61A is our largest and tallest freestanding tower. By using the RB-61A rotating base fixture the MT-61A is ideally suited for the SY33 or SY-36. If you plan to mount the tower to your house, caution should be taken to make certain the eave is properly reinforced to handle the tower. If not, one of the base accessory fixtures should be used.

TILT-OVER BASES FOR TOWERS

FIXED BASE

The FB Series was designed to provide an economical method of moving the tower away from the house. It will support the tower in a completely free-standing vertical position, while also having the capabilities of tilting the tower over to provide an easy access to the antenna. The rotor mounts at the top of the tower in the conventional manner, and will not rotate the complete tower.



FB-45A ... \$ 79.95
FB-61A ... 109.95

ROTATING BASE

The RB Series was designed for the Amateur who wants the added convenience of being able to work on the rotor from the ground position. This series of bases will give that ease plus rotate the complete tower and antenna system by the use of a heavy duty thrust bearing at the base of the tower mounting position, while still being able to tilt the tower over when desiring to make changes on the antenna system.

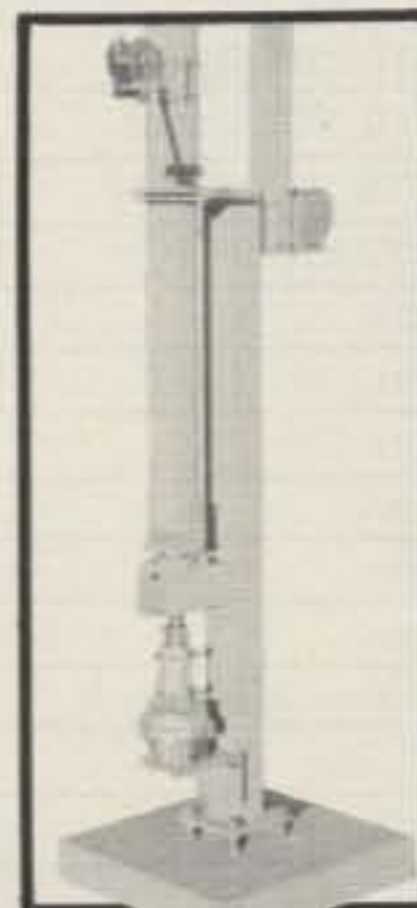

RB-45A ... \$119.95
RB-61A ... 179.95



Tilting the tower over is a one-man task with the Wilson bases.

(Shown above is the RB-61A.)

W S I WILSON SYSTEMS, INC.

4286 S. Polaris Avenue
Las Vegas, Nevada 89103
(702) 739-7401

Factory Direct Toll Free 1-800-634-6898

Prices and specifications subject to change without notice.

WILSON MONO-BAND BEAMS

At last, the antennas that you have been waiting for are here! The top quality, optimum spaced, and newest designed monobanders. The Wilson Systems' new Monoband beams are the latest in modern design and incorporate the latest in design principles utilizing some of the strongest materials available. Through the select use of the current production of aluminum and the new boom to element plates, the Wilson Systems' antennas will stay up when others are falling down due to heavy ice loading or strong winds. Note the following features:

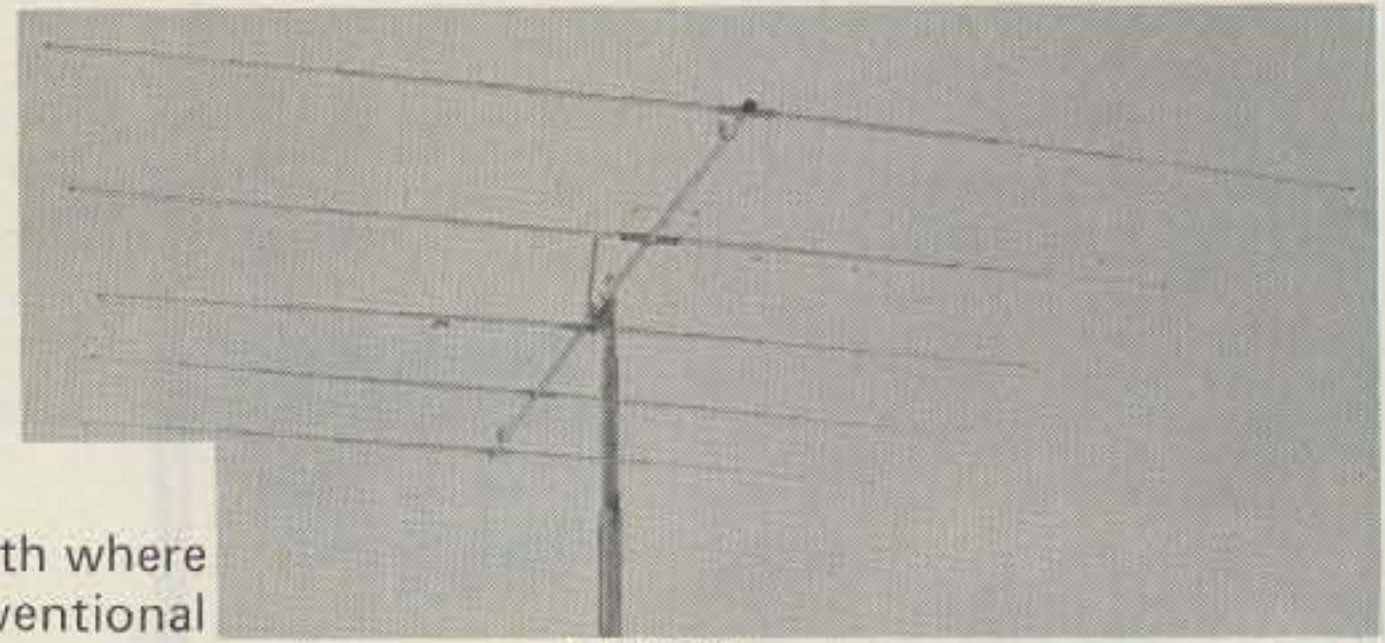

M-520A

- Taper Swaged Elements** — The taper swaged elements provide strength where it counts and lowers the wind loading more efficiently than the conventional method of telescoping elements of different sizes.
- Mounting Plates — Element to Boom** — The new formed aluminum plates provide the strongest method of mounting the elements to the boom that is available in the entire market today. No longer will the elements tilt out of line if a bird should land on one end of the element.
- Mounting Plates — Boom to Mast** — Rugged 1/4" thick aluminum plates are used in combination with sturdy U-bolts and saddles for superior clamping power.
- Holes** — There are no holes drilled in the elements of the Wilson HF Monobanders. The careful attention given to the design has made it possible to eliminate this requirement, as the use of holes adds an unnecessary weak point to the antenna boom.

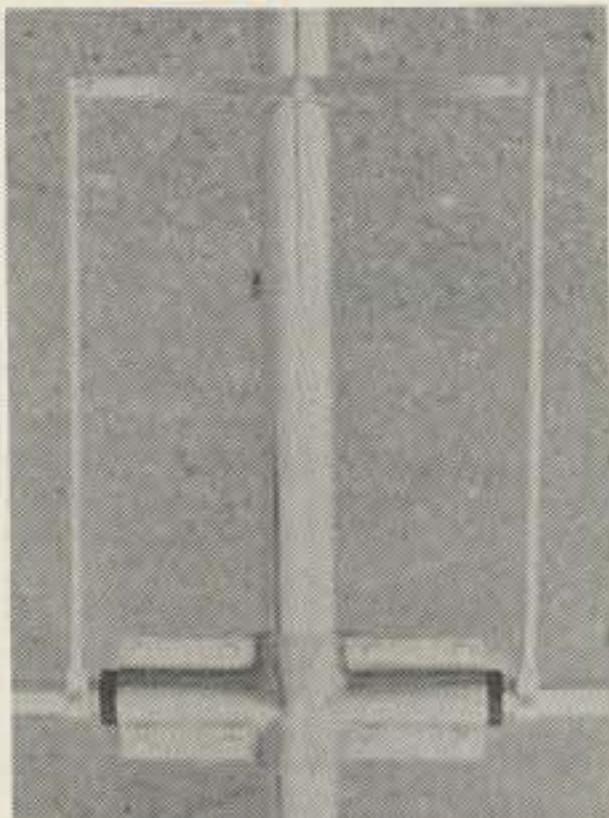

Wilson's Beta match offers maximum power transfer.

With the Wilson Beta-match method, it is a "set it and forget it" process. You can now assemble the antenna on the ground, and using the guidelines from the detailed instruction manual, adjust the tuning of the Beta-match so that it will remain set when raised to the top of the tower. The Wilson Beta-match offers the ability to adjust the terminating impedance that is far superior to the other matching methods including the Gamma match and other Beta-matches. As this method of matching requires a balanced line, it will be necessary to use a 1:1 balun, or RF choke, for the most efficient use of the HF Monobanders.

The Wilson Monobanders are the perfect answer to the Ham who wants to stack antennas for maximum utilization of space and gain. They offer the most economical method to have more antenna for less money with better gain and maximum strength. Order yours today and see why the serious DXers are running up that impressive score in contests and number of countries worked.

SPECIFICATIONS

Model	Band Mtrs	Gain dBd	F/B Ratio	Bandwidth @ Resonance 2:1 VSWR Limits	VSWR @ Resonance	Impedance	Matching	Elements	Longest Element	Boom O.D.	Boom Length	Turning Radius	Surface Area (Sq.Ft.)	Windload @ 80 mph (Lbs.)	Maximum Mast	Assembled Weight (Lbs.)
M520A	20	11.5	25 dB	500 KHz	1.1:1	50 Ω	Beta	5	36'6"	2"	34'2½"	25'1"	8.9	227	2"	68
M420A	20	10.0	25 dB	500 KHz	1.1:1	50 Ω	Beta	4	36'6"	2"	26'0"	22'6"	7.6	189	2"	50
M515A	15	12.0	25 dB	400 KHz	1.1:1	50 Ω	Beta	5	25'3"	2"	26'0"	17'6"	4.2	107	2"	41
M415A	15	10.0	25 dB	400 KHz	1.1:1	50 Ω	Beta	4	24'2½"	2"	17'0"	14'11"	2.1	54	2"	25
M510A	10	12.0	25 dB	1.5 MHz	1.1:1	50 Ω	Beta	5	18'6"	2"	26'0"	16'0"	2.8	72	2"	36
M410A	10	10.0	25 dB	1.5 MHz	1.1:1	50 Ω	Beta	4	18'3"	2"	12'11"	11'3"	1.4	36	2"	20

WILSON SYSTEMS, INC. — 4286 S. Polaris
Las Vegas, NV 89103 — (702) 739-7401

**FACTORY DIRECT
ORDER BLANK**

Toll-Free Order Number
1-800-639-6898

WILSON SYSTEMS ANTENNAS

WILSON SYSTEMS TOWERS

Qty.	Model	Description	Shipping	Price	Qty.	Model	Description	Shipping	Price
	SY33	3 Ele. Tribander for 10, 15, 20 Mtrs.	UPS	\$139.95		TT-45A	Freestanding 45' Tubular Tower	TRUCK	\$199.95
	SY36	6 Ele. Tribander for 10, 15, 20 Mtrs.	UPS	189.95		RB-45A	Rotating Base for TT-45A w/tilt over feature	TRUCK	119.95
	WV-1A	Trap Vertical for 10, 15, 20, 40 Mtrs.	UPS	44.95		FB-45A	Fixed Base for TT-45A w/tilt over feature	TRUCK	79.95
	GR-1	Ground Radials for WV-1A	UPS	9.95		MT-61A	Freestanding 61' Tubular Tower	TRUCK	399.95
	M-520A	5 Elements on 20 Mtrs.	TRUCK	199.95		RB-61A	Rotating Base for MT-61A w/tilt over feature	TRUCK	179.95
	M-420A	4 Elements on 20 Mtrs.	UPS	139.95		FB-61A	Fixed Base for MT-61A w/tilt over feature	TRUCK	109.95
	M-515A	5 Elements on 15 Mtrs.	UPS	119.95		STB-50	Thrust Bearing	UPS	18.95
	M-415A	4 Elements on 15 Mtrs.	UPS	79.95	Nevada Residents Add Sales Tax				
	M-510A	5 Elements on 10 Mtrs.	UPS	84.95	Ship C.O.D. <input type="checkbox"/> Check enclosed <input type="checkbox"/> Charge to Visa <input type="checkbox"/> M/C <input type="checkbox"/>				
	M-410A	4 Elements on 10 Mtrs.	UPS	64.95	Card # _____	Expires _____			
	WM-62A	Mobile Antenna: 5/8 λ on 2, ¼ λ on 6	UPS	19.95	Bank # _____	Signature _____			
	ACCESSORIES				<i>Please Print</i>				
	HD-73	Alliance Heavy Duty Rotor	UPS	109.95	Name _____	Phone _____			
	RC-8C	8/C Rotor Cable	UPS	.12/ft.	Street _____				
	RG-8U	RG-8U Foam-Ultra Flexible Coaxial Cable. 38 strand center conductor, 11 gauge	UPS	.21/ft.	City _____	State _____	Zip _____		

Note: On Coaxial and Rotor Cable, minimum order is 100 ft. and in 50' multiples.
Prices and specifications subject to change without notice.
Ninety Day Limited Warranty. All Products FOB Las Vegas, Nevada.

COMPUTER SPECIALS

16K Compucolor II with your choice of either (1) \$19.95 program diskette or the Compucolor programming manual! (Also includes the SAMPLER diskette free from the manufacturer.)—retail value \$1719.90—all for \$1650.00!

16K or 32K PET graphics or business models—purchase the computers and get cassette drive FREE!

16K PET (or CBM)—\$ 995.00
32K PET (or CBM)—\$1295.00
8K PET—\$745

The WORLD FAMOUS KIM-1 microcomputer board—the original 6502 development system. The best way possible to REALLY LEARN computers—over 400 pages of documentation! \$169.00 (regular \$179.00)

KIM-1 special package—includes the KIM-1 as above plus power supply (enough power for KIM plus 2-3 boards), book—"Programming a Microcomputer: 6502" and "The First Book of KIM" \$199.00 (regular \$238.00)

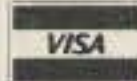

P.O. Box 1712, Auburn AL 36830
(formerly Plainsman Micro Systems)
Overseas inquiries invited

Call Toll Free 1-800-633-8724 ✓ L25
regular phone number (205) 745-7735

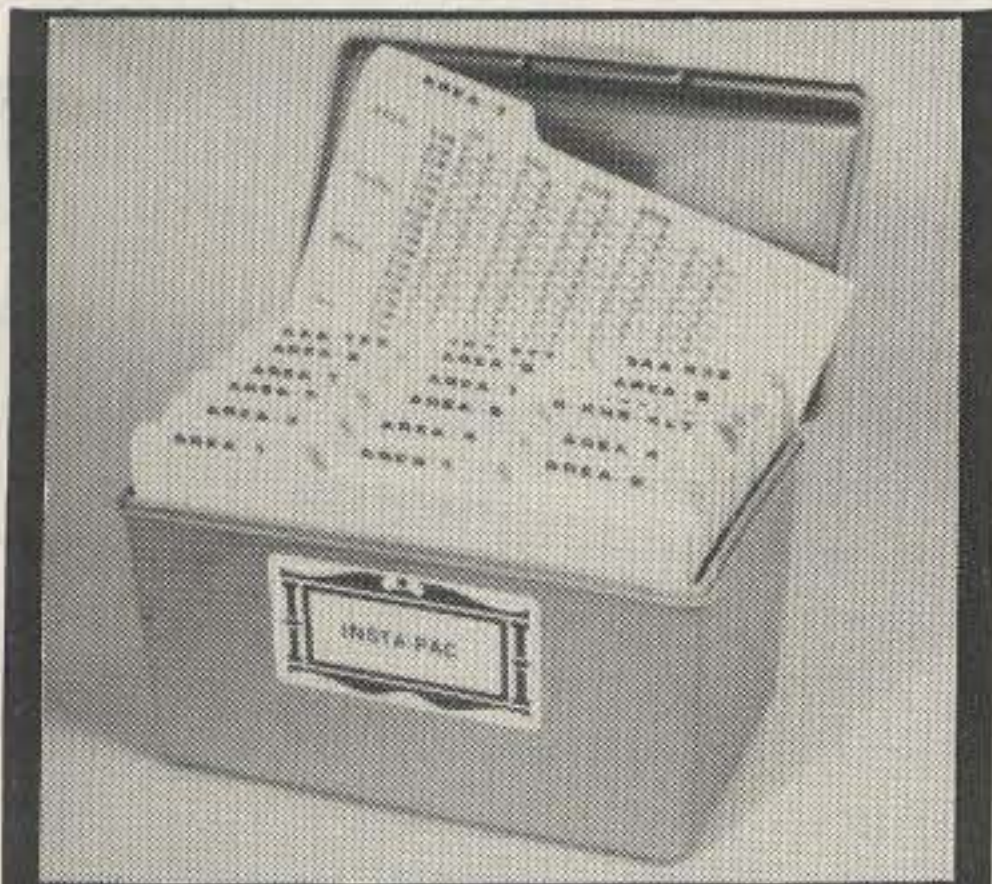

Know instantly what you have worked, what bands, modes—what needs to be confirmed—right at your fingertips. All your QSL's in one neat place—no more lost cards. ✓ I43

Unconditional money back guarantee—ONLY \$12.95
Mail to: INSTA-PAC, Box 22974, Honolulu, Hawaii 96822

NAME _____
STREET _____
CITY _____ STATE _____ ZIP _____

BI-DIRECTIONAL CASSETTE RECORDERS

★ SPECIAL BARGAIN SALE ★

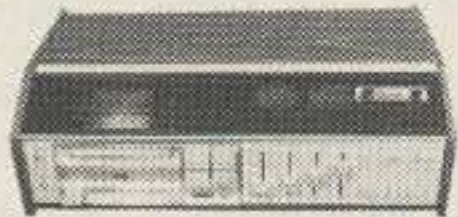

Every now and then we run into something unusual in our shopping for equipment. In this case it was a particularly good buy on Sonex cassette recorders. We needed a bunch of recorders for code tape duplication ... but in order to buy at a low price we had to take about 50 more than we needed. You benefit. These cassette recorders record and play both directions without stopping. You might expect to pay from \$250 up for a recorder like this ... we'll pass them along at our cost ... after all, we're not in the recorder business. While they last, get these recorders for \$75 each. One to a customer, please ... don't be greedy. You can call up the Radio Bookshop and place your order with a charge card: 603-924-3873.

73 MAGAZINE, PETERBOROUGH, NEW HAMPSHIRE 03458

FOR BEST PRICE AND FAST DELIVERY

CALL

1-800-325-3636

TOLL FREE



HAM RADIO CENTER

8346-42 Drive Blvd. P.O. Box 28771 St. Louis, MO 63112

Radio World
CENTRAL NEW YORK'S FASTEST GROWING HAM DEALER

Featuring Yaesu, Icom, Drake, Atlas, Ten-Tec, Swan, Dentron, Pace, Palomar, Alda, Midland, Wilson, KDK, MFJ, Microwave Module, Standard, Tempo, Astron, KLM, Hy-Gain, Mosley, Larsen, Cushcraft, Hustler, Mini Products, Universal and Tristao Towers. We service everything we sell! Write or call for quote. You Won't be Disappointed. We are just a few minutes off the NYS Thruway (I-90) Exit 32

CALL TOLL-FREE ONEIDA COUNTY AIRPORT TERMINAL BUILDING
1-800-448-7914 ORISKANY, NEW YORK 13424
NY STATE RESIDENTS CALL 315-337-2622 or 315-337-0203

Bob Warren
WA2MSH K2IXN

FLESHER CORP.

RTTY made easy !

TR-128
NEW FROM FLESHER



***RTTY REGENERATIVE BAUD RATE CONVERTER**

TTL compatible connections for direct hook-up to the TU-170, also adaptable to other units.

- ~ Five standard baud rates
- ~ Stable crystal-controlled oscillator
- ~ 128 Character storage capacity with storage status meter to show buffer fill
- ~ Continuously variable character rate

Wired \$239.95 Kit \$179.95



TU-170
TERMINAL UNIT

Connect to your receiver speaker, transmitter microphone jack, and teletype machine and you're on the air. Ideal for HF and VHF auto start operation.

- ~ Autostat with threshold control and solid state relay
- ~ Stable audio frequency shift oscillator produces phase coherent sine wave tones
- ~ TTL compatible inputs and outputs for auxiliary equipment
- ~ High level output for scope tuning

WIRED \$234.95 KIT \$159.95

Flesher products . . . the critics choice!



FLESHER CORP.

P.O. Box 976S Topeka, Ks. 66601 913/234-0198

Add \$3.00 for postage and handling.

No More TRS-80 Cassette Woes

—E-Z Loader does the trick

Paul L. Goetz WA9PUL
2228 Madison Place
Evanston IL 60202

David F. Miller K9POX
7462 Lawler Ave.
Niles IL 60648

You can eliminate most of your Level II TRS-80 cassette-loading problems once and for all! It's true, the circuit described in this article will go a long way toward eliminating your CLOAD problems. If all of the data is there on the cassette, this gadget will find it and load it into your TRS-80 Level II machine... it's the greatest thing since the Level I manual!

If you've worked with Level II for any time at all, you know that it is somewhat sensitive to playback volume on a CLOAD command (what an understatement!). Playing back a good recording through this circuit—let's call it the E-Z Loader—will allow you to set the playback volume on the Radio Shack CTR-41 recorder anywhere from 2 to 10! A not-so-good recording will have some-

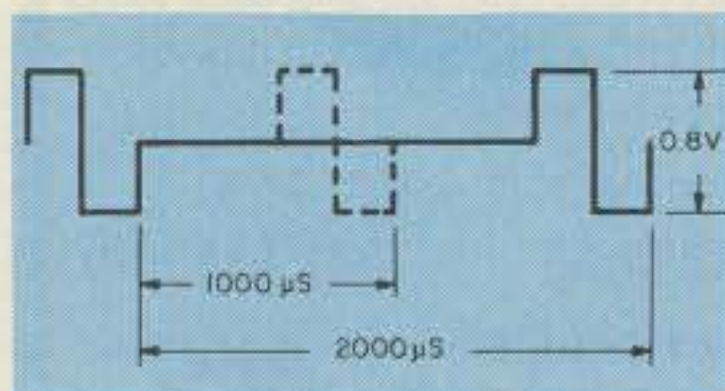

Fig. 1(a). Output directly from the cassette port of the computer. Sync pulses are solid lines; data pulses are dotted lines.

what less range, but it will still be quite broad, and you will be able to load it. Even the head azimuth (vertical alignment of the record vs the playback head if not the same machine) becomes fairly noncritical, and you can even vary the playback volume up and down while loading with no adverse effect.

Sound too good to be true? It seems that in this day and age we're besieged with all manner of claims and counterclaims, but E-Z Loader really works... try it and see for yourself!

The Problem

When you type CSAVE and ENTER, the TRS-80 puts out a positive- and negative-going square wave at the cassette port. However, when the audio recorder "processes" this square wave and lays it down on tape, it isn't exactly square any longer. Take a peek at Fig. 1 and see what we mean!

The output of the cassette recorder as depicted in Fig. 1(b) is more like a mostly negative-going spike, broadened out, with a small (in ratio) positive dimple on either side. This is what a good recording looks like; a bad one is downhill from that! Somehow, the TRS-80 will ac-

cept that waveform and load the data it contains into RAM, if the recorder/playback head azimuth is quite close and the playback level is just right!

This is where the circuit of Fig. 2 comes into action. The root of the problem lies in the TRS-80's resident software. After the computer recognizes a sync pulse, it waits a short time and then looks at the input once again. If there is a pulse present, the computer interprets it as a 1 and goes through the cycle all over again. If there is no pulse present, the computer assumes this to be a 0 and repeats the cycle.

This sequence occurs until all of the data has been loaded from the tape, at which time the READY prompt reappears. The problem in all of this, however, is in the amount of time that the TRS-80 waits after recognizing a pulse, before it looks for the next pulse, and not in the input level, as many believe!

Currently, a Level II TRS-80 waits only about 250 microseconds before testing for a pulse, and therein lies the problem. A good tape will produce a pulse that is much narrower than 250 microseconds—see Fig. 1(b)—but a bad tape, or one in which the head azimuth of the

record machine differs from the playback machine, can easily produce pulse widths in excess of that magical 250 microsecond figure! When that happens, the computer interprets the tail end of the initial pulse as a new pulse, and there goes your CLOAD!

The E-Z Loader corrects this by waiting for a sync pulse, triggering and producing an output pulse 150 microseconds wide and then locking-out for 750 microseconds (2/3 of the time between a sync and data pulse), triggering again if a data pulse (logic 1) is present, and outputting it as a 150-microsecond-wide pulse. Thus, no matter how wide your input pulses are, they can produce only 150-microsecond-wide output pulses.

In a nutshell, the E-Z Loader circuitry takes the rather poorly defined spike of Fig. 1(b) and regenerates it back into a nice square, narrow pulse again. Your computer will really love that narrow pulse and will

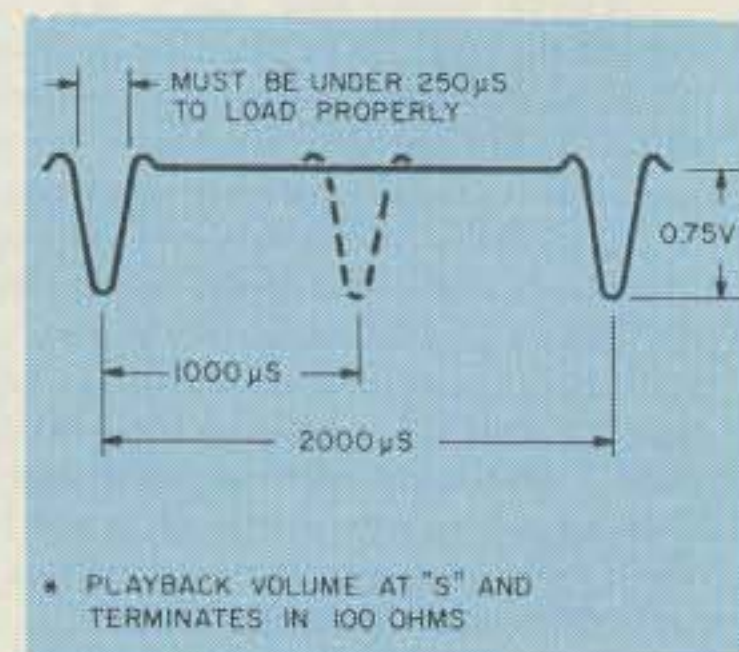

Fig. 1(b). The output from a good cassette tape after being recorded by the CTR-41 recorder. Sync pulses, solid; data pulses, dotted.

continue to reward you for your effort.

How the Circuit Works

Following the schematic diagram (Fig. 2) from the cassette player output (which is the input to the E-Z Loader), you'll notice that we transformer-couple in order to make the bridge rectifier behave properly and to eliminate the ground loop condition that exists in the Radio Shack CTR-41 recorder (in case you haven't eliminated it already by other means).

The input signal to the transformer first passes through a high-pass filter (C5 and R10) and is stepped up by a factor of at least 10. It is then applied to the bridge rectifier whose output consists of only positive-going pulses. These positive pulses are sent to the base of transistor Q1, but with a slight twist.

Locate R7 and C4 on the schematic and notice that Q1's base current must pass through C4. As pulses are rectified by the bridge, C4 charges to a voltage equal to the output of the bridge (less 0.6 V) and at the same time supplies a current spike to Q1's base, triggering the transistor. By the next time a pulse arrives, C4 has discharged slightly through R7, and again supplies a triggering current spike to Q1's base.

The net effect of all of this is that Q1, C4, and R7 form a passive level detector and trigger the rest of the circuitry only on pulse peaks, regardless of the level arriving from the recorder. The amplified and peak-detected pulses are fed to the first inverting input of the 74LS123 IC, which is a dual low-power Schottky retriggerable monostable multivibrator chip (say that three times!).

The two multivibrators in this package are connected in such a way that

the output is taken from the Q output of section one, which also feeds the non-inverting input of section two. The \bar{Q} output of section two is fed back to the non-inverting input of section one, which has the effect of disabling the output of section one for a 750-microsecond duration.

The total effect of all of this can be observed on an oscilloscope at pin 13 (or pin 10) of the IC: a positive-going square pulse, 150-microseconds wide, for every sync and data pulse leaving the tape, regardless of the width of the pulse on the tape. No hum, no noise, no miscellaneous crud to fool the TRS-80 into loading erroneous data... just nice, clean pulses. The buffer amplifier is an emitter-follower with a voltage gain somewhat less than unity, but it does a nice job of isolating and matching the 100-Ohm input impedance of the TRS-80 computer.

TRS-80 performance won't be affected by positive, negative or square waves (both transitions), so we chose positive pulses to keep the circuit parts count down. The pulses output to the computer are between 1 and 2 volts peak-to-peak (viewed on a scope with a 100-Ohm termination), regardless of where the CTR-41 recorder volume control is set, as long as there is at least enough volume to detect the pulses and trigger the E-Z Loader's circuitry. If the playback volume is too low, there simply will be no output (or possibly, sporadic output).

The point of minimum output for each cassette is easy to determine, however, and as long as you stay above that point, you'll get a good load. On a decent tape, this minimum can be 2 or 3 on the CTR-41's graduated volume control knob, and there

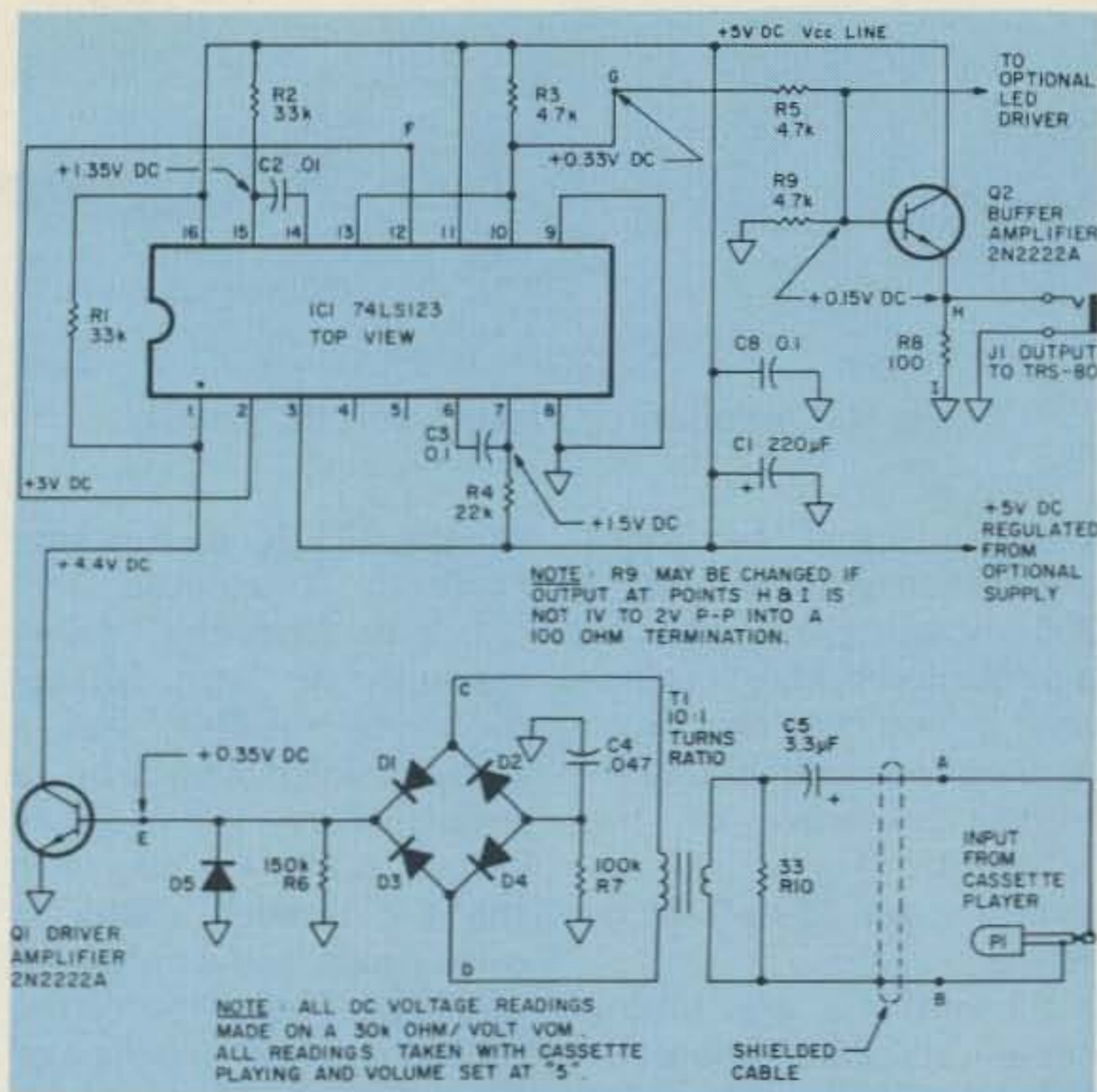

Fig. 2. TRS-80 E-Z Loader schematic diagram.

usually is *no maximum level*.

Precautions

One potential pitfall to properly loading with the E-Z Loader in-line (other than tape dropouts and/or bad data on the tape) would be insufficient level into the E-Z Loader, thus the optional LED driver shown in Fig. 3. The LED visually shows the operator that point at which the E-Z Loader is not receiving enough level from the recorder on playback. As long as the LED is lit and slightly flickering, the recorder output level control (volume) is set above this threshold. It also adds a nice touch in impressing visiting dignitaries.

It's an option because it has no effect on the rest of the circuitry and is for operator convenience only. To prevent occasional drops in level on the tape from causing a bad CLOAD, keep the recorder's output at least two divisions above the point at which the LED extinguishes.

Requirements

OK, we've talked you into building the E-Z Loader,

now you probably think that there will be some sort of catch such as specially selected parts, critical circuit layout, and/or fancy test equipment needed for alignment. No! All of the parts are available from Radio Shack with the possible exception of the input transformer, which is actually an output transformer with a turns ratio of approximately 10:1. You can probably scrounge one from that defunct \$9.95 portable transistor radio you've been putting off fixing. That's called recycling and it's the "in" thing to do.

The transformer is hooked up backwards so that the low impedance (speaker) winding is accepting the audio out of the cassette recorder. Resistors are all 1/4 or 1/2

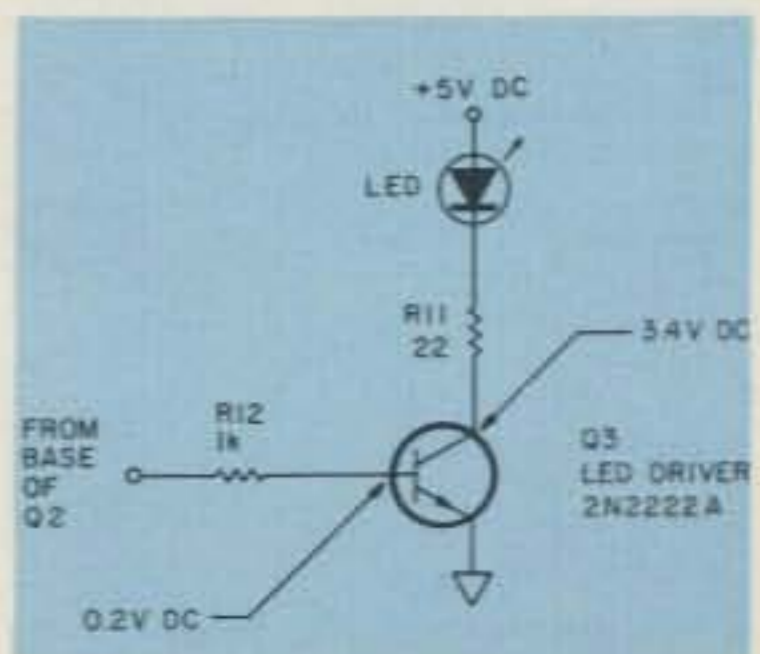

Fig. 3. Optional LED driver circuit.

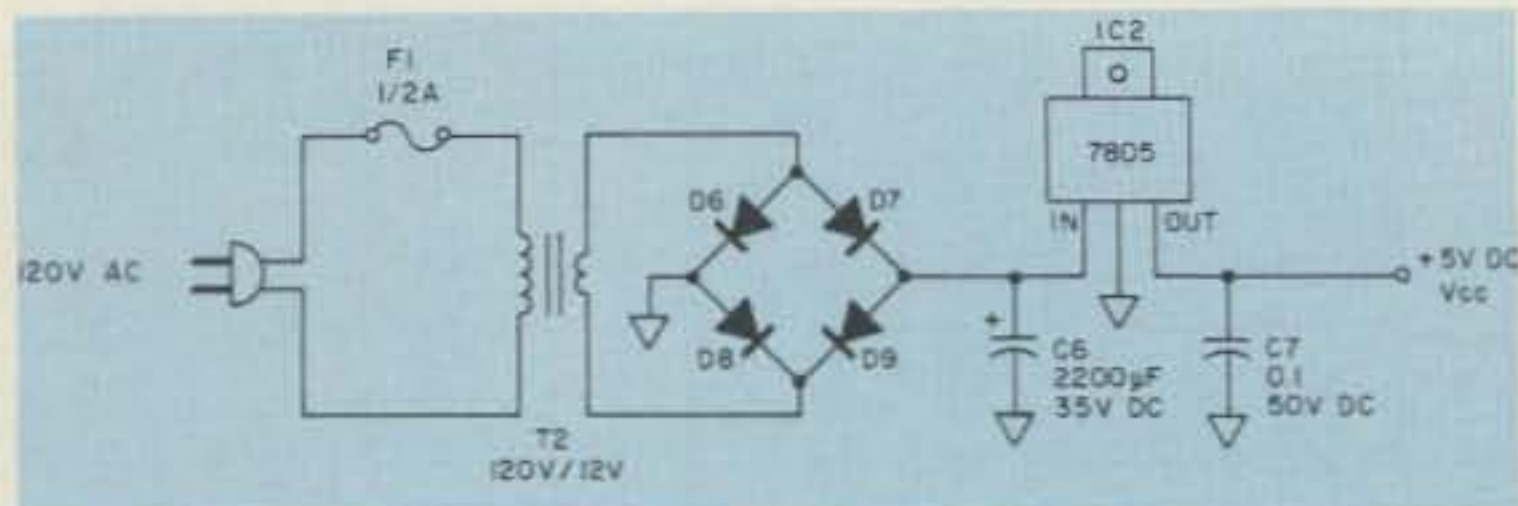

Fig. 4. Optional regulated 5-volt dc supply.

Watt units, and the diodes are silicon with at least a 200 piv rating. You can use a packaged bridge rectifier unit, or you may choose to wire up four individual rectifiers as shown on the schematic (Fig. 2). All capacitors are 35-to-50-V dc rating.

C2 and C3 are timing capacitors and should be polyester or tantalum for stability and accuracy of value. The 2N2222A transistors are medium-gain devices and also are not critical. Whether you use perfboard layout (as shown in the photo) or a printed circuit board, it would be advisable to consider using a socket for the 74LS123 IC (I just hate unsoldering 16 pins all at once).

As you may have noticed, the E-Z Loader requires +5 V dc (at about 25 mA), and it should be quite close to that figure

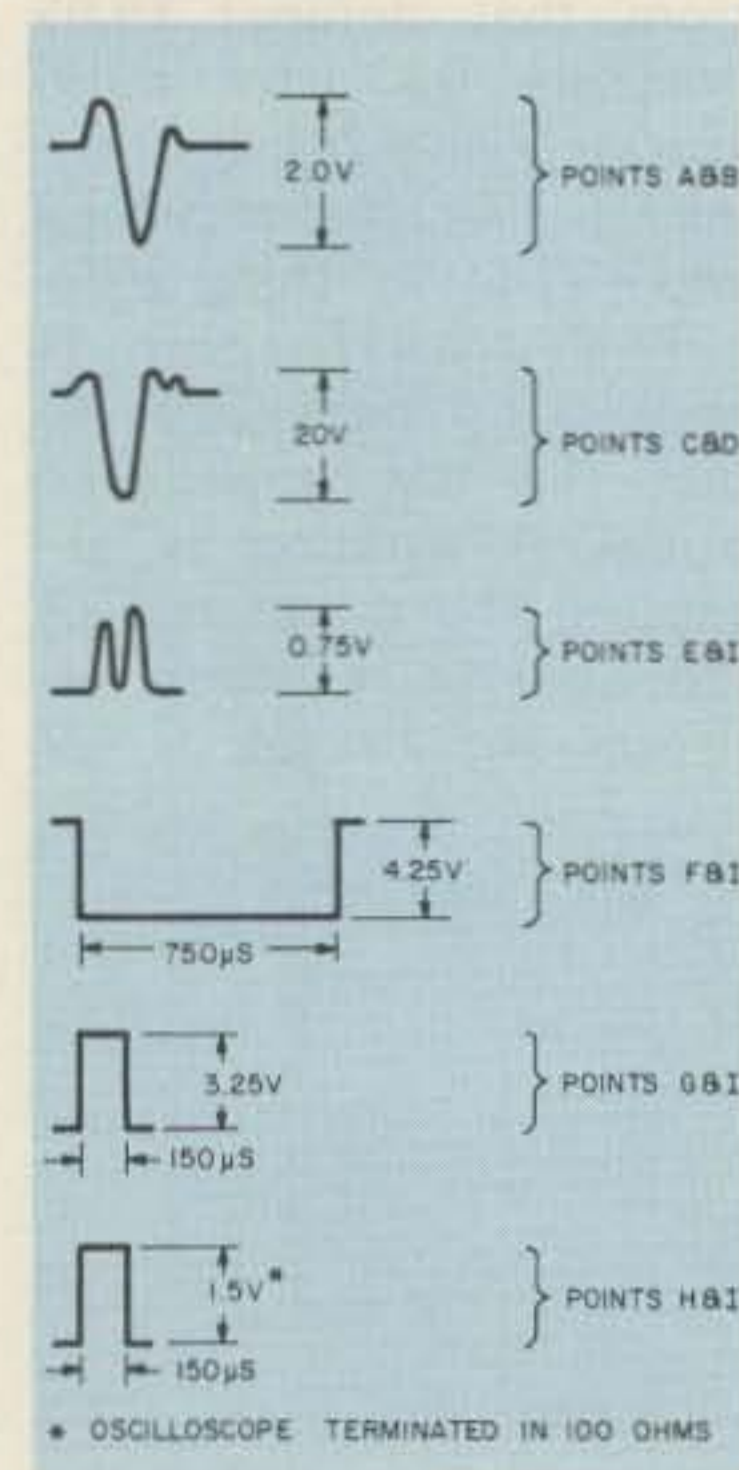

Fig. 5. Peak-to-peak oscilloscope measurement within the E-Z Loader's circuitry.

for the TTL IC to function correctly. You could steal +6 V dc from the CTR-41 through an appropriate dropping resistor, but a better choice would be to incorporate the supply shown in Fig. 4, along with the E-Z Loader board, in one neat self-contained package. The parts for the optional power supply and the optional LED driver are also available from Radio Shack. Now you don't have any excuse for putting off building the gadget!

Putting E-Z Loader to Use

There is no alignment or parts selection required. Voltage readings and oscilloscope waveforms at various points are shown to assist in verifying that the unit is functioning properly. Simply hook up the E-Z Loader between your CTR-41 recorder's "ear" output and the TRS-80's audio input and you're all set. Incorporating a 1/8-inch phone jack on its output and a 1/8-inch phone plug on its input will permit you to remove the E-Z Loader at any time and normalize your setup. But we honestly don't think that you'll be inclined to do that very often, not once you've seen how easy it is to CLOAD with the E-Z Loader in-line (except, perhaps, to demonstrate the difference to skeptical friends).

One other use for the E-Z Loader would be to clean up poor quality tapes. Using a second recorder, play the bad tape through the

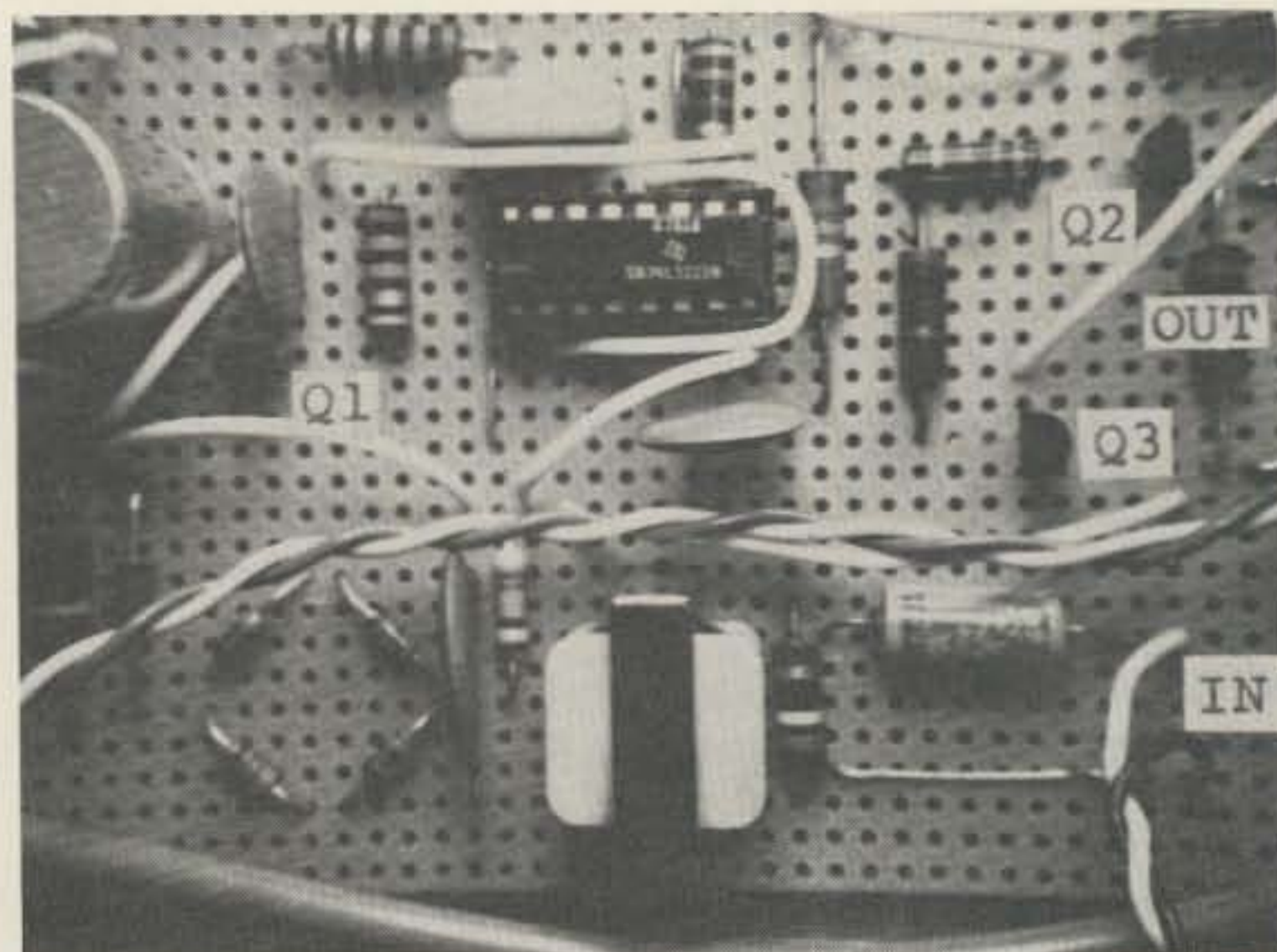

The perfboard layout used in one of the units that has been constructed.

E-Z Loader and plug the E-Z Loader's output into the second recorder's aux input. The recording on the second machine will then be first quality, and should load on anyone's unmodified computer with ease.

Exceptionally high hum

level on the tape being played back and wow (frequency instability) in the record or playback machines are other potential sources of CLOADing errors. The E-Z Loader helps in all cases, but obviously there are limits beyond

Parts List

- C1—220-µF electrolytic, R.S. #272-1029
- C2—.01-µF printed circuit capacitor, R.S. #272-1065
- C3—.1-µF tantalum capacitor, R.S. #272-1401
- C4—.047-µF printed circuit capacitor, R.S. #272-1068
- C5—3.3-µF tantalum capacitor, R.S. #272-1408
- C6—2200-µF electrolytic, R.S. #272-1020
- C7, C8—.1-µF ceramic disc, R.S. #272-135
- D1 to D9—200-volt silicon rectifiers, R.S. #276-1102
- F1—1/2-Amp, 1/4 × 1-1/4 inch fuse, R.S. #270-1271 mounted in R.S. #270-364 holder
- IC1—74LS123 integrated circuit, R.S. #276-1926
- IC2—7805 integrated circuit, R.S. #276-1770
- J1—1/8-inch phone jack, R.S. #274-251
- P1—1/8-inch phone plug, R.S. #274-286
- Q1 to Q3—2N2222A transistor, R.S. #276-1617
- R1, R2—33k, 1/2-W, 10 percent resistor, R.S. #271-040
- R3, R5, R9—4.7k, 1/2-W, 10 percent resistor, R.S. #271-030
- R4—22k, 1/2-W, 10 percent resistor, R.S. #271-038
- R6—150k, 1/2-W, 10 percent resistor, R.S. #271-047
- R7—100k, 1/2-W, 10 percent resistor, R.S. #271-045
- R8—100-Ohm, 1/2-W, 10 percent resistor, R.S. #271-012
- R10—33-Ohm, 1/2-W, 10% resistor, R.S. #271-007
- R11—22-Ohm, 1/2-W, 10% resistor, R.S. #271-005
- R12—1k, 1/2-W, 10% resistor, R.S. #271-023
- T1—audio output transformer, 10:1 ratio or greater, such as Calctro #D1-729 (200-Ohm c-t to 8 Ohm)
- T2—120 V ac to 12 V ac @ 300-mA transformer, R.S. #273-1385

Miscellaneous

- Socket for IC1—16-pin DIP, R.S. #276-1998
- LED—light emitting diode, R.S. #276-1622
- Solder, hook-up wire, shielded cable, perfboard and cabinet
- Note: C2 and C3 are timing capacitors and as such must be of good quality such as those listed above. Do not use disc types for this purpose.
- A circuit board for the E-Z Loader and power supply is available from the authors. Send \$6 and an SASE to Paul Goelz, 2228 Madison Pl., Evanston IL 60202.

which very little can be done.

Keeping your recorder's head, pinch roller, capstan and tape guides clean will go a long way toward helping the E-Z Loader do its job. Using fairly decent cassettes without wrinkles on the tape, fixing sticking reels and poorly placed pressure pads, and watching out for nonuniform oxide coating are also your responsibilities toward

good loading. As stated in the beginning of the article, as long as the data is on the tape, the E-Z Loader will go a long way toward digging it out and loading it into your TRS-80, but you will have to give it a fair shake at least!

It has been our intent to make public a circuit that is genuinely needed within the TRS-80 community. We intend no infringement on the rights of others, and

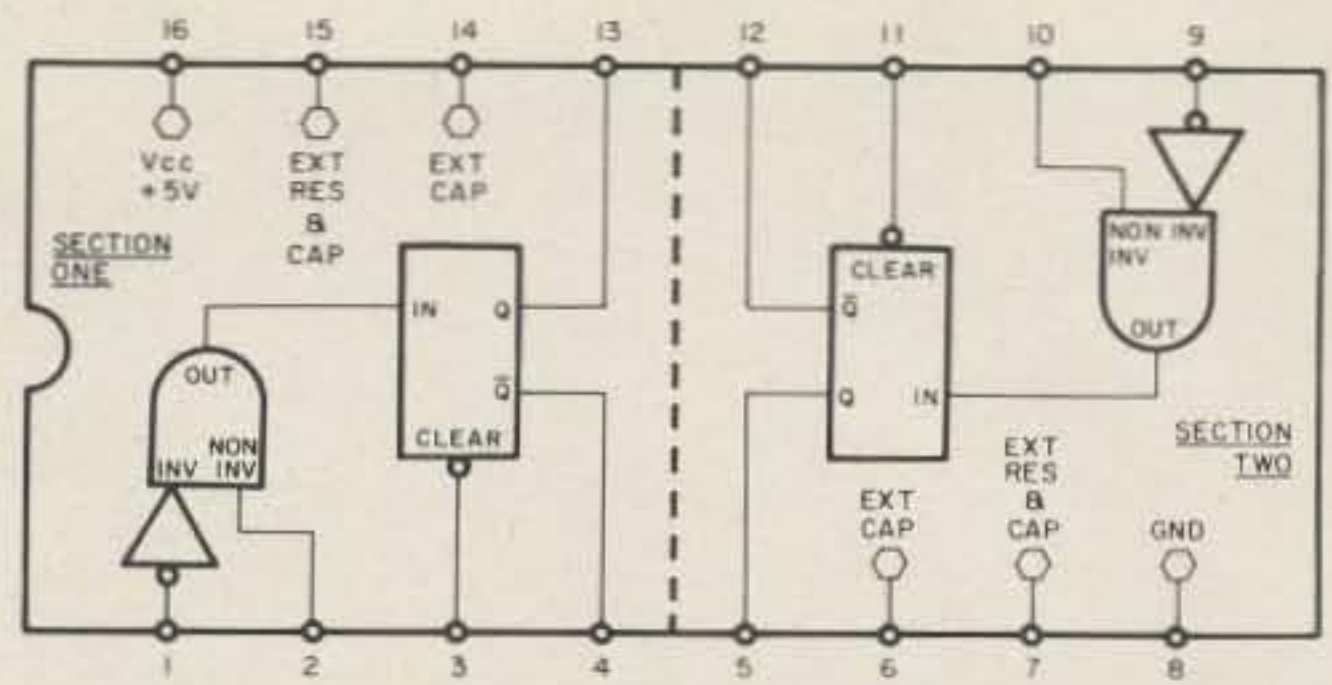
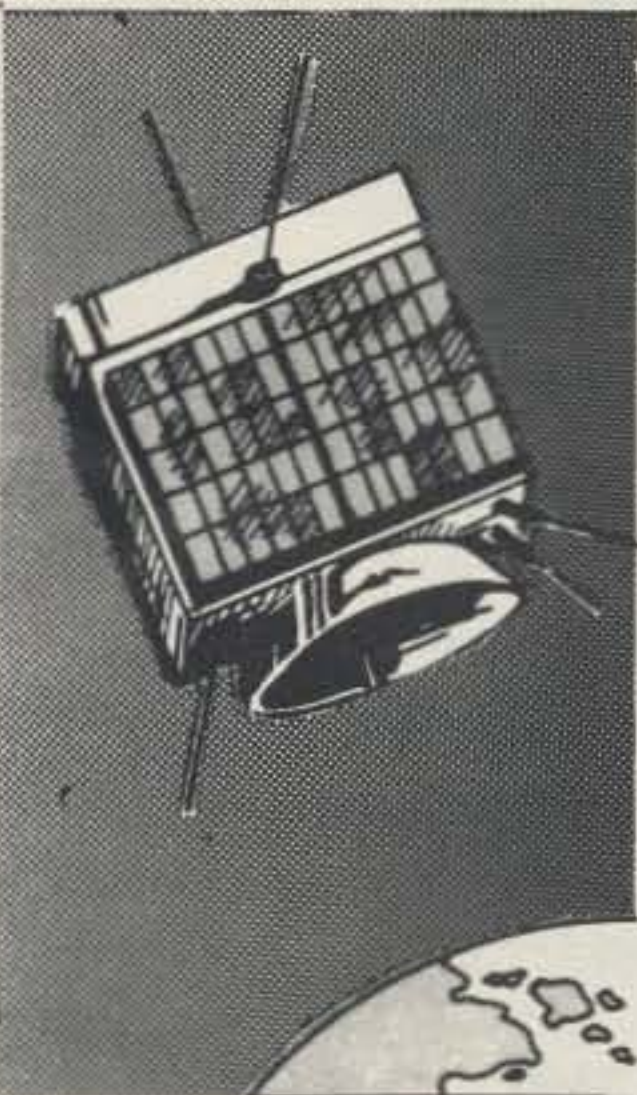

Fig. 6. Internal logic for the 74LS123 chip.

reproduction of the circuit is granted on a not-for-profit basis only. I will answer

all inquiries if the writers would be kind enough to enclose an SASE. ■



There's a new, eighth OSCAR satellite in orbit, and the AMSAT team helped put it there! Your help is needed for future satellites. Join AMSAT and support the new, advanced Phase III series of OSCARs, engineered to provide communications over transcontinental distances for hours at a time.

Send \$10 membership dues to AMSAT, P.O. Box 27, Washington, D.C. 20044. Life membership is available for a tax-deductible donation of \$100 or more, payable in quarterly installments if you wish.

Phase III satellite solar cells may be sponsored for \$10 each, and we'll send you a certificate specifying the cells you are sponsoring.

For a tax-deductible contribution of \$1,000 or more, we'll even inscribe your name on a plaque to be placed in orbit aboard the Phase III spacecraft for posterity, and we'll send you a replica honoring your contribution.

Dues and contributions may be charged to VISA or Master Charge. Phone us at (202) 488-8649.

Radio Amateur Satellite Corporation
P.O. Box 27, WASHINGTON, D.C. 20044
AMSAT
AMSAT MEMBER

ASCII MORSE RTTY

MONITOR #139.

(12" B&W)

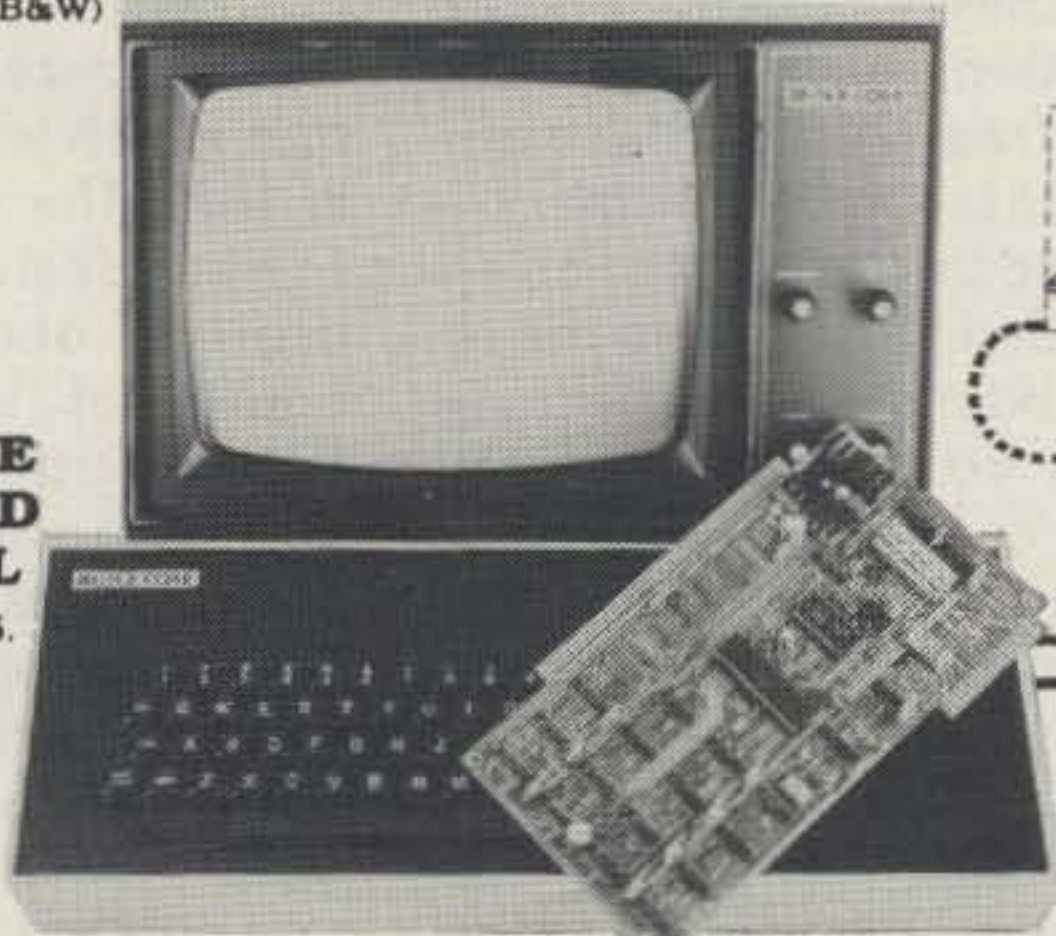

COMPLETE KEYBOARD TERMINAL
#350. Kit 295.
(Less Monitor)

SCT-100 STAND ALONE VIDEO BOARD

- Partial Kit \$99.
- Full Kit \$167.
- Assembled & Tested \$197.

COMPUTER

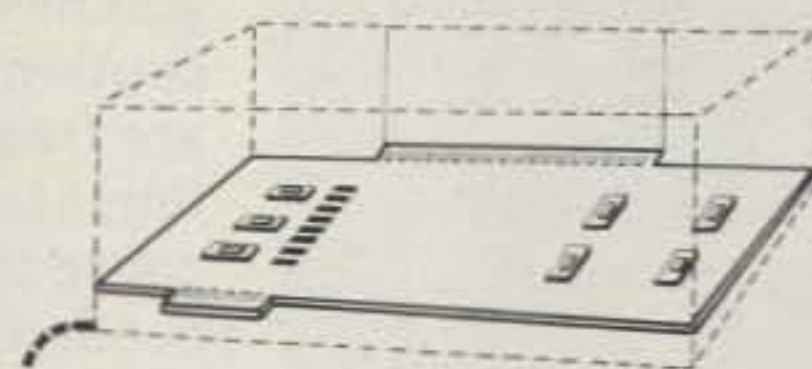

RS232 (in/out)

SERIAL LOOP

Features

- ASCII & BAUDOT
- Auto Sync. 1-150 WPM
- Microcomputer Interface

TRANSCEIVER



TERMINAL UNIT

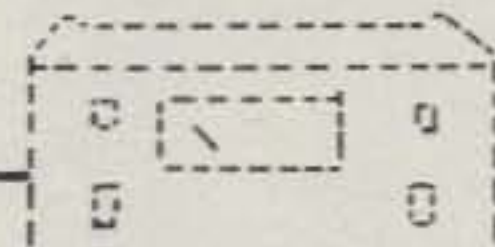

RTTY (TX/RX)

MRS-100



MORSE (TX/RX)

- Partial Kit \$95.
- Full Kit \$225.

KEYER OPTIONAL

- Assembled & Tested \$295.

XITEX CORP.

9861 Chartwell Drive
Dallas, Texas 75243 (214) 349-2490

MC/VISA ORDER BY PHONE X3

The Incredible Shrinking Transceiver

— build it on two tiny PC boards

Ray Megirian K4DHC
606 SE 6 Avenue
Deerfield Beach FL 33441

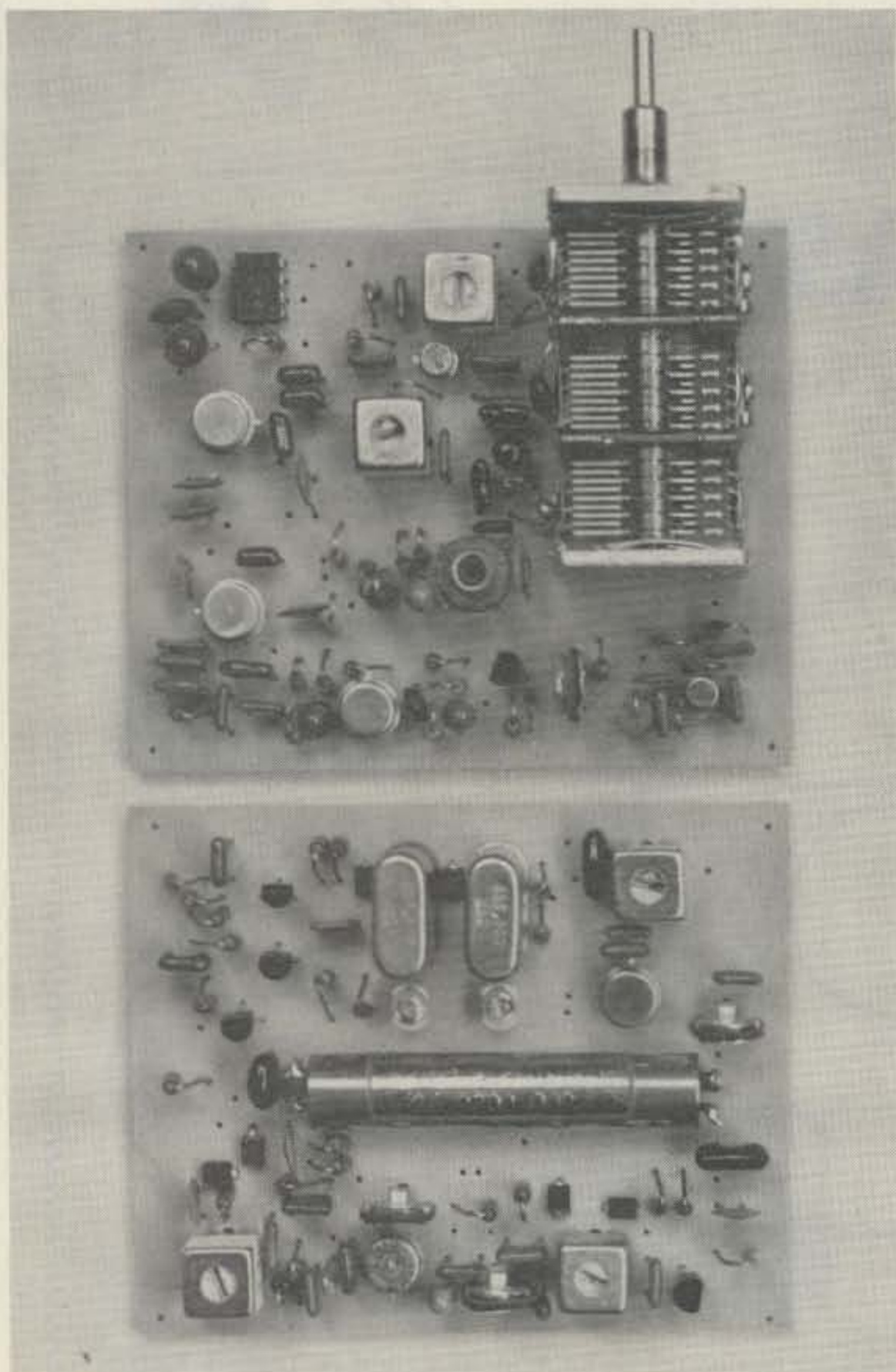

Both boards fully assembled.

Over the years, a ham's junk box can sport a pretty wild assortment of goodies, and mine is no exception. Many of the items are treasured for their sentimental value, some because they are of the often-needed variety, and the remainder simply because they cost a bunch. In this last category, I had stored away several Collins mechanical filters which by now had been with me so long that I couldn't remember how I had acquired them in the first place. On several occasions I had tried to sell or swap them, but no takers had appeared, so I decided I might just as well put them to use.

A Miniature Transceiver

If you are familiar with my Minicom series of receivers, you know I have a passion for miniaturization

and it would seem logical that the filters be used in something small. The final choice was an SSB generator and receiver combination which would ultimately form the major portion of a transceiver. The entire project occupies 2 PC boards of identical size. Both boards are 3.7" x 3" and can be stacked if desired. The receiver portion is a simplified version of the Minicom MK V and covers 3.5 to 4.0 MHz. The transmitting exciter section output is also 3.5 to 4.0 MHz. By adding a suitable amplifier, the rig could be used as is on 75 meters. For use on other bands, additional mixers and a crystal oscillator would be used to heterodyne up to the desired frequencies.

Circuit Description

The Collins filters from my junk box are all housed

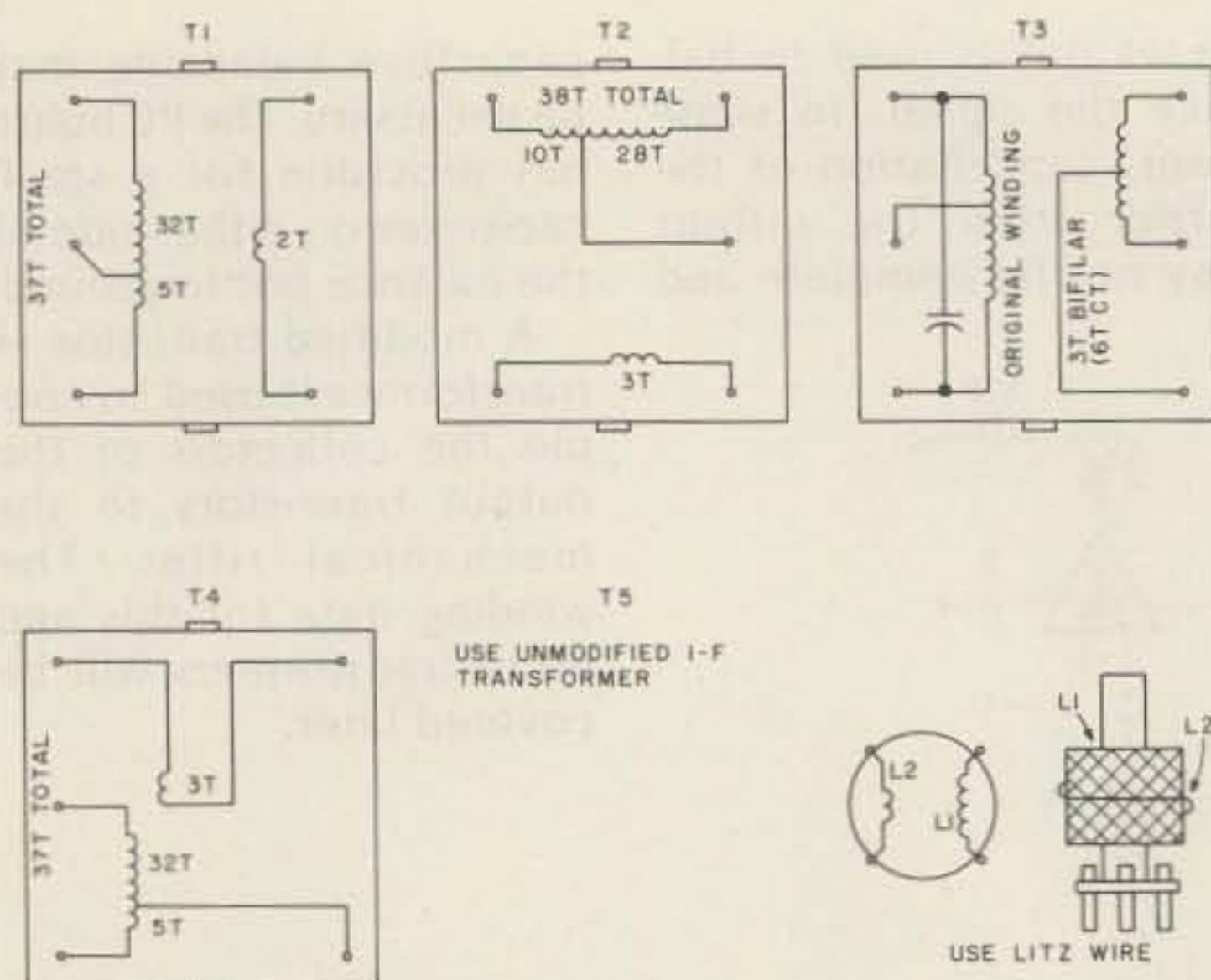

Fig. 2. Coil winding table. All bottom views.

I-f Amplifier

The SPDT diode switch at the input to the Collins filter connects it either to the transmitter mixer or to the receiver mixer output. Following the filter is a JFET amplifier that stays in the circuit for both transmitting and receiving. Then comes a second SPDT diode switch that routes the output to a second i-f stage for receiving or to a mixer for transmitting. The second i-f stage uses a dual gate FET with agc applied to gate 2.

Bfo, Vfo, and Transmitting Mixer

The bfo is crystal controlled and operates continuously since it is common to both receive and transmit modes. An SPDT diode switch selects the desired crystal for either upper- or lower-sideband operation.

The vfo tunes from 3.045 to 3.545 MHz. It is also a common circuit and operates continuously. It is actually a part of the receiver section and is the same circuit that has been used in the Minicom. The common vfo and bfo ensure that both transmitter and receiver will be on the same frequency. Since very little energy is required by the mixers, no buffers are used after the vfo. Output

is taken from a 1-turn link wound over the tank coil.

The 455-kHz signal and the output from the vfo are mixed in an SG3402T IC balanced mixer. A 3.5- to 4.0-MHz output is produced and the vfo signal is nulled by means of the 50k preset trimmer, R3. The output transformer, T4, is fabricated from a standard transistor i-f transformer. A PC pad is provided for connecting a small variable capacitor of 20 to 30 pF across the coil for front-panel peaking at any frequency. A tiny solid dielectric type from a transistor FM radio is ideal for this purpose.

Receiver

All the circuits used in the receiver section are the same as the Minicom MK V. For those not familiar with the DMOS transistors, such as the Motorola MFE521 used in the rf and i-f stages, they require a fixed bias of around 4 volts on gate 1. This is provided by the 2.2k and 4.7k resistors which form a divider across the 12-volt supply. Gate 2 is controlled by agc voltage but, unlike the regular MOSFETs, need not go negative to attenuate the signal. The DMOS transistor works with all positive bias which simplifies the agc. R4 is ad-

justed so that the no-signal level on the agc line is 6 volts. The transistors will be working at close to maximum gain at this value of bias and a strong signal will drive this voltage down to 3.5 to 4 volts. A manual rf gain control is provided and would normally be mounted on the front panel.

The mixer is an SG3402T IC which provides substantial gain and, as mentioned before, places a very light load on the vfo. Output from the mixer is routed to the filter via the diode switch.

A third SG3402T is used as a product detector and feeds the LM380N-8 audio IC directly. Some of the audio output from the detector is fed to a 741 op amp where it is amplified and rectified to provide a positive dc voltage which charges the 20- μ F tantalum capacitor across its output. Part of this charge is bled off by means of the two 1-meg resistors and applied to the gate of the 2N5246 agc control transistor. As the dc level increases due to strong signals, the transistor conducts more heavily and causes the voltage at the drain to drop. Since the drain is connected directly to the agc line, receiver gain is decreased and the purpose accomplished.

Filling in the Details

There are some numbered pads on the boards and some with letter designations. These notations also appear on the schematic and should aid in keeping the external wiring straight. The pads marked capital A, B, C, D, and E on both boards have to be connected together in pairs, that is, A to A, B to B, etc. Mating pads are directly above one another with the boards properly oriented and component side up. This allows stacking if desired. Pad A is vfo

output. B is output from the common i-f, and C is bfo output. Pad D is input to the filter, while E connects 12 volts to the vfo from the other board's constant 12-volt supply connected to pads marked 12C.

Pads to accommodate a balancing capacitor if it should be needed as mentioned earlier are marked with small letters. One pair is a and b, the other c and d.

Pads marked 12R are for 12 volts applied during receive mode, and 12T designates a connection for 12 volts applied during transmit. Only one pad is needed; others are spares. There is a separate pad (12C) for the bfo, however, and it should be connected to a constant source of 12 volts along with one of the other 12C pads.

The pad marked TR is used to control the diode switches in the i-f strip. A 12-volt level is used for transmit and a ground level for receive. A TR relay would normally control this line as well as the 12R and 12T connections. The bfo crystals are similarly controlled by application of either 12 volts or ground to pad 10.

Of the other numbered pads, none needs individual explanation since the schematic clearly indicates their locations and the function becomes obvious.

Coils and Transformers

All the transformers are fabricated from regular 10-mm 455-kHz transistor i-f transformers. T1, T2, and T4 require the bare parts only, which means removing the tuning capacitor and all wire from the bobbin. Carefully salvage all the wire as it will be used to wind the new transformers. The large winding goes on first and the link is then wound over the top. T1, T2, and T4 should be wound as per the table, making sure

TR line and the other half to transfer 12 volts between the receive and transmit circuits. An SPDT toggle can be used to switch the bfo crystals. A 10k audio gain control with log taper and a 10k rf gain control with linear taper are the only other items needed at this time. With the boards lying on the bench, make the jumpers

between boards long enough so that each board can be handled freely while making adjustments. The copper border around each PC is ground and should be made common with all other grounds and power-supply return.

Connect an 8-Ohm speaker and 12-volt power supply to the rig. Set all trimmers to midpoint. Run

the screws on the 2 compression trimmers on the 3-gang capacitor up snug but not tight. Turn the variable to full mesh. Connect a dc scope or high-impedance voltmeter between the top of the rf gain control pot and ground. Switch to receive and apply power. Current drain should be between 55 and 65 mils. Turn the rf gain control all the way down and adjust R4 for a reading of 6 volts. Disconnect the meter and turn the rf gain to maximum. Turn up the audio gain and feed in some signal at 3.5 MHz. Adjust the slug in the vfo tank coil until the signal is picked up. Adjust the cores in T1 and T2 for maximum output. Run the variable capacitor up to the high end and feed in signal at 4.0 MHz. Peak the response by means of the 2 compression trimmers on gangs 1 and 2. Repeat these 2 procedures as many times as needed to achieve good tracking. T5 can be peaked on the noise present. If the band is active, you can connect an antenna and listen on the air to verify proper operation of the receiver. Also make

sure both bfo crystals are working. This concludes receiver checkout.

An audio generator should be connected to the mike input during tune-up of the transmitter. Turn R2 to minimum and switch to transmit mode. Current drain should be 40 to 50 mils. Connect a scope to the output side of T3. A piece of discarded pigtail can be temporarily soldered to the pad if necessary to make the scope connections. With no audio input, adjust R1 to null out the carrier. If there is still some trace of rf, tack a mica trimmer across pads a and b and then c and d to see where improvement can be made. Measure the value of the trimmer at the best setting and substitute a silver mica fixed capacitor.

Once the carrier has been nulled, turn up R2 and feed in some audio signal at around 1500 Hz. Adjust the level to a point just below where distortion occurs as observed on the scope. Transfer the scope to the output side of T5. Determine the values for the capacitors that tune the filter and install them at this time. Turn the tuning capacitor up to the high end of the band just below 4.0 MHz and transfer the scope to the transmitter output at T4. Shut off the signal generator and null the vfo signal by adjusting R3. Turn on the generator and adjust the core in T4 for maximum output. Later on, a tuning capacitor can be mounted on the front panel to allow peaking of the output as frequency is changed. That concludes tune-up of the transmitter.

I've listened to the signal from this little rig on some of my Minicomms and can report that it sounds excellent.

If you write, please remember to enclose an SASE if you expect an answer. ■

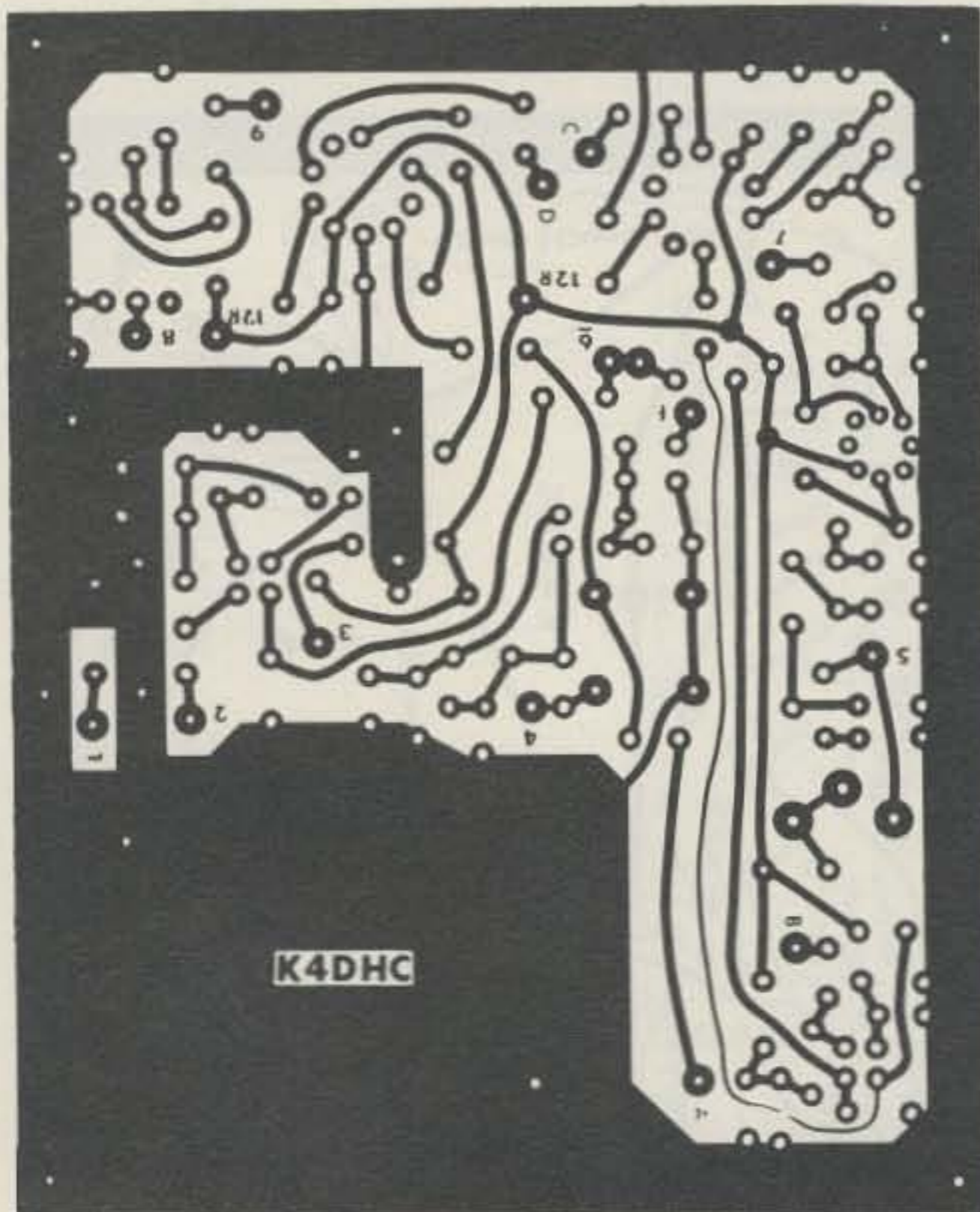

Fig. 5. PC board for receiver.

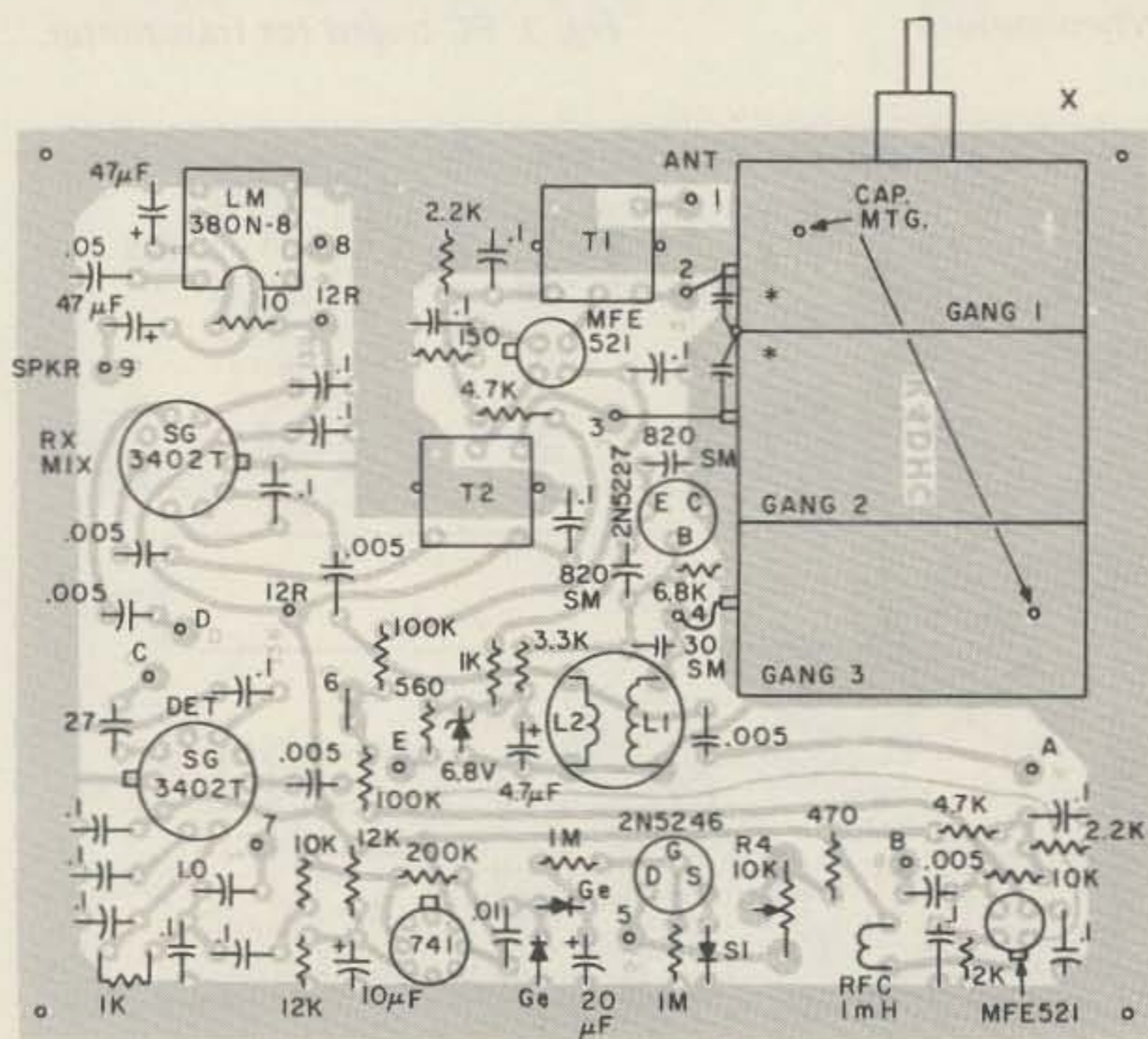

Fig. 6. Component layout for receiver board.

Terminating load resistors from Dielectric

Dielectric, the leader in supplying the communications industry with RF measuring instrumentation, has a wide selection of Terminating Load Resistors.



From a 5W dry load to a 50KW heat exchanger type load, Dielectric has a dummy load that meets your power and frequency requirements. Low power dry loads are available up to 150 Watts. Liquid/Air loads up to 10,000 watts and high power loads — either direct water-cooled or with heat

exchanger — up to 50,000 watts. All loads have a minimum VSWR specification of 1.1:1 (or better) over their rated frequency ranges.

RF Instruments for Professionals

For the name of your local distributor, call Toll Free 800-341-9678. A limited number of distributor locations are currently available; inquiries welcomed.



GS DIELECTRIC COMMUNICATIONS ✓ D29
A UNIT OF GENERAL SIGNAL
RAYMOND, MAINE 04071 • TEL. 207-655-4555 • 800-341-9678



AHF ANTENNAS

INTRODUCES
OUR NEW
EXCLUSIVE

MOBILE ANTENNA

- ✦ GREATER FIELD STRENGTH
- ✦ GREATER TUNING RANGE
- ✦ ALL NON-CORROSIVE PARTS
- ✦ ALL THREADS U. S. STANDARD 3/8 x 24
- ✦ MADE ENTIRELY OF QUALITY MATERIALS

OUR FINEST KIT
only

\$85.00

Radiator, Mast,
10 Meter Adaptor,
and 1 each
75, 40, 20 and 15
Meter Coils

(Parts may be purchased separately)

Common 2 - 4 - 6 and 8 MHz
MARINE
frequency coils also available

2 to 30 MHz Custom Frequency
Coils, made to order



Contact your favorite dealer
or
Write for brochure

✓ A92

TRS-80 OWNERS!

M800 Deluxe RTTY for the TRS-80

- Split-screen display. Full ASR.
- Save all text on cassette.
- Instant Replay - RCV and XMT text.
- Instant break operation - preserves buffers.
- WRU - save on cassette - automatically.
- Execute external programs - interactive graphics.
- One-time call sign insertion.
- Auto line numbers, margin labels, CR / LF, CR suppress, XMTR control.
- 4 small messages (255 char. ea.) plus big message (up to max. RAM).
- Additional RY, FOX, CQ messages.
- UT4 output speed control.
- Baudot (4 speeds) plus ASCII (110 baud).

Hardware/Software/Manual

Requires the
M80 Ham
Interface. **\$99**

M80 Send-Receive RTTY & CW

- Auto send. & receive: RTTY & CW
- Complete hardware & software.
- Connects to TRS-80 User Port & Key / headphone jacks.
- 10 message memories - 255 char. ea.
- Keyboard buffer - allows typing ahead.
- Uses built-in PLL or external TU.
- Includes hardware, cassette & manual.
- Morse trainer - random 5 letter words.
- Requires Level II Basic & 16K RAM.

NEW FEATURES:

- Auto-number contest keyer.
- Interactive Graphics.
- Auto-Transmitter control.

Assembled & Tested
\$149.

■ PET, APPLE, SORCERER versions available.

Write or Call for Complete Catalog.



✓ M48

MACROTRONICS, inc.®

P.O. Box 518 (S) Keyes, CA 95328
(209) 634-8888 / 667-2888

We are experiencing telephone difficulties, please keep trying.



California residents
add 6% tax

In Quest of Perfect Break-In

— well . . . almost perfect

PROLOGUE: About twenty years ago—no, more—it was the year the Russians blew our minds and our national ego by putting up their *Sputnik 1*—I found an article in an encyclopedia in the library at my high school.¹ The essence of the piece was that just anybody could have his own private radio station and communicate with other anybodies who had *their* own private radio stations. It gave detailed instructions for building a one-tube receiver. It hinted at a simple transmitter and even let on that one should get a license before transmitting.

I sent off for a hundred-pound grab-box of electronic goodies. I used only one thing: a filament transformer to heat the single filament of that single tube in my first home-brew receiver. I wound one of the coils a few turns too much (using a cardboard core from a roll of paper towels), and, behold! The local broadcast stations could be tuned in. A veritable miracle on a masonite frame.

Next, from another article, I built a simple transmitter. No, I didn't get the license, and I didn't even learn the code. But I didn't break the law, either, al-

though I intended to. This little widow-maker, I later learned, was high-voltage keyed. When I fired it up, it knocked me across the room as soon as I touched the key. I took it apart and let my yen for a personal radio communications station cool for fifteen or twenty years.

After I got out of the Army,² the yen returned. My wife drilled me in the code without ever learning it herself. I bought the first commercially-manufactured amateur transmitter I had ever seen or heard of: an Eico Model 720, for \$25.

"What will they think of

next?" I asked myself. "Somebody is saving us new amateurs a lot of trouble by building our transmitters for us."

That little jewel didn't work and it didn't have a manual or a schematic, and I didn't have a license yet, but I went right out and bought a nice brass key and a pair of coax connectors. A few days later I laid out thirty-five dollars for an Army surplus BC-348-Q receiver at a local swap meet. (Not a hamfest. I hadn't even heard of such a thing.)

WA7UKB was my "Elmer," my encourager,

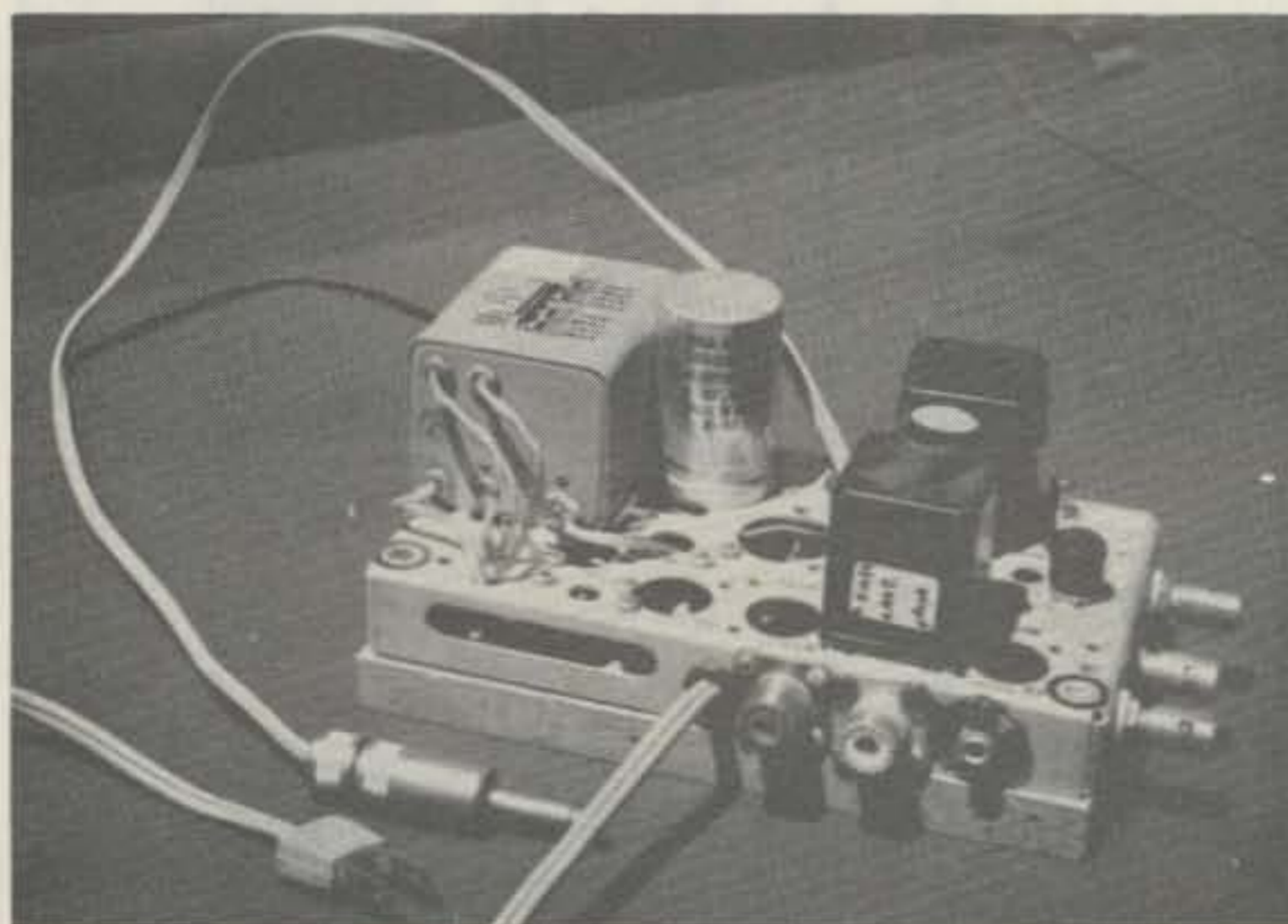

This is the finished QSK unit, showing antenna jacks, ugly holes, and wooden base.

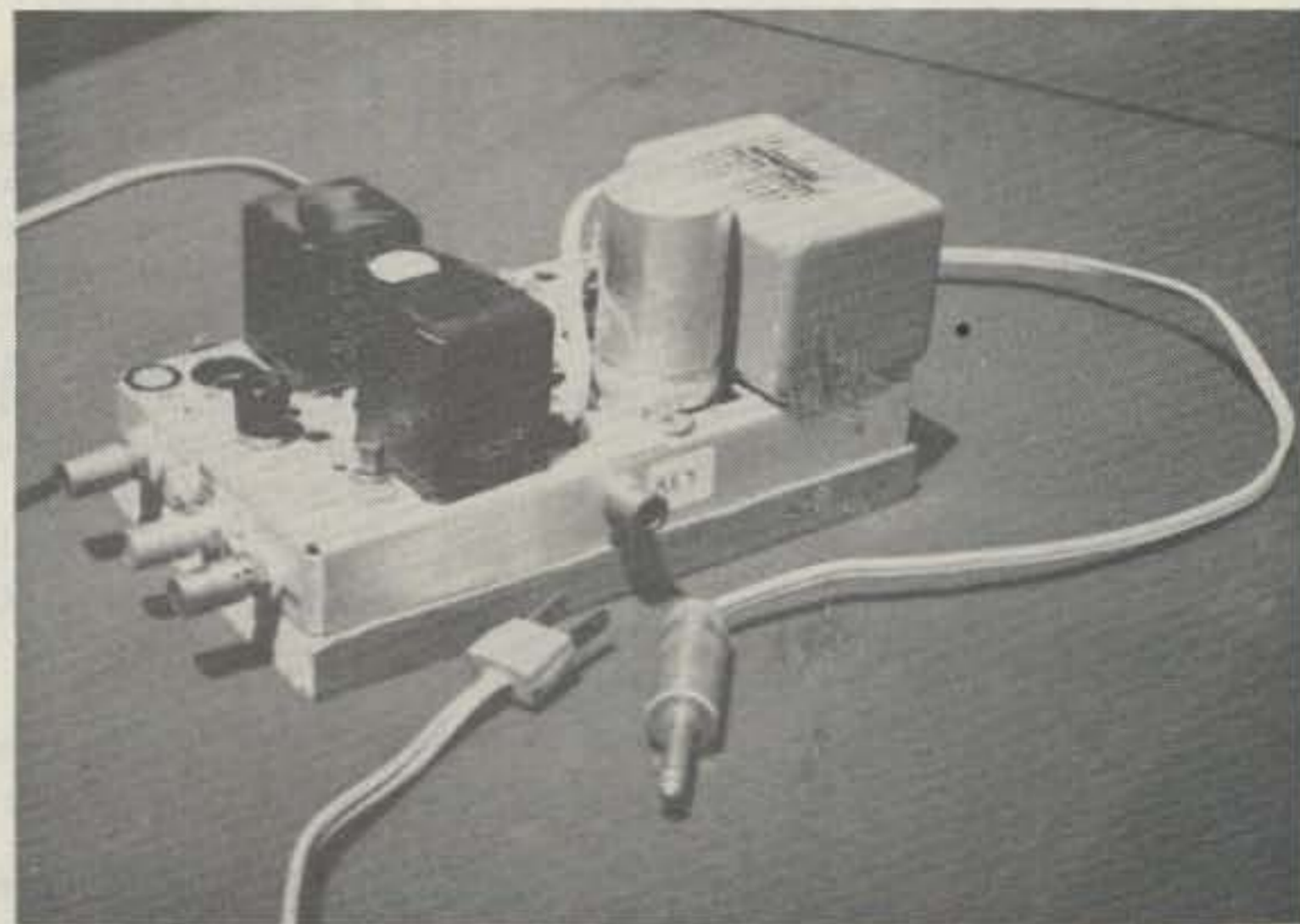

The finished QSK unit from its good side, showing mute adjustment, mute-defeat switch (the push-button), and mute and sidetone binding posts.

State of the art
TECHNICAL EXCELLENCE
in RTTY



The FSK-1000 Demodulator

If you demand the finest, no compromise technology, you need the FSK-1000 demodulator. Can't be outcopied because its design, computer grade parts, and modern technology offer landline copy over radio circuits.

Stops QRM with selectable 55 or 100 Hz. filters and two tone limiterless operation

Decision level correction improves selective fading

Uses either 170 volt, 60 Ma. or RS-232 loops

Video operation available. Interfaces microcomputers. We can install your Xitex SCT-100 board inside, too

Continuously adjustable shift from 100 to 1000 Hz.

Write for details. Visa and Master Charge accepted.

Being introduced now at
\$449.00
FOB Columbus, Ohio

IRL

700 Taylor Road
Columbus, Ohio 43230
(614) 864-2464

Code Made Easy.

To really master code, get Pickering Code Master instruction tapes. They're easy to use, easy to learn, complete and reliable. But don't just take our word for it, ask any ham. Or order a set and see for yourself.

CM-1 Novice. A complete course with 5, 7 and 9 WPM code group practice.

CM-1½ General. No instruction, just practice. ½ hr. at 11 WPM, 1 hr. at 14 WPM and ½ hr. at 17 WPM. Tape includes coded groups and straight text.

CM-2 Extra Class. Mostly straight text, some groups. 1 hr. at 20 WPM, ½ hr. at 25 and 30 WPM.

All courses are two hours long and come with key sheets for checking problem areas.

To order, send your check, money order, Master Charge or Visa number (along with card expiration date) to Codemaster. Specify number and quantity of tapes desired. Tapes are \$7.95 each, two for \$14, and three for \$19. Also specify 7" reel or cassette. We'll send your tapes post paid by fourth class mail. First class, Canada and Mexico orders, add \$1 per reel, 50¢ per cassette. To order by phone, call (401) 683-0575.

R.I. residents, add 6% sales tax.

✓ P44
Pickering
Codemaster Co.,
P.O. Box 396 D,
Portsmouth, R.I.
02871



Pickering Codemaster. Your key to code.

MY COMPETITION KNOWS ME, YOU SHOULD TOO.



COMPLETE KITS: CONSISTING OF EVERY ESSENTIAL PART NEEDED TO MAKE YOUR COUNTER COMPLETE. **HAL-600A** 7-DIGIT COUNTER WITH FREQUENCY RANGE OF ZERO TO 600 MHz. FEATURES TWO INPUTS: ONE FOR LOW FREQUENCY AND ONE FOR HIGH FREQUENCY; AUTOMATIC ZERO SUPPRESSION. TIME BASE IS 1.0 SEC OR .1 SEC GATE WITH OPTIONAL 10 SEC GATE AVAILABLE. ACCURACY ±.001%, UTILIZES 10-MHz CRYSTAL 5 PPM.

COMPLETE KIT.....\$129

HAL-300A 7-DIGIT COUNTER WITH FREQUENCY RANGE OF ZERO TO 300 MHz. FEATURES TWO INPUTS: ONE FOR LOW FREQUENCY AND ONE FOR HIGH FREQUENCY; AUTOMATIC ZERO SUPPRESSION. TIME BASE IS 1.0 SEC OR .1 SEC GATE WITH OPTIONAL 10 SEC GATE AVAILABLE. ACCURACY ±.001%, UTILIZES 10-MHz CRYSTAL 5 PPM.

COMPLETE KIT.....\$109

HAL-50A 8-DIGIT COUNTER WITH FREQUENCY RANGE OF ZERO TO 50 MHz OR BETTER. AUTOMATIC DECIMAL POINT, ZERO SUPPRESSION UPON DEMAND. FEATURES TWO INPUTS: ONE FOR LOW FREQUENCY INPUT, AND ONE ON PANEL FOR USE WITH ANY INTERNALLY MOUNTED HALTRONIX PRE-SCALER FOR WHICH PROVISIONS HAVE ALREADY BEEN MADE. 1.0 SEC AND .1 SEC TIME GATES. ACCURACY ±.001%. UTILIZES 10-MHz CRYSTAL 5 PPM.

COMPLETE KIT.....\$109

PRE-SCALER KITS

HAL 300 PRE.....\$19.95
(Pre-drilled G10 board and all components)

HAL 300 A/PRE.....\$24.95
(Same as above with preamp)

HAL 600 PRE.....\$34.95
(Pre-drilled G10 board and all components)

HAL 600 A/PRE.....\$39.95
(Same as above but with preamp)

TOUCH TONE DECODER KIT

HIGHLY STABLE DECODER KIT. COMES WITH 2 SIDED, PLATED THRU AND SOLDER FLOWED G-10 PC BOARD, 7-567's, 2-7402, AND ALL ELECTRONIC COMPONENTS. BOARD MEASURES 3½ x 5½ INCHES. HAS 12 LINES OUT. ONLY \$39.95

DELUXE 12-BUTTON TOUCHTONE ENCODER KIT utilizing the new ICM 7206 chip. Provides both VISUAL AND AUDIO indications! Comes with its own two-tone anodized aluminum cabinet. Measures only 2 3/4" x 3 3/4". Complete with Touch-Tone pad, board, crystal, chip and all necessary components to finish the kit.

PRICED AT.....\$29.95

For those who wish to mount the encoder in a hand-held unit, the PC board measures only 9/16" x 1 3/4". This partial kit with PC board, crystal, chip and components.

PRICED AT.....\$14.95

ACCUKEYER—MEMORY OPTION KIT THIS ACCUKEYER MEMORY KIT PROVIDES A SIMPLE, LOW COST METHOD OF ADDING MEMORY CAPABILITY TO THE WB4VVF ACCUKEYER. WHILE DESIGNED FOR DIRECT ATTACHMENT TO THE ABOVE ACCUKEYER, IT CAN ALSO BE ATTACHED TO ANY STANDARD ACCUKEYER BOARD WITH LITTLE DIFFICULTY. \$16.95

ACCUKEYER (KIT) THIS ACCUKEYER IS A REVISED VERSION OF THE VERY POPULAR WB4VVF ACCUKEYER ORIGINALLY DESCRIBED BY JAMES GARRETT, IN QST MAGAZINE AND THE 1975 RADIO AMATEURS HANDBOOK. \$16.95

ACCUKEYER—MEMORY OPTION KIT—TOGETHER ONLY \$32.00

6-DIGIT CLOCK • 12/24 HOUR

COMPLETE KIT CONSISTING OF 2 PC G10 PRE-DRILLED PC BOARDS, 1 CLOCK CHIP, 6 FND 359 READOUTS, 13 TRANSISTORS, 3 CAPS, 9 RESISTORS, 5 DIODES, 3 PUSH-BUTTON SWITCHES, POWER TRANSFORMER AND INSTRUCTIONS.

DON'T BE FOOLED BY PARTIAL KITS WHERE YOU HAVE TO BUY EVERYTHING EXTRA.

PRICED AT\$12.95

CLOCK CASE Available and will fit any one of the above clocks. Regular Price ... \$6.50 But Only \$4.50 when bought with clock

SIX-DIGIT ALARM CLOCK KIT for home, camper, RV, or field-day use. Operates on 12-volt AC or DC, and has its own 60-Hz time base on the board. Complete with all electronic components and two-piece, pre-drilled PC boards. Board size 4" x 3". Complete with speaker and switches. If operated on DC, there is nothing more to buy.*

PRICED AT\$16.95
Twelve-volt AC line cord for those who wish to operate the clock from 110-volt AC. \$2.95

SHIPPING INFORMATION

ORDERS OVER \$15.00 WILL BE SHIPPED POSTPAID EXCEPT ON ITEMS WHERE ADDITIONAL CHARGES ARE REQUESTED. ON ORDERS LESS THAN \$15.00 PLEASE INCLUDE ADDITIONAL \$1.00 FOR HANDLING AND MAILING CHARGES. SEND SASE FOR FREE FLYER.



"HAL" HAROLD C. NOWLAND
WBZXH

HAL-TRONIX ✓ H24
P. O. BOX 1101
SOUTHGATE, MICH. 48195
PHONE (313) 285-1782

my teacher. I became WN7CMZ. I was legal. I could transmit. At last. And with such modern, up-to-date, ready-made equipment as I could not have imagined to exist a short time before.

Look out, world! WN7CMZ is about to transmit! Plug in the crystal. Fill out the logbook headings. Warm up the tubes. Transfabulate the franistan. Borrow W7KWJ's swr meter. Prune the dipole to the last half inch. Pull up a chair. Throw the knife switch to "receive." Listen. Throw the knife switch back to "transmit." 4...3...2...1... TRANSMIT!!

YEEOOUUP YIP YAARRK YIP—WOOOP YEAAAP YIP WAAAZHP...

"Mercy sakes, good buddy! My nice new receiver has gone to the happy hunting ground." It hadn't. When I threw the antenna switch back to "receive," the WWII surplus receiver made those beautiful sea-double-you sounds again.

I asked a lot of questions and listened to a lot of answers and bought a book about amateur radio and studied it. I built an electronic transmit-receive switch right inside the transmitter and thought I was the only ham in the world smart enough to do this, seeing that my cookbook-type instruction sheet showed it on a separate chassis with a separate power supply.

I bought another receiver. It was bigger and prettier than the BC-348, but it had no markings at all, so I could never tell anyone just what I had. Anyway, with this handy combination I could transmit by pushing the key down and listen by letting it up again. The receiver overloaded very nicely and merely woofed and grunted when I transmitted, and I actually made a few contacts—some of them out-of-state.

The next summer I found out about hamfests, and I went to the one at Flagstaff. I bought a Johnson Viking Ranger because it had a built-in vfo. This transmitter didn't work, either, but it had a manual and schematic. In fact, it had two manuals—both for the Ranger II. I took out the modulator and built in a T-R switch just like the other T-R switch. It didn't work quite like the other. In fact, it didn't work at all. I built two or three different kinds, following magazine articles and friendly advice. They didn't work either.

Back to the old knife switch. Back to turning the receiver gain way down to transmit and turning it back up again to receive. Back to lost QSOs.

Back to reading about ham instead of doing ham. I bought a big pile of 73s and other amateur magazines second-hand and spent a lot of time reading them.³ There are a lot of articles in the back issues that are worth reading. Some of them tell how to change from transmit to receive without having to throw half a dozen switches. Some of them tell how to do it without using noisy, old-fashioned relays. I laid out about a day's wages for PNP transistors in blister packs and proceeded to gather the other components. The day before the transistors came in the mail, I finally found what I was looking for all along: How to do it *with* those noisy, old-fashioned relays.

Now, I had never lost the love of surprises ever since that hundred-pound grab-box twenty years before, and sometime along then I started buying two-ton grab-piles from Department of Defense Surplus Sales.⁴ Therefore, I had a very respectable junk box. It's about four feet deep in

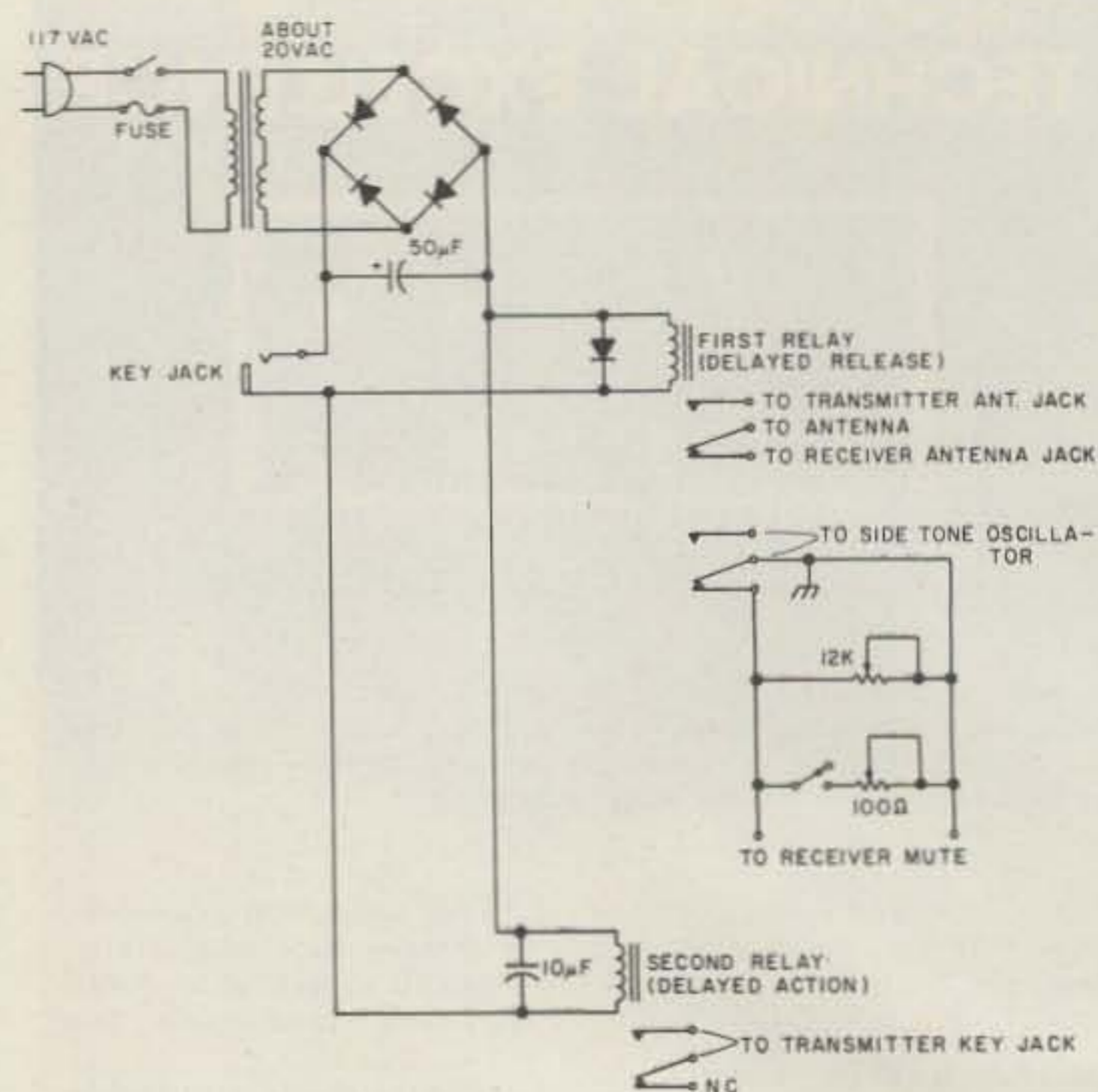

Fig. 1. Schematic diagram of break-in unit. The diode across the first relay delays its release; the capacitor across the second relay delays its action. Parts values are not critical. Contacts are shown with relays not energized.

not-so-neat rows all across my back yard. There are lots and lots of noisy, old-fashioned relays in MY junk box.

It seems the problem with relays is that the contacts cannot handle nearly as much current when they are opening and closing as when they are already closed. Sparks fly. Metal melts, or even vaporizes. The contacts get rough, pitted, oxidized, non-conductive. They may even weld themselves together. But if the current does not flow except while the contacts stay closed, those nasty things don't happen. (Unless, of course, you have a lot of current flowing.)

If you key the energizing coil of a DPDT relay and have one set of contacts key the transmitter and the other set change the antenna over from the receiver to the transmitter, pretty soon you fry the antenna change-over contacts because the finals are still putting out when the antenna connection opens at the end of each dit or dah. Sparks fly, etc.

You really need two re-

lays set to operate a very small fraction of a second apart. When you close the key, the first relay should change the antenna from receive to transmit and then the second relay should key the transmitter. When you open the key, the second relay should unkey the transmitter and then the first relay should change the antenna from transmit to receive. This way, there is no rf flowing in the relay contacts while they are opening and closing.

Here is the precious secret the Guru up on the high mountain peak in Northern India imparted to me, and now I disclose it to the world. (Actually, it has been disclosed to the world many times before, in amateur radio magazines, engineering texts, electronics magazines, the *Toymakers Journal*, handbooks, letters to the editor, over the air, and under the counter.)

You can delay the opening of a relay by putting a diode across the coil so that the inductive 'kick' when the current is shut off has a place to go; it goes

through the diode and back around the coil, and around and around it goes until it gets tired of going around and just lies down and quits due to the resistance of the circuit. This holds the relay closed a long time—maybe a thousandth of a second. When it finally, at long last, opens, a millisecond or so later, one hopes that there is no current left at the contacts to burn them up and weld them together. If your relay opens too slowly to suit your purpose, put in a few Ohms of resistance.

You can delay the closing of a relay by putting a capacitor across the energizing coil. When the current comes to close the relay, it has to charge the capacitor to a certain extent before it can close the relay. The delay is controlled by the capacity. This delay lets the other relay close and change the antenna over to "transmit" before the transmitter is even keyed. (See Fig. 1.)

This is not a secret, not a new breakthrough. But it was new to me. And very interesting. I went looking through my rows of surplus electronic scrap.

There was an aluminum chassis, about the right size, and it took me only half an evening to get the government parts off it so that I could put my parts on it. There were the relays, of course, and a filament transformer with enough winding to put in series to get enough volts. There was a solid-state rectifier bridge, a diode, and lotsa connectors. No two parts came off any one chassis in my junkyard; oops, pardon me. I mean junk box. Never bought a thing for this project.

Well, yes, it looks kinda funny, and there are holes in the chassis with no parts in them and circuit labels for circuits that aren't there any more. The labels

that count are just stick-ons, and there's that big capacitor that's merely taped onto the side of a relay. There's no panel, and wires stick out of every side except the bottom. But it works. And I did it my way. No one else ever had a QSK unit just like this one.

You're smart. You're careful. You can make a better, prettier one.

About those noisy, old-fashioned relays: They clack, clack, clack. Transistors don't. When my super-stable antique transmitter vfo drifts so far that I cannot hear my own sending on my super-stable antique receiver, I can still hear my sending, after a limited fashion, in the clacking of the relays.

These good government relays have extra sets of contacts and they are useful, too. Hook up one set as a mute and sidetone control. (See Fig. 1.) This thing worked the first time around. (That should prove there is nothing critical about it.) The receiver was silent when the transmitter was keyed, and it came back to life instantly when the key was raised. I actually made a contact or two that way before I tore into it to make improvements.

In order to hear the signal on the receiver, it cannot be altogether muted. (That's because I never got around to building that sidetone oscillator.) The diagram shows a variable resistor across the receiver-mute contacts of the first relay.⁵ It is there to adjust the loudness of the transmitter as heard in the receiver. Now I could hear myself send, but could not zero-beat the transmitter to the incoming signal without sending out a full-strength signal. It is a "no-no" to twiddle the vfo dial around with the finals turned on. It aggravates a lot of people to hear that

horrid WAH-YOOP sound when they are copying code, especially when they're copying the DX ham's callsign. The last thing I've done (so far) to this thingie is to add the "spot" switch and a second variable resistor across the receiver-mute contacts of the first relay.⁵ By closing that switch, I can hear the transmitter vfo and zero-beat the guy who's calling CQ before turning on the finals. By opening it, I can hear myself send without ripping my speaker cone and my eardrums. And the relays take care of changing the antenna from the transmitter to the receiver and back and turning the gain up and down as fast as I can key.

No. I haven't achieved Nirvana. Pardon me, I mean perfect break-in. But I have had many relaxed, satisfactory communications since I built this thing. Now that I write this, it occurs to me

that it is too complicated, too ugly... maybe a single relay would do—an open frame relay where I could get at the contacts and just bend them a little so that one contact makes before another. Let's see, a triple-pole, double-throw relay... and build it right into the transmitter... quiet it with sponge rubber, maybe... hmmm...

I can see now that this is not the final chapter of "Quest." In fact, it is all prologue. ■

Footnotes

1. *Book of Knowledge*, 1957, Vol. 14, p. 5183.
2. The United States Army, Department of Defense, Washington, D.C.
3. Lockheed Amateur Radio Club, 2814 Empire Ave., Burbank CA 91504.
4. DoD Surplus Sales, Box 1370, Battle Creek MI 49016.
5. These values were found by experiment, and are good only for my particular combination of vintage equipment.

VIBROPLEX®

Vibroplex® has built for those who use electronic keyers, the finest keying mechanism available.

the Vibro-Keyer

"deluxe"
\$65⁰⁰



- Adjustable jeweled bearings.
- Tension and contact spacing fully adjustable.
- Large, solid, coin silver contact points.
- 2½ lb. chrome plated steel base rests on non-skid feet.
- Top parts designed from our world famous Vibroplex® "Original."

- Lifetime guarantee against manufacturing defects.
- Registered serial number.
- Vibroplex® quality through-out.

"Standard" model with wrinkle finished cast iron base available for \$49.50.

Available at your dealers or through the factory. Send check, money order, or use your VISA or Master Charge. We pay all shipping charges except on orders outside the continental U.S.

See your dealer or write for literature on all our world famous line to:

The Vibroplex Company, Inc. ✓ V24
P.O. Box 7230 476 Fore St. Portland, Maine 04112
Or call: (207) 775-7710

1-800-633-3410 TODAY!

CALL LONG'S TOLL FREE

LONG'S HAM BUYERS GUIDE



Prices in this catalog subject to change without notice. Prices good only while supply lasts.

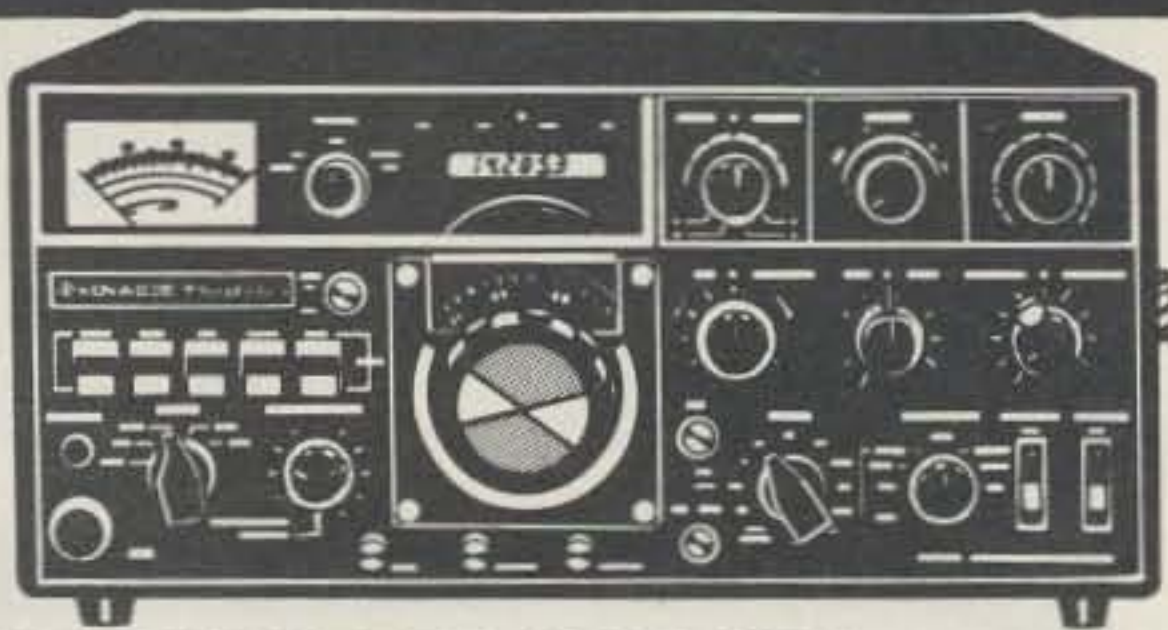

KENWOOD TS-180S HF transceiver

With Digital Frequency control with 4 memories & manual scanning, all solid state, 200W PEP SSB/160W DC, 160-10 meters, WWV, adaptable to 3 proposed bands, microprocessor, IF shift, noise blanker, RF AGC, Dual RIT (VFO & memory/fix), SSB, CW, & FSK, 13.8 VDC operation.

1149.95 List. Call for quote.



YAESU FT-901DM HF transceiver

An all mode HF total communications system. Freq. coverage: 160 thru 10 meters, 200W PEP, RF speech processor, built-in VFO, reject tuning, variable IF band width tuning, LED freq. display with memory, built-in Curtis Keyer, 6146 final tubes, AC/DC power supply built-in audio peak freq. tuning.

1495.00 List. Call for quote.

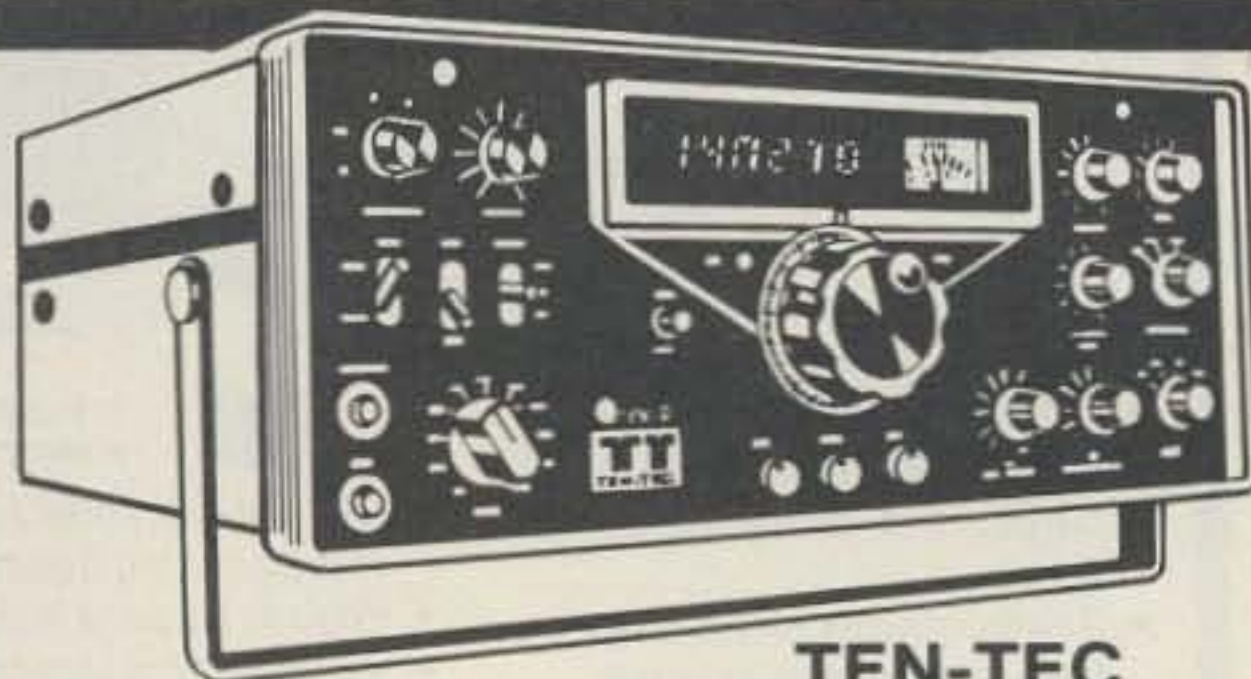

TEN-TEC Omni D Series B HF transceiver

Totally solid state. 200W all bands with 50 ohm load. Covers 160 thru 10 meters. Features digital readout, VOX and PTT, 4-position CW/SSB filter, 8 pole crystal filter, crystal calibrator, notch filter, zero beat switch SWR bridge, adjustable sidetone, operates on 12 VDC for mobile. Power supply required for fixed station.

1119.00 List. Call for quote.



DRAKE TR/DR7 general coverage digital R/O transceiver

Covers 160 thru 10 meters, reception from 1.5-30 MHz continuous, 0-30 MHz with optional Aux-7, modes: USB, LSB, CW, RTTY, AM, true passband tuning, RIT, built-in RF wattmeter/VSWR bridge, SSB 250W PEP, CW 250W, AM 80W. Power supply required for AC operation. PS-7 120/240V power supply available.

1395.00 List. Call for quote.



Long's Electronics

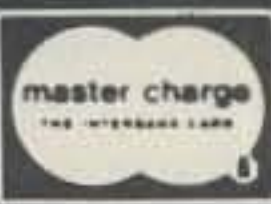

CALL LONG'S TODAY!

1-800-633-3410 TOLL FREE



KENWOOD MC-45 touchtone mic

Touchtone circuit provides PTT (push to talk) with 1/2 second hangtime. Dynamic, omnidirectional, 500 ohm imp. mic w/adjustable tone output level. Power requirement: 8 VDC, 20 mA. Has coiled cord and 5 pin mic connector. Compatible with the TR-7600 and TR-7625 with no modification.

49.95 Call today.



KENWOOD TR-7625 25W transceiver

The unit has memory channel with simplex or repeater operation ± 600 KHz transmitter offset, mode switch, full 4 MHz coverage on 2m (144.00-147.995), 800 channels, 5 KHz offset switch, MHz selector switch, digital freq. display, unlock indicator for transceiver protection.

425.00

List. Call for quote.



KENWOOD TR-7600 2m FM transceiver

Featuring full 4 MHz coverage 144-148, 800 channels, 10W RF output/1W Lo, memory channel with simplex or repeater offset, 13.8 VDC at 3 A continuous. Also LED freq. display, tone pad terminal and band pass filter. RM-76 microprocessor unit avail.

375.00 List. Call for quote.



YAESU CPU-2500RK 2m FM transceiver

With 800 PLL ch., automatic scan over entire 2m band, 4 memories, tone burst, 25W hi/3W lo, 13.6 VDC at 8 amps, freq. coverage 144-148 MHz. Keyboard mic allows remote input of memory or dial freqs., up/down scanning control, aux. repeater split selection to 4 MHz, and 2 tone input for autopatch or control link.

585.00 List. Call for quote.



ICOM IC-280 remotable 2m mobile transceiver

The main PLL control head may be detached and remotely mounted. The unit with the microprocessor stores 3 frequencies even after power is turned off. Freq.: 143.90-148.11 MHz, power: 10 watts Hi/1 watt adjustable Low. 13.8 VDC at 2.5 amps. Large easy to read LED's.

480.00 List. Call for quote.



ICOM IC-245/SSB all mode 2 meter transceiver with memory

Includes a single sideband adapter allowing both FM & SSB/CW. Freq: 144-148 MHz, easily works the new 144.5-145.5 repeaters, TX output 10W; A3J, 10W (PEP)/ A1, 10W, 4 digit LED, RIT function, step size: 5 KHz for FM, 100 Hz or 5 KHz for SSB. Compatible with the RM-2 microprocessor unit.

729.00 List. Call for quote.

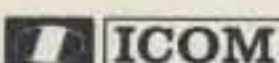

ICOM IC-215 2m FM transceiver

Features: 15 channel capacity, MOS FET RF amplifier and 5 tuned circuits in the front end for optimum sensitivity and selectivity, S-meter on front panel, dual power level, 3W Hi for long distance, 0.5W Low for local, 13.8 VDC, uses C batteries or rechargeable battery pak, BC-20.

239.00 List. Call for quote.



YAESU FT-202R 2m handheld FM transceiver

1 watt output minimum, 6 channel capability, flexibility helical whip antenna, equipped with tone burst, compact size and light weight, S-meter and battery condition indicator, operated on 8 AA NiCad or 7 AA dry cell batteries. 3 pr. Xtals incl.

199.00 List. Call for quote.



KENWOOD TS-700SP all mode 2m transceiver

Covers the entire 2 meter band. SSB, CW, FM, AM, and semi-break in CW, side tone monitor, digital frequency readout, receiver preamp and 600 KHz repeater offset operation within all 2m repeater subbands including the new 144.5-145.5 MHz. 10 watts RF output complete with AC/DC power supply.

799.00 List. Call for quote.



Larsen Antennas

LARSEN LM-MM 150K magnetic mount antenna

The 5/8 wave length 2 meter antenna consists of a 49" stainless steel rod, quadruple plated, coil for 144-174 MHz, cable and magnetic mount. Coil threads 5/16" x 24 threads. 3 dB gain over a 1/4 wave antenna.

39.45 Call today.



TUCH COM 227R encoder mic

Fits the Yaesu FT-277R with no modifications. 500 ohm impedance. Completely wired with 4 pin mic plug for direct hook up to the FT-277R. Also available: TUCH COM 1215 which fits the ICOM 211, 22S, 280S, 215 with no modification.

49.00 Call today.



Long's Electronics



& MAPS CALL TOLL

FOR YOUR BOOKS, TAPES



ARRL Publications

ARRL Radio Amateur's Handbook Newly revised & jam-packed with everything from basics to latest developments. I.N. 10081 9.75
ARRL Radio Amateur's License Manual The most up to date compilation of rules & regulations. Covers from Novice to Extra Class. I.N. 10012 4.00



ARRL Antenna Handbook Complete instructions for building antennas of all types. I.N. 10026 5.00
ARRL World Map I.N. 10099 3.50
LCF Calculator Slide rule type calculator to compute resonant frequency, etc. A great aid! I.N. 10062 3.00
Electronic Data Book All you need to know about Filter design, RF circuit data, antennas and feeding info & more. I.N. 10027 4.00
Learning to Work With Integrated Circuits Build a digital voltmeter/freq. counter while learning about IC's. I.N. 10060 2.00
Single Sideband for the Radio Amateur Covers theory and practical how-to-built ideas. I.N. 10017 3.00
FM and Repeaters for the Radio Amateur Learn all about FM and repeaters from this handy book. I.N. 10014 5.00
Solid State Design for the Radio Amateur Packed with information for practical use of solid state devices. I.N. 10061 7.00
Solid State Basics Pure solid state information and practical basics for today's ham. I.N. 10037 5.00
Specialized Communication Techniques for the Radio Amateur Covers ATV, SSTV, FAX, RTTY, satellite communications and more. I.N. 10028 3.00
ARRL Radiogram Message Pads I.N. 1000775 ea.
ARRL Special Operating Kit Consists of ARRL Ham Radio Guide, full color U.S. area call map, ARRL log book, 70 ARRL radiograms. I.N. 10063 6.50
ARRL Ham Radio Operating Guide Brush up on good operating practices with this ready reference source. I.N. 10025 4.00
Satellite Communications A package of maps and articles explaining amateur satellites. Includes Getting to Know OSCAR. I.N. 10064 4.75
80 meter DXing Handbook. Contains 4 sections on propagation, antennas, station equipment, and operating practices. It's filled with solid practical experience. I.N. 26307 4.50
The Amateur Radio Vertical Antenna Handbook. The first book for amateurs solely about vertical antennas, it is full of information. I.N. 26316 5.00
The Challenge of 160 The unique operating characteristics are explained and there are tips on building simple equipment. I.N. 26312 4.95



Hints and Kinks New ideas written by hams themselves. This is full of practical ideas and tips that they have used successfully. I.N. 10029 4.00
Radio Frequency Interference A new book to help everyone understand RFI. It covers all from good neighbor relations to simple technical cures for RFI. Helps identify and solve problems. I.N. 10083 3.00



ARRL Code Kit Upgrade your Novice or Tech. License with these 2 60 min. cassettes with speeds of 5, 7½, 10, & 13 wpm. Instruction book included. I.N. 10046 8.00
ARRL Log Books spiral bound books.
 Large I.N. 10015 1.75
 Small I.N. 1002075
Tune in the World with Ham Radio Learn all about amateur radio with a text and a morse code cassette. For the beginner studying for the Novice exam. I.N. 10031 7.00
Understanding Amateur Radio A must guide for the newcomer, it explains in simple language elementary principles of electronics & tells how to build low cost equipment. I.N. 10016 5.00

Radio Publications, Inc.

Beam Antennas Handbook by Wm. Orr, W6SAI. I.N. 26200 4.95
Wire Antennas by Wm. Orr, W6SAI. I.N. 10058 4.95
All About Cubical Quad by Wm. Orr, W6SAI. I.N. 26201 4.75
The Truth About CB Antennas by Wm. Orr, W6SAI. I.N. 26202 5.95
EIMAC's Care and Feeding of Power Grid Tubes I.N. 26205 4.95
The Antenna Handbook I.N. 26207 6.95
VHF Handbook by Wm. Orr, W6SAI. I.N. 26203 5.95
Better Short Wave Reception by Wm. Orr, W6SAI. I.N. 26204 4.95



Ameco Books

Communicate with the World with Ham Radio NP-1. I.N. 24825 6.95
Ameco 7-01 Question and Answer Guide for the Novice Exam 1.00
Question & Answer for Advanced Class Exam 16-1 I.N. 24809 1.50
Question & Answer for Extra Class Exam 17-1 I.N. 24801 1.50
Radio Amateur Theory Course 102-01 I.N. 24812 5.95
Radio Electronics Made Simple I.N. 24800 2.50
Logbook I.N. 24807 1.50
Commercial Radio Operator Theory Course 15-01 I.N. 24808 6.95
Commercial Q&A License Guide Ele. 4 10-01 I.N. 24805 1.95
Commercial Q&A License Guide Ele. 3 9-01 I.N. 24804 2.95
Commercial Q&A License Guide Ele. 1, 2, & 8-01 I.N. 24803 1.50



Other Great Books

Collins Radio Co. SSB Amateur Single Sideband. I.N. 10092 4.95
73 Magazine VHF Antenna Handbook. I.N. 26303 4.95
73 Magazine Novice Class Study Guide. I.N. 26300 4.95
73 Magazine General Class Study Guide. I.N. 26301 4.95
The Beverage Antenna Handbook. I.N. 0000 5.00
K3CHP DX QSL Guide I.N. 26313 3.95
Amateur TV in a Nutshell. I.N. 26322 5.00
How to Make Better QSL's. I.N. 26304 4.95
The Complete Handbook of Slow Scan TV. I.N. 30518 9.95

Remember, you can Call Toll Free: 1-800-633-3410 in the U.S.A. or call 1-800-292-8668 in Alabama for our low price quote. Store hours: 9:00 AM til 5:30 PM, Monday thru Friday.

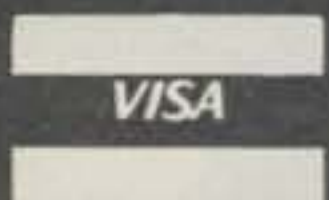

Long's Electronics



MAIL ORDERS: P.O. BOX 11347 BIRMINGHAM, AL 35202 • STREET ADDRESS: 2808 7TH AVENUE SOUTH BIRMINGHAM, ALABAMA 35233

FREE 1-800-633-3410 OR

ORDER BY MAIL TODAY

Tab Books

- Novice Class Study Guide I.N. 30517 5.95
- General Class Study Guide I.N. 30519 7.95
- Advanced Class Study Guide I.N. 30522 5.95
- Extra Class Study Guide I.N. 26302 5.95
- A Beginners Guide to Microprocessors I.N. 30502 5.95
- 57 Programs and Games in Basic I.N. 30501 7.95
- The "Compulator" Book I.N. 30509 7.95
- Ham Radio Incentive Licensing Guide I.N. 30503 4.95
- Programming Microprocessors I.N. 30508 . 8.95



- Third Class FCC License Study Guide I.N. 30514 6.95
- First Class FCC License Study Guide I.N. 30542 7.95
- Electronics Data Handbook I.N. 30549 5.95
- Impedance I.N. 30520 5.95
- Basic Digital Electronics I.N. 30527 4.95
- Basic Electronic Problems Solved I.N. 30545 4.95
- Tower's International FET Selector I.N. 30500 6.95
- Second Class FCC Encyclopedia I.N. 30535 7.95
- How to Use AF and RF Signal Generators I.N. 30512 5.95
- Electronics Unraveled I.N. 30531 5.95
- Master Transistor/IC Substitution Handbook I.N. 30510 7.95
- RF and Digital Test Equipment You Can Build I.N. 30521 5.95
- Commercial FCC License Handbook I.N. 30542 7.95
- IC Projects for the Amateur and Experimenter I.N. 30543 5.94
- How to Read Electronic Circuit Diagrams I.N. 30546 6.95

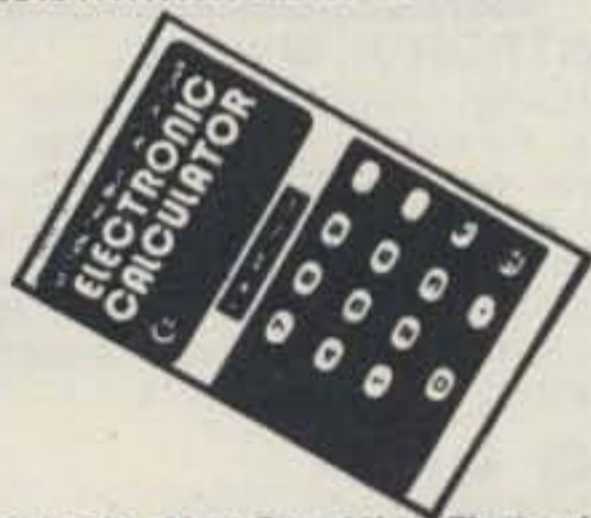

- Getting the Most Out of Your Electronic Calculator I.N. 30528 4.95
- How to Install Everything Electronic I.N. 30552 7.95
- The 2 Meter FM Repeater Circuit Handbook I.N. 30537 6.95
- Modern Applications of Linear IC's I.N. 30530 9.95
- Mobile Radio Handbook I.N. 30534 4.95
- Basic Electricity and Beginning Electronics I.N. 30536 5.95
- Practical Solid State DC Power Supplies I.N. 30515 6.95
- Electronic Conversions, Symbols, and Formulas I.N. 30524 5.95
- Tower's International Transistor Selector I.N. 30507 6.95
- Electronic Test Equipment and How to Use It I.N. 30526 4.95



- Master Handbook of 1001 Practical Electronic Circuits I.N. 30523 9.95
- Master Handbook of Ham Radio Circuits I.N. 30506 8.95
- Complete Short Wave Listeners handbook I.N. 30532 6.95
- Master OP-AMP Applications Handbook I.N. 30505 9.95
- C.E.T. License Handbook I.N. 30513 8.95
- Effective Trouble Shooting with EVM and Scope I.N. 30525 5.95
- Handbook of Electronic Tables I.N. 30548 4.95
- Homebrew HF/VHF Antenna Handbook I.N. 30504 5.95
- How to Be a Ham I.N. 30533 3.95



Radio Amateur Callbook

- Map Library A complete set of maps, prefix world map, great circle chart, map of N. America, and world atlas. I.N. 10005 3.75
- Callbook binders
- U.S. callbook red I.N. 10054 6.00
- DX callbook blue I.N. 10055 6.00
- DX Callbooks I.N. 10001 14.95
- U.S. Callbooks I.N. 10000 15.95
- Prefix map of North America I.N. 10004 1.25
- Zone prefix map of the World I.N. 10022 1.25
- Great circle chart of the World I.N. 10003 1.25

RSGB Books

- Oscar - Amateur Radio Satellites The comprehensive book on amateur satellites illustrated with pictures and charts. I.N.10059 8.50
- VHF-UHF Manual If you have any interest above 30 MHz, then get this book. It covers everything in this field. I.N. 26208 13.95



TRAINING PACKAGES TAPES

Crack the code and ace your exam by studying the new way with our selection of cassettes. Just drop them into a cassette player and study anywhere easily and quickly. You'll have great results.

73 cassettes
Novice Theory Tapes prepare you for the FCC novice exam. Clearly presented material can be reviewed many times. I.N. 26306 15.95

Code Tapes
5 word per min. Blitz Tape I.N. 26308 4.95
6 word per min. Blitz Tape I.N. 26309 4.95
13 word per min. Blitz Tape I.N. 26310 4.95
20 word per min. Blitz Tape I.N. 26311 4.95



Te co Code Practice Tape are guaranteed for life.

- Novice tape I.N. 31461 3.95
- 5 wpm tape I.N. 31450 3.95
- 7 1/2 wpm tape I.N. 31451 3.95
- 10 wpm tape I.N. 31452 3.95
- 13 wpm tape I.N. 31460 3.95
- 15 wpm tape I.N. 31454 3.95
- 17 wpm tape I.N. 31455 3.95
- 20 wpm tape I.N. 31456 3.95
- 22 wpm tape I.N. 31457 3.95
- 25/30 wpm tape I.N. 31458 3.95
- 35/40 wpm tape I.N. 31459 3.95

Ameco Code Tapes

- Junior Code Course #100-T Covers start to 8 wpm I.N. 24819 4.95
- Advanced Code Course #103-T From 8 1/2 to 18 wpm. I.N. 24821 4.95
- Senior Code Course #101-T Double length covering the Junior and Advanced Courses start to 18 wpm. I.N. 24820 8.95
- Extra Class Code Course #104-T Covers from 13 wpm to 22 wpm includes FCC type exam. I.N. 24822 4.95
- General Class QSO tapes #105-QT 12, 13, 14, & 15 wpm. I.N. 24827 4.95
- Extra Class QSO tape #106QT 19, 20, 21, & 22 wpm. I.N. 24826 4.95

Katronics
QSO Code Tapes Covers 7 1/2, 10, 13, & 15 wpm. Be ready for the new FCC exams! I.N. 28906 4.95

Remember, you can Call Toll Free: 1-800-633-3410 in the U.S.A. or call 1-800-292-8668 in Alabama for our low price quote. Store hours: 9:00 AM til 5:30 PM, Monday thru Friday.

VISA

Long's Electronics

master charge
THE INTERNATIONAL CARD

1-800-633-3410 TODAY!

CALL LONG'S TOLL FREE

ORDER NOW!



DENTRON Clipperton L linear amplifier

Hi/Lo Power switching, covers 160 thru 15 meters, 2000W PEP SSB, 1000W DC on CW, RTTY, SSTV, continuous duty power supply 2500V idle SSB 1800V idle CW, covers most MARS frequencies, easily changed 117V or 234V AC 50/60 Hz. Final tubes: 4-572B.

599.50 List. Call for quote.

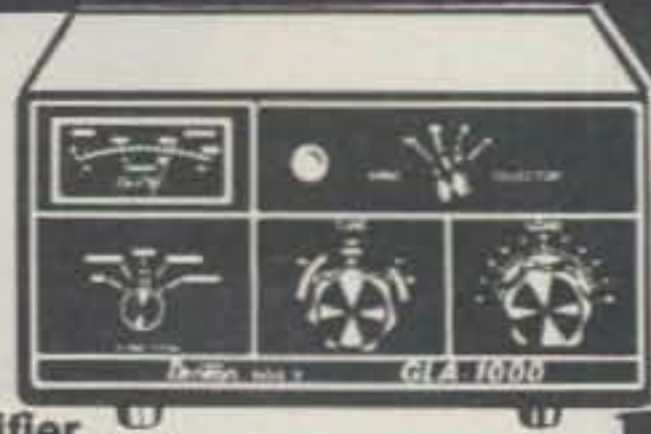

DENTRON GLA-1000 linear amplifier

Freq. coverage 80 to 15 meters, covers most MARS freq., RF drive: Max. 125, power consumption: 117 VAC 50/60 Hz 12.5 Amps, factory fused at 15 Amps, 234 VAC 50/60 Hz 7 Amps, DC input: 1 KW CW and 1200W PEP SSB, Final tubes: 4D-50A tubes (6LQ6).

379.50 List. Call for quote.



DENTRON MT-3000A antenna tuner

Dentron's ultimate tuner! For coax, random wire, and balanced feed systems, built-in antenna selector switch for 5 different antennas, power handling in excess of 3 KW PEP, built-in 50 ohm 250W dummy load, dual watt meters, 3 core heavy duty balun, continuous tuning: 160 to 10 meters.

349.50 List. Call for quote.



DENTRON MT-2000A antenna tuner

A full power tuner with continuous tuning 1.8 to 30 MHz, front panel grounding switch, handles a full 3KW PEP, inputs: unbalanced coax (SO-239 connectors), random wire balanced line, built-in heavy duty balun (3 cores), capacitor spacing 6000V, transforms load imp. to 50-75 ohms.

199.50 List. Call for quote.



DENTRON Super Tuner Plus antenna tuner

Matches any feedline, built-in heavy duty 2 core balun, selectable antenna functions (4 antennas), alternate output, relative output meter, 1000W CW and 1200W PEP SSB, continuous tuning 1.8-30 MHz.

149.50 List. Call for quote.

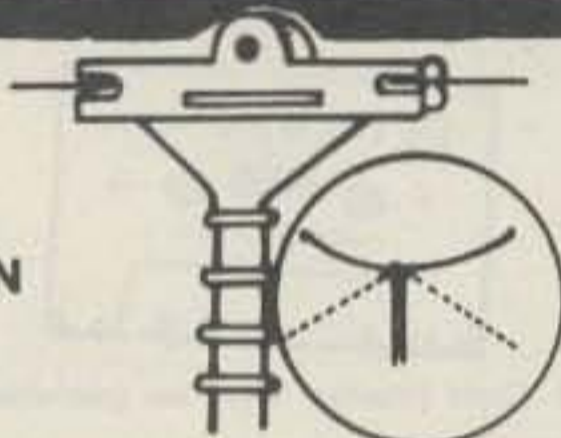

DENTRON All band doublet antenna

Covers 160 thru 10 meters and has a total length of 130' (14 ga. stranded copper) although it may be made shorter. It is center fed through 100' of 470 ohm PVC covered, balanced transmission line. Assembly is complete. Antenna tuner required. Tunes 160 thru 10 with 1 antenna.

24.50 Call today.

BIG BUY!



DENTRON Big Dummy load

Now you can tune-up off the air with the Big Dummy! It has a flat SWR, full freq. coverage from 1.8 to 300 MHz and a high grade of industrial cooling oil furnished with the unit. Fully assembled. Cut out the QRM factor now!

29.50

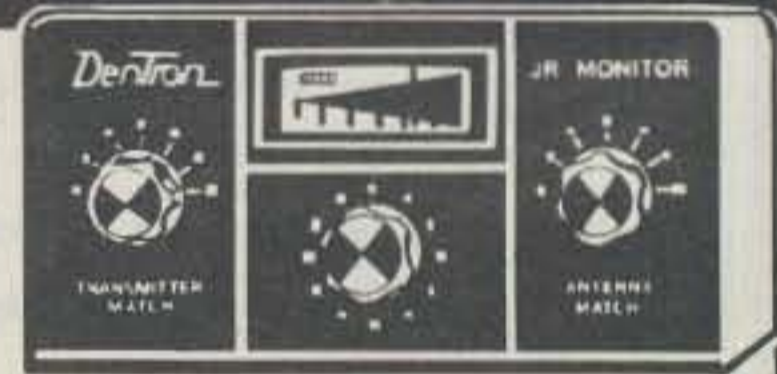

DENTRON Jr. Monitor

Featuring: continuous tuning 1.8-30 MHz, forward reading relative output power meter, 300W power capability, built-in balun, mobile mounting bracket, ceramic rotary switch 23 position, capacitor spacing 1000V, antenna inputs; coax, unbalanced, random wire, balanced feed ling.

79.50 Call today.

ORDER NOW!

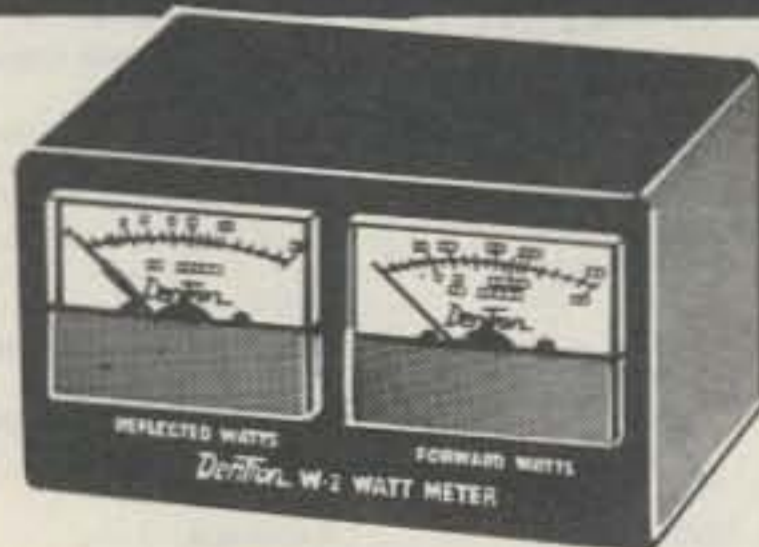

DENTRON W-2 wattmeter

The W-2 lets you read both forward and reflected watts at the same time. Forward watt scale: 2000 or 200, reflected watt scale: 200 watts, low insertion loss, frequency range: 1.8 to 30 MHz, accuracy $\pm 5\%$ has 2 SO-239 connectors, sensor box may be extended 4'.

99.95 List. Call for quote.

DENTRON DTR-2000L 2000W precision linear amplifier



A proven and tested precision linear amplifier. Features a Broadcast proven 8877 tube, freq. coverage 160 thru 15 meters, covers most MARS freq., modes: USB, LSB, CW, RTTY, SSTV, power requirements: 234/117 VAC 50/60 Hz, RF drive power 125W max and 65W RMS min for 1 KW DC input, 1.8-21 MHz 2000W PEP.

1199.50 List. Call for quote.



Long's Electronics



CALL LONG'S TODAY!

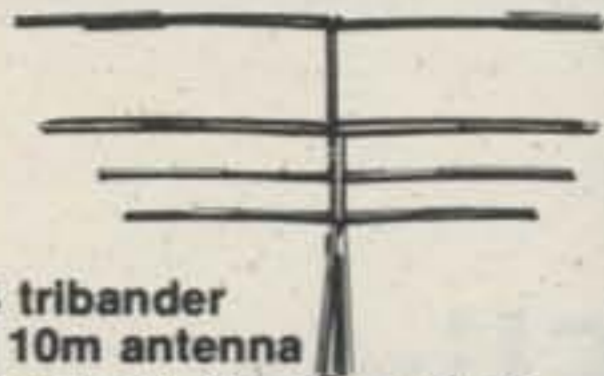

KLM KT-34 tribander 20, 15, and 10m antenna

Frequency coverage: 20, 15, and 10 meters. Gain: 7 dB VSWR: better than 1:51, feed impedance: 50 ohms unbalanced, no. of elements: 4 on each band, power rating: 4KW PEP, wind area: 6 sq. ft., wind survival: 100 mph, turning radius: 15', boom length: 16', longest element: 24'.

349.95 List. Call for quote.

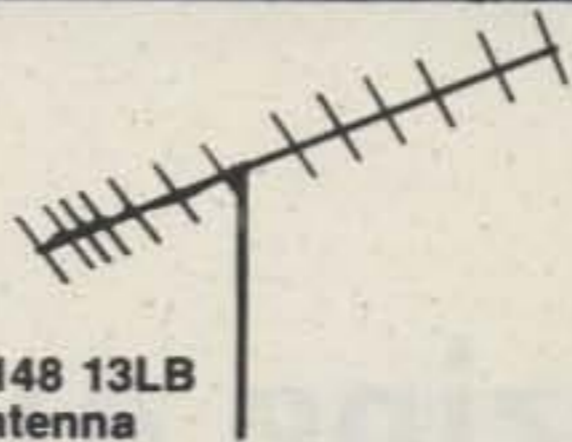

KLM 144-148 13LB 2 meter antenna

Has 13 elements, covers 144-148 MHz, gain: 15.5 DBd VSWR less than 1.2:1, feed impedance: 200 ohm balanced, boom length: 21.5 ft., center mounting, max mast size: 2 ins., 4:1 balun for 50 ohm coax feed supplied with the antenna.

69.95 Call today.

KLM 160V vertical adjustable antenna

A base loaded vertical antenna operates against ground or buried radials to provide operation in segments of the 160, 80, and 40 meter bands. Overall height is 24'. Loading inductor changes the frequency. Antenna is supplied with a bracket. The inductor is enclosed in a protective plastic container.

83.95 Call today.

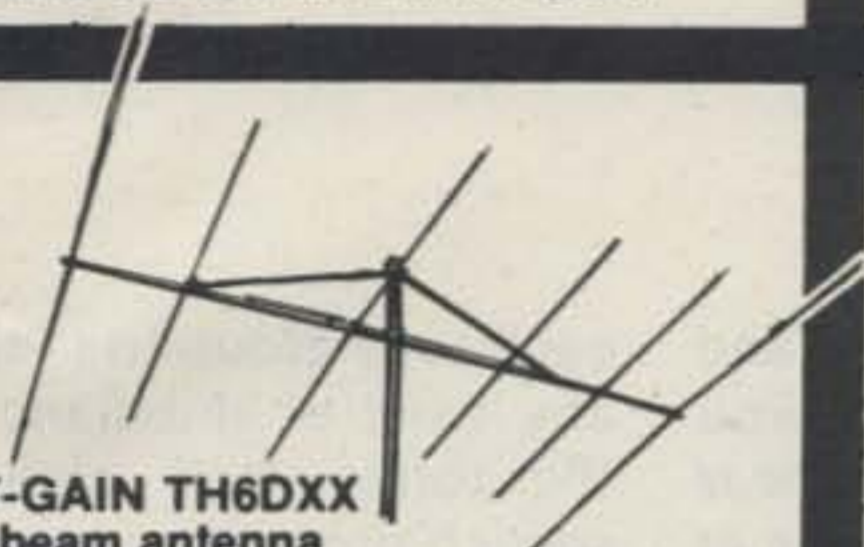

HY-GAIN TH6DXX tri-beam antenna

20, 15, and 10 meters, average gain 8.7 dB, front to back ratio: 25 dB, SWR less than 1.5:1 on all bands, boom length: 24 ft. longest element: 31.1 ft., turning radius: 20 ft., surface area: 8.09 sq. ft., 2000W PEP, balun BN-86 recommended.

329.95 List. Call for quote.



HY-GAIN TH3MK3 tri-band beam antenna

20, 15, and 10 meters, HY Q traps matched for each band, up to 8 dB forward gain, front to back ratio: 25 dB, 1.5:1 or lower SWR at resonance, boom length: 14 ft., longest element 27 ft., turning radius: 15.7 ft., surface area: 5.1 sq. ft., 2000W PEP, balun BN-86 recommended.

229.95 List Call for quote.

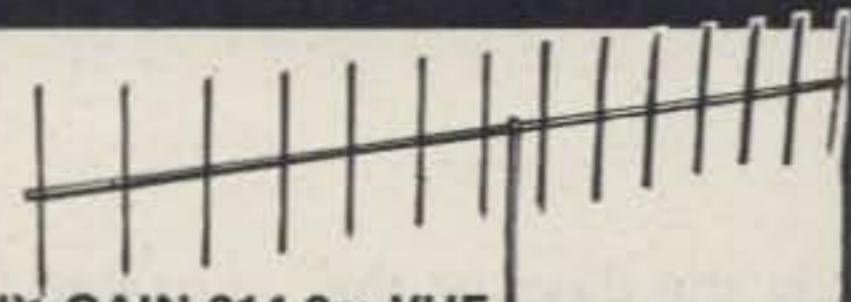

HY-GAIN 214 2m VHF base station antenna

14 elements for 2 meters. Closely spaced elements for exceptionally narrow beam widths, high efficiency coaxial balun-transformer, forward gain: 13 dB, front to back ratio: boom length: 15.5 ft., longest element: 3.3 ft., turning radius: 8 ft., surface area: 1.65 sq. ft., 80 MPH wind survival, band width: 2 MHz, max. power: 250W continuous and 500W PEP.

34.95 Call today.

CUSHCRAFT ATV-5 HF 5 band vertical antenna

Wide operating bandwidth 2:1 SWR bandwidth with 50 ohm feedline is 1 MHz on 10 meters, more than 500 KHz on 15 and 20 meters, 160 KHz on 40 meters, and 75 KHz on 80 meters. Resonance can be adjusted CW or SSB, Coaxial connector takes PL-259. Hgt. 293 inches. 2000W all bands.

109.95 List.
Call for quote.



CUSHCRAFT ATV-4 HF 4 band vertical antenna

Wide operating bandwidth on 10, 15, 20, and 40 meters. SWR is less than 2:1 over the CW and SSB segments of 10, 15, and 20. The 2:1 SWR bandwidth on 40 meters is approximately 240 KHz. Coaxial fitting takes 50 ohm transmission line with PL 259 connector. Overall height 233 inches. Rated at 2000W PEP.

89.95 Call today.



HY-GAIN 14AVQ/WB vertical antenna

This is an 18 ft. antenna that covers 40 thru 10 meters, has 3 separate Hy-Q traps, wide band performance, and an especially low angle radiation pattern. 2000W PEP, Max. wind survival: 80 MPH, input impedance: 52 ohms, SWR less than 2:1, power capabilities: 1 KW, AM, input connector: SO-239.

69.95 Call today.



CUSHCRAFT ARX-2 VHF 2m FM antenna

An omnidirectional antenna with 2 half-wave-length radiators in phase with an eighth-wave matching stub and a low angle of radiation. It's tuneable over a broad frequency range & matched to a 50 ohm feed line. Freq. coverage 137-160 MHz, 2:1 VSWR less than 3 MHz, length: 112", power rating: 1000W.

39.95 Call today.



HY-GAIN 12AVQ vertical antenna

This is a 13½ ft. antenna that covers 20, 15, and 10 meters. It has wide band performance, especially low angle radiation and full circumference clamps at the tubing joints. 2000W PEP. Max. wind survival: 80 MPH, input impedance: 52 ohms, SWR less than 1.5:1, max. power input 1 KW AM, Feed point termination SO-239.

42.95 Call today.

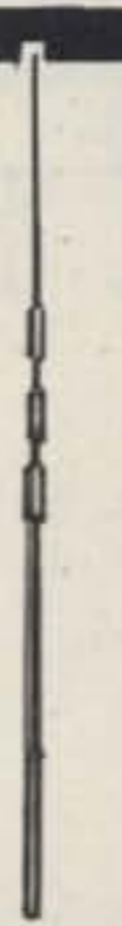

HY-GAIN 18AVT/WB vertical antenna

Covers 80 thru 10 meters, automatic, true ¼ wave resonance on all bands. 25 ft. tall. 2000W PEP, 80 MPH wind survival, SWR less than 2:1, input connectors.

105.95 List.
Call for quote.



1-800-633-3410 TOLL FREE



Long's Electronics



The Amazing Audio Elixir

— this limiting amp is a cure-all

Back in the days of the Old West, there were groups of traveling salesmen who sold snake oil and other cure-alls. The claims made by these people and their medicine shows were that if you bought this wonder elixir, it would cure anything that ailed you. Here is a modern-day electronic circuit which will "cure all that ails you." The circuit presented here is a general-purpose amplifier which can be used to solve many problems and increase the performance of many audio circuits. The unique feature of this amplifier is that it will take an input of 100 mV to 10 V while the output level stays the same. The output is ad-

justable from no output up to about 8 volts peak-to-peak. You are, no doubt, asking what it is used for. Let me describe a few uses which will get your mind working and then you can take it from there.

In a repeater system, a tone decoder is used for control. The tone decoder works best with some precise input level, and the users are always tweaking the pad levels to make their pads work the system reliably. Drop an audio limiting amplifier between the receiver and the tone decoder and the problem is gone. Another use is in an autopatch system. Put one of these little units be-

tween the phone line and the transmitter and you will always be able to hear the person on the phone at the normal level.

For you computer buffs, take this unit and put it between the output of the tape recorder and the tone input to your interface unit and get constant levels even as the tapes age. My 2-meter SSB rig does not have agc in it. When I have the volume high enough to hear a DX station and a local comes on, the level change inverts my speaker cone and my chair (with me in it). I lifted the wire from the top of the volume control and placed one of these units between it and the volume control. Now all the stations come out at the same level, at whatever level the volume control is set, and there is no more ear damage for me.

I know of one person who set up a room microphone and used this unit to record anyone talking in the room without moving the microphone or having to ride the tape recorder's input control. With touch-tone™-type signals, place a group splitting filter in front of two of these units and independently level

each tone group to remove any twist or imbalance in the tones. How about a speech processor? Use this unit in a fast-agc mode and drive the input to your SSB rig at full level all the time. Another use might be as a "linear clipper" in a modulator. Drive the unit below the point where the output limits, and if the signal through it gets too high, the limiter cuts back and won't allow excess audio to pass. The advantage of this unit over normal clipping methods is that this unit does not clip, and thus it does not add clipping distortion. Enough of these ideas. Let's go on to see how it works.

How It Works

See Fig. 1. U1 is an op amp and is simply a gain block. The gain of U1 is set by the values of R4 and R6. As shown, the amplifier is set for a gain of about 200. The output is sampled by C3, CR1, CR2, and C4. This network produces a dc voltage directly related to the ac (audio) output of the amplifier. This dc level is fed to the gate of FET Q1, which is an inexpensive Motorola MPF111. This FET is not critical and any

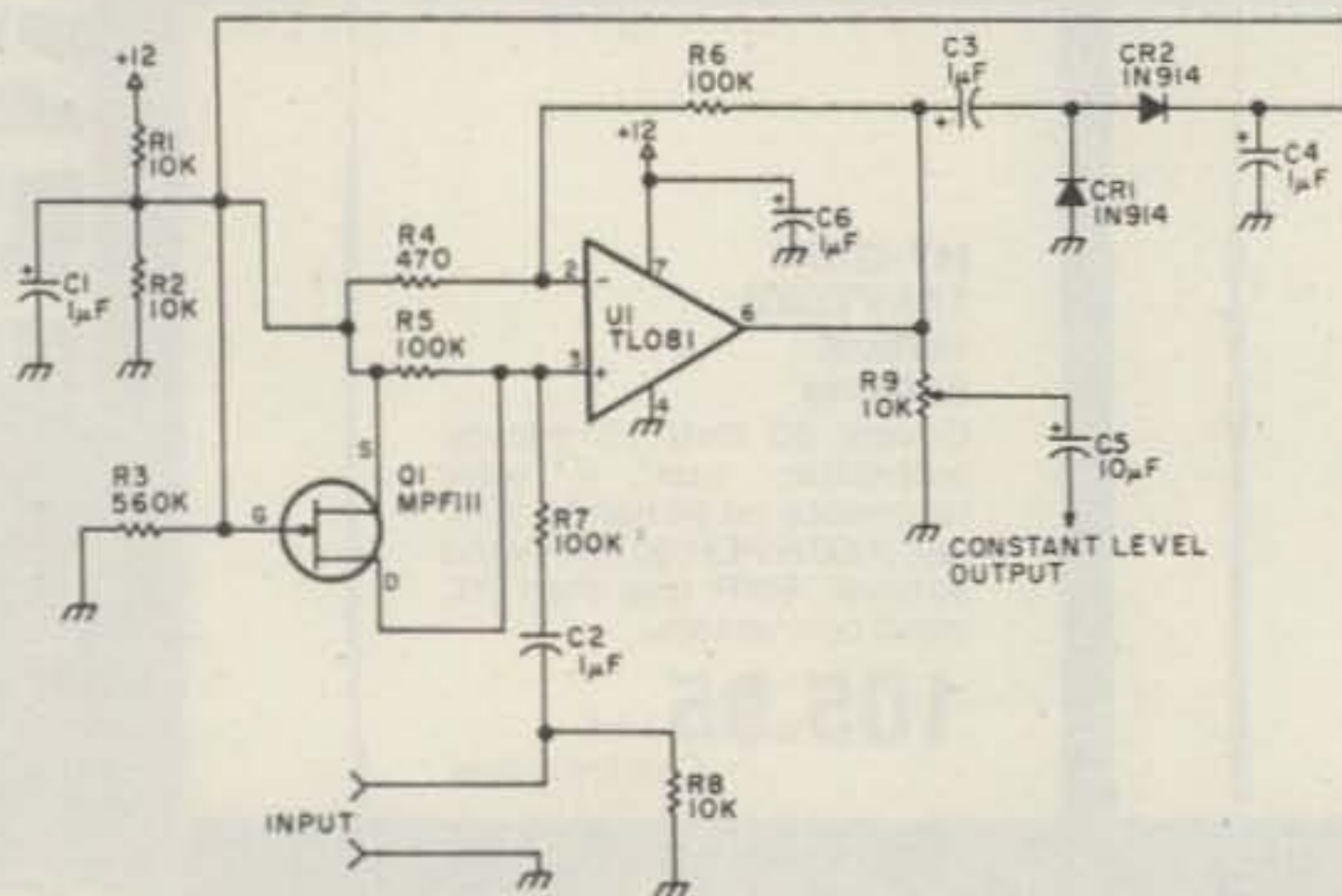

Fig. 1. Audio-limiting amplifier diagram. (This diagram is supplied with printed circuit boards.)

equivalent FET will do. R1 and R2 form a voltage divider which is used to bias the FET source and the op amp inputs at a point exactly one-half way between the power supply voltage and ground. C1 ensures that the bias point is at ac ground. With no detected voltage from C4 to the gate of Q1, the gate of Q1 is at ground, which is negative to the source, and the FET is in a "pinched-off," or nonconducting, condition.

The incoming signal comes in through R7 and is amplified by U1. The output is detected and the dc voltage is fed back, which lifts the gate of Q1 from ground and Q1 starts to conduct. As Q1 conducts more and more, it shunts the input signal away from the op amp input. R7 and R5 act as a voltage divider and, with the FET, R5 acts as a variable resistor. The combination acts as an elec-

tronically-operated pot, with the "wiper" connected to the input of the amplifier. Once the detected output reaches a certain level, it will cut back the input signal and not allow the output to go any higher.

The purpose of C2 is to block the bias voltage from going out the input. R8 is used only to terminate the input and should be a value that the driving circuit wants to see. It can be any value because it has no effect on the operation of the circuit. Since U1 is a closed-loop amplifier with a fixed gain, the output will drive anything as long as the output capabilities of the op amp are not exceeded. Even though there is some circuit loading, I have even driven small speakers with this unit and obtained output volume which was usable for testing purposes. The amplifier is protected so you do not

need to worry about damage.

This unit is designed for 12-volt operation, which is near its lower operating voltage limits. The voltage is not critical, and as long as the voltage limits of the capacitors are not exceeded, it will work over a wide range of voltage. The lower limit is 12 volts and the upper limit is greater than 30 volts. If different agc release times are desired, the value of R3 may be changed. The larger the value of R3, the longer, or

slower, the recovery time of the amplifier. When used as an agc, it has a fast attack time and a fast decay with the values shown.

In conclusion, this article was meant to be mostly an idea article and describes a building block which I have found to be very useful. Circuit boards may be obtained from the author for \$3.50 each and are top-quality glass-filled, drilled boards with silk-screened parts layouts on the surface. ■

Parts List

Designation	Description	Qty.
U1	TL081 BiFET op amp	1
Q1	MPF111 FET	1
CR1, CR2	1N914 signal diode	2
R4	470-Ohm, 1/4-Watt, 5% resistor	1
R1, R2, R8	10k, 1/4-Watt, 5% resistor	3
R5, R6, R7	100k, 1/4-Watt, 5% resistor	3
R3	560k, 1/4-Watt, 5% resistor	1
R9	10k pot, multi-turn variable resistor	1
C2	.1-uF mylar™ capacitor	1
C1, C3, C4, C6	1-uF electrolytic capacitor	4
C5	10-uF electrolytic capacitor	1
	PCB	1

SENIOR CITIZENS DISCOUNT

SENIOR CITIZEN WE ARE DECLARING WAR ON INFLATION & HIGH PRICES. WE FEEL IT'S TIME WE HELP THOSE WHO CAN LEAST AFFORD THE UPWARD CLIMB OF RISING PRICES. STARTING THIS MONTH AND EACH THERE AFTER WILL BE SENIOR CITIZEN DISCOUNT DAY AT BRODIE ELECTRONICS. IF YOU ARE 60 YEARS OLD OR OLDER WE WILL GIVE YOU A SPECIAL DISCOUNT ON ANY PURCHASE FROM OUR STORE. ALL YOU NEED FOR THIS SPECIAL SAVINGS IS A VALID IDENTIFICATION.

MAIL US PROOF YOU ARE A SENIOR CITIZEN ALONG WITH WHAT YOU DESIRE AND WE WILL BY RETURN MAIL SEND YOU YOUR SPECIAL SENIOR CITIZEN DISCOUNT SAVINGS QUOTE.

CHECK PREVIOUS 73 MAGAZINE ADDS FOR OUR LINES OR JUST WRITE.

BRODIE ELECTRONICS COMPANY

2537 Edgewood Drive ✓ B42
Moore, Okla. 73160
405-794-0406

No More Rotary Switches!

— gadget freaks will love these solid-state replacements

D. N. Ellis WA2FPT
R. D. 1, Box 108A
Ulster Park NY 12487

Are you bored with rotary switches in your projects? Even if by some slim chance you are not, here are a few simple remedies for replacing those tiresome rotaries with a sequentially-stepping counter that lights one of a string of LEDs each time a push-button momentary switch is pushed.

The cost of such a system is about as much as

you would pay for a new rotary switch, but the main attraction is that it makes that "electronic wombat finder" of yours a real eye-catcher that is fun to use.

The devices described here are primarily CMOS, because I am a devoted CMOS fanatic. With proper attention to the pertinent peculiarities, however, any other logic family will work well.

A two-position, two-deck rotary switch eliminator is shown in Fig. 1. The switch portion of the circuit is a set-reset flip-flop that gives clean, bounceless low-to-

high transitions to clock the counter. The counter is a 4013 D-type flip-flop wired as a toggle. It divides the incoming clock frequency by two and transfers data from the D input to the Q output on the positive edge of the clock pulse. Each push of the button puts a low to high signal at the clock input. With CMOS, these levels are essentially ground and the supply voltage. We will call these low and high levels "0" and "1" for clarity.

The characteristics of a D-type flip-flop wired as a

toggle, with the \bar{Q}_1 output fed back into the D input, is that for every 0 to 1 transition on the clock input, the Q output changes, and then remains at that value until the next positive going clock pulse comes along. This means that it has two stable conditions. If the Q output was at a 1 level, then a single push of the button would change it to a 0. The next push would send it back to a 1. The Q output does the same, but, of course, is of the opposite polarity.

As each of these outputs assumes a 1 level, it will turn on its LED driver, the 75492. The 75492, which has six drivers per package, is a power amplifier to supply the current requirements of the LED. The LEDs current is limited by a resistor whose value will be determined by the supply voltage and the desired current. A reasonable formula for such calculations is given in Fig. 1.

Speaking of power, CMOS works fine on 3-15 volts, but the 75492, a bipolar device with CMOS compatible inputs, is limited to 10 volts. Anyway, whichever one of the outputs, Q or \bar{Q} , is at a 1 level will cause the 75492 driver

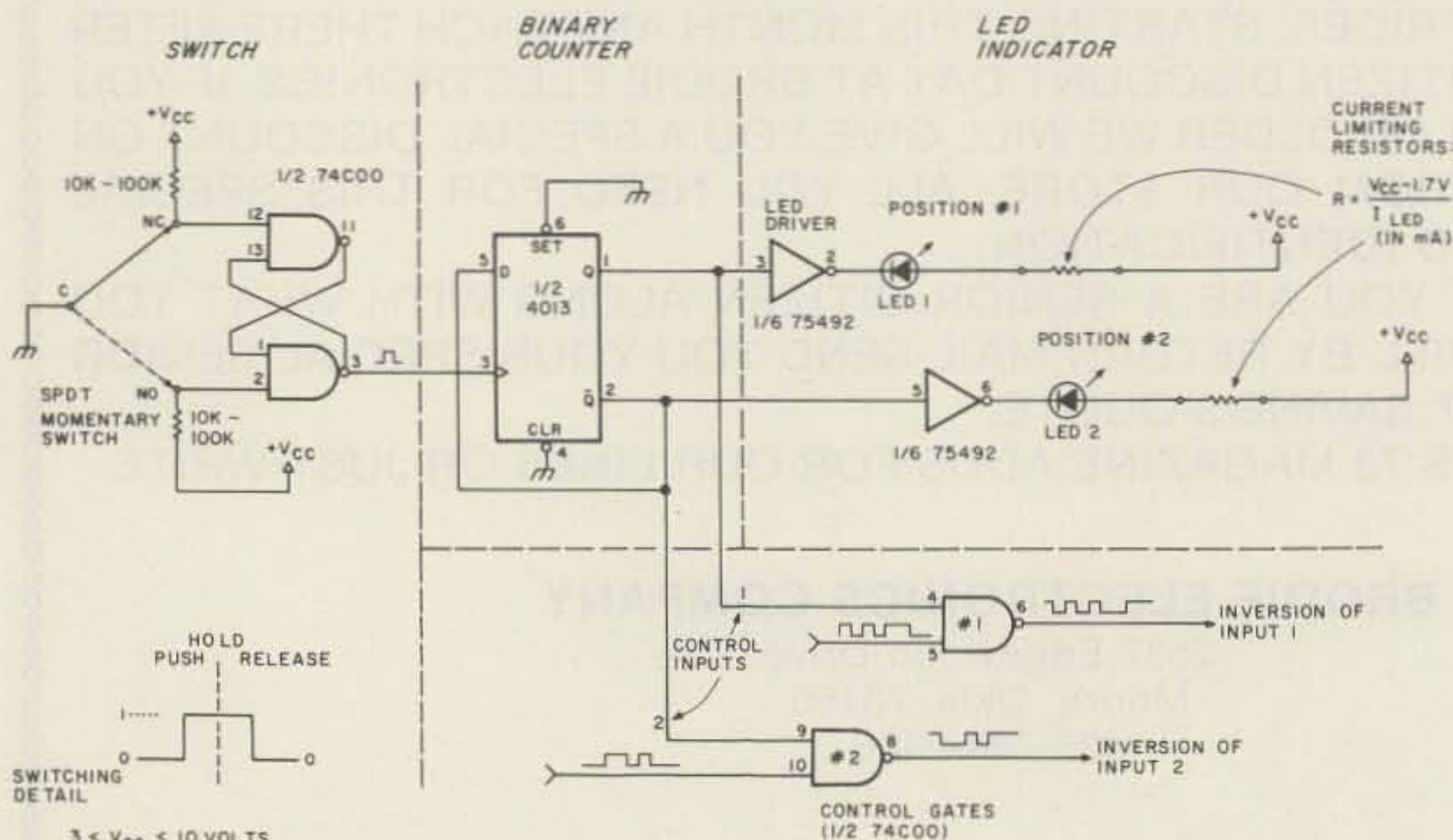

Fig. 1. Two-position rotary switch eliminator.

to go low, which will forward bias the LED, turning it on.

So much for the indicator, but what will it indicate? We need our switch to control something. This is accomplished by the remaining 74C00 2-input NAND gates labeled Control Gates. This section of the circuit is the second "deck" of our two-deck switch eliminator.

A 1 from either the Q or \bar{Q} flip-flop at one input of the 74C00 will allow an inverted replica of a signal at the other input to pass through the device. A 0 at the control input will keep the output at a 1 level regardless of the condition at the other input. As the button is pushed again, the control is shifted to Control Gate 2 and Control Gate 1 is disabled, remaining at a 1 level.

Because of the binary nature of toggle flip-flops, any number of switch positions that is a power of two can be readily made by cascading these binary dividers until the desired number of stages is reached.¹

A four-position rotary switch eliminator is shown in Fig. 2. With these two flip-flops come a possible four combinations of the Q outputs, Q_A and Q_B . They are 0,0; 1,0; 0,1; 1,1. The next sequences are only repetitions of the first. The sequence is as follows: Assume both Q_A and Q_B are at a 0 level. After the button is pushed once, Q_A goes to a 1, but Q_B is still at a 0 level. So far the count sequence is 0,0; 1,0. The next push gives a 0 at Q_A , but now Q_B goes to a 1. The sequence is now 0,0; 1,0; 0,1. The third push of the button flips Q_A to a 1, but because Q_B changes only half as often, it remains a 1. The sequence is now complete: 0,0; 1,0; 0,1; 1,1. The next push would cause Q_A and Q_B to become 0,1.

Now we have to decode

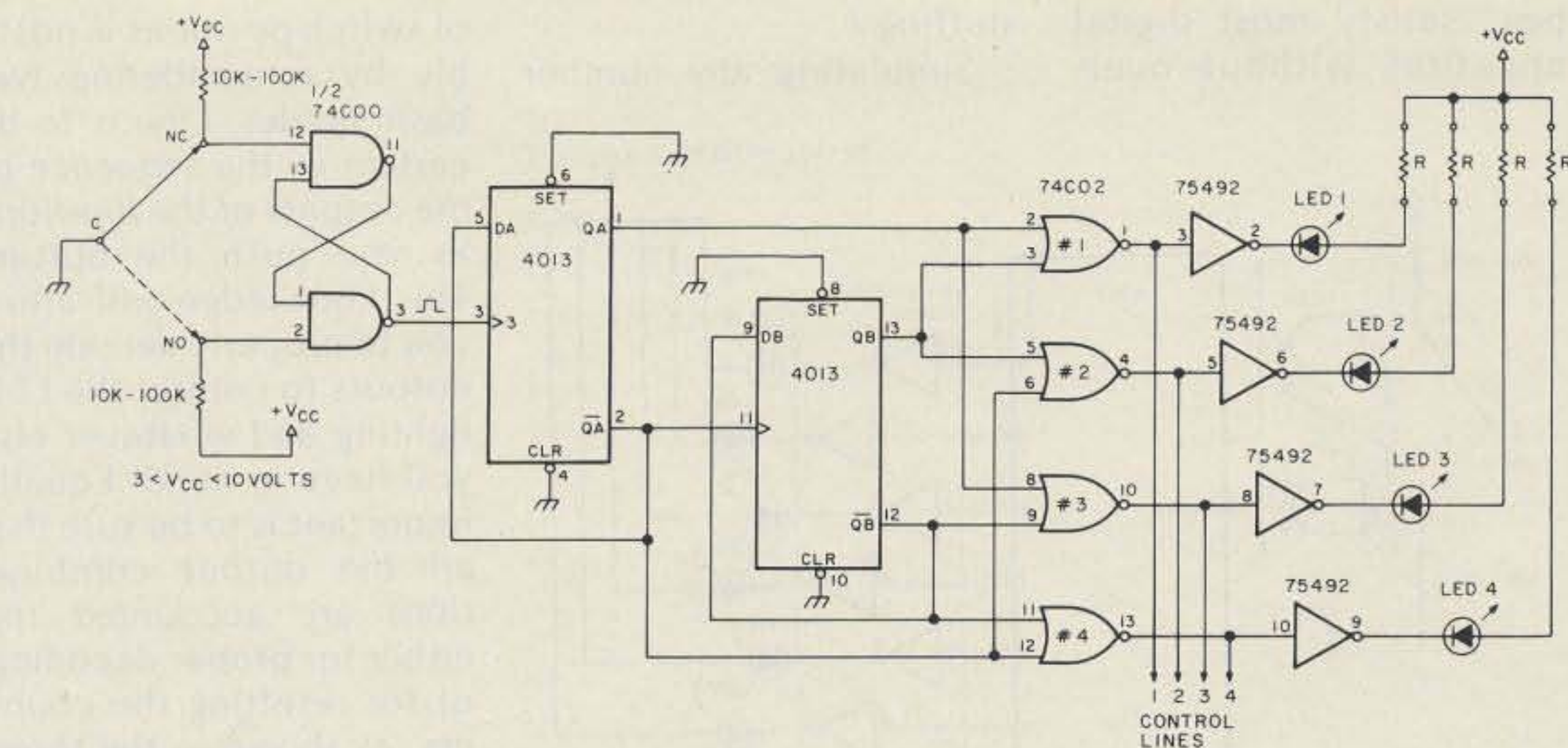

Fig. 2. Four-position rotary switch eliminator.

each of these pairs of outputs to light four LEDs in sequence, one at a time. The 74C02 quad 2-input NOR gates do this trick neatly.

The NOR gate is a great "zero detector" because it will give a 1 output only when all of its inputs are at a 0 level. The NOR gate fed directly with Q_A and Q_B would output a 1 level only when the count of 0,0 was reached, turning on the 75492 LED driver, illuminating LED 1. The next state in the count sequence is 1,0. This will extinguish LED 1 because the 74C02 no longer has the conditions required to turn on LED 1.

For LED 2 to turn on, we can use Q_B directly because it is a 0 level. Instead of Q_A , though, we'll use \bar{Q}_A , which is a 0 when Q_A is a 1.

Now 74C02 #2 has the proper zeros on the inputs to give a 1 output to turn on LED #2. The next state of the counter results in a Q_A of 0 and a Q_B equal to a 1 level. 74C02 #3 will be activated by using Q_A and \bar{Q}_B , the exact opposite from the requirements for 74C02 #2.

The final push gives a 1,1 condition, which needs both \bar{Q}_A and \bar{Q}_B to be used as 0 inputs to 74C02 #4 to turn on LED #4.

So much for a four-position switch, but how about an odd number like three? What we'll do is to start with a four-position switch and use the fourth state of 1,1 to reset the circuit back to 0,0. The counter will think it is still a four-position counter, and only we will know the difference.

The three-position rotary switch eliminator is shown in Fig. 3. The significant difference between it and the four-position counter in Fig. 2 is that the 74C02 #4, which detects and decodes the 1,1 condition, is used to reset both halves of the 4013 to zero, giving a count sequence of 0,0; 1,0; 0,1, and back to 0,0.

The point of this decoding business is to ensure that each and every combination of counter outputs results in only one LED on at a time. Otherwise, we will have the equivalent of a rotary switch with shorted contacts.

If you are interested in readable, useful information on counters, try one or more of Don Lancaster's *Cookbooks*. The "reci-

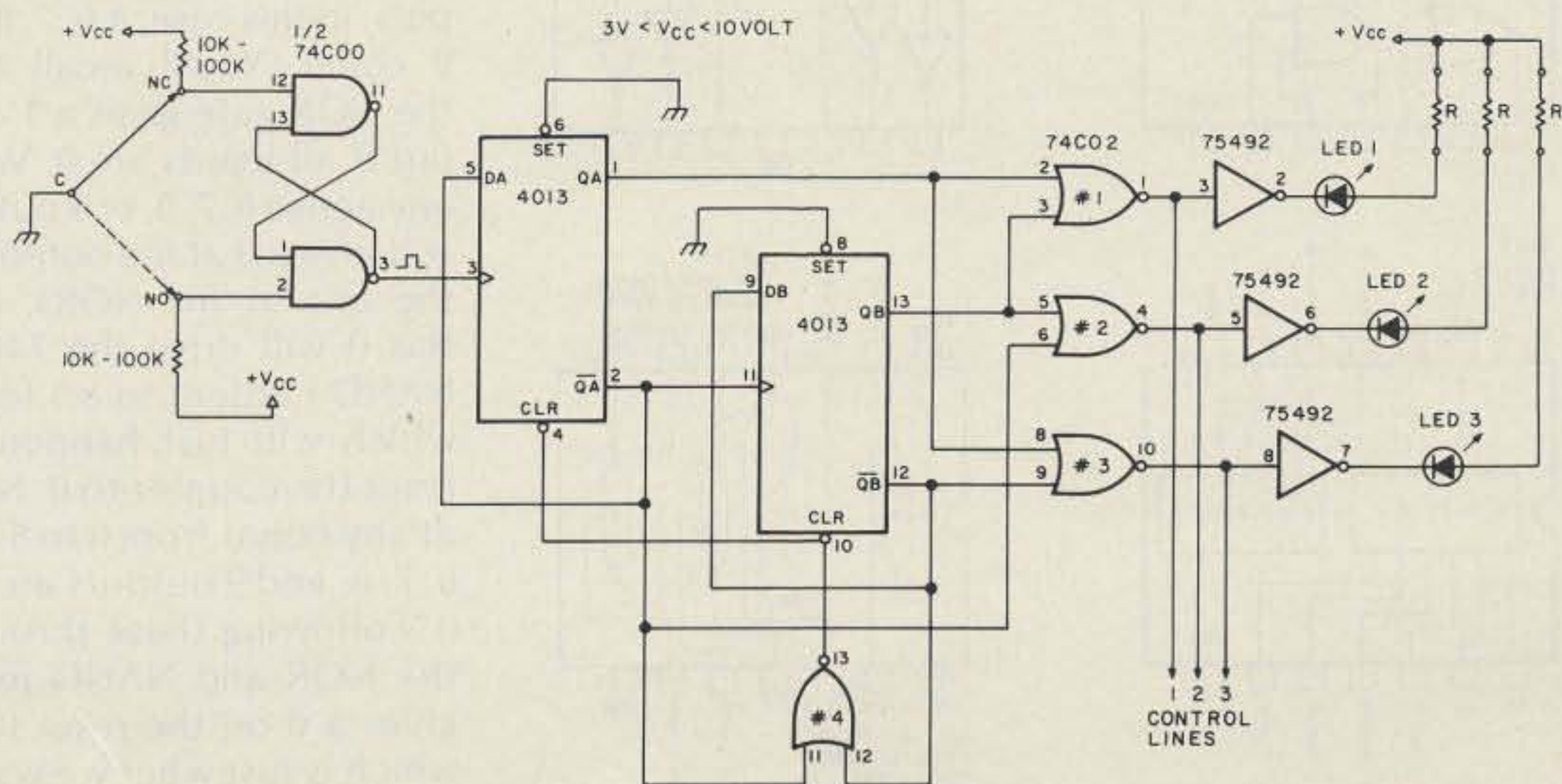

Fig. 3. Three-position rotary switch eliminator.

pes" satisfy most digital appetites without over-

stuffing.² Simulating any number

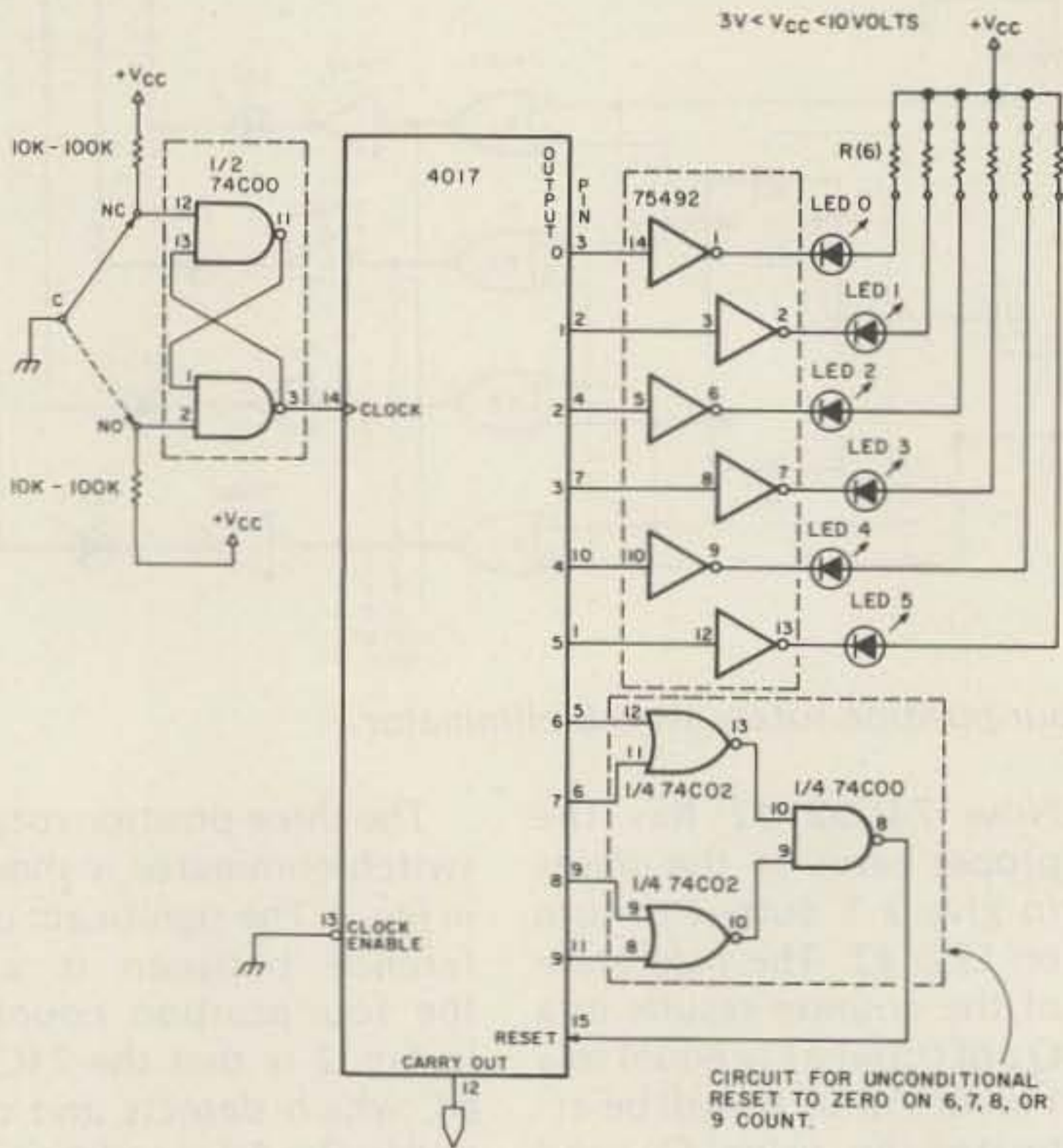

Fig. 4. Six-position rotary switch eliminator using a 4017 decade counter.

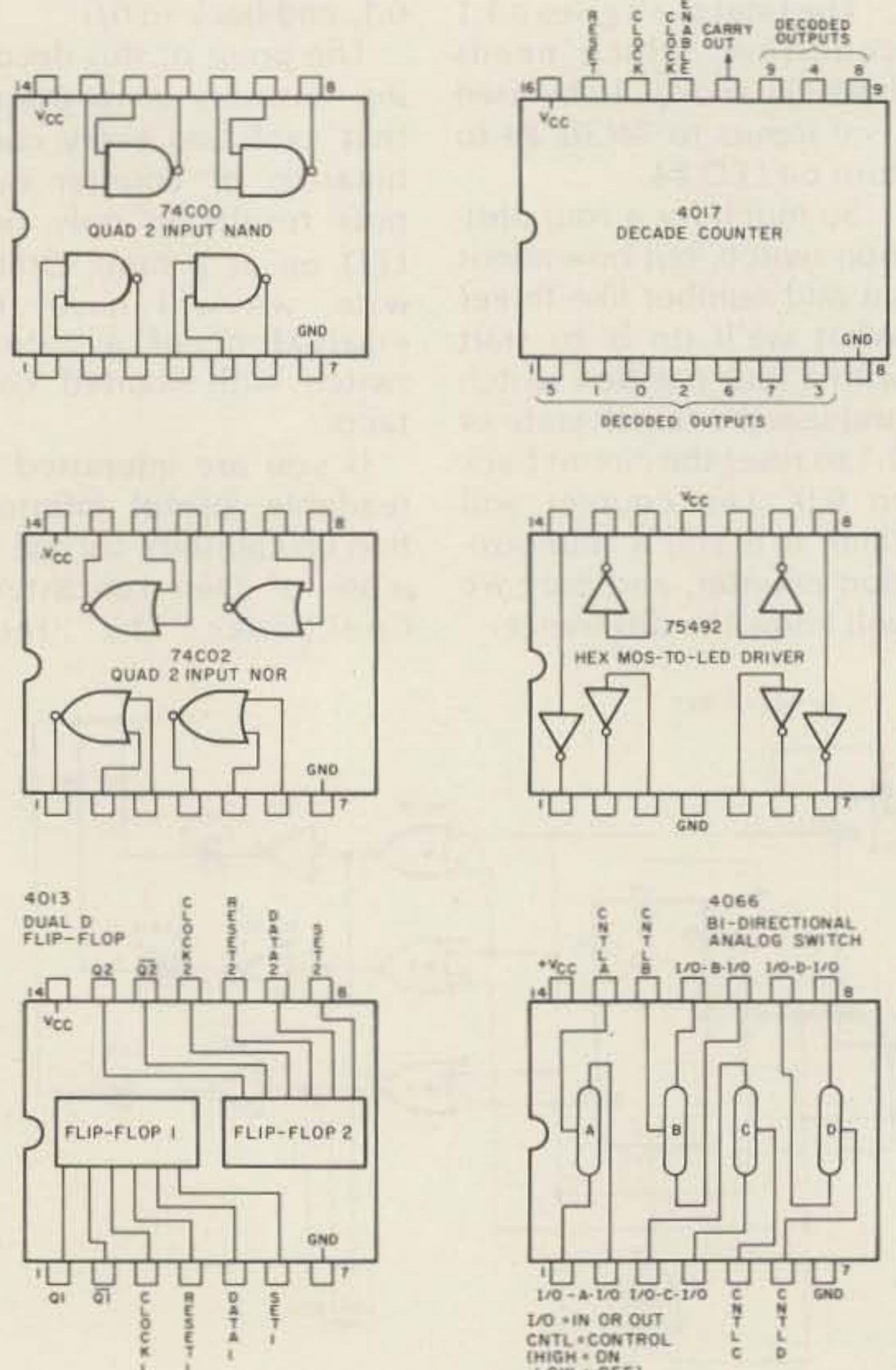

Fig. 5. Pinouts of the ICs used (top view).

of switch positions is possible by remembering two basic guides. One is to be certain of the sequence of the outputs of the flip-flops as you push the button. This knowledge will allow you to properly decode the outputs to control the LED lighting and whatever else you have in mind. Equally important is to be sure that all the output combinations are accounted for, either for proper decoding, or for resetting the counters, as shown in the three-position counter. Any combination you miss will at best give the effect of a dead switch position, or, as previously mentioned, a shorted switch.³

An easy way to avoid concerning yourself with much of the above trouble is to use a resettable counter like a 4017. Any number of switch positions from 1 to 10 can directly be implemented. The 4017 is a five-stage divide-by-ten Johnson counter with ten unique decoded outputs. Johnson must have been clairvoyant, because this sixteen-pin package is just what we need.

The example in Fig. 4 is a six-position rotary switch eliminator. This circuit will count from 0 to 5, then start over again with successive pushes of the button. The two 74C02 gates and the 74C00 gates eliminate any hazard of unwanted outputs, in this case, a 6, 7, 8, or 9 count. You'll recall that the NOR gate gives a 1 output if all inputs are 0. Well, any active 6, 7, 8, or 9 output will give a 0 at the output of the one of the NORs, and this 0 will drive the 74C00 NAND's output to a 1 level, which will just happen to reset the counter to 0. Now at any count from 0 to 5 the 6, 7, 8, and 9 outputs are all 0. Following these through the NOR and NAND logic gives a 0 on the reset line, which is just what we want, that is, no reset until a 6, 7, 8, or 9 appears. The 0

through 5 outputs control the lighting of their respective LEDs through the six gates of 75492 package. These lines can also be used to control other functions, as in Fig. 1. Easy enough. The 4017 also has a carry out, which allows cascading 4017s together for long count sequences. More components, a little imagination and a calloused index finger are the only requirements.

So far, only digital controls have been discussed. By using 4066 bi-directional analog transmission gates, low level analog (or digital) signals up to 40 MHz can be faithfully controlled with minute distortion. Just substitute 4066s for the 74C00 Control Gates as in Fig. 1. Pinouts for all the devices mentioned are shown for reference in Fig. 5.^{4,5}

As an extra attraction, these circuits also have built-in service aids. The LED indicators can act as diagnostic pointers by "illuminating" your logic and/or wiring errors. With all this in mind, "switch" to these rotary eliminators for your current and future projects. If you have the capacity, I'm sure you'll get a charge from designing and building them. You, too, can be the envy of friends and rivals alike! If I have etched them into your memory, then they will certainly be difficult to resist. ■

References

1. *TTL Cookbook*, Don Lancaster, pp. 207, 218; Howard W. Sams & Co. Inc., NY, 1976.
2. *Op. Cit.*, preface.
3. *Design of Digital Computers*, H. W. Gschwind and E. J. McCluskey, pp. 171-172; Springer-Verlag, NY, 1975.
4. *CMOS Databook*, National Semiconductor Corp., 2900 Semiconductor Dr., Santa Clara CA 1977, pp. 1-3, 2-29, 2-45, 2-150.
5. *Interface Integrated Circuits*, National Semiconductor Corp., 1975, p. 6-79.



S-f Amateur Radio Services

(213) 837-4870

4384 KEYSTONE AVE.,

CULVER CITY, CA. 90230

the W6TOG ✓S33

- RECEIVER MODIFICATION KITS
- INCREASE SELECTIVITY
- IMPROVE SENSITIVITY
- LOWER INTERNAL NOISE
- COMBAT BLOCKING FROM LOCAL SIGNALS

TS-520 KIT	\$27.50
TS-520S KIT	32.50
TS-820 & 820S KIT	34.50
TS-820 MIXER KIT	27.50
TS-120S KIT	32.50
R-820 KIT	34.50
FRG-7000 KIT	32.50
FT-101 SERIES KIT	32.50
FT-101ZD KIT	34.50
FR-101 SERIES KIT	34.50
FT-301 SERIES KIT	34.50
FT-901 SERIES KIT	34.50
ATLAS-210 OR 215X KIT	34.50
ALDA-103 OR 105 KIT	32.50

MAGICOM PROCESSOR MODIFICATION KIT

INCREASES AUDIO PUNCH
IMPROVES
PROCESSED SPEECH QUALITY
Converts TS-820 / 820S
speech processor
from RF compressor to RF clipper
\$27.50

RF speech processor / clipper for TS-520 / 520S \$42.50

The "MAGICOM" provides up to 6dB increase in output with smooth, clean, non-distorted audio and more penetration for those pile-ups. Easy installation. (No front panel alteration)

HI POWER KITS

INCREASE OUTPUT POWER BY 30%
Set of (2) 6293 pulse amplifier tubes
(Direct replacement for 6146 tubes)

GET MORE DRIVE FOR
THOSE HI POWER AMPLIFIERS!!!
TS-520 / 520S QRO KIT \$41.50
TS-820 / 820S QRO KIT 41.50

10% OFF ON KIT ORDERS
TOTALING \$75.00 OR MORE

AUTHORIZED DEALERS FOR

- KDK-FM 2016 A
- WANECO 1040RCW/SSB
- AUDIO PROCESSOR FILTER
- NYE VIKING PHONE PATCHES
- W2AU/W2VS ANTENNA KITS
- AHF MOBILE ANTENNAS

SEND FOR PRICING AND INFORMATION

ALL PRICES POSTPAID
IN CALIF. ADD 6% SALES TAX
MASTERCARD & VISA ACCEPTED
SATISFACTION GUARANTEED
OR MONEY REFUNDED

Completely Free Standing Towers

TELE TOW'R

PAT. NO.

4,151,534

40' MODEL

Model 40 (extends from 21' to 40') List \$259.10
Breakover Model 40 (extends from 23' to 40' with breakover at ground level) List \$440.62

55' MODEL

Model 55 (extends from 21' to 55') \$473.97
Breakover Model 55 (Extends from 23' to 55' with breakover at ground level) List \$661.75

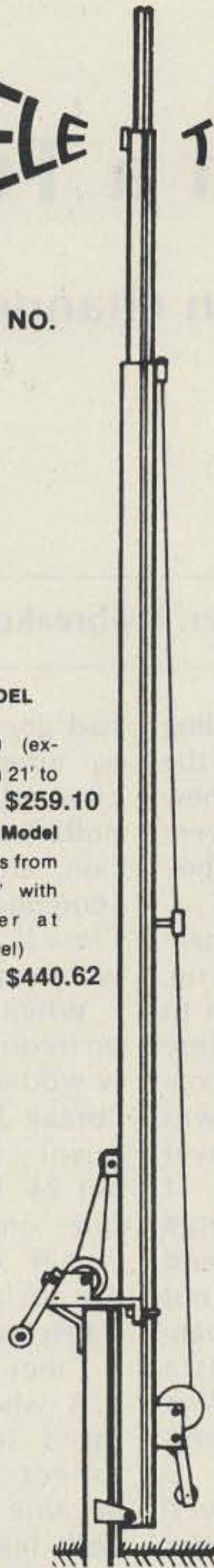

All steel constructed.
Concrete sleeve available for all models.

TELE-TOW'R MFG. CO., INC.
P.O. Box 3412 • Enid, OK 73701
405-233-4412

IC Keyer

The World's Greatest Sending Device

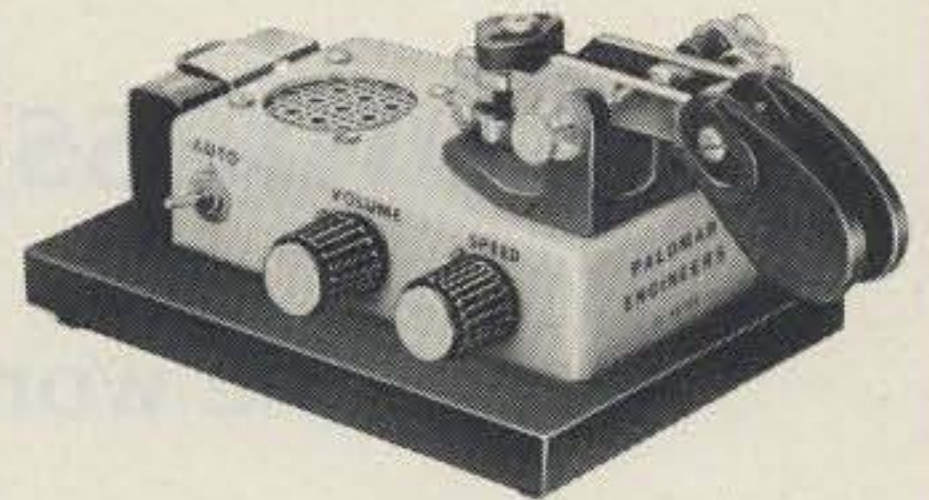

Adjustable to Any Desired Speed

Now available from Palomar Engineers — the new Electronic IC KEYER. Highly prized by professional operators because it is EASIER, QUICKER, and MORE ACCURATE.

It transmits with amazing ease CLEAR, CLEAN-CUT signals at any desired speed. Saves the arm. Prevents cramp, and enables anyone to send with the skill of an expert.

SPECIAL RADIO MODEL

Equipped with large specially constructed contact points. Keys any amateur transmitter with ease. Sends Manual, Semi-Automatic, Fully Automatic, Dot Memory, Dash Memory, Squeeze, and Iambic — MORE FEATURES than any other keyer. Has built-in sidetone, speaker, speed and volume controls, BATTERY OPERATED, heavy shielded die-cast metal case. Fully ADJUSTABLE CONTACT SPACING AND PADDLE TENSION. The perfect paddle touch will AMAZE you.

Every amateur and licensed operator should know how to send with the IC KEYER. EASY TO LEARN. Sent anywhere on receipt of price. Free brochure sent on request.

Send check or money order. IC KEYER \$97.50 in U.S. and Canada. Add \$3.00 shipping/handling. Add sales tax in California.

Fully guaranteed by the world's oldest manufacturer of electronic keys.

ORDER YOURS NOW!

Palomar Engineers

Box 455, Escondido, CA. 92025

Phone: [714] 747-3343

Confessions of a Teenage HFer

— the world between channel 40 and 28 MHz

"Breaker, lawbreaker!"

Hans Peter
c/o 73 Magazine

In August of 1975, while I was a long-term patient in the hospital, I received an AM mobile transceiver. This was before the FCC changed the Part 95 regulations to allow idle chitchat one month later. I did not receive my FCC call letters until October, two months later, but of course I transmitted before then.

Roll Your Own

On all crystal-synthesized 23-channel CB rigs, there was a blank spot between channels 22 and 23. It was normally an inoperable channel that, I thought at the time, was the position to use when using the PA function. After meeting a few other CBers and discussing equipment, I learned that on a few rigs, by setting the dial between the blank spot and channel 23, it was possible to "roll in" a non-CB channel, commonly called 22A. There was also another channel called 22B, but this channel could

only be installed by adding at least one crystal to the rig. No one really knew what these channels were for, but supposedly they were business channels.

I could not roll this channel in on my particular rig, so I wired in 2 switches to connect where the rotary switch was not making contact. It worked, and I was very excited to discover this modification. It seemed that most people thought that if you could not roll it in, then it was not possible to get this channel. At that time it was a quiet channel and at first only a few "elite CBers" had it.

I did read in an advertisement for an 11 meter vfo that 22A and B were for business traffic, but I never did hear any, and I could not find anything about this in FCC rules and regulations.

I also started modifying other CBers' radios to get this channel. It could be done by cutting a ground wire, or adding a jumper wire, or installing a toggle switch if the manufacturer

had gone to great lengths to internally defeat this channel. I charged five dollars to do this modification, although I knew of someone else with a First Class license who charged twenty dollars.

When people would get on frequency, they generally would say "break A" or "break 22A." Now this frequency has become channel 24. If you hear someone on the air saying "break A," they probably are using a 23-channel transceiver.

I met another fellow on 22A who was also interested in the electronic aspect of CB, and we became good friends. We both learned as much as we could about radio modification. We also did radio work for other CBers.

Moving Up

I eventually moved on to bigger and better things, namely getting into the HF aspect of 11 meters.

I studied my crystal synthesizer and eventually figured out that by changing two master crystals I

would get 23 channels just above the class D channels. At first I had no idea where to get these crystals made. Finally, in a CB catalogue, I saw I could order crystal certificates and have the crystals made. I thought perhaps the company I sent the certificates to would not grind the crystals for me because they would result in out-of-band operations, but this did not happen.

After about 3 months of waiting, the crystals arrived. I thought that by just unplugging the original master crystals and plugging in the new ones, I would be all set. However, only the transmitter would work. The receiver was dead. I eventually found out I had to retune the synthesizer cans for each set of master crystals. But it did work and I got HF capabilities. Later, I tuned the receiver for a happy medium so both sets of crystals worked, but the receiver performance suffered and I got all kinds of receiver images.

CB shops eventually

started selling HF synthesizer crystals. These would give 4 or 5 new channels per crystal. They were hot items and sold out quickly. Very few CBers even knew how to wire in these crystals, and here I was of service. The crystals sold for five dollars. I would install a 2-pole toggle switch with one empty socket and an HF crystal for twenty dollars.

Gadgets

CBers are almost helpless when it comes to doing even simple modifications or repairs. Even when a microphone cord needs to be resoldered or a CBer buys a preamplified mike, he has to pay someone to fix or install it. This lack of technical knowledge leaves CBers open to many rip-off artists. I have seen standing-wave meters advertised as 40-channel standing-wave meters, as if the ones manufactured during the days of the 23-channel sets were inferior.

I have seen an item called a crystal vfo. What is it? It's a little box with a twelve-position rotary switch connected to twelve crystal sockets with a trimmer cap for each socket. Theoretically, one of these could give a crystal-synthesized transceiver 60 new channels. All this for only \$100, less the crystals.

Other items in demand are tweety birds and pingers. The pinger produces a short feedback-like squeal of short duration when the microphone is keyed. The Browning Golden Eagle had this built in. Because of pressure from the FCC, the new 40-channel Brownings do not have this feature. It can easily be added because the pinger is still in the radio but is not connected when the set comes from the factory. Pingers are now sold as add-on units by

an independent firm for about \$18. These can be attached to any radio.

The tweety bird produces a chirping sound. They are often used to attract attention, but can cause severe bleed-over on adjacent channels. Prices for tweety birds are around \$15 to \$20. There are full page ads for both of these noisemakers in CB magazines, even though they are prohibited by Part 95 of the FCC rules and regulations.

Regular tunable 11 meter vfos are made which plug into one of the crystal sockets in the transceiver's synthesizer. There are two very popular models.

One, made by Siltronix, has a simple two-transistor LC circuit and is inclined to drift unless the unit is left on continuously. Few CBers know that these can be adapted to any transceiver by adding or subtracting some capacitance to or from the LC circuit. The other popular model is made by PAL. These are rather complex and use a crystal-controlled reference oscillator.

I have seen used units at hamfests going for \$175 to \$200, which is the same as the retail price. The funny part about eleven meter vfos is that in advertisements it specifically states that it is illegal to transmit with vfos, as if that will stop anyone. I charged \$20 to install a vfo. I arranged it so the vfo could be disconnected from the transceiver, for obvious reasons.

The clarifier on a single sideband set could be modified into a quasi-vfo by changing some components or readjusting trimmer resistors. This increased the sliding range from ± 500 Hz to about plus 2 kHz and minus about 13 or 14 kHz. Now the clarifier could slide into RC channels which are between class D channels.

In the world of CB, if something is illegal, it is even more desirable to have, and the CB consumer will pay an arm and a leg to have it.

Having a transmitter "peaked up" is another service in demand. Rarely can more than 1 extra Watt be squeezed out of an average CB transceiver and still have just a touch of upward modulation. Overdesign is not common. But a CBer usually thinks, "It may help me get out an extra mile." I usually charged \$5 to peak the transmitter, but a licensed repairman could get \$20 to \$25. Of course, he had to do this under the counter. The big money in CB is in modification, not repair.

HF Lingo

How do HFers refer to illegal channels? They think of the frequency in megahertz and use the first three digits after the decimal point. So 27.415 would be just 415. This is the first channel above channel 40. From channel 26 through 40, the frequency can be determined by just adding a 5 to the end of these digits. Channel 40 is actually 27.405, channel 34 is 27.345. By extrapolation then, 27.505 would be channel 50. Many AM HFers use this method of nomenclature, and you will hear "Break channel 43" on 27.435.

Eleven meter single sideband is a rather new and very different development. Almost all CB sideband is on the lower side. Upper-side users are looked down upon and sometimes even harassed when on the air.

Sideband conversations are formalized. They are very similar to ham QSOs, which they are intended to mimic. No ten codes are used as on AM—only Q codes are used. There are no AM handles either; everyone uses first names.

If you are an AMer new to sideband and have picked up the habit of saying 10-4, you will often be politely asked to try not to say it. "Roger" replaces 10-4 on sideband. There is very little of the stereotyped channel 19 lingo on sideband. But when skip starts, it is funny to hear sidebanders call out "CQ DX" over and over.

To replace handles, sideband operators have club call letters. The first CB sideband clubs formed used the number designating their state's place in the order of all states' admittance to the Union, followed by a W, which stands for World. For example, California would be a 31W state because it was the thirty-first state to be admitted to the Union. Newer clubs are using an N prefix, for National, so Georgia would be a 5N state. Other abbreviations include A for America and X for X-ray. It seems like the whole alphabet is being used.

An AM operator will generally get mad when someone else uses the same handle. Sidebanders will also get disturbed when someone else has the same club call letters. How can this happen? Well, 36A3536 could be the 36 Alpha or the 36 America club (Nevada) when written down on paper.

Many sidebanders get a number from every club in the area so they can use call letters to match the person on the other end of the QSO. The use of club letters makes a neater and more efficient operation on the crowded Citizens Band.

When the DX is in, it is easy to figure out what states other operators are in. Club call letters replace FCC call letters on the HF band. During local QSOs on class D frequencies, both FCC and club call letters are generally used.

An AMer might say, "This is the Hill Billy, KABC 1234, going 10-7 for the night."

A sidebander might say, "This is 36-National-1234, KXYZ 9876, QRT and QSY to bed."

Using Ham Gear

Most HF gear is modified CB gear with possibly a linear amplifier, but converted amateur gear is most popular among sidebanders. It may not be apparent, but amateur equipment has distinct advantages and actually makes sense. An amateur transceiver has a dynamite receiver. Its sensitivity and selectivity will beat any piece of CB equipment hands down.

Citizens Band is far more crowded than any ham band. In the evening, signals abound as people turn on their radios to have a conversation. Adjacent channel interference is unbelievable. Look around an average suburban area sometime, and see how many CB base station antennas are on the rooftops. Citizens Band has truly become radio communications for the people.

Before CB expanded to 40 channels, FCC type acceptance rules were very lax. Very inexpensive 23-channel transceivers were junk. Not only were they severe generators of TVI, but when a preamplified microphone was added, the transmitted signal was 15 or 20 kHz wide.

And think about this: The Cadillac of CB radios is the Browning Golden Eagle. This 40-channel set now retails for about \$1000. A Drake or Yaesu has a transmitter that can be tuned and has complete range over the 11 meter band after relatively simple modification. The price is also several hundred dollars less. The cost of a moderately priced CB transceiver, external vfo,

and linear amplifier is about the same as that of a piece of amateur gear.

Amateur transceivers put out a clean signal. There is very little spurious radiation and harmonic content. If everyone ran ham equipment on eleven meters, there would be virtually no TVI and far less adjacent channel interference.

There seems to be little interference to licensed users of the HF band, mainly because the business band is FM and usually 5 kHz off from most HF traffic. Business-band licenses are not being renewed because of expansion to 40 channels, and their signals are getting fewer all the time. There are a few business-band stations between the newly allocated CB channels, but few CBers realize what the buzz from the FM signal is. As far as government use of the HF band goes, it probably exists, but I have never heard any government transmissions.

Practically no one worries about being caught by the FCC. There may be a scare now and then that the FCC is in town, but I have yet to hear of someone I know being apprehended. With so many people into CB, it just cannot be controlled easily.

HFers are generally the CBers who go for ham tickets. After obtaining a ham ticket, they generally stop HFing or curtail their activity greatly. Getting a ham license fills their DX appetite and their HFing is done less and less after that. But most never leave CB for good because they still have too many friends there.

There are some CBers operating amateur gear who will not use a non-class D frequency. Most of these people are sidebanders. When CB had only 23 channels, only one of those channels came to be

known as a sideband frequency. This was channel 16. As the popularity of CB began to rise, so did the crowding. Occasionally, AMers strayed onto this frequency. Because of the hassle, many people held their conversations about 60 kHz or more above 23. After 40-channel expansion took place, the top 60 kHz of the present class D frequencies, channels 35 through 40, became unofficial sideband-only frequencies, mainly because they were beforehand. Because these frequencies were legalized, some sideband operators, including those running ham gear, quit operating out of band because they felt they now had a place and did not want to lose the new frequencies to AMers.

As a rough estimate, about $\frac{1}{3}$ to $\frac{1}{2}$ of the total CB population has probably at one time operated on illegal frequencies. Most of these operators do so when DX is in. When conditions are quiet, there is little non-Class D activity. In fact, there is more illegal AM activity when conditions are quiet. The sidebanders seem to stay put.

Special Activities

There are a few unusual activities that take place in sideband HFing. Slow scan television is around 27.985, just 15 kHz below 10 meters. I have personally never viewed an SSTV signal when the DX is running.

Round table conversations happen frequently. Three or more stations from different parts of North America link up and talk for an hour or more. Virtually all of these HFers use amateur gear and beam antennas.

Phone patches are popular. If an HFer QSOs with another whose location is near his relatives, he will dial up a phone patch without a second thought.

Perhaps one of the most unusual HF clubs is the Eleven M Club. To join, you must own and operate your own business and run all Collins equipment. The club's standby frequency is 27.765, and they only want their members to use this frequency. They generally appear only when DX is running. And the Eleven M is not what you think. The club was supposedly started by eleven millionaires. A rumor circulating about them is that most of these guys are hams who want something a little different to do.

There is also illegal activity below channel 1. For some unexplainable reason, it is all AM activity. When skip starts, this spectrum of frequencies gets filled with traffic. It extends about 300 kHz or more below channel 1. The frequency 26.800 is a popular one because it is exactly 455 kHz below channel 23. A receive crystal for channel 23 put in the transmit crystal socket is a common way to get this frequency.

CB's Popularity

Because CB became so popular in a short period of time, the FCC had to legalize idle chitchat. I really do not think it affected CB's growth. Psychiatrists have come up with many reasons why CB has become so popular so quickly, but I do not agree with any of these.

I think there is a little bit of a ham in everyone. Most CBers do not know how their radio works, but why is that so bad? A lot of people, including some hams, do not understand how a Polaroid camera works or understand every part of a car, but this does not prevent them from using these items and getting good results.

What attracts people to CB is the fact that they can push a button on a microphone and talk to someone

1-805-485-0942

VINEYARD AMATEUR RADIO

We sell Ten-Tec, Alda, SST, Wilson, Lunar, Mirage, and many others for less.



★ INTRODUCING ★

The RM-101 and TS-820 rcvr mod kit

If you own a YAESU FT-101 Series Transceiver or a Kenwood TS-820, the "RM" series mod kits will greatly improve AGC characteristics and signal-to-noise ratio, as well as reduce strong signal overload and internal noise.

Best of all, at \$14.95, the "RM" Series kit is an excellent investment in improved receiver performance.

Drop us a card or call for our low prices

VAR Vineyard Amateur Radio
4407 Vineyard Rd. 
Oxnard, CA 93030 

GND INPUT V

MINI MODULES & PLUG IN ASSEMBLIES TO FIT YOUR PROJECT & POCKET

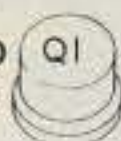

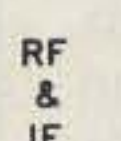
BROADBAND AMPLIFIERS

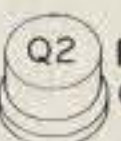

RF & IF AMPLIFIERS

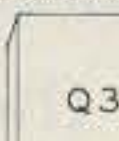

FET MIXERS CONVERTER

COMPRESSIVE AUDIO PREAMPLIFIER

This ad is a scale outline of an Audio Power Amplifier 1101-2

Q3

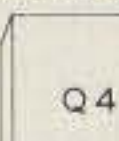

SEND FOR YOUR DESIGN MANUAL & CATALOG



Q4

H44

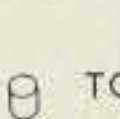
HFT INC
 158 WEST 9TH ST.
 DEER PARK NY
 11729

T1

TO SPEAKER
8 OHM

1101-2

SCANNERS * SCANNERS * SCANNERS

YOU'VE SEEN THE REST, NOW BUY THE BEST

HAM SCAN-2

Kenwood 7400A, KDK 2015R, KDK 2016A, Pace Comm II, Midland 13-510, HW-2036, others

- Features one channel of memory, without need of resetting dials to zeros as required by others.
 - Unit mounts totally inside of rig, no external boxes.
 - Scanning rate 200 kHz nom, not 50 kHz, with a 3 second pause on all active channels before resuming scan.
 - Mike-mounted switch provides 3 functions: scan start/stop, remote frequency incrementing, and transmit interlocking when in active scan mode.
 - Totally assembled and tested \$59.95 \$1.50 shp.
- Order HAM SCAN-2 and please specify type of rig

Technical Clinic

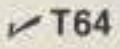
P.O. BOX 636
STERLING HTS. MI 48078 
Phone Orders Call: (313) 286-4836

★ For Sale ★

\$10,000,000
INVENTORY

The *ultimate* source for electronic components and equipment.

PRODUCTION OVERRUNS SURPLUS MATERIALS

Send us your inquiries. Get on our exclusive mailing list. Inquire in writing or by Telex

TWX: 510-224-6539

Serving domestic and overseas markets.

Ultima
Electronics, Ltd.
(516) 423-3770

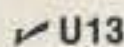

73 Sherwood Ct., Huntington, N.Y. 11743 U.S.A.

NOW! NOW! NOW! NOW! NOW!

The ultimate answer for eliminating the damaging effects of antenna weight on your rotor . . . it's the

"UDM THRUSTOR"



- Fits any taper tower or can be used with flat top.
- Accepts 1 1/4" mast pipe
- All steel construction.
- Utilizing precision ground & hardened ball-type thrust bearing.
- Comes ready to install.
- Eliminates the damaging effect on your rotor.
- Shipped prepaid UPS (U.S.A.)
- Check, cash, money order, Visa, MasterCard. \$49.95 complete.
- Also available for 2" mast pipe for \$59.95

UDM ENTERPRISES 
P.O. Box 2037, Sandusky, Ohio 44870

FREE CATALOG



NEW!

CATALOG OF
HARD-TO-FIND
PRECISION TOOLS

Also contains test equipment plus wide selection of tool kits and cases

Jensen's new catalog is jam-packed with more than 2000 quality items. Your single source for hard-to-find precision tools and tool kits used by electronic technicians, scientists, engineers, instrument mechanics, schools, laboratories and government agencies. Send for your free copy today!

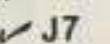



JENSEN TOOLS INC.

1230 S. PRIEST DR. TEMPE, AZ. 85281

antennas

MODEL AP-1

0, 40, 20, 15 and 10 meters
\$35.00

MODEL AP-2

40, 20, 15 and 10 meters
\$30.00

MODEL AP-3

20, 15 and 10 meters
\$25.00

SHIPPED POSTPAID USA
SEND FOR FREE BROCHURE

RUDY PLAK
W6TIK 

PO BOX 966
SAN MARCOS CA 92069

JUST GETTING ON THE AIR?

See Adirondack for



- New Equipment
- Used Gear
- Friendly Advice

ADIRONDACK Radio Supply

185-191 West Main Street • P.O. Box 88
Amsterdam, N.Y. 12010 Tel. (518) 842-8350
Just 5 minutes from N.Y. Thruway - Exit 27

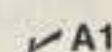

RT-524M TRANSCEIVER



Covers 136.00 to 149.95 Mhz in 50 Khz crystal-controlled steps; 15 watts output. Has volume and squelch controls; requires 27 VDC 6 amps. With tubes 8156, 2/8102, 6/6CW4, and 2/7587. O/A size: 6-3/8x3-1/2x14; 10 lbs.

sh. Used, no covers \$54.95

R-390A/URR RECEIVER: 2 to 32 Mhz AM in 1 Khz steps; mechanical filters. Used reparable \$295
Checked \$450 Manual \$12.00

VACUUM VARIABLE CAPACITOR: 50-2000 pf, 3 KV. Right-angle manual tune drive with 1/4"-3/8" dia. shaft. On 5-3/4"x3-1/4"x3-3/4" mount bracket. O/A 10-3/4x3-1/4x5, 9 lbs. sh. #C818/WRT, Used \$75.00

7.5 KV VARIABLE CAPACITOR: 55-420 pf single section; 0.22" air gap. 13-1/2x3-1/2x6-1/2" plus 2-1/4x3/8" dia. shaft #7765118 \$23.00

EIMAC SK610/JOHNSON 124-110 socket & Chimney for 4X150/4CX250, used \$9.00

Use your Visa or MasterCard.
All Prices F.O.B. Lima, Ohio. Please Allow for Shipping.
Send for FREE Copy of NEW Catalog '79!
Address Dept. 73 • Phone 419/227-6573

FAIR RADIO SALES 
1016 E. EUREKA • Box 1105 • LIMA, OHIO • 45802

else across town or further away. All this can be done without interconnecting wires. This is what attracted me to radio and this is what initially attracts every ham to amateur radio.





CB has proven there is strength in numbers. As more license applications came in, the FCC relaxed the rules. They allowed higher antenna placement, permitted idle conversation, changed the rules so that only the sender needed to use his call letters, and expanded the number of channels. Most of these changes happened in a relatively short period of time. No one really worked together as a group to achieve these ends, although I will admit that the EIA lobbies wield quite a bit of force.

Yet 350,000 hams, who generally know radio well

and work in unison for the most part, cannot persuade the FCC to allow phone operations in a large segment of the 20 meter band now allocated to CW.

Many CBers would like even more expansion on 27 MHz, but the FCC will not expand any further because of intermodulated products resulting from 455 kHz i-fs. Now that 220 MHz is not available, CB will probably end up around 800 or 900 MHz if there is any further expansion. Antennas with huge amounts of gain would be possible, and so would moonbounce. It would be an ideal hobby band. Skip would be all but totally eliminated, and so would interference to other devices. Skip on 11 meters is the main reason HFing exists. HF activity just is not there unless skip is present. ■

BELDEN

Part Number	MHz	db/100 ft.	db/100 m
 9888 39¢/ft	50	1.2	3.9
	100	1.8	5.9
	200	2.6	8.5
	300	3.3	10.8
	400	3.8	12.5
 8214 25¢/ft.	50	1.2	3.9
	100	1.8	5.9
	200	2.6	8.5
	300	3.3	10.8
	400	3.8	12.5
 8237 21¢/ft	100	2.0	6.6
	200	3.0	9.8
	400	4.7	15.4
	900	7.8	25.6
 8267 25¢/ft	100	2.0	6.6
	200	3.0	9.8
	400	4.7	15.4
	900	7.8	25.6

 8448 16¢/ft	No. of Cond. — 8
	AWG (in mm) — 6-22, (7x30), [.76]; 2-18, (16x30), [1.19]

 9405 26¢/ft	No. of Cond. — 8
	AWG (in mm) — 2-16, (26x30), [1.52]; 6-18, (16x30), [1.17]

MADISON ✓ M35
ELECTRONICS SUPPLY, INC.
1508 McKINNEY • HOUSTON, TEXAS 77002
713/658-0268

TIMETRAC

By Comus

the microcomputer-controlled
appointment clock

NEW
First Time Offer

— NOT A KIT —
Regular Price \$79.95
Introductory Offer by
HAL-TRONIX
only \$69.95



FEATURES:

- Sleek modern styling to complement any home or office decor.
- Tells the time.
- Tells the date and year.
- Up-timer to 60 minutes, 59 seconds with pause.
- Alarm to ring at the same time everyday.
- Daily appointment sets appointments for the next 23 hours, 59 minutes.
- Future appointments up to one year.
- Dimmer switch for display.
- Memory will hold up to 30 appointments.
- Lithium power cell to retain memory during power outage.
- Appointments entered out of chronological order will be stored in chronological order.
- Colon flashes once each second.
- A.M./P.M. indicator.
- Plugs into any wall outlet.
- Easy to read vacuum fluorescent display.
- Extremely accurate quartz crystal clock.

EFFICIENT. REMARKABLE.

TimeTrac sold and distributed by HAL-TRONIX. Dealers welcome.

Send 15¢ stamp or S.A.S.E. for information and flyer on other HAL-TRONIX products. To order by phone: 1-313-285-1782.



"HAL" HAROLD C. NOWLAND
WBZHX

HAL-TRONIX ✓ H24
P.O. Box 1101
Southgate, MI 48195

SHIPPING
INFORMATION:

ORDERS OVER \$15.00 WILL BE SHIPPED POSTPAID EXCEPT ON ITEMS WHERE ADDITIONAL CHARGES ARE REQUESTED. ON ORDERS LESS THAN \$15.00 PLEASE INCLUDE ADDITIONAL \$1.00 FOR HANDLING AND MAILING CHARGES.



Para-graphics is proud to announce its' new portfolio of QSL's. The portfolio contains our complete line of QSL Cards... not small reproductions, but actual size, FULL COLOR prints. Included in the portfolio are twelve brand new, FULL COLOR cards.

Send \$1.00 today, for your QSL portfolio. The \$1.00 is redeemable with your first order of QSL's.

para-graphics ✓ P20

exclusive QSL's for the Ham Radio Operator...

P.O. Box 268, Whitehall, PA 18052
A Division of AA Printing Service, Inc.
801 Third Street, Whitehall, PA 18052



**Germtown
Amateur
Supply,
Inc.** ✓ G12

MEMPHIS, TENNESSEE

NO MONKEY BUSINESS!

- (A) Complete Service Facilities
- (B) Good Deals on most Brands
- (C) Shipping within 24 Hours
- (D) All inquiries handled by Active Hams with over 20 years experience in ham radio

CALL TOLL FREE
1-800-238-6168

IN TENNESSEE, CALL 901-452-4276
MONDAY - SATURDAY 8:30-5:30
FOR YOUR SPECIAL.

Write: 3202 Summer Ave., Memphis, Tennessee 38112



NEWEST NO SLUG WATTMETER

Never Again Worry About That Forgotten Slug
Or The ONE Slug You Don't Have!

THIS ONE COVERS 20 MHz-1000 MHz WITHOUT SLUGS

Eliminate that
wrong power or
frequency range
problem...

... just eliminate
the need for that
large box of different
\$38 slugs!

**THE TELEWAVE
MODEL 44
DOESN'T NEED SLUGS**

yet the "44" covers
20 MHz-1 GHz and 0-500 watts

GET YOURS TODAY

**Now Just \$295 Complete
SHIPPED FROM STOCK**

All M.O. & Cert. Check Orders Shipped Next Day
Calif. Res. Add 6% Tax

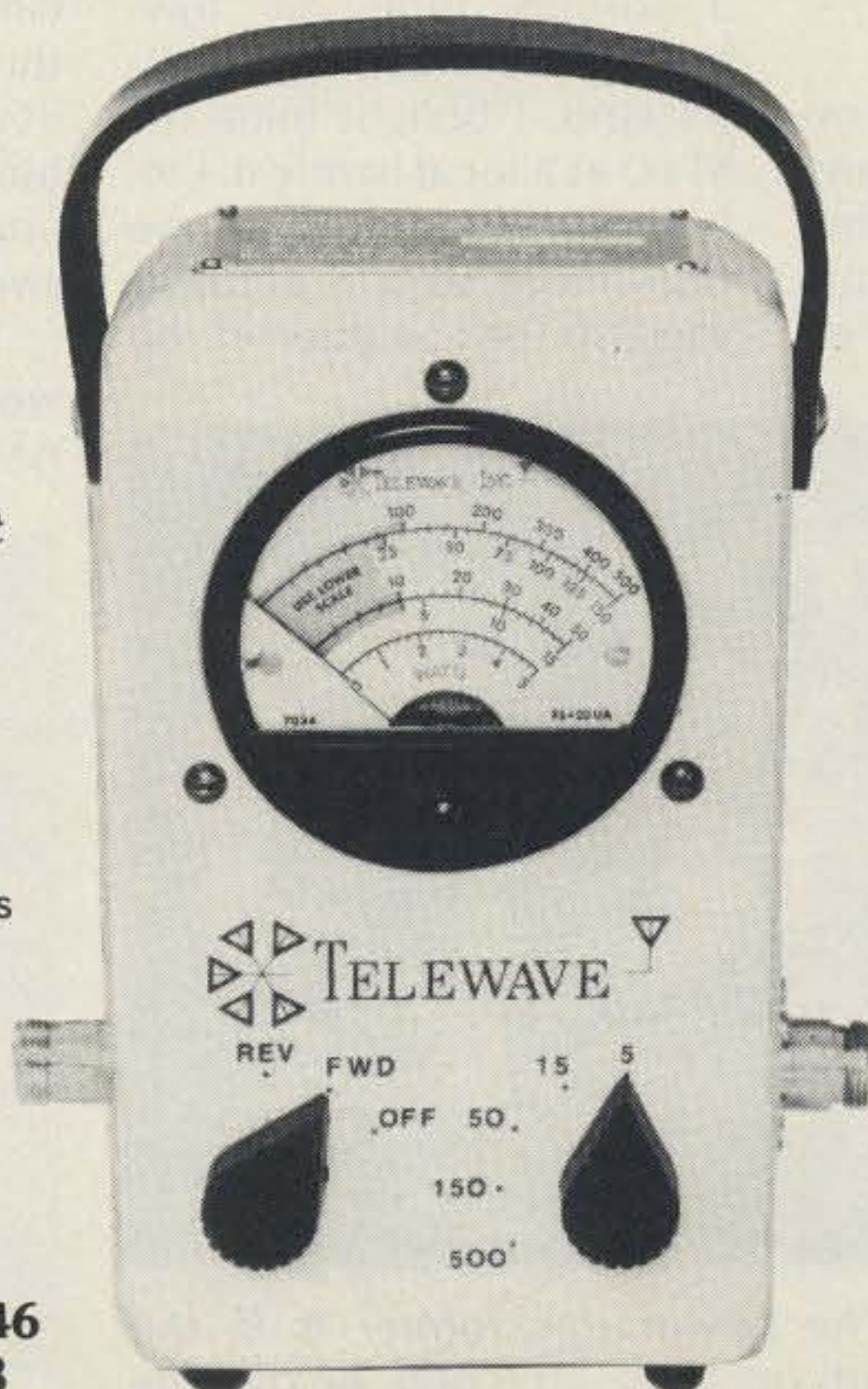

CHECK THIS...

- ✓ No Slugs
- ✓ No Bandswitching
- ✓ Zero to 500 Watts
- ✓ 5 Power Ranges
- ✓ 20 to 1000 MHz
- ✓ Forward or Reflected Power
- ✓ Type "N" Connector UHF on Special Order
- ✓ Rugged Die Cast Metal Case
- ✓ 20µa Taut Band Meter Movement
- ✓ Just 3 Lbs Light

✓ R35



**ROSS DIST. CORP. (213) 919-3446
BOX 5003 • COVINA, CA 91723**

EG-73-9-79

70-Watt Shoes for the IC-502

— put some punch in that 6m signal

*George Hovorka WA1PDY
John Hovorka, Jr.
674 Brush Hill Rd.
Milton MA 02186*

The IC-502 is an excellent 6 meter transceiver for the money, but sometimes a little more power is very useful, es-

pecially during skip openings. Here is a linear amplifier that you can build at little or no cost, which runs about seventy Watts input. The heart of this amplifier is a surplus tube-type low-band Motorola FM transmitter strip. I bought mine for \$1.00 at a local hamfest. Only the final amplifier of the transmitter strip is actually used, so the condition of the

strip is unimportant. The advantage of my scheme is that the critical VHF wiring, neutralizing, and shielding, as well as the procurement of rf components is all taken care of for you. Essentially, this project consists of modifying the transmitter strip, building a power supply, and creating the relay switching for the amplifier.

This amplifier will also work well with low-power AM transceivers, such as

the Heathkit Sixer and the Lafayette HA-650.

Selecting a Transmitter Strip

This conversion is based on a Motorola TA104 series low-band transmitter strip. These can be easily recognized by their long, thin appearance, and a large multi-turn tank coil. This transmitter series covers the 25-to-54-MHz range in 5-MHz segments. To find the

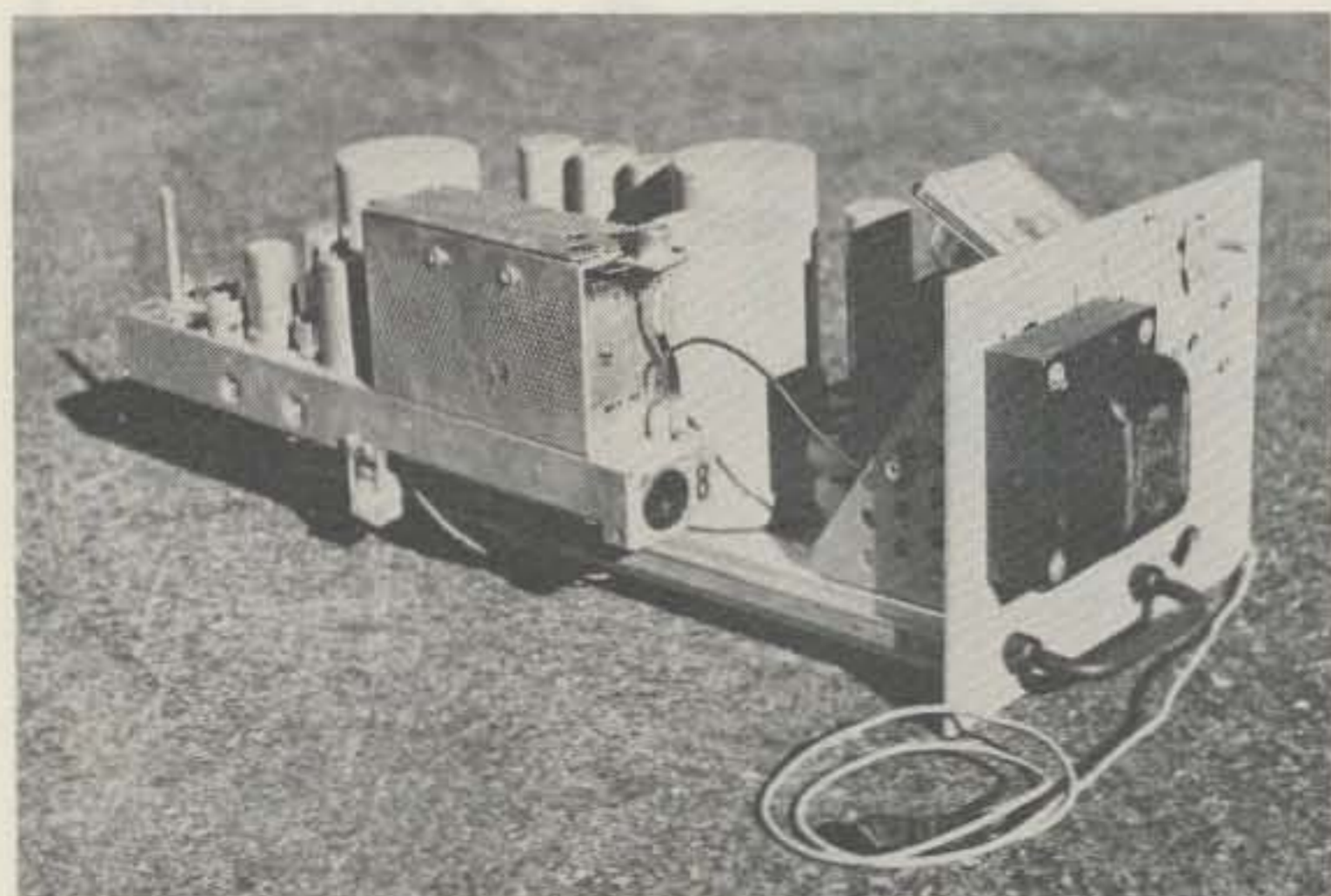

Completed amplifier. The power transformer is in the foreground, and C1 can be seen attached below the transmitter strip.

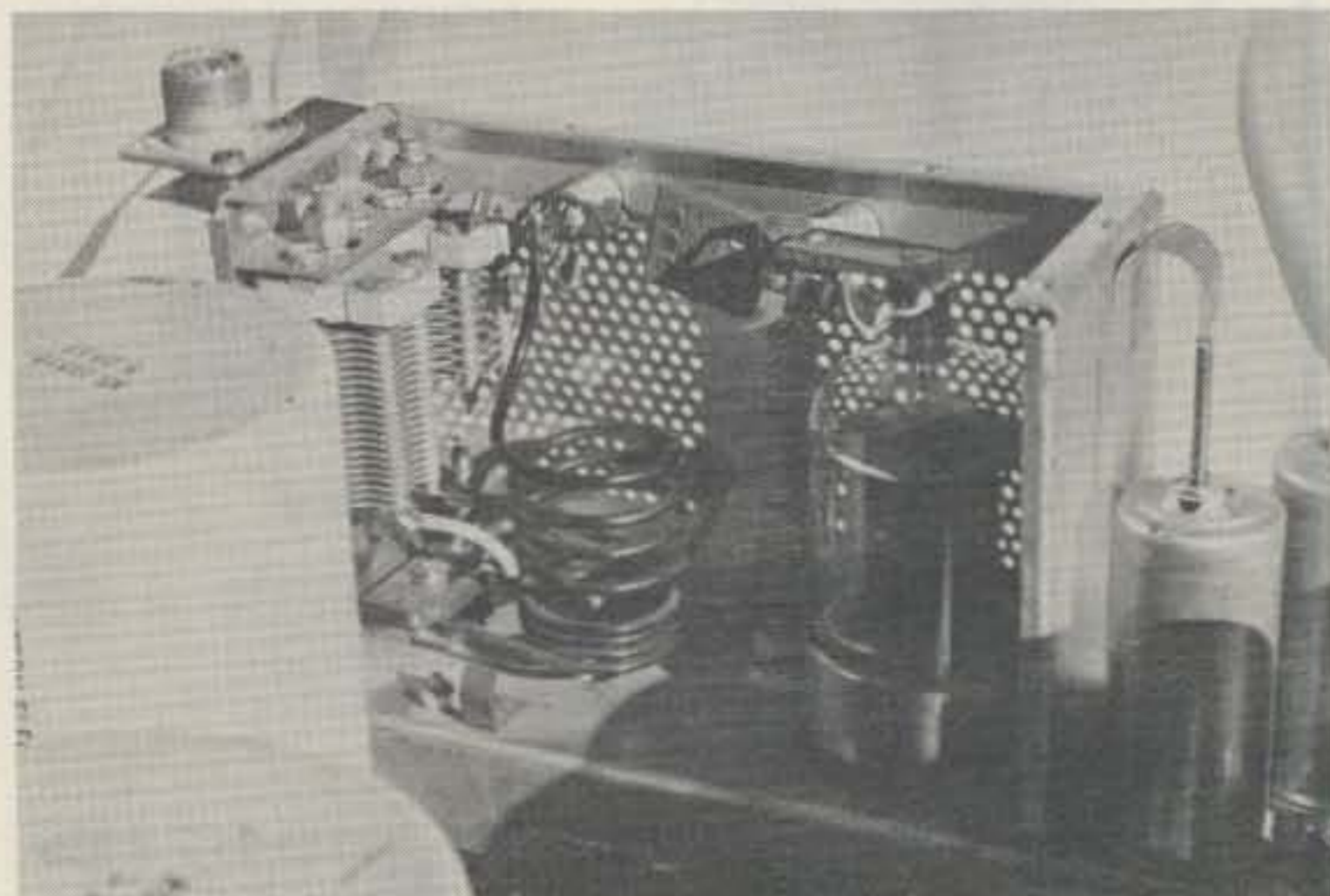

Power amplifier coil. Note cut-down tank coil.

and RLY2 is the original antenna changeover relay in the transmitter strip. All of the rf wiring should be done with RG-58/U coaxial cable. Except for insulating the high-voltage filter capacitors, the rest of the wiring is noncritical.

Some sort of 6 meter TVI filter should be placed on the output side of the amplifier to ensure that it meets FCC harmonic suppression requirements.

Tune-Up

Without any rf drive applied to the amplifier, adjust the grid bias control so that the plate idle current is about twenty milliamps. Next, connect an swr bridge between the amplifier and the exciter. Adjust the exciter to the frequency you most commonly use (such as 50.11 MHz), and place it in the tune position. In the case of the

IC-502, place the transceiver in the CW position, and put the key down. Then with the amplifier off, adjust C1 for the lowest swr. With the amplifier peaked for 50.11 MHz, I am able to QSY up to 50.4 MHz without any substantial drop in power.

Over the past few months, the on-the-air reports which I have gotten while using the amplifier have been gratifying. Stations that I have contacted on a regular basis report about a 4 S-unit improvement when the amplifier is turned on. Often, over long tropospheric bending paths of 400 miles or more, the amplifier has made the difference between whether I was able to make a contact or not. If you construct one of these 6 meter amplifiers, I am sure you will find it a valuable asset to your station. ■

NEW!! THE SPACE CASE®

...What better way to give your circuit designs a professional look. House them in top quality enclosures...

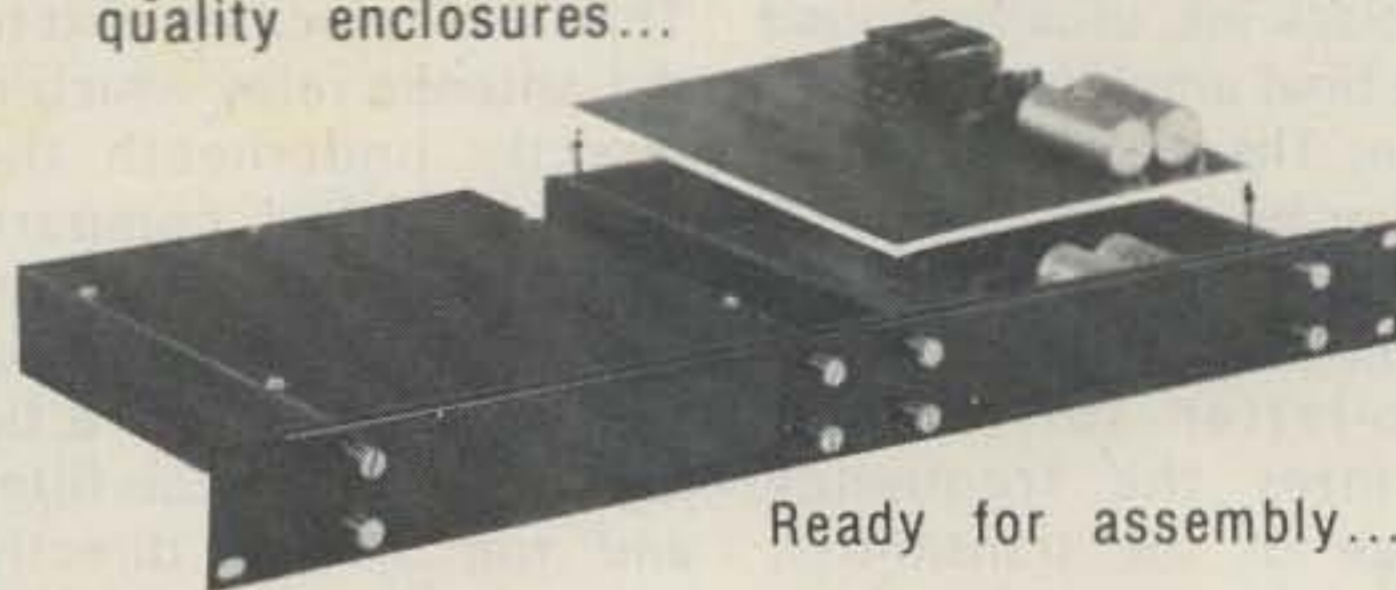

Ready for assembly...

THE SPACE CASE®

- C-1 1 1/2" x 7" x 8" \$24.50
- C-3 3" x 7" x 8" \$29.50

•6061-T6 Black Anodized Aluminum•1/4" Sides, 1/8" Front and Rear, 18 Gauge Top and Bottom Panels•Circuit Card Guides•Pre-Drilled For Ease of Assembly•All Necessary Hardware.

RACK PANELS

- P-1 1 1/4" x 19" \$12.50
- P-3 3 1/2" x 19" \$14.50

• Fits Any Standard Size Rack

PROTO-TYPE BOARDS

- B-5 5V (Complete) \$40.50
- B-12 ± 12V (Complete) \$45.00
- B-B Bare Board \$25.00
- T-5 5V Transformer \$12.00
- T-12 ± 12V Transformer \$12.00

• Powerbuses Accepts Up To 25, 14 Pinpacks • Provisions Made For Either 5V at 800 ma. or ± 12 V at 230 ma. By Simple Transformer Change • Complete With All Parts.

Charge to VISA or MASTER CHARGE or mail us a check or money order. Include list price plus \$3.00 shipping & handling. Ohio residents add 4% sales tax.

✓ \$100

SCOTT MANUFACTURING

CALL OR WRITE FOR FREE LITERATURE
(216) 494-6050

P.O. BOX 2304 NORTH CANTON, OHIO 44720

NOTE TO 73 Subscribers

From time to time 73 Magazine makes its subscriber lists available to carefully-screened companies and organizations whose products, services or information may be of interest to you. In every case, we must approve all organizations wishing to mail to our subscribers. In every case they receive a list of names and addresses only—no other information we may have is divulged. Each organization may use the list only once and agrees never to make any personal or telephone solicitations from it.

The overwhelming majority of our subscribers appreciate this controlled use of our mailing lists—it helps them shop conveniently by mail for products and services they need, often at substantial savings. A few people prefer their names not be used. It is to them we address this message.

If you do *not* wish to be a part of this service, please complete the form below... your name will not be used in this manner for any reason.

(If you asked us in the past to remove your name from our lists, there is no need to repeat the request.) Please allow about six weeks for your request to take effect.

I wish to have my name removed from the list of subscribers receiving mail other than the regular subscription to 73 Magazine.

Mr. _____
Mrs. _____
Ms. _____
Please Print

Address _____

City _____ State _____ Zip _____

Mail this form with your mailing label from the latest issue (or fill out the information as it appears on the label) to:

73 Magazine
Subscription Services Dept.
P.O. Box 931
Farmingdale NY 11737

BARRY ELECTRONICS CORP.

Mon.-Wed. 9:00-5:30
Thurs. 9:00-7:30
Fri. 9:00-6:30
Sat. 10:00-3:00

512 Broadway
New York, N.Y.
10012

CALL FOR BEST OFFERS ✓ B54

212-925-7000

YAESU SYNTHESIZED HT
HANDIE TALKIE
IN STOCK



FT-207-R

MURCH UT 2000 B
THE ULTIMATE
TRANSMATCH
(10-160 METERS)

- USED WITH ANY ANTENNA
 - ROTARY INDUCTOR WITH TURNS COUNTER
- SWR 1:1 PRICE: \$242.50



Start your own encyclopedia of Amateur Radio by taking advantage of this super offer. Hurry, though: this offer is limited.

If you've been thinking about subscribing to **73 Magazine**, this is the time to do it. Subscribe today at the already low subscription price of \$15 (you save \$15 off the newsstand cost for one year) and get your choice of three issues from the following pages, **FREE!** Each issue is full of information on building projects, antennas, traffic handling, radioteletype, computers, and more.

If you already subscribe to **73 Magazine**, you know what a fine magazine it is. You'll want to take advantage of this super offer by renewing for 12 months and taking your choice of these great issues, **FREE!**

Look over the wealth of information included in these issues. There's little or no information that goes stale. And by subscribing now, you can choose three issues and start your encyclopedia of Amateur Radio right away. Simply indicate on the attached postage-paid card the issues you wish to receive. Please include two alternate choices as these issues are limited and they're going fast. Allow 4-6 weeks for delivery. (Your subscription will start with the next published issue; if you already subscribe, we'll extend your subscription.)

Look over these great issues on the following pages...

What have you missed?

68

JUNE 68. Surplus Issue! transformer tricks; BC-1206 RX; APS-13 ATV TX; low-voltage dc supply; surplus scopes; FM rig commercial xtal types; Wilcox F-3 RX; restoring old equipment; 75A-1 RX mods; TRA 19 on 432; frequency counter uses; transceiver power supply; uses for cheap tape recorders; surplus conversion bibliography; RT-209 walkie on 2m; ARC-1 guard RX; RTTY TX TU.

JULY 68. Wooden tower construction; tilt-over towers; erecting a telephone pole; IC AF oscillator; "dB" explained; ham club tips (part 1).

SEPT 68. Mobile VHF; 432 FET preamps; converting TV tuners; xtal oscillation stability; parallel-tee design; moonbounce rhombic; 6m exciter (corrections Jan. 69); 6m transceiver (corrections Jan. 69); 2m DSB amp; ham club tips (part 3).

NOV 68. SSB xtal filters; solid-state troubleshooting; IC frequency counter (many errors & omissions); "CV" transformers; space communications odyssey; pulsar info; thin-wire antennas; 40m transistor CW TX/RX; BC 348M double conversion; multifunction tester; copper wire specs; thermistor applications; hi-voltage transistor list; ham club tips (part 5).

Available issues published from 1968 are listed at the end of this catalogue.

69

JAN 69. Suppressor compressor; HW 12 on 160; beam tuning; ac voltage control; 2m transistor TX; LC power reducer; spectrum analysis info; 6m transistor RX; operating console; RTTY autostart; calculating oscillation stability; low-power 40 CW TX; sequential relay switching; sightless operator's bridge; ham club tips (part 7).

FEB 69. SSTV camera mod for fast scan; tri-band linear; selective AF filter; unijunction transistor info; Nikola Tesla biography; mobile installation hints; Extra class license study (part 1).

MAR 69. Surplus issue: TCS TX mods; cheap compressor/amp; RXZ calculations; transistor keyer; better balanced modulator; transistor oscillators; using blowers; half-wave feedline info; surplus conversion bibliography; Extra class license study (part 2).

APR 69. 2-channel scope amp; RX preamp; Two-er PTT; variable dc load; swr bridge; 100 kHz marker gen.; some transistor specs; SB-610 monitorscope mods; portable 6m AM TX; 2m converter; Extra class license study (part 3).

MAY 69. 2m turnstile; 2m slot; RX attenuator; generator filter; short vee; quad tuning; using antennascope; measuring antenna gain; phone patch regs; swr indicator; 160m short verticals 15m antenna; HF propagation angles; FSK exciter; kW dummy load; hi-power linear; Extra class license study (part 4); all-band curtain array.

JUNE 69. Microwave power generation; 6m SSB TX; 432-er TX/RX; 6m converter; 2m 5/8 wave whip; UHF TV tuners ATV video modulator; UHF FET preamps; RTTY monitorscope; Extra class license study (part 5); building UHF cavities; mini-vee for 10-20m; VHF vfo.

JULY 69. AM modulator; SSTV signal generator; 6m kW linear; 432 kW amp; 432-34 TX/RX; 6m IC converter; radio-controlled models; RTTY IC TU; audio notch filter; VRC-19 conversion; tube substitution; 2m transistor exciter; Extra class license study (part 6); HF FET vfo.

AUG 69. FET regen for 3.5 MHz up; FM crystal switching; 5/8-wave vertical; introduction to ICs; RTTY tone generator; good/bad transistor checker; 2m AM TX; measure transistor Ft; 160m propagation; triac applications; simple i-f sweep generator; transistor keyer; SB-100 on 6m; xtal frequency measurement; Extra class license study (part 7); FM deviation meter; QRP AM 6m TX; circular quads; FM noise figure; transistor parameter tracer.

SEPT 69. Tunnel diode theory; magic tee; soldering techniques; wave-travel theory;

cable shielding; transistor theory; AM noise limiter; AFSK generator transistor amp debugging; measure meter resistance; diode-stack power supply; transistor testing; 2 1/2 W 6m TX; HX-10 neutralizing; capacitor usage; radio propagation; AM mod percentage; Extra class license study (part 8); 3-400Z linear; ATV vidicon camera; 2 transistor testers; FET compressor; rf plate choke.

OCT 69. Super-gain 40m antenna; FET chirper; telephone info; scope calibrator; thyrector surge protector; slower tuning rates; identify calibrator harmonics. FM adapter for AM TX; CB sets on 6m; proportional control xtal oven; xtal filter installation; Q-multiplier; transceiver power supply; Extra class study (part 9).

NOV 69. NCX-3 on 6m; i-f notch filters; dial calibration; HW-32A external vfo; 6m converter; feedline info; rf Z-bridge; FM mobile hints; umbrella antenna 432-34 TX (part 1); power supply tricks with diodes; transistor keyer; transistor bias design; xtal VHF signal generation; electronic variac; SB-33 mods; Extra class study (part 10); SB-34 linear improvements.

DEC 69. Transistor-diode checker; dummy load/attenuator; tuned filter chokes; band-switching Swan 250 & TV-2; 88 mH selectivity; math exercises; RTL xtal calibrator; transistor PA design; HV mobile p.s.; 1-10 GHz freqmeter; CB rig on 6m; Extra class license study (part 11); 1970 buyer's guide.

70

JAN 70. Transceiver accessory unit; bench power supply; SSTV color method; base-tuned center-loaded antenna; 6m bandpass filter; Extra class license study (part 12); rectifier diode usage; facsimile info.

FEB 70. 18-inch 15m dipole; 6m converter; high-density PC board; camper-mobile hints; 2m frequency synthesizer; encoding/decoding for repeaters; DX-35 mods; panoramic VHF RX; variable-Z HF mobile mount; Extra class license study (part 13); linear IC info; QRP 40m TX; IC Q-multiplier.

MAR 70. Gdo applications; charger for dry cells; FM frequency meter; PC board construction; ham FM standards; cheap rf wattmeter; multifreq FM oscillation; "i-f" system modules (part 1); Six-er mods; gdo dip lite; Motorola 41 V conversion; CW monitor; buying surplus logic; SSQ-23A sonobuoy conversion; GRC-9 RX/TX conversion; Extra class study (part 14); intro to VHF FM.

APR 70. Noise blanker; 2m hot carrier diode converter; repeater controller; under-standing COR repeater; 7/8-wave 2m antenna; Extra class study (part 15); inexpensive semiconductors; renovating surplus meters; linear amp bias regulator; hi-performance i-f amp & agc system; SSB bfo for shortwave radio; vacuum-tube load box; general FM dope & repeater guide; meggering your antenna.

MAY 70. comments on "FM docket" #18803; future of CW; FM-AM RX aligner; 5/8-wave verticals; using 2m intelligently; auto burglar alarms; power supplies from surplus components; "i-f" system modules (part 2); VHF FET preamps; educated "idiot" lights; postage-stamp 6m TX; Extra class study (part 16); Bishop IFNL; low-band police monitor; mobile CW TX; Wichita outpatch.

JUNE 70. DDRR antenna; vfo circuit; remote swr indicator; indoor HF vertical; two RX on one antenna; environment & coax loss; 2-el trap verticals; buying surplus; two 40m QRP TX; 21 dB 2m beam; Extra class study (part 17).

JULY 70. Improved Color Slow-Scan Television; How to Build a Keyer; 450-MHz Mighty Mite—one-transistor superregenerative receiver; Cheapie 6-Meter Half-Gallon—use 811-As and be heard; A High-Performance Power Supply—using an IC voltage regulator; Latham Island DXpedition; Db to Power; Protection for Grid-Dipper Coil's; Mobile CW Receiver; QSLing ... Ham Radio's Own Con Game.

SEPT 70. Integrated Circuit CW ID Generator; The Indication Oscillator—another dipper circuit; 1-400 MHz; Tuning VHF Receivers—clever infinite attenuator and oscillator unit; Repeater Antenna Separation;

Diode Stacks; Deluxe Receiver Gain Control—using one transistor and a zener; Reed Relays for Coaxial Switching; Beer-Can Two Meter Coaxial Antenna; Converting 24 V Relays to 115 V ac; Versatile 2m MOSFET Converter—low noise, high gain, ultra stable.

NOV 70. Differential J-FET preamplifier; Remote Quad Tuning; Two-Watt Six Meter Transmitter—using the crystal-heterodyne vfo; Semiautomatic FM channel Scanning; Low-cost Automatic Keyer—an excellent "first project"; Ac Switching with Self-Powered ICs—clever zero voltage switch; Pioneer Radio on the Prairies—what it was like 45 years ago; SST-1 Solid-State Transceiver for 40 Meters; A Low-Cost RF Wattmeter; Calibrate That Calibrator.

DEC 70. Solid-state VHF exciter; delta frequency control for SSB; 2m transistor FM TX; HW-100 offset tuning; "little gate" dipper; 3-500Z HF linear; General class study (part 5); "transi-test" (no good errors!); transistor p.s. current limiter.

Available issues published from 1970 are listed at the end of this catalogue.

71

JAN 71. Split phones for DXing; Heath Ten-er mods; CW duty cycle; repeater zero beater; HEP IC projects; 10-15-20m parabolic ideas; lightning protection; IC RX accessory; attic antennas; double-balanced mixers; permanent marker tool; ham license study questions.

FEB 71. metal locator; varactor theory; AFSK unit; SSTV patch box; ATV hints; RTTY tuning indicator; tone encoder/decoder; 220-MHz converter; SSTV magnetic deflection; IC code oscillator; 6m TX beeper; General class study (part 6); RTTY intro; perfboard terminal; low ohmmeter.

MAR 71. IC audio filter; IC 6m converter; trap vertical ideas; digital counter info; surplus equipment identification; HF linear; simple phone patch; repeater audio mixer; digital RTTY accessories; coat-hanger ground plane; General class study (part 7).

MAY 71. 75m mobile whip; 2m preamp; transistor amp design; 10m DSB TX; portable FM transceiver directory; audio compressor-clipper; transistor LM freqmeter; 450-MHz link TX; simple AF filter; 1-tube 2m transceiver; surplus 2m power amp; General class study (part 8).

JUNE 71. 2m beam experiments; 3-el 2m quad; multi-band dipole patterns; weather balloon vertical; pocket-pager squelch; Two-er vfo; tuning mobile whips; transistor power supply; capacity decade box; 40m gain antennas; General class study (part 9).

JULY 71. IC audio processor; audio signal generator; CW filter; 2m FM oscillator; 2m collinear vertical; FM supplier directory; Motorola G-strip conversion; transistor beta tester; General class study (part 10).

AUG 71. Ham facsimile (part 1); 500-Watt linear; dimensions for July collinear; 4-tube 80/40 station; vfo digital readout; Jupiter on 15m; General class study (part 11); pink ticket wave-meter.

SEPT 71. Transformerless power supplies; solid-state TV camera; IC substitution; two rf wattmeters; IC compressor-agc; multichannel HT-200; ham facsimile (part 2); causes of man-made noise; vfo with tracking mixer; General class study (part 12); transistor heatsinking; IC pulse generator; phone patch isolation; hcd wattmeters.

OCT 71. Emergency repeater COR; transceiver power supply; predicting meteor showers; digital switching; reverse-current battery charger; passive repeaters; earth grounds; audio "tailoring" filters; Swan 350 mods.

NOV 71. 3-el 75m beam; motor-tuned ground plane; 2m gain vertical; transistor biasing; split-site repeater; fox-hunting; audio filter; transistor/diode tester; xtal tester; 6m kW amp; 10-15-20m quad; transistor pi-net final; antenna feedline; communications dBs; 2300-MHz exciter.

DEC 71. Convert Your 7-MHz Cubical Quad to All Bands; The Indoor Quad; Get

63

JUNE 63. Surplus Issue! DMQ-2 Beacon TX on 220; increasing ARC-2 transceiver selectivity; PE-97A power supply conversion; BC-348 band-spread; inductance tester; converting BC-230 TX; beginner's RX using BC-453; receiver motor-tuning; transistor CW monitor; BC-442 antenna relay conversion; mobile loading coils; increasing Two-er selectivity; TV with the ART-26 TX; TRC-8 RX on 220; ARC-5 HF RX & TX; ARC-3 TX on 2m.

AUG 63. Battery-op 6m station; diode noise generator; video modulation; magic T-R switch; antenna gain; halo mods; CW break-in; VEE beam design; coax losses; rf wattmeter; TX tube guide; diode power supply; "Lunchbox" squelch; swr explanation; vertical antenna info; info on Windom antenna.

OCT 63. WBFM transceiver ideas; HF propagation; cheap phone patch; remote-tuned yagi; construction hints; antenna coupler; \$5 vertical; filament transformer construction; 2m nuvistor converter; Lafayette HE-35 mods; buyer's guide to RX & TX; product detector; novel converter; compact mike amplifier.

Available issues published from 1960-1963 are listed at the end of this catalogue.

64

FEB 64. 2m multichannel exciter; RX design ideas; magic t/r switch; loudspeaker enclosures; 40m 2 W TX; look at test equipment; radio grounds; 40m ZL special antenna; neutralization.

Available issues published from 1964 are listed at the end of this catalogue.

65

Available issues published from 1965 are listed at the end of this catalogue.

66

Available issues published from 1966 are listed at the end of this catalogue.

67

MAY 67. Quad Issue! 432 quad-quad-quad; expanded HF quad; two el quad; mini-quad; 40m quad; quad experiments; half-quad; three-el quad; quad bibliography; FET vfo; tube troubleshooting; HF dummy load; understanding "dB"; HF SSB/CW RX; geometric circuit design; GSB-201 transceiver; FET converter for 10-20m; hi-pass RX filters.

JULY 67. VE ham radio; VE0 hams; DSB adaptor; home-brew tower; transistor design; '39 World's Fair; ground plane antenna; G4ZU beam; SSTV monitor; UHF FET preamps; IC "i-f" strip; vertical antenna; VHF/UHF dipper; tower hints; scope monitoring; operating desk; S-line cross-band; hi-school ham club; Heath HR-10 mods.

OCT 67. HF solid-state RX; rugged rotator; designing slug-tuned coils; FET converter; SSTV pix generator; VHF log-periodics; rotatable dipole; gamma-match cap; old-time DXing; modern DXing.

Available issues published from 1967 are listed at the end of this catalogue.

ting to Know Tee Squared Ell; More Power From 6146s; Radio Direction/Range Finder; Morse Memory—30-letter memory for ident, contests, etc.; SCR Mobile Theft Alarm; DX QSOs or contacts; Code Short-hand; VHF Double Sideband.

72

FEB 72. A Solid-State High Frequency Regenerative Receiver—el cheapo using one IC; Tips for Raising Your Code Speed to 20 WPM; Why Not Try QRP? VHF Dummy Load Wattmeter; CW DX On 1/2 Watt—enjoy QRP with this 1-Watt rig; 20-60 W 1-4 Band TX—two-tube CW transmitter; Quick and Easy PNP/NPN Transistor Sorter; Self-Contained Reflected Power and CW Monitor; Circuits, Circuits, Circuits; The Automatic Transmission Line Tuner.

MAY 72. Quick Band Change Mobile Antenna—with output indicator; How to Get the Stuff into the House; Anti-CW RTTY Autostart; A Modern VHF Frequency Counter—can be built for under \$100; TV Sync Generator—using ICs; Radio Astronomy; Noise and Receiving Antennas; The Sewerpipe Antenna—2m FM, of course; Circuits, Circuits, Circuits; Simple Car Ammeter—all solid state.

JUNE 72. Six Elements on Twenty Meters—eliminate QRM; Slow Scan Television—basics; Active Filter Design and Use—all kinds of filters. Part I; Radio Astronomy for Amateurs (Part II); 20 dB Beams—design and construction of VHF antennas; Phasing Multiband Verticals—ten thru eighty meters; 300-MHz Frequency Scaler—extends frequency counters to VHF; Circuits Circuits, Circuits; RTTY Filters—elliptic function filters; Trouble-shooting for the Novice.

JULY 72. Solid-State VHF Amplifier; The Phase-Locked Loop; VHF Converters; Add \$15 T-Power; 1296-MHz Mixer; The VHF Specialists FM Amplifier; Meteor Shower DXing; Tone Decoder and Carrier Relay Circuits—using the 741 op amp; Flying Spot Scanner for SSTV—solid-state unit, simple, relatively; Active Filter Design, Part II.

AUG 72. SSTV Intro; speech processor; FM repeater info; test probe construction; GE Procline ac supply; 432 rf testing; pre-amp compressor; Six-er mods; phone patch; Two-er info; solar info; SCR regulator for HVPS; "ideal" xtal oscillator; FM RX adapter; auto theft alarm.

SEPT 72. Plumbicon TV camera; WWVB 60-kHz RX; cigar tube signal generator; CW active filter; rf testing at 1296-3500 GHz; balun antenna feed; transistor power supply; IC 6m RX; IC FM/AM detector (part 2); active filter design (part 3); K2OAW frequency counter (part 3); 2m frequency synthesizer (part 1).

OCT 72. Corrections for Aug. FM RX adapter; 2m frequency synthesizer (part 2); 6m transistor vfo; nano-ampere meter; time-frequency measurement (part 1); active filter design (part 4); repeater timer; Extra class Q&A (part 3); balloon vertical; ID generator; time-delay relay; 432 filter ideas; dc-ac inverter; hc-diode converter; RTL decade and nixie driver; plus-minus supply for ICs.

NOV 72. HF transistor power amps; RTTY Selcal; IC trf RX transistor keyer; emergency power; 220-MHz preamp; double-delta antenna; simple converter using modules; HF rf tester; "lumped line" oscillator; 2m frequency synthesizer (part 3); K2OAW counter errata; 2m preamp; Extra class Q&A (part 4); hi-Z voltmeter; Nikola Tesla story; VHF swr meter; transistor regen RX; 432 SSB transverter; ac arc welder; intro to computers; hybrid AM modulator; HR-10 RX mods; 10m transistor AM TX; 40m ground plane; IC logic demonstrator; overload protection; i-1/rf sweep generator; digital frequency counter; aural TX tuning.

DEC 72. SSTV scope analyzer; 2m FM RX; tone burst encoder and decoder; universal i-f amp; autopatch hookup; LM380N info; voltage variable cap info; 2m 18-Watt amp; SSB modulation monitor; xtal freq/activity meter; 10 A var. dc supply; transmission line uses; radio astronomy; inductance meter; 75 to 20m transverter; LED info; 40m preamp; transistor vfo; 1972 index; 2m preamp.

73

JAN 73. HT-220 touchtone; 3-el 20m yagi; 50-MHz frequency counter; speech processor; 2-tone generator; FM test set; tilt-over tower; 2m converter using modules; tunable AF filter; six-band linear; 10m i-f tuner; diode noise limiter; CW/SSB agc; HW-22A transceiver 40m mod; HAL ID-1 mod.

MAR 73. A Fast-Scan Facsimile System—use it with SSTV; Six and Two Meter High Power—using a \$25 surplus amplifier; A Digital Tape Distributor for RTTY; The Ample Amplifier—all band, 1200 Watts; Popular SSTV Circuits (Part II); Improving the Indoor Antenna System—using copper foil; FM Deviation Meters; Time Frequency Measuring System (Part III); Another Use for 400-Cycle Transformers; Bandpass Filter Design.

APR 73. FM deviation meter; 2m FET pre-amp; two 2m power amps; repeater control (part 1); repeater licensing; European 2m FM; FM scanner adapter; RCA CMU15 mods; lightning detector; CB alignment gadget; transistor rf power amps (part 2); repeater economics.

JUNE 73. 220-MHz signal generator; UHF power meter; repeater licensing info; RTTY autoswitch; 40m hybrid vfo TX; antenna polar mount; 10-15-20m quad; K2OAW counter mods; double coax antenna; ham summer job; tone decoder; field strength meter; nicad battery pack; ohmmeter; FCC regs (part 1).

JULY 73. Tuneable Oscillators for 2m FM Receivers; Basic ATV System—a T-44 transmitter strip does most of the work; Multiple Output Frequency Standard—lets you calibrate your receiver in .0625-Hz increments; Digital Identification Unit; 450-MHz Power Divider—easily-constructed matching system for stacked arrays; CW Filters. Bared and Compared—complete with scope traces and bandwidth specs; 85 dB Gain 2m Antenna; Compromise Multiband Antennas; Grid-Dip Tuning the Quad Antenna.

AUG 73. Log-periodics (part 1); tone burst generator; rf power amp design; transistor radio intercom; 160m antenna; SSTV monitor; low-cost frequency counter; VOM design; QRP 40m TX; 432-MHz exciter; FM audio processing; FCC regs (part 3).

SEPT 73. Repeater control system; log periodics (part 2); 2m RX calibrator; PLL IC applications; TT pad hookup; Heath HW-7 "S" meter; OSCAR-6 Doppler; 2m coaxial antenna; 2m converter; IC keyer; measure antenna Z; FCC regs (part 4).

NOV 73. 450-MHz exciter; intro to ATV circuits; nicad voltage monitor; autopatch connections; IC meter amplifier; TR-22 ac supply; indoor vertical; IC AF filter; momentary power failure protection; 160m antenna coupler; Motorola HT info; SSTV-15B; Class B AF amp; FCC regs (part 6).

74

FEB 74. SSTV monitor info; IC audio amps; scope sweep generator; 15/20m vertical; telephone line control system; PC board construction; var-Q AF filter; blown-fuse indicator; 40m CW station with Ten-Tec modules; simple preamp compressor; single-IC RX; "432-34" final assembly; transistor keying circuit; 7-segment readout with nixie driver.

APR 74. VOX for repeaters; tone-operated relay; HF transverter; 10 to 2m TX converter; remote control panel for scanner; RCA FM TX tuning; subaudible tone generator; FCC regs (part 9); repeater atlas.

MAY 74. CD car ignition; audio compressor info; interference suppression for boats; auto burglar alarms; 2m IC preamp; 10m FET converter.

JUNE 74. Poor Man's Quad; Reconciling the Long Squared Quad—developing a new type antenna; Antenna Load Indicator; Matching; Remotely tunable Antenna Coupler; A Practical Ground System for 160; Wide-Range Antenna Tuner; Old Antennas and New Baluns—build a double zepp; A Multiband Ground Plane—10-40 meters; Mod Quad for Frustrated Cliff Dwellers.

JULY 74. 4-1000A linear; universal frequency generator; universal AFSK generator; 555 IC timer; 80m phased array; 135-kHz-432-MHz preamps; 10m QRP AM TX; 3000 V dc supply; how to read diagrams.

AUG 74. Toroidal directional wattmeters; 450-Hz FET preamp; use gdo to find "C"; Trimline TT pad hookup; R390 & R392 RX mods; tracking CW filter; aural voltmeter; universal regulated supply; SSTV scan converter; TTL logic problems; ID timer.

SEPT 74. MOSKEY electronic keyer (part 1); WX warning system; Heath IO-103 scope mods; QRP 6m AM TX; rf speech clipper; audio noise limiter; WX satellite on SSTV monitor; universal IC tester; miniature rig construction; tower construction; infinite rf attenuator; electronic photo flash ideas; IC "select-o-ject."

OCT 74. Microtransistor circuits; synthesized HT-220 (part 1); repeater government; regulated 5 V dc supply; FM Selcal; removable mobile antennas; Motorola metering; 2m vertical collinear; Motorola model code; 2m coaxial dipole; 1.6-MHz i-f strip; MOSKEY electronic keyer (part 2); carbon mike circuit; hi-power lo-pass filter; 6m preamp; 3-wire dipole; ATV sync generator; NCX-5 mods; mobile whip for apartment dwellers; SSTV automatic vertical trigger.

NOV 74. K2OAW counter update; regulated 5 V dc supply; wind direction indicator; synthesized HT-220 (part 2); 20m 3-el beam; autopatch pad hookups; double-stub antenna match; Novice class instruction; digital swr meter (part 1); 6m converter (1.6-MHz i-f); "C-bridge"; MOSKEY electronic keyer (part 3); Aug. SSTV scan converter errata; repeater off-frequency indicator.

DEC 74. Care of nicads; wind speed/direction indicator; WX satellite video converter; electronic keyer; hints for Novices; unknown meter scales; SSTV tape ideas; TTL logic probe; public service band converter; tuned-diode test receivers; digital swr meter (part 2); telephone pole beam support; rhombic antennas; 1974 Index.

75

FEB 75. Heath HO-10 scope mod for SSTV; electronic keyer; digital satellite orbital timer; OSCAR-7 operation; satellite orbital prediction; Heath SB-102 mods; comparing FM & AM; repeater engineering; Robot 80-A SSTV camera mod; neutralizing Heath SB-110A; "Bounceless" IC switch; tape keyer for CW TX.

MAY 75. IC Callsign Generator; Playing with Power on 432; Does Ether Cause Gravity?; OSCARING Your FM Rig; In Pursuit of the Perfect SSTV Picture; Ac Power for the HW-202; You Can Work 75m DX; The Postage Stamp Squealer; disaster in Honduras.

JUNE 75. Home Brew this SSTV Monitor; El Cheapo Superbeam; The Smart Alarm; RF Power at 432; Dirt Cheap Tunable I-F for Converters; All Band Frequency Marker; Front Burner for Six; Three on Fifteen; Presto! Transistor Checker from VOM; How to Put on a Professional Slide Show.

JULY 75. OSCAR Special! Antennas for OSCAR—What Really Works?; How You Can Take OSCAR's Temperature; FM Alignment Oscillator; The Audio Synthesizer for RTTY, SSTV and Whatever; Ham Radio in the Arctic—1925; Gee, What's a Zepp?; Vertical Antennas for the Novice; Preventing Regulator Carnage; The Ultimate in Variable Selectivity; Phone Patching—A Public Service.

AUG 75. 146/432-MHz helical antennas (part 2); 20 minute ID timer; digital swr computer (part 1); debugging rf feedback; DVM buyer's guide; WX satellite monitor; CMOS "accu-keyer"; PC board methods; sweep-tube final precautions; compact multiband dipoles; small digital clock; accessory vfo for HF transceiver; modern non-Morse codes; multi-function generator; 2m scanning synthesizer errata; KP-202 walky charger; 10m multi-element beam.

SEPT 75. Calculating frequency counter; WX satellite FAX system (part 1); IC millivoltmeter; three-button TT decoder; troubleshooting SSTV pix; 40m DX antennas; 146/432-MHz helical antennas (con-

clusion); digital swr computer (conclusion); reed relay for CW bk-in; NE555 preset timer; power-failure alarm; portable QRP rig power unit; precision 10 V dc reference standard; 135-kHz i-f strip; telephone handsets with FM transceivers; Motorola T-44 TX mod for ATV; 0-60-MHz synthesizer (part 1); ham radio PR.

OCT 75. A deluxe TTY keyboard (part 1); op amps: a basic primer; an introduction to microprocessors; 2m synthesizer (conclusion); satellite FAX system (conclusion); regulated supplies (dispelling the mystery); digital logic made simple; FCC interview; a contest uP system; digital clock timebases; the operating desk; QRP 432; ham PR.

NOV-DEC 75. Blockbuster double issue! Flip-flops exposed; breakthrough in fast scan ATV; strobing displays is cool; the tuned lunch box (antenna tuner for HF transceivers); a deluxe TTY keyboard (part 2); the 127' rotating mast; less than \$100 multi-purpose scope for your shack (part 1); predicting third-order intermod; feedline primer; QRMing the Third Reich; why tubes haven't died; instant circuits—build your own IC test rig; the K2OAW synthesizer PROM-oted; a ham's intro to micro-processing; ground fault interrupter (a keep-alive circuit for yourself); a \$1 strip chart recorder; an even simpler clock oscillator; the Fun City surplus scene; updating the Heath IB-1101 counter; 256 pages!

76

FEB 76. Build a Starfleet Communicator—Trekkies special; Synthesized IC Frequency Standard! You Can Make Photo PC Boards; How's Your Speech Quality?; ASCII-to-Baudot converter; RTTY Autocall—the Digital Way; Improving the FT-101; Night DXing on 10 and 15m; Really Soup Up Your 2m Receiver; Put Your SB-10 on 160m.

MAY 76. Special Antenna Issue! The Magnificent Sevens Microhelix; An Allband Inverted Vee; Closed Loop Antenna Tuning; The 75-80m Broadbander; The Magic of a Matchmaker; How to Coax Your Antenna; 40m DXing—City Style; The Secret 2m Mobile Antenna; An Inverted Vee for 160/80m; The Dipole Dangler; Amateur Weather Satellite Reception; Scan Your HR-212; A Very Cheap I/O—the Model 15; Code Converter Using PROMs; A Nifty Cassette-Computer Systems; The Ins and Outs of TTL; Build a CW Memory; 5/8-Wave Power for Your HT; 555 Timer Sweep Circuit for SSTV; AM Is Not Dead—It Never Existed at All; Computer Languages—Simplified.

JUNE 76. VHF Special! Super COR—Digital, of course!; Touchtone Decoder—using a calculator readout; Simple Amateur TV Transmitter; Amateur TV Receiving System; Mobile Autodialer; Autocall '76—using a touchtone decoder; Build This Lab Type Bridge—and measure transformer impedances; How Those Triangle Things Work—a sort of op amp handbook; Those Exciting Memory Chips—RAMs, ROMs, PROMs, etc.; ASCII/Baudot with a PROM—for ribbonless RTTY on computers; Aim Your Beam Right—with a programmable calculator.

JULY 76. Perfect CW—drive 'em crazy with the keycoder I; The Mini-Mite Allband QRP Rig—a mighty 7 Watts; A Fun Counter Project—under \$50; Build a FAX from Scratch—then get satellite pictures and other things; Der Repeatermeister—repeater control with ID; The Giant Nixie clock; Creative SSTV Programming; CW Regenerator/Process; What's Up on 156 MHz?; TT Pad for the Wilson HT; Power Supply Testing—to save your digital circuits; A RTTY/Computer Display Unit; Your Computer Can Talk Morse; Gain for Your HT—a half-wave whip; The Super Transmatch; Simple VHF Monitor.

SEPT 76. The Surprising DRRR Low Noise Antenna (part II); Ultrasimple Regulation with New IC—power supply design greatly simplified; Can an Indoor Antenna Work?—making the best out of a bad bargain; Inexpensive 12 Volts for Your Base Station; A Test Lab Bonanza—using a transistor radio; Protect Your VHF Converter—novel antenna relay; ridiculously simple RTTY System; How to Catch a CBer; A 450-MHz Transceiver for Under \$130; Space Age Jungle II; PROM Memory Revisited; Eight Trace Scope Adapter;

The PROM Zapper; Sneaky Baudot—with an ASCII keyboard!; Simple Graphics Terminal—using surplus; Counters Are Not Magic—they're simple.

OCT 76. Build a Weird 2 Band Mobile Antenna; Build a Counter for Your Receiver; How Do You Use ICs? (part II); QRP Fun on 40 and 80—have a real ball with just 5 Watts; The Hybrid Quad—low windload, expense, hassle!; Frequency Detector for Your Counter; Programmable CW ID Unit—for RTTY, repeaters, mobile, etc.; New ICs for the Counter Culture—simpler counters with less used power; Is My Rig Working or Not?—build an effective radiated field meter and know!; Quickie Collinears for 15 and 10—satisfaction guaranteed; Build a Super Standard—goes right down to 1 Hz; The Incredible Lambda Diode; Mechanical RTTY Buffer; Have You Used a Triac Yet?; How To Interface a Clock Chip—Baudot, BCD, or ASCII conversion; A TTL Tester—great for unmarked bargain ICs; The New Ham Programmer—making those confounded uPs work; BASIC? What's That—the basics of BASIC; The Soft Art of Programming (part I).

NOV 76. Blockbuster 288-pg. issue! Cordless Iron Tips; Bicycle Mobile; Build a Simple Lab Scope—costs less than \$70!; Get on Six with Surplus—the el cheapo RT-70 is a natural; The Beam Saver—rotor memory system; Updated Universal Frequency Generator; The Shirt-Pocket Touchtone; Liquid Crystal Display Guide; Self-Powered Mike Preamp; The Wind Counter; The S38 is Not Dead! The Amazing Inverted L—antenna for 20, 40, and 80m; Battery Chargers Exposed; How Do You Use ICs (part III); Thirty Years of Ham RTTY; Big Noise Burglar Alarm; Dandy Digital Dial Decoder; Weather Satellite Display Control; Ham Time-Sharing Is Here for You!; The Soft Art of Programming (part III); OSCAR Smoke Tester—power supply tester; The Man Who Invented AC—Tesla, the greatest pioneer of them all; Baudot to ASCII—you want to learn programming?; Baudot and BASIC—an interpreter for a Baudot computer; Toward a More Perfect Touchtone Decoder; Using a Wireless Broadcaster; The Quiet Spy—amateur uncovers spy ring in the US!; The Benefits of Sidetone Monitoring—and how to do it.

DEC 76. Go Tone for Ten—simple sub-audible encoder; World's Simplest Five Band Receiver?; How Do You Use ICs? (part IV); A Super Cheapo CW IDer; The ZF Special Antenna; CT7001 Clockbuster; Saving a CBER; A Ham's Computer; What's All This LSI Bunk?—an ostrich's eye view of the microprocessor; The Soft Art of Programming (part III); Put Snap into Your SSTV Pictures—using a \$20 frequency standard; What's All This Wire-Wrap Stuff?—talk about cold solder joints! Exploding the Power Myth; Exploding the SWR Myth; The IC-22 Walkie—portabilization with nicads; Watch DX with a Spectrum Analyzer; DXing with a Weather Map.

HOLIDAY 76. 55-article issue! An Inexpensive 400-Watt HF Amplifier; How Do You Use ICs? (part V); Mobile Smokey Detector—10.5 GHz; use it or lose it!; Add RIT to Your Transceiver; DXpedition: Memories for a Lifetime—reflections of HK1TL; Design Your Own QRP Dummy Load; Fail-safe Super Charger—multi-rate, too!; The Amazing 18" Antenna for 160m; Replacing the Knife Switch—simple TR system for the Novice; Now You Can Synthesize—the VHF Engineering approach to 2m happiness; Hutchinson's Remedy—the chirpless CW machine; The Mod Squad Does the Pocket Scanner—Radio Shack Pro-4 update; TR-22 Mod Squad; What Computers Can and Can't Do; A Ham Shack File Handler—program in BASIC for QSLs, repeaters, etc.; Print Your Own Logbook—on your nearest computer; Shoeing Your HT; Cash In on the CB—installation for fun and profit; Tuning Those Big Antenna Coils; The 2m Mod Squad Tackles the Weather Radio—and wins!; Hamming by laser; A 60-Foot Antenna on a 20-Foot Lot—solving a 40m Novice problem; Dual-Voltage Power Supply; An Autopatch Busy Signal; Inside the GLB—a gutsy look at a synthesizer! How to Bug an Automatic Keyer; A 450 Duplexer—that fits in your car; Will Silver-Zinc Replace the Nicad?

77

JAN 77. SSTV Test Generator—invaluable diagnostic tool; How Does Your Rig Perform?—an example using the HW-7;

What's The Best Antenna for 160?—the inverted vee compromise; 200 lb. Cookie—microwave repeater control; A Super Log—a program for the ham shack computer; Practical Solar Cell Power—great for remote repeaters; A Simple RC substitution Box—using a matrix; Double Sideband: Something New?—one for voice, one for SSTV; A Vest Pocket QRP Rig—if you have a big one; Antenna Magic—good advice on antenna fundamentals. Plus 40 more.

FEB 77. Give That Professional Look To Your Home-Brew Equipment—win prizes; Give the Hamburglar Heart Failure—car alarm system; Contest Special Keyer—has short but adequate memory; You Can sound better With Speech Pre-emphasis—a simple circuit which will work wonders; Getting a Patent—Is It Really Worth It?—how to do it, if you really want to; SSB: The Third Method—bet you can't even name the first two; The TTL One Shot—another digital building block; Computerized Satellite Tracking—the needed software; Drive More Safely With A Mobile Dialer—hold 4 or 8 phone numbers in a PROM; Tune Up A Random Wire—world's simplest antenna for 80-15. Plus 10 more.

MAR 77. Pitcairn Island—an inside look at VR6TC; How Do You Use ICs?—part VI; PROM Message Generator For RTTY—keyboards are obsolete; Inexpensive Variable DC Supply—easy and quick; The History of Ham Radio—part I; Versatility Plus For the HW-202—external channel mod; Making Your Own PC Boards—part I; Announcing the PCF—legal aid for ham problems; Build Your Own Car Regulator—solid state; The Happy Flyers—fun and public service. Plus 15 more.

APR 77. RTTY? What's That?—how to get started with teletype; Making Your Own PC Boards—part II; 80 CW for the 6800—it works; The Super Clock—what'll they think of next?; The Final Feeder—driving a high power amplifier; What About Surplus Nicads?—how to test and repair them; The History of Ham Radio—part II; Retire to a Ham Heaven—how to go on a permanent DXpedition; The Carbon Marvel—best mobile mike yet?; The Minicom Receiver—finally, a QRP allbander. Plus 25 more.

MAY 77. Build The World's Simplest Keyer—uses 555 timers; Predict the Weather!—a complete satellite receiver; The History of Ham Radio—part III; Let BASIC Control Your Next Contest!—with Extended Tiny BASIC language; Understand Your Pet Rock—tips on crystal oscillators; TTL Techniques—bypass those glitches; Stop Timeouts!—build this 10-minute ID timer; Quick Vertical—for 20 and 40; Try Power Saver Logic—a guide to CMOS applications; All-Electronic Selcal—uses a UART for versatility. Plus 24 more.

JUNE 77. Build This CW Filter—darned good; The W1BB Story—a visit with the king of 160; Ten Watts on 2—it's possible with this rock crusher!; At Last! A 10m Band Plan—requires a CB radio; Sheet Metal Brake—build microwave components; Practical P.S. Design—do it right this time; Regulated Nicad Charger—don't cook 'em! Current-Saver Counter Display—multiplex those LEDs!; New PC Techniques Unveiled!—dig out your old chemicals; How Do You Use ICs—part VII. Plus 22 more.

JULY 77. A Battery Voltage Monitor—how simple can an IC project get?; Hunting Noise—with a grid dipper; Hams Profit From CB—how to set up a service center; Patch Up Your 101—simple mod for the HW-101; Dipole Designer Program—calculates coils and length; CB to 10—parts III, IV, and V; World's Smallest Continuity Tester—it's almost minute; Digital Synthesizer—revitalize old xmtr strips; Phone Patch Tips—a lost art?; Digital Clock Fail-Safe—so you won't miss the train. Plus 18 more.

AUG 77. Antenna Special! Centerfed Specials—for the small city lot; Build a Double Bazooka—give your signal a blast; Dirt Cheap Directional Array—for the serious DX hound; Instant PS Regulation—a quickie; The Zepky Vertical—a perfect 2m antenna; The 8JK Array Revisited—inexpensive and effective; Build a Brute Power Supply—completely regulated and protected; Computer Logger—for those who keep logbooks; build a kW Linear—a 4-1000 provides the punch; PC Layout Tips—next time, do it right! Plus 44 more.

SEPT 77. RTTY Special! A FAAR-OUT DX-pedition—airborne VHF and OSCAR!; So You Want to Get into RTTY?—"Call For Papers" winner; Design an Active RTTY Filter—eliminate CW QRM and noise; Build a RTTY Message Generator—it's programmable!; FSK for the Drake—easy; Baudot To ASCII Converter—use it for OSCAR RTTY; RTTY With the KIM—features built-in display!; FSK for the FT-101—a simple mod for RTTY; Noise Rejector—great for CW or phone receivers; A Practical 2m Synthesizer—who said it can't be built? Plus 17 more.

OCT 77. W.A.S.—Easily!—catching the last few; Try Your KIM-1 on RTTY—CUL on your computer; Try a Trapped Dipole—save copper and coax!; Novice Antenna Specials—tips for that first antenna; Traffic Handling Explained—a lost art?; One-Cent Channels For the IC-22S—inflation fighter!; Sensitive Meters Saved; Add Jazz to Your Tempo—with a few simple mods; Interested in Television?—how to get started; Digital To Audio Decoder—for the blind operator. Plus 26 more.

DEC 77. The History of Ham Radio—part V; How Do You Use ICs?—part VIII; A Kilo-watt Alternative—try a gain antenna; The DA4FB Story—American repeater in Germany; Computerized Global Calculations—finding the best way to Pago Pago; Run, Sheila, Run!—real-life radio control; CB to 10—parts VI and VII; amplitude vs. Frequency—poor man's spectrum analyzer; Regenerated CW—CW as you like it. Plus 41 more.

78

JAN 78. Build a Better Phone Patch—hybrid op amps—the works; Build a 3 1/2 Digit DVM—replaces old meters!; QRP Hints—for low-power freaks; Custom-Made Thermistors—for precise values; UHF Propagation—believe it; Put an ELF in Your Keyer—sneaky computer strikes again; CB to 10—part VIII; The Extreme Basics of Antennas—for pre-Novices; Versatile Transistor Tester—save expensive devices; How to dissipate 200,000 Megawatts—fool Mother Nature. Plus 36 more.

MAR 78. Old Rigs Can Live Again!—a guide to their resurrection; Novices, Padlock Your Way to Happiness—super deluxe Novice Keyer; 1220 MHz—Use It or Lose It!—simple gear you can build and enjoy; New Protection For Your Car—simple force field system; The World of Tone Control—a virtual encyclopedia on the subject; Another Approach to the ASCII/Baudot Headache—a Model 15 and an SWTP system; Surprisingly Low-Cost Lab Supply—an IC regulator does it!; The Solar-Powered Ham Station—one hundred Watts, yet!; Are You Afraid To Build?—how to get organized and started; How to Use a Varactor—And Why—semi-exhaustive article. Plus 33 more.

APR 78. How to Succeed on 1296—catfood can 50-Watt amplifier; How Do You Use ICs?—part IX; The Challenge of 10.5 GHz—use it or lose it to Smokey; Now Anyone Can Afford a Keyboard—surplus keyboard, KIM, and software; Is TTL Already Obsolete?—CMOS vs. TTL; Improve Your HW-202—more flexibility, etc.; Simple CW Interference "Filter"—diode code regeneration; How Sunspots Work—basics for the Novice; Use Noise to Tune Your Station—build this simple noise generator; Danger! Microwave Radiation!—just how much is dangerous? Plus 19 more.

MAY 78. Official FCC RFI Report—curing radio and TVI; Fake 'Em Out With Remote Control—TT-operated control unit; Now—A Digital Capacity Meter!—simple construction project; DMM Survival Course—"all" about using digital multimeters; Build This Excitingly Simple Receiver; Diary of a Survivor—cyberosis victim tells all; The Super Select-o-Ject—kill rotten QRM with this filter system; The Miser's Delight Repeater Controller—the very ID!; Make Antenna Tuning A Joy—Instant swr bridge; The COR Goes Solid State—turning two Midland rigs into a repeater. Plus 18 more.

JUNE 78. Antenna Special! Wait Till You Try 16 Elements!—15 dB gain on 2m is a real kick; Working 15m with a 20m Beam—by adding three more elements; Resurrecting the Beverage Antenna—try this

55-year old, low-noise, low-band antenna; Better Than a Quad?—try a delta loop; Towering Low-Band Antennas—berserk mathematician figures impedance; Modernize the Matchbox—increased capability for a classic coupler; The 75m DX Chaser Antenna—the 5/8λ works on 75m as well as 2m; Computerized Loop Antenna Design—in BASIC; Novice Guide To Phased Antennas—part I; The 21-Element Brown Bomber—2m beam with sadistically strong signal. Plus 29 more.

JULY 78. Reincarnating Old Test Equipment—a 1942 capacitance meter is born again; Novice Guide to Phased Antennas—part II; Build Your Own Digital Dial—great update for your receiver; Your Scope Can Be Improved—simple calibrator; The \$5 Memory Keyer—for lazy cheapskates; RAMmed By Morrow—ECONRAM III lauded; VHF Notch Filter—rejection can be beautiful; Yes, You Can Build A Synthesizer!—220-MHz synthesizer for under \$50; A Darn Good IDer—repeaters get smarter every day; VHF Transverters and the FT-101—quickie FM conversion. Plus 34 more.

AUG 78. Radio Row Revisited—it's alive and well in Tokyo; A Complete X-Band Transmitter—easy to build; Power Line DX—(almost) wireless remote control; The End of RF Feedback—here's how the pros do it; CB to 10—part IX; A WWV Primer—become a calibration freak; Super Charger—keeps nicads up to snuff; HW-101 Owners, Check This!—RIT mod for the good old HW-101; Ham Radio Is NOT a Rich Man's Hobby—another myth exploded; New Life for Double Sideband?—awake, ye pioneers, and get cracking. Plus 34 more.

SEPT 78. Another IC-22S Scheme—for oddball repeaters; Tracking the Wild Turkey—DF tips; DVM Scrapbook—the basics; How Do You Use ICs?—part X; Computerized QSO Records—who needs a logbook?; CB to 10—parts X & XI; Build the Triple Threat Keyer—great Novice project; The Ten Meter AM Antenna Special—\$5 vertical also works on SSB or FM; Build the IC Experimenter—getting started with TTL and CMOS; Two Meters at the Summit—a backpackers delight. Plus 37 more.

OCT 78. DXpeditioning—a "how to" guide; The History of Ham Radio—part VI; Building From Magazine Articles—the breadboard/wire-wrap way; High Seas Adventure—Ham Style—part I; Use a Computer? Who, Me?—yes, you!; Bird Watching in BASIC Land—another use for your micro; World's Cheapest QSLs—BASIC program keeps your log, too; Happiness Is a Smart Scanner—mods for the PBM/AWE FMSC-1; A Perfect Power Supply?—well... almost; Antenna Design: Something New!—controlled-current distribution. Plus 37 more.

NOV 78. Murphy's Masterpiece—the lost weekend; How About Some Ham Shack Safety?—don't be a statistic; The History of Ham Radio—part VII; CB to 10—part XIV; A Realistic PLL rig; High Seas Adventure—Ham Style—part II; Squelchifying Cheap Receivers—junk-box project; Build the Brute—unique heavy-duty power supply; The Circuit Board Aquarium—no fish story; Who Needs Transistors?—you do!; Ham Help!—a telephone aid for the blind. Plus 47 more.

DEC 78. A DXer's Dream Vacation—try sunny Montserrat; Close Encounters—the eyes of Texans are upon them; Receiver Diseases—and how to cure them; Confessions of a Stripper—confirmed junker tells all; Whither Microcomputers?—a pro looks ahead; "This is Your Computer Speaking"—how to dial up your micro; Big Max Attacks—it's W2DU vs. K4KI, in the battle of the bazooka; WARC '79 Preview—showdown in Geneva; Build the Flexi-Filter—a very active device; Code-Practice Oscillators—an exhaustive report. Plus 29 more.

Also Available: December, 1960; June, July, August, September, October, December, 1961; January, February, November, 1962; January, April, May, July, September, November, 1963; January, March, April, July, September, October, November, December, 1964; May, June, July, August, December, 1965; August, September, December, 1966; January, February, March, April, June, August, September, December, 1967; January, March, April, May, August, October, December, 1968; October, 1970.



Send 10¢ for our latest catalog. Write or phone for more details.

JAN CRYSTALS easy to charge

2400 Crystal Drive
Ft. Myers, Florida 33907
all phones (813) 936-2397

AMATEUR TELEVISION

FAST SCAN 420-450 MHz

APTRON OFFERS THE ATV ENTHUSIAST THE MOST COMPLETE LINE OF EQUIPMENT AVAILABLE

- *Model 1570B ATV REPEATER a complete unit-transmitter, receiver-demodulator, control, identifier, power supply
- *TXR15A ATV TRANSCIVER a complete unit-15w transmitter with subcarrier sound, dual frequency xtal converter-ch2 or 3 out, power supply
- *TX 15A ATV TRANSMITTER a complete unit-15w, subcarrier sound, power supply
- *XR 70B XTAL CONVERTER dual frequency, ch2 or 3 out, high performance, power supply
- *XD 25 B IN-LINE DETECTOR samples-defects video modulation at xmtr output, video output drives any standard tv monitor
- *TD100A VIDEO-AUDIO DEMOD demodulates converter output, video drives monitor, audio drives speaker, power supply
- *TV HANDBOOK for the AMATEUR

Call 812-336-4775, or write for our detailed catalog.

APTRON LABORATORIES
PO Box 323, Bloomington, IN 47402

FOR BEST PRICE AND FAST DELIVERY CALL

1-800-325-3636

TOLL FREE

HAM RADIO CENTER

8340-42 Olive Blvd. P.O. Box 28271 St. Louis, MO 63132

ALL BAND TRAP ANTENNAS!

PRETUNED - COMPLETELY ASSEMBLED - ONLY ONE NEAT SMALL ANTENNA FOR UP TO 6 BANDS! EXCELLENT FOR CONGESTED HOUSING AREAS - APARTMENTS LIGHT - STRONG - ALMOST INVISIBLE!

FOR ALL MAKES & MODELS OF AMATEUR TRANSCIVERS - TRANSMITTERS - GUARANTEED FOR 2000 WATTS - SSB 1000 WATTS CW. INPUT FOR NOVICE AND ALL CLASS AMATEURS!

COMPLETE AS SHOWN with 90 ft. RG58U-52 ohm feedline, and PL259 connector, insulators, 30 ft. 300 lb. test dacron end supports, center connector with built in lightning arrester and static discharge - molded, sealed, weatherproof, resonant traps 1"X6"- you just switch to band desired for excellent worldwide operation - transmitting and receiving! WT. LESS THAN 5 LBS.

160-80-40-20-15-10 bands 2 trap---209 ft. with 90 ft. RG58U - connector - Model 777BU ... \$64.95
80-40-20-15-10 bands 2 trap --- 102 ft. with 90 ft. RG58U - connector - Model 998BU ... \$59.95
40-20-15-10 bands 2 trap --- 54ft. with 90 ft. RG58U coax - connector - Model 1001BU ... \$58.95
20-15-10 bands 2 trap --- 26 ft. with 90 ft. RG58U coax - connector - Model 1007BU ... \$57.95

SEND FULL PRICE FOR POST PAID INSURED DEL. IN USA. (Canada is \$5.00 extra for postage - clerical - customs - etc.) or order using VISA Bank Americard - MASTER CHARGE - AMER. EXPRESS. Give number and ex. date. Ph 1-308-236-5333 9AM - 6PM week days. We ship in 2-3 days. ALL PRICES WILL INCREASE MAR 1-SAVE - ORDER NOW! All antennas guaranteed for 1 year. 10 day Money back trial! Made in USA. FREE INFO. AVAILABE ONLY FROM.

WESTERN ELECTRONICS Dept. A7- 9 Kearney, Nebraska, 68847

Kantronics' Field Day™

Morse/radioteletype reader & speed display

only **\$449.95**

Kantronics' Field Day morse code/teletype reader reads code signals right off the air. Its powerful microcomputer system picks out signals, computes their speed and even reads sloppy copy up to 80 words per minute.

The **Field Day** is simple to use. You plug it into your station receiver just as you would a set of headphones. Code and teletype conversations are converted from dots and dashes to standard alphanumeric text. The text advances from right to left across ten big 1/2 inch displays.

The **Field Day** displays incoming or outgoing code speed for you at the touch of a button, right on the front panel. The **Field Day** is enclosed in a compact, lightweight package including speaker. HWD 3.44" by 8.50" by 9.25". The **Field Day** has the features that make it a truly great code reader. Write us for a complete **Kantronics** authorized dealer list.

KANTRONICS
The Lightweight Champs.

1202 East 23rd Street
Lawrence, Kansas 66044
We accept Visa, Master Charge, check and money orders.

Phone: 913-842-7745

The Big Bopper

As an interested amateur, you probably have heard many on-the-air and off-the-air conversations discussing phased antennas. If you have never operated a phased array, you may have wondered—with honest skepticism—whether they really perform well. In particular, are

they generally equivalent to other good arrays and do they have any unique advantages? The answer to both questions is yes. Obviously, there are some qualifications. No single approach to an antenna system can ever be the universal solution to every ham's radiation problem.

But if what you need is an effective radiation system on multiple bands with a low physical profile and you want it to be relatively inexpensive as well as easy to construct and maintain, then you may want to consider a vertical array.

The two-tower vertical

array described here has directional radiation (and reception) characteristics which are easily rotatable. The system is sturdy, attractive, and readily usable on five bands, with no outdoor adjustments required while operating. Standing-wave ratios are

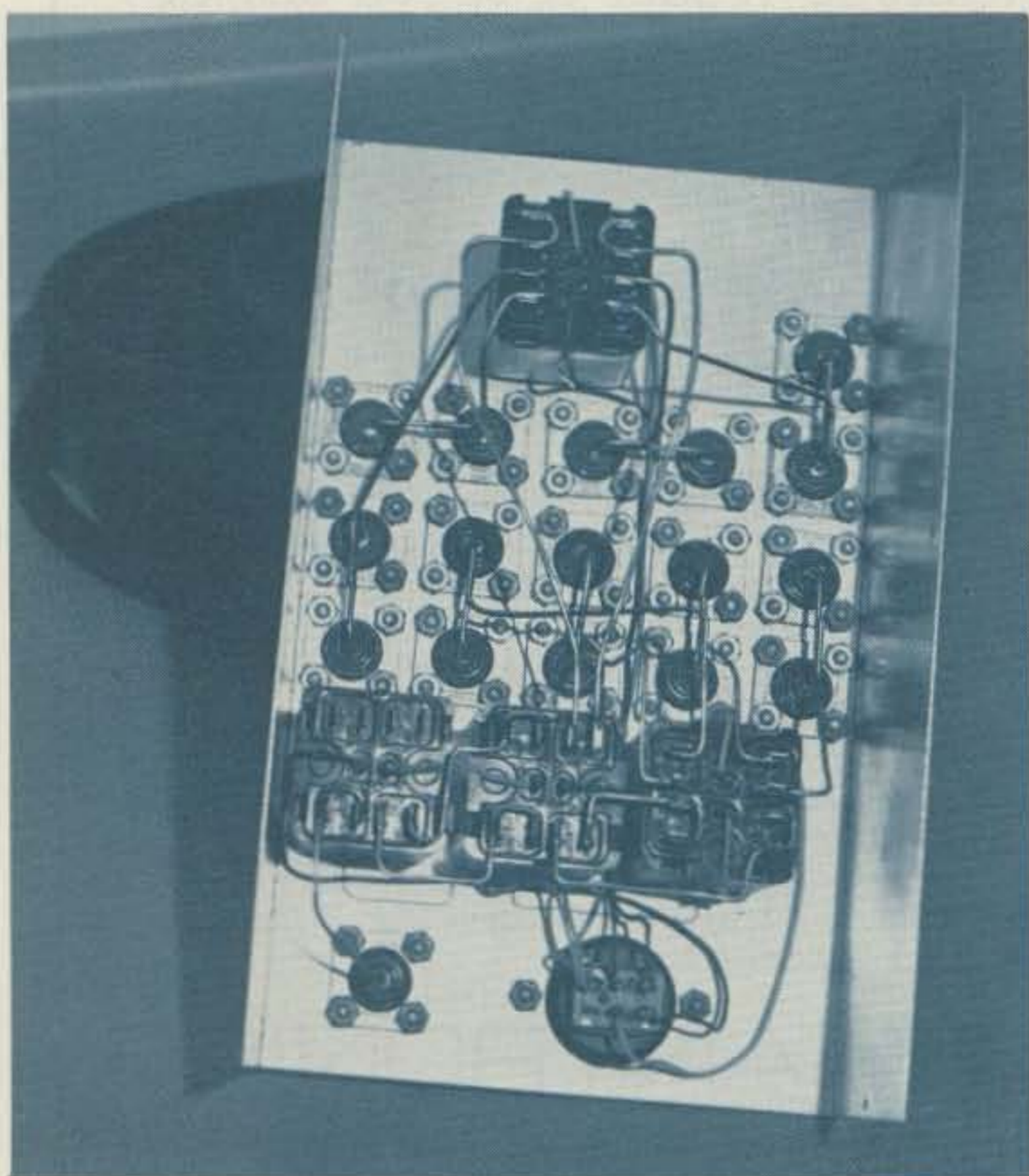

Photo A. Wiring side of the relay switch box.

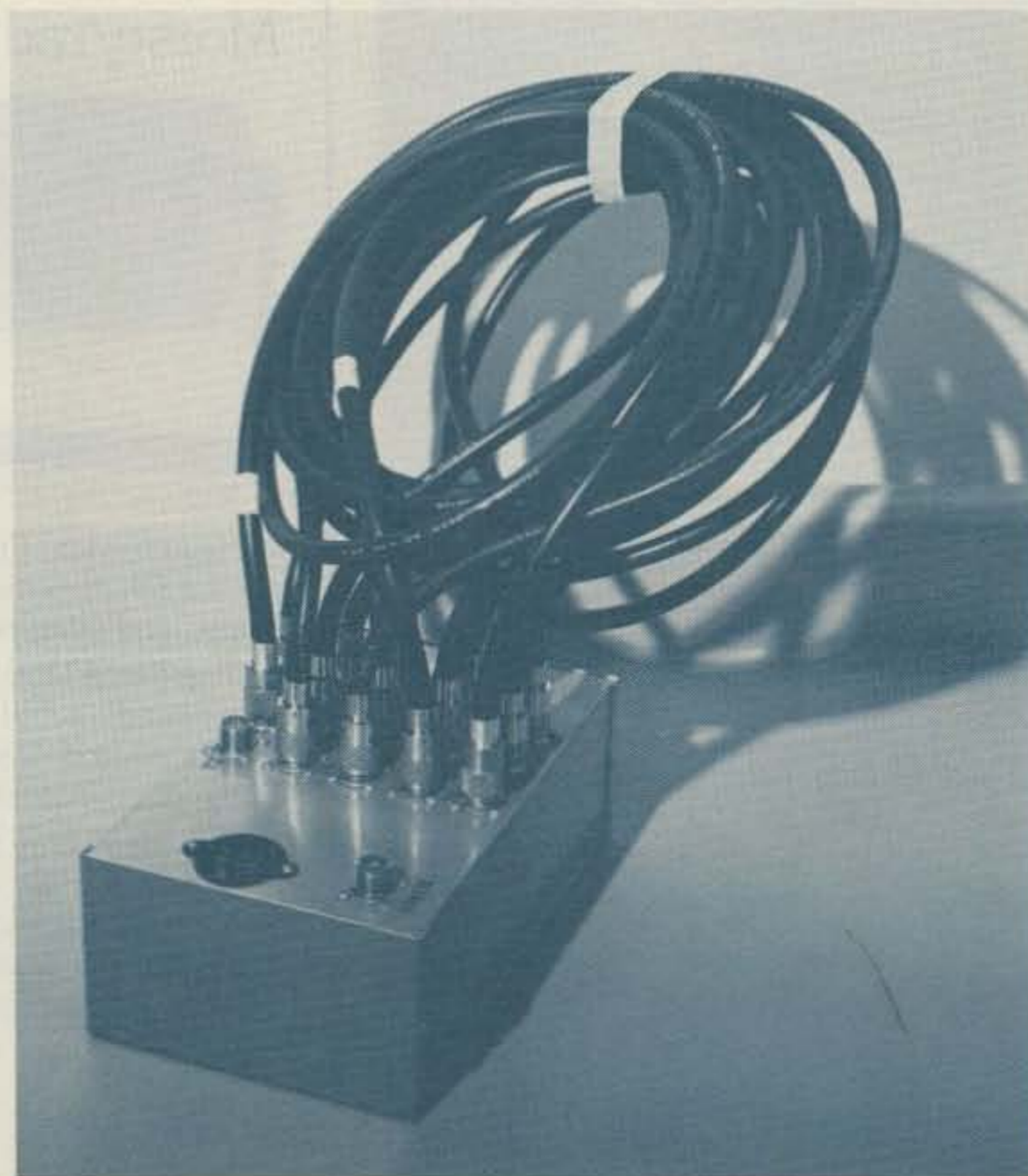

Photo B. Relay switch box "buttoned up" with seven "internal" lines attached.

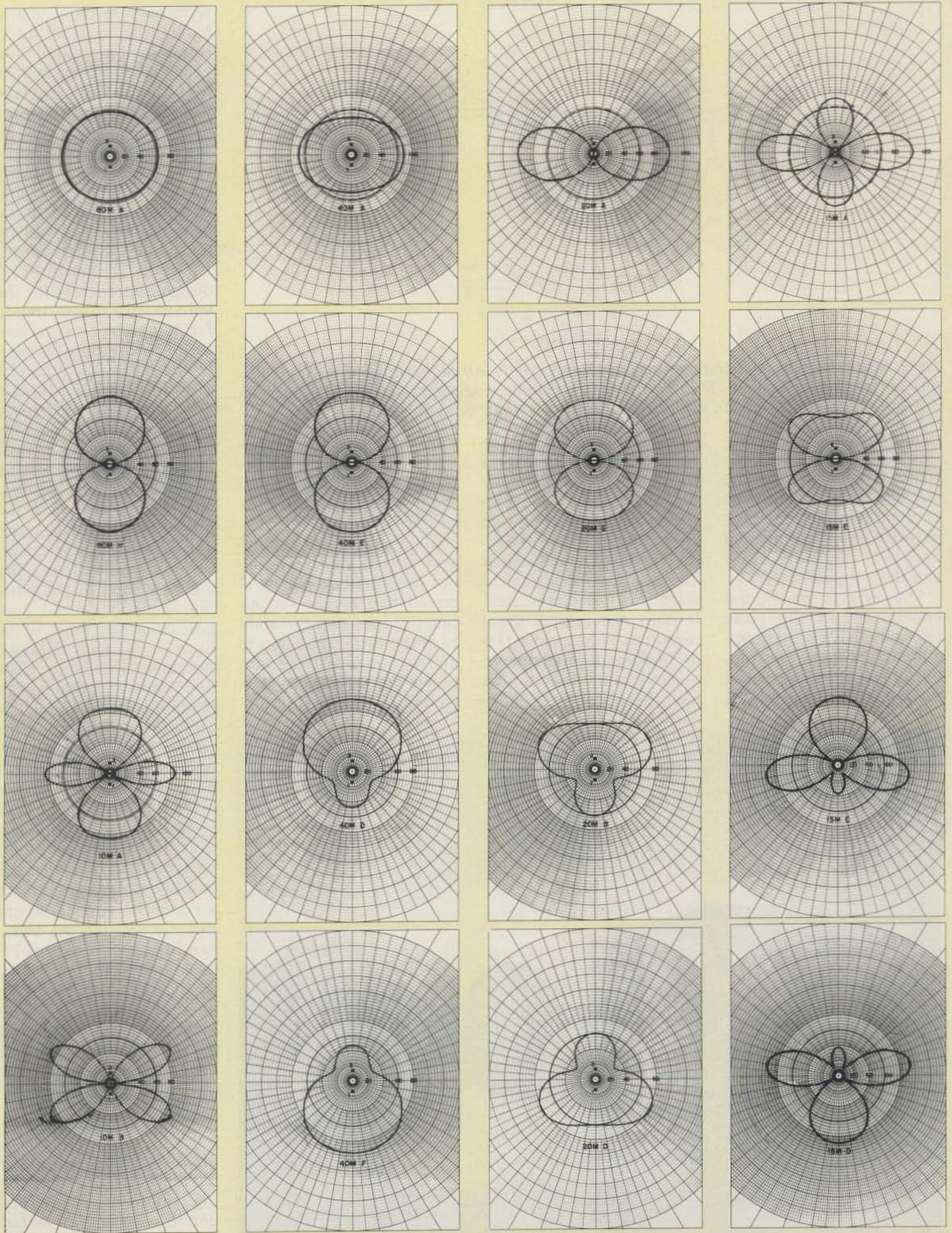

Fig. 1. Idealized radiation patterns. All patterns represent field intensity from 100 radiated Watts. Dots 1 and 2 represent towers 1 and 2. Capital letters represent switch positions. Circles = 61.8 millivolts/meter at one mile. This is the field intensity from a single tower with the same 100 Watts radiated.

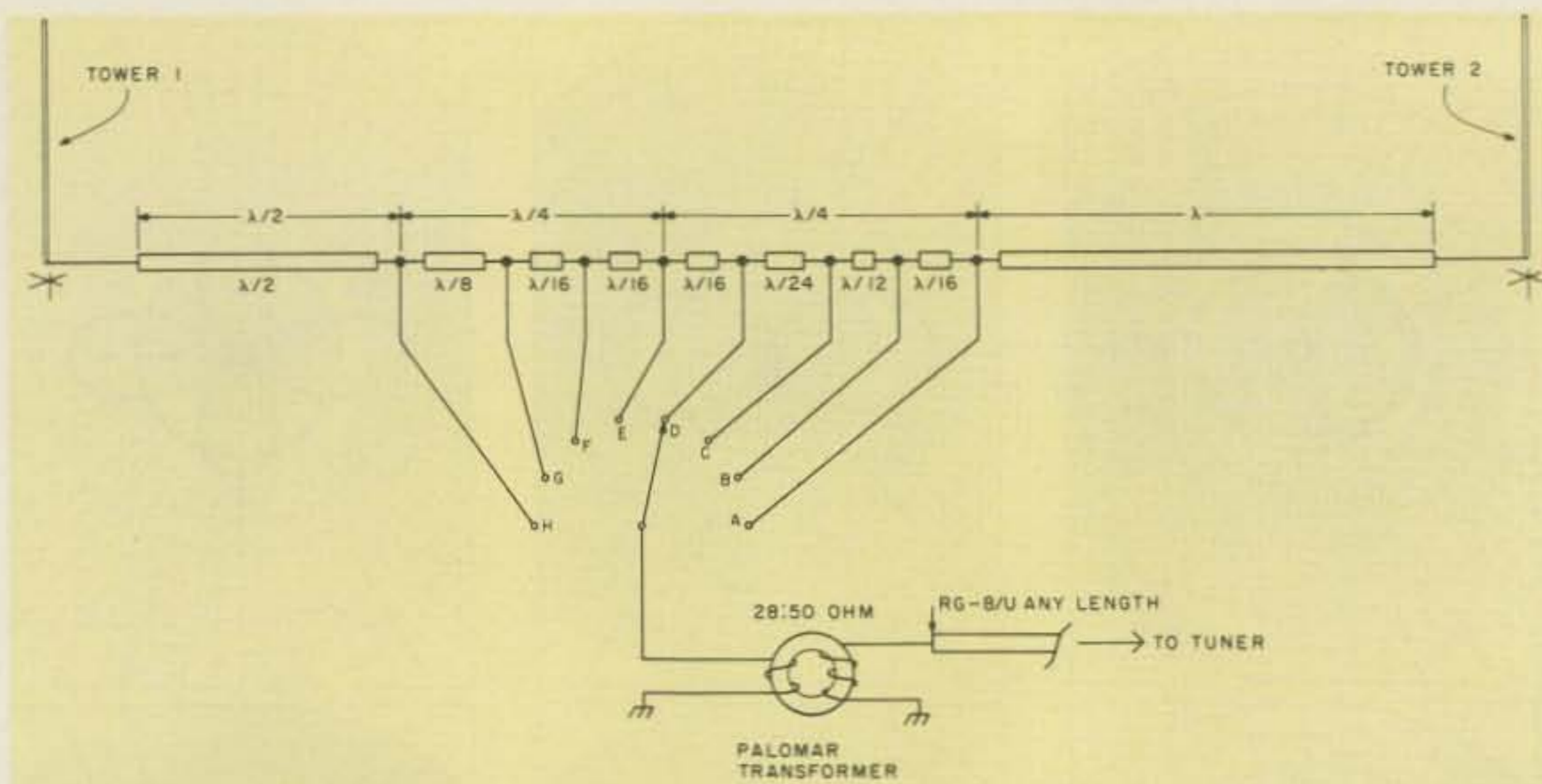

Fig. 2. Block diagram. All notation refers to 40 meters only. All cable and delay lines are RG-8/U or a 50-Ohm equivalent. The transformer is a Palomar Engineers or equivalent (see text). Towers and trapped units on each band are Hustler 4-BTV or equivalent.

moderate under all conditions of operation. The transmission line can be any convenient length. An antenna tuner or matching network is recommended between the transmitter and the antenna system.

The effects of mutual impedance on the array operation have been determined. The radiation patterns have been calculated for typical amateur-level

field intensities. Importantly, the patterns recognize the effects of any unbalanced tower currents which sometimes result. The construction of the array, and its operation, is completely straightforward and uncomplicated. It does not require great resources, either real estate or budget. It may be especially attractive if you have been denied a more

conventional beam because of zoning restrictions, house construction limitations, or general appearance considerations.

Since the tower separation is fixed, the array cannot be equally directional on all five bands. Offsetting this quality is the ability of the system to operate on five bands with the turn of an indoor switch. It is emphasized that this abili-

ty to operate on all major bands with variable directional enhancement on each band is a capability that is not a commonplace feature of typical antenna systems. Also, as will be seen, once the system is tuned to a pattern, it is very tolerant of frequency shifts within a band and can be characterized as having quite a flat load response.

There is no special design requirement for the individual trapped towers. For symmetry, it is recommended that they be nearly the same. Commercial units are readily available and are competitively priced. If your machine shop facilities are limited, buying the verticals may be the quickest and least expensive approach. On the other hand, if you are more venturesome, or able, various means of trapping are described in the amateur handbooks and periodicals which most of us have in our ham libraries. Actually, you may have one vertical antenna already. In this situation, the array discussed may offer you an easy extension in operating capability, with only incremental cost or effort.

This array effectively uses all of the basic lobe patterns that are intrinsic to a two-tower system with a common feedline. Intentionally omitted are some familiar two-tower patterns—perfect cardioids, for instance—that can be generated only with an elaborate feed system so as to maintain balanced tower currents.

The Design Approach

Vertical antennas—towers—used as the basis of the design approach have a number of appealing qualities. They are unobtrusive in residential neighborhoods. Vertical towers with tuned traps allow easy band changing and multiband operation.



Photo C. The desk control unit in place.



KENWOOD

**TECH
TALK**
8C79

AT-120 and AT-180

**Antenna Tuners recommended
for TS-120S and TS-180S
All Solid-State HF Transceivers.**

Why is the use of an antenna tuner so much more important with the TS-120S and TS-180S all solid-state HF rigs than with transceivers having tube-type final amplifiers?

Tube-type final amplifiers generally handle a broader range of load impedance than a transistor final. However, RF power into the antenna system will decrease with an increasing impedance mismatch, and tube life may even be shortened if the mismatch is extreme. Transistor final amplifiers, on the other hand, require a 50-ohm nonreactive load for efficient power transfer and are not very tolerant of high SWR. Therefore, protection circuits are used in the TS-120S and TS-180S to reduce RF power output significantly under high-SWR conditions, thus preventing damage to the solid-state devices.

In the TS-120S, an SWR detection circuit detects reflected-wave voltage, which is then amplified and applied to the ALC circuit as a protective voltage to control power output. Thus, as SWR increases, RF power output decreases continuously.

In the TS-180S, the final amplifier functions normally up to an SWR of 3:1, at which point the protection circuit drops RF power output significantly.

Using an antenna tuner such as the AT-120 to match the TS-120S or the AT-180 to match the TS-180S will lower the reflected power at the transceiver to avoid detection by the protection circuit, thus enabling the transceivers to produce full RF power output and even with rigs which have tube final amplifiers, we recommend an antenna tuner (such as the AT-200 to match the TS-520 or TS-820 Series) for optimum coupling to antennas with high SWRs.

A major advantage of using an all solid-state rig such as the TS-120S or TS-180S is the elimination of final-amplifier tuning and loading. It's great to be able to switch bands, dial up any frequency, and transmit immediately, especially when operating mobile or in a contest or chasing DX. Isn't this advantage lost if an antenna tuner has to be used?

We recommend using an antenna that has a low SWR (below 1.5:1) and that presents a proper impedance match (50-ohms) to the transceiver. Then the full advantages of using an all solid-state rig can be realized. Furthermore, the antenna will be more efficient, and power will not be reflected back to an antenna tuner.

However, many antennas are not broad enough to cover an entire band, and may have an SWR below 1.5:1 in just a portion of the band. The antenna may be cut for resonance in the middle of the portion of the band that is mostly used. When operating outside this portion, where SWR exceeds 1.5:1, the antenna tuner should be switched in.



AT-120



AT-180

Therefore, with a well-designed antenna, the antenna tuner may be switched out for most operating, and the full advantage of using a no-tune all solid-state rig may be realized. But for those occasions when operating in the band portions where the antenna is not resonant and reactance increases or when, for some reason, the antenna develops a high SWR or a poorly matched antenna is used, the antenna tuner should be switched in to obtain full RF power output.

During those occasions when the antenna tuner is needed with an all solid-state rig, it would probably be advantageous with a tube-type rig also for optimum power transfer to the antenna system. With a tube-type final, plate tuning and loading adjustments would be required in addition to adjusting the antenna tuner. With an all solid-state transceiver, only the antenna tuner would need adjusting during those occasions when it is required.

What are the primary features of the AT-120 and AT-180 antenna tuners?

The AT-120 antenna tuner is very compact (only 6 inches wide, 2-3/8 inches high and 6-1/4 inches deep) - perfect for mobile mounting with the mounting bracket provided - and operates on 80 through 10 meters. It consists of an antenna coupler and an SWR meter (which can be illuminated). Although much smaller, it complements the appearance of the TS-120S.

The bandswitch has a "THROUGH" position for switching the AT-120 out of the circuit. Input impedance (to the transceiver) is 50-ohms and output impedance (to the antenna system) covers 20 to 300 ohms, unbalanced. It handles 150 watts (120 watts on 80 meters). The SWR meter measures from 1.0:1 to 10.0:1.

The AT-180 antenna tuner matches the TS-180S (same height) and consists of a through-line watt and SWR meter, antenna selector switch, and, of course, an antenna coupler.

It operates on 160 through 10 meters, with a 50-ohm input impedance and an output impedance of 10 to 500 ohms (10 to 400 ohms on 160 meters), unbalanced. Switches allow up to 20 or 200 watts of forward or reflected power to be measured. (It is not intended for use at the output of a linear amplifier.) UHF-type connectors are provided for the input, two antenna outputs, and a dummy load, and a standoff connector is provided for a wire feedline.

With both tuners, the "R TUNE" (for resistance component) and "X TUNE" (for reactance component) controls are adjusted alternately with a CW carrier applied until minimum SWR or reflected power is obtained.

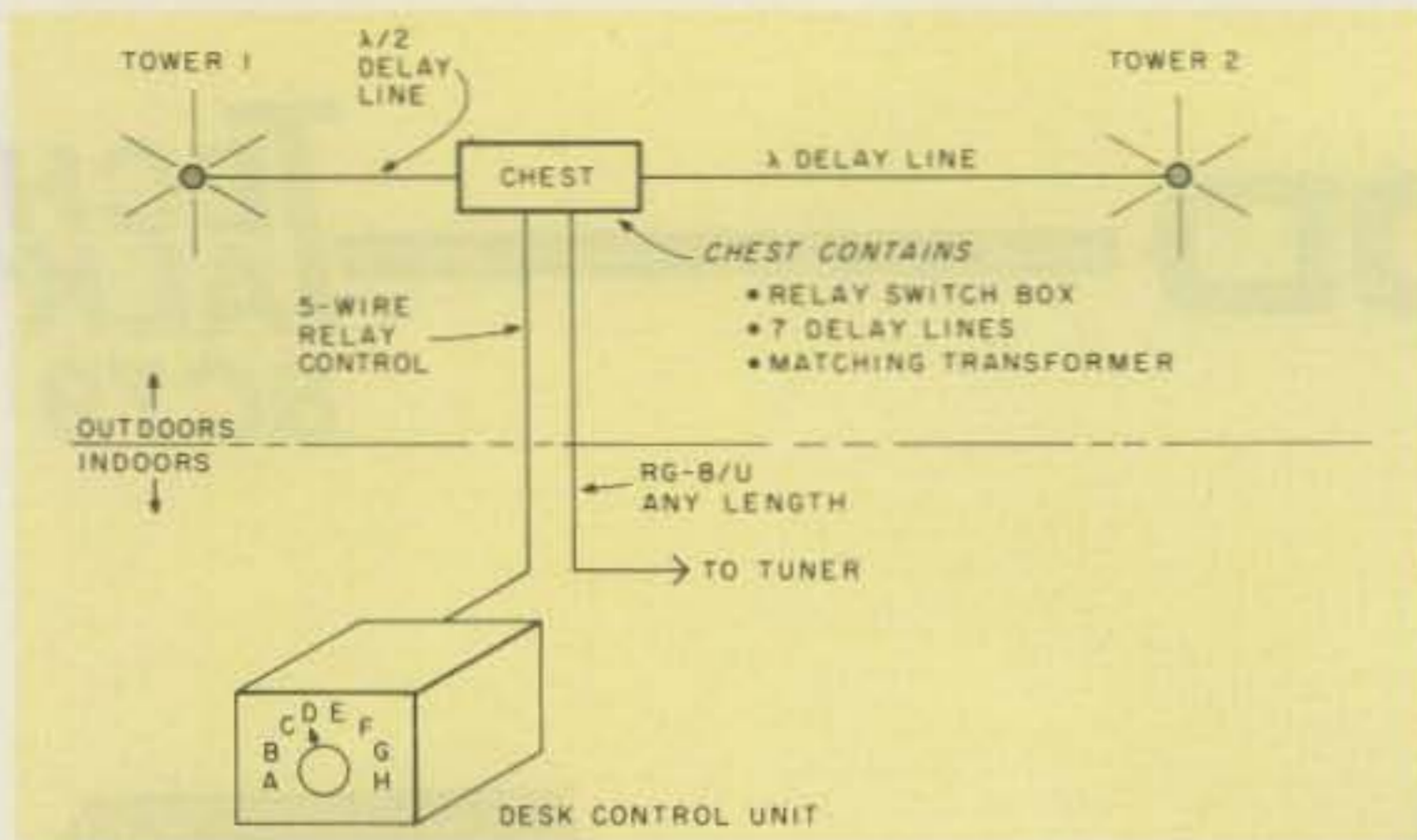

Fig. 3. Bird's-eye view showing the simplicity of the system.

The low-angle radiation patterns from verticals enhance DX probabilities for a given transmitter power. The absence of high-angle vertical lobes usually equates to effective use of radiated power. Properly constructed, ground-mounted verticals can have low losses and are structurally sound in almost all weather.

For 40 meter and 80 meter operation, a two-tower vertical system is one of the few practical options that can be used to enhance directivity. This is especially true if rotation of the pattern is desired. Typically, at these frequencies, the beam element lengths in conventional arrays become too ponderous for most hams to cope with.

Finally, in the two-tower system, no mechanism or external rotators are required. The quick switching of the lobe patterns is especially handy for reception when operating in a net or group. Often the compass bearing between received stations is quite wide. Quick optimization of the received signal is a real operating advantage. Sometimes, too, it is helpful to be able to partially null an interfering signal.

How This Antenna System Operates

The two towers are physically separated by $\lambda/4$ on 40 meters (34'5"). This is

a separation distance that will comfortably fit on many home lots. There is an eight-position switch at the operator's position that selects between the lobe patterns (Fig. 1). For example, switch position D on the 40 meter band selects a paddle-shaped pattern directed off the top end of the axis. Switch position F on the 40 meter band is an identical paddle-shaped pattern, but directed off the bottom end of the axis. The absolute geographic direction is determined by the tower axis orientation.

It is worth noting again that the division of current between the towers affects the pattern generated. Yet the current division between towers, with a common feedline, is a function of the tower self-impedances—including mutual impedance—as trans-

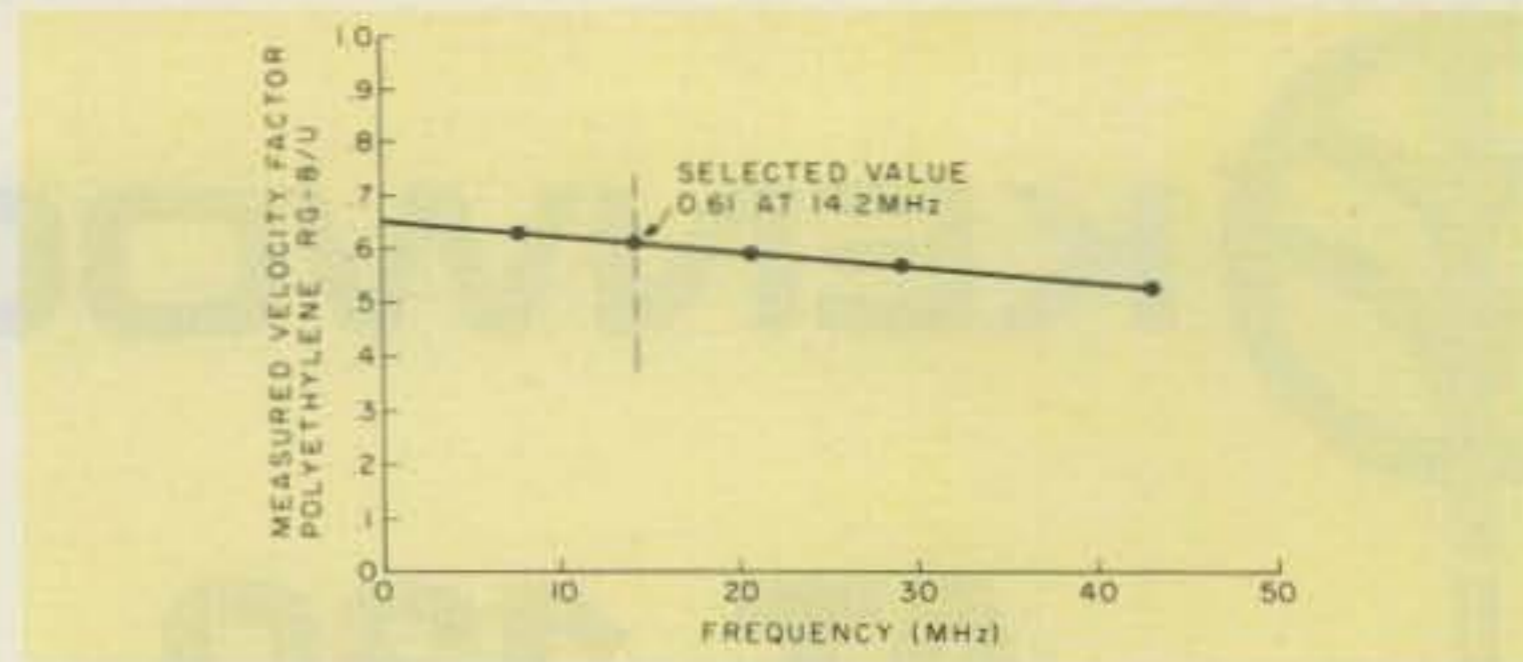

Fig. 4. Velocity factor versus frequency for polyethylene RG-8/U.

formed through the delay lines to the feed-in point. The individual tower impedances, in turn, for a given current phasing, are a function of the current division between them.¹ Sound circular? For example, it is possible with some patterns and phasings to initiate a multivibrator-type action. As a tower current goes down, the tower impedance goes up, which causes the current to go down further . . . etc. The resulting radiation pattern degenerates toward a single tower pattern or a circle. It can be speculated that such action has discouraged unsuspecting experimenters in the past when actual performance compared poorly with anticipated pattern enhancement.

These degenerative conditions have been avoided in this array. But to avoid them, some two-tower patterns, as shown in a *Radio Engineering Handbook* or

similar source, are not available in practice. Uncritical referencing to tables of these patterns is a common error. Such hand-book displays are normally predicated on towers which are $\lambda/4$ high and which have equal currents in each tower. Maintaining equal currents under all conditions of operation and switching is not an easy trick. Instead, the lobe patterns in Fig. 1 are based on the unequal currents which occur normally. The patterns give good emphasis and direction selection on each band. By orientating the tower axis with care, good world coverage can be obtained.

All patterns as shown in Fig. 1 are "idealized," meaning that they are computed, not measured, and are assumed to be generated over perfectly conducting earth. For most ham installation planning jobs, these assumptions are quite acceptable. The

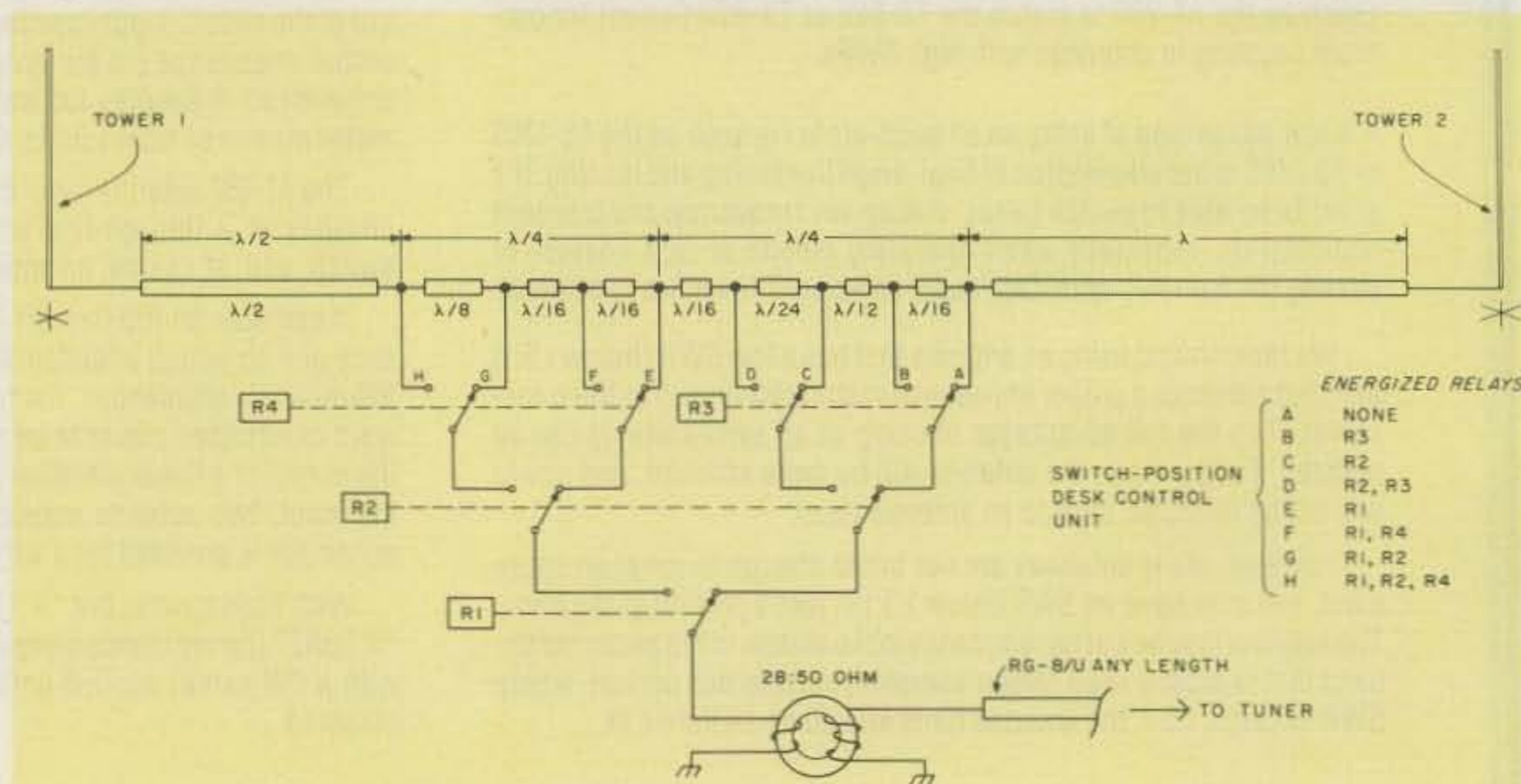

Fig. 5. Relay circuit. All relays are shown at rest. All wavelengths refer to 40 meters only.

Get Everything Ham Radio Has to Offer with Heath®

A big part of the enjoyment of Amateur Radio is firing up a rig that you built with your own hands. With Heathkit® Amateur Radio gear, you get more from your hobby by building it yourself...and you get more for your money, too. You save money over comparable assembled units, and you save by servicing your own equipment. Of course, technical assistance is available, if you need it, at 55 Heathkit

sales and service locations from coast to coast. Just a phone call away. If you've never built a kit from Heath, you're in for a pleasant surprise. The instruction manual that comes with every kit is the best you'll find anywhere. As one first-time kit builder put it, "If you're not color-blind (for differentiating resistor and wire colors), you can build anything in the Heathkit catalog."

HW-8 QRP Transceiver

HX-1681 CW Transmitter
HR-1680 Receiver



1kW and 2kW
Linear Amps

SB-104A All Solid State Transceiver and Station Aids

HW-101 SSB/CW
Transceiver

VF-2031 Hand-
held
2-Meter
Transceiver



HW-2036A
Synthesized
2-Meter
Transceiver

The latest Heathkit Catalog features complete information on nearly 400 quality electronic kits you can build for pride, satisfaction and savings. Send for your FREE copy now.

If coupon is missing,
write to: Heath Company,
Dept. 011-570,
Benton Harbor, MI 49022



FREE HEATHKIT CATALOG
There's more for the Ham at Heath!

HEATH Schlumberger	Heath Company, Dept. 011-570 Benton Harbor, MI 49022	MAIL THIS COUPON TODAY
Please send me my FREE Heathkit Catalog. I am not on your mailing list.		
Name _____	Address _____	
City _____	State _____	
AM-393	Zip _____	

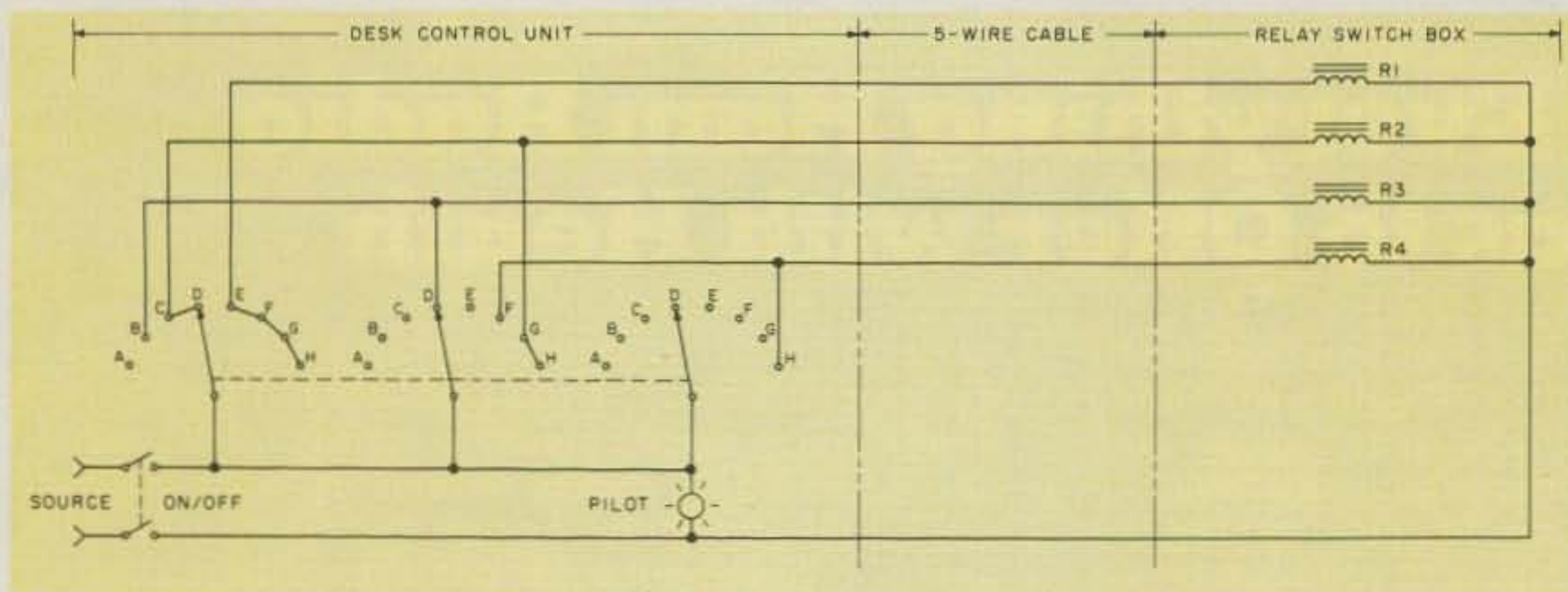

Fig. 6. Relay coil-control circuit.

charts are calibrated in millivolts/meter for a radius of one mile with a total rf radiated power of 100 Watts. To estimate the field strength for a different radiated power, P_2 , it is only necessary to multiply the chart reading in the chosen direction by $\sqrt{P_2/P_1}$. In our case, P_1 is 100 Watts. The circles in the charts represent 61.8 millivolts/meter at one mile, which is the field intensity that theoretically would be obtained if the 100 reference Watts were to be radiated from a single vertical tower.

The Block Diagram

The antenna system is shown in block diagram form in Fig. 2. For consistency, all notations in Fig. 2 and throughout this article relating to wavelength or delay degrees will refer to 40 meter operation. Conversion to other bands is then straightforward.

Although the towers are physically $\lambda/4$ apart (90°), they are separated elec-

trically by two wavelengths of delay line in nine unequal sections. The electrical centerpoint is at A. The feed-in point of the transmission line is determined by an eight-position switch.

In the D position, as shown, there is a $13/16\lambda$ delay to tower 1 and a $19/16\lambda$ delay to tower 2. In other words, the current in tower 2 lags the current in tower 1 by the difference in delays, or: $19/16\lambda - 13/16\lambda = 6/16\lambda = 3/8\lambda = 135^\circ$. At the same switch position, consider 20 meter operation. All electrical dimensions are now doubled. The towers are physically separated by 180 electrical degrees. Tower 2 current now lags tower 1 current by twice the amount at 40 meters, or 270° .

The eight-position switch function could be done manually as is illustrated. Such manual switching would be quite awkward in most operating situations, since the switch would necessarily be outdoors. Instead, the equivalent function is done remotely with four relays. The relay circuit and the matching transformer will be discussed in a later section.

The specification of trapped antennas for the towers is important. For predictable radiation pattern generation, it is desirable that each tower be an electrical quarter wavelength high for each

operating band (at least no higher than $5/8\lambda$). Trapping achieves this condition. It may be tempting to try to use untrapped 40 or 80 meter quarter-wavelength towers for all bands. Such untrapped tower heights, when used on high frequency bands such as 10 or 15 meters, can cause confusion and difficulty. In effect, each tower can become a resonant "long-wire" with the associated intricate radiation pattern. Lossy high-angle lobes can result. The interaction of these complex patterns in a switchable two-tower array is apt to result in unpredictable and disappointing results without careful analysis.

Construction Features

One real advantage of this array is its easy and straightforward adaptation to construction. For instance, the full λ length of delay line to tower 2 and the $\lambda/2$ length of delay line to tower 1 permit the physical grouping of a switch box plus seven of the delay lines conveniently away from both towers. This statement allows for the physical shortening of the delay lines to accommodate transmission line velocity factors. This arrangement flexibility is often useful for appearance or screening considerations (Fig. 3).

While on the subject of velocity factors, it may be helpful to review my own

experience. Perhaps I should have known better, but I was unprepared for calibrated dip-meter measurement results, which indicate that the velocity factor in polyethylene RG-8/U varies with frequency (Fig. 4). A review of the technical literature that I have, plus manufacturer's data on hand, discloses no mention of this quality. A single standard "nominal" value for the velocity factor is usually given. Other experimenters may also have this gap in their information. Obviously, knowledge of this variable is significant if the same cable is to be used for generating specific delays, but at different frequencies—as in this array. I selected a velocity factor of 0.61 obtained at 14.2 MHz. This is a compromise value. Errors introduced on other bands are within reasonable limits with this value. Table 1 lists the physical lengths I have used.

It is suggested that the λ length of delay line, and also the $\lambda/2$ length of delay line, be cut a little long. Then, with all of the delay lines attached to the switch box but not connected at the towers, balance and trim the lines from midpoint A outward with a dip meter. This balancing will minimize any discontinuity effects in the switched leg due to relay points or coax hardware.

The Relay Switching Circuit

The functional switch in Fig. 2 is replaced by the relay circuit in Fig. 5. The switching relays are conventional medium-power units and need not be the expensive coax type. They should have two sets of SPDT contact points. A compact physical design is suggested. It is important that they have sufficiently heavy-duty contact points

Electrical wavelength	Physical length (vel. fac. = 0.61)
λ	84'8"*
$\lambda/2$	42'4"*
$\lambda/8$	10'7"
$\lambda/12$	7'5"
$\lambda/16$	5'3.5"
$\lambda/24$	3'6.25"

Table 1. Physical lengths of delay line sections. *Initially cut long and trimmed to final length with a dip meter (see text).

to be able to handle the currents involved. A contact current rating of 10 Amps or better will be adequate in most applications. Obviously, the relays should have good insulation and a low inductance switch path. Contact resistance should not be a problem since full rf current flows through any contacts that are used.

The relay coil-control cable is a five-wire cable. Since the cable runs from the shack to the switch box outside, it is likely to either be buried or at least to touch the earth. As a result, conventional safety precautions require that the relay coils should either be of the low-voltage type or else should be isolated with a suitable transformer arrangement.

In my installation, the relays are housed in an aluminum box, 3½ x 6 x 10 inches (Photos A and B). This box also serves as a mount for the SO-239 panel receptacles which make the connections to the transmission line and delay lines. This arrangement affords good shielding, short connections, and easy assembly and disassembly. Another plus is the ability to make easy substitutions of delay line lengths for experimentation. The layout is not critical and your own design should work well if attention is given to short lead lengths.

Selection of the relays is controlled from a desk control unit which basically consists of a 3-pole, 8-position rotary switch housed in a decorator metal box (Photo C). A pilot light and an on/off switch can be convenient additions. The relay coil-control circuit is detailed in Fig. 6.

Radials and the Ground System

All too frequently, hams underestimate the need for

a proper ground system with vertical towers and attempt to skimp by. This is false economy and wastes effort and power. An adequate radial system is a fundamental and necessary component of the total radiation array and should not be neglected. A working rule of thumb is to have a minimum of six radials per band with a minimum length per band of 0.125λ (Photo D).

The Transmission Line, Delay Lines, and Matching Considerations

Although simple in physical appearance, operation, and construction, there are some deceptively involved aspects to the electrical analysis of the array:

- There are two towers with mutual coupling which affects the individual tower impedance.
- Pattern switching affects the load impedance at each tower.
- The towers are not always operated at resonance with the corresponding introduction of reactance of varying magnitude and sign.
- The impedance of the system, viewed from the radial switch, is a resultant of two parallel paths—one to each tower. The length of these paths, their individual impedances, and the current division between them change with switching.

It should be clear that the system—considered as a load—varies under normal operating conditions. For the most part, these operating conditions, while

Band	Tower 1	Tower 2
10	1.30	1.25
15	1.45	1.50
20	1.25	1.15
40	1.20	1.20
80	1.00	1.05

Table 2. Swrs measured at tower base and at tower resonant frequency.

tedious to analyze, are quite solvable with the charts and equations of G. H. Brown, the liberal use of Smith charts, plus the determined application of patience and time with a programmable hand calculator. Fortunately, in practice, the system analysis complexity can largely be ignored while achieving excellent operating results. Anyway, the analysis is mostly needed for determining the pattern shapes when the tower currents are unbalanced. Still, it is realized that most users will want an insight into the operation without the tedium. The following discussion is intended for that purpose.

The range of impedances

at the radial switch is such that a broadband transformer can offer very suitable compromise matches to the transmission line. In short, it splits some differences. Two simplified examples will illustrate in principle the general mode of the transformer plus some system features.

Assume that the two towers are physically identical and are operating at resonance in the 20 meter band. Assume further that the resonant resistance of each antenna is a typical 40 Ohms. Assume also for simplicity that there is no mutual impedance! Now let the feed-in point of the transmission line be switch position A, or the midpoint

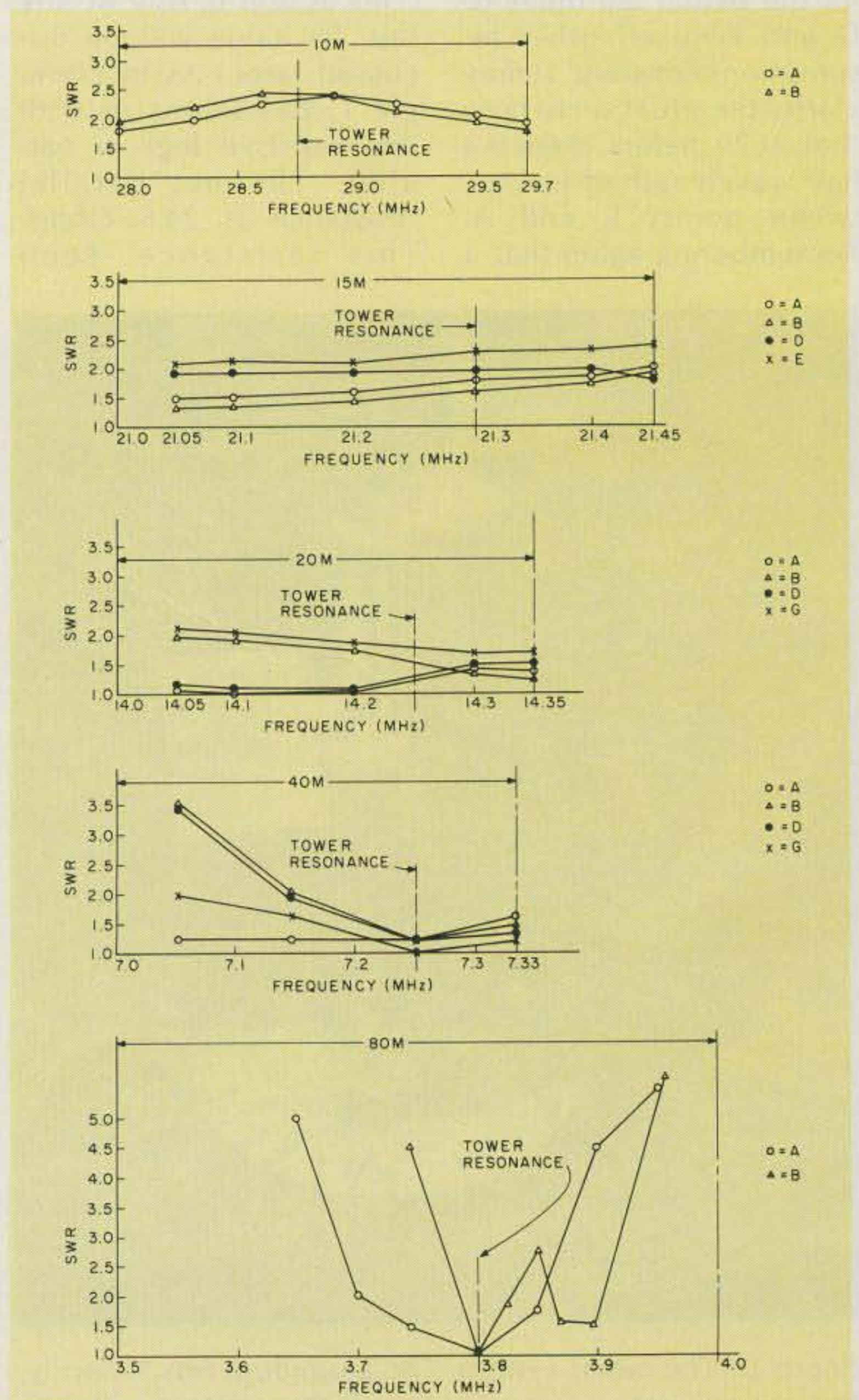

Fig. 7. Swrs versus frequency.

of the delay line. From switch position A, with 20 meter operation, there are two wavelengths of delay line to each tower. Since a half wavelength of transmission line repeats its input at its output, then the resonant resistance of each tower—40 Ohms—will be repeated at A. The two legs are in parallel so that there is a net resistance at A of 20 Ohms. Without a transformer, the 20 Ohms as a load would develop an swr, with the 50-Ohm transmission line of $50/20 = 2.5$. However, 20 Ohms through the 1.0:1.8 ratio transformer will appear as 36 Ohms, which will develop an swr of only 1.4—a significant improvement!

For the second example, let the switch tap move to D and keep all other assumptions constant. It may clarify the situation to note that, at 20 meters, there is a half wavelength of line between points E and A. Remembering again that a

half wavelength of line repeats its input at its output, the tower 1 resistance is repeated at point H and again at point E. Similarly, tower 2 resistance is repeated at A. The electrical distance from E to D is $1/8\lambda$. The electrical distance from A to D is $3/8\lambda$. The question now becomes what happens at D? Whipping out our handy Smith chart, we find that the resistance of tower 1 will be seen at D as 49 Ohms resistance plus 12.5 Ohms of *inductive* reactance. Likewise, the resistance of tower 2 will be seen at D as 49 Ohms of resistance plus 12.5 Ohms of *capacitive* reactance. Since the reactances are equal and opposite, they will cancel. (This action is true at any tap. Its value will be discussed later.) As in example 1, this leaves us with two resistive legs in parallel. The net parallel resistance is 24.5 Ohms. This resistance, seen

through the transformer, will appear as 44.1 Ohms, which, in turn, will generate an swr of only 1.13.

Unfortunately, when mutual impedance is reintroduced into our assumptions, the reactive components do not always cancel at all times. Also, the self-resistance of the towers may become different, which would mean that the currents will no longer be the same in each tower. Nevertheless, the function of the transformer can be understood as an impedance leveler and, in fact, practical experimentation is easy.

The transformer itself is a ferrite core unit. I use the Palomar transformer at the nominal ratio of 28:50 Ohms. Roll-your-own transformer winders should have little difficulty achieving the 1.0:1.8 ratio or close to it.^{2,3} The turns ratio is not excessively critical, and some experimentation with ratios may be rewarding. It has been my experience that swrs for a favored band can be improved, but usually at some expense to another band.

Adjustments/Tuning

The first operation in adjustment is to tune the towers individually to the same frequency on each band. Other things being equal, a midband resonant frequency will probably give better overall results than a frequency near band edge. Assuming the absence of an rf bridge, probably the most direct alignment technique is to measure the swr at the base of each tower and adjust for minimum. To avoid mutual coupling effects, the other tower should be removed from its standard and placed out of the immediate area.

It will be remembered that an ideal vertical $\lambda/4$ tower has a resonant resis-

tance of about 36 Ohms. Thus, with a 50-Ohm transmission line, the swr for an ideal tower would be $50/36 = 1.4$. Some hams are confused about this point—probably by advertising claims—and expect an swr of 1.0 or close to it.

The swrs that I measure on the transmission-line side of the matching transformer are shown in Fig. 7. These moderate swrs represent no threat to RG-8/U, even at full legal power. Coax losses at these ratios are insignificant. Most antenna tuners can easily cope with these ratios and will present a perfect load to the transceiver or linear amplifier.

Table 2 lists the swrs I measure at the base of each tower. Superficially, it would appear that I have the best adjustment on 80 meters where the swrs are the lowest. The contrary is the case. My towers are telling me that I have an inadequate radial system on 80 meters. In effect, I have a dissipative ground resistance in series with the radiation resistance, and, therefore, the total resistance is raised. The net resistance at 80 meters nearly matches the transmission line characteristic impedance. Although this raised overall resistance gives a nice low swr, it also indicates that I am wasting some valuable rf power heating the ground!

Perhaps of more interest is the shape of the swr curves in Fig. 7. For the most part, 80 meters excepted, they do not have the familiar lopsided, saucer-shaped, resonant curves. Instead, they tend to be gently curved and be level, or have a slight tilt. That is, *the swr does not change appreciably* with change in operating frequency! This is a feature of the system. Stated another way, once an antenna tuner is adjusted for a par-

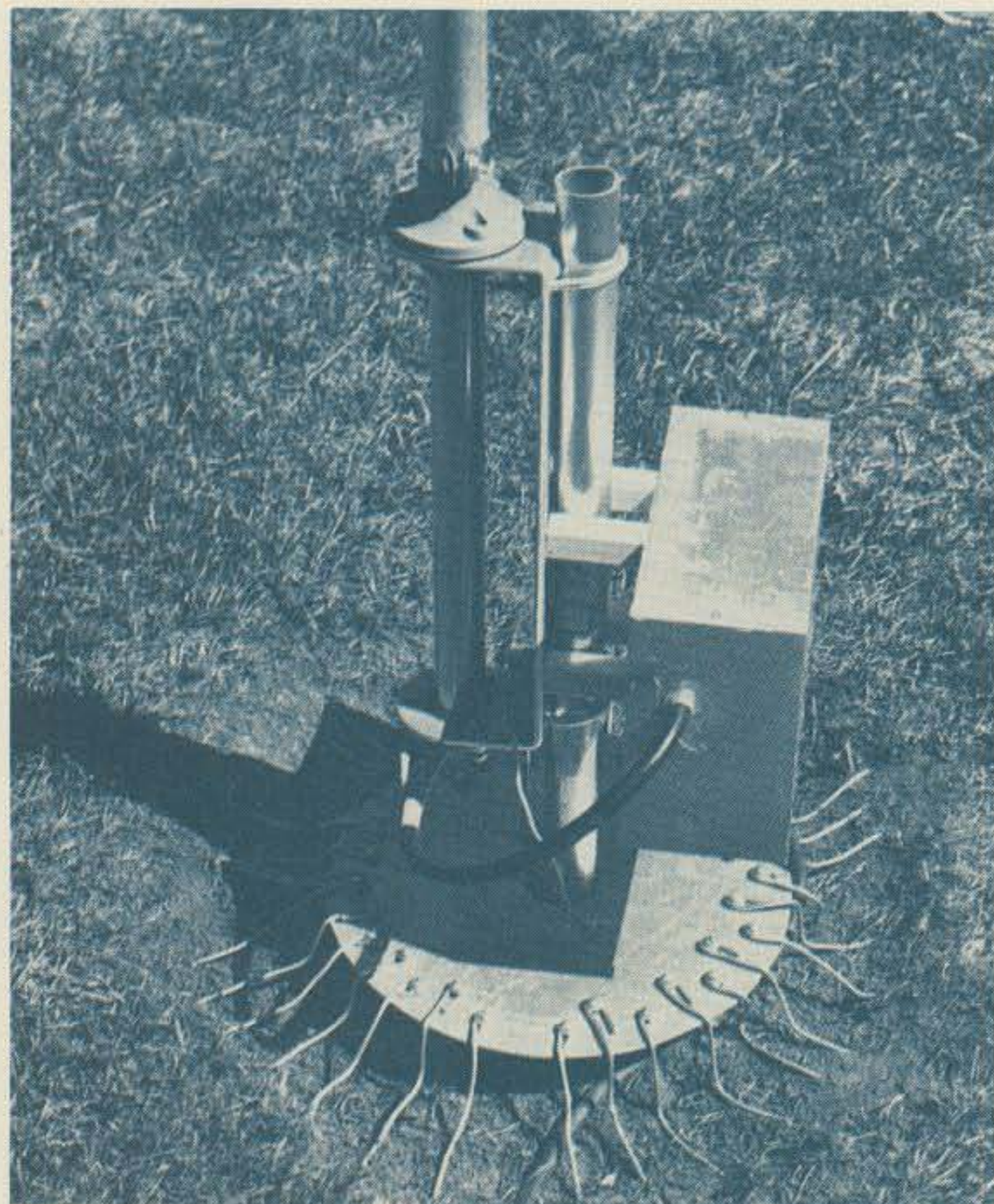

Photo D. The radial system. The aluminum box is handy, but not necessary. It is used to weather protect a PL-239, which was used for cable length experimentation.

ticular lobe pattern, at a particular frequency, it is usually unnecessary to re-adjust it much while operating across a significant band segment. For emphasis, it should be noted that the chart for the 10 meter band has a 5:1 compression in its frequency scale when compared to the other bands. Its flatness is thus even more impressive.

For an explanation of these unusual swr curve

shapes, recall that, in our second example, there was a cancelling of reactance at each switch tap, providing that there is an integral number of half wavelengths of delay line between towers. If the operating frequency is moved away from the resonant frequency of the towers, an identical reactive component will be introduced at each tower. These reactive components will tend to cancel at

the taps, leaving only resistance. It is like having a built-in compensating tuner!

In addition to matching the antenna system to the output pi network of your transceiver or linear amplifier, an antenna tuner gives added protection against spurious radiation. This antenna system is an excellent radiator on all bands at all times! It will not filter nor inhibit any undesired harmonics. An

antenna tuner is an investment in tranquility. ■

References

1. G. H. Brown, "Directional Antennas," *Proceedings of the Institute of Radio Engineers*, January, 1937. See equations 37, 38, 39, and 40 on page 92.
2. John J. Nagle K4KJ, "Wide-band rf Autotransformers," *Ham Radio Magazine*, November, 1976.
3. Jerry Sevick, "Broadband Matching Transformers Can Handle Many Kilowatts," *Electronics*, November 25, 1976.

something new!

ALL WE DO IS AMATEUR SERVICE, SO. . . WE HAVE TO BE GOOD!

Why buy new gear when your old gear can be refurbished for a fraction of the cost? Just send your equipment with mic, manuals and a description of the problem. For faster service, call first. We try to anticipate needs and have parts on hand.



International Electronic Communications, Inc.

503 Avon St., Mocksville, NC 27028 PH (704) 634 5661 ✓144



ALL-MODE VHF amplifiers

FOR BASE STATION & REPEATER USE

MODEL: V350



MODEL: V180

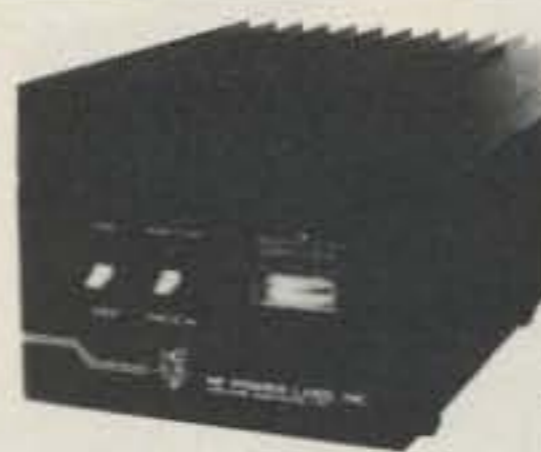

- ☆ Built-in 115/230 VAC Supply
- ☆ AM-FM-CW-SSB-RTTY
- ☆ 60dB Harmonics
- ☆ 60dB Spurious
- ☆ Heavy Duty Design

All Solid-State!

- ☆ Illuminated Panel Meter
- ☆ Automatic T/R Switching
- ☆ VSWR Protected
- ☆ + 13V/3A Accessory Socket
- ☆ U.S. Manufactured

MODEL	FREQUENCY	INPUT	OUTPUT	SIZE WxDxH	WEIGHT	FAN KIT REQUIRED	PRICE
**V76	50-52MHz	8-15W	100-120W	216x330x178mm	11.7 kg (26 lbs)	No	\$339.00
**V360	50-52MHz	5-10W	400-450W	432x330x178mm	23.4 kg (52 lbs)	Yes	\$895.00
V70	144-148MHz	10-15W	75-90W	216x330x178mm	11.7 kg (26 lbs)	No	\$315.00
V71	144-148MHz	1-3W	75-90W	216x330x178mm	11.7 kg (26 lbs)	No	\$349.00
V180	144-148MHz	5-15W	170-200W	216x330x178mm	13.5 kg (30 lbs)	CW & FM	\$539.00
V350	144-148MHz	10-20W	350-400W	432x330x178mm	23.4 kg (52 lbs)	Yes	\$895.00
V130B	220-225MHz	10-15W	70-85W	216x330x178mm	11.7 kg (26 lbs)	No	\$329.00
V135B	220-225MHz	25-35W	140-160W	216x330x178mm	11.7 kg (26 lbs)	CW & FM	\$469.00
F110		Fan Kit, 115VAC		135x135x50mm	1 kg (2.2 lbs)	—	\$ 33.00
F220		Fan Kit, 230VAC		135x135x50mm	1 kg (2.2 lbs)	—	\$ 33.00
*F135		Fan Kit, 115VAC		381x140x89mm	3.2 kg (7 lbs)	—	\$ 59.00
*F235		Fan Kit, 230VAC		381x140x89mm	3.2 kg (7 lbs)	—	\$ 59.00
RM-1		19 Inch Rack Adaptor		483x3x178mm	1 kg (2.2 lbs)	—	\$ 25.00
*RM-2		19 Inch Rack Adaptor		197x32x28mm	.5 kg (1.1 lbs)	—	\$ 12.00

* Used with the V360 & V350 Amplifiers / ** For Export Only / Other Frequencies Available on Request

Dealer Inquiries Invited

FCC Type Acceptance Pending



RF POWER LABS, INC.

✓R27



11013-118th Place N.E. • Kirkland, Washington 98033 Telephone: (206) 822-1251 • TELEX No. 32-1042

FOR BEST PRICE AND
FAST DELIVERY

CALL

1-800-325-3636

TOLL FREE



HAM RADIO CENTER

8340-42 Olive Blvd. P.O. Box 28271 St. Louis, MO 63132

H2

50 144 REPEATERS 220 450 Mhz

BASIC AUTO PATCH

*Access, #Disable and adjustable Timer.
COMPLETELY ASSEMBLED—\$75.00.

Now with courtesy
beep and beacon
capability

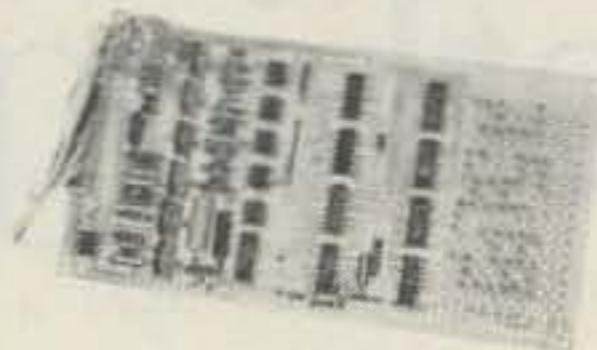

EXTENSION BOARD

Antifalsing, 3 digit sequential Touch Tone™
decoder with automatic reset, Antifalsing
Ring detector, reverse auto patch capability
for basic auto patch and two, two-watt audio
amplifiers.

COMPLETELY ASSEMBLED—\$140.00

Available Separately:

COR Identifier: All on one board, programmable, Fully ad-
justable, time out (.5-7 min.), hang time (0-1 min.), Identifier
(1-10 min.), tone, speed, volume, L.E.D. outputs, low current
drain CMOS logic, plugs for easy installation and removal plus
much more. \$79.95 COMPLETELY ASSEMBLED

Basic Repeater \$499.95 COMPLETELY ASSEMBLED

2M 130-175 MHz Basic Repeater for 2 meters with all the features of the HI
Pro Mki less the power supply and front panel controls and accessories.

Hi Pro Mk I
REPEATERS

PA Res. add 6% tax

PLUS SHIPPING

50 MHz \$789.95 450 MHz 799.95
144 + 220 MHz \$699.95

M36

Maggiore Electronic Laboratory

845 WESTTOWN RD.

WEST CHESTER, PA. 19380 PHONE 215 436-6051

New! Amateur Upgrade™



Upgrade today!
Great for
ham parties
and clubs,
\$9.95 each

Kantronics Amateur Upgrade is an educational board game that
familiarizes players with FCC rules governing amateur radio and elementary
radio concepts. The game comes complete with playing surface, playing pieces
— coil, grommet, etc —, a die, exam cards and answer sheets, over 100 Novice,
General, Advanced and Extra questions in all.

Players roll the die to determine the number of spaces to move. Some spaces
players land on have a consequence such as "exceeded 1000 watts — answer
question, if wrong go to start." When a player lands on an exam space, he must
take an exam card. After three cards have been collected by one player, he must
take the exam, hoping to upgrade. The first person to progress through all
levels to obtain the Extra-class WINS! Novice exam cards may be used
exclusively for beginner play.

KANTRONICS

The Training Company

1202 East 23rd Street
Lawrence, Kansas 66044

We accept Visa, Master Charge, check and money orders.

Phone: 913 842-7745

FREE!
RADIO AMATEURS
WORLD ATLAS
with purchase of famous
CALLBOOK
MAP LIBRARY!

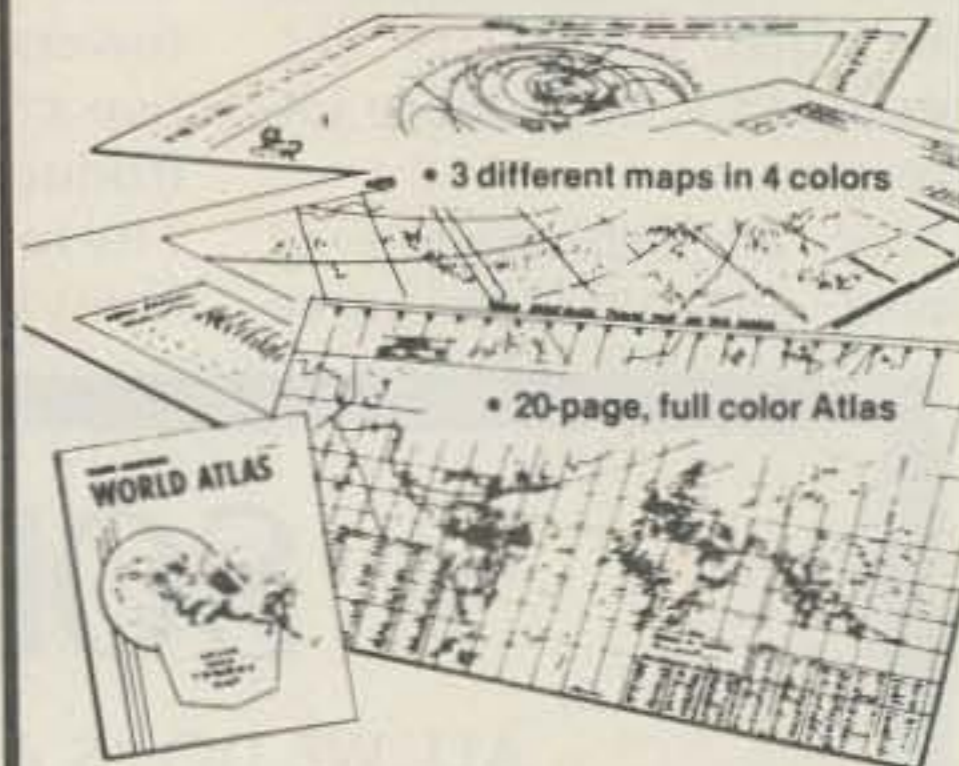

Here's an offer you can't refuse! You
receive three, information-packed, Ama-
teur Callbook maps, folded, plus the
World Atlas for only \$3.75 plus \$1.50
shipping and handling. If purchased
separately, total value of map/atlas offer
would be \$6.25, plus shipping. You save
\$2.50 and get these invaluable radio
amateur aids!

1. Prefix Map of the World, folded.
World-wide prefixes. Shows 40-zone
map on one side, 90-zone map on the
other. Size 40" x 28"
2. Map of North America, folded.
Includes Central America and Carib-
bean to the Equator. Shows call
areas, zone boundaries, prefixes, etc.
Size 30" x 25"
3. Great Circle Chart of World, folded
Centered on 40°N, 100° W. Shows
cities, latitude, longitude, great circle
bearings and more! Size 30" x 25"

Plus special FREE bonus!

The Callbook's own Radio Amateur
World Atlas, FREE with the purchase of
the 3 maps. Contains eleven full color
maps of the world, looking at things from
the radio amateurs point of view.

Callbook Map Library	\$3.75
Shipping	\$1.50
Total	\$5.25



Special Limited Offer!
Amateur Radio
Emblem Patch
only \$2.50 prepaid

Pegasus on blue field, red lettering, 3" wide x
3" high. Great on jackets and caps. Sorry, no call
letters.

ORDER TODAY!

Order from your favorite electronics dealer or direct from the
publisher. All direct orders add \$1.50 for shipping. Illinois
residents add 5% Sales Tax.

RADIO AMATEUR
callbook INC.
Dept. B
925 Sherwood Drive
Lake Bluff, Ill 60044

Contests

from page 30

RS(T) and 3-digit serial number starting with 001.

SCORING:

European stations count 1 point per QSO on any band; non-European stations score 1 point per QSO on 20 through 10 meters, and 3 points per 80/40 meter QSO. Count every call area in the above-mentioned countries on every band as a multiplier, e.g., LA1 = LB1 = LJ1 and SM3 = SK3 = SL3. A portable station in Norway or Denmark counts as the 10th call area, e.g., W2XXX/OZ counts for OZ0. Some countries have no geographical call areas, but count this contest as if they had. The sum of all complete QSO points from all bands multiplied by the sum of multipliers from all bands is the final score.

AWARDS:

Certificates awarded to the highest-scoring station in each participating country and US call area in each operating class separately on CW and phone. A special SAC-plaque will be given to the continental winners on both CW and phone. A reasonable score is requested for both certificates and plaques. Depending on the number of contestants in each country, the contest committee will consider more certificates.

ENTRIES:

Write separate logs for CW and phone. The logs are to be filled in in the following order: date and time in GMT, station worked, sent and received message, multiplier, and points. Separate logs for each band are recommended. On the summary sheet the contestant will write his/her callsign, name and address, the final result, the operating class, and a signature that he/she fully agrees to the rules. The logs must be mailed no later than October 15 and sent to: SRAL, SAC Contest Committee, PO Box 306, SF-

00101 Helsinki 10, Finland. The decisions of the contest committee are final and definite and they reserve the right to change the rules. Usual disqualification rules.

DELTA QSO PARTY

Starts: 1800 GMT September 29
Ends: 2400 GMT September 30

All amateurs are invited to participate in the 10th annual party which is sponsored by the Delta Division of the ARRL. Amateurs outside of the Delta Division (Arkansas, Louisiana, Mississippi, Tennessee) will attempt to contact as many stations inside of the Delta Division. Delta Division stations will attempt to contact as many stations both inside and outside of the division. Stations may be worked on each band/mode; portables and mobiles may be reworked on the same band/mode if they change counties.

FREQUENCIES:

CW—3550, 7050, 14050, 21050, 28050.

SSB—3990, 7290, 14290, 21390, 28590.

Novice—3725, 7125, 21125, 28125.

EXCHANGE:

QSO number, RST, and QTH (ARRL section for non-Delta Division; county and state for Delta Division).

SCORING:

Delta Division stations score number of QSOs times the number of ARRL sections (75 maximum); outside Delta Division score number of QSOs times the number of counties worked (316 maximum). DX stations may be worked by Delta Division stations but do not count as multipliers.

ENTRIES AND AWARDS:

Logs must include date/time, station worked, exchange, band, emission, and multiplier. Logs must be postmarked no later than October 21 to be eligible for award consideration. Logs will be returned if request-

ed. Send logs to Malcolm P. Keown W5XX, 213 Moonmist, Vicksburg MS 39180. All amateurs contacting 5 different stations in each of the 4 states comprising the Delta Division will receive a certificate. Section awards to the 3 highest-scoring stations in each Delta Division state, 4th and 5th place if warranted; section awards to high-scoring stations in each ARRL section and country outside Delta Division, 2nd and 3rd if warranted. Plaques to high-scoring stations both inside and outside of the division and to high-scoring portable and mobile stations in the division. Another plaque to the high-scoring Delta Division club station (no limit to number of operators or transmitters, but all QSOs must be made from same QTH).

COLLEGE RADIO SCRIMMAGE

Starts: 1900 GMT September 30
Ends: 0100 GMT September 31

Entry classes: 1) alumni and 2) club station. Open to all amateurs; alumni may work other alumni and club stations. Entry may have one or more operators but must have only one transmitter (no distinction between single- and multi-operator).

EXCHANGE:

Name of college, junior college, or university you last attended and the last two digits of the year you graduated, will graduate, or last attended. Club stations substitute the words "Amateur Radio Club" for number. Non-collegians substitute the words "High School" for college name, but are not eligible for awards and may not be counted as a multiplier.

SCORING:

Stations may be worked once per band. Multiply total QSOs by number of different colleges worked (college counts once regardless of band).

FREQUENCIES:

1815, 3895, 7230, 14280, 21355, 28560.

AWARDS AND ENTRIES:

Trophy for top scorer in each entry class. Certificates as well. Logs must be received by November 1 to be eligible. Send an

SASE for results to: Penn State Amateur Radio Club, K3CR, 202 Engr. Unit E, University Park PA 16802.

FALL CLASSIC RADIO EXCHANGE

Starts: 2000 GMT Sunday, September 30
Ends: 0300 GMT Monday, October 1

This contest is sponsored by the Southeast Amateur Radio Club, K8EMY, of Cleveland, Ohio, and is open to all. The object is to restore, operate, and enjoy older equipment with like-minded hams. A classic radio is any equipment built since 1945 but at least ten years old (an advantage, but *not required* in the Exchange). The same station may be worked with different equipment combinations and on each mode on each band. General call is "CQ CX" and non-contestants may be worked for credit.

EXCHANGE:

Your name, RST, state/province/country, receiver and transmitter type (home brew send PA tube type, e.g., "6L6").

FREQUENCIES:

CW—up 60 kHz from low band edges.

Phone—3910, 7280, 14280, 21380, 28580.

Novice/Tech—3720, 7120, 21120, 28120.

SCORING:

Multiply total QSOs by number of different receivers, transmitters, states, provinces, and DX countries worked on each band and mode. Multiply that total by your classic multiplier: total years old of all receivers and transmitters used, three QSOs minimum per unit. If equipment is a transceiver, multiply age by two.

ENTRIES AND AWARDS:

Certificates and other appropriate memorabilia are awarded periodically for highest scores, longest DX, best excuse, and other "unusual achievements." Send logs, comments, anecdotes, etc., to Stu Stephens K8SJ, 2386 Queenston Rd., Cleveland Heights OH 44118. Include an SASE for a copy of the *Classic Radio Newsletter*.

Ham Help

I would like to correspond with any ham using a Heath HW-18-3 160-meter single side-band transceiver on CW as well as SSB.

William Toben W7JGL
1244 W. Schafer Drive
Tucson AZ 85705

I have been taking 73 Magazine now for three years. I want my Novice license very much. I am 70 years old and

blind—my wife reads the magazine to me. I have 73's code tape and know the code very well. However, I can't receive too well, as I don't know Braille and can't read back anything after writing it down.

I believe I could pass my theory test. I need to know just what is required for the blind to pass the test and if there is anything else I could get that might help me. I have radios

that I listen to all the time, but I would be happy to talk to someone.

Can anyone give me any help or advice?

Raymond L. White
3341 James Avenue
Fort Worth TX 76110

I am looking for meter rewinding information and/or specifications for a replacement meter for a Johnson Viking Challenger transmitter. Thank you.

George L. Smyth N8AMZ
1316 Eastern Ave.
Morgantown WV 26505

I need any information I can get for a Keithley Milliohmmeter Model 502.

Will buy, copy, or pay to have copied information on batteries, operation, calibration, and schematics.

Dave Hammer K0PCL
610 E. South
King City MO 64463

I would like to form an exchange of solar, alternative energy, and anti-nuclear information with thinking hams.

James G. Coote WB6AAM
906 Dexter Street
Los Angeles CA 90042

W2NSD/1 NEVER SAY DIE

editorial by Wayne Green

from page 6

... not just for our own egos, but in order to keep newcomers entering our hobby and thus keeping it alive.

Without the support of a national organization, what can we as individuals or even as clubs do to help the situation? Well, getting publicity is not difficult once you recognize how the system works ... ask your terrorist or other politically active group. No, I'm not suggesting that hams start fire bombing police cars; I'm just pointing out that a realization of how television and newspapers select what they think is news will give us some ideas which can allow us to take advantage of a seriously unbalanced situation.

Take a large parade ... maybe thousands of people and floats. That's not news. But if you add six yelling and screaming agitators in a small group jostling the parade, that's what you'll see on the news that evening ... and not the ten thousand people in the parade. No, we don't want to break up parades either ... we just want to understand what *is* news and what is *not* news.

Our getting publicity should take advantage of amateur radio's possibilities. For instance, suppose we set up a national net to check food prices and report the inequities. Then amateurs could set up cars or vans in front of grocery stores with a big report poster showing the comparison between the prices in that store and other stores around the country ... where large price differences are found.

There are plenty of these price inequities to be found, and the project would make television all over the country. Heck, right here in Peterborough you can find 10% to 20% differences in the prices of identical products just between the Grand Union and A&P stores! As long as stores end prices in a 9, we know that these prices are not honest ones ... at least the chances are 90% against their being honest. We know for darned sure that a price ending in 9 is 90% of the time picked because it seems lower than one which is one cent more. If products were honestly priced, the prices would end in a random selec-

tion of numbers ... which should reflect the cost of manufacture and distribution. We also know darned well that if the honest price of a product comes out to be, say, 80¢, it will turn up on the store shelf at 89¢, not at 79¢.

There are fewer and fewer products which are not being priced in 10¢ steps, all ending in a 9. The carpet people go in dollar steps, always managing to end in 99. Bless 'em.

Ham communications could do the job, using two meters for price reports in the immediate area and perhaps 20m for long-range comparisons. And if you don't think something like that wouldn't make every television news broadcast in the country, you have another think coming.



CQ... DE LEAVENWORTH

The chap in the middle, between the two police officers, has some serious problems. The photo was taken from a video monitor shortly after the arrest of the unhappy chap in the center for shoplifting.

This fellow had previously been into the store, one of the largest ham stores in the country, and had been suspected of gaining a good deal of weight during his earlier visit. This time they were waiting for him, complete with video monitoring and recording. The police were called and arrived to watch him stuffing his coat with books and parts via the TV monitor.

You see him in the Polaroid above, just after having been read his rights and as he was being carted off to the police station for booking.

The monitoring system has worked well, providing the staff with some rather clear pictures of shoplifters for use during later visits, complete with police in the audience. The tape recorder allows a moment by moment replay of the surveillance at any later time ... which helps in the case of any later claims of innocence.

Hams working to beat down the artificially high prices on food ... hams working to bring honesty to pricing and show up the price gougers.

The gas shortage may not last very long, but we could take advantage of the tremendous interest in this situation by setting up a ham reporting network on two meters in each area which could let motorists know where gas was to be found, where the gas lines were the shortest, and gas prices ... particularly on weekends. Temporary signboards along the major routes, manned by hams (with coordination by a local ham club), would make the news broadcasts. The gas stations could be checked by telephone for the latest news of their situation or checked out by mobile units. It would be a fun project and would provide a real service. Now that the idea is out, if you don't do it, the CBers will, and you'll have to see them on television and in the newspapers. Your choice.

Those are just a couple of ideas. I'm sure you'll be able to come up with more and possibly better ones. Those came

to me while I was taking a shower this morning. Take a shower. Let's get amateur radio known and appreciated.

THE ARRL LINE

Every time I tune from 14,200 on up past 14,275 to where the channels are packed solid with nets and QRM, I tend to think of the dividing line at 14,275 kHz as being the ARRL line. This dividing line is there because the League forced the FCC to take away General frequencies. Before the advent of "incentive licensing," there was no such line and General Class licensees had the use of the entire band. Now they're jammed up into half the phone band, away from 99% of the attractive DX ... certainly away from the relatively open frequencies in the lower part of the band ... and from SSTV experimenting.

This all started in 1963 when the League, being run at the time by some old-timers who wanted the ham bands to be back the way they were before the War, pushed through a disastrous piece of legislation. Amateur reaction to the proposals was so furious that it almost stopped the League, despite their inside help via Herb Hoover, Jr. The amateur reaction brought the sale of amateur equipment almost to a halt and stopped the growth of the hobby for over ten years. Talk about disaster!

This was the time when most of the famous names in ham manufacturing disappeared ... Hallicrafters, National, Hammarlund, Johnson, Harvey Wells, B&W, etc. Tuning past 14,275 brings back these memories of the havoc wrought by the League in the 1960s. 73 was too small then to be more than a cry in the wind, but I think that without the cry the League proposal to remove Generals entirely from the major DX bands would have gone through. The retaining of half of the bands by Generals was better than nothing.

The result of all this? Proof that forcing amateurs to upgrade would not work. Many of us held that the FCC should offer rewards such as better call letters rather than taking away frequencies and then giving them back if you upgraded. If you are locked above 14,275, it's something to think about.

SAROC ZOMBIE

That's what they call the dead brought back to life ... or at least some semblance of life ... and it seems apropos for the SAROC hamfest. This is a strictly commercial venture run for profit by a chap in Nevada and it died a couple years ago of extreme neglect. I see a report that this exploitation of amateur

radio has been announced again for next year in Las Vegas.

The main purpose of SAROC is to provide a legal excuse for a few of the ham manufacturers to go to Las Vegas for a vacation in January. The actual business done is a farce. For instance, one major supplier brought in a truckload of ham gear for his exhibit at the last show and over the three days of the show sold \$1,500 worth of gear. That's less than one tenth of the minimum acceptable business for him just to break even.

Now, if the show was that lousy when there was still plenty of gas for the California hams to drive over the desert to come, who will be there when gas is in short supply and a lot more expensive? Ten years ago, when FM and repeaters were firing everyone's imagination, the local Vegas FM club ran a hospitality suite. Art Householder of Spectronics also had a hospitality suite where he made everyone crazy with desire for recycled Motorola HT-220s which he pulled from his pockets and sold in a kind of under-the-table atmosphere. It was heady stuff and FMers were king of the roost.

No more. The last show, two years ago, was held together mainly by itinerant hams in town for the concurrent winter Consumer Electronics Show and who came over to the hamfest for a few minutes to see what their poor relatives were doing. Next year, CES will be January 5-8th. The hamfest will be the 10-12th and the Fifth Annual Ham Industry meeting will be in Aspen, Colorado, on January 12-19th. I'll probably hop out on the 7th for a couple of quick days at CES, visit the Wilson factory on the 9th in Vegas, see who was wealthy enough in the industry to "exhibit" at the hamfest, and then poop or up to Aspen for the yearly industry conference and workshops.

SAROC, being run strictly for a profit, has a tremendous charge for attending... I think I paid \$17 last time... and for that I got to wander around a handful of booths. It took me maybe half an hour to see everything. There was no recognizable program. ARMA held a meeting, but many of the manufacturers were unable to find the meeting room, which was very well hidden.

Now, why is Wayne Green so down on SAROC? Is it that I'm getting even because I haven't been asked to speak? No... as a matter of fact, I've been asked to speak and have refused. It's a long story and there is a lot of background. It comes down to a question of supporting what I

feel are unsavory elements. I sure wish someone would take the time to write an exposé of the people behind this hamfest.

Anyway, between the gas problem and the CES show ending two days before the hamfest, it seems unlikely that the next SAROC will be any improvement over the last one... which had CES to help and no gas problems... and still was a disaster. Perhaps this commercial show should be put to rest and remembered for its heyday ten years ago instead of its more recent disappointments.

DXERS AND LISTS

A lot of true-blue DXers are very uptight over list operations. For those of you who have not enjoyed the spice of working serious DX, a list of calls is taken by some intermediary and passed along to the rare DX station, who then works the list and only the list. This can be very upsetting for some operator who comes along after the list has been drawn and finds that while he can hear the DX station easily, he can't work him. Oh, bitter anguish!

The operators of rare DX stations have several choices open to them when they get on the air. First, they know that a normal contact is out of the question because every time they stand by there will be dozens, then hundreds, of stations all calling them simultaneously. The din soon gets so great that it is impossible to hear any call distinctly and the tendency then is to wait out the caterwauling until there is just one station left to come back to him.

The encouraging of "tail-ending" quickly screws up everything. The waiting hordes quickly detect what is happening and there soon develops a two or three operator contest to see who can be the last one to call. None of them can even hear the DX station and none will quit the bedlam, so the calling can go on for several minutes. One W5 I know got steamed up at a certain K6 and the two of them refused to budge or listen on the frequency for well over an hour. The poor DX station had gone to bed long before they stopped jamming each other.

Some DX ops like the system where a DX station operates from just outside the US band and tunes for calls. I like this, too, for it doesn't take long to find out where the chap is tuning and jump in the pileup on that frequency.

Having been on the other end of the pileups, I have some observations from the viewpoint of the rare DX station. Newcomers, I've DXed from the following rare and relatively rare spots: JY, OD, 5Z, YK, YA, VU, 9N, FK, VR2, 5W, KS6, FO8,

KW6, KG6, KC4, HH, PJ, 4U, OH0, VP9, VP7, and probably some more that don't come right to mind. The main problem in working a lot of stations from a rare location is not in hearing them—it's in pulling the calls apart and getting the individual calls.

After trying every known system for working 'em as fast as possible, which included working by call districts on my own frequency, working from outside the US band and listening on one frequency in it, tuning a small band of frequencies, and working from lists, there was no question... the list could beat everything by far.

Well, let me amend that. The list situation works great if you manage to get hold of some sharp operators to gather the lists for you. I somehow always managed to get one or maybe two good ops and one thoroughgoing idiot. I really hate it when I think I have everything set up for some really fast operating. I've rounded up three chaps with good signals to move off my frequency and copy down call letters for me... maybe ten at a time. Then all they have to do is come on my channel and read off the list quickly so I can write the calls down and give each one in turn a report. I can run through ten in one minute if I have the calls. And getting the calls shouldn't take more than one minute at best, right?

So on comes my helper with his list: "Hello, Juliet Yankee Eight Alpha Alpha. Juliet Yankee Eight Alpha Alpha, this is Kilo Baker Zero Xray Quebec Quebec. This is Kilo Baker Zero Xray Quebec Quebec in Washington, Nebraska. That's doubleyou whiskey, aye America, ess Sweden, aich hotel, eye Indiana, enn Nancy, gee George, tee Toronto, oh Oregon, enn Nancy. The name here is Wilbur... that's doubleyou whiskey, eye Indiana, ell love, bee bravo, you Uruguay, are radio. You're certainly putting a good signal in here, Wayne, really poking the old S-meter around. I have your list for you. I sure hope everyone on the list is going to come up here and find us. Let me know if you're getting me all okay and I'll pass along the list. Juliet Yankee Eight Alpha Alpha, this is Kilo Bravo Zero Xray Queen Queen standing by."

I grunt out a terse "go ahead, quickly, please," stifling an oath. Good old Wilbur comes back, spelling out both of our calls again, apparently in the belief that I may have forgotten not only his call, but my own, too. Then he starts slowly spelling out each call, one at a time, spelling each one twice for me and standing by after each call has been sent, triumphantly.

Wilbur is able to take a one-minute task and escalate it to nerve-shattering lengths for all concerned, stretching it out for maybe ten minutes or more. By this time, the other two chaps who have been scrounging calls for me are on channel wanting to give me their lists and I suddenly have thirty stations to work instead of just ten.

Ten works well. Thirty doesn't. Before I can work my way down through even twenty of the chaps, I have some breakers wanting to know who is on there, how can they get into the contact, where is the list being made... plus an Italian calling CQ DX with a 40 over 9 signal. When I ask him to stand by, he gives me my report, spells out his name twice, then the name of his town twice (why do most Italian towns have over twenty letters?), and refuses to get off the frequency until I give him my location and agree to QSL.

It is unfortunate that many lists are run in a much slower style. Hopefully, some of the DX operators will read this or hear about it and get moving faster. I heard YK1AA on the other evening and some OK station was running a list for him. It took maybe five minutes for each damned contact... and all Rasheed did was swap signal reports and call letters. But it went on with excruciating slowness and drove me and a few hundred others up the wall. I didn't particularly need a contact with Syria; I just wanted an opportunity to say hello to Rasheed since I had visited him and operated from his station a few years back.

Try the live list system with perhaps three good operators, all with good signals and in separate parts of the country, taking calls for the DX station. If you can't clearly read off ten calls, spelling them out as you go for the DX op to copy, in less than one minute, then you need some practice. Once the DX op has the calls, 95% of the work is over... he can then stand by for one, get the report, give a report, and get an okay... stand by for the next, etc. He doesn't have to spell any calls out or even give his own call more than once every few minutes.

The purpose of most DXpeditions is to work as many stations as possible in a given time... so why horse around with slow and frustrating systems?

MAY WINNER

"The W7GAQ Key Collection" collected an extra \$100 for author Martin Krey K7NZA, since his article was voted the best in our May issue. Make sure your favorite article gets recognized by using your Reader Service card ballot.

Microcomputer Interfacing

from page 26

unique digit enable code, and then output these eight bits of information to the interface. For instance, the value 01010011 will cause a five to be displayed on the fourth digit from the right on the display. The digit enable code in this example is 0011, and the digit enable code for the right-hand display is 0000.

To display the number 3,163,908,332, register pair H is first loaded with the memory address where the two least-significant digits (LSDs, 32) are stored. In Fig. 4, this address is 004 120. Only five memory locations are required to store the 10-digit number, because the number is stored in a packed BCD format. The D register, which is used to store the digit enable code, is then set to zero. The content of register D, which will eventually be latched by the interface hardware, is used to turn on one and only one digit at a time. At DISPL1, the DIGIT subroutine is called, so that the content of memory addressed by register pair H is moved to

the A register. Since the data values are stored in memory as packed BCD digits, this subroutine unpacks them. The digit in the four LSBs of the A register is rotated to the left four times, bit by bit. The first digit to be displayed is now in bits D7 through D4 of the A register when the OUTIT subroutine is called.

At OUTIT, the four LSBs of the A register are set to zero by the ANI instruction (the digit to be displayed is in bits D7 through D4). The digit enable code contained in the D register is then added to the BCD number in the A register and the result is output to the interface (OUT 125). When this word is output, the four LSBs determine which digit is enabled and the four MSBs represent the value to be displayed. The first time the OUTIT subroutine is executed, the A register will contain 00100000, because a two must be displayed on the right-hand digit.

At the end of the OUTIT subroutine, the content of the D register (the digit enable code)

is incremented from zero to one, preparing it for the next digit enable code. To "intensify" the digit that has just been turned on, the computer executes a time delay at INTENS. Thus the digit is kept on for a period that allows it to be clearly seen. When the 8080 finishes the OUTIT subroutine, it returns to the MOVAM instruction just before the OUTIT subroutine.

The A register is loaded with the content of the same memory location addressed by register pair H, only this time the BCD digit contained in bits D7 through D4 must be displayed. This is the second digit from the right in the number 3,163,908,332. The ANI instruction at OUTIT sets bits D4 through D0 to zero and the digit enable code (one) is added to

/THIS PROGRAM DRIVES A 10-DIGIT, MULTIPLEXED,
/LIGHT EMITTING DIODE (LED), SEVEN-SEGMENT DISPLAY
/IN ADDITION, INSTRUCTIONS HAVE BEEN ADDED SO THAT
/THE INTENSITY OF EACH DISPLAY IS EQUAL.

```
DISPLA, LXIH    /LOAD REGISTER PAIR H WITH THE MEMORY
          120    /ADDRESS WHERE THE BCD DIGITS ARE STORED.
          004    /004 120 = HEX 0450
          MVID   /LOAD D WITH THE FIRST DIGIT
          000    /THAT WILL BE ENABLED
DISPL1, CALL   /DISPLAY THE FIRST TWO PACKED
          DIGIT  /BCD DIGITS
          0
          INXH   /INCREMENT THE MEMORY ADDRESS
          MOVAD  /GET THE DIGIT ENABLE WORD INTO A
          CPI    /COMPARE IT TO THE
          012   /ELEVENTH DIGIT ENABLE COUNT
          JNZ    /HAVEN'T DISPLAYED ALL TEN
          DISPL1 /DIGITS YET, SO DO TWO MORE
          0
          JMP    /HAVE DISPLAYED ALL 10 DIGITS,
          DISPLA /SO DISPLAY THEM ALL AGAIN
          0
DIGIT,  MOVAM  /GET THE PACKED BCD WORD INTO A
          RLC   /ROTATE THE FOUR LSB BITS INTO THE
          RLC   /FOUR MSB BITS
          RLC
          RLC
          CALL  /THEN DISPLAY THIS DIGIT
          OUTIT
          0
          MOVAM /GET THE SAME WORD AGAIN
OUTIT,  ANI    /SAVE ONLY THE FOUR MSBS
          360   / (360 = HEX F0)
          ADD  /ADD THE DIGIT ENABLE
          OUT  /OUTPUT THE EIGHT-BIT VALUE
          125
          INRD /INCREMENT THE DIGIT ENABLE
INTENS, MOVIE  /LOAD E WITH A NUMBER
          100   /100 = HEX 40
INTEN1, DCRE  /DECREMENT THE NUMBER
          JNZ  /IF IT IS NON-ZERO, EXECUTE THE
          INTEN1 /JNZ INSTRUCTION BACK TO INTEN1
          0
          RET  /WHEN E = 0, RETURN
```

Fig. 4. Displaying a 10-digit number on a multiplexed LED display.

/THIS PROGRAM DRIVES A 10-DIGIT, MULTIPLEXED, SEVEN-
/SEGMENT DISPLAY. A LOOK-UP TABLE IS USED TO CONVERT
/BCD NUMBERS TO THE APPROPRIATE SEVEN-SEGMENT CODE.

```
DISPLA, LXIH    /LOAD REGISTER PAIR H WITH THE MEMORY
          120    /ADDRESS WHERE THE BCD DIGITS ARE STORED.
          004    /004 120 = HEX 0450
          MVID   /LOAD D WITH THE FIRST DIGIT
          000    /THAT WILL BE ENABLED
DISPL1, CALL   /DISPLAY THE FIRST TWO PACKED
          DIGIT  /BCD DIGITS
          0
          INXH   /INCREMENT THE MEMORY ADDRESS
          MOVAD  /GET THE DIGIT ENABLE WORD INTO A
          CPI    /COMPARE IT TO THE
          012   /ELEVENTH DIGIT ENABLE COUNT
          JNZ    /HAVEN'T DISPLAYED ALL TEN
          DISPL1 /DIGITS YET, SO DO TWO MORE
          0
          JMP    /HAVE DISPLAYED ALL 10 DIGITS,
          DISPLA /SO DISPLAY THEM ALL AGAIN
          0
DIGIT,  MOVAM  /GET THE PACKED BCD WORD INTO A
          CALL  /THEN USE THE LOOK-UP TABLE TO
          OUTIT /DETERMINE THE PROPER SEQUENCE
          0     /OF ONES AND ZEROES.
          MOVAM /GET THE SAME WORD AGAIN
          RLC   /ROTATE THE FOUR MSB BITS INTO
          RLC   /THE FOUR LSB BITS.
          RLC
          RLC
OUTIT,  ANI    /SAVE ONLY THE FOUR LSBs
          017   / (017 = HEX 0F)
          PUSHH /SAVE REGISTER PAIR H ON THE STACK
          LXIH  /LOAD REGISTER PAIR H WITH THE
          BINSS /BASE ADDRESS OF THE LOOK-UP TABLE.
          0
          ADDL  /ADD THE LO ADDRESS TO THE NUMBER IN A
          MOVLA /SAVE THE RESULT IN THE L REGISTER
          JNC   /THERE IS NO CARRY, SO LEAVE THE
          OKASIS /CONTENT OF THE H REGISTER ALONE
          0
          INRH  /INCREMENT THE H REGISTER BY ONE
OKASIS, MOVIA  /OUTPUT AN INVALID DIGIT ENABLE CODE
          377   /SO THAT THE DISPLAY IS BLANKED.
          OUT
          125
          MOVAM /GET THE SEVEN-SEGMENT CODE INTO A.
          POPH  /POP REGISTER PAIR H OFF OF THE STACK
          OUT   /THEN OUTPUT THE VALUE TO THE
          126   /INTERFACE (7475 AND UDV2981).
          MOVAD /GET THE DIGIT ENABLE CODE
          OUT   /AND OUTPUT IT TO THE INTERFACE
          125
          INRD  /INCREMENT THE DIGIT ENABLE
INTENS, MOVIE  /LOAD E WITH A NUMBER
          200   /200 = HEX 80 = DECIMAL 128
INTEN1, DCRE  /DECREMENT THE NUMBER
          JNZ  /IF IT IS NON-ZERO, EXECUTE THE
          INTEN1 /JNZ INSTRUCTION BACK TO INTEN1
          0
          RET  /WHEN E = 0, RETURN

BINSS,  077   /SEVEN-SEGMENT CODE FOR 0
          006   /SEVEN-SEGMENT CODE FOR 1
          133   /SEVEN-SEGMENT CODE FOR 2
          117   /SEVEN-SEGMENT CODE FOR 3
          146   /SEVEN-SEGMENT CODE FOR 4
          155   /SEVEN-SEGMENT CODE FOR 5
          174   /SEVEN-SEGMENT CODE FOR 6
          007   /SEVEN-SEGMENT CODE FOR 7
          177   /SEVEN-SEGMENT CODE FOR 8
          147   /SEVEN-SEGMENT CODE FOR 9
          000   /SEVEN-SEGMENT CODE FOR 10
          000   /SEVEN-SEGMENT CODE FOR 11
          000   /SEVEN-SEGMENT CODE FOR 12
          000   /SEVEN-SEGMENT CODE FOR 13
          000   /SEVEN-SEGMENT CODE FOR 14
          000   /SEVEN-SEGMENT CODE FOR 15
```

Fig. 5. Using a look-up table with the multiplexed LED display.

the number and the result output. After incrementing the digit enable code to two, the 8080 again executes the INTENS delay loop, so that the three on the second digit from the right is displayed for a reasonable amount of time. When the RET instruction is executed, the 8080 returns to the INXH instruction just before DISPL1.

The 8080 increments the memory address in register pair H and then examines the digit enable code contained in the D register. If this code is less than 012 (decimal 10), the 8080 jumps back to DISPL1 so that the two BCD digits now addressed by register pair H are displayed. If the digit enable code is equal to 012, then all ten digits in the number have been displayed. If this is the case, the 8080 jumps back to DISPLA so that the memory address in register pair H and the digit enable code in the D register are re-initialized.

As you can see from this program, the 8080 is constantly updating (writing new information out to the interface) the display. New digit enable codes and data values are output to the display every millisecond.

Unfortunately, this "ties up" the microcomputer and it cannot perform any other tasks. Of course, the program listed in Fig. 4 could be converted to a subroutine. If it is called every 15 or 20 ms, the 10-digit number will still be displayed at a reasonably fast rate. However, it may be difficult to program the microcomputer so that the DISPLA subroutine is called this often.

One solution to this problem is to use an interrupt. This means that whenever the 8080 is interrupted, it outputs a numeric value to the next consecutive digit in the display. The microcomputer will have to be interrupted at least 400 times every second for the display not to "flicker." This means that our 10-digit number will be displayed 40 times every second. To interrupt the 8080 so that it "services" the display this frequently, a low frequency oscillator (400 Hz) can be wired to one of the interrupt interfaces previously discussed.^{2,3}

The program that services the interrupt and outputs a new

eight-bit value to the display interface is very similar to the software in Fig. 3. Because of its length, we have not included a listing of it. The only difference between the two programs is that the 8080 has to store the digit enable code and the address of the memory location that contains the next digit to be displayed. These values must be stored in memory, because register pair H and the D register may be used by the program that was interrupted. Therefore, each time the oscillator interrupts the microcomputer, it has to read from memory the address for the next digit to be displayed and its corresponding digit enable code. After the number is displayed, the digit enable code and the memory address have to be incremented and stored back in memory. To keep this software as simple as possible, it is easiest to store the 10-digit number in ten memory locations, one digit per memory location, rather than "packing" the BCD data.

One feature of our interface that we have not mentioned is the fact that we are limited by the DS8857 to display only the numbers 0 through 9. This device cannot be used if we wish to display the letters A through F, as is often the case if hexadecimal numbers or message codes need to be displayed. To display the hexadecimal characters 0-9 and A-F, the DS8857 must be replaced by a device that can be used to drive individual segments in any combination we desire. The UDN-2981A (Sprague Electric Company, Worcester MA) contains eight individual drivers that can be used in the display interface. This device has eight inputs and eight outputs—each input is interfaced to an individual data bus line by means of a latch circuit and each output is wired through a current-limiting resistor to one of the segment inputs of the display (A-G). If desired, the last driver in the integrated circuit can be used to drive the decimal point in the display. Since the UDN-2981A has eight inputs, an eight-bit output port (latch) will have to be used to interface it to the microcomputer. This means

that one output port will be used to output the sequence of ones and zeroes that specifies a specific sequence of segments to be turned on or off. A four-bit output port is also required so that the digit enable code can be output and stored in the interface.

In Fig. 5, there is a look-up table used for converting BCD numbers to seven-segment codes.

The first difference between the programs listed in Figs. 4 and 5 can be seen at DIGIT. After the packed BCD word is moved from memory to the A register, the OUTIT subroutine is called. This means that the first BCD digit to be displayed is in bits D3 through D0 of the A register. At OUTIT, bits D7 through D4 of the A register are set to zero. The content of register pair H is then saved on the stack and register pair H is loaded with the base address of the look-up table. The BCD number in the A register is added to this address. The MVIA and OUT instructions at OKASIS cause the display to be blanked by writing an invalid digit enable code out to the display interface. While the display is blanked, the 8080 moves the bit pattern for the number to be displayed from memory to the A register (MOVAM). Register pair H is then popped off the stack and the seven-segment bit pattern is output to output port 126. The A register is then loaded with the digit enable code which is output to output port 125. When the OUT 125 instruction is executed, the specified digit in the display is turned on. The 8080 executes an intensifying time delay loop before returning to the MOVAM instruction just after DIGIT.

The MOVAM instruction loads the A register with the same packed BCD word that contained the previously displayed digit. However, the BCD digit in bits D7 through D4 must now be displayed. Therefore, bits D7 through D4 are rotated into bits D3 through D0 of the A register before the 8080 executes the instructions at OUTIT which cause the required bit pattern for the seven-segment display to be fetched from the look-up table. The bit

pattern followed by a digit enable code is then output to the interface. The remaining instructions in Fig. 5 are the same as the instructions in Fig. 4.

One advantage of using seven or eight individual segment drivers is that you can display any combination of segments that you want. You are no longer limited to the numbers 0-9. If desired, you can display the letters A-F so that hexadecimal numbers can be displayed. For some special applications, some additional letters and words can be displayed, such as H, r, L, o, OIL, HELP, Error, etc.

There is one additional display method that we have not discussed—the use of an external display controller integrated circuit to control the multiplexed display. The Intel Corporation makes a number of these integrated circuits that are compatible with the 4004/4040, 8080, and 8085. These are the 4269, 8279, and 8279-5 integrated circuits. National Semiconductor Corporation also has two display controller integrated circuits that can be used with six-digit displays. One of the devices (MM74C912) can be used to display 0-9 and the other (MM74C917) can be used to display hexadecimal numbers. For additional hardware and software information about multiplexed LED displays, we refer you to reference 4.

References

1. P. R. Rony, D. G. Larsen, and J. A. Titus, "Microcomputer Interfacing: Accumulator I/O vs. Memory I/O," *American Laboratory*, (8) 2, p. 119 (1975).
2. J. A. Titus, D. G. Larsen, and P. R. Rony, "Microcomputer Interfacing: Microcomputer Interrupts," *American Laboratory*, (8) 8, p. 67 (1975).
3. D. G. Larsen, P. R. Rony, and J. A. Titus, "Microcomputer Interfacing: The Vectored Interrupt," *American Laboratory*, (8) 9, p. 116 (1975).
4. C. A. Titus, P. R. Rony, D. G. Larsen, and J. A. Titus, *8080/8085 Software Design*, Howard W. Sams & Co., Inc., Indianapolis IN, 1978.



Ham Help

I need an operator's manual and schematic for a BC-1031 panoramic adapter. I will gladly pay for all copying and postage.

Chuck Holstein WD5CUG
4721 Lucy Dr.
El Paso TX 79924

I would like to copy or purchase the manual and/or schematic for the Multi-Elmac AF-67 transmitter and power supply. Can anyone help? Thanks.

Al Christman WD8CBJ
Box 44
Granville WV 26534

I have some older VHF equipment that utilizes electron tubes (remember those things?). Anyway, there doesn't appear to be a ready market for the tubes I need and I can't find a distributor who sells them.

If anyone has one or more tubes I list below, I would appreciate hearing from them, particularly those having the 6850. The tubes I need are: 5696, 5718, 5896, 5899, 5902,

5940, 6021, 6112, and 6850. Many thanks.

Bill Walston KB5GD
Drawer 1418
Rockport TX 78382

Does anyone have a Geiger counter in good working condition reasonably priced? Please send me the particulars.

Leroy Lawmaster W5HOM
Rt. 1 Oak Hill
Westville OK 74965

DX

from page 12

clerk.

Although the story seems to be changing daily, it now appears that the DXCC desk will not accept TH8JM cards for credit. If you need this one, you will probably have to work John again when he gets his true-blue TL8 license.

TR8AC and TR8GDC recently moved to Alexandria, Egypt, and should be heard signing SU any day.

Anyone needing confirmation for an ET3FMA/9E3FMA/9F3FMA contact from 1965 to 1968 can send an SASE to Don Murray W4WJ, 19700 NW 5 Ct., Miami FL 33169.

ON4UN recently worked CR9AJ on 75 meters to complete his 5BWAZ. Five more QSLs and it will be confirmed. 5BWAZ is easily the most difficult operating award to obtain in all of hamdom.

The correct route for ZS2MI QSLs is WA2IEN, 255 Route 17, Upper Saddle River NJ 07458.

C5ABK has reportedly received permission to operate in CR3 Guinea-Bissau for two weeks in December. He is presently assembling the necessary equipment to make the operation a success and plans to open up on December 1st. QSL to G3LQP.

If you worked HV3SJ on November 11/12 and had your QSL bounced by W6KNH, try again. Logs for that period disappeared for awhile, but now they are safely in the hands of W6KNH, all 45 pages.

As we mentioned last month, several of the deserving were surprised last June when they received a citation from the FCC for contacting HS stations in Thailand. The citation stated that Thailand was on the banned countries list. Those responding received a follow-up form letter from the FCC saying only that in view of the reply, the matter was being closed. Apparently, no form letter exists for apologizing and admitting an error.

The Panamanian government has confirmed to the ARRL that HP9 callsigns have never been issued for use on amateur bands. Communication of any type with stations signing HP9 is illegal.

VR6TC has recently acquired some SSTV gear and has been showing regularly on 14233 kHz from 0530Z. QSL to W6HS.

All KZ5 Canal Zone licenses expire September 30, 1979.

9M2FK reports needing Arkansas, Utah, North Dakota, and South Dakota for WAS and

Zone 2 for WAZ. Look for him on 14020 kHz between 1000Z and 1300Z.

Those of you involved in the DX net and/or DX list business should keep in mind that it is possible to violate third-party traffic regulations when passing a list to a DX station. If you compile a list and pass it directly to a station in a non-third-party country, then you could be in violation. If you say "DX1DX call W5USA," then you are in violation. The correct way would be to say "W5USA call DX1DX." If you think this is just nit-picking, then be advised that some FCC monitoring types are on the prowl for just such violations.

Jim Smith P29JS finally received an answer from the Indian government concerning his application for permission to operate from Andaman. Unfortunately, the letter stated that new rules beginning in January, 1979, made it impossible to grant licenses for short stays.

Rumors floated hot and heavy that XZ2P was SP5AUC and that his was a true-blue operation. Unfortunately, the real SP5AUC denied the rumor and that sort of ended that.

While in Poland, we might mention that Polish amateurs are now allowed to work 160 meters between 1750 kHz and 1950 kHz. Maximum power is 10 Watts.

New officers of Murphy's Marauders include Al Meleg N1JW—President, Ron Grzelak K1BW—Vice President, Dan Street K1TO—Activities Manager, and Ron Nevers K1TVM—Secretary/Treasurer. Newsletter editor is Ed Kalin K1RT.

WA1SQB ran off better than 5000 contacts during his HC8 operation in March. He should

be setting up in Montserrat this month where he will be signing either VP2MAY or VP2MI.

Last month we mentioned that sending currency through the mails to foreign hams could bring trouble to the recipient. If you are in doubt as to which countries can receive USA currency in the mails, ask your local post office to check through the Foreign Postal Manual for the country in question. Any illegal items are listed in this manual.

If you've worked everything else, then you might try for all the cities and districts in Japan. A full list can be obtained by sending 14 IRCs or \$8.00 to Michio Koshimizu JR1BFT, 37-3, Nakano, 1-chome, Nakano-ku, Tokyo 164, Japan.

Tom Wong VE7BC recently returned from a business trip to China. While he was there, he inquired into the possibility of obtaining an operating permit for a future visit. Tom says that the current policy of the Central Government is that there will be no amateur radio operation. It seems that there will probably have to be some top-level changes made before any legitimate operation occurs. Tom feels, however, that this is entirely possible, and with the great interest in amateur radio, something might develop before the end of the year. The feeling still runs strong that when a legitimate operation does surface, it will be by the Chinese themselves and not a group of war-mongering, Imperialist, running-dog lackeys, or whomever. Keep the faith.

That Soviet ski team that was signing U0CR successfully reached the North Pole last July.

ZS5DC is Diane Cardell, formerly VQ9DC, now living in Durban. Diane was in on the big Desroches effort by VQ9D, VQ9BP, and others back in 1974.

That HB9APN/BY operation a

few months back did not have official approval and is not being accepted for DXCC credit.

Several "goodies" have been checking into the WA2JUQ Net on 14240 kHz. Heard recently were TA1MB, YI1BGD, FH8YL, and ZS2MI on Marion Island. The time to listen is around 0630Z.

Another net to watch is the DX-DX Net on 21280 kHz. Listen from 1600Z.

Vendaland is the third of the nine African homelands being established by South Africa, the first two being S8 Transkei and H5 Bophuthatswana. Independence day is set for September 13 and several ZS types plan to be there for the unveiling. ZS6AK and ZS6ABO will head a contingent of eight Durban DXers planning to make the 200-mile trip. DXCC status is expected to be the same as Transkei and Bophuthatswana, that is, no decision until after WARC 79 and then a favorable decision made retroactive back to the date of independence.

JF1IST/7J showed on schedule from Okino Torishima with a very good signal to most of the states. The one-man effort opened up on June 11th and ran through June 15th with WB8LDH the last station logged at 0653Z. Weather conditions cut short the expected ten-day stay, but some 5500 contacts were made on 6 through 40 meters. QSL to JA1RNH, Itaru Tomita, 1-2-9, Zaimokuza, Kamakura, 248 Japan.

This is the month (September) the ARRL begins accepting Desecheo QSLs for DXCC credit.

Reports have all 7Q7 stations being shut down and their equipment confiscated.

Slim showed from 3Y6CD in June and from 9A1VU earlier in the year.

The correct route for all FH8OM/YL QSLs is to Box 86, Dzazoudi, 97600 Mayotte... via France.

The Guatemalan Radio Society indicates that TG7AA was Slim and the ARRL is returning the cards without allowing DXCC credit.

There is a multi-national effort being planned for a fifteen-day operation from 3V8 Tunisia this month. Amateurs from France, Italy, and the UK will man as many as ten different stations.

UHF marine-band applicants are being asked to make up their own callsigns until the overworked FCC can get their applications processed and the regular type licenses in the mail.

If you paid more than \$20.00 to the FCC between August 1, 1970, and December 31, 1976, you are eligible for a refund. If you are eligible, then you



Jean F5FV and his nice layout in France. When not chasing DX for himself, Jean serves as QSL Manager for FB8XV.

should obtain a copy of the "Phase One Fee Refund Program" instruction and form manual from your nearest FCC field office or Federal Information Center. Check the June QST for more information.

Remember that EI8H/anything is always Slim and you will save time and money.

Bill KA2WG writes to remind us all that even though KA stations are not recognized as amateur stations by the Japanese government, they still count as Japan for everything except the All Asia Contest. Any US ham being transferred to Japan or Okinawa as US military or a civilian employee of the

military is eligible to obtain a KA license. For more information, contact FEARL, c/o Sam Flemming, USAGH D/O, APO SF 96343.

That's about it for this month. I hope some of the information provided here will help you pick up a few new ones. If it does, let me know. In the meantime,

don't forget we are always looking for DX info and pictures. Any pictures you send us can be returned if you wish. In the meantime, best DX and health.

Thanks as always to the *West Coast DX Bulletin*, *LIDXA Newsletter*, and *WorldRadio Magazine* for much of the preceding information.

Looking West

from page 10

USER RIGHTS

Question: What rights, if any, do repeater users have when being repeated through the station of another amateur? This is a question being fiercely debated in southern California and elsewhere. It recently surfaced here in Los Angeles when one of the control operators on the WA6KOS/R system turned the repeater off on a system user because of the "content of communications." The operator in question yelled "censorship" and the controversy ensued.

One group feels that the system owner, licensee, or control station does not have the right to turn off the repeater for any reason other than a technical malfunction, and that the repeater is akin to a public utility and therefore must be kept on the air regardless of what is repeated. This group feels that the total responsibility for "content of communications" rests with the individual system user, and the use of jamming, music, and even profanity is left to his discretion. To turn a repeater off under these circumstances is an act of censorship against the originating station.

The other side yells "wrong!" The FCC rules clearly state that an amateur station may not transmit profanity, unidentified signals, or music, and that a repeater does constitute an amateur station. Therefore, not only do the system licensee and control operators have a right to terminate system operation in such circumstances as outlined above, but under the terms of Parts 97.113, 97.115, 97.116, 97.119, 97.123, and 97.125 of the FCC Rules and Regulations, they are directly *obligated* to take such action. To do otherwise directly violates FCC rules. This group also feels that once an amateur decides to operate through a repeater, he is, in effect, operating through the station of another amateur. Therefore, when operating through a repeater, the user gives up any First Amendment rights and is totally subject to the will of the system owner/licensee. Whatever standards, guidelines, and

regulations the licensee sets for user operation must be adhered to without question.

Where do we find the answers? Part 97? Have any of you read Part 97 lately? The FCC regulations, in relation to repeater operation, are too ambiguous. For that reason, I have written a letter to the FCC asking direct questions about repeater operation, regulatory enforcement, and other related matters. The letter was written on June 19, 1979, and was mailed to the FCC on June 23rd. It is presented below for your information. If received, the FCC's response will also be presented in this column.

Federal Communications
Commission
M Street
Washington DC
Attn: Personal Communications
Division

Gentlemen:

I wish to ask some specific questions in regard to Part 97 of the Amateur Rules and Regulations, concerning amateur repeater operation.

- 1) Who is responsible for "content of communications," the system licensee or the system user?
- 2) If a repeater system owner permits profanity and unidentified transmissions to be "repeated" via his repeater system (while his system is operational under fully automatic remote control), is he legally responsible for the content of such communications? Can he legally censor such communications? Should he?
- 3) Does the FCC hold any one person legally responsible for "content of communications" and all other aspects of amateur repeater operation?
- 4) What constitutes an operational amateur repeater—an established repeater, known to the community, or a repeater system that happens to be operating at any given moment?
- 5) If an established amateur repeater is resting between transmissions and another amateur decides to operate during that time, is the established amateur guilty of jamming when he operates once again, or is the new operator considered responsible for the subsequent jamming?
- 6) If the conduct of any amateur is considered by his peers to be obnoxious, although he may be technically operating within the regulations of Part 97, can the amateur community, through the Commission, take any legal action to stop said amateur?
- 7) Why is the Commission unwilling to heed the calls for help from amateurs

who are suffering the outrage of willful and malicious interference on both high frequency SSB and VHF FM repeater operations?

8) Is the Commission willing to enforce the terms of Part 97 of the Amateur Rules and Regulations regarding profanity and unidentified transmissions (97.116, 97.119, and 97.123)? If not, why not?

9) Why hasn't the Commission acted to suspend or revoke the amateur license of one Scott Lookholder WB6LHB? He was convicted in federal court on a charge of using foul and abusive language on the two-meter amateur band. I have copies of letters sent to the Commission by southern California amateurs requesting such action. Does the Commission intend to act in this matter?

10) What action can we amateurs take to rid the community of the individuals who, licensed or unlicensed, willfully and maliciously jam, harass, and intimidate the law-abiding amateur's day-to-day operation? Would the Commission be willing to act if supplied documentation of such violations? Exactly what type of documentation does the Commission require before acting on such reported violations?

11) If I challenge the right of another amateur to hold an amateur's license because he operates his amateur station in violation of the regulations as set forth in Part 97, what possible Commission action can be taken? Must I file a formal challenge with your office?

12) Please define the following (using specific examples) as they relate to our subject:

- A) willful and malicious interference
- B) unidentified transmissions
- C) profanity and indecency

I intend to publish this letter—and your response—in my "Looking West" column. Many amateur repeaters are suffering tremendous willful and malicious interference problems, and it is my hope to help guide them toward a solution. Your response to these questions will be appreciated.

Yours truly,
William M. Pasternak

I wish to credit WB2MIC for arousing my interest in this subject. In the June issue of 73, a letter appeared from Jozef which relates directly to the situation out here. Jozef felt that he was treated unfairly by a repeater licensee who may have arbitrarily censored him. I must state my personal belief that, while I may not agree with arbitrary censorship by control operators and system licensees in certain situations, these people are clearly within their rights when they choose to censor. While you and I may not want to adhere to these standards, we are obligated to do so because we really have no alternative. I remember being told by one

amateur that he felt he was a "god" by virtue of the fact that he owned and operated his own repeater. If he demanded that his users "paint their radios with red stripes and operate only while standing on their heads," they had better adhere to his dictates "or else." He had absolutely no compunction whatsoever about turning off his repeater if someone even "sneezed the wrong way." He was clearly "the boss."

It sounds absurd, but that's the way he felt. Having never operated through his system, I cannot tell you how tight a ship he really runs. Jozef and many others are unhappy with this unresolved situation. The problem is spreading. Only the FCC can make a final determination of this matter, and we await their answer.

HANDLING MALICIOUS INTERFERENCE DEPARTMENT

A few months ago, "Looking West" ran a series of articles on the problem of how to deal with malicious interference. While the amount of response to my questions has not been overwhelming, I have received a few letters. Over the next few months, I hope to bring you some of my respondents' views.

The following letter appeared in the June issue of the Mt. Lee (CA) Repeater Association *Newsletter* and is relevant to our discussion:

The jammers must be getting quite a laugh out of repeater users and owners these days, because a lot of us are so easy to bait.

A jammer with nothing better to do will figure out someone's weakness and rub that person the wrong way. Often this jamming is legal, because the one doing the jamming is a ham and uses proper procedure. The jammer, by manipulating the right people with the right words, can tie up a repeater with hours of counter-jamming, shouting matches, and arguments. Former "good guy" hams, when baited and sufficiently angered, may resort to counter-jamming the original troublemaker. The jammer's gotten what he wants: People have taken his bait. A good example of this might be the licensed ham who uses CW on a repeater. He uses correct procedure, callsigns, and breaks properly, but may be trying to bait a response. CW, RTTY, and SSTV are legal on repeaters if mode and bandwidth rules are obeyed. Instead of reacting with hostility, come back with perfect F1 30-wpm telegraphy! What rubs you the wrong way? Do you fall for the bait?

Some of us feel that high power is

the solution to jamming. Boy, it feels good to talk right over the twerp with your 150 Watts and listen to the capture effect on your duplex! Secretly, you probably hope the jammer also has duplex so that he can hear his puny signal get stomped. Although this is satisfying, it creates problems. With 150 Watts versus the 2 Watts of the jammer, the DF committee will have a hard time hearing the jammer. Many jammers don't care if they are Q-5 into a repeater or not, because they get their jollies causing discomfort to other hams.

"Sorry OM... no copy... you're being jammed... 73." You, the legitimate ham, have just succumbed to a psychological defeat from the jammer. The jammer is laughing at you. Try to sign off gracefully, if you're not succeeding. Don't give him his kicks by going QSY or QRT. Try to draw

the jammer out the same way he baits us. Bait the jammer, legally... don't talk to him, talk about him to another ham. Don't get into jamming him. Instead, go to low power and allow plenty of time for breaks. It's unpleasant to hear one of these clowns and you may want to "cover" him, but be sure to leave a space for the DF committee to listen in. While drawing out a jammer, it is important not to act as he does. It's easy to get mad and jam the jammer. Aren't we better than that?

Most of us have a local repeater... a machine we like to hang out on, meet our friends, etc. It is hard to break away from a favorite machine and go somewhere else. We are loyal to the repeater or club to which we belong. When most of us get mad at a jammer, we want to make our stand on our own machine. When the jammer is forced off our repeater or decides to hassle

another group, we tend to become temporarily apathetic about our common problem.

Jammers have knobs on their radios, although it seems some hams don't... and these hams should be helping the ham community by following the jammer around the dial. All repeater users should get some sense of community and try to pool personnel and equipment to beat this thing. We must be able to continue the hunt even if the jammers have left "our" repeater and moved to another. The jammers seem secure in knowing that they can change frequencies without other repeater groups following.

DFers already know what to do, and the average user can also help. When the carriers or cursing start, listen to the input to the repeater. Normally, your radio is set so that you are transmitting on 147.84 MHz (the input) and

receiving on 147.24 MHz (the output). Reverse this setup, or at least find a way to listen on 147.84. (Transmitting on 147.24 is not necessary.) Now, check your S-meter; is the needle 25% over from 0? 80%? 100%? Break with your call, QTH, cross-streets, time of day, and date, and tell the "woodwork" what % reading you have. See if any other breakers would like to give their reports. (We use % of signal instead of S-units because S-meters are not standard or accurate.)

Let's hope we can end apathy on the airwaves and pool our resources. After all, the jamming is only a by-product of our apathy. The problems on repeaters affect us all, and high-power amps, private systems, and 800-channel radios are not adequate solutions to our common problem.

73,
An Interested User

Review

TELEVISION HANDBOOK FOR THE AMATEUR

A large number of hams are professionals in the field of commercial television. Their daily involvement in the world of video gives them a headstart in understanding and operating a fast scan television station. The rest of the population shouldn't be discouraged, though. The book, *Television Handbook for the Amateur*, is a real help in bridging the gap between beginner and pro.

Television Handbook is published by Apron Laboratories and a paperback edition costs

\$6.50. The author, Biagio Presti, is not a ham, but as president of Apron, he is familiar with amateur television efforts. The first two-thirds of the book is devoted to theory, while the remaining 30 pages discuss construction projects and include tables dealing with radio transmission and television standards.

By minimizing the use of mathematics and including numerous illustrations, the author is able to make the theory chapters down to earth and very understandable. The circuits used to generate a video signal are thoroughly

described. To get the most benefit from these chapters, the reader should have a good background in basic transistor circuit design. If you are studying for an Extra class license, the *Television Handbook* may be helpful. Questions concerning television theory appear on some versions of the exam.

There is an abundance of information about special circuits that won't be found in the usual amateur references. Color television may be more of a dream than a reality for most beginning ATVers, but the reader's appetite is whetted by a short summary of the principles involved. The contents of these chapters will be of interest long after your first ATV QSO.

The construction chapters are similar to the theory section.

The sub circuits that comprise 450-MHz transmitters and receivers are tackled individually. It is not like the wire-by-wire description frequently found in some ham publications. There is adequate information for the experienced home-brewer. As a bonus, you will have a good understanding of the theory behind the design.

The recent appearance of commercial equipment and beginner-oriented literature has helped to put fast scan television within the reach of many hams. *Television Handbook for the Amateur* does not give complete coverage of the subject, but for a ham who aspires to be more than an appliance operator, it is bound to be useful.

Tim Daniel N8RK/1
Peterborough NH

OSCAR Orbits

Courtesy of AMSAT

The listed data tells you the time and place that OSCAR 7 and OSCAR 8 cross the equator in an ascending orbit for the first time each day. To calculate successive OSCAR 7 orbits, make a list of the first orbit number and the next twelve orbits for that day. List the time of the first orbit. Each successive orbit is 115 minutes later (two hours less five minutes). The chart gives the longitude of the day's first ascending (northbound) equatorial crossing. Add 29° for each succeeding orbit. When OSCAR is ascending on the other side of the world from you, it will descend over you. To find the equatorial descending longitude, subtract 166° from the ascending longitude. To find the time OSCAR 7 passes the North Pole, add 29 minutes to the time it passes the equator. You should be able to hear OSCAR 7 when it is within 45 degrees of you. The easiest way to determine if OSCAR is above the horizon (and thus within range) at your location is to take a globe and draw a circle with a radius of 2450 miles (4000 kilometers) from your QTH. If OSCAR passes above that circle, you should be able to hear it. If it passes right overhead, you should hear it for about 24 minutes total. OSCAR 7 will pass an imaginary line drawn from San Francisco to Norfolk about 12 minutes after passing the equator. Add about a minute for each 200 miles that you live north of this line. If OSCAR passes 15° east or west of you, add another minute; at 30°, three minutes; at 45°, ten minutes. Mode A: 145.85-95 MHz uplink, 29.4-29.5 MHz downlink, beacon at 29.502 MHz. Mode B: 432.125-175 MHz uplink, 145.975-925 MHz downlink, beacon at 145.972 MHz.

OSCAR 8 calculations are similar to those for OSCAR 7, with some important exceptions. Instead of making 13 orbits each day, OSCAR 8 makes 14 orbits during each 24-hour period. The orbital period of OSCAR 8 is therefore somewhat shorter: 103 minutes.

To calculate successive OSCAR 8 orbits, make a list of the first orbit number (from the OSCAR 8 chart) and the next thirteen orbits for that day. List the time of the first orbit. Each successive orbit is then 103 minutes later. The chart gives the longitude of the day's first ascending equatorial crossing. Add 26° for each succeeding orbit. To find the time OSCAR 8 passes the North Pole, add 26 minutes to the time it crosses the equator. OSCAR 8 will cross the imaginary San Francisco-to-Norfolk line about 11 minutes after crossing the equator. Mode A: 145.85-95 MHz uplink, 29.4-29.50 MHz downlink, beacon at 29.40 MHz. Mode J: 145.90-146.00 MHz uplink, 435.20-435.10 MHz downlink, beacon on 435.090 MHz.

OSCAR 7 Orbital Information				OSCAR 8 Orbital Information			
Orbit	Date (Sep)	Time (GMT)	Longitude of Eq. Crossing *W	Orbit	Date (Sep)	Time (GMT)	Longitude of Eq. Crossing *W
21928	1	0053:46	78.5	7593Jbn	1	0056:12	60.0
21941	2	0148:03	92.1	7607Jbn	2	0101:22	61.3
21953qrp	3	0047:23	76.9	7621Abn	3	0106:31	62.6
21966	4	0141:40	90.5	7635Abn	4	0111:41	63.9
21978X	5	0041:00	75.4	7649X	5	0116:50	65.2
21991	6	0135:17	89.0	7663Abn	6	0122:00	66.5
22003	7	0034:38	73.8	7677Abn	7	0127:09	67.8
22016	8	0128:55	87.4	7691Jbn	8	0132:19	69.1
22028	9	0028:15	72.3	7705Jbn	9	0137:28	70.4
22041qrp	10	0122:32	85.9	7719Abn	10	0142:38	71.7
22053	11	0021:52	70.7	7732Abn	11	0004:33	47.2
22066X	12	0116:09	84.3	7746X	12	0009:43	48.5
22078	13	0015:29	69.1	7760Abn	13	0014:52	49.8
22091	14	0109:46	82.7	7774Abn	14	0020:02	51.2
22103	15	0009:06	67.6	7788Jbn	15	0025:11	52.5
22116	16	0103:23	81.2	7802Jbn	16	0030:20	53.8
22128qrp	17	0002:44	66.0	7816Abn	17	0035:30	55.1
22141	18	0057:00	79.6	7830Abn	18	0040:39	56.4
22154X	19	0151:17	93.2	7844X	19	0045:48	57.7
22166	20	0050:38	78.1	7858Abn	20	0050:58	59.0
22179	21	0144:55	91.7	7872Abn	21	0056:07	60.3
22191	22	0044:15	76.5	7886Jbn	22	0101:16	61.6
22204	23	0138:32	90.1	7900Jbn	23	0106:26	62.9
22216qrp	24	0037:52	75.0	7914Abn	24	0111:35	64.2
22229	25	0132:09	88.5	7928Abn	25	0116:44	65.5
22241X	26	0031:29	73.4	7942X	26	0121:53	66.8
22254	27	0125:46	87.0	7956Abn	27	0127:03	68.1
22266	28	0025:06	71.8	7970Abn	28	0132:12	69.4
22279	29	0119:23	85.4	7984Jbn	29	0137:21	70.7
22291	30	0018:44	70.3	7998Jbn	30	0142:30	72.0

Awards

from page 28

SOUTH AMERICA

CE Chile
 CE8A Easter Is.
 CE8X San Felix
 CE8Z Juan Fernandez
 CP Bolivia
 CX Uruguay
 FY French Guiana
 HC Ecuador
 HC8 Galapagos Is.
 HK Colombia
 HK0 Bajo Nuevo
 HK0 Malpelo Is.
 HK0 San Andres & Providencia
 HP Panama
 HR Honduras
 HR0 Swan Is.
 KZ Canal Zone
 LU Argentina
 OA Peru
 PJ Bonaire
 PJ Netherlands Antilles
 PY Brazil
 PY0 Fernando de Noronha
 PY0 St. Peter & St. Paul
 PY0 Trinidad & Martim Vaz Is.
 PZ Surinam
 TG Guatemala
 TI Costa Rica
 TI9 Cocos Is.
 VP1 Belize
 VP8 Falkland Is.
 VP8, LU South Georgia Is.
 VP8, LU South Orkney Is.
 VP8, LU South Sandwich Is.
 VP8, LU South Shetland Is.
 VP8W South Grahamsland
 YN Nicaragua
 YS Salvador
 YV Venezuela
 YV0 Aves Is.
 ZP Paraguay
 8R Guyana
 9Y Trinidad and Tobago

EUROPE

C3 Andorra
 CT Portugal
 CT2 Azores
 DA-DL Federal Republic of Germany
 DM, DT German Democratic Republic
 EA Spain
 EA8 Balearic Islands
 EI Republic of Ireland
 EJ0 Aran Is.
 F France
 FC Corsica
 G England
 GD Isle of Man
 GI Northern Ireland
 GJ, GC Jersey
 GM Scotland
 GM Orkney Islands
 GM Shetland Islands
 GU, GC Guernsey
 GW Wales
 HA Hungary
 HB Switzerland
 HB0 Liechtenstein
 HV Vatican
 I Italy
 IC Ischia
 IA Tuscan Archipelago
 IS Sardinia
 IT Sicily
 JW Bear Is.
 JW Svalbard Is.
 JX Jan Mayen
 LA Norway
 LX Luxembourg
 LZ Bulgaria
 M1 San Marino
 OE Austria
 OH Finland
 OH0 Aland Is.
 OJ0 Market Reef
 OK Czechoslovakia
 ON Belgium
 OY Faeroe Islands
 OZ Denmark
 PA Netherlands
 SM Sweden
 SP Poland
 SV Greece
 SV Crete
 SV Dodecanese
 SV Mount Athos
 TF Iceland
 UA, UK1, 3, 4, 6 European RSFSR
 UA1, UK1 Franz Josef Land
 UA2, UK2F Kaliningradsk
 UB, UK, UT, UY5 Ukraine
 UC2, UK2 White RSFSR
 UO5, UK50 Moldavia
 UP2, UK2B, P Lithuania
 UQ2, UK2G, Q Latvia
 UR2, UK2R, T Estonia
 YO Romania
 YU Yugoslavia
 ZA Albania
 ZB Gibraltar
 3A Monaco
 4U ITU, Geneva
 9A (See M1)

ASIA

A4X Oman Is.
 A5 Bhutan
 A6X United Arab Emirates
 A7X Qatar
 A9X Bahrain
 AP Pakistan
 BV Taiwan
 BY China
 CR9 Macao
 EP Iran
 HL, HM North Korea
 HL, HM South Korea
 HS Thailand
 HZ, TZ Saudi Arabia
 JA-JR Japan
 JR6, KA6 Okinawa (Ryukyu Is.)
 JD, KA1 Ogasawara
 JT Mongolia
 JY Jordan
 KA US Military in Japan
 OD Lebanon
 S2 Bangladesh
 TA Asiatic RSFSR
 UA, UK, UV, UW9-0
 UD6, UK6C, D, K Azerbaizdhan
 UF6, UK6F, O, Q, V Georgia
 UG6, UK6G Armenia
 UH6, UK8H Turkoman
 UI8, UK8I Uzbek
 UJ8, UK8J, R Tadzhih
 UL7, UK7 Kazakh
 UM8, UK8M, N Kirghiz
 VS6 Hong Kong
 VS9K Kamaran Is.
 VU India
 VU7 Andaman & Nicobar
 VU7 Laccadives
 XU Khmer Republic
 XV Vietnam
 XW Laos People's Dem. Rep.
 XZ Burma
 YA Afghanistan
 YI Iraq
 YK Syria
 1S Spratly
 4S Sri Lanka
 4X, 4Z Israel
 5B4, 2C Cyprus
 8Z4 Neutral Zone
 9H Saudi Arabia/Iraq
 9H4 Malta
 9K Gozo & Comino
 9M2 Kuwait
 9M6 West Malaysia
 9M8 North Borneo
 9N Sarawak
 9V Nepal
 9V Singapore
 Abu Ail, Jabal Attair

OCEANIA

A3 Tonga Republic
 CR8 Portuguese Timor
 C2 Republic of Nauru
 DU Philippines
 FK New Caledonia
 FO French Polynesia
 FW Wallis & Fortuna Islands
 H4, VR4 Solomon Islands
 JD, KA1 Minami Torishima
 JD, 7J1 Okino Torishima
 KB, KH1 Baker, Howland, American Phoenix
 Eastern Carolines
 Western Carolines
 Guam Island
 Rota
 Saipan
 Tinian
 Hawaiian Islands
 Kure Island
 Johnston Island
 KM, KH4 Midway Island
 KP6, KH5K Kingman Reef
 KP6, KH5 Palmyra
 KS6, KH8 American Samoa
 KW, KH9 Wake Island
 KX Marshall Islands
 P2 Papua, New Guinea
 T2, VR8 Tuvalu Island
 VK Australia
 VK Lord Howe Island
 VK9 Willis Island
 VK9 Christmas Island
 VK9 Keeling, Cocos Island
 VK9 Mellish Reef
 VK9 Norfolk Island
 VR1 Macquarie Island
 VR1 British Phoenix Islands
 VR1 Gilbert Island
 VR1 Ocean Island
 VR3 Christmas Island
 VR6 Pitcairn Island
 VR7 Line Island, South and Central (See T2)
 VR8 Brunei
 VS5 Borneo
 YB, YC, YD Celebes
 YB, YC, YD Java
 YB, YC, YD Sumatra
 YJ West Irian
 ZK1 New Hebrides
 ZK1 North Cook Island
 ZK1 South Cook Island

ZK2 Niue Island
 ZL New Zealand
 ZL Auckland & Campbell
 ZL Chatham Island
 ZL Kermadec
 ZM7 Tokelau
 3D2 Fiji Islands
 5W Western Samoa

AFRICA

A2 Botswana
 C5 Gambia
 C9 Mozambique
 CN Morocco
 CN2 Tangier
 CR3 Guinea Bissau
 CT3 Madeira Is.
 D2, 3 Angola
 D4 Republic of Cape Verde
 D6 Comoros
 EA8 Canary Islands
 EA9 Ceuta and Melilla
 EA9 Ifni
 EA9 Rio de Oro
 EL Liberia
 ET2 Eritrea
 ET3 Ethiopia
 FB8W Crozet
 FB8X Kerguelen Is.
 FB8Z Amsterdam & St. Paul
 FH Mayotte
 FR Glorioso Island
 FR Juan de Nova, Europa
 FR Reunion
 FR Tromelin
 H5 Bophuthatswana
 IG Lampedusa Island
 IH Pantelleria Island
 J2, FL8 Djibouti
 S7 Seychelles
 S8 Transkei
 S9 Sao Tome and Principe
 ST Sudan
 ST0 South Sudan
 SU Egypt
 TJ Cameroon
 TL Central African Empire
 TN Congo
 TR Gabon

TT Chad
 TU Ivory Coast
 TY Benin
 TZ Mali
 VK0 Heard Island
 VQ9 Aldabra Island
 VQ9 Chagos (Diego Garcia)
 VQ9 Desroches
 VQ9 Farquhar
 XT Upper Volta
 ZD7 St. Helena
 ZD8 Ascension Island
 ZD9 Gough Island and Tristan da Cunha
 ZE Rhodesia
 ZS1, 2, 4, 6 South Africa
 ZS2 Prince Edward Island
 ZS2 Marion Island
 ZS3 Southwest Africa (Namibia)

3B6, 7 Agalega & St. Brandon
 3B8 Mauritius
 3B9 Rodriguez Island
 3C Equatorial Guinea
 3D6 Swaziland
 3V Tunisia
 3X Republic of Guinea
 3Y Bouvet Island
 4W Yemen
 5A Libya
 5H Tanzania
 5N Nigeria
 5R Malagasy Republic
 5T Mauritania
 5U Niger
 5V Togo
 5X Uganda
 5Z Kenya
 6O Somali
 6W Senegal
 7O People's Dem. Rep. of Yemen
 7P Lesotho
 7Q Malawi
 7X Algeria
 8Q, VS9 Maldiv Islands
 9G Ghana
 9J Zambia
 9L Sierra Leone
 9Q Republic of Zaire
 9U Burundi
 9X Rwanda

Corrections

In "So You Want to Raise a Tower" (July, 1979, page 110), Photo J shows what appears to be a vertical stacking of the cable lengths under the cable clamps. The cable lengths should be positioned in a horizontal side-by-side arrangement such that both halves of the cable clamps contact each side of each cable.

Gene Smarte WB6TOV/1
 News Editor

In reference to "At Last! A Really Simple Speech Processor," June, 1979:

Thanks to W5VSR for pointing out the need for a circuit change. A 10k pot should be added at the emitter of the first transistor.

Sorry about any inconvenience this may have caused.
 Jeff Stadelman W9UT
 Pound WI

Ham Help

I just acquired an 80-10-meter amp. It's a TXL-80B made by Westcom Engineering. The problem is that the final transistors have been blown and I can't find any suitable replacements, as the transistors have a nonstandard "house number." I'd be grateful to anyone who could suggest a good replacement, or give me an address where I might find Westcom. Thanks in advance for helping.

Bob Howle WA4ZID/0
 10432 Baseline Road
 Lafayette CO 80026

I'm the president of the newly-formed Phoenix Honeywell Amateur Radio Club and could use some help. We have a lot of tube-type equipment and most of us would like to replace the front-end rf stage with an

FET equivalent (such as a 6HA5). We would like to build them on a direct-replacement tube socket. Does anyone have tubes-to-FET conversion circuits? Also, does anyone have any application circuits for FET noise blankers or audio noise filters? Any help will be appreciated.

P.J. Scola, President
 Phoenix Honeywell Amateur
 Radio Club
 PO Box 6000
 Phoenix AZ 85005

I am in need of a schematic for a Pride 150 bilinear amplifier, 80-10 meters. If anyone has one and could send a copy, it would be a great help.

Francis Whittier WB1CXX
 RFD #1 Box 339
 Madison ME 04950

ou goons don't ever proof-
lousy manuscripts from bab-
burh...
you...
I insist that you print ev-
tell Ma Bell that she shou

LETTERS

from page 14

electronics experimenter, though, and guess I must agree with you that, in my experience, your mag is more with it in terms of construction articles than are the official publications of the ARRL. I tuned in too late to know the whole background of your seeming vendetta against this organization, but I suspect that you have some valid points, if only because too many organizations in and out of gov't (plus religions) get hardening of the arteries too soon, after which everyone wants to merely survive and not rock the boat. Being an iconoclast, I'm sympathetic.

Recalling the ARRL "pledge of allegiance," so to speak, that would have the ham saying that he owed his hobby to the ARRL, much as I owe my soul to the company store, I don't think I'd care to be represented by that "religious" denomination even if I were to become a ham.

Beyond that, there was a time when I used to buy the *Handbook* every few years, mainly for new test instrument circuits to build. Then I noted that it was about the last and least source of such information. Now I get the unchanging data I need (like the nice LCR resonance chart) from editions some 10 years old. The formula is still good, but magazines such as yours give me a better update on test instrument circuits, even though I scarcely need your July antenna issue, except maybe for my TV set.

**Benjamin Johnson
Rochester NY**

ECLECTICISM

It may interest the ham community to know that Sears, after seemingly abandoning ham radio in the Spring-Summer '79 catalog, has jumped back in with both feet.

On pp. 1238-9 of the Fall-Winter '79 catalog, the Sears 22-channel 2m FM xtal rig has returned, grouped with—brace yourself—the Midland (that's right, Midland—not a Sears nameplate in sight) 13-510A 2m syntho rig and the Midland (again!) 13-509 and 13-513 220 (!) FM rigs (xtal and syntho respectively). I'm not going to comment on prices (other than to

say that they seem reasonable) because there is a bigger matter which this raises.

I was perusing *Looking West* in 73 #200 (May, 1977) which touched on the flak raised by Sears' first foray into amateur gear. This increased involvement (especially the 220 rigs) is bound to raise even more, so I thought I'd get my two cents in before inflation struck. At least Sears does point out that you must have a license, although I wish they could get it straight that it's *Technician*, not "Technical." I'm a Tech myself, and I like them to get my class right. What's more, the added exposure of 220 (use it or...) can't hurt! As for the bugaboo about "da CBer gonna getcha"—well, if we can't handle a few unauthorized signals (the price of the rigs will keep the CB-boom \$39 radio crowd off the band), we are in trouble.

On other matters, keep the mag the way it is (if not better!). Don't be bullied away from the eclecticism, the controversy, and the general free attitude of the magazine! At this time, it's the only ham magazine (counting *Worldradio* as a newspaper) worth reading! Keep it up!!

**Edward Eastman WD0ENF
Minneapolis MN**

IGNORAMI

I cannot sit idly by any more and let some unintelligent and uneducated hams slash your wonderful magazine and enlightening editorials. I cringe every time someone says that Wayne is against ham radio (WD8DWO, Letters, 73 Magazine, June, '79). These people must have read his editorials with their dunce caps on! Anyone who digests them with intelligence or has read Wayne's writings for a while can clearly see that Wayne Green is one of the leading proponents of ham radio and that ham radio is one of Wayne's lifetime loves.

I have been reading his editorials since I received my Novice license in September of '75, and while there have been times when I disagreed with Wayne, I have always been impressed with his honesty and his factual unbiased reports of many situations. I admire the way he has never backed down

on an issue, nor been afraid to state his opinion on any issue. I also admire the way he has succeeded in his business ventures.

So the next time you read one of Wayne's dynamic editorials, read it intelligently and you will learn about the inside happenings of ham radio, politics, business, and about devotion. I have learned about these things and more from Wayne's editorials, and so even though I know Wayne will not let a few ignorami stop him, count me as one of his supporters and keep those unabashed, interesting, and provocative editorials coming. Your magazine is the best in ham radio and better than most of the others in other fields, so continue the good work and take it easy!

**John Kerekes N9EI
South Bend IN**

GREEN PAGES

I just received my first 73 issue on a new subscription. The article on "The KGCY Story" was worth the price of the subscription. Keep articles like this coming and I'll renew... could do with fewer "green" pages, however.

**Ron Schwendt N3AR
Douglassville PA**

EGYPTIAN PROGRESS

As the first woman member of the Egyptian Radio Club, Inc., Granite City IL, I feel compelled to respond to the "Letter to the Editor" written by Tania Miller WB9TKC that appeared in the August, 1978, issue of 73 Magazine. Tania's letter was written as a result of the difficulty experienced by women who wished to become members of the club. At that time there were enough members who did not want women in the club to block any attempt by women to join. Since that time, however, open-minded members have been responsible for changes that allow any responsible amateur radio operator to join the club.

I believe that this progress shows that old traditions and ideas must be changed when they do nothing except cause hurt feelings or give people in control a feeling of power. There is no place in amateur radio for prejudice.

My husband and I have both enjoyed being members of the Egyptian Radio Club very much. We have met and learned from a super bunch of fellow hams. We are pleased with the progress that has been shown in the Egyptian Radio Club, Inc.

**Bess J. Nelson WD0CZF
Florissant MO**

NUKES

One year ago, I was one of those people who thought nuclear power would really help. I didn't question the authority of the geniuses who gave us Three Mile Island, Brown's Ferry, and the Karen Silkwood cover-up.

Since then I have learned a lot about the poor engineering, short-term monetary greed, and media whitewashing that goes hand in hand with the nuclear industry.

On June 30, I and forty to fifty thousand people were at the Diablo Canyon rally in San Luis Obispo, California. I saw exhibits there on solar and many types of alternative energy—alternatives that have been here for years. There were people from all walks of life there, and even some fellow amateurs.

I believe this is no longer a small minority issue. I feel that we hams should set a good example and use our excellent tinkering and engineering ability to apply to solar and alternative electricity sources.

Let amateurs use solar power at the home QTH, at Field Day, and at outdoor fairs.

Let amateur publications show conscience and responsibility by running how-to articles on alternative energy. Let amateurs, through their global communications capabilities, exchange information on solar and other alternative electric power.

I hope you will take these ideas to heart for technical articles, parts source articles, and editorials. I am one ham who doesn't need "nukes," and I know there will be others.

**James G. Coote WB6AAM
Los Angeles CA**

CONVERTING

Perhaps this information will be of interest to those of you converting 40-channel CBs to 10 meters. I received a Hy-Gain model 2681 board, less channel switch (which includes rotary dial and knob). I found that Hy-Gain parts are available through Telex Communications, Inc., 8601 Northeast Highway 6, Lincoln NE 68505, Attn: Jim Kepustka.

The parts noted above are listed as: part #700047, switch, \$0.75; 40-ch dial, \$0.50; channel knob, \$0.50; shipping (very good box), \$1.00.

The board is sold by Poly Paks, and costs about \$12.00. They will supply a schematic diagram (specifically request it). Other info is supplied but it does not have much to do with the board received. It does give

info on another type of PLL which may or may not be used in another board they can furnish for more money. A complete Hy-Gain 40-channel set with all controls on the mike is available; the mike is an extra.

I haven't yet seen an SSB rig on sale through any of my contacts for less than \$65. One should be available soon, as the popularity of CB in the crowded cities is going down fast.

The big surprise is that the going price for a divider-type switch used with other rigs seems to be from \$16 to \$25. I get that from the CB repairmen, who say that they practically never have to replace them. Look at the price I paid for it (75 cents). When I figured out how to build a switch to divide by 278 or so, I thought \$20 was pretty fair.

Henry B. Plant W6DKZ
San Jose CA

CLASSICS

Being a Novice of about three months, I find my subscription to 73 thoroughly satisfying and enlightening in all aspects. It is very gratifying to have a publication on our behalf that pulls no punches and has its cards laid out on the table instead of putting up a smoke screen and being cloaked with the "official final authority" attitude approach. In your June issue (#225, page 13) Letters department, Don Hurley VE3HAN suggested an "equipment evaluation" booklet of rigs dating back over the past twenty years. Sounds like a great idea. Obviously an enormous amount of time and effort would need to be put into a big project on that order. Consider, though, how much value such a reference-type booklet like that could be... it would be ideal to bring along to that next hamfest for when you're rummaging

through those tables of used Hallicrafters, Hammarlunds, Johnsons, Nationals, etc. If an "equipment evaluation" booklet is not conceivable, then how about running a feature article in 73 on some of those more popular older classic rigs?

Speaking of so-called outdated gear, if you tune around the bands listening carefully, there are plenty out there sporting their well-maintained vintage equipment... just another facet of the art. I run those "oldies but goodies," a Viking Valiant I transmitter with a Hammarlund HQ-100 receiver. Keep up the superb work.

Bill Wolf KA2EEV
Newark NJ

FEARL

Any hams working in the military or for the military services as civilians should definitely bring their gear along on permanent changes of station to Japan. Write to FEARL, c/o Sam Fleming KA2SF, USAGH D10, APO SF 96343, or call 228-4703 (military number in Japan) for info. Licensing is done by US Forces, Japan. All US license classes get full privileges, except that no mobile portable operation is allowed (except MARS, where we have 2m frequencies and repeaters, etc.).

SFC W. J. Graham KA2WG
Signal Act-N
APO SF 96343

OLDIE

I would like to comment on your review concerning the Daiwa CN-720 swr and rf power meter (June, page 24). Your statement, "... why someone didn't think of it before..." left me bewildered.

On page 386 of the September, 1952, issue of DL-QTC—

yes, 1952—G. Blaeser DL1GX describes a standing-wave indicator which uses a cross-pointer instrument similar to the one used in the CN-720.

DL1GX's work was based on the work of a Mr. Buschbeck. Mr. Buschbeck's idea and invention was published in Volume 61, April, 1943, of *Hochfrequenztechnik und Elektroakustik*, "decimal classification DK 621.717; 621.396.61.

In the June issue of the *Technical Library* of the Northwest German Radio Network, 1949, Dr. Roland Walter describes this type of instrument again because, due to the war, most of the original material got lost or was destroyed.

Telefunken marketed a version for use on high-power BC and shortwave transmitters in the early 50s, with power handling capacities of up to 100 kW. It was called "supervisory equipment for feedlines for short, medium, and long waves." It became a standard on all major transmitting equipment in DL-land.

Ergo, the idea of the cross-pointer instrument in the context of swr measurements is about 36 years old.

Kurt U. Grey VE2UG
Sept Iles, Quebec

MISS AMERICA

This is to advise of the following station activity: Special Event—Miss America Pageant, Atlantic City, New Jersey. Station K2BR will be operating from the Miss America Pageant Headquarters in Atlantic City NJ, September first through eighth, 1979. It will be sponsored by the Southern Counties Amateur Radio Association (SCARA). Approximate frequencies: CW—3560, 7060, 14060, 21060; Novice—3730, 7130, 21130; Phone—3935, 7235, 14280, 21380. QSL to K2BR, 591

White Horse Pike, Egg Harbor NJ 08215 (SASE, please). Traffic to and from the Miss America contestants will be accepted.

Henry G. Rainville K2HG
Miss America Pageant/
SCARA coordinator
Ventnor NJ

HAMMARLUND

I have been trying hard to find a replacement variable tuning capacitor for my Hammarlund HQ-170A VHF receiver and finally found one at Pax Mfg., 100 Montauk Hwy., Linden Hurst NY 11757, (516)-884-4300.

In talking with Mr. Peter Kjeldsen of Pax Mfg., he indicated that they have most replacements for Hammarlund capacitors. Maybe this information will help someone else find parts.

Leroy Marion W8CGQ
Marlette MI

JAMMING

As printed in "Letters" of the June, 1979, issue of 73, reader K6EGM is "... appalled that you could publish something ("The 2-Meter ECM Caper," 73, February, 1979) tantamount to sanctioning the jamming of another station..." and says that such "new" ideas are not in the best interest of amateur radio.

Apparently K6EGM is not well versed in the history and romance of amateur radio. "Jamming," intentional, accidental, or fantasized, is not a "new" idea. It has been going on for over 50 years in every and any call area.

I suggest that K6EGM read "The Templeton Case" by K9ODE which appeared in the January, 1963, issue of QST magazine.

Byron H. Kretzman W2JTP
Huntington NY

New Products

from page 40

Company, PO Box 29243, Cumberland IN 46229. Reader Service number E40.

TRAC CMOS ELECTRONIC KEYS

TRAC Electronics, Inc., has introduced an addition to its line of state-of-the-art CMOS keyers. The TRAC CMOS Electronic Keyer, Model TE133, contains all CMOS integrated circuitry. Included features are self-completing dots and dashes; both dot and dash memory; iambic keying with any squeeze paddle; 5-50 wpm; speed, vol-



TRAC's Model TE133 keyer.

ume, tune, and weight controls; and built-in sidetone and speaker. Low-current-drain CMOS allows portable battery



Heath/Schlumberger's new catalog.

operation. The rear panel contains deluxe quarter-inch jacks for output and keying. The TE133 CMOS Electronic Keyer is operated on a single 9-volt battery and keys both positive and negative keyed rigs. For further information, contact TRAC Electronics, Inc., 1106 Rand Building, Buffalo NY 14203. Reader Service number T18.

HEATH/SCHLUMBERGER OFFERS LATEST INSTRUMENTS CATALOG

Heath/Schlumberger has announced the publication of its latest instruments catalog. This new catalog features Heath/Schlumberger's complete line of fully assembled and tested computers and peripherals and gives complete descriptions

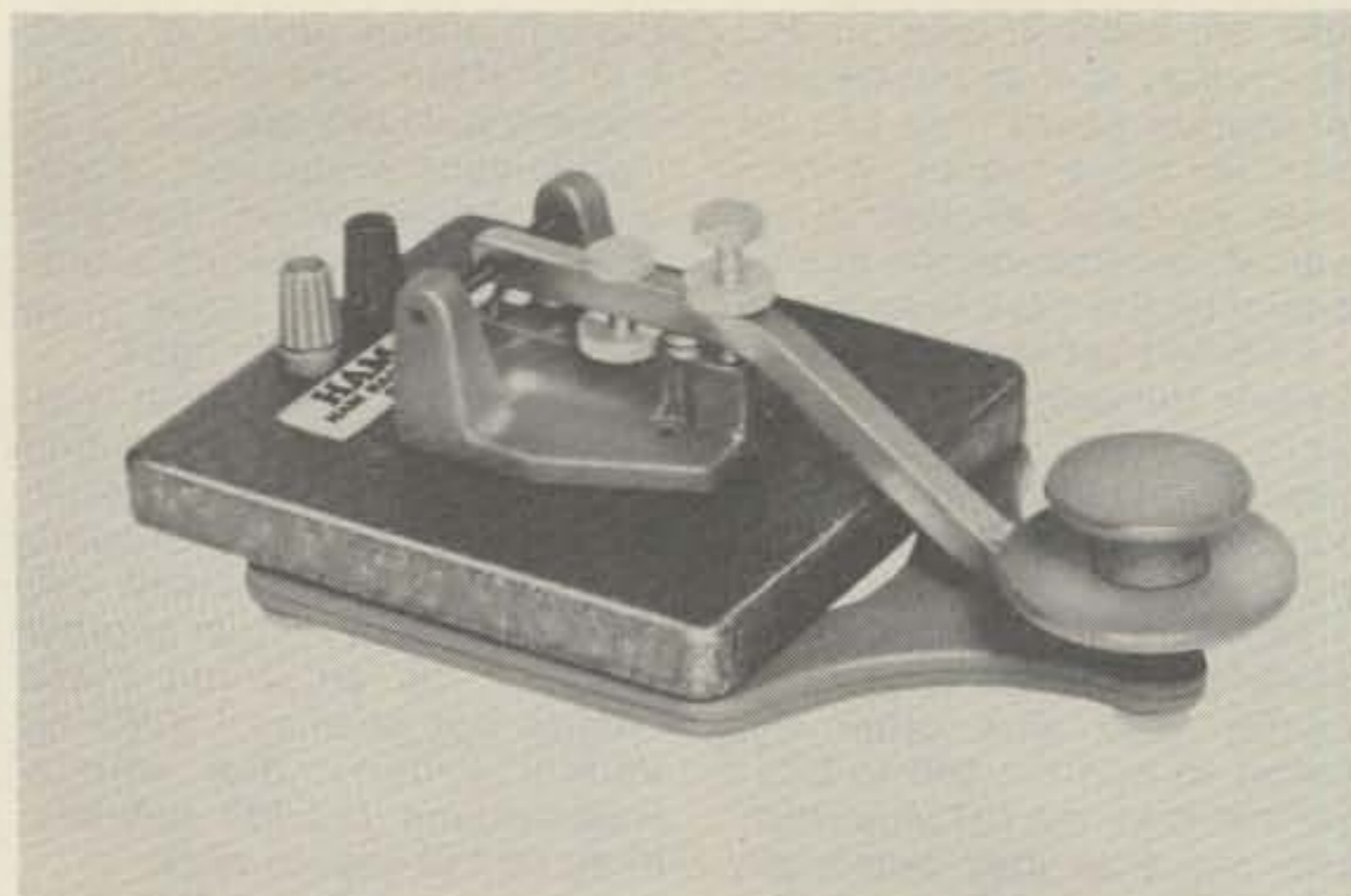

Ham Radio Center's HK-3M.

and specifications for their line of electronic test instruments. Included are oscilloscopes, laboratory-grade strip and X-Y recorders, power supplies, various signal and function generators, counters, and a full line of multimeters (from analog to digital).

In addition, the publication contains a complete listing of Heath/Schlumberger Continuing Education Programs for industrial training, including ac and dc electronics, semiconductor devices, digital techniques, microprocessors, and test instruments.

For further information, contact Heath/Schlumberger, Dept. 350-870, Benton Harbor MI

49022. Reader Service number H5.

THE HK-3M KEY

Ham Radio Center has introduced a new modified straight key which replaces their popular Model HK-3 Ham-Key™. The new model is the HK-3M; it features a new anti-tip bracket that defies even a pump-handle type of operator from tipping over. The beauty of this new feature is that any HK-3 now in the field can be converted to an HK-3M by merely adding the easily-installed AT-B bracket.

For further information, contact Ham Radio Center, PO Box 28271, St. Louis MO 63132. Reader Service number H2.

Ham Help

I would like a schematic and input/output impedance for an RME 80-10 preselector. The model is unknown, but I think it matched the RME 6900 receiver. Thanks.

William F. Mollenhauer N2FZ
Box 3, RFD 1
Glassboro NJ 08028

I would like to receive sche-

matics for any modifications to the Ten-Tec PM2/2A QRP rig.
H. Goldberg VE3JBU
PO Box 913, Stn. B
Ottawa, Ontario
Canada K1P 5P9

I would like to get in touch with amateurs who believe in UFOs, who have made a sighting or who are members of any organization that investigates UFOs. I would like to organize an international net.

Anastasios Panos SV1IG
PO Box 2563
Athens, Greece

I got a flood of replies to my request in the June issue. Thanks a lot, fellows! Instead of a brief visit in August, I have decided to come on the "HOUSA" student exchange/work scheme from November, 1979, to February, 1980. Under this scheme, NZ students can come to the US or Canada to work and sightsee.

Ideally, I would like to work

for short periods in various parts of the US, and would appreciate information on temporary jobs and accommodations.

I would also like to hear about UHF FM repeaters, as I intend bringing along my home-brew mobile rig (cheap, but good), based on our club design. Do UHF repeaters need the special access techniques, e.g., tone burst, etc., like your 2-meter ones?

Ash Nallawalla ZL4TBU
PO Box 6159
Dunedin, New Zealand

I have been following the articles on the conversion of CB sets to 10 meters and I have been trying to convert a SBE Sidebander II mobile rig, but have run into problems.

Does anyone have any information on the conversion of this unit? I did find the article on the SBE Sidebander III model (January, 1979, 73), which is strictly sideband (no AM) and am told that the boards are entirely different.

I have changed the base crystals up 1.535 MHz to put channel 1 on 28.500, but, after

complete alignment, which makes the set very hot on both receive and transmit, we find ourselves on a lower frequency than even 11 meters. Around 25.535.

James W. Barnes WB7PKR
PO Box 283
Mesa AZ 85201

I need a schematic or conversion info on an ARC R-19 aircraft receiver which tunes 118-148 MHz. Expenses will be reimbursed.

Howard S. Robb AF0W
Box 17
Bird Island MN 55310

I need a manual, or a copy, for a Gonset G-76 transceiver. I will pay costs.

Tim Rulon WA2KQD
12 Morahopa Rd.
Centerport NY 11721

I would like to get in touch with anyone who shares my interest in model railroading for a 40m CW sked on the Novice portion.

Rick Todd KA8AKL
14470 Basslake Rd.
Newbury OH 44065

RIPPED OFF!

If you have a serious problem with a ham firm, send them a letter with all the facts in detail, plainly and simply... and send a copy to Wayne Green W2NSD/1, c/o 73 MAGAZINE. 73 protects its readers more than any other magazine.

Social Events

Listings in this column are provided free of charge on a space-available basis. The following information should be included in every announcement: sponsor, event, date, time, place, city, state, admission charge (if any), features, talk-in frequencies, and the name of whom to contact for further information. Announcements must be received two months prior to the month in which the event takes place.

GEORGETOWN IL SEP 1-2

The 1979 Danville, Illinois, Area Hamfest will be held on September 1-2, 1979, at the Georgetown, Illinois, fairgrounds, located ten miles south of Danville on Illinois Rt. 1. Gates open at noon on Saturday for vendors to start setting up their displays. Gates open to the general public at 6:00 am Sunday. Facilities will consist of a large enclosed building 50 x 150 feet with electrical hookups available at no charge. Please bring your own tables and chairs and power cords. Outside space is also

available at a \$2.00 per person gate charge. Overnight camping on the fairgrounds is available at \$5.00 per vehicle. For information, contact Bob Wilson K9RBW, c/o Illiana Repeater Systems, Inc., PO Box "G", Catlin IL 61817.

TEXAS CITY TX SEPT 1-2

The Tideland Amateur Radio Society (TARS) will hold its Hamfest '79 on September 1-2, 1979, at the Nestler Civic Center on 5th Street, Texas City, Texas. The registration and hospitality period will be held on Saturday evening, with the final prize drawing to be held on Sunday afternoon. There will be many small prizes, plus TARS will be giving away the winner's choice of a Kenwood TS-120S or Drake UV-3, a Wilson Mark II HT, and a Wilson System III beam. For further information and pre-registration, write Hamfest '79, PO Box 73, Texas City TX 77590.

PENSACOLA FL SEP 2

The Five Flags Amateur

Radio Association, Inc., will hold its 1979 Ham-A-Rama on September 2, 1979, at the Pensacola Municipal Auditorium, Pensacola, Florida.

ROSEMONT IL SEP 7-9

The Quarter Century Wireless Association will hold its 1979 Chicago Convention on September 7-9, 1979, at the O'Hare/Kennedy Holiday Inn, Rosemont, Illinois. The complete package for the three days is \$35.00. Special room rates will also be available. There will be the annual banquet, special ladies' program, various tours, and prizes. For reservations and information, write Phil Haller W9HPG, 6000 S. Tripp, Chicago IL 60629.

BLOOMINGTON IN SEP 8

The second annual Hoosier Backyard Hamfest will be held on September 8, 1979, at the Hensonberg School, just east of the intersection of state highway 37 and Vernal Pike, in Bloomington, Indiana. Tickets are \$1.00 per head over age 12. Features of the event will include ATV, an ATV repeater, SSTV demonstrations, a home-computer show, inside swap area, plenty of parking, food, and some door prizes. Talk-in

on 147.70/10. Send all inquiries to HBYH, 7391 W. Hwy. 46, Ellettsville IN 47429.

AUGUSTA NJ SEP 8

The Sussex County Amateur Radio Club will hold its hamfest on Saturday, September 8, 1979, from 9:00 am to 5:00 pm, rain or shine, at Sussex County Farm and Horse Show grounds, off Rte. 206, Augusta, New Jersey. There will be a large indoor selling area and tailgating. Admission for buyers is \$1.00, which includes a chance at the door prizes. YLs, XYLs, and harmonics will be admitted free. Admission for indoor sellers is \$6.00 at the door and \$5.00 in advance. For tailgaters, admission is \$5.00 at the door and \$4.00 in advance. Talk-in on 147.90/30 and 146.52. For registration and information, write Sussex County Amateur Radio Club, PO Box 11, Newton NJ 07860, or call Ed Woznicki AC2A at (201)-852-3268.

UNIONTOWN PA SEP 8

The Uniontown Amateur Radio Club will hold its 30th annual Pie Gabfest on September 8, 1979, starting at noon at the club grounds, Old Pittsburgh Rd., at the bypass on Rte. 51.

DEALER DIRECTORY

Tell them you saw their name in 73

Fontana CA

We carry the following: ICOM, Midland, Amcom, DenTron, KLM, Swan, Drake, Ten-Tec, Wilson, SST, MFJ, Hy-Gain, Lunar, Nye-Viking, B&W, Redi-kilowatt, CushCraft, Mosley, Big Signal, Pipo, etc. Full Service Store **Fontana Electronics, 8628 Sierra Ave., Fontana CA 92335, 822-7710.**

Santa Clara CA

Bay area's newest Amateur Radio store. New & used Amateur Radio sales & service. We feature Kenwood, ICOM, Wilson, Yaesu, Atlas, Ten-Tec & many more. **Shaver Radio, 3550 Lochinvar Avenue, Santa Clara CA 95051, 247-4220.**

Denver CO

Experimenter's paradise! Electronic and mechanical components for computer people, audio people, hams, robot builders, experimenters. Open six days a week. **Gateway Electronics Corp., 2839 W. 44th Ave., Denver CO 80211, 458-5444.**

Columbus GA

KENWOOD—YAESU—DRAKE

The world's most fantastic amateur showroom! You gotta see it to believe it! **Radio Wholesale, 2012 Auburn Avenue, Columbus GA 31906, 561-7000.**

Preston ID

Ross WB7BYZ, has the Largest Stock of Amateur Gear in the Intermountain West and the Best Prices. Call me for all your ham needs. **Ross Distributing, 78 So. State, Preston ID 83263, 852-0830.**

Terre Haute IN

Your ham headquarters located in the heart of the midwest. **Hoosier Electronics, Inc., 43B Meadows Shopping Center, P.O. Box 2001, Terre Haute IN 47802, 238-1456.**

Littleton MA

The ham store of N.E. you can rely on. Kenwood, ICOM, Wilson, Yaesu, DenTron, KLM amps, B&W switches & wattmeters, Whistler radar detectors, Bearcat, Regency, antennas by Larsen, Wilson, Hustler, GAM. **TEL-COM Inc. Communications & Electronics, 675 Great Rd., Rt. 119, Littleton MA 01460, 486-3040.**

Laurel MD

We stock Drake, Icom, Ten-Tec, Swan, Tempo, Dentron, DSI, KDK, Wilson, Midland and others. Call toll free 800-638-4486. **The Comm Center, Inc., Laurel Plaza, Rte. 198, Laurel MD 20810.**

St. Louis MO

Experimenter's paradise! Electronic and mechanical components for computer people, audio people, hams, robot builders, experimenters. Open six days a week. **Gateway Electronics Corp., 8123-25 Page Blvd., St. Louis MO 63130, 427-6116.**

Camden NJ

X-Band (& other frequencies) Microwave Components & Equipment. Laboratory Grade Test Instruments, Power Supplies, 1000's in stock at all times, BUY & SELL all popular makes—HP, GR, FXR, ESI, Sorensen, Singer, etc. **Lectronic Research Labs, 1423 Ferry Ave., Camden NJ 08104, 541-4200.**

North Arlington NJ

Collins, General Radio, Tektronix, Hewlett Packard. Radio sales/service. Cash or trade for tubes or gear. **Ted W2KUW, DCO, INC., 10 Schuyler Avenue, No. Arlington NJ 07032 998-4246.**

Syracuse—Central NY

We deal, we trade, we discount, we please! Yaesu, Ten-Tec, Cushcraft, Drake, Dentron, KLM, Midland, B&W, ICOM, Hygain, Swan, Amcom, Telco, Mirage, DSI etc. Complete 2-way service shop! **Ham-Bone Radio (Div. Stereo Repair Shop) 3206 Erie Blvd. East, Syracuse NY 13214, 446-2266.**

Syracuse-Rome-Utica NY

Featuring: Yaesu, ICOM, Drake, Atlas, DenTron, Ten-Tec, Swan, Tempo, KLM, Hy-Gain, Mosley, Wilson, Larsen, Midland Southwest Technical Products. You won't be disappointed with equipment/service. **Radio World, Oneida County Airport-Terminal Building, Oriskany NY 13424, 337-2622.**

Scranton PA

ICOM, Bird, CushCraft, VHF Engineering, Antenna Specialists, Barker & Williamson, CDE Rotators, Ham-Keys, Belden, W2AU/W2VS, Shure, Regency, CES Touch-Tone pads, Radio Amateur Callbooks. **LaRue Electronics, 1112 Grandview St., Scranton PA 18509, 343-2124.**

Houston TX

Experimenter's paradise! Electronic and mechanical components for computer people, audio people, hams, robot builders, experimenters. Open six days a week. **Gateway Electronics Inc., 8932 Clarkcrest, Houston TX 77063, 978-6575.**

Port Angeles WA

Mobile RFI shielding for elimination of ignition and alternator noises. Bonding straps. Components for "do-it-yourself" projects. Plenty of free advice. **Estes Engineering, 930 Marine Drive, Port Angeles WA 98362, 457-0904.**

DEALERS

Your company name and message can contain up to 25 words for as little as \$150 yearly (prepaid), or \$15 per month (prepaid quarterly). No mention of mail-order business or area code permitted. Directory text and payment must reach us 45 days in advance of publication. For example, advertising for the November issue must be in our hands by September 15th. Mail to 73 Magazine, Peterborough NH 03458. ATTN: Aline Coutu.

Uniontown, Pennsylvania. Registration is \$2.00, with a chance for a main prize of a Tempo S-1. There will also be a Swap 'n Shop.

**MENA AR
SEP 8-9**

The QWHC is celebrating the 10th anniversary of the Queen Wilhelmina Hamfest on September 8 and 9, 1979, at the Queen Wilhelmina State Park lodge, atop Rich Mountain just north of Mena, Arkansas. Featured will be displays, a free flea market, a banquet, a live band, church services, activities for XYLs and harmonics, and much, much more. There will be a grand prize of a Yaesu FT-101ZD, and many more prizes. Look for WB5MFI/P5 operating from the lodge. Admission is \$2.00. Tickets for the grand prize are \$2.00 each or 3 for \$5.00. Talk-in on 3995, 146.19/.79, and 146.52. For additional information, contact Steve Myers WB5MFI, SS103 Carlson Terrace, Fayetteville AR 72701, or phone (501)-443-3489.

**MONTGOMERY AL
SEP 8-9**

The 2nd annual Central Alabama Hamfest is scheduled for September 8-9, 1979, at the

Montgomery Civic Center, 300 Bibb St., Montgomery, Alabama. The FCC will administer exams beginning at 8:00 am on Saturday, September 8. Bring your Form 610. All activities will be indoors in air-conditioned comfort. There will be prizes and a ladies' program. Talk-in on 146.04/146.64. For more information, contact Ed Sensintaffar WA4NKU, 745 Dubuque Dr., Montgomery AL 36109 or Sam Windham WB4RGX, 1834 Shoreham Dr., Montgomery AL 36106.

**FINDLAY OH
SEP 9**

The Findlay Radio Club will hold its 37th annual Findlay Hamfest on Sunday, September 9, 1979, at Riverside Park, Findlay, Ohio. There will be both commercial and amateur display space available. Ticket donation is \$1.50 in advance and \$2.00 at the hamfest site. For more information, write the Findlay Radio Club, c/o Randy Peterson, Hamfest Chairman, 6016 Marion Twp. 243, Findlay OH 45840.

**BUTLER PA
SEP 9**

The Butler County Amateur Radio Association, Inc., will

hold "Ye Olde Fashioned Hamfest" on September 9, 1979, from 10:00 am to 4:00 pm at the Butler County Farm Show Grounds adjacent to Roe Airport on Rte. 68, west of Butler, Pennsylvania. The \$1.00 charge includes free parking and admission to the outside flea market. Children under 12 are admitted free. Overnight campers are welcome. Tables for the indoor flea market are \$3.00 for an 8-foot table provided by us, or \$2.00 for an 8-foot table provided by you. Food and refreshments will be available. Mobile check-ins on .52 and 147.90/.30 (W3UDX). Fly-ins welcome (80 + 100 aviation gas will be available). YL, mobile, and fly-in prizes will be awarded. There will be six main prizes plus other prizes to be drawn every 15 minutes. For more information, contact Fred Young WB3HGC, 195 Robbie Way, Portersville PA 16051, or phone (412)-368-3386.

**PECATONICA IL
SEP 9**

The Rockford Amateur Radio Association will hold its second annual Rockford Hamfest and Illinois State ARRL Convention on Sunday, September 9, 1979, at the exhibition hall at the Winnebago County Fairgrounds at Pecatonica, Illinois, just west of Rockford on US Rte. 20. Tickets are \$2.00 in advance or \$2.50 at the gate. Tickets are available by mail by writing RARA, PO Box 1744, Rockford, Illinois 61110. Please include a SASE for tickets by mail. Prizes include a Kenwood TS-520S transceiver and an Atlas receiver. Campsites are available on site, with electric and sanitary hookup available. There are 300 flea-market tables available at a nominal charge. Plenty of free parking is available. Featured will be speakers, forums, demonstrations, and discussions. A hamfest menu, including hot dogs, BBQ, and soft drinks will be available at reasonable prices. Talk-in on 146.01/.61 or 146.52.

**PENNSAUKEN NJ
SEP 9**

The South Jersey Radio Association will hold its hamfest on September 9, 1979, at Pennsauken Senior High School, Hylton Rd. at Rtes. 3, 130, and 70. Admission is \$2.00, tailgating is \$3.00, and an inside table is \$5.00. For further information, contact Bruce Eichmann WA2NBM, Hamfest Chairman, 204 E. Lake Blvd., Marlton NJ 08053, or phone (609)-983-0106.

**VALPARAISO IN
SEP 9**

The Porter County Amateur

Radio Club will hold its annual hamfest on September 9, 1979, at the Porter County Fairgrounds, Valparaiso, Indiana. Featured will be a flea market, prizes, and technical sessions. Admission is \$2.00. There will be no charge for a flea market space but do bring your own tables. Talk-in on 147.96/.36 and 146.52. For advance tickets and information, write Art Cushman N9FB, 944 N. 100 W., Valparaiso IN 46383.

**HUDSONVILLE MI
SEP 15**

The Grand Rapids Amateur Radio Association, Inc., will hold its annual Swap 'n Shop on Saturday, September 15, 1979, at the Hudsonville Fairgrounds, Hudsonville, Michigan. Gates open at 6:00 am; sales begin at 8:00 am. Talk-in on .16/.76, .63/.03, and .52/.52.

**PEORIA IL
SEP 15-16**

The 21st annual Peoria Superfest 1979 will be held on September 15-16, 1979, at Exposition Gardens, W. Northmoor Rd., Peoria, Illinois. Advance tickets are \$2.00. Door tickets are \$3.00. Camping will be available Friday night on the grounds. There will be free indoor and outdoor flea market space available. Tickets will be sold on the grounds for hourly prize drawings. Main prize drawing will be at 3:00 pm both days. Continuous demonstrations of the latest equipment and technology will be given by major manufacturers and dealers. All dealers, distributors, and manufacturers write or call for info on free commercial table space. There will be movies, forums, talks, and displays of interest to all given daily. For the ladies: There will be a free bus trip to the Northwoods Mall on Sunday at 12:00 noon, plus daily displays and demonstrations and also a ladies' flea market. An informal get-together will be held at the Heritage House smorgasbord, 8209 N. Mt. Hawley Rd., (Rte. 88) at 7:30 pm Saturday, September 15th. No reservations are necessary. Price will be approximately \$5.75 per person. Talk-in on 146.76 W9UVI and .76, .85, and .97. For advance tickets, write Peoria Hamfest, 5808 N. Andover Ct., Peoria IL 61614, or phone (309)-692-8763.

**ROSS OH
SEP 16**

The Greater Cincinnati Amateur Radio Association, Inc., will hold its 43rd annual Cincinnati Hamfest on Sunday, September 16, 1979, at Strickers Grove on Ohio Rte. 128, one mile west of Ross (Venice), Ohio. Exhibits, prizes, food, and refreshments will be available.

TELREX "Tri-Band" — \$415.00

ELECTRICAL	TB5EM
Gain in DB reference 1/2 wave dipole	8.5 dbd
Front to back ratio	28 db
V/S/W/R at resonant point	1.3/1
Maximum Power Input	4 KWP
Nominal Input Impedence	52 ohm
Beamwidth to 1/2 power Input	60° 3 bands
Frequency range	10, 15, 20
Side Nulls	35 db
MECHANICAL	
Number of Elements	Five
Alum. Boom: Dia. & Lgth. approx.	2.25"x18 ft.
Turning Radius approx.	20 ft.
Wind Load at 100 mph (approx.)	210 lbs.
Wind Area	7 sq. ft.
Longest Element	36 ft.
Net Weight (approx.)	49 lbs.
Shipping weight (domestic pack)	60 lbs.
Length of shipping carton	13 ft.

MADISON ✓M35
ELECTRONICS SUPPLY, INC.

1508 McKINNEY • HOUSTON, TEXAS 77002
713/658-0268

W5GJ, W5MBB, K5AAD, N5JJ, AG5K, W5VVM, W5EGP, WA5TGU, WB5AYF, K5BGB.

MASTERCHARGE • VISA

DLA!

Featured will be a flea market with radio-related products only, music and good fellowship, a hidden transmitter hunt, and a sensational air show. Admission and registration are \$4.00. For further information, write Lillian Abbott K8CKI, 1424 Main St., Cincinnati OH 45210.

**MT. CLEMENS MI
SEP 16**

The L'Anse Creuse Amateur Radio Club will hold its 7th annual Swap and Shop on September 16, 1979, at the L'Anse Creuse High School, Mt. Clemens, Michigan. Take I-94 eastbound to the Metro Parkway exit. Then take the Metro Parkway to Crocker. Go left on Crocker to Reimold and then right on Reimold to the last school, L'Anse Creuse High School. Admission is \$2.00 at the door, or \$1.00 in advance. There will be plenty of food and parking plus hourly prize drawings. Prizes include a first prize of \$200.00, a second prize of \$100.00, and a third prize of \$50.00. Talk-in on 147.69/.09 and 146.52. For more information, send an SASE to WD8ITS, 3488 Ashley, Pontiac MI 48055.

**HARRISBURG PA
SEP 16**

The Central Pennsylvania Repeater Association, Inc., will hold its 6th annual High Rise Hamfest on Sunday, September 16, 1979, from 8:00 am until 3:00 pm at the Park and Shop Garage, 200 block of Walnut Street, Harrisburg, Pennsylvania. Admission is \$3.00, with tailgating, wives, and kids free of charge. There will also be door prizes.

**QUEENS NY
SEP 16**

The Hall of Science Amateur Radio Club, Inc., will hold its 2nd annual indoor/outdoor, rain or shine electronics hamfest on September 16, 1979, from 9:00 am to 4:00 pm at the municipal parking lot, one block off Queens Blvd. at 80-25 126th St., Queens, New York. There will be free parking, refreshments, and free prizes. Admission is \$2.00 for sellers and \$1.00 for buyers. Talk-in on .52/.52 and .96/.36.

**WHITESTONE NY
SEP 20**

The Tu-Boro Radio Club will hold its auction on Thursday, September 20, 1979, from 6:00 pm to 10:00 pm at the Odd Fellows Hall, 149-14 14th Avenue, Whitestone, New York. Donation is \$1.00. Talk-in on 145.62 and 146.52.

**ELMIRA NY
SEP 22**

The Elmira Amateur Radio Association will hold its fourth

annual International Hamfest on September 22, 1979, from 8:00 am to 5:00 pm at the Chemung County Fairgrounds, Elmira, New York. There will be prizes, programs, a free flea market, and dealers' and manufacturers' displays. Talk-in on .52, .96/.36, and .10/.70. For more information, contact John Breese WA2FJM, 340 West Avenue, Horseheads NY 14845.

**ADRIAN MI
SEP 23**

The Adrian Amateur Radio Club will hold its 7th annual hamfest on Sunday, September 23, 1979, at Lenawee County Fairgrounds, Adrian, Michigan. Featured will be prizes, games, and programs. Tables are available at \$5.00 per 8 ft. space, \$3.00 per 4 ft. space, \$1.00 per 8 ft. trunk space, and \$2.00 for an inside space. Talk-in on 146.31/.91 and 146.52. For ticket and table information, write Adrian Amateur Radio Club, Inc., PO Box 26, Adrian MI 49221, or call Bob or Sally Fay of Sword Enterprises at (517)-263-3597.

**FLINT MI
SEP 23**

The Genesee County Radio Club, along with the Bay Area Radio Club, the Lapeer County

Radio Club, the Saginaw Valley, and the Shiawassee County Radio Club, will hold their 2nd annual 5-County Swap 'n Shop on September 23, 1979, from 7:30 am to 4:00 pm at Southwestern High School, Flint, Michigan. Take I-69 to the Hammerberg Rd. exit, turn south to 12th St., then left on 12th to the high school. Admission is \$2.00 for adults, with children under 12 free. There will be refreshments, prizes, and fun for all. Talk-in on 146.52, 147.27, and 146.91. For information, contact Don Williams WD8QPM, 5114 Knapp Dr., Flint MI 48506.

**BEREA OH
SEP 23**

The fourth annual Cleveland Hamfest will be held on Sunday, September 23, 1979, at the Cuyahoga County Fairgrounds, Berea, Ohio. The hamfest will be an all-indoor operation. There will be 10-foot booths available with an 8-foot table and two chairs for \$30.00.

**GAINESVILLE GA
SEP 23**

The Lanierland Amateur Radio Club will hold its sixth annual Hamnic at the Lake Lanier Islands Dogwood Pavilion on September 23, 1979. There will be two large covered pavilions

and a large parking area for the swap shop and exhibits. Food will be available. There will be no entry fee for Hamnic; however, Lanier Islands charges a \$2.00 entry fee per car. There will be picnicking, hiking, and swimming available for the kids. Trailer hookups and camping are also available on site. First prize will be a KDK FM2015R; there will be many other prizes. Talk-in on W4IKR .07/.67. For further information, write Bob Cochran W4DNX, 607 East Lake Drive, Gainesville GA 30501.

**BOULDER CO
SEP 23**

The Boulder Amateur Radio Club will hold Barcfest '79, on September 23, 1979, beginning at 9:00 am at the Boulder National Guard Armory, North Broadway, at the city limits, Boulder, Colorado. There will be an auction and a snack bar. Admission is \$2.00 which includes a door prize drawing. Talk-in on 146.10/.70 and .52/.52. For further information, contact Mark Call N0MC, 4297 Redwood Ct., Boulder CO 80301, or phone (303)-442-2616.

**SUTTON NH
SEP 23**

The Connecticut Valley FM



IT'S HERE!!

**THE
AMCODER**

4" x 2 3/8" x 6"

A NEW ERA IN CW REGENERATION

- Select any CW signal that's 40 hz away from any other (Tune—400 to 1500 hz)
- Lock and switch to "auto" and you have tape quality audio. One and one only signal reception.
- Only 20 mv of audio above receiver noise required for acquisition.
- A 40 db over S9 signal, 50 hz away cannot come through.
- Reduce operator fatigue by not listening to any other band and/or signal noise except the one you want to work.
- Variable acquisition frequency—400 to 1500 hz.
- Variable output tone frequency—100 to 2000 hz.
- Variable output audio level (drives ear-phones or station speaker).

Kit includes all parts including cabinet, power supply and complete instructions. Epoxy glass boards, plated and pre-drilled.

Available—Factory wired and tested with 1 year warranty on parts and workmanship.

Kit—\$69.95 FWT—\$89.95

VISA and Master Charge Accepted.

AMC ENGINEERING ✓ A106
P. O. Box 427, Jessup, MD 20794

CTU Dozen

Buy 12—get 2 free (mix or match)

EXACT Replacements for

SYLVANIA 

ECG Transistor-Diodes-ICs

ECG#	ECG#	ECG#	ECG#
100 .94	163 5.95	220 1.72	289 .88
101 .98	164 5.75	221 1.90	290 .96
102 .96	165 6.95	222 1.99	291 1.99
102A .98	171 1.37	223 2.79	292 2.26
103 1.05	172A .72	224 5.08	293 1.08
103A 1.11	175 1.62	225 4.34	294 1.14
104 1.06	176 2.06	226 1.67	295 2.02
105 2.27	177 .49	228 1.38	297 1.13
106 .80	179 5.69	229 1.06	298 1.13
107 .79	180 5.88	230 3.80	299 2.02
108 .89	181 4.65	231 3.96	300 2.02
121 2.15	182 3.35	232 .70	302 2.80
123 .69	183 3.63	233 .74	306 2.80
123A .79	184 1.37	234 .72	307 2.57
124 1.53	185 1.70	235 2.45	308 7.65
126 1.16	186A 1.46	236 5.75	309K 3.27
127 4.60	187A 1.46	237 5.07	310 7.65
128 1.37	188 1.59	238 7.95	311 2.13
129 1.56	189 1.59	239 3.02	312 1.13
130 1.95	190 1.85	241 1.71	313 1.00
131 1.98	191 2.07	242 1.90	314 7.85
132 1.01	192 .98	276 8.72	315 2.01
133 1.14	193 1.04	278 2.36	316 2.74
152 1.43	194 .82	279 5.85	317 24.20
153 1.85	195A 2.57	280 5.06	318 20.60
154 1.85	196 1.98	281 6.35	319 1.11
155 2.02	197 1.89	282 4.24	320 26.00
157 1.43	198 1.89	283 6.32	321 7.65
158 1.08	199 .59	284 7.35	322 1.80
159 .86	210 1.37	285 7.99	323 3.53
160 1.43	211 1.56	286 5.75	324 3.53
161 .98	218 3.08	287 .69	325 27.50
162 5.75	219 4.36	288 .74	326 .96

- Above only partial listing—please inquire
- R-U-S-H, All Orders Shipped Same Day Received
- FREE Freight on \$20.00 & up prepaid orders
- All others—\$150 freight charge
- 1979 Accessory Catalogues in stock—send \$3.00
- Longer Hours Mon-Sat 9a-10p, Sun 1-7p
- Call or write today—to place your order (518)465-3367

Communications & T.V. Unlimited
Dept 73, 17 Washington St., Rensselaer, N.Y. 12144

DISTRIBUTOR INQUIRIES INVITED
T.V.-C.B.-AMATEUR RADIO-STEREO-MONITORS-
ELECTRONIC PARTS ✓ C105

Association will hold its hamfest on September 23, 1979, from 9:00 to 5:00 pm at King Ridge ski area, Exit 11 off I-89, Sutton, New Hampshire. Admission at the gate is \$2.00 per person over 16. Advance admission is \$1.50. Send to C. A. Breuning, 54 Myrtle Street, Newport NH 03773. Festivities include an indoor/outdoor flea market, a florist exhibit, a frisbee toss, a horseshoe competition, dealers' exhibits, food, overnight camping available for self-contained units only, and a consignment room. Door prizes will be awarded, including a grand prize of a handheld, portable synthesized 2-meter rig, plus a raffle of a 19" color television at 5:00 pm. Talk-in on .52/.52 and .16/.76.

**ERIE PA
SEP 23**

The Radio Association of Erie, Inc., will hold its annual Ham Jam '79 on September 23, 1979, between the hours of 8:00 am and 4:00 pm at Rainbow Gardens, Waldemeer Beach Park, at the head of Presque Isle Bay, Erie, Pennsylvania. Tables can be reserved on a first-come, first-served basis, at a cost of \$5.00 per table. There will be plenty of free parking and lots of indoor display area. Admission is \$3.00 at the gate and includes a door-prize ticket, a YL ticket, a main-prize ticket, and a free coffee. Commercial displays will also be available. There will be a \$1.00 charge per car for display space in the flea market area. Refreshments will be served on the premises. Talk-in on 146.34/.94, 146.34 simplex, and 7,250 kHz. For additional information or advanced tickets, send an SASE to Ham Jam '79, c/o the Radio Association of Erie, PO Box 844, Erie PA 16512.

**LOUISVILLE KY
SEPT 29-30**

The ninth annual Greater Louisville Hamfest and Kentucky State ARRL Convention will be held on September 29-30, 1979, at the West Hall of the Kentucky Fair and Exposition Center in Louisville, Kentucky. Follow QSY signs off either I-65 or I-264. There will be a gigantic indoor air-conditioned exhibitors' area and flea market plus meetings, forums, and ladies' program. FCC exams will be given on Saturday with a banquet on Saturday night. Admission is \$3.00 in advance, \$3.50 at the door, and \$9.75 for the banquet. Exhibitors and flea market vendors should write for a special information sheet. For other information, contact the Greater Louisville Hamfest, PO Box 34444, Louisville KY 40232, or phone (502)-634-0619.

**WARNER ROBINS GA
SEP 30**

Central Georgia ARC's first annual hamfest will be held on September 30, 1979, from 8:00 am to 5:00 pm at the City Recreation Center, on Watson Boulevard, Warner Robins, Georgia. Dealers and flea market will be indoors. The Georgia Single Side Band Association and Georgia CW Association both plan their annual meetings with us. Talk-in on 3,975 LSB and 146.25/.85 and 146.52. For more information, call or write Bill Atkins WD4ASB, 201 Avalon Drive, Warner Robins GA 31093, or phone (912)-923-3454.

**GAITHERSBURG MD
SEP 30**

The Foundation for Amateur Radio will hold its annual hamfest at the Gaithersburg Fairgrounds, Gaithersburg MD, on Sunday, September 30, 1979, rain or shine. Featured are a large flea market, food service, exhibits, ladies' events, a supervised children's program, and many prizes. The main events are all indoors. Picnic grounds and free parking are available. Participation fee is \$2.00, sales space for flea market is \$6.00, and for tailgate, \$5.00 (spaces available on a first-come basis). Commercial exhibitors' spaces are \$15.00 with pre-registration required. Talk-in service provided and nearby motel rooms available. For information, write or call Ron Levin W3GBU, 802 Greenview Court, Reisterstown MD 21136, or telephone (301)-833-1816.

**BLACKSBURG VA
OCT 1-6**

Two expanded workshops on 8080/8085/Z80 microcomputer design, microcomputer interfacing, software design, and digital electronics are being given by the editors of the popular Blacksburg books. Participants have the option of retaining the equipment used in these courses. Dates are October 1-6, 1979. For more information, contact Dr. Linda Lefel, C.E.C., VPI and SU, Blacksburg VA 24061 or phone (703)-961-5241.

**SIoux FALLS SD
OCT 5-7**

The '79 ARRL Dakota Division Convention will be held from October 5-7, 1979, at the Sioux Falls Airport Ramada Inn, located off Exit 81 on I-29, Sioux Falls, South Dakota. Featured will be technical and operating forums, a ladies' program, an ARRL forum, a large exhibit area, and a banquet. Prizes include an advance-registration prize of a DenTron GLA-1000 amplifier, a grand prize of a Kenwood TS-820S and a second

grand prize of a Wilson System One™ antenna and WR-500 rotor. Registration is \$15.00 (\$16.00 after September 1) or \$6.00 for the convention only (\$7.00 after September 1). Talk-in on 146.16/.76. For further information and convention-rate hotel accommodations, write Sioux Falls Amateur Radio Club, Box 91, Sioux Falls SD 57101.

**HOUSTON TX
OCT 5-7**

The Houston Area Amateurs will host the ARRL West Gulf Division Convention on October 5-7, 1979, in Houston, Texas. For further information, contact Houston Ham Conventions, Inc., PO Box 79252, Houston TX 77024, or phone (713)-466-0518 or (713)-223-3161.

**WARRINGTON PA
OCT 6**

The Mt. Airy VHF Radio Club Inc., will hold its Hamarama '79 and Mid-Atlantic States VHF Conference on Saturday and Sunday, October 6-7, 1979. The conference will be held on Saturday, October 6, from 9:00 am to 5:00 pm at the Warrington Motor Lodge, Rte. 611, Warrington, Pennsylvania. Featured will be an all-day VHF program, a cocktail hour and get together, and a buffet dinner. Registration is \$3.00 in advance, or \$4.00 at the door, which includes the flea market. The buffet dinner is \$9.00. The flea market will be held on Sunday, October 7, from 8:00 am to 4:00 pm, rain or shine, at the Bucks County Drive-In Theatre, also on Rte. 611. Registration is \$2.00 with tailgating \$2.00 per space (bring your own table). Featured will be amateur radio equipment, electronic parts, surplus, and door prizes. Talk-in on 146.52 W3CCX. For information, write Ron Whitsee WA3AXV, Chairman, PO Box 353, Southampton PA 18966, or phone (215)-355-5730.

**CORNWALL NY
OCT 6**

The Orange County Amateur Radio Club will hold its annual auction on Saturday, October 6, 1979, at Munger Cottage, Cornwall, New York. Admission is \$1.00 and includes a chance on a door prize. The auction begins at 1:00 pm and sellers should arrive at noon. Talk-in on .52. For further information, contact Bill Lazzaro N2CF, 11 Jefferson St., Highland Mills NY 10930.

**ROME GA
OCT 7**

The Northwest Georgia Amateur Radio Club will hold its annual Rome Hamfest on October 7, 1979, at the Coosa Valley Fairgrounds, Rome, Georgia. Gates will open at 9:00 am.

Talk-in on 146.34/.94 and 146.085/.685. For further information, contact WB4AEG, Box 274, Adairsville GA 30103.

**ROCK HILL SC
OCT 7**

The York County Amateur Radio Society will hold its 28th annual hamfest on Sunday, October 7, 1979, starting at 8:00 am, at Joslin Park, Rock Hill, South Carolina. Registration is \$2.75 each, or 2 for \$5.00 in advance, or \$3.00 at the gate. The main prize is a Yaesu FT-901DM. A barbecue dinner is available at the park. Talk-in on 146.43/147.03 and 146.52. For more information, write York County Amateur Radio Society, Inc., PO Box 4141 CRS, Rock Hill SC 29730.

**BERRIEN SPRINGS MI
OCT 7**

The Blossomland Amateur Radio Association will hold its fall Swap Shop on Sunday, October 7, 1979, at the Berrien County Youth Fairgrounds, north of Berrien Springs, Michigan, on US 31, beginning at 8:00 am. There will be commercial exhibits, prizes, refreshments, plenty of free parking, and display space. Space for self-contained campers, at \$3.50 including electricity, is on the grounds. Talk-in on 146.22/.82. Advance tickets are \$1.50; \$2.00 at the gate. Eight-foot tables are \$2.00 and are restricted to electronic items. For advance tickets and information, write Charles White, 1940 Union Ave., Benton Harbor MI 49022.

**TAYLOR MI
OCT 7**

The 3rd annual Radio and Electronic Equipment Swap & Shop will be held on Sunday, October 7, 1979, from 9:00 am until 3:00 pm, at Kennedy High School, Taylor, Michigan. Admission is \$2.00. Featured will be door prizes and food. Talk-in on .93/.33, .52/.52, and .99/.39. For information, write RADAR, Inc., PO Box 1023, Southgate MI 48195.

**OTTAWA ONT CAN
OCT 12-14**

The Radio Society of Ontario will hold its 11th annual convention at the Skyline Hotel, Ottawa, Ontario, Canada. On Friday evening, there will be a buffet and dance. On Saturday, there will be demonstrations, forums, technical sessions, a women's program, and a banquet and dance. On Sunday, there will be a flea market and delegates' meeting. For information, write PO Box 5076, Station F, Ottawa, Ontario, CAN K2C 3H3.

**ASHEVILLE NC
OCT 13**

The Western Carolina Ama-

teur Radio Society will hold its Asheville Autumnfest on Saturday, October 13, 1979, at the Asheville Civic Center, Asheville, North Carolina. There will be ample space for manufacturers, dealers, and the flea market, which will be in another part of the arena. A concession stand will be operated by the Civic Center. All manufacturers and dealers will have separate booths. And it will be possible to drive directly to your booth for unloading.

SYRACUSE NY OCT 13

The Radio Amateurs of Greater Syracuse will hold its annual hamfest on October 13, 1979, from 9:00 am until 6:00 pm at the New York State Fairgrounds, located adjacent to I-690, 3 miles southeast of the New York State Thruway, Exit 39, one mile northwest of Syracuse, New York. For commercial exhibitors, a fee of \$15.00 will include a booth with a display counter ten to fifteen feet in length or a table and two chairs. Included in the \$15.00 fee will be two tickets to the hamfest. Accommodations are available at nearby motels or travel trailer and motor home space will be available on the grounds. Commercial exhibitors will be able to set up their displays Friday night from 7:30 to 10:00 pm or on Saturday morning from 7:30 to 9:00 am. For more information, contact Bod Edgett or Paul Dunn, exhibitor chairmen, c/o Radio Amateurs of Greater Syracuse, PO Box 88, Liverpool NY 13088.

MEMPHIS TN OCT 13-14

The Mid-South Amateur Radio Association and participating Memphis-area clubs will sponsor the Memphis Hamfest and Tennessee State ARRL Convention on October 13-14, 1979, at the Youth Building at the Mid-South Fairgrounds, Memphis, Tennessee. Featured will be forums, exhibits, a giant flea market, FCC exams, a hospitality party, and commercial and manufacturer exhibits. The display area will be open from 9:00 am to 4:00 pm on Saturday, and from 9:00 am to 2:30 pm on Sunday. Fifty trailer hookups are on the premises, which the Memphis Park Commission will rent for \$5.00 per night.

BEAVER OK OCT 14

The Beaver Hamfest will be held on October 14, 1979, at the Fairgrounds Building in Beaver OK. Doors open at 8:00 am, with registration at 10:00 am. Tickets are \$2.50 each. There will be a covered-dish luncheon, a short program at 1:30 pm, swap tables, and door prizes. Camper

hookups are nearby and the event is airport-close. Talk-in on .01/.61 and .52. For details, contact Stella Shaw WB5VUN, Box 310, Beaver OK 73932, (405)-625-3368.

LIMA OH OCT 14

The Northwest Ohio Amateur Radio Club will hold its annual hamfest on October 14, 1979, at the Allen County Fairgrounds, Lima, Ohio. Two large heated buildings will house the hamfest where tables will be available for \$3.00 each. A flea market will be held outside for free. Advance tickets are \$2.00 each. For information, send an SASE to NOARC, PO Box 211, Lima OH 45802.

WEST GHENT NY OCT 14

The Northeastern States 160-Meter Amateur Radio Association will hold its annual election and banquet on Sunday, October 14, 1979, at Kozel's Restaurant, Rte. 9H, West Ghent, New York. There will be a flea market in the rear parking lot at 1:00 pm and a roast beef dinner at 5:00 pm. All hams and XYLs are welcome. For reservations and details, contact William Derby WA5IOD, Secretary/Treasurer, 14 Plain St., Medfield MA 02052.

ISLIP LI NY OCT 14

The Long Island Mobile Amateur Radio Club, Inc., will hold its Hamfair '79 on Sunday, October 14, 1979, from 9:00 am until 4:00 pm at the Islip Speedway, Rte. 111 (Islip Ave.), one block south of Southern State Pkwy., Exit 43, or come south from the Long Island Expressway, Exit 56, Islip, Long Island, New York. There will be free parking, door prizes, and several contests. Admission is \$1.50 (non-hams are free) and \$3.00 per seller's space, which permits one person to enter. For information, call Hank Wener WB2ALW, nights, at (516)-484-4322, or Sid Grossman N2AOI, nights, at (516)-681-2194.

ANAHEIM CA OCT 19-21

The ARRL Southwestern Division Convention will be held on October 19-21, 1979, at the Sheraton-Anaheim Hotel, located at Ball Rd. and I-5, Anaheim, California. The convention will begin on Friday evening with registration and exhibits from 4:00 pm until 9:00 pm. On Saturday, registration will begin at 8:00 am and exhibits and technical sessions will run from 9:00 am until 3:30 pm. FCC testing will continue until 3:30 pm also. The ARRL Forum will be held from 4:00 pm until 5:30 pm, with a no-host

cocktail party being held until the 7:30 pm banquet. The Wouff Hong pageant will be held at 00:01 am PST on Sunday morning. At 9:00 am Sunday morning the various breakfasts will be held and the exhibits will again be open until noon. The pre-registration deadline is September 15, 1979. Advanced registration price, which includes complete program, banquet, exhibits, and technical sessions, is \$17.00, and \$19.00 at the door. The charge for the banquet only is \$12.00, and for exhibits and technical sessions, the charge is \$5.00, pre-registration; \$6.00 at the door. The ladies' program and luncheon is \$6.00, pre-registration only. For more information and pre-registration, contact Hamcon, PO Box 1227, Placentia CA, or phone (714)-993-7140.

CEDAR RAPIDS IA OCT 19-21

The 1979 ARRL Midwest Division Convention and CVARC Hamfest will be held on October 19-21, 1979, at the Five Seasons Center, Cedar Rapids, Iowa. Tickets are \$4.00 in advance or \$5.00 at the door. Forums will include FCC, ARRL, DX, antenna, AMSAT/OSCAR, FM and repeaters, microprocessors, modern CW, and more. A flea market will be held at \$5.00 per table with 150 tables available. Reservations are good for Saturday and Sunday and must be paid in advance. Pre-registrations will be taken through October 1, 1979. Setup begins at 6:00 am Saturday. FCC exams also will be given on Saturday. (Send Form 610 and copy of license two weeks in advance.) There will be many prizes, including a grand prize of a deluxe HF transceiver, a TH6DXX antenna, a HAM III rotor, and a 60-ft Rohn 25G tower. There will be a Saturday-evening banquet, with Senator Barry Goldwater K7UGA as guest speaker. There are many hotels and motels available. Talk-in on 146.34/.94. For information, write Convention, Cedar Valley Amateur Radio Club, Box 994, Cedar Rapids IA 52406.

BILOXI MS OCT 20-21

The Gulf Coast Ham/Swap Fest will be held on Saturday and Sunday, October 20 and 21, 1979, at the International Plaza, located at the west end of the Biloxi-Ocean Springs bridge on Highway 90 in Biloxi MS. Tables are \$3 per day or \$5 per weekend. Talk-in on 146.13/73 and 146.52. For information, advance tickets, and tables, contact Al Williams WD5GNR, 311½ DeMontluzin Ave., Bay St. Louis MS 39520.

READING MA OCT 20

The Quannapowitt Radio Association will hold its annual auction on October 20, 1979, at the Knights of Columbus Hall in Reading, Massachusetts. Doors will open at 10:00 am and the auction will start at 11:00 am. Food and refreshments will be available. Talk-in on 146.52. For information, call Bob Reiser AA1M at (617)-272-6219.

NORFOLK VA OCT 20-21

The fourth annual Tidewater Hamfest-Computer Show-Flea Market will be held on October 20-21, 1979, starting at 9:00 am at the Norfolk, Virginia, Cultural and Convention Center SCOPE, Norfolk, Virginia. There will be 60,000 square feet of air-conditioned exhibit and flea market tailgating space available. Featured will be ARRL meetings, DX and traffic forums, and a CW contest. FCC exams are planned for amateur upgrading on Saturday from 9:00 to 12:00 am. A special feature will be a dinner cruise and banquet on the *Spirit of Norfolk* cruise ship on Saturday night for \$16 per person, or \$30 per couple. Advance registrations are \$2.50 (include an SASE) or \$3.50 at the door. Flea market tailgate spaces are \$3.00 per day. For tickets and information, write TRC, PO Box 7101, Portsmouth VA 23707.

LONDON ONT CAN OCT 28

The London Amateur Radio Club will hold its 2nd annual Swap and Shop on October 28, 1979, from 8:00 am until 4:00 pm at Lord Dorchester High School in Dorchester, just off 401. Admission and tables are both \$2.00. Featured will be displays and prizes. Talk-in on .78/.18. For more information, write VE3CSK, RR #1, Ailsa Craig, Ontario, Canada N0M 1A0.

FRAMINGHAM MA NOV 11

The Framingham Area Radio Association will hold its indoor electronic flea market on Sunday, November 11, 1979, from 10:00 am until 2:00 pm at the Framingham Police drill shed behind the police station, Framingham, Massachusetts. From Rte. 9, take Rte. 126 south to the center of Framingham. Sellers' setup time is from 9:00 am to 10:00 am. Advance table reservations will be \$5.00, with tables available at the door for \$7.50. Refreshments will be served outside the flea market area. Talk-in on .75/.15 and .52. For information or reservations, write Framingham Area Radio Association, PO Box 3005, Framingham MA 01701.

The Only Automatic Dialing Touch Tone MIC

The CES Model 235A Automatic Micro-dialer has a 10 number memory that can store even 11 digit numbers. Just dial * and one digit to bring up auto-patch, pause and dial phone number automatically. Program Dialing speed for virtually any repeater auto-patch, then dial number at fastest speed. Automatic PTT with manual or automatic dialing. All dialing and programming done from Keyboard. LED indicator for programming or PTT and ... ✓C115



69.95

ALL CONTAINED IN A SMALL MIC.

At your Ham Radio Dealer or Call or Write

CES COMMUNICATIONS ELECTRONICS SPECIALTIES, inc.

399 W. Fairbanks Ave., Winter Park, Fla. 32789
305/645-0474

NEW! 5-Band Trap Dipole (80 thru 10Meters)



Pre-assembled:
Model 370-11

Power rated 2kW PEP, approx. 110-ft span

Complete with • wire • traps • end insulators • 50 ft RG-8/U, PL-259 connector • heavy duty cast aluminum and stainless steel center connector.

At your ✓B23 B&W dealer. 4-Band (40 thru 10M), 55 ft model 370-13 also available, pre-assembled only.



Made in Bristol, Pennsylvania, by

Barker & Williamson Inc.

10 Canal Street □ Bristol, PA 19007

GREAT NEWS



CLEGG AB-144

For owners of Multi-Mode 2 Meter Transceivers!

Your present rig becomes a superb VLF/LF/MF/HF receiver tuning continuously from 100 KHz to 30 MHz.

ORDER YOURS TODAY VIA
1-(800)-233-0250

or write for DATA SHEET.

ONLY \$129.95 including UPS

Full refund (less shipping costs) within 10 days if not delighted.

Clegg ✓C3

Communications Corp.

1911 Old Homestead Lane
Greenfield Industrial Park East
Lancaster, PA 17601
(717) 299-7221

QUASAR VIDEO TAPE RECORDER SALE!

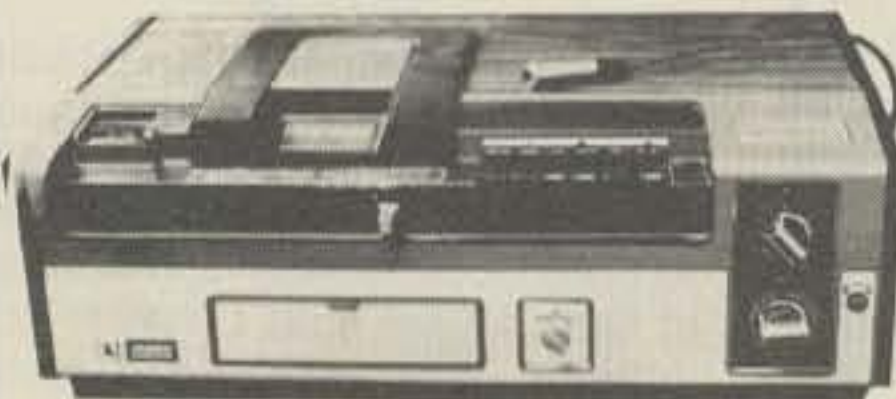

- ★ Records to two hours, color or black & white
 - ★ Records off the air—record one program while watching another
 - ★ Camera input to make your own tapes
 - ★ Can be used with optional timer while you are out
 - ★ Pause control for editing
 - ★ Limited supply—these \$1,000 VTRs were demonstrators & come with new warranty... \$499
- \$100 worth of new blank tape will be included at no extra charge!

Send for our new catalog!
\$3 Shipping charge per order • NO C.O.D.s!

Bill: MC Visa Amex

Credit card # _____

Exp. date _____

Signature _____

Name _____

Address _____

City _____ State _____ Zip _____

TUFTS
Radio Electronics

209 S. Mystic Ave
Medford MA 02153
1(800) 225-4428
(617) 395-8280

✓T3

ALL BAND TRAP VERTICAL ANTENNAS!

FULL 1 4th WAVE - All Bands! Automatic Selection with proven HI-Q Traps. 3 Models-ALL self supporting - Ground or roof mount. HEAVY Double wall seamless Aluminum lower section - HI IMPACT POLY Low Loss Plastic Cover OVER-ALL. NO WOBBLY, LUMPY TRAPS - NO UNSIGHTLY CLAMPS needed - Same size all the way up - 1 1/4" - Traps hidden inside. You can use it in a 1 ft. sq. Backyard! Neighbors will never know this is a HI-Power ALL Direction DX Antenna. FOR APARTMENTS, ROW HOUSES, MOBILE HOMES - CONDOS etc. where minimum space and neat appearance is MANDATORY! Instant "Drive In" ground mount (Included). Use with or without radials (Included) (All angle roof mount - Extra) COMPLETELY PRETUNED - NO ADJUSTMENTS NEEDED EVER! NO TUNER NEEDED Over All Bands (except 80 meter - 400 KC) SWR 1-1 to 2-1 at Band edges, Std, SO239 connector - 50 ohm for any length RG58U - RG8U feedline. Matches ALL MAKES TRANSRECEIVERS. 2000 Watt PEP. Shipped in 5 ft. Box - PREPAID IN USA. Assembles in 3 min. using only screwdriver. WEATHERPROOF!

No.-AVT80-10 5 Band 24'9" \$79.95
No.- AVT40-10 4 Band 18'9" \$69.95
No.- AVT20-10 3 Band 12'6" \$59.95

SEND FULL PRICE FOR PP DEL IN USA (Canada is \$5.00 extra for postage, clerical, Customs etc.) or order using VISA (BankAmericard) or MASTER CHARGE or AMER EXP. Give Number and Ex. date. Ph 1-308-236-5333 9AM-6PM weekdays. We ship in 2-3 days.

Prices will increase Sept 1, so order NOW AND SAVE. All Antennas Guaranteed for 1 year - 10 day money back trial. Made in USA. Free Inf. Available from WESTERN ELECTRONICS Dept. A7 - 9 Kearney Ne, 68847



The **ONLY** thing you need to know about

Quartz Crystals

is: **1-405-224-6780**

• Best delivery plus Emergency Service with Guaranteed Delivery

• Highest Quality with gold MIL-C-3098 Process

• Ask for Sentry Technology Manual

And, order Toll Free 1-800-654-8850

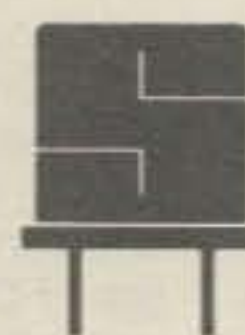
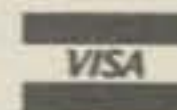

SENTRY

✓S3 Crystal Park
Chickasha, Oklahoma
73018



ATTENTION ELF OWNERS ANNOUNCING QUEST SUPER BASIC

At last a Full Size Basic for 1802 systems. A complete function Basic including two dimensional arrays, string variables, floating point, arithmetic and 32 bit signed integer arithmetic (10 digit accuracy) with I/O routines. Easily adaptable on most 1802 systems. Requires 12K RAM minimum for Basic and user programs. Cassette version in stock now for immediate delivery. ROM versions coming soon with exchange privilege allowing credit for cassette version.

Super Basic on Cassette **\$40.00**

Tiny Basic Source now available **\$19.00**

S-100 Slot Expansion. Add 3 more S-100 slots to your Super Expansion Board or use as a 4 slot S-100 Mother Board. Board without connectors **\$9.95.**

Coming Soon: High resolution alpha/numerics with color graphics expandable up to 256 x 192 resolution for less than **\$100.** Economical versions for other popular 1802 systems also.

16K Dynamic RAM board expandable to 32K for less than **\$150.**

RCA Cosmac Super Elf Computer \$106.95

Compare features before you decide to buy any other computer. There is no other computer on the market today that has all the desirable benefits of the Super Elf for so little money. The Super Elf is a small single board computer that does many big things. It is an excellent computer for training and for learning programming with its machine language and yet it is easily expanded with additional memory, Full Basic, ASCII Keyboards, video character generation, etc.

Before you buy another small computer, see if it includes the following features: ROM monitor; State and Mode displays; Single step; Optional address displays; Power Supply; Audio Amplifier and Speaker; Fully socketed for all IC's; Real cost of in warranty repairs; Full documentation.

The Super Elf includes a ROM monitor for program loading, editing and execution with SINGLE STEP for program debugging which is not included in others at the same price. With SINGLE STEP you can see the microprocessor chip operating with the unique Quest address and data bus displays before, during and after executing instructions. Also, CPU mode and instruction cycle are decoded and displayed on 8 LED indicators.

An RCA 1861 video graphics chip allows you to connect to your own TV with an inexpensive video modulator to do graphics and games. There is a speaker system included for writing your own music or using many music programs already written. The speaker amplifier may also be used to drive relays for control purposes.

Super Expansion Board with Cassette Interface \$89.95

This is truly an astounding value! This board has been designed to allow you to decide how you want it optioned. The Super Expansion Board comes with 4K of low power RAM fully addressable anywhere in 64K with built-in memory protect and a cassette interface. Provisions have been made for all other options on the same board and it fits neatly into the hardwood cabinet alongside the Super Elf. The board includes slots for up to 6K of EPROM (2708, 2758, 2716 or TI 2716) and is fully socketed. EPROM can be used for the monitor and Tiny Basic or other purposes.

A 1K Super ROM Monitor \$19.95 is available as an on board option in 2708 EPROM which has been preprogrammed with a program loader/editor and error checking multi file cassette read/write software, (relocatable cassette file) another exclusive from Quest. It includes register save and readout, block move capability and video graphics driver with blinking cursor. Break points can be used with the register save feature to isolate program bugs quickly, then follow with single step. The Super Monitor is written with subroutines allowing users to take advantage of

A 24 key HEX keyboard includes 16 HEX keys plus load, reset, run, wait, input, memory protect, monitor select and single step. Large, on board displays provide output and optional high and low address. There is a 44 pin standard connector slot for PC cards and a 50 pin connector slot for the Quest Super Expansion Board. Power supply and sockets for all IC's are included in the price plus a detailed 127 pg. instruction manual which now includes over 40 pgs. of software info, including a series of lessons to help get you started and a music program and graphics target game.

Many schools and universities are using the Super Elf as a course of study. OEM's use it for training and research and development.

Remember, other computers only offer Super Elf features at additional cost or not at all. Compare before you buy. Super Elf Kit \$106.95, High address option \$8.95, Low address option \$9.95. Custom Cabinet with drilled and labelled plexiglass front panel \$24.95. Expansion Cabinet with room for 4 S-100 boards \$41.00. NiCad Battery Memory Saver Kit \$6.95. All kits and options also come completely assembled and tested.

Questdata, a 12 page monthly software publication for 1802 computer users is available by subscription for \$12.00 per year.

Tiny Basic Cassette \$10.00, on ROM \$38.00, original Elf kit board \$14.95.

monitor functions simply by calling them up. Improvements and revisions are easily done with the monitor. If you have the Super Expansion Board and Super Monitor the monitor is up and running at the push of a button.

Other on board options include Parallel Input and Output Ports with full handshake. They allow easy connection of an ASCII keyboard to the input port. RS 232 and 20 ma Current Loop for teletype or other device are on board and if you need more memory there are two S-100 slots for static RAM or video boards. A Godbout 8K RAM board is available for \$135.00. Also a 1K Super Monitor version 2 with video driver for full capability display with Tiny Basic and a video interface board. Parallel I/O Ports \$9.85, RS 232 \$4.50, TTY 20 ma I/F \$1.95, S-100 \$4.50. A 50 pin connector set with ribbon cable is available at \$12.50 for easy connection between the Super Elf and the Super Expansion Board.

The Power Supply Kit for the Super Expansion Board is a 5 amp supply with multiple positive and negative voltages \$29.95. Add \$4.00 for shipping. Prepunched frame \$7.50. Case \$10.00. Add \$1.50 for shipping.

Multi-volt Computer Power Supply
8v 5 amp, ±18v .5 amp, 5v 1.5 amp, -5v .5 amp, 12v .5 amp, -12 option, ±5v, ±12v are regulated. Kit \$29.95. Kit with punched frame \$37.45. Woodgrain case \$10.00.

60 Hz Crystal Time Base Kit \$4.40
Converts digital clocks from AC line frequency to crystal time base. Outstanding accuracy. Kit includes: PC board, IC, crystal, resistors, capacitors and trimmer.

TERMS: \$5.00 min. order U.S. Funds. Calif residents add 6% tax.
BankAmericard and Master Charge accepted.
Shipping charges will be added on charge cards.

Same day shipment. First line parts only.
Factory tested. Guaranteed money back.
Quality IC's and other components at factory prices.

INTEGRATED CIRCUITS

7400TL	LM3177K	2.92	CD4015	.86
7400N	LM318	1.35	CD4016	.36
7402N	LM320K-5	1.20	CD4017	.94
7404N	LM323K-5	8.95	CD4018	.94
7409N	LM320K-12	1.35	CD4019	.28
7410N	LM320K-15	1.35	CD4020	1.02
7414N	LM320T-5	1.60	CD4021	1.02
7420N	LM320T-8	1.60	CD4022	.86
7427N	LM320T-12	1.50	CD4023	.28
7430N	LM320T-15	1.60	CD4024	.75
7443N	LM324N	1.15	CD4025	.28
7445N	LM329N	1.55	CD4026	1.51
7447N	LM340K-5	1.35	CD4027	.36
7448N	LM340K-8	1.35	CD4028	.79
7450N	LM340K-12	1.35	CD4029	1.02
7474N	LM340K-15	1.35	CD4030	.28
7475N	LM340K-24	1.35	CD4035	1.02
7485N	LM340T-5	1.25	CD4040	1.02
7489N	LM340T-8	1.25	CD4042	.71
7490N	LM340T-12	1.25	CD4043	.63
7492N	LM340T-15	1.25	CD4044	.63
7493N	LM340T-18	1.25	CD4046	1.67
7495N	LM340T-24	1.25	CD4049	.36
74100N	LM343H	4.50	CD4050	.36
74107N	LM350	7.50	CD4051	1.13
74121N	LM370	1.15	CD4060	1.42
74123N	LM377	3.00	CD4066	.71
74125N	LM379	5.00	CD4068	.40
74150N	LM3801	1.60	CD4069	.40
74151N	LM382	1.60	CD4070	.40
74154N	LM382H	4.00	CD4072	.28
74157N	LM389H	2.80	CD4073	.28
74161N	LM723HN	5.00	CD4075	.28
74162N	LM733N	6.70	CD4076	1.75
74163N	LM741CH	3.50	CD4078	.40
74174N	LM741N	2.50	CD4081	.28
74175N	LM747HN	8.50	CD4082	.28
74180N	LM749N	3.50	CD4116	.47
74182N	LM733N	6.70	CD4490	5.50
74183N	LM733N	6.70	CD4507	1.00
74184N	LM733N	6.70	CD4508	4.25
74185N	LM733N	6.70	CD4510	1.02
74186N	LM733N	6.70	CD4511	.94
74187N	LM733N	6.70	CD4512	1.10
74188N	LM733N	6.70	CD4513	1.02
74189N	LM733N	6.70	CD4514	1.02
74190N	LM733N	6.70	CD4515	1.10
74191N	LM733N	6.70	CD4516	1.10
74192N	LM733N	6.70	CD4517	1.10
74193N	LM733N	6.70	CD4518	1.10
74194N	LM733N	6.70	CD4519	1.10
74195N	LM733N	6.70	CD4520	1.10
74196N	LM733N	6.70	CD4521	1.10
74197N	LM733N	6.70	CD4522	1.10
74198N	LM733N	6.70	CD4523	1.10
74199N	LM733N	6.70	CD4524	1.10
74200N	LM733N	6.70	CD4525	1.10
74201N	LM733N	6.70	CD4526	1.10
74202N	LM733N	6.70	CD4527	1.10
74203N	LM733N	6.70	CD4528	1.10
74204N	LM733N	6.70	CD4529	1.10
74205N	LM733N	6.70	CD4530	1.10
74206N	LM733N	6.70	CD4531	1.10
74207N	LM733N	6.70	CD4532	1.10
74208N	LM733N	6.70	CD4533	1.10
74209N	LM733N	6.70	CD4534	1.10
74210N	LM733N	6.70	CD4535	1.10
74211N	LM733N	6.70	CD4536	1.10
74212N	LM733N	6.70	CD4537	1.10
74213N	LM733N	6.70	CD4538	1.10
74214N	LM733N	6.70	CD4539	1.10
74215N	LM733N	6.70	CD4540	1.10
74216N	LM733N	6.70	CD4541	1.10
74217N	LM733N	6.70	CD4542	1.10
74218N	LM733N	6.70	CD4543	1.10
74219N	LM733N	6.70	CD4544	1.10
74220N	LM733N	6.70	CD4545	1.10
74221N	LM733N	6.70	CD4546	1.10
74222N	LM733N	6.70	CD4547	1.10
74223N	LM733N	6.70	CD4548	1.10
74224N	LM733N	6.70	CD4549	1.10
74225N	LM733N	6.70	CD4550	1.10
74226N	LM733N	6.70	CD4551	1.10
74227N	LM733N	6.70	CD4552	1.10
74228N	LM733N	6.70	CD4553	1.10
74229N	LM733N	6.70	CD4554	1.10
74230N	LM733N	6.70	CD4555	1.10
74231N	LM733N	6.70	CD4556	1.10
74232N	LM733N	6.70	CD4557	1.10
74233N	LM733N	6.70	CD4558	1.10
74234N	LM733N	6.70	CD4559	1.10
74235N	LM733N	6.70	CD4560	1.10
74236N	LM733N	6.70	CD4561	1.10
74237N	LM733N	6.70	CD4562	1.10
74238N	LM733N	6.70	CD4563	1.10
74239N	LM733N	6.70	CD4564	1.10
74240N	LM733N	6.70	CD4565	1.10
74241N	LM733N	6.70	CD4566	1.10
74242N	LM733N	6.70	CD4567	1.10
74243N	LM733N	6.70	CD4568	1.10
74244N	LM733N	6.70	CD4569	1.10
74245N	LM733N	6.70	CD4570	1.10
74246N	LM733N	6.70	CD4571	1.10
74247N	LM733N	6.70	CD4572	1.10
74248N	LM733N	6.70	CD4573	1.10
74249N	LM733N	6.70	CD4574	1.10
74250N	LM733N	6.70	CD4575	1.10
74251N	LM733N	6.70	CD4576	1.10
74252N	LM733N	6.70	CD4577	1.10
74253N	LM733N	6.70	CD4578	1.10
74254N	LM733N	6.70	CD4579	1.10
74255N	LM733N	6.70	CD4580	1.10
74256N	LM733N	6.70	CD4581	1.10
74257N	LM733N	6.70	CD4582	1.10
74258N	LM733N	6.70	CD4583	1.10
74259N	LM733N	6.70	CD4584	1.10
74260N	LM733N	6.70	CD4585	1.10
74261N	LM733N	6.70	CD4586	1.10
74262N	LM733N	6.70	CD4587	1.10
74263N	LM733N	6.70	CD4588	1.10
74264N	LM733N	6.70	CD4589	1.10
74265N	LM733N	6.70	CD4590	1.10
74266N	LM733N	6.70	CD4591	1.10
74267N	LM733N	6.70	CD4592	1.10
74268N	LM733N	6.70	CD4593	1.10
74269N	LM733N	6.70	CD4594	1.10
74270N	LM733N	6.70	CD4595	1.10
74271N	LM733N	6.70	CD4596	1.10
74272N	LM733N	6.70	CD4597	1.10
74273N	LM733N	6.70	CD4598	1.10
74274N	LM733N	6.70	CD4599	1.10
74275N	LM733N	6.70	CD4600	1.10
74276N	LM733N	6.70	CD4601	1.10
74277N	LM733N	6.70	CD4602	1.10
74278N	LM733N	6.70	CD4603	1.10
74279N	LM733N	6.70	CD4604	1.10
74280N	LM733N	6.70	CD4605	1.10
74281N	LM733N	6.70	CD4606	1.10
74282N	LM733N	6.70	CD4607	1.10
74283N	LM733N	6.70	CD4608	1.10
74284N	LM733N	6.70	CD4609	1.10
74285N	LM733N	6.70	CD4610	1.10
74286N	LM733N	6.70	CD4611	1.10
74287N	LM733N	6.70	CD4612	1.10
74288N	LM733N	6.70	CD4613	1.10
74289N	LM733N	6.70	CD4614	1.10
74290N	LM733N	6.70	CD4615	1.10
74291N	LM733N	6.70	CD4616	1.10
74292N	LM733N	6.70	CD4617	1.10
74293N	LM733N	6.70	CD4618	1.10
74294N	LM733N	6.70	CD4619	1.10
74295N	LM733N	6.70	CD4620	1.10
74296N	LM733N	6.70	CD4621	1.10
74297N	LM733N	6.70	CD4622	1.10
74298N	LM733N	6.70	CD4623	1.10
74299N	LM733N	6.70	CD4624	1.10
74300N	LM733N	6.70	CD4625	1.10

IC Keyer

The World's Greatest
Sending Device



Adjustable to
Any Desired Speed

Now available from Palomar Engineers — the new Electronic IC KEYSER. Highly prized by professional operators because it is **EASIER, QUICKER, and MORE ACCURATE.**

It transmits with amazing ease **CLEAR, CLEAN-CUT** signals at any desired speed. Saves the arm. Prevents cramp, and enables anyone to send with the skill of an expert.

▶ **SPECIAL** ◀
RADIO MODEL

Equipped with large specially constructed contact points. Keys any amateur transmitter with ease. Sends Manual, Semi-Automatic, Fully Automatic, Dot Memory, Dash Memory, Squeeze, and Iambic — **MORE FEATURES** than any other keyer. Has built-in sidetone, speaker, speed and volume controls, **BATTERY OPERATED**, heavy shielded die-cast metal case. Fully **ADJUSTABLE CONTACT SPACING AND PADDLE TENSION**. The perfect paddle touch will **AMAZE** you.

Every amateur and licensed operator should know how to send with the IC KEYSER. **EASY TO LEARN**. Sent anywhere on receipt of price. Free brochure sent on request.

Send check or money order. IC KEYSER \$97.50 in U.S. and Canada. Add \$3.00 shipping/handling. Add sales tax in California.

Fully guaranteed by the world's oldest manufacturer of electronic keys.

ORDER YOURS NOW!

Palomar Engineers

Box 455, Escondido, CA. 92025

Phone: [714] 747-3343

TODAY'S MOST VERSATILE SCANNER

Scan a few channels or all 800 - for example - you can program CES Model 800 to scan Repeater and Simplex Channels or all 2 Meter Bands - Other features include: Instantaneous Addition or Deletion of Channels • Scan Resume delay assures hearing return calls • Resume and Hold provides complete control of scanning action • Hold Control activated by mic's P.T.T. switch • Scan entire band in 5 KHz steps and retain programmed memory • Selectable automatic scan resume after 10 secs. on channel. Slow Scan of memory to locate specific channels.

Available
for Kenwood TR
7400, Midland 13-510,
Yaesu 227R, or KDK FM-144

At your Ham Radio Dealer
or Call or Write ✓ C115

CES COMMUNICATIONS
ELECTRONICS
SPECIALTIES, inc.

399 W. Fairbanks Ave., Winter Park, Fla. 32789
305/645-0474

DOVETRON



MPC-1000C

Multipath Correction
In-Band Diversity &
AFSK Tone Keyer

Amateur Net: \$545.00

Standard features include CONTINUOUSLY tuneable Mark and Space channels (1000 Hz to 3200 Hz), Dual Mode (MARK or FSK) Autostart and internal high level neutral loop keyer (20 to 60 ml). Both EIA and MIL FSK outputs are provided for direct interface to microprocessor and video terminal peripherals.



MPC-1000CR

Signal Regeneration &
Speed Conversion

Amateur Net: \$645.00

A front panel switch permits internal TSR-200 Signal Regenerator-Speed converter assembly to electronically "gear-shift" between 60, 67, 75 and 100 WPM. All incoming and outgoing signals are regenerated to less than 0.5% bias distortion. Also available with DIGITAL Autostart (TSR-200D): Amateur Net: \$695.00



MPC-1000R/- TSR-500

Dual UART Regeneration,
Speed Conversion, 200
Char. Memory, Word Cor-
rection & DIGITAL
Autostart

Amateur Net: \$895.00*

The MPC-1000R/TSR-500 provides Preloading and Recirculation of the 200 character FIFO Memory, a keyboard-controlled Word Correction circuit, Variable Character Rate, Tee Dee Inhibit, Blank/LTRS Diddle, a Triple Tone-Pair AFSK Tone Keyer and a Character Recognition/Speed Determination DIGITAL (DAS-100) Autostart mode.

*The MPC-1000R is also available without a TSR assembly and functions as a MPC-1000C with a Triple Tone-Pair AFSK Tone Keyer. This "Basic-R" permits future expansion with a TSR-100, TSR-200, TSR-200D or TSR-500 by simply lifting the lid and plugging in the appropriate TSR assembly: Amateur Net (Basic-R): \$595.00

Your QSL will bring complete specifications, or call: 213-682-3705.

✓ D23

DOVETRON

627 FREMONT AVENUE
(P. O. BOX 267)
SOUTH PASADENA, CA. 91030

☆☆☆☆☆☆☆☆☆☆ **PALOMAR ENGINEERS** ☆☆☆☆☆☆☆☆☆☆

R-X NOISE BRIDGE \$49.95



- Learn the truth about your antenna.
- Find its resonant frequency.
- Find R and X off-resonance.
- Broadband 1-100 MHz.
- Simple to use. — Self contained.

VLF CONVERTER \$55.00



- New device opens up the world of VLF radio.
- Converts VLF to 80 meters. For use with any shortwave receiver covering 3.5-4 MHz.
- Advanced design for simple operation, high performance.
- Gives reception of the 1750 meter band.
- Also covers navigation radiobeacons, WWVB, ship-to-shore, and LF broadcast band.

LOOP ANTENNA
Loop Amplifier \$67.50
Plug-in loops \$47.50 ea.

- Plug-in loops available for:
1600-5000 KHz (160/80 meter amateur bands)
550-1600 KHz (Broadcast Band)
150-550 KHz (VLF, 1750 meter band)
40-150 KHz (WWVB, Loran)
10-40 KHz (Omega)
• Nulls out interference



ALL BANDS PREAMPLIFIER \$89.50



- Tunes 1.8 to 54 MHz. Covers ALL amateur bands 160 to 6 meters. ALL shortwave broadcast bands.
- For receivers AND transceivers.
- Up to 20 db gain.
- Peps up that tired receiver.
- Reduces image and spurious response.

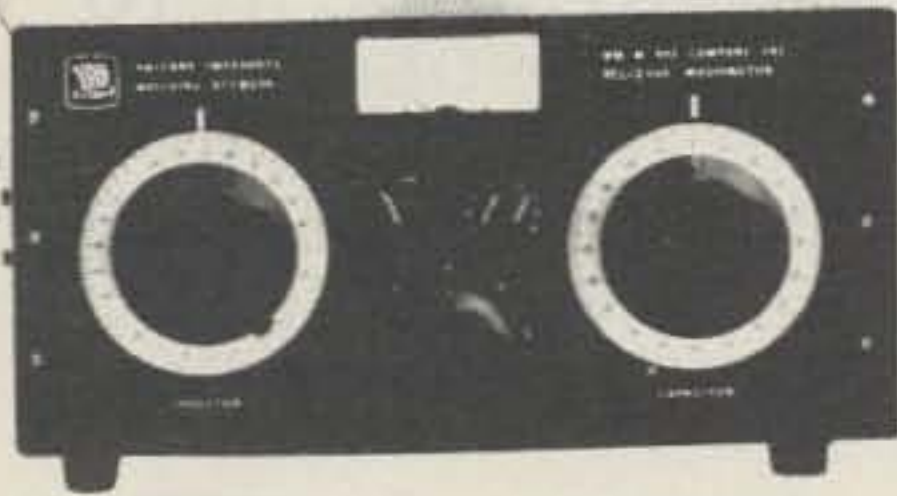

Model MB II \$295
(with Balun) \$325

MB II provides:

- Constant SWR monitoring. • Precision tuning of final amp. • Harmonic suppression.
- Receiver input impedance-matching. • Maximum power transfer to antenna. • Continuous frequency coverage 1.6 to 30 MHz. • Precision tuning of any wire 1/2 wavelength or longer, with SWR of 1:1.

MB II features:

- Finest quality, made-in-USA components. • Large, precision, easy-to-read dials with 360 readout. • Optional 3000 watt Balun for twin lead antennas.

BIRD
Electronic Corporation

\$94 VHF model 4362 (140-180 MHz)

\$94 HF model 4360 (18-30 MHz)

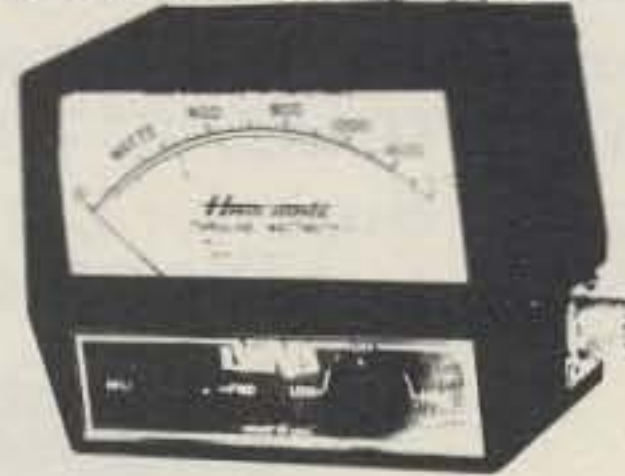

The 4360, 4362 HAM-MATE Directional Wattmeters are insertion type instruments for measuring forward or reflected power in 50-ohm coaxial transmission lines. They are direct descendants of the model 43 THRULINE® Wattmeter — the professional standard of the industry—and will accurately measure RF power flow under any load condition. Each wattmeter is made up of a precisely machined section of 50-ohm line, a rotatable sensing element and meter calibrated in watts, all mounted in a high-impact plastic housing. It is this type of solid construction and the directional THRULINE coupling circuit, without toroids, that account for the superiority of the HAM-MATE Wattmeters.

the indispensable
BIRD 43
THRULINE
WATTMETER



Power Range	Frequency Bands (MHz)				
	2-30	25-100	100-1000	200-500	400-1000
5 watts	—	5A	5C	5D	5E
10 watts	—	10A	10C	10D	10E
25 watts	—	25A	25C	25D	25E
50 watts	50H	50A	50C	50D	50E
100 watts	100H	100A	100C	100D	100E
250 watts	250H	250A	250C	250D	250E
500 watts	500H	500A	500C	500D	500E
1000 watts	1000H	1000A	1000C	1000D	1000E
2500 watts	2500H	—	—	—	—
5000 watts	5000H	—	—	—	—

MODEL 43
Elements (Table 1) 2-30 MHz \$125.00
Elements (Table 1) 25-1000 MHz 45.00
Carrying case for Model 43 & 6 elements 38.00
Carrying case for 12 elements 27.50
Carrying case for 12 elements 17.00

READ RF WATTS DIRECTLY! (Specify Type N or SO239 connectors) 0.45 — 2300 MHz, 1-10,000 Watts ±5%, low insertion VSWR — 1.05. Unequaled economy and flexibility. Buy only the element(s) covering your present frequency and power needs, add extra ranges later if your requirements expand.



5-BAND TRAP DIPOLE
(80 thru 10 Meters)

Barker & Williamson

Power rated 2k WPEP, approx. 110 ft. span

Complete with: wire, traps, end insulators, 50 ft. RG-8/U, PL-259 connector, heavy-duty cast aluminum and steatite center connector. 4-Band (40 thru 10M) 55 ft.



Pre-assembled:
Model 370-11
— \$59.95

Kit (illustrated):
Model 370-12 — \$49.95

Hy-Gain REEL TAPE PORTABLE DIPOLE
for 10 thru 80 Meters Model 18TD

The most portable high performance dipole ever...

The Model 18TD is unquestionably the most foolproof high performance portable doublet antenna system ever developed. It has proven invaluable in providing reliable communications in vital military and commercial-applications throughout the world. Two stainless steel tapes, calibrated in meters, extend from either side of the main housing up to a total distance of 132 feet for 3.5 mc operation. 25 ft. lengths of polypropylene rope attached to each tape permits installation to poles, trees, buildings... whatever is available for forming a doublet antenna system. Integrated in the high impact housing is a frequency to length conversion chart calibrated to meter measurements on the tapes... makes installation foolproof. Feeds with 52 ohm coax. Delivers outstanding performance as a portable or permanent installation. Measures 10x5½x2 inches retracted. Wt., 4.1 lbs.
Order No. 228 Price: \$94.95



hy-gain

BOMAR Crystal Company
TWO METERS
CRYSTALS IN STOCK
Motorola HT 220 Crystals
In Stock!

Standard • Icom • Heathkit • Ken • Clegg • Regency • Wilson • VHF Eng • Drake • And Others! Lifetime Guarantee! Now only \$9/pair.

BANDPASS-REJECT DUPLEXER
DPLA-144 FOR 144-174 MHz

Also available for
54, 220, 450 MHz.

THESE BAND PASS BAND REJECT CIRCUIT DUPLXERS include the use of an exclusive circuit designed for VHF ENG which provides superior suppression of spurious sideband noise between and adjacent to the duplex frequencies. When used with a high Q filter, the Band Pass Band Reject Circuit provides frequency response curves with bandwidths varying characteristics of the frequency to be passed and band-reject characteristics at the frequency to be attenuated. Performance characteristics improve as the frequency approaches is increased. Frequency stability of the Band Pass Band Reject Circuit duplexers is excellent — an important factor in close frequency spacing. Each model will handle transmitter powers up to 250 watts and all models are supplied with complete cable harness and mounting frame.

\$409.95



Name _____ Call _____
Address _____
City _____ State _____ Zip _____
Order: _____

Check Enclosed Visa Master Charge Send for Free Catalog

PRICES SUBJECT TO CHANGE WITHOUT NOTICE

Card no. _____ Card exp. date _____
Signature _____

Prices FOB Medford, MA. MA residents add 5% sales tax. Minimum \$3.00 for shipping and handling on ALL ORDERS.

TUFTS

Radio Electronics
OPEN DAILY 9-9
SATURDAY 9-6

206 Mystic Avenue, Box 73, Medford, Mass. 02155, 1-800-225-4428, (Mass. residents: 1-617-395-8280)

NEW! NEW! NEW!
FM2016A



All Solid State-CMOS PL digital synthesized - No Crystals to Buy! 5KHz steps - 144-149 MHz-HUGE 3/8" LED digital readout PLUS MARS-CAP and MULTIPLE OFFSET BUILT IN.
 ● 5 MHz Band Coverage - 1000 Channels (instead of the usual 2 MHz to 4 MHz-400 to 800 Channels) ● 4 CHANNEL RAM IC MEMORY WITH SCANNING AND AUTO TRANSMIT ● MULTIPLE FREQUENCY OFFSETS ● ELECTRONIC AUTO TUNING - TRANSMIT AND RECEIVE ● INTERNAL MULTIPURPOSE TONE OSCILLATOR ● RIT ● RF ATT ● DISCRIMINATOR METER - 16 Watts Output-Superior Receiver Sensitivity and Selectivity - 15 POLE FILTER, MONOLITHIC CRYSTAL FILTER AND AUTOMATIC TUNED RECEIVER FRONT END, COMPARE!
 ● Superb Engineering and Superior Commercial Avionics Grade Quality and Construction Second to None at ANY PRICE.

SUMMER SPECIAL
\$299⁰⁰
 Reg. \$369.00



FMMC-1* Microphone with Built-in Touch Tone Pad.

WHY BUY LESS? THE FMMC-1 HAS IT ALL!

- New! Auto key up
- Snap-Action Keyboard
- Adj. level and tone balance
- Use with any transceiver
- Only 3 1/4" x 2" \$39⁹⁵

Regulated AC/PS Model FMPS-4R . . . \$39.95

SHOWN WITH OPTIONAL µP-800 MICRO-PROGRAMMER* \$99.⁰⁰

- **FREQUENCY RANGE:** Receive and Transmit: 144.00 to 148.995 MHz, 5 KHz steps (1000 channels) + MARS-CAP and MULTIPLE OFFSET BUILT IN.
- **HUGE 3/8" LED DIGITAL READOUT.**
- **4 CHANNEL RAM SCANNER WITH IC MEMORY AND AUTO TRANSMIT:** Program any 4 frequencies and reprogram at any time using the front panel controls—search for occupied (closed) channel or vacant (open) channels. Internal Ni-Cad included to retain memory (no diode matrix to wire or change).
- **MULTIPLE FREQUENCY OFFSETS: NO CRYSTALS TO BUY - EVER -** Any offset any split! "Odd Ball" splits accomplished by digital programming. Never any need for crystals!
- **INTERNAL MULTIPURPOSE TONE OSCILLATOR BUILT IN:** Sine Wave 1750 Hz tone burst for "whistle on operation" and sub-audible tone operation. Internal 2 position switch for automatic and manual operation, tone burst or sub audible tone. PL - adjustable 60-203 Hz (100 Hz Pre-Set).
- **AIRCRAFT TYPE FREQUENCY SELECTOR:** Large and small coaxially mounted knobs select 100KHz and 10KHz steps respectively. Switches click-stopped with a home position facilitate frequency changing without need to view LED's while driving and provides the sightless amateur with full Frequency Selection as standard equipment.
- **FULL AUTOMATIC TUNING OF RECEIVER FRONT END AND TRANSMITTER CIRCUITS:** DC output of PLL fed to varactor diodes in all front end RF tuned circuits provides full sensitivity and optimum intermodulation rejection over the entire band. APC (AUTO POWER CONTROL) - Keeps RF output constant from band edge to band edge. NO OTHER AMATEUR UNIT AT ANY PRICE has these features which are found in only the most sophisticated the expensive aircraft and commercial transceivers.

- **TRUE FM:** Not phase modulation - for superb emphasized hi-fi audio quality second to none.
- **RIT CONTROL:** Used to improve clarity when contacting stations with off frequency carrier.
- **MONITOR LAMPS:** 2 LED's on front panel indicate (1) incoming signal-channel busy, and (2) Transmit.
- **FULLY REGULATED INTEGRAL POWER SUPPLY:** Operating voltage for all 9v circuits independently regulated. Massive Commercial Hash Filter.
- **MODULAR COMMERCIAL GRADE CONSTRUCTION:** 3 Unitized modules eliminate stray coupling and facilitate ease of maintenance.
- **ACCESSORY SOCKET:** Fully wired for touch tone, phone patch, and other accessories. Internal switch connects receiver output to internal speaker when connector is not in use.
- **MULTI-PURPOSE METER:** Triple Function Meter Provides Discriminator Meter, "S" Reading on receive and Power Out on Transmit.
- **RECEIVE:** Better than .25uv sensitivity, 15 POLE FILTER as well as monolithic crystal filter and AUTOMATIC TUNED LC circuits provide superior skirt selectivity - COMPARE!
- **HIGH/LOW POWER OUTPUT:** 16 watts and 1 watt, switch selected. Low power may be adjusted anywhere between 1 and 16 watts. Fully protected - short or open SWR.
- **RF ATT:** Live right next to King Kong Repeater and can't operate? With the 2016A You Can - Just flick the RF ATT switch. Only the 2016A has this feature.
- **OTHER FEATURES:** Dynamic Microphone, built in speaker, mobile mounting bracket, external 5 pin accessory jack, speaker jack, and much, much more. Size 2 1/2 x 7 x 7 1/2. All cords, plugs, fuses, microphone hanger, etc. included. Weight 5 lbs.

Manufactured by one of the world's most distinguished Avionics manufacturers, Kyokuto Denshi Kaisha, Ltd. First in the world with an all solid state 2 meter FM transceiver.



AMATEUR-WHOLESALE ELECTRONICS

8817 S.W. 129th Terrace, Miami, Florida 33176

Telephone (305) 233-3631 ● Telex: 80-3356

U.S. DISTRIBUTOR DEALER INQUIRIES INVITED

ORDER NOW TOLL-FREE

Credit card holders may use

our toll-free ordering number

Ask for operator 701

(800) 824-7888

In California (800) 852-7777

Alaska and Hawaii (800) 824-7919

✓ A21

800 800

Regional Sales & Service Centers *

East: Sanford Communications, Inc. Colonia, N.J. (201) 574-3003

Northeast: Buzzards Bay Electronics Buzzards Bay, Mass. (617) 759-3376

West: The Radio Place Sacramento, Cal. (916) 441-7388

Northwest: Action Supply, Inc. Boise, Idaho (208) 344-5084

Midwest: Universal Service Columbus, Ohio (614) 866-4267

South: Electronic Communications Highland Springs, Virginia (804) 737-5100

COMPARE AT ANY PRICE!
JP-800 MICRO-PROGRAMMER
 FOR KDK 2016A AND 2015R



- 800 CHANNEL PROGRAMMABLE MEMORY WITH SCAN. RETAINS MEMORY WHEN OFF ... **AND** ...
- FULL BAND RANDOM SCAN - UP OR DOWN
- SINGLE STEP SCAN FEATURE IN ANY MODE.
- MEMORY SLOW SCAN
- HOLD AND TRANSMIT AT ANY TIME.
- AUTOMATIC RESUME
- EASY INSTALLATION

\$99⁰⁰

**ACCESSORIES FOR KDK:
 FM2016A AND FM2015R**

- JP 800 - Micro Programmer 99.00
- FMPS-4R Regulated AC Power Supply ... 39.95
- FMFC-1 Touch Tone Microphone 39.95
- FMAT-1 1/4 Wave Portable Antenna
 For Motel, Hotel, or Apt. 7.95
- Extra DC Power Cord & Plug 4.00
- Extra Mounting Bracket 6.00

**NEW CDE HAM IV
 ROTATORS**

Reg. \$189.95

Our Price \$149⁰⁰

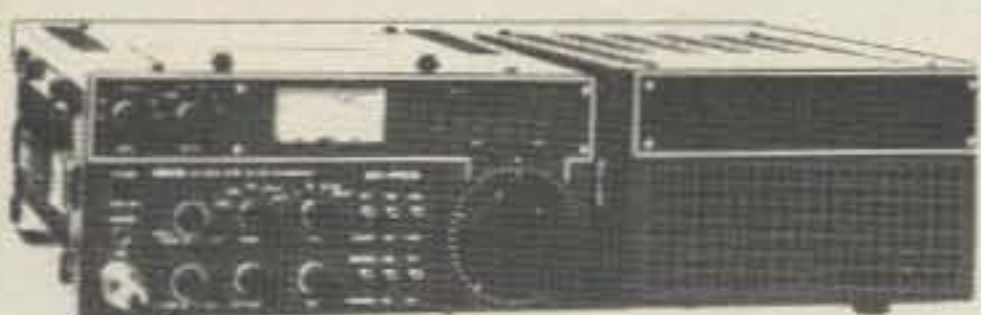

**SUPERB!
 NEW ICOM
 IC-701S
 H.F. XCEIVER**

Please Call or Write for Special Package Price

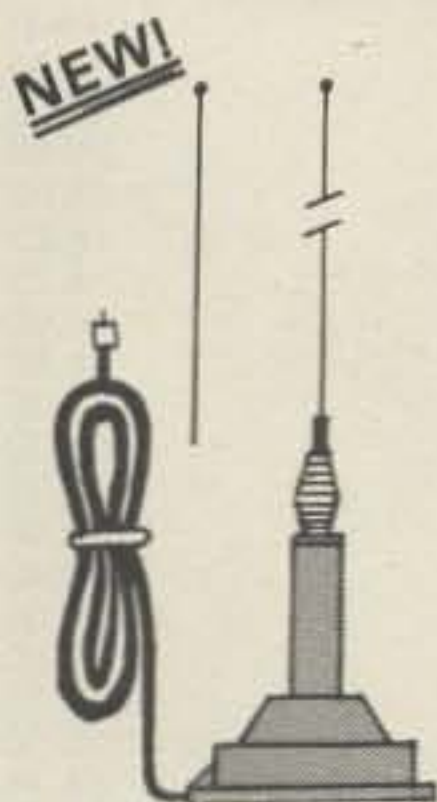

KDK MAX II

TWIN ANTENNA

- SUPER 80 LB. 100 M.P.H. BLACK MAGNETIC MOUNT
- 1/4 WAVE FOR MAX II SIGNAL **AND**
- 1/4 WAVE FOR CLOSE-IN AND RESTRICTED HEIGHT AREAS
- INSTANT CHANGE-OVER
- SUPERIOR PERFORMANCE
- STAINLESS STEEL SPRING AND WHIP, CHROME ON BRASS BASE - COMPARE!
- COMPLETE WITH 17' COAX AND CONNECTOR

\$29⁹⁵

COMPARE!! Nothing Else Does!

**NEW!
 TOWER
 MASTER**

40 foot Self-Supporting Crank-up Mast

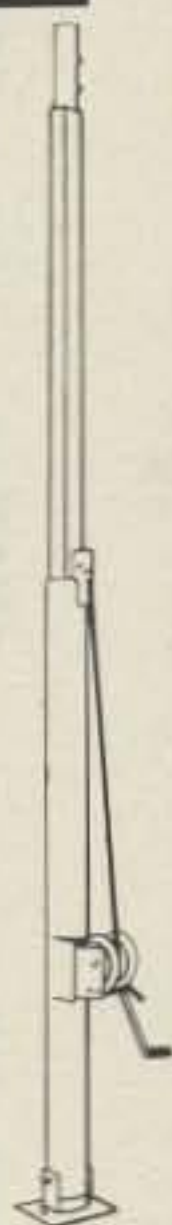

Regular
\$399

COMPLETE With Hinged Mounting Plate And House Bracket

Our Price
\$310

\$29 Shipping Anywhere USA

ORDER NOW TOLL-FREE

Credit Card Holders May Use Our Toll Free Ordering Number

ASK FOR OPERATOR 701

(800) 824-7888

IN CALIFORNIA (800) 852-7777

ALASKA and HAWAII (800) 824-7919

AMATEUR-WHOLESALE ELECTRONICS

8817 S.W. 129 Terr. A21
 Miami, Fla. 33176
 Tel: (305) 233-3631

**SST T-4
 ULTRA TUNER DELUXE**



ULTRA TUNER DELUXE. Matches any antenna—coax fed or random wire on all bands (160-10 meters). Tune out the SWR on your antenna for more efficient operation of any rig. Home, mobile, portable—only 9" x 2 1/2" x 5" • 300 watt RF output capability • SWR meter with 2-color scale • Antenna Switch selects between two coax fed antennas, random wire, or tuner bypass • Efficient Airwound inductor • 208 pf. 1000V. Capacitors • Attractive bronze finished enclosure.

only \$64.95

SST T-2 ULTRA TUNER

Tunes out SWR on any antenna—coax fed or random wire (160-10 meters). Any rig—up to 200 watts RF output. Rugged, yet compact: 5 1/4" x 2 1/4" x 2 1/4".



only \$37.95

**SST T-3 MOBILE
 IMPEDANCE
 TRANSFORMER**

Matches 52 ohm coax to the lower impedance of a mobile whip. Taps between 3 and 50 ohms. 3-30 MHz. 300 watts output. 2 3/4" x 2" x 2 1/4".



only \$19.95

**SST T-1 RANDOM WIRE
 ANTENNA TUNER**

All bands (160-10 m.) with any wire • 200W output • Any transceiver • Home or portable • Neon tune-up indicator.



only \$29.95

SST DL-1 K4RLJ DUMMY LOAD. 1000W PEP 1.5:1 1-225 MHz. Sealed. 3-1/8" x 4-3/8".

only \$17.95

SST CL-1 24 HR. CLOCK. Giant red LED numerals. Month and day also at push of button. Beautiful for your desk. 110VAC.

only \$22.95

SST B-1 BALUN for balanced lines. 300W.

only \$5.00

Call (213) 376-5887 to order C.O.D., VISA, or Master Charge.

To Order:

Send a check or money order—or use your M.C. or VISA. Add \$8 shipping and handling. Calif. residents, add sales tax.

Guarantee: All SST products are unconditionally guaranteed for 1 year. In addition, they may be returned within 10 days for a full refund (less shipping) if you are not satisfied for any reason.

SST ELECTRONICS S10
 P.O. BOX 1 LAWDALE, CALIF.
 90260 (213) 376-5887

Polorad Model 1206
1.95 to 4.20 GHz
signal source
\$400.00
Model 1107 3.8 to 8.20
GHz signal generator
\$550.00

Alfred Model 632D
Sweep signal generator
2-4 GHz \$339.00

TUNNEL DIODES	
TYPE	PRICE
TD261A	\$10.00
TD266A	10.00
1N2930	7.85
1N2939	7.85
1N4395	5.40

AA NICADS
Used/pull out of calculators
79¢ each or \$59.00/100
E.F. Johnson tube socket #122-0275-001
for 3-400Z, 3-500Z, 4-125A, 4-250A, 4-400A
\$29.95/pair

Magic Lantren Model ATR3
2350 MHz down converter and power supply with Bogner antenna
\$299.95
(limited quantity available — may be back ordered)

RF TRANSISTORS

TYPE	PRICE	TYPE	PRICE
2N1561	\$15.00	2N5184	2.00
2N1562	15.00	2N5216	47.50
2N1692	15.00	2N5583	4.43
2N1693	15.00	2N5589	4.60
2N2857JAN	2.45	2N5590	6.30
2N2876	12.35	2N5591	10.35
2N2880	25.00	2N5637	20.70
2N2927	7.00	2N5641	4.90
2N2947	17.25	2N5643	14.38
2N2948	15.50	2N5645	11.00
2N2949	3.90	2N5764	27.00
2N2950	5.00	2N5842	8.65
2N3287	4.30	2N5862	50.00
2N3294	1.15	2N5913	3.25
2N3301	.75	2N5922	10.00
2N3302	1.05	2N5942	46.00
2N3304	1.48	2N5943	1.75
2N3307	10.50	2N5944	7.50
2N3309	3.90	2N5945	10.90
2N3375/MM3375	7.00	2N5946	13.20
2N3553	1.45	2N6080	5.45
2N3818	6.00	2N6081	8.80
2N3866	1.09	2N6082	9.90
2N3866JAN	2.70	2N6083	11.80
2N3866JANTX	4.43	2N6084	13.20
2N3924	3.20	2N6094	5.75
2N3925	6.00	2N6096	19.35
2N3927	11.50	2N6097	28.00
2N3950	26.25	2N6136	18.70
2N4072	1.70	2N6166	36.80
2N4135	2.00	2N6265	75.00
2N4261	14.60	2N6266	100.00
2N4427	1.09	2N6439	43.45
2N4429	7.50	BFR90	3.00
2N4430	20.00	BLY568C	25.00
2N4957	3.50	BLY568CF	25.00
2N4958	2.80	HEP76/S3014	4.95
2N4959	2.12	HEPS3002	11.30
2N4976	19.00	HEPS3003	29.88
2N5090	6.90	HEPS3005	9.95
2N5108	3.90	HEPS3006	19.90
2N5109	1.55	HEPS3007	24.95
2N5160	3.34	HEPS3010	11.34
2N5179	.49	HEPS5026	2.56
		MM1500	32.20
		MM1550	10.00

FETS	
3N128	\$1.00
40673	1.39
MPF102	.45
MPF121	1.00
MPF131	1.00

SPECIALS!	
IN831	\$8.00
IN5711	2.00
IN5712	4.00

MHZ ELECTRONIC KITS:

kit #1
Motorola MC14410CP CMOS Tone Generator
CMOS Tone Generator uses 1MHZ crystal to produce standard dual frequency dialing signal. Directly compatible with 12 key Chomeric Touch Tone Pads. Kit includes the following:
1 Motorola MC14410CP Chip
1 PC Board
And all other parts for assembly with 1 MHz crystal
NOW ONLY \$15.70
\$20.65

Kit #2
Fairchild 95H90DC Prescaler 350MHZ.
95H90DC Prescaler divides by 10 to 350 MHZ. This kit will take any 35MHZ Counter to 350 MHZ. Kit includes the following:
1 Fairchild 95H90DC Chip
1 2N5179 Transistor
2 UG-88/U BNC Connectors
1 PC Board
And all other parts for assembly.
NOW ONLY \$19.95

FAIRCHILD VHF AND UHF PRESCALER CHIPS

95H90DC	350MHZ Prescaler Divide by 10/11	\$ 9.50
95H91DC	350MHZ Prescaler Divide by 5/6	8.95
11C90DC	650MHZ Prescaler Divide by 10/11	16.50
11C91DC	650MHZ Prescaler Divide by 5/6	15.95
11C83DC	1GHZ Divide by 248/256 Prescaler	29.90
11C70DC	600MHZ Flip/Flop with reset	12.30
11C58DC	ECL VCM	4.53
11C44DC	Phase Frequency Detector (MC4044P/L)	3.82
11C24DC	Dual TTL VCM (MC4024P/L)	3.82
11C06DC	UHF Prescaler 750MHZ D Type Flip/Flop	12.30
11C05DC	1GHZ Counter Divide by 4	74.35
11C01FC	High Speed Dual 5-4 Input NO/NOR Gate	15.40

CRYSTAL FILTERS: Tycos 001-19880 same as 2194F

10.7MHZ Narrow Band Crystal Filter
3 db bandwidth 15khz minimum 20 db bandwidth 60khz minimum 40 db bandwidth 150khz minimum. Ultimate 50 db; Insertion loss 1.0db Max. Ripple 1.0db Max. Ct. 0 + - 5pf. Rt. 3600 Ohms.
NOW ONLY \$5.95

TUBES

2E28	\$5.00	4CX1500B	\$285.00
3-500Z	90.00	4X150A	37.00
3-1000Z	225.00	4X150G	70.00
3B28	5.00	100TH	144.00
4.85A	54.50	572B	33.60
4-125A	88.75	811A	12.95
4-250A	80.00	813	29.00
4-400A	81.50	589A	39.00
4-1000A	255.00	6146A	5.25
5-500A	145.00	6146B	6.25
4CX250B	38.50	6159	10.60
4CX250F	53.50	6293	18.50
4CX250G	53.50	6360	7.95
4CX250K	72.00	6907	35.00
4CX250R	48.00	6939	9.95
4CX350A	60.00	7360	10.60
4CX350FJ	70.00	7984	10.40
4CX1000A	289.00	8072	45.00
		8156	7.85
		8226	127.70
		8295A/PL172	328.00
		8458	25.75
		8560AS	50.00
		8950	5.95

SONALERT Model SL628P

6-28 volts DC
3-14 ma
\$5.95

1 MHz TCXO Crystal Oscillator
TTL output
3.3 volts DC
\$19.95

TERMS:
ALL CHECKS and MONEY ORDERS ARE IN US FUNDS!
ALL ORDERS SENT FIRST CLASS OR UPS.
Please include \$1.50 Minimum for postage.
ALL PRICES ARE IN US DOLLARS.
ALL PARTS PRIME/GUARANTEED.

MHz
electronics

✓ M8

(602) 242-3037

2111 W. Camelback
Phoenix, Arizona 85015

BANK AMERICARD/VISA/MASTERCHARGE

Your Number:
(or equivalent)

Exp. Date

Your Signature:

MURATA CERAMIC FILTERS

Model SFD-455D
455 kHz \$3.00
Model SFB-455D
455 kHz \$2.00
Type: CFM-455E 455 kHz \$7.95
Type: SFE-10.7 10.7 MHz \$5.95

TEKTRONIX
585A Oscilloscope
with 82 dual trace plug-in
DC-100 MHz \$800.00

HEWLETT PACKARD
Model 140A Oscilloscope
W/1402A, 1400A \$495.00
(also available 1415A \$300)

TEKTRONIX
IL30 Spectrum Analyzer plug-in
925MHz-10.25GHz \$899.00

HEWLETT PACKARD UHF, VHF, AND MICROWAVE SIGNAL GENERATORS AND SWEEPERS, AND OTHER EQUIPMENT

MODEL 434A
Calorimetric power meter
\$450.00

MODEL 416A
Ratio meter
\$125.00

MODEL 413AR
DC null voltmeter
\$112.50

MODEL 400DR
Vacuum tube voltmeter
\$79.95

MODEL 616B/A
1.8 to 4.2 GHz
only \$399.00

MODEL 618B
3.8 to 7.6 GHz
only \$499.99
A Model \$299.00

MODEL 606A
50 kHz to 65 MHz
.1mV to 3V into 50 ohms
\$1,000.00

MODEL 683C
2 to 4 GHz
ONLY \$299.00

MODEL 612A
450 to 1230 MHz
.1uv to .5uv into 50 ohms
ONLY \$499.99

MODEL TS510/U HP608D
10 MHz to 420 MHz
.1V to .5V
\$399.95

MODEL 620A
7 to 11 GHz
.223V to 1uv.
\$699.99

302A with a 297A
Wave Analyzer and Sweep Drive
20 HZ to 50 kHz
\$799.00

WISPER FANS

This fan is super quiet, efficient cooling where low acoustical disturbance is a must.
Size 4.68" x 4.68" x 1.50", Impedance protected, 50/60 Hz 120 volts AC
ONLY \$9.95 or 2/\$18.00

TRW BROADBAND AMPLIFIER MODEL CA815B

Frequency response 40 to 300 MHz
Gain

300 MHz 16dB MIN.
17.5dB MAX.
50 MHz 0 to -1dB from 300 MHz
24 volts DC at 220ma MAX

Voltage

ONLY \$14.95

CIRCUIT BOARD DRILL BITS

Size	Price	Size	Price
35	\$2.15	58	\$1.85
42	\$2.15	59	\$1.85
47	\$2.15	60	\$1.85
49	\$2.15	61	\$1.85
50	\$2.15	62	\$1.85
51	\$2.15	63	\$1.85
52	\$2.15	64	\$1.85
53	\$1.85	65	\$1.85
54	\$1.85	66	\$1.90
55	\$1.85	1.25 mm	\$1.85
56	\$1.85	1.45 mm	\$1.85
57	\$1.85	3.20 mm	\$3.58

INTEGRATED CIRCUITS

MC1303L	\$ 2.00	MC1460R	\$ 5.40
MC1461R	6.90	MC1463R	5.15
MC1469G	2.05	MC1469R	3.55
MC1550G	1.50	MC1560G	10.20
MC1560R	12.40	MC1563R	10.00
MC1568G	5.31	MC1568L	5.00
MC1569R	8.15	MC1590G	6.50
MC4024P	3.82	MC6800P	9.95
MC6820P	6.95	MC68B21P	12.00
2513	6.95	4116-200NS	10.37
8080A	3.95	TMS4060	6.95
2708T1	8.95	TMS4024	13.90
2716T1	29.95	1702A	4.95

19.2 KC

31.5
37.35
49.710
70
81.9
96
225
250
285.714
576
720
1.0000MC
1.2288
1.3047
1.4
1.455
1.689600
1.7
1.76375
1.77125
1.773125
1.78675
1.80224
1.81875
1.845125
1.84375
1.845625
1.84575
1.846
1.8425
1.84975
1.8575
1.908125
1.925
1.927
1.932
1.982
1.985
1.9942
1.995975
1.964750
2.0000
2.0285
2.05975
2.126175
2.12795
2.1315
2.133275
2.13505
2.136825
2.1425
2.144625
2.14675
2.148875
2.151
2.153125
2.15375
2.155
2.15525
2.157375
2.1595
2.16375
2.165875
2.170125
2.17225
2.174375
2.1765
2.17925
2.18475
2.18575
2.194125
2.207063
2.208313
2.209563
2.210812
2.210813
2.212063
2.214562
2.214563
2.215625
2.217938
2.21975
2.222125
2.22325
2.22675
2.22875
2.23725

2.2395 MC
2.24075
2.241
2.246
2.2475
2.2925
2.2975
2.320
2.326
2.32625
2.32885
2.3525
2.35256
2.368
2.374
2.375
2.38725
2.395
2.396875
2.42
2.4375
2.44275
2.4495
2.45
2.4585
2.46125
2.482
2.486
2.5
2.51375
2.56
2.581
2.604
2.6245
2.618
2.62825
2.633125
2.639
2.63575
2.64325
2.646
2.647
2.650750
2.6545
2.65825
2.660
2.662
2.66575
2.6695
2.677
2.68075
2.681
2.6845
2.68825
2.69575
2.7
2.702
2.704
2.71075
2.715
2.716
2.723
2.730
2.7315
2.73225
2.732625
2.733
2.737
2.73975
2.742125
2.7425
2.744
2.7445
2.74475
2.746875
2.751
2.754
2.75525
2.762375
2.7735
2.776625
2.78
2.814
2.817
2.8225
2.835
2.85

ALL CRYSTALS \$4.95

2.854 MC
2.854285
2.865
2.868
2.8725
2.876875
2.887
2.889
2.894
2.910
2.920
2.925450
2.92545
2.931
2.94375
2.945
2.94675
2.952
2.966
2.973
2.980
2.981
2.98325
2.987
2.9989
3.001
3.0235
3.045
3.049
3.053
3.062
3.067
3.074
3.1125
3.126
3.137
3.13975
3.1435
3.144
3.145
3.151
3.1545
3.158
3.1585
3.1615
3.1625
3.166
3.16975
3.177
3.181
3.1825
3.18475
3.1885
3.2035
3.20725
3.2105
3.2165
3.2175
3.2315
3.23275
3.2365
3.23775
3.23775
3.2385
3.238875
3.23925
3.24
3.24025
3.2405
3.241
3.2425
3.244
3.248875
3.24975
3.4975
3.2515
3.255
3.256125
3.258625
3.261
3.261125
3.268625
3.271125
3.273625
3.276125
3.3
3.3345

20.1MC

21.99965
22.
23.25
23.575
25.47667
25.9
25.99961
26.66667
26.8965
26.9
26.958
27.77778
27.9
28.728
28.88889
28.9
28.93888
29.896
29.9
30.0000
30.9
31.0000
31.11111
31.66667
31.9
32.0000
32.22222
32.9
33.0000
33.33333
33.9
34.0000
34.4444
34.44444
35.0000
35.25000
35.55555
36.0000
36.21750
36.66667
37.00000
37.2175
37.385
37.460
37.77777
38.00000
38.33333
38.77777
38.88888
38.88889
39.00000
39.160
40.00000
41.11111
41.66666
43.33333
45.
47.48
49.84166
49.95
53.45
54.95
57.45
59.45
60.45
61.95
63.80833
66.66667
72.855
75.185
76.66667
82.75
83.
84.
85.833330
90.833
93.1346
93.535
93.9353
94.3
95.
95.35
100.0
106.850
123.5
146.64
147.09
165.5

Prices are subject to change. Some items are in limited quantity.



FREQUENCY COUNTER KIT

Outstanding Performance

Incredible Price

\$89⁹⁵

CT-50

The CT-50 is a versatile and precision frequency counter which will measure frequencies to 60 MHz and up to 600 MHz with the CT-600 option. Large Scale Integration, CMOS circuitry and solid state display technology have enabled this counter to match performance found in units selling for over three times as much. Low power consumption (typically 300-400 ma) makes the CT-50 ideal for portable battery operation. Features of the CT-50 include large 8 digit LED display, RF shielded all metal case, easy pushbutton operation, automatic decimal point, fully socketed IC chips and input protection to 50 volts to insure against accidental burnout or overload. And, the best feature of all is the easy assembly. Clear, step by step instructions guide you to a finished unit you can rely on.

Order your today!

CT-50, 60 MHz counter kit
 CT-50WT, 60 MHz counter, wired and tested
 CT-600, 600 MHz scaler option, add

\$89.95
159.95
29.95

CB-1, Color TV calibrator-stabilizer
 DP-1, DC probe, general purpose probe
 HP-1, High impedance probe, non-loadin

\$14.95
12.95
15.95

SPECIFICATIONS:

Frequency range: 6 Hz to 65 MHz, 600 MHz with CT-600
 Resolution: 10 Hz @ 0.1 sec gate, 1 Hz @ 1 sec gate
 Readout: 8 digit, 0.4" high LED, direct readout in MHz
 Accuracy: adjustable to 0.5 ppm
 Stability: 2.0 ppm over 10° to 40° C, temperature compensated
 Input: BNC, 1 megohm/20 pf direct, 50 ohm with CT-600
 Overload: 50VAC maximum, all modes
 Sensitivity: less than 25 mv to 65 MHz, 50-150 mv to 600 MHz
 Power: 110 VAC 5 Watts or 12 VDC @ 400 ma
 Size: 6" x 4" x 2", high quality aluminum case, 2 lbs
 ICS: 13 units, all socketed

CAR CLOCK

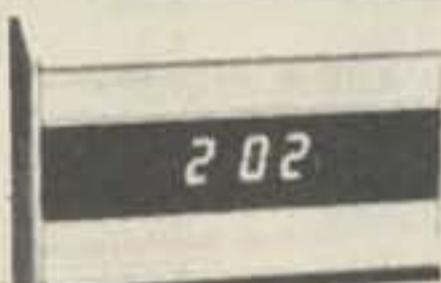

The UN-KIT, only 5 solder connections

Here's a super looking, rugged and accurate auto clock, which is a snap to build and install. Clock movement is completely assembled—you only solder 3 wires and 2 switches, takes about 15 minutes! Display is bright green with automatic brightness control photocell—assures you of a highly readable display, day or night. Comes in a satin finish anodized aluminum case which can be attached 5 different ways using 2 sided tape. Choice of silver, black or gold case (specify).

DC-3 kit, 12 hour format **\$22.95**
 DC-3 wired and tested **\$29.95**
 110V AC adapter **\$5.95**

Under dash car clock



12/24 hour clock in a beautiful plastic case features, 6 jumbo RED LEDs, high accuracy (1 min/mo), easy 3 wire hookup, display blanks with ignition, and super instructions. Optional dimmer automatically adjusts display to ambient light level.

DC-11 clock with mtg bracket **\$27.95**
 DM-1 dimmer adapter **2.50**

PRESCALER



Extend the range of your counter to 600 MHz. Works with any counter. Includes 2 transistor pre-amp to give super sens, typically 20 mv at 150 MHz. Specify -10 or +100 ratio.

PS-1B, 600 MHz prescaler **\$59.95**
 PS-1BK, 600 MHz prescaler kit **49.95**

OP-AMP SPECIAL

741 mini dip **12/\$2.00**
 B1-FET mini dip, 741 type **10/\$2.00**

VIDEO TERMINAL

A completely self-contained, stand alone video terminal card. Requires only an ASCII keyboard and TV set to become a complete terminal unit. Two units available, common features are: single 5V supply, XTAL controlled sync and baud rates (to 9600), complete computer and keyboard control of cursor. Parity error control and display. Accepts and generates serial ASCII plus parallel keyboard input. The 3216 is 32 char. by 16 lines, 2 pages with memory dump feature. The 6416 is 64 char. by 16 lines, with scrolling, upper and lower case (optional) and has RS-232 and 20ma loop interfaces on board. Kits include sockets and complete documentation.

RE 3216, terminal card **\$149.95**
 RE 6416, terminal card **189.95**
 Lower Case option, 6416 only **13.95**
 Power Supply Kit **14.95**
 Video/RF Modulator, VD-1 **6.95**
 Assembled, tested units, add **60.00**

CALENDAR ALARM CLOCK

The clock that's got it all; 6-5" LEDs, 12/24 hour, snooze, 24 hour alarm, 4 year calendar, battery backup, and lots more. The super 7001 chip is used. Size: 5x4x2 inches.

Complete kit, less case (not available) **\$34.95**
 DC-9

30 Watt 2 mtr PWR AMP

Simple Class C power amp features 8 times power gain. 1 W in for 8 out, 2 in for 15 out, 4 W in for 30 out. Max. output of 35 W, incredible value, complete with all parts, less case and T-R relay.

PA-1, 30 W pwr amp kit **\$22.95**
 TR-1, RF sensed T-R relay kit **6.95**

FM MINI MIKE KIT



A super high performance FM wireless mike kit! Transmits a stable signal up to 300 yards with exceptional audio quality by means of its built in electret mike. Kit includes case, mike, on-off switch, antenna, battery and super instructions. This is the finest unit available.

FM-3 kit **\$12.95**
 FM-3 wired and tested **16.95**

CLOCK KITS



our Best Seller
 your Best Deal

Try your hand at building the finest looking clock on the market. Its satin finish anodized aluminum case looks great anywhere, while six 4" LED digits provide a highly readable display. This is a complete kit, no extras needed, and it only takes 1-2 hours to assemble. Your choice of case colors: silver, gold, bronze, black, blue (specify).

Clock kit, 12/24 hour, DC-5 **\$22.95**
 Clock with 10 min. ID timer, 12/24 hour, DC-10 **27.95**
 Alarm clock, 12 hour only, DC-8 **24.95**
 12V DC car clock, DC-7 **27.95**
 For wired and tested clocks add \$10.00 to kit price.

Hard to find PARTS

LINEAR ICs		REGULATORS	
301	\$ 35	78MG	\$1.25
324	1.50	723	50
380	1.25	309K	85
380-8	75	7805	85
555	45	78L05	25
556	85	7905	1.25
566	1.15	7812	85
567	1.25	7912	1.25
1458	50	7815	85
3900	50	TTL ICs	
CMOS ICs		74500	35
4011	20	7447	65
4013	35	7475	50
4046	1.85	7490	50
4049	40	74196TI	1.35
4518	1.25	SPECIAL ICs	
5369	1.75	11C90	13.50
TRANSISTORS		1011B	1.25
2N3904 type	10/1.00	4511	2.00
2N3906 type	10/1.00	5314	2.95
NPN 30W Pwr	3/1.00	5375AB	2.95
PNP 30W Pwr	3/1.00	7001	6.50
2N3055	60	4059 + N	9.00
UJT 2N2646 type	3/2.00	7208	17.95
FET MPF 102 type	3/2.00	LEDs	
UHF 2N5179 type	3/2.00	Jumbo red	8/1.00
MRF-238 RF	11.95	Jumbo green	6/1.00
SOCKETS		Jumbo yellow	6/1.00
8 pin	10/2.00	Mini red	8/1.00
14 pin	10/2.00	Micro red	8/1.00
16 pin	10/2.00	BiPolar	75
24 pin	4/2.00	FERRITE BEADS	
28 pin	4/2.00	With info, specs	15/1.00
40 pin	3/2.00	6 hole balun	5/1.00

Ramsey's famous MINI-KITS

FM WIRELESS MIKE KIT

Transmits up to 300' to any FM broadcast radio, uses any type of mike. Runs on 3 to 9V. Type FM-2 has added sensitive mike preamp stage.
 FM-1 kit **\$2.95** FM-2 kit **\$4.95**



VIDEO MODULATOR KIT

Converts any TV to video monitor. Super stable, tunable over ch. 4-6. Runs on 5-15V, accepts std. video signal. Best unit on the market!
 Complete kit, VD-1 **\$6.95**

TONE DECODER

A complete tone decoder on a single PC board. Features: 400-5000 Hz adjustable range via 20 turn pot, voltage regulation, 567 IC. Useful for touch-tone decoding, tone burst detection, FSK, etc. Can also be used as a stable tone encoder. Runs on 5 to 12 volts.
 Complete kit, TD-1 **\$5.95**



SUPER SLEUTH

A super sensitive amplifier which will pick up a pin drop at 15 feet! Great for monitoring baby's room or as general purpose amplifier. Full 2 W rms output, runs on 6 to 15 volts, uses 8-45 ohm speaker.
 Complete kit, BN-9 **\$5.95**



POWER SUPPLY KIT

Complete triple regulated power supply provides variable -6 to 18 volts at 200 ma and +5V at 1 Amp. Excellent load regulation, good filtering and small size. Less transformers, requires 6.3V @ 1 A and 24 VCT.
 Complete kit, PS-3LT **\$6.95**



COLOR ORGAN/MUSIC LIGHTS

See music come alive! 3 different lights flicker with music. One light for lows, one for the mid-range and one for the highs. Each channel individually adjustable, and drives up to 300W. Great for parties, band music, nite clubs and more.
 Complete kit, ML-1 **\$7.95**

LED BLINKY KIT

A great attention getter which alternately flashes 2 jumbo LEDs. Use for name badges, buttons, warning panel lights, anything! Runs on 3 to 15 volts.
 Complete kit, BL-1 **\$2.95**

WHISPER LIGHT KIT

An interesting kit, small mike picks up sounds and converts them to light. The louder the sound the brighter the light. Completely self-contained, includes mike, runs on 110VAC, controls up to 300 watts.
 Complete kit, WL-1 **\$6.95**

SIREN KIT

Produces upward and downward wail characteristic of a police siren. 5W peak audio output, runs on 3-15 volts, uses 3-45 ohm speaker.
 Complete kit, SM-3 **\$2.95**

ramsey electronics

BOX 4072, ROCHESTER, N.Y. 14610

PHONE ORDERS CALL
 (716) 271-6487

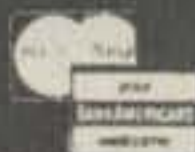

TERMS: Satisfaction guaranteed or money refunded. COD, add \$1.50. Minimum order, \$6.00. Orders under \$10.00, add \$ 75. Add 5% for postage, insurance, handling. Overseas, add 15%. NY residents, add 7% tax.

These Low Cost SSB TRANSMITTING CONVERTERS

Let you use inexpensive recycled 10 or 11 meter SSB exciters on VHF!

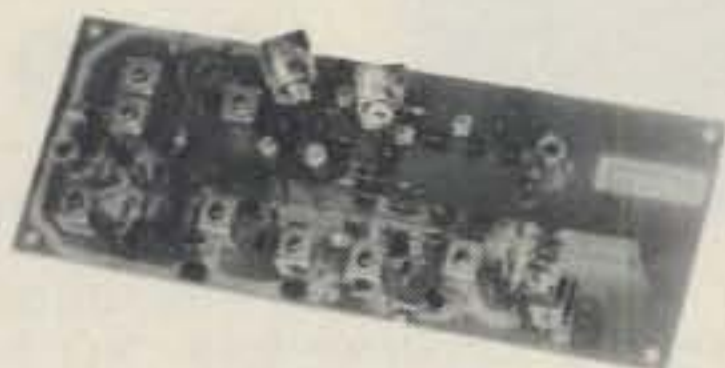

- Linear Converter for SSB, CW, FM, etc.
- A fraction of the price of other units
- 2W p.e.p. output with 1 mW drive
- Use low power tap on exciter or attenuator pad
- Easy to align with built-in test points
- Link with VHF RX converter for transceiver

KIT ONLY \$69.95

MODEL	INPUT (MHz)	OUTPUT (MHz)
XV2-1	28-30	50-52
XV2-2	28-30	220-222
XV2-3	28-30 (26-28)	222-224 (220-222)
XV2-4	28-30	144-146
XV2-5	28-30	145-147
XV2-6	26-28	144-146
XV2-7	144-146	50-52
XV2-8	144-146	220-222

FAMOUS HAMTRONICS PREAMPS

Let you hear the weak ones too!
Great for OSCAR, SSB, FM, ATV. Over 14,000 in use throughout the world on all types of receivers.

P9 Kit \$12.95
P14 Wired \$24.95
Specify band when ordering



- Deluxe vhf model for applications where space permits ● 1½" x 3" ● Models available to cover any 4 MHz band in the 26 to 230 MHz range ● 12 Vdc ● 2 stages ● Ideal for OSCAR ● 20 dB gain

P8 Kit \$10.95
Specify band when ordering

- Miniature vhf model for tight spaces—size only ½ x 2 ½" ● Models available to cover any 4 MHz band in the range 20 to 230 MHz ● 20 db gain ● 12 Vdc

P15 Kit \$18.95
P35 Wired \$34.95



- Covers any 6 MHz band in UHF range of 380 to 520 MHz ● 20 dB gain ● 2 stages ● 12 Vdc

Easy to Build FET RECEIVING CONVERTERS

Let you receive OSCAR and other exciting VHF and UHF signals on your present HF or 2M receiver

VHF KIT STILL ONLY \$34.95



MODEL	RF RANGE	OUTPUT RANGE
C28	28-32 MHz	144-148
C50	50-52	28-30
C50-2	50-52	144-146
C144	144-146	28-30
C145	145-147	28-30
C146	146-148	28-30
C146	144-146	26-28
C220	220-222	28-30
C220-2	220-222	144-146
C110	Any 2 MHz of Aircraft Band	26-28 or 28-30
C110-ELT	121.5 (121.6)	CB Chan 9 (17)



UHF KIT ONLY \$34.95

MODEL	RF RANGE	OUTPUT RANGE
C432-2	432-434	28-30
C432-5	435-437	28-30
C432-4	432-436	144-148
C432-7	427.25	61.25
C432-9	439.25	61.25

Professional Quality VHF/UHF FM/CW EXCITERS

- Fully shielded designs
- Double tuned circuits for spurious suppression
- Easy to align with built-in test aids



T50-50	6-chan, 6M, 2W Kit	\$49.95
T50-150	6-chan, 2M, 2W Kit	\$49.95
T50-220	6-chan, 220 MHz, 1½W Kit	\$49.95
T40/T20	11-chan, 450 MHz, 200mW Kit	\$49.95

See our Complete Line of VHF & UHF Linear PA's

- Use as linear or class C PA
 - For use with SSB Xmtg Converters, FM Exciters, etc.
- | | | |
|----------|--|----------|
| LPA 2-15 | VHF PA, 2W in/15-20W out. Solid-state t/r switching. Kit only | \$59.95 |
| LPA 2-45 | VHF PA, 2W in/40-45W out. Can also be used with 8-10W drive. Kit price | \$109.95 |
| LPA 4-10 | UHF PA, 200-500mW in/6-10W out. Kit price only | \$79.95 |

New R75 One Channel VHF FM RECEIVER

Offers Unprecedented Range of Selectivity Options!

- New generation
- More sensitive
- More selective
- Uses crystal filters
- Smaller
- Easy to align

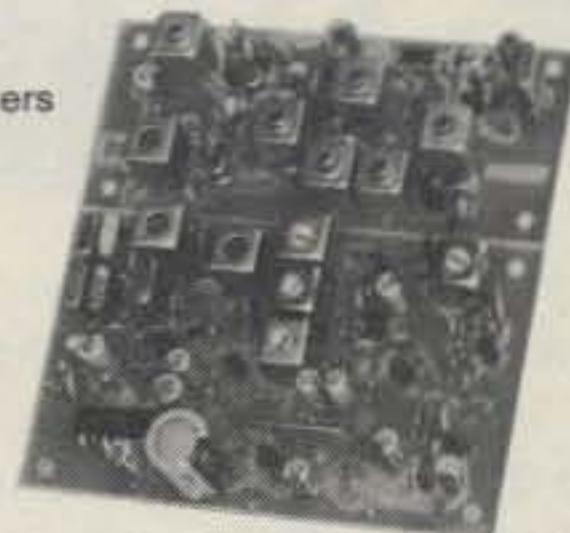

- R75A** Kit for monitor or weather satellite service. -60dB at ± 30 KHz.....\$69.95
- R75B** Kit for normal nbm service. -60dB at ±17KHz, -80dB at ± 25 KHz.....\$74.95
- R75C** Kit for repeater service. -60dB at ± 14 KHz, -80dB at ± 22 KHz.....\$84.95
- R75D** Kit for split channel operation. Uses 8 pole crystal filter! -60dB at ± 9 KHz, -100dB at ± 15 KHz... \$99.95

Specify band: 10M, 6M, 2M, or 220 MHz. May also be used on adjacent commercial bands. Use 2M version for 137MHz WX satellite.

HAMTRONICS SIX CHANNEL VHF & UHF FM RECEIVERS

In use by the hundreds throughout the world. Unlimited applications.

- Commercial grade design
- Easy to build & align
- 70 or 100dB selectivity options
- Low system cost
- Compartmentized shielding

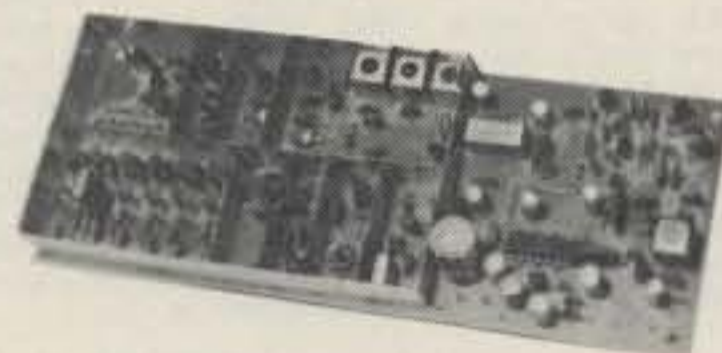

- R70** VHF Receiver kit for 10M, 6M, 2M, 220 MHz or adjacent commercial bands.....\$74.95
- Optional xtal filter for 100dB adjacent channel... \$10.00



- R90** UHF Receiver kit for any 2MHz segment of 380 to 520 MHz band.....\$89.95

IT'S EASY TO ORDER!

- Write or phone 716-392-9430 (Electronic answering service evenings & weekends)
- Use Credit Card, UPS COD, Check, Money Order
- Add \$2.00 shipping & handling per order

Call or Write to Get **FREE 1979 CATALOG** With Complete Details

(Send 4 IRC's for overseas mailing)

hamtronics, inc.

65A MOUL RD · HILTON, NY 14468

DEALER INQUIRIES INVITED

16K EPROM CARD-S 100 BUSS

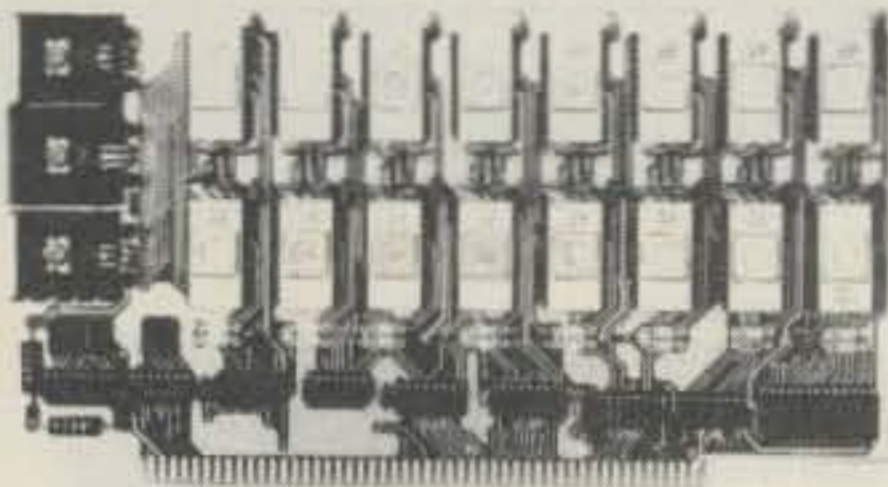

\$59.95
KIT

OUR
BEST
SELLING
KIT!

USES 2708's!

Thousands of personal and business systems around the world use this board with complete satisfaction. Puts 16K of software on line at **ALL TIMES!** Kit features a top quality soldermasked and silk-screened PC board and first run parts and sockets. All parts (except 2708's) are included. Any number of EPROM locations may be disabled to avoid any memory conflicts. Fully buffered and has WAIT STATE capabilities.

OUR 450NS 2708'S
ARE \$8.95 EA. WITH
PURCHASE OF KIT

ASSEMBLED
AND FULLY TESTED
ADD \$25

8K LOW POWER RAM KIT-S 100 BUSS 250 NS SALE!

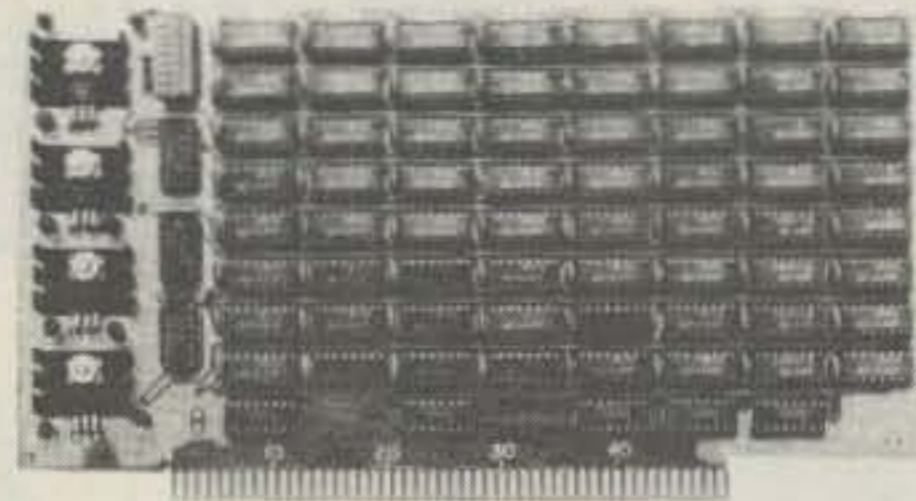

ADD \$5
FOR
250NS!

\$129 KIT

(450 NS RAMS!)

Thousands of computer systems rely on this rugged, work horse, RAM board. Designed for error-free, NO HASSLE, systems use.

KIT FEATURES:

1. Doubled sided PC Board with solder mask and silk screen layout. Gold plated contact fingers.
2. All sockets included.
3. Fully buffered on all address and data lines.
4. Phantom is jumper selectable to pin 67.
5. FOUR 7805 regulators are provided on card.

Blank PC Board w/Documentation
\$29.95
Low Profile Socket Set...**13.50**
Support IC's (TTL & Regulators)
\$9.75
Bypass CAP's (Disc & Tantalums)
\$4.50

ASSEMBLED AND FULLY
BURNED IN ADD \$30

16K STATIC RAM KIT-S 100 BUSS

\$279 KIT

PRICE CUT!

FULLY
STATIC, AT
DYNAMIC PRICES

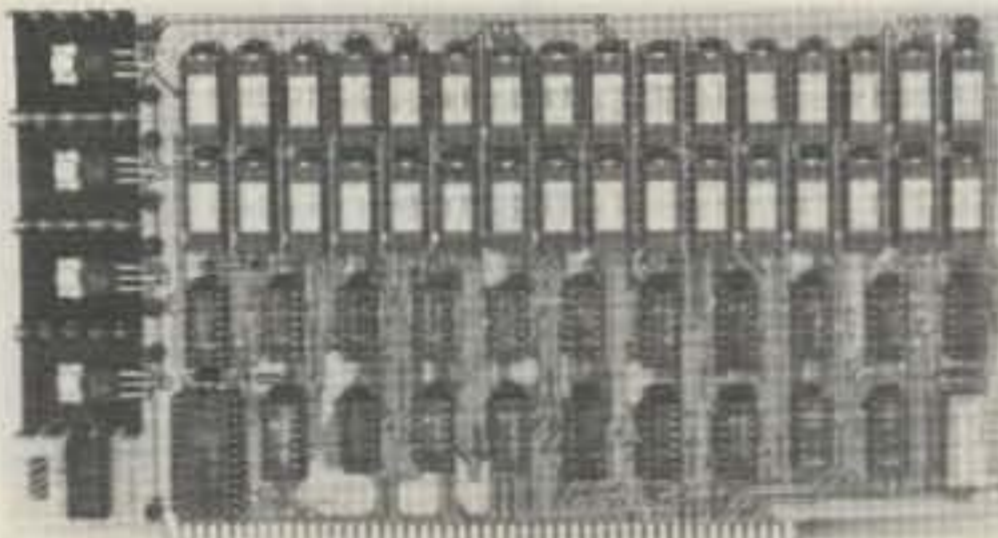

WHY THE 2114 RAM CHIP?

We feel the 2114 will be the next industry standard RAM chip (like the 2102 was). This means price, availability, and quality will all be good! Next, the 2114 is FULLY STATIC! We feel this is the **ONLY** way to go on the S-100 Bus! We've all heard the HORROR stories about some Dynamic Ram Boards having trouble with DMA and FLOPPY DISC DRIVES. Who needs these kinds of problems? And finally, even among other 4K Static RAM's the 2114 stands out! Not all 4K static Rams are created equal! Some of the other 4K's have clocked chip enable lines and various timing windows just as critical as Dynamic RAM's. Some of our competitor's 16K boards use these "tricky" devices. But not us! The 2114 is the **ONLY** logical choice for a trouble-free, straightforward design.

KIT FEATURES:

1. Addressable as four separate 4K Blocks.
2. ON BOARD BANK SELECT circuitry. (Cromemco Standard!). Allows up to 512K on line!
3. Uses 2114 (450NS) 4K Static Rams.
4. ON BOARD SELECTABLE WAIT STATES.
5. Double sided PC Board, with solder mask and silk screened layout. Gold plated contact fingers.
6. All address and data lines fully buffered.
7. Kit includes ALL parts and sockets.
8. PHANTOM is jumpered to PIN 67.
9. LOW POWER: under 2 amps TYPICAL from the +8 Volt Buss.
10. Blank PC Board can be populated as any multiple of 4K.

BLANK PC BOARD W/DATA—\$33

LOW PROFILE SOCKET SET—\$12
SUPPORT IC'S & CAPS—\$19.95

ASSEMBLED & TESTED—ADD \$30
2114 RAM'S—8 FOR \$69.95

16K STATIC RAM SS-50 BUSS

\$295 KIT

FULLY STATIC
AT DYNAMIC PRICES

KIT FEATURES:

1. Addressable on 16K Boundaries
2. Uses 2114 Static Ram
3. Runs at Full Speed
4. Double sided PC Board. Solder mask and silk screened layout. Gold fingers.
5. All Parts and Sockets included
6. Low Power: Under 2 Amps Typical

FOR SWTPC
6800 BUSS!

ASSEMBLED AND
TESTED - \$30

BLANK PC BOARD—\$33

COMPLETE SOCKET SET—\$12
SUPPORT IC'S AND CAPS—\$19.95

NEW! G.I. COMPUTER SOUND CHIP

AY3-8910. As featured in July, 1979 BYTE! A fantastically powerful Sound & Music Generator. Perfect for use with any 8 Bit Microprocessor. Contains: 3 Tone Channel, Noise Generator, 3 Channels of Amplitude Control, 16 Bit Envelope Period Control, 2-8 Bit Parallel I/O, 3 D to A Converters, plus much more! All in one 40 Pin DIP. Super easy to interface to the S-100 or other busses.

SPECIAL OFFER: \$14.95 each Add \$3 for 64 page Data Manual.
Initial stock very limited: FIRST COME FIRST SERVED!

Z-80 PROGRAMMING MANUAL

By MOSTEK, or ZILOG. The most detailed explanation ever on the working of the Z-80 CPU CHIPS. At least one full page on each of the 158 Z-80 instructions. A **MUST** reference manual for any user of the Z-80. 300 pages. Just off the press.

\$12.95

PROC. TECH. QUILTS THE MICROPROCESSOR BUSINESS!

FACTORY CLOSE OUT - SPECIAL PURCHASE!

#16KRA

16K S-100 Dynamic Ram Board - \$149.⁹⁵

ORIGINALLY PRICED AT \$429 each!

We purchased the remaining inventory of PT's popular 16K Ram Board when they recently closed their plant. Don't miss the boat! These are brand new, fully tested, ASSEMBLED and ready to go. All are sold with our standard 90 day limited warranty!!

72 Page Full Manual, Included Free!

NOT ASSOCIATED WITH DIGITAL RESEARCH OF CALIFORNIA, THE SUPPLIERS OF CPM SOFTWARE.

Digital Research: Computers
(OF TEXAS)

P.O. Box 401565 • GARLAND, TEXAS 75040 • (214) 271-2461

TERMS: Add 50¢ postage, we pay balance. Orders under \$15 add 75¢ handling. No C.O.D. We accept Visa, MasterCard, and American Express cards. Tex. Res. add 5% Tax. Foreign orders (except Canada add 20% P & H. 90 Day Money Back Guarantee on all items.

NATIONAL SEMICONDUCTOR

NEW!

CAR CLOCK MODULE - #MA6008

\$6⁹⁹ each

Originally used by HYGAIN to indicate time and channel on an expensive C.B. Mini size, self contained module. Not a Kit. Four digits plus flashing indicator for seconds. Includes MM5369 and 3.58 MHZ crystal for super accurate time base. With hookup data.

**INCLUDES CRYSTAL TIMEBASE!
WORKS ON 12 VDC!**

**MFGR'S CLOSEOUT
LIMITED QTY.**

NATIONAL SEMICONDUCTOR

MILITARY TIME FORMAT!

JUMBO CLOCK MODULE

**MA1008D
BRAND NEW!**

ASSEMBLED,
NOT A KIT!

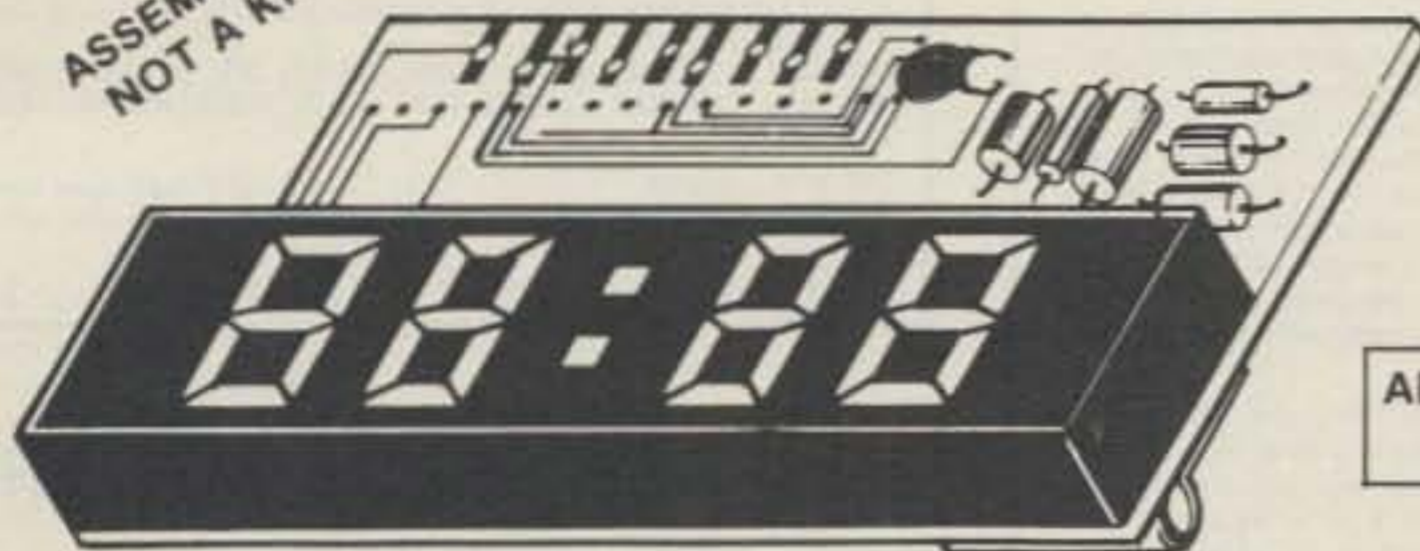

\$4⁹⁵
REG. \$9.95

ADD \$1.95 FOR
AC XFMR

FEATURES:

- ★ FOUR JUMBO 1/2 INCH LED DISPLAYS
- ★ 24 HR REAL TIME FORMAT
- ★ 24 HR ALARM SIGNAL OUTPUT
- ★ 50 OR 60 Hz OPERATION
- ★ LED BRIGHTNESS CONTROL
- ★ POWER FAILURE INDICATOR
- ★ SLEEP & SNOOZE TIMERS
- ★ DIRECT LED DRIVE (LOW RFI)
- ★ COMES WITH FULL DATA

ZULU

50% OFF SALE!

PERFECT FOR USE
WITH A TIMEBASE.

**COMPARE AT UP TO TWICE
OUR PRICE!**

MANUFACTURER'S CLOSEOUT!

TEMPERATURE CONTROLLED HEATING PLATE

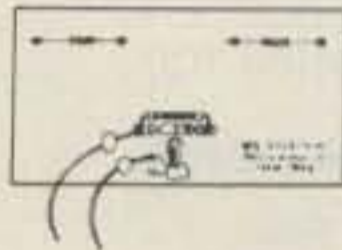

\$2.99

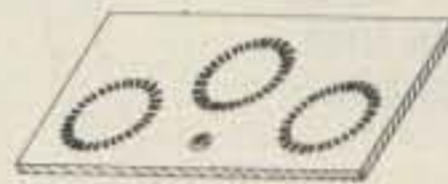

5 7/8 x 10 3/8 In. 120 VAC, 120 WATTS. Made of 1/4 In. tempered plate glass with Ni-Chrome heating element laminated to back. Element size is 4 1/4 x 9 1/4 Inches. Double protected by TI KLIXON Thermostat and two thermal fuses. Each also has neon ready light.

Besides the obvious use as a bun warmer, food warmer, coffee warmer, glue warmer, etc., our tests show this plate to be an excellent warmer for ferric chloride solution used in etching PC Boards by hobbyists. Typically increases etching efficiency by 300% over room temperature. Non-Submersible.

SONY 23 WATT AUDIO AMP MODULE

#STK-054. 23 WATTS SUPER CLEAN AUDIO. 20 HZ to 100 KHZ ± 2 DB. HYBRID, SILICON, SELF-CONTAINED MODULE. ONLY 1 3/4 x 2 1/2 IN. WITH DATA.

COMPARE AT UP TO TWICE OUR PRICE! **\$8⁹⁹** each

60 Hz CRYSTAL TIME BASE

\$4.95 (Complete Kit)
Uses MM5369 CMOS divider IC with high accuracy 3.579545 MHZ Crystal. Use with all MOS Clock Chips or Modules. Draws only 1.5 MA. All parts, data and PC Board included. 100 Hz, same as above, except \$5.95.

SILICON POWER SOLAR CELLS

2 Inch Dia. Approx. .5 VDC at 500 MA. in sunlight. Factory new units, not rejects as sold by others. Series for higher voltage, parallel for higher current. Converts solar energy directly to electricity.

LIMITED QUANTITY. **\$5⁹⁹** ea

FAIRCHILD PNP

"SUPER TRANSISTOR"
2N4402. TO-92 Plastic. Silicon PNP Driver. High Current. VCEO-40 HFE-50 to 150 at 150 MA. FT-150 MHZ. A super "BEEFED-UP" Version of the 2N3906.

8 FOR \$1.19

JUMBO IC ASSORTMENT

All new not rejects. BIG computer mfg. Surplus. Some standard marked, many house numbered. TTL, DTL, LINEAR. All prime. 1st line.

50 for \$1.59 500 for \$12.95

NATIONAL SEMICONDUCTOR

"COLOSSUS JR." JUMBO CLOCK MODULE

**MA1013
BRAND NEW!**

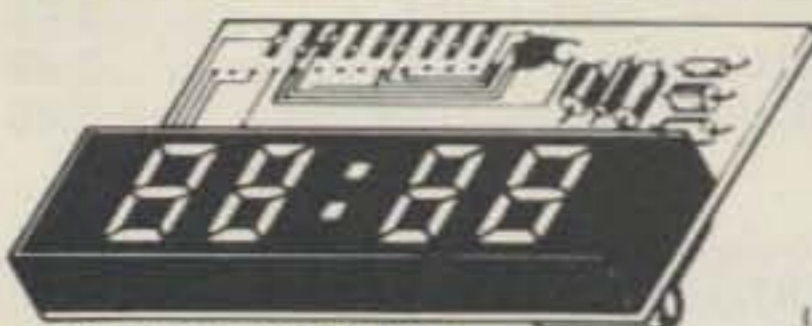

\$8.50

2 FOR \$15

(IAC XFMR \$1.95)

- Bright 4 digit 0.7" LED Display
- Complete-Add only Transformer and Switches
- 24 Hour Alarm Signal Output
- 12 Hour Real Time Format
- 50 or 60 Hz Operation
- Power Failure Indication
- LED Brightness Control
- Sleep and Snooze Timers
- Alarm "on" and PM Indicators
- Direct Drive - No RFI
- Direct Replacement for MA1012
- Comes with Full Data

PERFECT FOR USE
WITH A TIMEBASE.

ASSEMBLED! NOT A KIT!

MANUFACTURER'S CLOSEOUT!

TOSHIBA POWER AUDIO AMP

5.8 WATTS RMS Typical Output. 50 to 30,000 HZ ± 3 DB. For CB's, tape decks, PA's, etc. Works off of a single supply voltage from 10.5 to 18 VDC. 10 Pin plastic DIP with special built in heat sink tab. Perfect for use on 12VDC.

With Data. **\$3⁹⁹** each

Digital Research: Parts

(OF TEXAS)

P.O. BOX 401247 • GARLAND, TEXAS 75041 • (214) 271-2461

TERMS: Add 50¢ postage, we pay balance. Orders under \$15 add 75¢ handling. No C.O.D. We accept Visa, MasterCard and American Express cards. Tex. Res. add 5% Tax. Foreign orders (except Canada) add 20% P&H. 90 Day Money Back Guarantee on all items.



SPECTRONICS, INC.

1009 Garfield St., Oak Park, Illinois • 60304

(312) 848-6777

DIPOLES, ROTORS,

ACCESSORIES

At Warehouse-To-You Savings

KLM

- KLM 144-148-11 2 meter beam. \$47.95 c
- KLM 144-148-14 2 meter beam. 65.95 d
- KLM 144-148-16 2 meter beam. 72.95 d
- KLM 219-226-7 220 MHz beam. 28.95 b
- KLM 219-226-9 220 MHz beam. 29.95 b
- KLM 219-226-11 220 MHz beam. 32.95 c
- KLM 219-226-14 220 MHz beam. 49.95 d
- KLM 420-470-6 UHF beam 19.95 b
- KLM 420-470-14-UHF beam 31.95 c
- STANDARD BALUNS for abv beams. 24.95 b

Larsen

- LM150K 2M 3db, mob ant w/cable . . \$31.95 c
- NM0150 2M adapt ant TAD/TAE mt. . 27.10 b
- NLA150K 3/8" hole, 3db mob w/cable 33.75 c
- LMQ-K 1/4 wave w/cable 136-512 MHz . 9.55 b
- LM220K 220 MHz, 3db mob w/cable . 32.00 c
- LM440K UHF 5db mob w/cable. 30.00 c
- MMLM150 2M Mag mt 3db gain ant. . 40.75 d
- PQ 1/4 wave port and w/PL259 conn. . 5.25 a



HALF-SIZE FULL PERFORMANCE Multi-Band HF Communications Antennas



- MOR-GAIN HD Dipoles.
- * One half the length of conventional half-wave dipoles.
- * Multi-band, Multi-frequency.
- * Maximum efficiency - no traps, loading coils, or stubs.
- * Fully assembled and pre-tuned - no measuring, no cutting.
- * All weather rated - 1 KW AM, 2.5 KW CW or PEP SSB.
- * Proven performance - more than 10,000 have been delivered.
- * Permit use of the full capabilities of today's 5-band xcvrs.
- * One feedline for operation on all bands.

- 40-10HD/A 40/20/15/10 Mtrs (36) \$63.25 c
- 80-40HD/A 80/40 Mtr bands (69) 61.25 c
- 75-40HD/A 75/40 Mtr bands (66) 58.75 c
- 75-10HD/A 75/40/20/15/10 Mtr (66) . . . 78.25 c
- 80-10HD/A 80/40/20/15/10 Mtr (69) . . . 80.25 c



MODEL 595
\$21⁵⁰

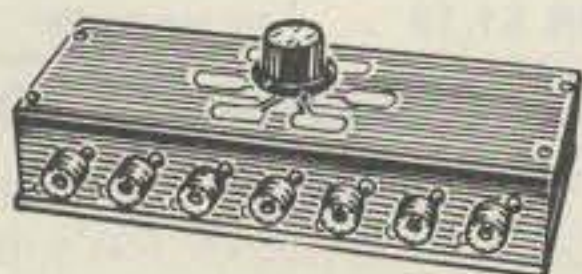

Our most popular switch. 6 position, grounds all except selected output circuit. Can be mounted on wall, on desk, or almost anywhere. Good to 150MHz. Wt. 2 lbs.

- 375 6 position, axial lead, gnd. \$19.75 a
- 376 5 pos, PROTAX, gnd pos 19.75 a
- 550A 5 pos, Radial, no gnding 17.50 a
- 550A2 2 pos, Radial, economy sw 14.95 a
- 590 5 pos, axial, panel mtg. 18.50 a
- 590G same as above w/gnd unused . 18.50 a
- 592 2 pos axial, panel mtg 17.25 a

"SLINKY" Dipole Antenna

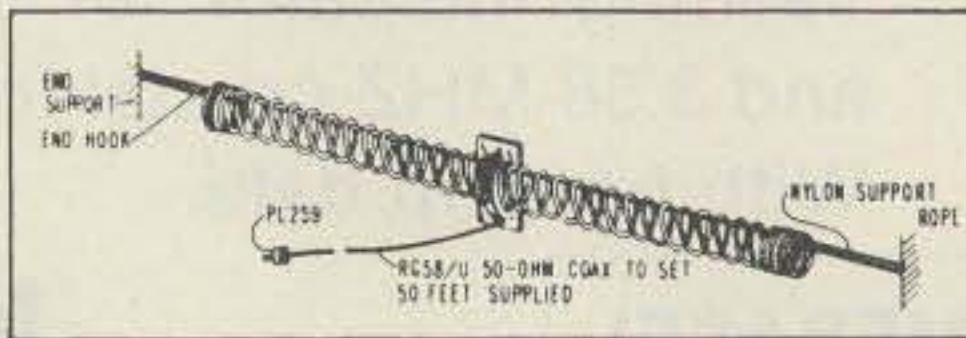

A lot of performance in a little space, on 80/75, 40 and 20 meters. Only one setting needed for full band coverage—low VSWR throughout. Can be set at any length from 24-40' on 80/75 meters, 12-35' on 40, 6-18' on 20. Band change takes less than a minute. Handles 1000 watts CW, 2000 PEP on SSB. With 50' RG-58/U coax. \$43.95

NEW! B&W PORTABLE WHIP ANTENNA



Quick Mounting
\$32⁵⁰

Simple, dependable whip is designed especially for apartment dwellers and renters who cannot install a permanent antenna. Tunes the 2, 6, 10, 15, 20 and 40-meter Amateur bands. Offers VSWR of 1.1:1 when properly adjusted to operating frequency. Ideal for use as a portable emergency antenna, too. Amounts to almost any horizontal support with a simple clamp bracket.

Weights less than 2 pounds including five base-loading coils (not used for 6/2 meters), coax line and counterpoise. Whip is 22 1/2" long disassembled, extends to 57". Mount is 14" long. Power rating: 360 watts SSB or CW. Model 370-10 \$32.50

SOUTH RIVER

HDT TRIPODS

- Galvanized steel.
- Lag Screws incl.
- UPS Shippable.

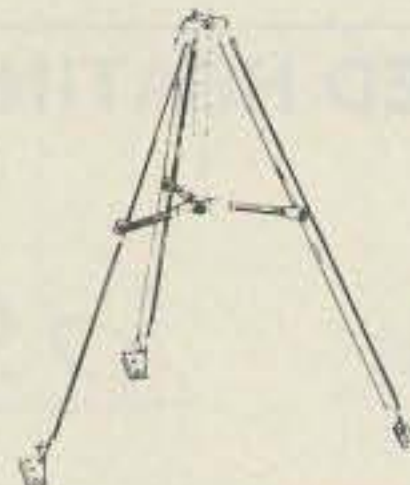

- HDT-10KD 10' tripod, hvy duty \$49.95 g
- HDT-5 5' tripod, galvanized 24.95 f
- HDT-3 3' tripod, galvanized 15.95 c
- ST-SN Stainless chimney mt (pair) . . 17.50 c
- PFM71 Hvy duty self sup roof mt 8.95 c
- 2791 Guy wire wood screw hooks (3) . . 1.54 a
- 2751 "thread x 7/8" turnbuckle (3) . . . 3.46 b
- 2871 50' #8 alum ground wire. 4.35 b
- 2876 100' #8 alum ground wire. 8.19 c
- GND-4CP 4' copper plated grnd rod. . . 3.39 c
- S-1625P 2 1/2 ft. x 1 1/4" mast 3.95 c
- A-125-5P 5 ft. x 1 1/4" alum mast. . . . 11.50 c

WHEN ORDERING FROM SPECTRONICS, REMEMBER:

ALL PRICES are subject to change without notice. When any item carries a special sale price lower than shown in the catalog, you will automatically receive a refund if you overpaid with your order.

C.O.D. ORDERS require payment to be made by cash, certified check, or money order only. We will gladly quote you the exact amount that the deliveryman will ask for.

SHIPPING CHARGES must be added to your order. Please refer to the chart on the order blank page and add to your total.

ALL ORDERS sent F.O.B. Oak Park, Illinois.

Famous "W2AU" Balun

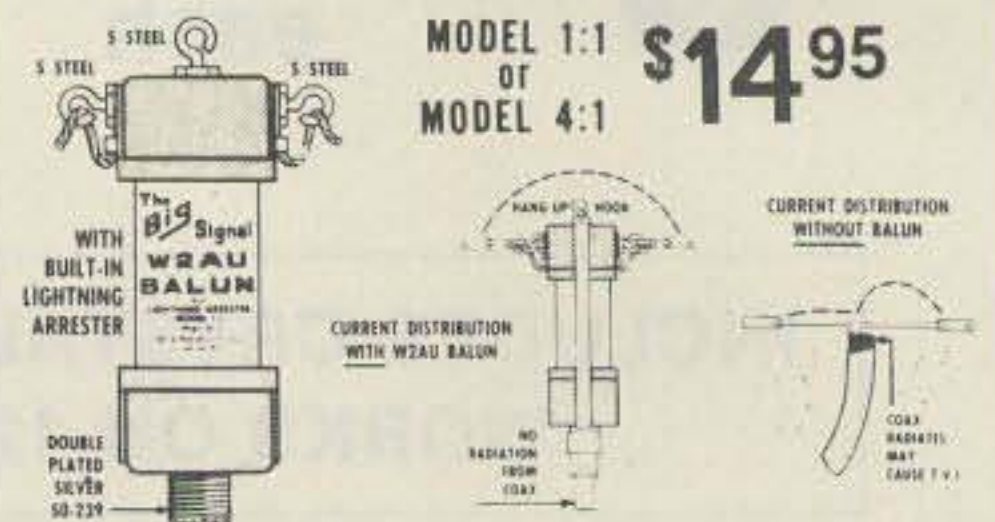

MODEL 1:1
OF
MODEL 4:1 \$14⁹⁵

1. HANDLES FULL 2 KW PEP AND THEN SOME. Broad-Banded 3 to 40 Mc.
2. HELPS TVI PROBLEMS By Reducing Coax Line Radiation
3. NOW ALL STAINLESS STEEL HARDWARE. SO239 Double Silver Plated
4. IMPROVES F/B RATIO By Reducing Coax Line Pick-Up
5. REPLACES CENTER INSULATOR. Withstands Antenna Pull of Over 600 Lbs.
6. BUILT-IN LIGHTNING ARRESTER. Helps Protect Balun— Could Also Save Your Valuable Gear
7. BUILT-IN HANG-UP HOOK. Ideal For Inverted Vees, Multi-Band Antennas, Dipoles, Beam and Quads

NOW BEING USED BY ALL BRANCHES OF THE U.S. ARMED FORCES, FAA, RCA, CIA, CANADIAN DEFENSE DEPT. PLUS THOUSANDS OF HAMS THE WORLD OVER

Comes in 2 models: 1:1 matches 50 or 75 ohm unbalanced (coax line) to 50 or 75 ohm balanced load; 4:1 model matches 50 or 75 ohm unbalanced (coax line) to 200 or 300 ohm balanced load.

Model 1:1 \$14.95 Model 4:1 \$14.95

DIPOLE HEADQUARTERS

CABLE

- 8U FOAM, hi dens braid 50 ft. \$11.95 c
- 8U FOAM, hi dens braid 100 ft. 22.00 e
- RG58A/U stranded center 50 ft. 6.95 c
- RG58A/U stranded center 100 ft. 9.95 d
- RG58 3 ft w/PL259 each end. 3.35 b
- RG58 5 ft w/PL259 each end. 4.39 b
- RG58 50 ft w/PL259 each end. 9.95 c

COPPER WIRE

- #14 stranded, 100 ft spool. 5.95 c
- #14 solidcopper enameled 100' 5.95 c

INSULATORS

- Egg Ins, porcelain per pair99 a
- DOG BONE, porcelain set of 3 1.25 a
- HY GAIN #155 center insulator. 5.95 b
- HY GAIN Cyclocac end ins per pair . . . 3.95 b
- MOSLEY dipole center insulator 5.75 a

CONNECTORS

- PL259 UHF male, 2 per pkg 1.59 a
- SO239 UHF female chassis mt69 a
- UG175 Adapts RG58 to PL259, pkg 2 . . . 59 a
- UG176 Adapts RG59 to PL259, pkg 2 . . . 59 a
- PL258 UHF double female99 a
- DM-SP UHF double male 1.69 a
- M359 90 deg UHF elbow conn. 2.10 a
- UG88U BNC male for RG58 1.49 a
- 1094 BNC female 1.10 a
- M358 UHF "T" connector. 2.95 a
- UG255 UHF female to BNC male 3.49 a
- UG273 BNC female to UHF male 2.45 a

ESTIMATED WEIGHT CODING

After the price of each item you will find a letter, i.e., 19.95 a. To make it easier to figure shipping costs, these letters indicate the approximate weight of the item as follows:

- a. Less than 1 lb. f. 20-30 lbs.
- b. 1-3 lbs. d. 7-10 lbs. g. 30-40 lbs.
- c. 4-6 lbs. e. 10-20 lbs. h. 40-50 lbs.

★ will be sent truck collect.

HF & VHF BEAMS and VERTICALS

At Warehouse-To-You Savings



SPECTRONICS, INC.

1009 Garfield St., Oak Park, Illinois • 60304

✓S81

(312) 848-6777

the antenna
specialists



2 MTR DUCKIES

- Model HM-4. Has 5/16"-32 thread. Fits Motorola HT's, ICOM IC215 and Standard 146A \$7.00
- Model HM-5. Same as above, but with PL-259 connector \$7.00
- Model HM-226. Same, with TNC connector for Wilson 1405 \$18.50
- Model HM-227. Same, but with BNC connector termination \$12.00
- Model HM-228. With F connector for Wilson 1402 & Tempo \$11.50

HM-4

HM-5

- HM180 2mtr, 3db trunk lip ant. \$33.50 b
- HM179 2mtr, 3db hole mount ant. 29.00 b
- HM20 2mtr, 3db for marine use. 39.00 b
- HM176 440MHz 5db trunk lip ant. 33.00 b
- HM175 440MHz 5db hole mount ant. 29.00 b
- HM224 220MHz 4db trunk lip ant. 33.50 b

2M BASE ANT. PACKAGE

Here's what you get:

- Cushcraft AR2 Ringo South River.
- PFM71 Roof mount.
- A125-5P 5' alum mast.
- Lag bolts.
- 50' 8U foam coax.
- PL259 coax conn.



\$59⁹⁵

Wt. 16 lbs.

FINCO

The most rugged 6 & 2 meter beams we've seen yet!!

- A 2-10 10 ele, 2M beam \$44.95 d
- A 2-5 5 ele, 2M beam, 9.5db gain. 27.95 c
- A 2-2 10 ele, 2M dual polarization. 46.50 e
- A62 6&2M antenna on one boom 74.95 e
- A6-5 5 element 6M beam, 11db 46.50 e
- A6-3 3 ele 6M beam, 7db gain 30.00 d
- A 1 1/4 220MHz 10 ele, 13.8db 32.95 d

HUSTLER

\$9⁹⁵ "BUCK-BUSTER" SF-2 ANTENNA

Fits all Hustler deluxe mobile mounts. 3/8"x24 base. 5/8" wave two meters, 3.4 db gain. SWR at resonance: adj. to 1.5:1 or better. Bandwidth: 6 MHz, 2:1 or better SWR. 100 watts max.

\$79⁹⁵ NEW 4-BTV VERTICAL

One setting covers 10, 15, 20, 40M. Space restricted or unlimited, you get top signal reports, consistent contacts and complete coverage. Add 5th band with a 75M resonator. Use one feedline, any length. Requires no switching or matching devices. 15 lbs.

SF-2

4-BTV

- MO1 Mobile mast \$22.95 c
- MO2 Mobile mast 22.95 c
- RM10 10 Meter resonator 6.95 b
- RM15 15 meter resonator 7.95 b
- RM20 20 Meter resonator 8.95 b
- RM40 40 Meter resonator 14.95 b
- RM75 75 Meter resonator 16.95 b
- RM80 80 Meter resonator 17.95 b
- RM10S 10M resonator 2KW PEP 11.95 b
- RM15S 15M resonator 2KW PEP 12.95 b
- RM20S 20M resonator 2KW PEP 13.95 b
- RM40S 40M resonator 2KW PEP 16.95 b
- RM75S 75M resonator 2KW PEP 31.95 b
- RM80S 80M resonator 2KW PEP 31.95 b
- CG144 5.2db 2mtr ant 3/8 x 24 stud ... 26.95 b
- CGT144 Same but trunk lip mount... 42.95 c
- SF2 3db 2mtr ant 3/8 x 24 stud 9.95 b
- SF220 3db 220MHz ant 3/8 x24 stud .. 11.95 b
- 4BTV 40-10mtr vertical 79.95 e
- G6-144 2mtr base ant 6db 79.95 d
- BM1 Bumper mount 3/8 x 24 thread... 15.95 d
- RSS2 Mobile resonator spring 5.95 a
- QD1 Quick disconnect 3/8 x 24 16.95 a

hy-gain

VERTICAL ANTENNAS

Model 14AVQ/WB

- 40 thru 10 meters.
- Wide band performance
- New Hy-Q traps

Self-supporting, automatic band switching vertical antenna. Omni-directional performance. Favorable L/C ratio. High Q. True 1/4 wave resonance on all bands. Low angle radiation pattern. Taper swagged seamless aluminum construction. 12" double-grip mast bracket. Full circumference compression clamps at tubing joints. Weight: 8.2 lbs.

Model 14AVQ/WB \$57.00

Model 18AVT/WB

- Automatic band switching
- Completely Self-Supporting
- Omni-Directional Performance

Three beefed-up Hy-Q traps permit automatic switching. 5 band capability. Favorable L/C ratio. Top loading coil. Across the band performance with one furnished setting for each band (10 thru 40). True 1/4 wave resonance on all bands. SWR of 2:1 or less at band edges. Low angle radiation pattern. Extra heavy duty tapered swaged seamless aluminum tubing with full circumference, corrosion resistant compression clamps at tubing joints. Antenna can be mounted without guide wires. 25' high. Weight: 10.7 lbs.

Model 18 AVT/WB \$79.95

NEW! ASP-694 1/4-Wave Magnetic Antenna

Low profile magnetic antenna with cable and connector. Tunable 108-512 MHz. Can be converted to gain antenna later. Wt.: 3 lbs.

Model ASP-694 \$21.00

Cushcraft

- AR2 2meter Ringo base ant. \$24.95 b
- ARX2 2mtr Ringo Ranger base ant .. 39.95 c
- AR220 220MHz Ringo base ant. 24.95 b
- ARX220 220MHz Ringo Ranger. 39.95 c
- AR450 UHF Ringo base ant 24.95 b
- ARX450 UHF Ringo Ranger base ant .. 39.95 c
- AR6 6 meter Ringo base ant 36.95 c
- ARX2K Adapts 2M Ringo to Ranger .. 16.95 b
- A147-4 4 ele 2M FM beam ant 24.95 b
- A147-11 11 ele 2M FM beam. 36.95 c
- A147-20T 10 ele 2M vert/horz twist... 62.95 d
- A144-7 7 ele 2M CW/SSB beam. 26.95 c
- A144-11 11 ele 2M CW/SSB beam. 36.95 d
- A144-10T 10 ele Twist OSCAR ant ... 42.95 c
- A144-20T 20 ele Twist OSCAR ant ... 62.95 d
- A220-7 7 ele 220MHz beam. 26.95 c
- A220-11 11 ele 220MHz beam 34.95 c
- A449-6 6 ele UHF FM beam 24.95 c
- A449-11 11 ele UHF beam. 34.95 c
- A432-11 11el 432MHz SSB/CW beam 34.95 c
- AFM4D 144-148MHz Four Pole 69.95 c
- AFM24D 220MHz Four Pole 64.95 c
- AFM44D 435-450MHz Four Pole 64.95 c
- ASQ-2 2M Squalo horiz ant 19.95 b
- LAC-1 Coax lightning arrester. 4.95 a
- LAC2- Coax lightning arrester. 4.95 a
- ATB34 ★ 4 ele 20-10mtr beam 219.95 ★
- ATV3 20-10mtr trap vertical 49.95 e
- ATV4 40-10mtr trap vertical 69.95 e
- ATV5 80-10mtr trap vertical 89.95 e
- A50-3 3 element 6 meter beam 39.95 d
- A50-5 5 element 6 meter beam 59.95 e
- A28-3 ★ 3 element 10 meter beam .. 69.95 ★
- A432-20T 432MHz 20 ele twist. 59.95 d

- BN86 Ferrite balun for 80-10mtrs... \$15.95 a
- 155 Center insulator for doublet. 5.95 a
- 156 End insul. for doublet (pair) 3.95 a
- 18HT ★ HyTower 80-10M vertical .. 239.95 ★
- 18V Economy 80 tru 10M vertical 24.95 c
- 12AVQ 20-10mtr trap vertical. 39.95 c
- 14AVQ 40-10mtr trap vertical. 57.00 d
- 18AVT/WB 80-10mtr trap vertical ... 79.95 d
- 2BDQ Trap doublet for 80 & 40mtr ... 39.95 d
- 5BDQ Trap doublet for 80-10mtrs. ... 69.95 e
- TH3 MkIII ★ 3 ele 20-10 tribander .. 179.95 ★
- TH6DXX ★ 6 ele 20-10M tribander. . 239.95 ★
- TH3 Jr 3 ele tribander (750W PEP) .. 129.95 e
- HY QUAD ★ 2 ele quad 20-10 mtrs. . 189.95 ★
- 103BA 3 element 10Mtr beam 54.95 e
- 153BA ★ 3 element 15mtr beam. 79.95
- 204BA ★ 4 element 20mtr beam ... 179.95 ★
- 402BA ★ 2 element 40 mtr beam... 169.95 ★
- 64B ★ 4 element 6 meter beam 39.95
- 270 6db fiberglass 2M antenna. 39.95 e
- 203 3 element 2 meter yagi. 15.95 b
- 205 5 element 2 meter yagi. 17.95 c
- 208 8 element 2 meter yagi. 25.95 c
- 214 14 element 2 meter yagi. 31.95 d

Mosley

- TA33 ★ 3 el triband beam 2KW PEP . \$189.95
- TA33Jr ★ 3ele triband 1KW PEP ... 149.95 ★
- TA36 ★ 6ele triband 2KW PEP 269.95 ★
- CL33 ★ 3 ele Classic. 209.95 ★
- CL36 ★ 6 ele Classic. 269.95 ★
- TA40KR 40mtr adpt for TA33/36 92.95 e
- MPK3 2KW conv kit for TA33Jr 67.65 e

CDE

- HAM IV Rotor with control box \$149.95 f
- T2X Tailtwister xtra hvy dty 219.95 f
- CD45 Medium duty rotor 119.95 f
- AR22XL Light duty rotor 59.95 e
- Mast adaptor for Ham II/T2X. 29.95 d
- South Center meter kit 3.00 a

THE SUMMER SPECIALS CONTINUE !!!

Special prices good through cover month of magazine. All items are limited quantity — first come, first served.

16K MEMORY EXPANSION CHIP SET

★ \$87.20 ★

Expand memory in the Apple, Radio Shack-80, and Exidy Sorcerer computers — for 20% off our regular price! Why is this kit one of our all time best sellers? Many reasons... 250 ns access time chips for use with 4 MHz systems, low power ICs used exclusively, DIP shunts included, 1 year limited warranty, and easy-to-follow instructions that make memory expansion a snap. We've not only made it simple for you to acquire a more powerful memory, we've made it economical too.

MA1003 CLOCK MODULE

★ \$13.20 ★

Our very best clock module is reduced by 20% for another month... but don't count on these lasting too much longer. Features include an internal crystal timebase accurate to .01%, fluorescent readouts that don't wash out in daylight (and look beautiful at night!), simple assembly (just add 2 time-setting switches and 12V DC), and much more. Our applications note tells you how to use this module to maximum advantage in your car, van, boat, or airplane. Also available: matching case with mounting hardware and optical filter for \$5.95.

HAMS! ON RF POWER TRANSISTORS

★ 10% OFF ★

- 2NRF-1 2 GHz RF power transistor. Pd max (@ 25 degrees C) 3.5W, Pout min @ 2 GHz 1.0W, Pin 310 mW, efficiency @ 2 GHz 30%, round shape, similar to RCA 2N5470. **\$4.45**
- 2NRF-2 2 GHz RF power transistor. Pd 8.7W, Pout 2.5W, Pin 300 mW, efficiency 33%, cross shape, similar to RCA TA8407. **\$5.35**
- 2NRF-3 2 GHz RF power transistor. Pd 21W, Pout 5.5W, Pin 1.25W, efficiency 33%, cross shape. Similar to RCA 2N6269. **\$6.25**
- 2NRF-4 2 GHz RF power transistor. Pd 29W, Pout 7.5W, Pin 1.5W, efficiency 33%, cross shape. Factory selected, prime 2N6269. **\$7.15**

★ WE BREAK THE 1¢/BYTE BARRIER! ★

We're offering low power 21L02 1K static RAM memory chips, guaranteed to run with any 2 MHz system, at the very low price of 10/\$9.90... that's under 1¢ per byte. Stock up now, we can't predict how much longer we'll have the last of these prime parts available for sale.

GODBOUT SLASHES STATIC MEMORY PRICES AGAIN: S-100 32K \$529, 24K \$398, 16K \$269!

Econoram* unkits are now at their lowest prices ever. What's an unkit? It's a standard Econoram board that has all sockets and bypass caps pre-soldered in place. To complete assembly, the user simply solders in a few other parts, and inserts all ICs into their sockets. The result: A one-evening project that saves money while offering true CompuPro/Econoram quality for those on a budget. Static technology used throughout; all boards except Econoram VI run with 4 MHz systems. Same 1 year limited warranty, same great specs as our regular boards.

Speaking of regular boards, we offer assembled/tested models and boards qualified under our high-reliability Certified System Component (CSC) program (200 hour burn-in, immediate replacement in event of failure within 1 year of invoice date). Refer to chart below for pricing.

Name	Storage	Buss	Configuration	Unkit	Assm	CSC
Econoram IIA	8K X 8	S-100	2-4K blocks	\$149	\$179	\$239
Econoram IV	16K X 8	S-100	1-16K	\$269	\$329	\$429
Econoram VI	12K X 8	H8	1-8K, 1-4K	\$200	\$270	n/a
Econoram VIIA-16	16K X 8	S-100	2-4K, 1-8K	\$279	\$339	\$439
Econoram VIIA-24	24K X 8	S-100	2-4K, 2-8K	\$398	\$485	\$605
Econoram IX-16	16K X 8	Dig Grp	2-4K, 1-8K	\$319	\$379	n/a
Econoram IX-32	32K X 8	Dig Grp	2-4K, 1-8K, 1-16K	\$559	\$639	n/a
Econoram X	32K X 8	S-100	2-8K, 1-16K	\$529	\$649	\$789
Econoram XI	32K X 8	SBC	2-8K, 1-16K	n/a	n/a	\$1050

BANK SELECT MEMORIES (for Alpha Micro Systems, Marinchip, etc.)

Econoram XII-16	16K X 8	S-100	2 ind. banks**	\$329	\$419	\$519
Econoram XII-24	24K X 8	S-100	2 ind. banks**	\$429	\$539	\$649
Econoram XIII	32K X 8	S-100	2 ind. banks**	\$559	\$699	\$849

*Econoram is a trademark of Bill Godbout Electronics

**Econoram XII-16 and -24 have 2 independent banks addressable on 8K boundaries; Econoram XIII has 2 independent banks addressable on 16K boundaries.

TERMS: Add \$1 handling to orders under \$15. Allow up to 5% shipping, excess refunded. Give street address for UPS delivery. VISA®/Mastercharge® call our 24 hour order desk at (415) 562-0636. CODs OK with street address. Cal res add sales tax. Thanks for your business!

GODBOUT

BILL GODBOUT ELECTRONICS
BOX 2355, OAKLAND AIRPORT, CA 94614

✓G4 **FREE FLYER:** Our flyer tells about all the latest in electronic bargains... and one of our bargains is the flyer, since it's free. Just send us your name and address, we'll take care of the rest. Include 41¢ in stamps if you want first class delivery.

7400 TTL

SN7400N	16	SN7470N	29	SN74160N	89
SN7401N	18	SN7471N	29	SN74161N	89
SN7402N	18	SN7472N	35	SN74162N	1.95
SN7403N	18	SN7473N	35	SN74163N	89
SN7404N	18	SN7474N	5.00	SN74164N	89
SN7405N	20	SN7475N	5.00	SN74165N	89
SN7406N	20	SN7476N	5.00	SN74166N	1.25
SN7407N	20	SN7477N	5.00	SN74167N	1.95
SN7408N	20	SN7478N	5.00	SN74168N	1.50
SN7409N	20	SN7479N	5.00	SN74169N	6.00
SN7410N	18	SN7480N	1.75	SN74170N	1.25
SN7411N	25	SN7481N	4.5	SN74171N	89
SN7412N	25	SN7482N	5.0	SN74172N	89
SN7413N	40	SN7483N	4.3	SN74173N	79
SN7414N	70	SN7484N	4.3	SN74174N	79
SN7415N	25	SN7485N	5.5	SN74175N	1.95
SN7416N	25	SN7486N	5.5	SN74176N	1.95
SN7417N	25	SN7487N	5.5	SN74177N	79
SN7420N	20	SN7488N	5.5	SN74178N	1.95
SN7421N	20	SN7489N	5.5	SN74179N	1.95
SN7422N	39	SN7490N	3.00	SN74180N	1.95
SN7423N	39	SN7491N	3.00	SN74181N	1.95
SN7424N	39	SN7492N	3.00	SN74182N	1.95
SN7425N	39	SN7493N	3.00	SN74183N	1.95
SN7426N	39	SN7494N	3.00	SN74184N	1.95
SN7427N	39	SN7495N	3.00	SN74185N	1.95
SN7428N	39	SN7496N	3.00	SN74186N	1.95
SN7429N	39	SN7497N	3.00	SN74187N	1.95
SN7430N	39	SN7498N	3.00	SN74188N	1.95
SN7431N	39	SN7499N	3.00	SN74189N	1.95
SN7432N	39	SN7500N	3.00	SN74190N	1.95
SN7433N	39			SN74191N	1.95
SN7434N	39			SN74192N	1.95
SN7435N	39			SN74193N	1.95
SN7436N	39			SN74194N	1.95
SN7437N	39			SN74195N	1.95
SN7438N	39			SN74196N	1.95
SN7439N	39			SN74197N	1.95
SN7440N	39			SN74198N	1.95
SN7441N	39			SN74199N	1.95
SN7442N	39			SN74200N	1.95
SN7443N	39			SN74201N	1.95
SN7444N	39			SN74202N	1.95
SN7445N	39			SN74203N	1.95
SN7446N	39			SN74204N	1.95
SN7447N	39			SN74205N	1.95
SN7448N	39			SN74206N	1.95
SN7449N	39			SN74207N	1.95
SN7450N	39			SN74208N	1.95
SN7451N	39			SN74209N	1.95
SN7452N	39			SN74210N	1.95
SN7453N	39			SN74211N	1.95
SN7454N	39			SN74212N	1.95
SN7455N	39			SN74213N	1.95
SN7456N	39			SN74214N	1.95
SN7457N	39			SN74215N	1.95
SN7458N	39			SN74216N	1.95
SN7459N	39			SN74217N	1.95
SN7460N	39			SN74218N	1.95

C/MOS

CD4000	23	CD4070	55
CD4001	23	CD4071	23
CD4002	23	CD4072	23
CD4003	1.19	CD4073	1.39
CD4007	25	CD4081	23
CD4009	49	CD4082	23
CD4010	49	CD4093	99
CD4011	23	CD4098	2.49
CD4012	25	MC14409	14.95
CD4013	39	MC14410	14.95
CD4014	1.39	MC14411	14.95
CD4015	1.19	MC14419	4.95
CD4016	49	MC14433	19.95
CD4017	1.19	MC14506	7.5
CD4018	99	MC14507	99
CD4019	49	MC14582	14.50
CD4020	1.19	MC14583	3.50
CD4021	1.39	CD4508	3.95
CD4022	1.19	CD4510	1.39
CD4023	23	CD4511	1.29
CD4024	79	CD4515	2.95
CD4025	23	CD4518	1.29
CD4026	2.25	CD4520	1.29
CD4027	69	CD4566	2.25

74C00

74C00	39	74C153	2.49
74C01	39	74C164	2.49
74C02	39	74C173	2.60
74C03	39	74C192	2.49
74C04	39	74C193	2.49
74C05	39	74C195	2.49
74C06	39	74C196	2.49
74C07	39	74C222	5.95
74C08	39	74C223	6.25
74C09	39	74C225	8.95
74C10	1.95	74C226	8.95
74C11	1.25	74C227	8.95
74C12	1.25	74C228	8.95
74C13	1.25	74C229	8.95
74C14	1.95	74C230	8.95
74C15	3.00	74C231	8.95
74C16	2.15	74C232	8.95
74C17	2.15	74C233	8.95
74C18	2.49	74C234	8.95
74C19	2.49	74C235	8.95
74C20	2.49	74C236	8.95
74C21	2.49	74C237	8.95
74C22	2.49	74C238	8.95
74C23	2.49	74C239	8.95
74C24	2.49	74C240	8.95
74C25	2.49	74C241	8.95
74C26	2.49	74C242	8.95
74C27	2.49	74C243	8.95
74C28	2.49	74C244	8.95
74C29	2.49	74C245	8.95
74C30	2.49	74C246	8.95
74C31	2.49	74C247	8.95
74C32	2.49	74C248	8.95
74C33	2.49	74C249	8.95
74C34	2.49	74C250	8.95
74C35	2.49	74C251	8.95
74C36	2.49	74C252	8.95
74C37	2.49	74C253	8.95
74C38	2.49	74C254	8.95
74C39	2.49	74C255	8.95
74C40	2.49	74C256	8.95
74C41	2.49	74C257	8.95
74C42	2.49	74C258	8.95
74C43	2.49	74C259	8.95
74C44	2.49	74C260	8.95
74C45	2.49	74C261	8.95
74C46	2.49	74C262	8.95
74C47	2.49	74C263	8.95
74C48	2.49	74C264	8.95
74C49	2.49	74C265	8.95
74C50	2.49	74C266	8.95
74C51	2.49	74C267	8.95
74C52	2.49	74C268	8.95
74C53	2.49	74C269	8.95
74C54	2.49	74C270	8.95
74C55	2.49	74C271	8.95
74C56	2.49	74C272	8.95
74C57	2.49	74C273	8.95
74C58	2.49	74C274	8.95
74C59	2.49	74C275	8.95
74C60	2.49	74C276	8.95
74C61	2.49	74C277	8.95
74C62	2.49	74C278	8.95
74C63	2.49	74C279	8.95
74C64	2.49	74C280	8.95
74C65	2.49	74C281	8.95
74C66	2.49	74C282	8.95
74C67	2.49	74C283	8.95
74C68	2.49	74C284	8.95
74C69	2.49	74C285	8.95
74C70	2.49	74C286	8.95
74C71	2.49	74C287	8.95
74C72	2.49	74C288	8.95
74C73	2.49	74C289	8.95
74C74	2.49	74C290	8.95
74C75	2.49	74C291	8.95
74C76	2.49	74C292	8.95
74C77	2.49	74C293	8.95
74C78	2.49	74C294	8.95
74C79	2.49	74C295	8.95
74C80	2.49	74C296	8.95
74C81	2.49	74C297	8.95
74C82	2.49	74C298	8.95
74C83	2.49	74C299	8.95
74C84	2.49	74C300	8.95

LINEAR

LM709	1.75	LM710N	1.75
LM106H	99	LM711N	39
LM300H	80	LM723N/H	55
LM301CN/H	35	LM733N	1.00
LM302H	75	LM739N	1.19
LM304H	1.00	LM741CN/H	35
LM305H	60	LM741-14N	39
LM307CN/H	35	LM747N/H	79
LM308CN/H	1.00	LM748N/H	39
LM309H	1.10	LM749N/H	2.95
LM309K	1.25	LM340T-18	1.25
LM310CN	1.15	LM340T-24	1.25
LM311N/H	90	LM340T-12	1.25
LM312H	1.50	LM340T-15	1.25
LM318N	1.30	LM340T-18	1.25
LM320K-5	1.35	LM340T-24	1.25
LM320K-5.2	1.35	LM340T-12	1.25
LM320K-12	1.35	LM340T-15	1.25
LM320K-15	1.35	LM340T-18	1.25
LM320K-18	1.35	LM340T-24	1.25
LM320K-24	1.35	LM340T-12	1.25
LM320T-5	1.25	LM340T-15	1.25
LM320T-5.2	1.25	LM340T-18	1.25
LM320T-8	1.25	LM340T-24	1.25
LM320T-12	1.25	LM340T-12	1.25
LM320T-15	1.25	LM340T-15	1.25
LM320T-18	1.25	LM340T-18	1.25
LM320T-24	1.25	LM340T-24	1.25
LM325K-5	5.95	LM340T-12	1.25
LM324N	1.80	LM340T-15	1.25
LM329N	39	LM340T-18	1.25
LM340K-5	1.35	LM340T-24	1.25
LM340K-6	1.35	LM340T-12	1.25
LM340K-8	1.35	LM340T-15	1.25
LM340K-12	1.35	LM340T-18	1.25
LM340K-15	1.35	LM340T-24	1.25

74LS00TTL

74LS00	29	74LS138	89
74LS01	29	74LS139	89
74LS02	29	74LS151	89
74LS03	29	74LS155	89
74LS04	35	74LS157	89
74LS05	35	74LS160	1.15
74LS06	29	74LS161	1.15
74LS09	35	74LS162	1.15
74LS10	29	74LS163	1.15
74LS11	75	74LS164	1.25
74LS13	59	74LS175	99
74LS14	1.25	74LS181	2.49
74LS15	35	74LS190	1.15
74LS20	29	74LS191	1.15
74LS21	35	74LS192	1.15
74LS22	35	74LS193	1.15
74LS26	35	74LS194	1.15
74LS27	35	74LS195	1.15
74LS28	35	74LS253	99
74LS30	29	74LS257	89
74LS32	35	74LS258	1.75
74LS37	45	74LS260	69
74LS40	35	74LS279	79
74LS42	89	74LS287	75
		74LS288	75
		74LS289	75
		74LS290	75
		74LS291	75
		74LS292	75
		74LS293	75
		74LS294	75
		74LS295	75
		74LS296	75
		74LS297	75
		74LS298	75
		74LS299	75
		74LS300	75
		74LS301	75
		74LS302	75
		74LS303	75
		74LS304	75
		74LS305	75
		74LS306	75
		74LS307	75
		74LS308	75
		74LS309	75
		74LS310	75
		74LS311	75
		74LS312	75
		74LS313	75
		74LS314	75
		74LS315	75
		74LS316	75
		74LS317	75
		74LS318	75
		74LS319	75
		74LS320	75
		74LS321	75
		74LS322	75
		74LS323	75
		74LS324	75
		74LS325	75
		74LS326	75
		74LS327	75
		74LS328	75
		74LS329	75
		74LS330	75
		74LS331	7

ASSOCIATED RADIO

913-381-5900

8012 CONSER BOX 4327

OVERLAND PARK, KANSAS 66204



CALL US WITH YOUR REQUIREMENTS
AMERICA'S NO. 1 Real Amateur Radio Store



**Associated Wants to TRADE - BUY - SELL
GOT YOUR BEST DEAL? THEN CALL US AT
913-381-5900 - NO TRADE? ASK FOR EXT. 12**

**NOTE: SEND \$1.00 FOR OUR CURRENT CATALOG
OF NEW AND RECONDITIONED EQUIPMENT.**

*** ALSO WE PERIODICALLY PUBLISH A LIST OF
UNSERVICED EQUIPMENT AT GREAT SAVINGS.
A BONANZA FOR THE EXPERIENCED OPERATOR.
TO OBTAIN THE NEXT UNSERVICED BARGAIN LIST,
SEND A SELF ADDRESSED STAMPED ENVELOPE.**



WE'RE BACK WITH OUR WORLD FAMOUS INFLATION FIGHTIN'

'ONE CENTERS'

4V RECHARGEABLE GEL/SEL ENERGY PAK \$12.50

Portable Power at Poly Paks Prices! Brand New, 4V @ 2.6 Amp. Hr. Gel Cell storage battery. Units consist of gelled electrolyte, enclosed in hermetically sealed plastic, for years of dependable service. Compact, (only 3-1/2" x 2-3/8" x 1-5/16" in size). Stack 'em to produce 8V, 12V, 24V... or increase the amperage up and away. Use 'em for Burglar Alarms, Intrusion Detectors, Ham, Mo., or Solar Storage Applications. Cat. No. 92CU5788

2 for \$12.51

It's Stacked Energy!

PARALLEL ENTRY DIGITAL PRINTER

These unique printers feature precision Swiss construction. 18 key columns are divided into 16 for numerals, and 2 for alphabetical and trig figures, and mathematical functions. Each wheel is 12 position. Utilizes 2.75" wide adding machine tape, and dual color ribbon. Printing technique: parallel pressure printing, multiple copies. Print Rate: 3 lines per second. Operating voltage: 22 to 28 VDC. Comes in original packing w/roll of tape. Size: 6-1/2" x 3-1/8" x 5-3/8" Wt. 7 lbs. Cat. No. 92CU5545

Only \$19.99

2 for \$20.00

40 CHANNEL CB BOARD \$12.50

2 FOR \$12.51

Poly Paks buys up factory close-out from Hy-Gain... so you gain! Boards have: Heat-sinked 9 Watt Amp Chip, RF and Mod. Transistors, and Motorola MC series PLL. May be used for 10 meter conversion, (see continuing series "CB to 10" in 73 magazine). The parts alone make it an offer you can't refuse. Wt. 9 oz. Cat. No. 92CU5554

HY-GAIN ONE ARM BANDIT MIKES

Only \$14.99

2 FOR \$15

Take one hand command of your mobile or base rig with Hy-Gain's One Arm Bandit Mike. ON/OFF, VOLUME, SQUELCH, CHANNEL SELECTOR, SPEAKER, and DIGITAL DISPLAY are all conveniently located where your fingers do the talking. Comes with 6 ft. multi-conductor, color-coded, coiled cable, (separate) for easy integration into any type of rig. Size: 4 1/4" x 2 1/4" x 1 1/4". Wt. 9 oz. No. 92CU5886

\$12.50

2 for \$12.51

DIAL DESK TELEPHONE

Cat. No. 92CU5906

"TIE-PIN" CONDENSER MIKE

2 for \$3.96

It's a little giant in sound quality. Metal encased, and omnidirectional. Frequency response 20-20,000 Hz. Less tie pin or lapel clip. 800 ohm impedance. 1.5 VDC. Cat. No. 92CU5730

\$3.95

25 AMP BRIDGE RECTIFIERS

PIV	SALE	2 FOR
25	1.25	1.26
50	1.95	1.96
100	2.25	2.26
200	2.95	2.96
400	3.50	3.51
600	4.25	4.26
800	4.95	4.96

Order No. 2273 & voltage

1N4000 Epoxy Rectifiers

Cat. No.	Type	Volts	SALE	IC SALE!
2377	1N4001	50	10 for \$.75	20 for \$.76
2378	1N4002	100	10 for .85	20 for .86
2379	1N4003	200	10 for .95	20 for .96
2380	1N4004	400	10 for 1.19	20 for 1.20
2381	1N4005	600	10 for 1.39	20 for 1.40
2382	1N4006	800	10 for 1.49	20 for 1.50
2383	1N4007	1000	10 for 1.59	20 for 1.60

ULTRASONIC TRANSDUCER

2 for \$3.98

\$3.99

Perfect for dozens of projects, including remote control devices, alarms, etc. Sends and Receives! 1" diameter, 1/4" deep, with standard RCA type phone jack. Wt. 2 oz. Cat. No. 92CU5375

FANTASTIC? YOU BET IT IS! LOOK WHAT YOU GET FOR 1¢ MORE!

- 10-HUMBUCKER CONTROLS W/KNOB, for TV vertical, horiz., etc. (#5882) 1.29 20 for 1.30
- 50-CAPACITOR SPECIAL, discs, mylars, and more. (#3775) 1.29 100 for 1.30
- 6-HOBBY VOLTAGE REGULATORS, LM-309, 320, 340's, TO-3, (#3330A) 1.29 12 for 1.30
- 12-PANEL SWITCHES, assorted slides, rotaries, modulars, etc. (#295) 1.29 24 for 1.30
- 65-RESISTOR SPECIAL, 1/4 to 1 watt, carbons, carbo-films, etc. (#35896) 1.29 130 for 1.30
- 65-HALF WATT RESISTORS, asstd. carbons, carbo-films, various values, (#454) 1.29 130 for 1.30
- 6-LM340T VOLTAGE REGULATORS, 5 to 24 volts, TO-220, (#5897) 1.29 12 for 1.30
- 60-POLYSTYRENE CAPACITORS, asstd'd values and voltages, (#1052) 1.29 120 for 1.30
- 15-THERMISTORS, resistors that change with the temperature. (#2048) 1.29 30 for 1.30
- 65-1/4 WATT RESISTORS, asstd'd values, metal film, marked. (#5797) 1.29 130 for 1.30
- 1-12VDC SPDT RELAY, 180 ohm coil, 25 mA, 1x1x1 1/2" (#5937) 1.29 2 for 1.30
- 15-VOLUME CONTROLS, asst. values, audio, and switch too! (#592) 1.29 30 for 1.30
- 75-PREFORMED DISC CAPS, handy assortment of values, marked. (#1181) 1.29 150 for 1.30
- 15-AXIAL ELECTROS, assorted values and capacitance, (#5901) 1.29 30 for 1.30
- 100-GLASS ZENERS, 400mW, untested, better than 50% yield, (#5889) 1.29 200 for 1.30
- 10-PC TRIMPOTS, screwdriver adjust, assorted values, (#3346) 1.29 20 for 1.30
- 5-SLIDE VOLUME CONTROLS, assortment of values, duals, singles, (#2318) 1.29 10 for 1.30
- 30-4" CABLE TIES, plastic, like Ty-wrap style, (#5217) 1.29 60 for 1.30
- 5-CRYSTALS, may include; CB, ham, various shapes and sizes, (#5716) 1.29 10 for 1.30
- 30-POWER RESISTORS, assorted types, includes 2 to 10 watters, (#428) 1.29 60 for 1.30
- 30-TWO WATT RESISTORS, carbo-films, carbons, some 5%ers, (#456) 1.29 60 for 1.30
- 60-TERMINAL STRIPS, asstd'd solder and screw types, 2 lugs & up, (#334) 1.29 120 for 1.30
- 1-WATCH GUTS, LED, who knows how good, micro-digital bonanza, (#5115) 1.29 2 for 1.30
- 10-1000V 1A RECTIFIERS, 1N4007, epoxy case, axial leads, (#5926) 1.29 20 for 1.30
- 5-MULTI-DIGIT LED READOUTS, bubble magnifier, 2 to 6 digits, (#3624) 1.29 10 for 1.30
- 15-POWER TAB TRANSISTORS, NPN, plastic, TO-220, (#5898) 1.29 30 for 1.30
- 6-PRECISION TRIM POTS, asstd'd singles and multi-turns, untested, (#3389) 1.29 12 for 1.30
- 50-1N4000 RECTIFIERS, epoxy, axial leads, untested, (#2594) 1.29 100 for 1.30
- 30pc.-HEAT SHRINK, Thermo-fit, useful asst. of sizes, shrinks 50% (#5248) 1.29 60 for 1.30
- 15-SLIDE SWITCHES, SPST, SPDT, etc. all shapes and sizes, (#5927) 1.29 30 for 1.30
- 25-DTL's, 100% prime, asstd'd flip flops, etc., marked, (#3709) 1.29 50 for 1.30
- 25-TTL's, 100% prime, asstd'd flip flops, etc., marked, (#5873) 1.29 50 for 1.30
- 6-HOBBY OPTO COUPLERS, 1500 volt isolation, U-test, (#2629A) 1.29 12 for 1.30
- 8-TAPE RECORDER EARPHONE, for radios, recorders, 8 ohms, (#2946) 1.29 16 for 1.30
- 8-MICRO-MINI JACKS, in a block, for 2mm sub-mini plugs, (#1437) 1.29 16 for 1.30
- 5-PL-55 PHONE JACKS, standard bushing, for hams, communications, (#5868) 1.29 10 for 1.30
- 15-RED DEVIL CAPACITORS, handy assort. of pop. values, axial leads, (#3823) 1.29 30 for 1.30
- 60-MICAS asst. sizes-n-shapes, incl. "silvers" too! (#373) 1.29 120 for 1.30
- 12-TRANSISTOR SOCKETS, for npn and pnp types, (#5944) 1.29 24 for 1.30
- 12-LED DRIVER IC's, similar to 75491, (#5890) 1.29 24 for 1.30
- 10-MODULAR SWITCHES, Centralab "push-on" type, up to 8PDT, (#3150) 1.29 20 for 1.30
- 6-"MOTORS MOTORS", small, high speed, asstd'd sizes, 3-6VDC, (#2551) 1.29 12 for 1.30
- 2-HEAVY DUTY LINE CORDS, 8 ft., 2 cond., 18 gauge, black insulation, (#5803) 1.29 4 for 1.30
- 12-LED SOCKETS, "snap-in" minis, for LEDs, and transistors too! (#5745) 1.29 24 for 1.30
- 15-MV-54 MICRO-MINI LEDS, flat top style, diffused red lens, (#1789) 1.29 30 for 1.30
- 30-WIRE NUTS, twist-on's, for #20-24 gauge wire, (#3724) 1.29 60 for 1.30
- 2-ALUM. HEAT SINKS, 2 3/4" x 3", for power tabs, innumerable uses, (#5338) 1.29 4 for 1.30
- 1-"MICRO MINI" METER, 1/2" dia. 0-1 basic movement (#5858) 1.29 2 for 1.30
- 2-DOUBLE-SIDED PC BOARDS, 3" x 12" high quality G-10 glass, (#5694) 1.29 4 for 1.30
- 60-TUBULAR CAPACITORS, asstd'd 100mmf to .1mf to 600 WVDC, (#35A219) 1.29 120 for 1.30
- 6-MICRO MINI REED SWITCHES, 1" long, for alarms, relays, etc., (#1258) 1.29 12 for 1.30
- 10-TANTELUM ELECTROS, asstd'd mini, axial, hermetically sealed, (#5848) 1.29 20 for 1.30
- 60-DISC TYPE CAPS, incl; NPO, hi-Q, mylar, ceramics, asstd'd values, (#437) 1.29 120 for 1.30
- 60-COILS & CHOKES, asstd'd RF, OSC, IF, parasitic types, (#35A297) 1.29 120 for 1.30
- 10-SWITCHCRAFT PHONO JACKS, hi-Q, chassis mount, teflon base, (#5119) 1.29 20 for 1.30
- 1-TO-3 HEAT SINK, heavy duty aluminum, prepunched for TO-3, (#4083) 1.29 2 for 1.30
- 75-MOLEX SOCKETS, "on-a-strip", for multiple pin dips, (#1609) 1.29 150 for 1.30
- 6-PAIRS 9V BATTERY CLIPS, w/red & black color-coded leads, (#2852) 1.29 12 for 1.30
- 1-UHF TUNER, 3 gang, uhf TV unit, 300 ohm, pos. direct drive, (#2927) 1.29 2 for 1.30
- 15-HUMBUCKER CONTROLS, assorted values, manufacturers dump, (#3807) 1.29 30 for 1.30
- 50-SUBMINI IF TRANSFORMERS, slug tuned, shielded, (#35A9) 1.29 100 for 1.30
- 15-"POP" OPTICAL LENSES, plano-convex, 1" dia., plastic, (#5043) 1.29 30 for 1.30
- 40-ADJUSTABLE FERRITE CORES, center cut for hex adjust, (#5701) 1.29 80 for 1.30

- 3-1.5V MINI LAMPS, only 3/32" dia., draws 15 mA, w/1" wire leads, (#5693) 1.29 6 for 1.30
- 30-FT. WIRE-WRAP WIRE, 30 gauge, insulated, continuous length, (#3803) 1.29 60 for 1.30
- 4-MONO TAPE HEADS, may incl; cassette, 8-track, reel to reel too! (#5789) 1.29 8 for 1.30
- 5-DUAL DIGIT "BUBBLE" READOUTS, HP5082 style, red, dip type (#5748) 1.29 10 for 1.30
- 50-METAL & PLASTIC TRANSISTORS, asstd'd sizes (#1965) 1.29 100 for 1.30
- 2-HI PWR. TRANSISTORS, Motorola type, MJ3201, NPN, 15W, TO-66, (#2797) 1.29 4 for 1.30
- 100-GERM. GLASS DIODES, similar to 1N34, axial leads, untested, (#642) 1.29 200 for 1.30
- 30-1N914 SWITCHING DIODES, silicon, 4nS, glass, untested, (#143) 1.29 60 for 1.30
- 4-AM/FM VARIABLE COND., 2 bands, "poly-con", 3/4" square, (#2924) 1.29 8 for 1.30
- 4-MICRO SWITCHES, SPST, NO contacts, plunger style, solder tabs, (#5785) 1.29 8 for 1.30
- 10-CRYSTAL SOCKETS, 3/16" mt. holes for 1/16" PC leads, (#5527) 1.29 20 for 1.30
- 10-MULTI-GANG POTS, audio 2 gangs and up, asstd'd types and values, (#5326) 1.29 20 for 1.30
- 10-MAN-3's, 7 segment, w/bubble magnifier, 100% material, (#3842) 1.29 20 for 1.30
- 3-PL-259 COAX PLUG, mates to 50-239, Amphenol, (#5221) 1.29 6 for 1.30
- 1-LITE SENSITIVE UNIJUNCTION TRANSISTOR, programmable, (#5719) 1.29 2 for 1.30
- 1-LASCR OPTO COUPLER, type H11C3, mini dip, (#5700) 1.29 2 for 1.30
- 4-MINI BLOCK READOUTS, .122", red, type FND-10, (#5913) 1.29 8 for 1.30
- 3-LINE CORDS, 6 ft. 18 gauge, 2 cond. white w/plug, (#3787) 1.29 6 for 1.30
- 15-SINGLE PIN MICRO RED LEDS, 100% material, 3 volts @ 10 mils, (#5896) 1.29 30 for 1.30
- 50-FEEDTHRU CAPACITORS, used for hams, RF, UHF circuitry, (#5847) 1.29 100 for 1.30
- 40-PLASTIC TRANSISTORS, asstd'd untested and hobby, (#2604A) 1.29 80 for 1.30
- 5-6V INDICATORS, w/leads, test lamp manufacturers excess, (#5893) 1.29 10 for 1.30
- 40-METAL CAN TRANSISTORS, asstd'd types, hobby, untested, (#2603A) 1.29 80 for 1.30
- 15-UPRIGHT ELECTROS, 100% asstd'd values and voltages, (#5900) 1.29 30 for 1.30
- 4-SEMI-CON SUPRISE, zeners, rectifiers, transistors, etc, U-test, (#2226) 1.29 80 for 1.30
- 100-STABISTORS, axial, for regulators & computers, U-test, (#3140) 1.29 200 for 1.30
- 40-SQUARE PC COILS, uprights, assorted values, for PC applications, (#3188) 1.29 80 for 1.30
- 50-1 WATT ZENERS, 3.3, 8, 10, 12, 15V, etc., double plug, untested, (#1964) 1.29 100 for 1.30
- 4-ROCKER SWITCHES, DPDT, solder eyelet terminals, (#3302) 1.29 8 for 1.30
- 60-LONG LEAD DISCS, 100% prime, marked capacitors, (#5899) 1.29 120 for 1.30
- 6-MINI TRANSFORMERS, asstd'd outputs, interstage & audio, 1" sq. (#3295) 1.29 12 for 1.30
- 1-TV/AUDIO SHIELDED CABLE, 2 cond. 15 ft. w/RCA phone plugs, (#5812) 1.29 2 for 1.30
- 25-DATA ENTRY KEYCAPS, 3/4" sq. H's & functions, asst. colors, (#4013) 1.29 50 for 1.30
- 2-GE 3W AUDIO AMP, type PA-263 IC chip, mono, (#1522) 1.29 4 for 1.30
- 1-MERCURY TILT SWITCH, N.C. rated 24VDC @ .05A, w/leads, (#5686) 1.29 2 for 1.30
- 6-POWER TAB TRIACS, 100% prime, 100V, TO-220, (#5888) 1.29 12 for 1.30
- 6-POWER TAB SCR's, 100% prime, 100V, TO-220, (#5904) 1.29 12 for 1.30
- 3-WATCH LCD's, 3-1/2 digit, asst. types, size: 1" x 1-1/2" (approx.), (#5066) 1.29 6 for 1.30
- 10-TV INTERLOCK JACKS, for TV/power mt. ctr, solder tab terms, (#5519) 1.29 20 for 1.30
- 4-MOS FETS, 3N128, by Fairchild & RCA, TO-18, some duals, (#1686) 1.29 8 for 1.30
- 4-PHOTO ELECTRIC DARLINGTON TRANSISTORS, 2N5777, (#3276) 1.29 8 for 1.30
- 6-AC "UTILITY" OUTLETS, for 1 1/4" mt. ctr., solder lugs, (#3582) 1.29 12 for 1.30
- 15-NE-2 LAMPS, neon red, for 110VAC, less resistor, (#1435) 1.29 30 for 1.30
- 20-1N4148 SWITCHING DIODES, 4nS, 100V @ 10mA, axial 100%, (#3000) 1.29 40 for 1.30
- 2-4 AMP SILICON BRIDGE RECTIFIER, 200V, block style, (#5928) 1.29 4 for 1.30
- 4-VARACTOR DIODES, var. tuner capacitance, 20-50 pf. (#5887) 1.29 8 for 1.30
- 50-PRECISION RESISTORS, 1/2, 1, & 2 watts, 1%, assorted types, (#363) 1.29 100 for 1.30
- 60-CERAMIC CAPS, asstd'd val. & styles, incl; tubulars, NPO's, etc., (#590) 1.29 120 for 1.30
- 25-PLASTIC SCR's, incl; 200V, untested, high yield, TO-92, (#3192) 1.29 50 for 1.30
- 35-MOLDED CAPACITORS, tubular, asstd'd volt. to 1 mf. axial leads (#348642) 1.29 70 for 1.30
- 100-MICRO ZENER & RECT. KIT, asstd'd voltages, only 1/8" sq. U-test, (#1251) 1.29 200 for 1.30
- 1-LINE CORD, 8 ft. 2 cond, 16 gauge, vinyl molded plug & grommet (#3661) 1.29 2 for 1.30
- 6-SPDT MICRO SLIDE SWITCH, only 3/7" cube, for PC mount, (#3429) 1.29 12 for 1.30
- 10-PR.-RCA PLUGS & JACKS, for audio, speakers, etc., (#402) 1.29 20 for 1.30
- 7-2N3055 HOBBY TRANSISTORS, 100%, TO-3, (#3771) 1.29 14 for 1.30
- 20-ZENERS, 1 watt 9.1 volts axial leads 100% (#5370A) 1.29 40 for 1.30
- 40-1N4148, 4 NANO. SWITCHING DIODE, axial leads untested (#5923) 1.29 80 for 1.30
- 2-RELAYS, BABCOCK 6VDC, SPST, plastic case (#5807) 1.29 4 for 1.30
- 1-25 AMP BRIDGE RECTIFIER, 50 volts, 100% (#5948) 1.29 2 for 1.30
- 2-QUADRACS, 10 amp 200 PRV, TO-220 100% (#5915) 1.29 4 for 1.30
- 15-PNP SWITCHING TRANSISTORS, 2N404, 1305 etc. TO-5 (#5911) 1.29 30 for 1.30
- 60-MINI RESISTORS, 30-1/2W, 30-1/4 watt, axial, color coded, (#5922) 1.29 120 for 1.30
- 12-SCR5-TRIAC-QUADRACS, asst. volts. TO-220 case (#2087) 1.29 24 for 1.30

"SKINNY-TRIMS" POTENTIOMETERS

3/8" square! Single turn style screw driver adjust. 20% tolerance. 0.5 Watt ratings, cermet construction. PV leads. ORDER BY CAT. NO. AND VALUE

92CU3866

6 for \$2.49

12 for \$2.50

TYPE-B3 SINGLE TURN FLAT

10	100	1K	5K	25K	200K
20	200	2K	10K	50K	500K
50	500	2.5K	20K	100K	1Meg

HY GAIN LED CLOCK KIT*

Panel or case design • 3 PC set

Kit consists of a 3 pc set, transformer, function switches on a board, and a National MA1012-12A digital clock module with all parts and IC chip mounted on a 3" x 1 3/8" G-10 pc board. The RED filtered module measures 3" x 3/4" x 3/16". The PC board module is mounted in a bakelite frame 3 7/8" x 1 3/4" x 1/8" with 2 holes for easy panel mounting. 1 3/4" on center!

\$12.50

2 for \$12.51

Cat. No. 92CU5643

POLY PAKS®

(COD'S MAY BE PHONED)

P.O. BOX 942-A9
SO. LYNNFIELD, MA
01940

Terms: Add Postage Rated: Net 30
Phone: (617) 245-3828
Retail: 16-18 Del Carmine St
Wakefield, MA

MINIMUM ORDER: \$8

HOW TO ORDER

When ordering, always use catalog number, type no., the name of the magazine you are ordering from and the month

7294 N.W. 54 STREET
MIAMI, FLORIDA 33166

SURPLUS ELECTRONICS CORP. ✓S43

PHONE: (305) 887-8228

TWX: 810-848-6085

WHOLESALE - RETAIL

<p>PL259's/SO 239's Quality American Made 10/\$5.00 100/\$35.00 50/\$20.00 1000/\$300.00</p>	<p>CB SPECIAL Brand new printed circuit board assembly. Used in all HyGain 40 channel CB transceivers. Fits many other manufacturers' units also. Squelch pot/volume control/channel selector switch not included. 1- 9—7.50 ea. 50-99—6.00 ea. Board Dimensions 6" x 6 1/2" 10-49—6.50 ea. 100-up—5.50 ea.</p>		<p>IC SOCKETS Cambion Gold Plated Wire Wrap 14 pin .35 ea 10/\$3.00 16 pin .38 ea 10/\$3.30</p>																																																																																																																				
<p>E. F. Johnson NICAD 12.0 V. 1.2 AH @ 10 hr rate 4 1/2" x 1 7/8" x 1 3/4" \$1495ea.</p>	<p>NEW Hy-Gain Remote 40ch CB Less Case, Speaker & Control Mic (as is) \$14.95 ea</p>		<p>SIGNAL DIODE IN 4148 \$5.00 PER 100 25.00 PER 1000 OR 15 FOR \$1.00</p>																																																																																																																				
<p>E F Johnson External Battery Charger Model 239-0206-001 Output 14.5 V dc @ 50 mA. \$3.50 ea.</p>	<p>Serviceman Special New Hy-Gain 40ch CB Less Case, Speaker & Knobs (as is) \$14.95 ea</p>		<p>MODEM CABLE 50' cable contains 13 # 22 ga. wire DB-25p with DB-51226-1 cover on one end \$6.50 ea 10/\$50.00</p>																																																																																																																				
<p>E. F. Johnson S Meter Edge Meter 250 UA. Fits in 5/8" x 1-3/8" hole. MTG holes on each end 1-1/4" behind panel. Black scale 0-5 bottom 1-20 top \$1.25 ea. 5/\$5.00</p>	<p>ASTATIC T-UG8-D104 PREAMP Desktop microphone w/crystal element 3 Pin Plug \$35 ea.</p>	<p>NEW E.F. Johnson Power Mic/Less Cord, Desktop Style \$19.95 ea</p>		<p>EFJ CRYSTAL OVENS 6V/12V 75° \$5.00 ea.</p>																																																																																																																			
<p>Edge meter same as above with silver scale and reads SWR 1-10 \$1.25ea 5/\$5.00</p>	<p>New 40 CH CB Boards 1-9 \$10.50 ea 10-49 \$9.50 ea w/40 ch SW 50-99 \$9.00 ea 100-up \$8.50 ea</p>		<p>SOLDER LUG-TYPE CAPS 50 UF @ 350V 1" D x 3" L 50 UF @ 450V 1" D x 2 1/2" L 50 UF @ 450V 1" D x 3" L 60¢ EA. 5 FOR \$2.50</p>																																																																																																																				
<p>E. F. Johnson Signal Strength Meter 200 UA 2 1/2" x 2 1/2" Sq. mounts in 1 3/4" hole 1" behind panel. Scale: 1-30 db top 0-5 bottom. \$4.95ea 5/\$20.00</p>	<p>22 pins/Double Row/Dipped Solder .156 \$2.08 ea 10/\$17.00</p>		<p>22 pins/Double Row/Wire Wrap .156 \$2.44 ea 10/\$19.00</p>		<p>Double Row/Solder Eyelet .156 6 pins \$1.10 ea 10/\$ 9.00 15 pins \$1.55 ea 10/\$12.50 22 pins \$2.08 ea 10/\$17.00 43 pins \$3.66 ea 10/\$30.00</p>																																																																																																																		
<p>PANEL METERS \$4.00 ea 2 for \$7.00 25-0-25 dc Volts } 2 1/4" x 3" 0-25 dc Volts } 2 1/4" x 2 1/4" 0-50 ac Volts } -Shunt Required-</p>		<p>MINI TOGGLE SW C&H SPDT \$1.00 ea 6/\$5.00</p>	<p>2 SIDED .062 Copper Clad Board 9 1/4" x 10 3/4" \$2.00ea 3/\$5.00</p>	<p>Sony RK64A 2 conductor mini phono plug w/patch cord 3 6" long \$2.00ea</p>	<p>100 ASSORTED DISC CAPS (FULL LEADS) 20 EA OF 5 DIFFERENT VALUES \$2.00 PER PACK</p>																																																																																																																		
<p>Double Row/Wire Wrap .100 25 pins \$3.49 ea 10/\$30.00 30 pins \$3.96 ea 10/\$32.00 50 pins \$5.43 ea 10/\$45.00</p>		<p>12 Vdc RELAY SPST Open Frame 5 Amp Contacts Mfg-Magnecraft \$1.50 ea 4/\$5.00</p>		<p>STANCOR TRANSFORMERS STEP-DOWN AUTO (3) COND LINE CORD W/RECPT GSD 200 (230V In/115V Out @ 200 Va) \$12.00 ea GSD 400 (230 In/115 V Out @ 400 Va) \$14.50 ea</p>		<p>RECEIVER FRONT ENDS Made by EFJ 132-174 MHz \$12.00 ea.</p>																																																																																																																	
<p>C & K SWITCHES PART # MOVEMENT 7101 ON/NONE/ON SPST 7103 ON/OFF/ON SPST 7107 ON/NONE/ON SPST 7108 ON/NONE/(ON) SPST 7201 ON/NONE/ON DPDT \$1.00 EA 6 FOR \$5.00</p>		<p>12 Vdc RELAY SPST 35 Amp Contacts Open Frame Rugged, great for mobile use \$4.50 ea 5/\$20.00</p>		<p>CRYSTAL FILTERS 10.7 3/Lead Can Type \$3.00 ea.</p>		<p>TRIMMER CAPS Small enough to fit in your watch— 3.5 to 20 pF 5 to 30 pF \$.75 ea., 2 for \$1.25 5 for \$3.00</p>																																																																																																																	
<p>6 TV GAMES ON (1) CHIP Gen Instr AY-3-8500-1 28 Pin Plastic Case EVERYDAY LOW PRICE \$7.50 ea</p>		<p>Coax Connectors UG-273/U BNC-F/UHF-M 2.50 UG-255/U BNC-M/UHF-F 3.00 UG-146A/U N-M/UHF-F 4.50 UG-83B/U N-F/UHF-M 4.50 UG-175 RG-58 Adapt. .20 UG-176 RG-59 Adapt. .20</p>		<p>CERAMIC IF FILTERS EFC L455K \$3.50 ea.</p>		<p>CAPS 2200 UF @ 16V Radial Leads .25 ea. 10/\$2.00</p> <p>White Porcelain Egg Insulator 1 1/2" x 1" 50¢ ea. 3 for \$1.25</p>																																																																																																																	
<p>ASSORTED ELECTROLYTICS</p> <table border="1"> <thead> <tr> <th>VALUE/MFD</th> <th>VOLTS</th> <th>DIA</th> <th>LENGTH</th> <th>PRICE</th> <th>21,000</th> <th>@</th> <th>25V</th> <th>2 1/2"</th> <th>x</th> <th>3"</th> <th>3.00 ea</th> </tr> </thead> <tbody> <tr> <td>250,000</td> <td>5V</td> <td>3"</td> <td>5 3/4"</td> <td>\$4.00 ea</td> <td>39,000</td> <td>@</td> <td>45V</td> <td>3"</td> <td>x</td> <td>5 3/4"</td> <td>3.00 ea</td> </tr> <tr> <td>30,000</td> <td>15V</td> <td>3"</td> <td>4 1/2"</td> <td>4.00 ea</td> <td>1,000</td> <td>@</td> <td>50V</td> <td>1 1/4"</td> <td>x</td> <td>3 1/4"</td> <td>2.50 ea</td> </tr> <tr> <td>63,000</td> <td>15V</td> <td>3"</td> <td>5 1/2"</td> <td>4.00 ea</td> <td>34,800</td> <td>@</td> <td>50V</td> <td>3"</td> <td>x</td> <td>5 1/2"</td> <td>3.00 ea</td> </tr> <tr> <td>10,000</td> <td>20V</td> <td>1 1/2"</td> <td>5 3/4"</td> <td>3.00 ea</td> <td>450</td> <td>@</td> <td>75V</td> <td>1 1/4"</td> <td>x</td> <td>2 1/4"</td> <td>2.00 ea</td> </tr> <tr> <td>2,700</td> <td>25V</td> <td>1 1/4"</td> <td>2 1/4"</td> <td>2.00 ea</td> <td>500</td> <td>@</td> <td>100V</td> <td>1 1/2"</td> <td>x</td> <td>3 1/2"</td> <td>2.00 ea</td> </tr> <tr> <td>2,900</td> <td>25V</td> <td>1 1/4"</td> <td>2"</td> <td>2.00 ea</td> <td>240</td> <td>@</td> <td>300V</td> <td>1 1/4"</td> <td>x</td> <td>3 1/4"</td> <td>2.00 ea</td> </tr> <tr> <td>3,000</td> <td>25V</td> <td>1 1/2"</td> <td>4 1/2"</td> <td>2.00 ea</td> <td>50</td> <td>@</td> <td>450V</td> <td>1 1/4"</td> <td>x</td> <td>2"</td> <td>2.00 ea</td> </tr> <tr> <td>18,000</td> <td>25V</td> <td>2"</td> <td>4"</td> <td>3.00 ea</td> <td>140</td> <td>@</td> <td>450V</td> <td>1 1/4"</td> <td>x</td> <td>3"</td> <td>2.00 ea</td> </tr> </tbody> </table>												VALUE/MFD	VOLTS	DIA	LENGTH	PRICE	21,000	@	25V	2 1/2"	x	3"	3.00 ea	250,000	5V	3"	5 3/4"	\$4.00 ea	39,000	@	45V	3"	x	5 3/4"	3.00 ea	30,000	15V	3"	4 1/2"	4.00 ea	1,000	@	50V	1 1/4"	x	3 1/4"	2.50 ea	63,000	15V	3"	5 1/2"	4.00 ea	34,800	@	50V	3"	x	5 1/2"	3.00 ea	10,000	20V	1 1/2"	5 3/4"	3.00 ea	450	@	75V	1 1/4"	x	2 1/4"	2.00 ea	2,700	25V	1 1/4"	2 1/4"	2.00 ea	500	@	100V	1 1/2"	x	3 1/2"	2.00 ea	2,900	25V	1 1/4"	2"	2.00 ea	240	@	300V	1 1/4"	x	3 1/4"	2.00 ea	3,000	25V	1 1/2"	4 1/2"	2.00 ea	50	@	450V	1 1/4"	x	2"	2.00 ea	18,000	25V	2"	4"	3.00 ea	140	@	450V	1 1/4"	x	3"	2.00 ea
VALUE/MFD	VOLTS	DIA	LENGTH	PRICE	21,000	@	25V	2 1/2"	x	3"	3.00 ea																																																																																																												
250,000	5V	3"	5 3/4"	\$4.00 ea	39,000	@	45V	3"	x	5 3/4"	3.00 ea																																																																																																												
30,000	15V	3"	4 1/2"	4.00 ea	1,000	@	50V	1 1/4"	x	3 1/4"	2.50 ea																																																																																																												
63,000	15V	3"	5 1/2"	4.00 ea	34,800	@	50V	3"	x	5 1/2"	3.00 ea																																																																																																												
10,000	20V	1 1/2"	5 3/4"	3.00 ea	450	@	75V	1 1/4"	x	2 1/4"	2.00 ea																																																																																																												
2,700	25V	1 1/4"	2 1/4"	2.00 ea	500	@	100V	1 1/2"	x	3 1/2"	2.00 ea																																																																																																												
2,900	25V	1 1/4"	2"	2.00 ea	240	@	300V	1 1/4"	x	3 1/4"	2.00 ea																																																																																																												
3,000	25V	1 1/2"	4 1/2"	2.00 ea	50	@	450V	1 1/4"	x	2"	2.00 ea																																																																																																												
18,000	25V	2"	4"	3.00 ea	140	@	450V	1 1/4"	x	3"	2.00 ea																																																																																																												

TERMS: All material guaranteed • If for any reason you are not satisfied, our products may be returned within 10 days for a full refund (less shipping). Please add \$3 for shipping and handling on all orders. Additional 5% charge for shipping any item over 5 lbs. COD's accepted for orders totaling \$50.00 or more. All orders shipped UPS unless otherwise specified. Florida residents please add 4% sales tax. Minimum order \$15.00.

EQUIPMENT / COMPONENTS / WIRE & CABLE / ACCESSORIES

SEMICONDUCTORS SURPLUS

✓ S63

2822 North 32nd Street/Unit -1 Phoenix, Arizona 85008 (602) 956-9423

We accept checks, MasterCard, and Visa

Prices subject to change without notice

R.F. CONNECTORS

UG-1095A/U	\$3.99
UG-58/U	3.29
UG-30C/U	3.00
UG-27C/U	3.50
PL-259	.50
SO-239	.43
UG-175	.36
PL-258	2.99
UG-106	.69
UG-177	.69
UG-274/U	3.27
UG-447/U	1.50
UG-492	3.69
UG-306/U	3.00
UG-646/U	3.29
UG-260B/U	1.59
UG-1094/U	.90
UG-701/U	3.00
UG-212C/U	3.00

TUBES

3-500Z	\$90.00
572B/T160L	34.00
6146	5.09
6146A	5.99
6-46W	7.95
811A	12.95
811	9.95
4CX250B	36.95
4CX250R	39.95
6KD6	4.99
6LF6	4.99
6LQ6/6JE6	6.25
8950	6.65
2E26	6.00
3B28	5.00
4X150A	15.00
6360/A	7.95
6939	5.95
7289/2C39	4.95
8072	45.00
4-400A	90.00
8877	300.00
PL172	250.00
4-1000A	160.00
4-250A	35.00

FERRITE BEADS

12/\$.89 or
100/\$4.00

1N914/1N4148

30/\$1.00 or
120/\$3.00

R.F. TRANSISTORS

2N2857	\$1.80
2N2857JAN	2.45
2N2947	17.00
2N3375	7.00
2N3553	1.80
2N3818	6.00
2N3866	1.09
2N3866JAN	2.70
2N2866JANTX	4.43
2N3925	6.00
2N3948	2.00
2N3950	26.25
2N3960	4.70
2N4072	1.70
2N4427	1.09
2N4877	2.57
2N4957	3.50
2N5108	3.90
2N5109	1.55
2N5179	.59
2N5589	4.60
2N5583	5.00
2N5590	6.30
2N5591	10.35
2N6080	5.45
2N6081	8.80
2N6082	10.75
2N6083	12.00
2N6084	13.20
2N6095	10.35
2N6097	19.35
MRF502	.69
MRF8004	.75
SS2548	.75
40280	3.50
40281	10.90
40282	11.90

TRIMMERS 5-80pf

45¢ each or 10/3.50
or 100/25.00

CHOKE (U252) 2.5mh

150ma 30MHz
2/\$1.00

TRIMMER CAPS

small enough to
fit in your watch
3.5-11pf 75¢ each
or 10/\$6.00

PISTON CAPS 1.2-10pf

75¢ each or 10/\$5.50

F.E.T.'s

MPF4391	\$.75 or 10/ 6.50
MPF112	.69 or 10/ 5.50
MPF102	.43 or 10/ 3.50
40673	1.39 or 10/10.00
3N128	1.35 or 10/10.00
2N5248	.60 or 10/ 4.50
MPF131	.60 or 10/ 5.00
2N4303	.45 or 10/ 3.50
2N3958	2.95 each
MFE2000	.90 or 10/ 8.00
MFE2001	.99 or 10/ 8.00
MFE2008	4.20 or 10/36.00
MFE2009	4.80 or 10/39.00
MFE3002	3.35 each
MMF-5	5.00 each
MFE120	1.00 or 10/ 8.50
2N3436	2.25 each
2N4416	1.00 each
MFE131	1.05 each

MICROWAVE DIODES

1N21D	\$ 1.40
1N21C	1.05
1N21WE	2.00
1N23B	1.05
1N23C	1.05
1N23CR	2.00
1N23E	2.00
1N23F	4.10
1N23WE	2.10
1N25	3.03
1N121WE	4.00
1N286	5.00
1N416E	5.00
1N446	8.00
1N3655A	4.00
1N5153	15.00
1N5711	1.20

ADDITIONAL R.F. TRANSISTORS

40894	\$ 2.50
MRF454/568BLYCF	17.10

BRIDGES 24 AMPS

500PIV \$2.99 each

LM566V VCO/FUNCTION GENERATOR

\$.99 each

LM340T-5 & LM340T-12

\$1.49 each

VACUUM CAPACITORS

Amperex Model CVC
10/1k-5KV405A 10 pf to 1000
pf @5000 volts \$59.95

MC4024P & MC4044P

\$3.25 each

HEP 170 2.5 Amps

1000PIV 10/\$2.00 or 100/\$14.50

POTTER & BRUMFIELD 12VDC RELAYS

SPDT	25 Amps	\$5.95
2PDT	3 Amps	\$1.99

KILOVAC H-8/54 VACUUM RELAY

26 volt coil \$29.95 each

E. F. JOHNSON TUBE SOCKETS

for 3-400Z and
3-5000Z tubes \$29.95 per pair

TOROIDAL CORES

T-37-6	6/1.00
25/4.00,	50/6.00
100/10.00	

4CX250B/R SOCKETS AND CHIMNEYS NEW

\$14.95 per set (1 socket, 1
chimney)

B&W COILS

1206T	\$3.99
2006T	\$7.99

FAIRCHILD REGULATOR 78H05KC

\$6.99 each

TUBES

6146B \$6.50

MINIMUM ORDER \$5.00

Minimum Shipping \$1. Insurance 35¢
per \$100. COD charges 85¢ to street ad-
dress only! We prefer street address as
we ship UPS and P.O. Box #'s take up to
50% longer to deliver. We accept VISA
or MasterCard. Please list complete
card number and expiration date. Allow
10% extra for shipping of heavy items.
We reserve the right to change prices
without notice. All items listed are sub-
ject to prior sale. Some items listed are
in small quantities.

BULLET ELECTRONICS

P.O. BOX 401244E
GARLAND, TX 75040
(214) 278-3553

WE APOLOGIZE!

* Phone orders accepted on credit card orders

JUST WHEN IT LOOKED LIKE ALL THE HOOPLA ABOUT OUR LOW COST HIGH CURRENT REGULATED PS-14 POWER SUPPLY KIT WAS FADING AWAY AND OUR COMPETITORS COULD BREATHE A LITTLE EASIER, WE GO AND DO SOMETHING LIKE THIS!

PS-15 POWER SUPPLY KIT 12V 30 AMPS

SPECS:

CONTINUOUS CURRENT	30 AMPS
REGULATION	200 MV LOAD AND LINE
RIPPLE	LESS THAN 300MV @ 30A
CURRENT LIMIT	ADJUSTABLE FOLDBACK TYPE
VOLTAGE OUTPUT	ADJUSTABLE 11.5 TO 14 VDC
SAFETY FEATURES	SHORT CIRCUIT PROTECTION; THERMAL SHUTDOWN; RF BY-PASSED

YOU GET:

- HUGE 40 AMP TRANSFORMER
- 3 LARGE HEATSINKS
- DRILLED & PLATED PC BOARD
- LARGE COMPUTER GRADE CAP
- ALL ELECTRONIC PARTS
- FUSES, FUSEHOLDERS, LINE CORD WIRE, MICA INSULATORS
- COMPLETE STEP-BY-STEP INSTRUCTIONS
- COMPLETE WARRANTY AND REPAIR SERVICE
- WE PAY SHIPPING!*

PRICE DOES NOT INCLUDE CHASSIS, METERS OR JACKS

PS-14 Power Supply Kit.

Same features as above but 20 AMP max current. SHIPPING PAID. **45.00**

Regulator Card &
Components: **14.95**

59.95

*Canadian Orders add \$10.00 for Shipping and Insurance.

OVP-2 OVERVOLTAGE PROTECTOR

Protect your expensive gear from overvoltage from transients or power supply malfunctions. Use with any fused power supply. Compatible with PS-14 or PS-15. Adjustable 10-20 VDC

MATCHED METER SET

A quality pair of American Made 3 1/2" rectangular panel meters. 5% Accuracy. Modern styling.

12.95 set

SET 0-15VDC, 0-30ADC

SPECIAL PACKAGE:

PS-15, OVP-2 AND METERS

75.00

SHIPPING PAID

SE-01 SOUND EFFECTS KIT

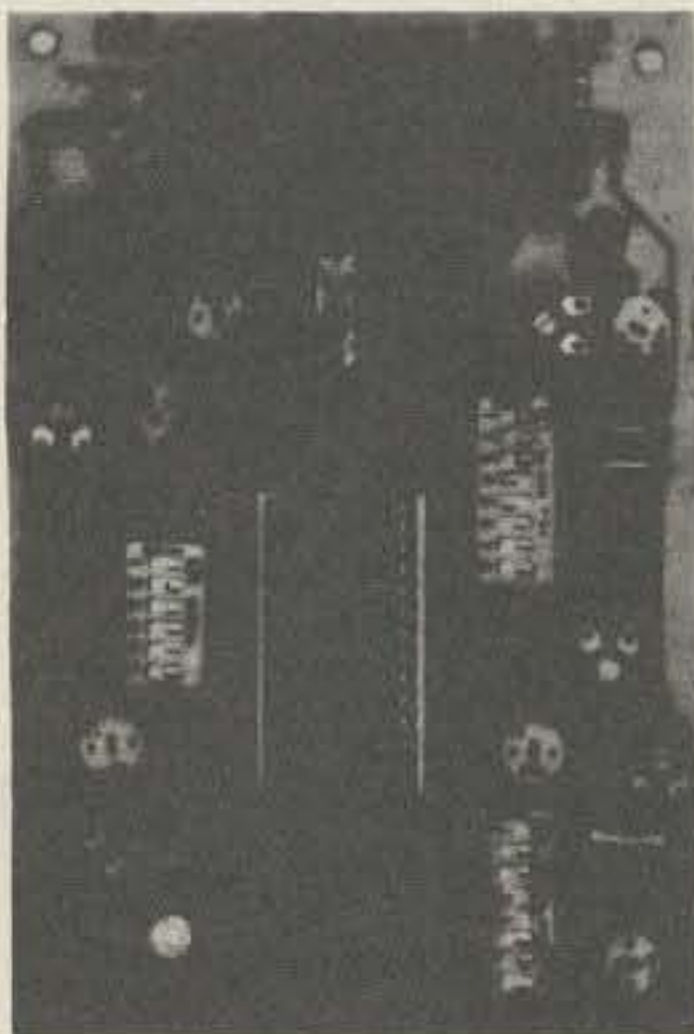

- ALL PARTS
- COMPLETE INSTRUCTIONS
- QUALITY PLATED & DRILLED BOARD
- IC SPECS INCLUDED
- RUNS ON ONE 9-VOLT BATTERY
- SMALL 3 1/2" x 5"

\$16.95
LESS SPEAKER & BATTERY

• 76477 CHIP IS INCLUDED. EXTRA CHIPS \$2.95 EACH

OTHERS WILL SELL YOU THE CHIP, BUT ONLY BULLET CAN FURNISH YOU A COMPLETE KIT OF ALL THE PARTS YOU NEED TO PUT THE T.I. 76477 SOUND CHIP THROUGH ITS PACES! WE INCLUDE SPECS AND PROGRAMMING CHARTS. YOU WILL BE AMAZED AT THE THOUSANDS OF SOUND EFFECTS YOU CAN PRODUCE WITH OUR KIT! MAKE PHASOR GUN, STEAM TRAIN, GUNSHOT AND OTHER SOUNDS. BOARD HAS AUXILIARY PULSE GENERATOR, COMPARATOR AND MULTIPLEX OSC FOR EVEN MORE VERSATILITY.

7 WATT AUDIO AMP KIT

SMALL, SINGLE HYBRID IC AND COMPONENTS FIT ON A 2" x 3" PC BOARD (INCLUDED). RUNS ON 12 VDC. GREAT FOR ANY PROJECT THAT NEEDS AN INEXPENSIVE AMP. LESS THAN 3% THD @ 5 WATTS. COMPATIBLE WITH SE-01 SOUND KIT.

\$5.95

6 DIGIT AUTO/VAN CLOCK

- LARGE 1/2" CHARACTERS (LED)
- QUARTZ XTAL TIMEBASE
- ALARM & SNOOZE OPTIONS
- NOISE FILTERING
- EASY TO ASSEMBLE
- 4 5/8" x 3" x 1 1/2"
- DRILLED & PLATED PC BOARDS

COMPLETE KIT
12 VDC

\$16.95

ULTRASONIC RELAY KIT

INVISIBLE BEAM WORKS LIKE A PHOTO ELECTRIC EYE. USE UP TO 25 FT. APART. COMPLETE KIT. ALL PARTS & PC BOARDS.

\$21.50

LED'S

JUMBO GREEN	4/.89
JUMBO RED	5/.89
MEDIUM RED (1/8")	.15
MEDIUM GRN OR YELLOW	.16

- NO COD'S
- SEND CHECK, M.O., M.C. OR VISA
- ADD 5% FOR SHIPPING
- CATALOG FREE UPON REQUEST
- ORDERS UNDER \$10 ADD 75c
- TEX. RESIDENTS ADD 5% SALES TAX
- FOREIGN ADD 10%

DIODES/ZENERS			
QTY.			
1N914	100v	10mA	.05
1N4005	600v	1A	.08
1N4007	1000v	1A	.15
1N4148	75v	10mA	.05
1N4733	5.1v	1 W Zener	.25
1N4749	24v	1W	.25
1N753A	6.2v	500 mW Zener	.25
1N758A	10v	"	.25
1N759A	12v	"	.25
1N5243	13v	"	.25
1N5244B	14v	"	.25
1N5245B	15v	"	.25
1N5349	12v	3W	.25

SOCKETS/BRIDGES			
QTY.			
8-pin	pcb	.16 ww	.35
14-pin	pcb	.20 ww	.40
16-pin	pcb	.25 ww	.45
18-pin	pcb	.30 ww	.95
20-pin	pcb	.35 ww	1.05
22-pin	pcb	.40 ww	1.15
24-pin	pcb	.45 ww	1.25
28-pin	pcb	.50 ww	1.35
40-pin	pcb	.55 ww	1.45
Molex pins	.01	To-3 Sockets	.35
2 Amp Bridge		100-prv	.95
25 Amp Bridge		200-prv	1.50

TRANSISTORS, LEDS, etc.			
QTY.			
2N2222M	(2N2222 Plastic .10)		.15
2N2222A			.19
2N2907A	PNP		.19
2N3906	PNP (Plastic)		.19
2N3904	NPN (Plastic)		.19
2N3054	NPN		.55
2N3055	NPN 15A 60v		.60
T1P125	PNP Darlington		1.95
LED Green, Red, Clear, Yellow			.19
D.L.747	7 seg 5/8" High com-anode		1.95
MAN72	7 seg com-anode (Red)		1.25
MAN3610	7 seg com-anode (Orange)		1.25
MAN82A	7 seg com-anode (Yellow)		1.25
MAN74	7 seg com-cathode (Red)		1.50
FND359	7 seg com-cathode (Red)		1.25

9000 SERIES			
QTY.		QTY.	
9301	.85	9322	.65
9309	.50	9601	.30
		9602	.45

C MOS					
QTY.		QTY.		QTY.	
4000	.15	4017	.75	4034	2.45
4001	.20	4018	.75	4035	.75
4002	.25	4019	.35	4037	1.80
4004	3.95	4020	.85	4040	.75
4006	.95	4021	.75	4041	.69
4007	.25	4022	.75	4042	.65
4008	.75	4023	.25	4043	.50
4009	.35	4024	.75	4044	.65
4010	.35	4025	.25	4046	1.25
4011	.30	4026	1.95	4047	2.50
4012	.25	4027	.35	4048	1.25
4013	.40	4028	.75	4049	.65
4014	.75	4029	1.15	4050	.45
4015	.75	4030	.30	4052	.75
4016	.35	4033	1.50	4053	.95
				4066	.75
				4069/74C04	.45
				4071	.25
				4081	.30
				4082	.30
				4507	.95
				4511	.95
				4512	1.50
				4515	2.95
				4519	.85
				4522	1.10
				4526	.95
				4528	1.10
				4529	.95
				MC14409	14.50
				MC14419	4.85
				74C151	2.50

MICRO's, RAMS, CPU's, E-PROMS	
QTY.	
8T13	2.50
8T23	2.50
8T24	3.00
8T97	1.75
74S188	3.00
1488	1.25
1489	1.25
1702A	4.50
AM 9050	4.00
ICM 7207	6.95
ICM 7208	13.95
MPS 6520	10.00
MM 5314	4.00
MM 5316	4.50
MM 5387	3.50
MM 5369	2.95
TR 1602B	3.95
UPD 414	4.95
Z 80 A	22.50
Z 80	17.50
Z 80 P10	10.50
2102	1.45
2102L	1.75
2107B-4	4.95
2114	9.50
2513	6.25
2708	11.50
2716 D.S.	34.00
2716 (5v)	69.00
2758 (5v)	26.95
3242	10.50
4116	11.50
6800	13.95
6850	7.95
8080	7.50
8085	22.50
8212	2.75
8214	4.95
8216	3.50
8224	4.25
8228	6.00
8251	7.50
8253	18.50
8255	8.50
TMS 4044	9.95

- T T L -							
QTY.		QTY.		QTY.		QTY.	
7400	.20	7492	.45	74H20	.25	74LS76	.70
7401	.20	7493	.35	74H21	.25	74LS86	.95
7402	.20	7494	.75	74H22	.40	74LS90	.85
7403	.20	7495	.60	74H30	.30	74LS93	.85
7404	.20	7496	.80	74H40	.35	74LS96	2.00
7405	.35	74100	1.15	74H50	.30	74LS107	.90
7406	.25	74107	.35	74H51	.30	74LS109	1.50
7407	.55	74121	.35	74H52	.20	74LS123	1.95
7408	.20	74122	.55	74H53	.25	74LS138	2.00
7409	.25	74123	.55	74H55	.25	74LS151	.95
7410	.20	74125	.45	74H72	.35	74LS153	1.15
7411	.25	74126	.45	74H74	.35	74LS157	1.15
7412	.25	74132	.75	74H101	.95	74LS160	1.15
7413	.45	74141	.90	74H103	.55	74LS164	2.90
7414	.75	74150	.85	74H106	1.15	74LS193	2.00
7416	.25	74151	.95	74L00	.30	74LS195	1.15
7417	.40	74153	.95	74L02	.30	74LS244	2.90
7420	.25	74154	1.15	74L03	.35	74LS259	1.50
7426	.25	74156	.70	74L04	.40	74LS298	1.50
7427	.25	74157	.65	74L10	.30	74LS367	1.95
7430	.20	74161/9316	.75	74L20	.45	74LS368	1.25
7432	.30	74163	.85	74L30	.55	74LS373	2.50
7437	.20	74164	.75	74L47	1.95	74S00	.45
7438	.30	74165	1.10	74L51	.65	74S02	.45
7440	.20	74166	1.75	74L55	.85	74S03	.35
7441	1.15	74175	.90	74L72	.65	74S04	.35
7442	.55	74176	.95	74L73	.70	74S05	.45
7443	.45	74177	1.10	74L74	.75	74S08	.45
7444	.45	74180	.95	74L75	1.05	74S10	.45
7445	.75	74181	2.25	74L85	2.00	74S11	.45
7446	.70	74182	.75	74L93	.75	74S20	.35
7447	.70	74190	1.25	74L123	1.95	74S22	.55
7448	.50	74191	1.25	74LS00	.40	74S40	.30
7450	.25	74192	.75	74LS01	.40	74S50	.30
7451	.25	74193	.85	74LS02	.45	74S51	.35
7453	.20	74194	.95	74LS03	.45	74S64	.15
7454	.25	74195	.95	74LS04	.45	74S74	.70
7460	.40	74196	.95	74LS05	.45	74S112	.60
7470	.45	74197	.95	74LS08	.45	74S114	.85
7472	.40	74198	1.45	74LS09	.45	74S133	.85
7473	.25	74221	1.50	74LS10	.45	74S140	.75
7474	.30	74298	1.50	74LS11	.45	74S151	.95
7475	.35	74367	1.35	74LS20	.45	74S153	.95
7476	.40	75491	.65	74LS21	.45	74S157	.98
7480	.75	75492	.65	74LS22	.45	74S158	.80
7481	.85	74H00	.20	74LS32	.50	74S194	1.50
7482	.95	74H01	.30	74LS37	.45	74S196	2.00
7483	.95	74H04	.30	74LS38	.65	74S257 (8123)	2.50
7485	.75	74H05	.25	74LS40	.70	8131	2.75
7486	.55	74H08	.35	74LS42	.95		
7489	1.05	74H10	.35	74LS51	.75		
7490	.55	74H11	.25	74LS74	.95		
7491	.70	74H15	.45	74LS75	1.20		

I ² L, LINEARS, REGULATORS, ETC.			
QTY.		QTY.	
MCT2	.95	LM320K24	1.65
8038	3.95	LM320T5	1.65
LM201	.75	LM320T12	1.65
LM301	.45	LM320T15	1.65
LM308	.65	LM323K	5.95
LM309H	.85	LM324	1.25
LM309 (340K-5)	1.50	LM339	.75
LM310	.85	7805 (340T5)	1.15
LM311 (8-14 Pin)	.75	LM340T12	.95
LM318	1.50	LM340T15	.95
LM320H6	.79	LM340T18	.95
LM320H15	.79	LM340T24	.95
LM320H24	.79	LM340K12	1.25
7905 (LM320K5)	1.65	LM340K15	1.25
LM320K12	1.65	LM340K18	1.25
LM320K15	1.65	LM340K24	1.25
		LM373	3.95
		LM377	3.95
		78L05	.75
		78L12	.75
		78L15	.75
		78M05	.75
		LM380 (8-14 Pin)	1.19
		LM709 (8-14 Pin)	.45
		LM711	.45
		LM723	.40
		LM725	2.50
		LM739	1.50
		LM741 (8-14)	.45
		LM747	1.10
		LM1307	1.75
		LM1458	.65
		LM3900	.95
		LM75451	.65
		NE555	.45
		NE556	.85
		NE565	1.15
		NE566	1.25
		NE567	.95
		TA7205	6.95
		76477	2.95
		95H90	9.95

INTEGRATED CIRCUITS UNLIMITED
 7889 Clairemont Mesa Blvd., San Diego, California 92111
 Out of State 1-800-854-2211 Cable Address: ICUSD Telex: 697-827
 (714) 278-4394 California Residents 1-800-542-6239

NAME _____
 STREET ADDRESS _____
 CITY _____ STATE _____ ZIP _____
 PHONE _____ CHARGE CARD # _____ AE Visa BA MC _____ EXP. DATE _____

C.O.D. _____ WILL CALL _____ UPS _____ POST _____ NET 10th OF THE MONTH _____ PO # _____
 ALL ORDERS SHIPPED PREPAID - NO MINIMUM - COD ORDERS ACCEPTED - ALL ORDERS SHIPPED SAME DAY
 OPEN ACCOUNTS INVITED - California Residents add 6% Sales Tax. PRICES SUBJECT TO CHANGE WITHOUT NOTICE.
 24 Hour Phone Service - We accept American Express / Visa / BankAmericard / Master Charge

Total Order	Deduct
\$35-\$99	10%
\$100-\$300	15%
\$301-\$1000	20%

VARIABLE POWER SUPPLY KIT \$11⁹⁵

- Continuously Variable from 2V to over 15V
- Short-Circuit Proof
- Typical Regulation of 0.1%
- Electronic Current Limiting at 300mA
- Very Low Output Ripple
- Fiberglass PC Board Mounts All Components
- Assemble in about One Hour
- Makes a Great Bench or Lab Power Supply
- Includes All Components except Case and Meters

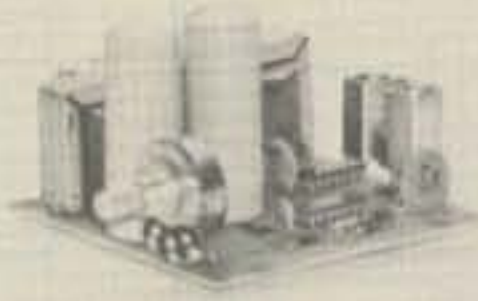

ADD \$1.25 FOR POSTAGE/HANDLING

FREE

IC or FET's WITH
\$5 & \$10 ORDERS.†
DATA SHEETS
WITH MANY ITEMS.

SPECIALS—THIS MONTH ONLY

1N34A	Germanium Diode 50V 10mA	10/51	LM308H	Low Bias Current Op Amp-Super 709	\$0.94
1N270	Germanium Diode 80V 200mA	4/51	LM309K	5 Volt Regulator TO-3	.84
1N914	Silicon Diode 100V 10mA	25/51	LM317K	Adjustable Voltage Regulator 2-37V	3.50
1N6263	Hot Carrier Diode (HP2800, etc.)	\$1.00	LM380N	2 Watt Audio Power Amplifier DIP	.94
F7	Power Varactor 1-2W Out @ 432MHz (Specs & Circuits included with F7)	\$2.90	NE555A	Phase Locked Loop DIP	.94
DIODE GRAB BAG	Mixed zeners, rectifiers, etc.	50/51	LM723CN	Precision Voltage Regulator DIP	3/51
2N706	NPN High-Speed Switch 75ns	4/51	LM747	Dual 741 Compensated Op Amp DIP	2/51
2N918	UHF Transistor—Dca/Amp up to 1 GHz	4/51	2102	1024-Bit Static RAM (1024 x 1) DIP	\$1.75
2N2906	P-Channel FET Amplifier 2500umhos	\$1.00	2740DE	FET-Input Op Amp—like NE 536/A740	1.95
2N2920	NPN Dual Transistor 3mV Match @25	2.95	CA3018A	4-Transistor Array/Darlington	.80
2N3904	NPN Amp/Switch @100 40V 200mA	8/51	CA3028A	RF/IF Amplifier DC to 120MHz	1.45
2N4122	PNP RF Amplifier & Switch	3/51	CA3075E	FM IF Amp/Limiter/Detector DIP	1.45
2N4888E	N-Channel Audio FET Super Low-Noise	2/51	RC4558	Dual High Gain Op Amp mDIP	3/51
2N4888	150 Volt PNP Transistor for Keyer	2/51	NE555V	Precision Fast Op Amp mDIP	2/51
E112	N-Channel FET VHF RF Amp	3/51	NE555EV	Dual Hi Gain Op Amp-Comp. mDIP	3/51
TIS74	N-Channel FET High-Speed Switch 40ns	3/51	8038	Function Generator/VCO with circuits	\$3.75
			LF-10	LOGIC PROBE kit—TTL, CMOS, etc. Mached case included—5% hr. assembly	\$7.85

SEND FOR ADVA'S NEW 1979 CATALOG
NEARLY 1000 SEMICONDUCTORS, KITS, CAPACITORS, ETC.—SEND 25¢ STAMP.

OTHER ADVA KITS:

LOGIC PROBE KIT—Use with CMOS, TTL, DTL, RTL, HTL, HNIL and most MOS IC's. Built-in protection against polarity reversal and overvoltage. Draws only a few mA from circuit under test. Dual LED readout. Complete kit includes case and clip leads. **ONLY \$7.95**

FIXED REGULATED POWER SUPPLY KITS—Short-circuit proof with thermal current limiting. Compact size and typical regulation of 0.5% make these ideal for most electronic projects. Available for 3V @ 500mA, 6V @ 500mA, 8V @ 500mA, 12V @ 400mA, 15V @ 300mA. Specify voltage when ordering. **\$8.95 ea.**

These easy-to-assemble kits include all components, complete detailed instructions and plated fiberglass PC boards. Power supply kits do not include case or meters. Add \$1.25 per kit for postage and handling.

MAIL NOW! FREE DATA SHEETS supplied with many items from this ad. FREE ON REQUEST—741 Op Amp with every order of \$5 or more—749 Dual Op Amp or two E100 FET's with every order of \$10 or more, postmarked prior to 12/31/78. One free item per order. **ORDER TODAY**—All items subject to prior sale and prices subject to change without notice. All items are new surplus parts—100% functionally tested.

WRITE FOR FREE CATALOG #79 offering over 700 semiconductors carried in stock. Send 25¢ stamp.

TERMS: Send check or money order (U.S. funds) with order. Add 5% postage for U.S., Canada and Mexico. \$1.00 handling charge on orders under \$10. Calif. residents add 6% sales tax. Foreign orders add 10% postage. COD orders—add \$1.00 service charge.

MORE SPECIALS:

RC4195DN ±15V @ 50mA VOLTAGE REGULATOR IC. Very easy to use. Makes a neat Highly Regulated ±15V Supply for OP AMP's, etc. Requires only unregulated DC (18-30V) and 2 bypass capacitors. With Data Sheet and Schematics. 8-pin mDIP **\$1.25**

RC4136 Quad 741 Low-Noise Op Amp mDIP **\$0.95**

LM1304 FM Multiplex Stereo Demodulator DIP **0.99**

LM2111 FM IF Subsystem (IF Amp, Det., Limiter) DIP **0.99**

1N6263 Hot Carrier Diode 0.4V @ 1mA 0.1ns DO-35 **1.00**

ZENERS—Specify Voltage 3.3, 3.9, 4.3, 5.1, 6.8, 8.2 400mW 4/51.00
9.1, 10, 12, 15, 16, 18, 20, 22, 24, 27, or 33V (±10%) 1 Watt 3/51.00

- MONEY-BACK GUARANTEE
- ALL TESTED AND GUARANTEED

ADVA

ELECTRONICS
BOX 4181 GB, WOODSIDE, CA 94062
Tel. (415) 328-1500

DIODES	TRANSISTORS	TRANSISTORS	TRANSISTORS	LINEAR IC's
ZENERS & RECTIFIERS	2N706 \$0.24	2N4091 3/51	2N5638 2/51	LM340K-5 \$1.20
1N270 .24	2N4092 \$0.75	2N5640 2/51	LM340T-5 1.20	LM340T-6 1.20
1N456 6/51	2N720 .48	2N4121 3/51	CP643 \$4.00	LM340T-12 1.20
1N458 2N918 3/51	2N4122 3/51	CP650* \$5.00	LM340T-15 1.20	LM340T-24 1.20
1N483 2N1613 \$0.29	2N4124 5/51	CP651 \$4.00	LM340T-25 1.20	LM340T-24 1.20
1N486 2N1711 .25	2N4248 5/51	E100 4/51	LM340T-24 1.20	LM376N* .55
1N746 2N1890 .30	2N4249 5/51	E101 3/51	LM376N* .55	NE555V* 2/51
1N758 4/51	2N1893 .38	2N4250 4/51	E102 3/51	NE558A \$8.00
1N814* 15/51	2N2218 .24	2N4274 5/51	E175 3/51	LM380N 1.20
1N822 2N2222 8/51	2N2222 8/51	2N4302 \$0.29	MPF102 2/51	NE555V* 2/51
1N874 4/51	2N2222A 5/51	2N4303 .29	MPF104 3/51	NE588A \$8.00
1N3084 6/51	2N2305 5/51	2N4338 .51	MPF112 4/51	LM790CH .29
1N4001* 12/51	2N2506 2/51	2N4339 .51	MPF5015 3/51	LM790CN .29
1N4003 12/51	2N2905 \$0.24	2N4352 \$0.30	SE1001 4/51	LM723N* 3/51
1N4004 12/51	2N2906A .24	2N4415 2/51	SE2001 4/51	LM793N \$1.00
1N4005 10/51	2N2907* 5/51	2N4416A \$0.80	SE2002 4/51	LM741CH 3/51
1N4006 10/51	2N3553 \$1.50	2N4456 5/51	SE3001 3/51	LM741CN14 .34
1N4007 10/51	2N3553 8/51	2N4457 5/51	SE5003 \$2.00	LM747CN .85
1N4148 15/51	2N3554 4/51	2N4857E 2/51	SE5029 3/51	78C32 DIP .35
1N4154* 25/51	2N3555 6/51	2N4888 2/51	T1572 3/51	79C32 DIP 1.00
1N4370 2/51	2N3638 6/51	2N4888 .51		844CP mDIP .80
1N4372 2/51	2N3638A 5/51	2N4888 3/51	MM5738N \$2.95	LM1390N 1.15
1N4454 15/51	2N3641 5/51	2N5007 4/51	SN7400N .18	LM1458N* 3/51
1N4725 3/51	2N3642 5/51	2N5008 4/51	SN7410N .18	LM2111N \$1.40
1N4753 3/51	2N3643 6/51	2N5125 6/51	SN7420N .18	XR2500CP 1.55
1N5221 4/51	2N3644 4/51	2N5126 5/51	SN7420N .18	2740DE 1.95
1N5226 4/51	2N3646 4/51	2N5128 5/51	SN7420N .18	CA3028A 1.75
	2N3648 3/51	2N5129 5/51	SN7420N .18	CA3046 .84
	2N3688 3/51	2N5133 3/51	SN7420N .18	LM3075N1 1.45
	2N3690 3/51	2N5137 \$5.00	SN7475N .45	CA3088* .62
	2N3691 4/51	2N5199 2.50	SN7475N .35	LM3900N .55
	2N3694 3/51	2N5210 3/51	SN7480N .64	RC4194D 1.80
	2N3697 3/51	2N5210 3/51	SN7480N .64	RC4194TK* 2.50
	2N3722 2/51	2N5308 2/51	LINEAR IC's	RC4195DN* 1.25
	2N3822 .70	2N5309 \$1.50	LM100H \$7.50	RC4195TK* 2.25
	2N3833 .40	2N5397 \$1.50	LM301AN .27	LM4230CN 2.00
	2N3866 .75	2N5432 1.80	LM307H .27	RC4558DN .55
	2N3903 6/51	2N5457 3/51	LM307H .27	RC4558DN .55
	2N3906 6/51	2N5458 \$0.38	LM308N .88	NE555V .95
	2N3919 5/51	2N5484 2/51	LM308K .94	NE555V .50
	2N3922 5/51	2N5486 2/51	LM311N .80	LM329K-5 1.35
	2N3954 3.25	2N5543 \$3.00	LM329K-12 1.35	8038 DIP* 3.75
	2N3958 1.15	2N5544 2.50	LM329K-15 1.35	DM75402 .88
	2N3970 1.00	2N5561 12.00	LM329K-15 1.35	

*SUPER SPECIALS:

1N34	Germanium Diode	10/51	FSA2501M Diode Array	2/51
1N914	100V/10mA Diode	20/51	MPF102 200MHz RF Amp	3/51
1N4001	50V/1A Rectifier	15/51	40573 MOSFET RF Amp	\$1.75
1N4154	30V 1N914	25/51	LM324 Quad 741 Op Amp	.94
BR1	50V 1/4A Bridge Rec	4/51	LM376 Pos Volt Reg mDIP	.55
2N2222	NPN Transistor	6/51	NE555 Timer mDIP	.38
2N2907	PNP Transistor	6/51	LM723 2-37V Reg DIP	3/51
2N3055	Power Xistor 10A	\$0.75	LM741 Comp Op Amp mDIP	6/51
2N3904	NPN Amp/Sw @100	6/51	LM1458 Dual 741 mDIP	3/51
2N3906	PNP Amp/Sw @100	6/51	CA3085 5 Trans Array DIP	.62
CP650	Power FET 1/2Amp	\$.5	RCA29 Pwr Xistor 1A 30W	.70
RF391	RF Power Amp Transistor 10-25W @ 3-30MHz TO-3	\$5.00		
555X	Timer 1.5-1hr Different pinout from 555 (w/data)	3/51		
RC4194TK	Dual Tracking Regulator ±0.2 to 30V @ 200mA TO-66	\$2.50		
RC4195TK	Dual Tracking Regulator ±15V @ 100mA (TO-66)	\$2.25		
8038	Waveform Generator ~V~ Wave With Circuits & Data	\$3.75		

NEW SPECIALS

LM318CN	High Speed Op Amp 50V/μs mDIP	\$0.94
LM318D	High Speed Op Amp 50V/μs DIP	.90
LM339N	Quad Comparator Single or Dual Supply	.79
LM380N-8	1/2W Audio Power Amplifier 8-22V	.90
NE567V	Tone Decoder (PLL) 0.01Hz to 500kHz	.99
XR567CP	Tone Decoder (PLL) 0.01Hz to 500 kHz	.99
LM723CN	Precision Voltage Regulator 2-37V DIP	3/51
LM747CN	Dual 741 Compensated Op Amp	2/51
SAD1024	Dual 512 Stage (1024) Audio Delay Line "Bucket Brigade" Appl. Data included	\$18.95
XR2206CP	Function Generator with applic. data	4.40
XR2242CP	Long-Range Precision Timer μs to days	1.50
1 YEAR TIMER Kit-2 XR2242's and Applic. Note		3.00
LM2901N	Quad Comparator +5V or 2 to 36VDC	\$1.20
CA3018A	4-Transistor Array/Darlington	.99
CA3028A	RF/IF Amplifier DC to 120MHz	1.25
RC4558	Dual High Gain Op Amp mDIP	3/51
SPACER Kit - 4 ea of 5 assorted size spacers		\$1.00
±15 VOLT Regulated Power Supply Kit-Easy assembly, 5mV regulation, 100mA, fully protected. Includes all components and hardware, no PCB or case—Add \$1.50 for shipping		\$13.95

1N270	Germanium Diode 80V 200mA	4/51
1N823	Temp Comp Reference 6.2V ±5% ± .005%/°C	\$0.60
1N914	Silicon Diode 100V 10mA	25/51
1N3044	100V Zener 1W—Better than an OB3	.75
1N3045	110V Zener 1W—Better than an OB2/OC3	.75
1N3071	200V 100mA Switching Diode 40ns	.30
2N2915	NPN Dual Transistor 3mV Match β100	\$1.95
2N3819M	N-Channel RF FET 100MHz Amp	.35
2N4020	PNP Dual Transistor 5mV Match β250	5.00
2N4445	N-Channel FET 5Ω Switch	3.50
2N5394E	Ultra-Low Noise J-FET Audio Amp	\$1.25
2N5912	Dual J-FET RF Dif Amp to 800MHz	2.90
2N6028	Programmable Unijunction Transistor	.45
2N6449	300 Volt N-Channel J-FET Amp/Sw	2.00
CP640	Broadband FET RF Amp 140dB Dyn Range	\$4.50
E304	N-Channel RF FET 3.8dB NF @ 400MHz	.50
MPSA12	NPN Darlington Transistor β20,000	.75
TIS88	N-Channel FET 400MHz RF Amp	.60
RESISTOR Kit—150 pcs 1/4W, 20 most common values, individually packaged, 5 to 20 pcs each		\$4.95
PC BOARD Mounting Kit—8 ea spacer, screw, nut and washer—32 pcs total		\$1.00

SEND FOR ADVA'S NEW 1979 CATALOG
NEARLY 1000 SEMICONDUCTORS, KITS, CAPACITORS, ETC.—SEND 25¢ STAMP.

ADVA

ELECTRONICS

BOX 4181 GB
WOODSIDE, CA 94062
Tel.(415) 328-1500

MOTOROLA 4 MHZ XTAL OSCIL-LATOR 14 pin dip pkg., 5 VDC in, 4 MHz out. TTL compatible. \$5.95 ea.

NATIONAL SEMICONDUCTOR - 6 DIGIT CLOCK MODULE A 12-hr. clock featuring alarm and snooze alarm function. Comes complete with everything. All you add is a power cord and switches. Each module utilizes discreet components and is ready for you to mount in your enclosure. Display is 6 each seven segments, .33 inches high, clockchip is MM5375. Can easily be mounted in either of our instrument clock case kits. \$14.95.

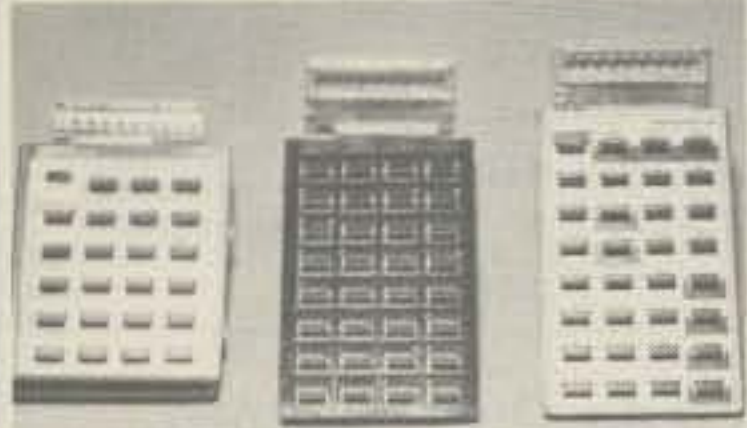

CALCULATOR GUTS

Experimenter's delight. Each keyboard includes a monolithic calculator chip and display. These are rejects. It might be something simple to repair or it could be very nasty. At this price, who cares! 9 volt. \$1.50 ea. 3/\$3.00.



INSTRUMENT CLOCK CASE KIT

A real jewel for those small projects. Hinged top door allows you to hide your control area. O.D. 4 1/2" x 4" x 1 3/4". \$1.99 each.

DB-25 FEMALE CONNECTOR

A unique assembly originally adapting the RS232 Type Connector to flat cable. \$1.50 each or 2/\$2.50.



INSTRUMENT/CLOCK CASE KIT

Perfect for your opto projects. Solid aluminum construction with real walnut sides. O.D. 5-3/8" by 5-3/8" by 2". \$6.95 ea.



EDGE CARD CONNECTOR

Cinch Jones 10/20 Pins. .156 Spacing PC Mount. .85 Burndy 22/44 Pins. .156 spacing PC Mount, \$1.40 each.



DEFECTIVE CALCULATORS

Well, some are and some are not. We can't afford the time to test them. \$2.50 ea. Batteries not included. 2/\$4.00.

M-M Electronic Sales

A division of **united products Corporation**

Corp. Hdqts., 2300 1st Ave—Seattle, Wash. 98121



LINE PRINTER HAMMER DRIVER BOARD

Each board contains approx. 130 each #MJE800 (Silicon Darlington NPN hfe 750, 1.5A). About \$130.00 worth, over 100 1N4001 diodes, plus support chips. The whole package is yours for only \$14.95.

HURRY, WE DON'T EXPECT THESE TO LAST VERY LONG!

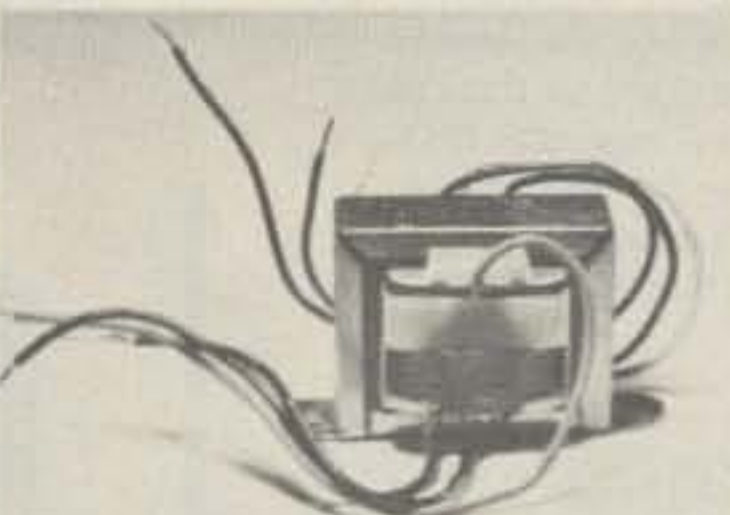

TRANSFORMER Pri. 110 VAC Sec. 11.2 and 5 VCT @ .1 amp. \$.95 ea.

MINIATURE D.P.D.T. [PUSH BUT TON]

momentary, rated 6A/125 VAC, microswitch part #8N2021. Only \$1.54.

CLOCK DISPLAY

National Semi. 6 Digit Multiplexed Display; .33" Characters (Common Cathode). A REAL BUY AT JUST \$1.00.

EDGE METER 100-0-100 ua 1/2" by 11/16". Compare with other meters costing \$6.00. Only \$2.00 ea. Why pay more?

DIODE SALE 1N4148

100/\$1.95 TAPE/REEL
1000/\$14.95

DIODES

TYPE	VOLTS	WATTS	PRICE
1N4001	50	1A	15/\$1.00
1N4002	100	1A	15/\$1.00
1N4003	200	1A	12/\$1.00
1N4004	400	1A	12/\$1.00
1N4005	600	1A	10/\$1.00
1N4006	800	1A	10/\$1.00
1N4007	1000	1A	6/\$1.00
1N5400	50	3A	5/\$1.00
1N5401	100	3A	5/\$1.00
1N5402	200	3A	5/\$1.25
1N5403	300	3A	4/\$1.25
1N5404	400	3A	4/\$1.25
1N5405	500	3A	4/\$1.49
1N5406	600	3A	4/\$1.49
1N5407	800	3A	3/\$1.49
1N5408	1000	3A	2/\$.99
1N4148	75	10M	20/\$1.00

1/4 WATT 5% DEPOSITED CARBON FILM RESISTOR ASSORTMENTS

ASST. A	10 ea	1 OHM 1.5 OHM 2 OHM 2.7 OHM 3 OHM 3.6 OHM 4.7 OHM 5.6 OHM 6.8 OHM 8.2 OHM	100 pcs \$2.40
ASST. B	10 ea	10 OHM 12 OHM 15 OHM 18 OHM 22 OHM 27 OHM 33 OHM 39 OHM 47 OHM 56 OHM	100 pcs \$2.40
ASST. C	10 ea	68 OHM 82 OHM 100 OHM 120 OHM 150 OHM 180 OHM 220 OHM 270 OHM 330 OHM 390 OHM	100 pcs \$2.40
ASST. D	10 ea	470 OHM 560 OHM 680 OHM 820 OHM 1K 1.2K 1.5K 1.8K 2.2K 2.7K	100 pcs \$2.40
ASST. E	10 ea	3.3K 3.9K 4.7K 5.6K 6.8K 8.2K 10K 12K 15K 18K	100 pcs \$2.40
ASST. F	10 ea	22K 27K 33K 39K 47K 56K 68K 82K 100K 120K	100 pcs \$2.40
ASST. G	10 ea	150K 180K 220K 270K 330K 390K 470K 560K 680K 820K	100 pcs \$2.40
ASST. H	10 ea	1M 1.2M 1.5M 1.8M 2.2M 2.7M 3.3M 3.9M 4.7M 5.6M	100 pcs \$2.40
ASST. A-H	INCLUDES ALL RESISTOR ASSORTMENTS (800 pcs)		\$14.95 ea

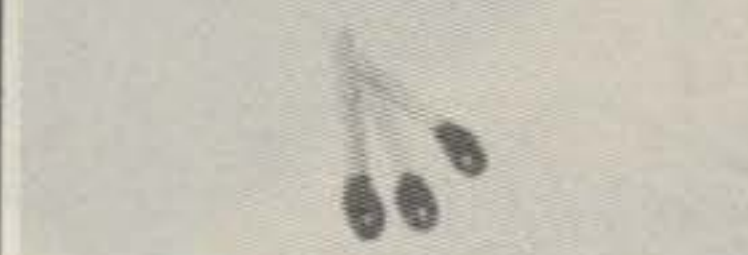

SOLID DIPPED TANTALUM CAPACITORS

	1-99	100 PLUS
.1 X 35 VOLT	.23	.19
.15 35	.23	.19
.22 35	.23	.19
.33 35	.23	.19
.47 35	.23	.19
.68 35	.23	.19
1.0 35	.25	.20
1.5 35	.29	.23
2.2 35	.31	.25
3.3 35	.36	.29
4.7 35	.38	.30
6.8 35	.50	.40
10.0 35	.60	.48
15.0 35	.79	.63
22.0 35	1.39	1.12
33.0 35	2.08	1.66
47.0 35	2.65	2.12

VALUES AND QUANT. MAY BE ASSORTED TO ATTAIN QUANT. PRICING

NYLON TIE WRAPS

3"	65000	10/\$.30
4"	65002	10/ .50
5.3"	65003	10/ .59
6.9"	65004	10/ .69
10.8"	65005	10/ 1.59
13.0"	65006	10/ 2.69
14.4"	65055	10/ 2.96
SCREW MOUNT		
13.6"	65054	10/ 4.29
7.4"	65052	10/ .98
5.8"	65051	10/ .89
4.4"	65050	10/ .75



GALLIUM PHOSPHIDE L.E.D.'s

Provide greater light out-put, brighter colors, greater uniformity and less current drain than regular L.E.D.'s

.110 DIAMETER		
P/N 724H	Red Diffused	4/\$1.00
724G	Green Diffused	4/ 1.19
724Y	Yellow Diffused	4/ 1.49
724O	Orange Diffused	4/ 1.49
.220 DIAMETER		
714H	Red Diffused	5/\$1.19
714G	Green Diffused	4/ 1.49
714Y	Yellow Diffused	4/ 1.59
714O	Orange Diffused	4/ 1.59
.220 DIAMETER (low dome)		
704R	Red Diffused	4/\$1.59
704G	Green Diffused	4/ 1.65
704Y	Yellow Diffused	4/ 1.84
704O	Orange Diffused	4/ 1.84
101R-g	Dual (Red and Green)	\$2.85
		2/5.00
MOUNTING HARDWARE		
.220 Diameter #7aMH		12/\$1.44



PARTS BOARDS A great way to buy parts on a budget. We guarantee your money's worth. ONLY \$1.00 ea.

ROTRON WHISPER FAN #WR2H1

3 Blade 4" Diameter 75CFM 115VAC. NET \$17.00 YOUR PRICE \$9.95 Wait now, these are not pull-outs or something like that, these are new!

CLAIREX PHOTO CELLS

These have a real USEFUL range to them. Any project involving control from ambient light levels will utilize this photo cell. Light resistance 1K. Fast response. .156 Diameter. \$.75 each or 2/\$1.00.

NOVUS CALCULATOR #824R

Rechargeable Ni-Cad calculator WITH MEMORY, EX, CS AND % KEY. \$4.95 ea. (owners manual and charger are not included)

PLASTIC PARTS BOX A nice little hinged-top box for storing all your small parts. O.d. 6 3/4" by 3 3/4" by 2". \$.75 ea. 10/\$5.00.

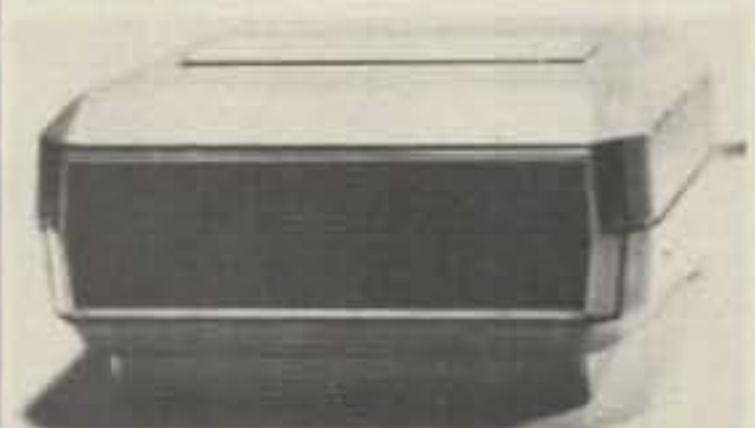

REPEAT OF A SELL-OUT

A complete 12 hour digital clock. Some are manufacture line rejects, some are returns, and some are just scratched. Features: hours, minutes, alarm, snooze alarm. Parts value alone would equal \$20.00, you pay only \$6.00 ea.

HOT DEALS

75493N (quad seg. driver)	.55
SN7428N	.25
1000uf 25VDC P-C.	.25
2000uf 25VDC AXIAL	.50
18 ga. LINE CORD 6'	.25
2N2222A	4/1.00
2N3054	.75
2N3055 (TO-3)	.99
MEMOREX 1" VIDEO TAPE 1/2 HOUR (with case)	4.95
SIEMENS MAGNETIC SENSOR	1.99
43/43 GOLD EDGE CONN. .156	4.95
P/B MIN. 12VDC RELAY D.P.D.T.	1.99

FREE BY POPULAR DEMAND

With min. purchase of \$50.00, you will receive free, a 5 function National Semiconductor L.C.D. mens watch. With min. purchase of \$100.00 you will receive free, our L.C.D. car clock. (watch and clock advertised in Dec. issue of 73 Mag.)

For Master Charge/Visa Orders Use Our TOLL FREE HOT LINE: 1-800-426-0634 for areas outside Washington (incl. Alaska & Hawaii)

O.E.M.'s WELCOME



Terms: All orders shipped promptly. Minimum order \$50.00. Telephone orders accepted. All orders shipped UPS or PP. Add 5% extra for shipping & handling. Washington state residents add additional 5.4% sales tax. Master Charge & Visa cards accepted. Money orders & your personal or company check are welcome. Funds made payable in U.S. currency only. No C.O.D. orders. Your satisfaction is guaranteed on all merchandise purchased. All merchandise subject to prior sale. Open account to govt. agencies & publicly funded schools.

Store Hours M-F 9-6 • SAT 9-5

NEW!



Tunable 420 MHz Fast Scan TV Converter

Receive Fast Scan Amateur TV in the 420 to 450 MHz Band with any TV set. Low noise, high gain rf Amp with Varactor tuned input and outputs. Built in AC supply. Comes in two tone walnut & beige cabinet measuring 1-7/8" x 4-1/4" x 4-1/8". Factory wired with 2-year guarantee.

\$59.95

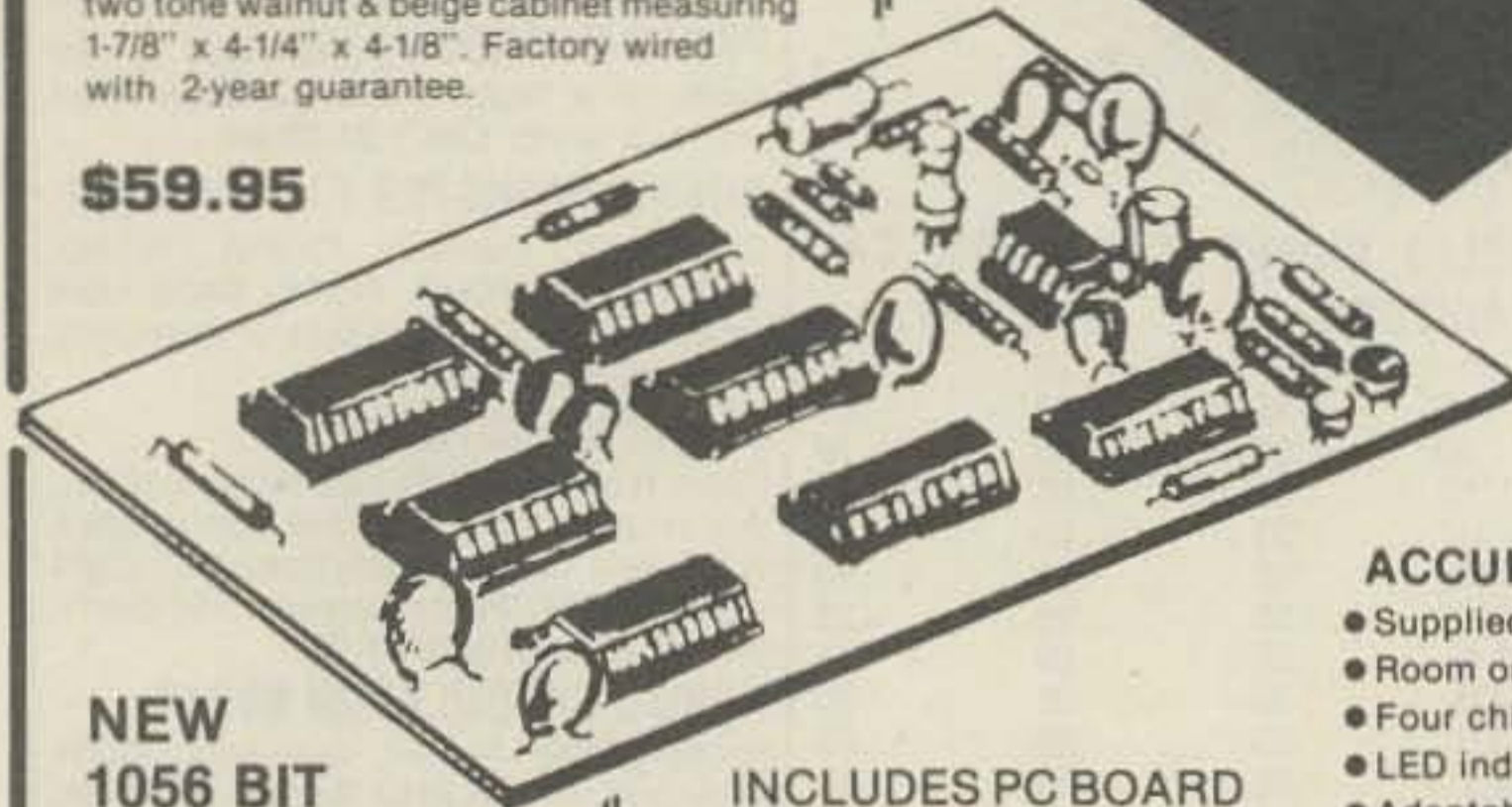

NEW 1056 BIT EXPANDABLE MEMORY KIT

INCLUDES PC BOARD AND PARTS STILL ONLY **\$19.95** requires 5 volts DC

RF TRANSISTORS

SD1018-4	40W	4.5db	450MHz	380-4LFL	15.25	2N3375	3.0W	400 MHz TO60	5.60
SD1074	50W	11db	30MHz	500-6LFL	21.15	2N3553	2.5W	175 MHz TO39	1.40
SD1076	75W	13	50	500-6LFL	24.00	2N3866	1.0W	400 MHz TO39	1.25
SD1088	25W	6	450	500-6LFL	23.25	2N4427	1.0W	175 MHz TO39	1.35
SD1089	40W	5	450	500-6LFL	27.15	2N5589	3.0W	175 MHz MT71	4.75
SD1143	10W	10	200	MT72	10.95	2N5590	10W	175 MHz MT72	7.80
SD1158	12W	5.3	200	TO117	12.30	2N5591	25W	175 MHz MT72	10.25
SD1272	30W	6	220	MT72	9.60	2N5913	1.75W	175 MHz TO39	1.70
SD1278	50W	10	50	MT72	16.30	2N6080	4.0W	175 MHz MT72	5.40
SD1416	70W	6.7	175	500-6LFL	26.80	2N6081	15W	175 MHz MT72	8.45
SD1428	45W	6.5	175	500-6LFL	22.65	2N6082	25W	175 MHz MT72	10.95
SD1433	8W	7.5	450	MT90	9.50	2N6083	30W	175 MHz MT72	12.30
SD1434	50W	5	450	500-6LFL	34.00	2N6084	40W	175 MHz MT72	16.30
SD1451	50	14	50	500-6LFL	18.10	2N6094	4.0W	175 MHz X106	6.60
SD1477	100W	6	175	500-6LFL	52.85	2N6095	15W	175 MHz X106	8.50
2N5945	4W	8	450	MT90	10.75	2N6096	30W	175 MHz X106	10.35
2N5946	10W	6	450	MT90	13.00	2N6097	40W	175 MHz X106	20.00

OVERVOLT 12

Crow Bar circuit protects Transceivers & Tape Decks from runaway power supply voltage that can zap expensive components. OV 12 causes fuse in Power Supply to blow if voltage exceeds preset level (approx. 16 to 18 volts). Rated at 25 Amperes. Model OV5. Protects 5 Volt circuits. Triggers at 7.5 Volts. Other units available at 3.3 to 100 Trigger Voltages.

\$ 7.95
\$ 8.95
\$10.95 ea.

FMMC 1



Dynamic Touch Tone Mic **\$39.95**



FM2016A New Yorkers must pay sales tax
144 to 149 MHz 1000 CHANNELS
SHOWN WITH OPTIONAL μP-800 MICRO PROGRAMMER



All the features of the 2015R and now with adjustable sine wave PL 60 Hz to 203 Hz. Adjustable low power position 1 Watt to 16 Watts.

Low, Low Price **\$299**

Buy your KDK 2016A from Aldelco and we'll pay shipping and insurance in the 48 states. Sorry no charge cards accepted on 2016A

Regulated AC/PS Model FMPS-4R... \$39.95

ALARM CLOCK KIT

6 Big 0.5 LED Displays * On Board AC Transformer * 12 Hour Format with 24 Hour Alarm * Snooze Feature * Elapsed Timer. Timer feature makes this Popular in Broadcast Stations. It's a natural for cars, boats and campers when used with optional crystal time base. Fits our standard cabinet. **\$21.95**
Crystal time base when purchased with clock. **\$3.95**

BLINKY FLASHER KIT

PC board, 555 & all parts works on 9 volts. Mouse button—**\$1.00**

12 or 24 HOUR DIGITAL CLOCK KIT

Uses 0.5 Display LED. 5314 Clock Chip. Freeze feature for accurate set, fits our standard cabinet. **ONLY \$19.95**

CLOCK CABINETS

Woodgrain or black leather **ea. \$4.95**

CRYSTAL TIME BASE KIT

Includes PC Board, Crystal, all parts and instructions. **\$4.95**

CLOCK FILTERS

Blue, Red, Green, Amber or Smoke **\$.60**

NEW! NEW! NEW!

- Self Completing Dots & Dashes
- Iambic Operation
- Single Dot & Dash Memories
- Provision for Attachment of Memory for DX or Contest Work

THE VERY POPULAR TOPE ACCUKEYER KIT

Revised version of the Accukeyer featured in the ARRL Handbook. Has more logical IC Layout and ON Board sidetone Oscillator. Includes PC Board. TTL ICs, 555 Timer, IC Sockets, Switch, Speaker, Transistors, capacitors and resistors. Requires 5 VDC. **\$19.95**

CRYSTAL SOCKETS

HOLDS 8 HC25U... \$ 59
Single HC25U... 29

NATIONAL A1188A

9 digit calculator readout .89

BUILD A 6 DIGIT 500 MHz FREQUENCY COUNTER



COMPLETE LUNCH COUNTER KIT \$79.95
Includes a reprint of a six-page construction article from Dec. 1978, 73 Magazine.

Aldelco can supply 3 PC boards. Silk screened front panel and complete instructions for only \$12.50 & shipping.

SOME PARTS USED IN COUNTER

11C90 Prescaler	14.50
74C925 Multiplex	9.95
F9368 Driver (2)	7.90
1 MHz XTAL	7.95
10.60 pF trim cap	.60
Register kit	1.75
Capacitor kit	5.50
See six page construction article in Dec. 1978 73 Magazine	

ALDELCO KITS

DUAL DIGITAL 12/24 HOUR CLOCK KIT NOW WITH A NEW WALNUT GRAIN WOOD CABINET

ONLY \$49.95



MODEL ALD 5-W 0.5 LEDS

Features:
12 or 24 Hour Operation on either clock
Each Clock separately controlled
Freeze feature for time set
Easy assembly for clock and cabinet

ADJUSTABLE POWER SUPPLY KITS

5-15 Volts 500 MA	\$6.95
12-28 Volts 500 MA	6.95

ALDELCO

2789A MILBURN AVE, BALDWIN, N.Y. 11510
516-378-4555

Add 6% shipping. Add \$1.00 for orders under \$10.00. Out of U.S.A. add 15% shipping and certified check or money order in U.S. funds.

RADIO BOOKSHOP

LICENSE STUDY GUIDES & TAPES

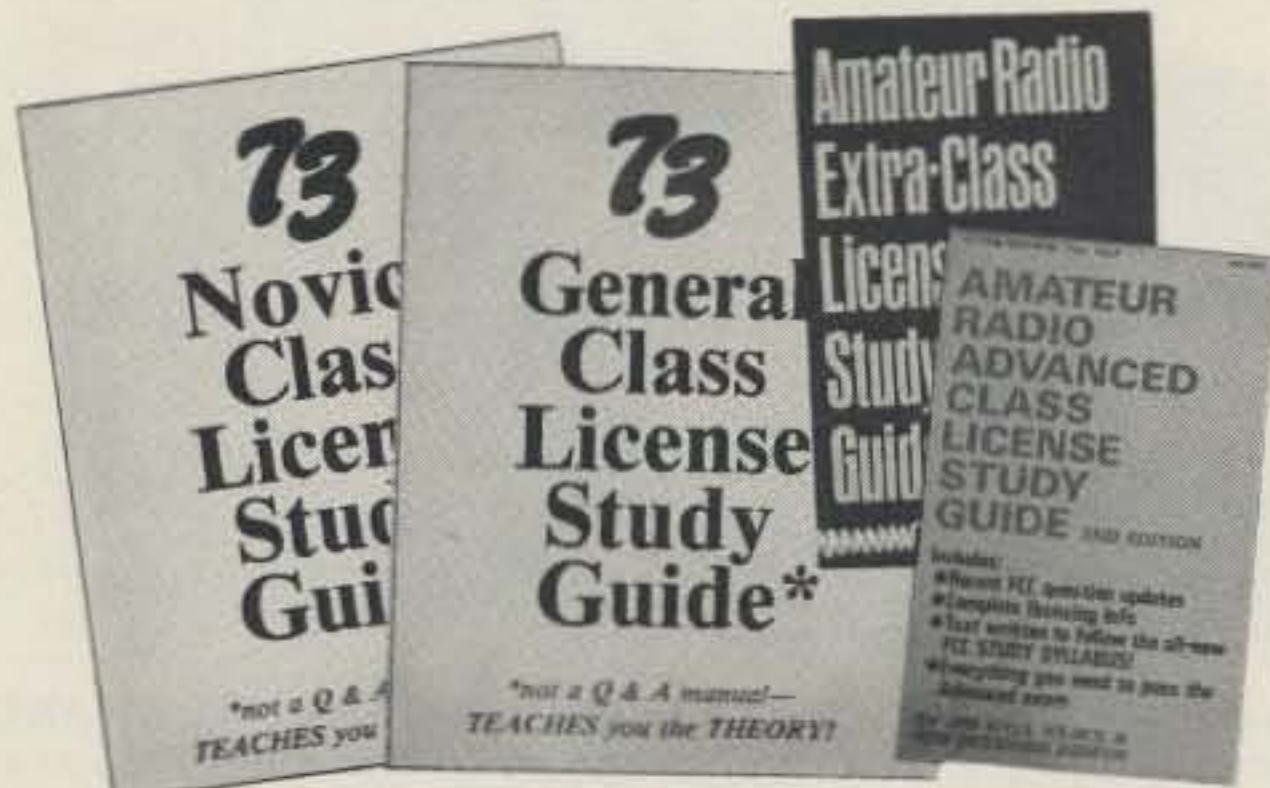

● **NOVICE STUDY GUIDE—SG7357**—Here is a completely new study guide and reference book for the potential ham. This is not a question/answer memorization course. Electronic and radio fundamentals are presented and explained in an easy-to-understand fashion, preparing the beginner for the Novice exam. Includes the latest FCC amateur regulations, as well as application forms. Easily the best path into the exciting world of ham radio! \$4.95.*

● **GENERAL CLASS STUDY GUIDE—SG7358**—A complete theory course for the prospective General or Technician. This reference explains transistor, amplifier, and general radio theory, while preparing the Novice for the "big" ticket. After getting your ticket, you'll use this guide again and again as an electronic reference source. Not a question/answer guide that becomes dated when the FCC updates the amateur exams. \$5.95.*

● **ADVANCED CLASS STUDY GUIDE—SG1081**—Ready to upgrade your license? To prevent retaking the FCC theory exam, you need the 73 Advanced theory guide. SSB, antenna theory, transmitters, and electronics measuring techniques are covered in detail in this easy-to-follow study guide. Special modes and techniques, such as RTTY, are also treated. An engineering degree is not necessary to master Advanced theory—try this book before visiting the examiner's office! \$5.95.*

● **EXTRA CLASS LICENSE STUDY GUIDE—SG1080**—Before going for your 1 x 2 call, it pays to be a master of the Extra class electronic theory. This study guide is the logical extension of the 73 theory course. All the theory necessary to pass the exam is presented. Antennas, transmission lines, swr are discussed, as well as noise, propagation, and specialized communication techniques. This book is not a classroom lecture or memorization guide, but rather a logical presentation of the material that must be understood before attempting the Extra exam. Save yourself a return trip to the FCC and try the 73 method first! \$5.95.*



NOVICE THEORY TAPES Startling Learning Breakthrough



● **NOVICE THEORY TAPES—CT7300**—Startling Learning Breakthrough. You'll be astounded at how really simple the theory is when you hear it explained on these tapes. Three tapes of theory and one of questions and answers from the latest Novice exams give you the edge you need to breeze through your exam. 73 is interested in helping get more amateurs, so we're giving you the complete set of our tapes for the incredibly low price of **ONLY \$15.95.***

Scientists have proven that you learn faster by listening than by reading because you can play a cassette tape over and over in your spare time—even while you're driving! You get more and more info each time you hear it.

You can't progress without solid fundamentals. These four hour-long tapes give you all the basics you'll need to pass the Novice exam easily. You'll have an understanding of the basics which will be invaluable to you for the rest of your life! Can you afford to take your Novice exam without first listening to these tapes? Set of 4—\$15.95.*

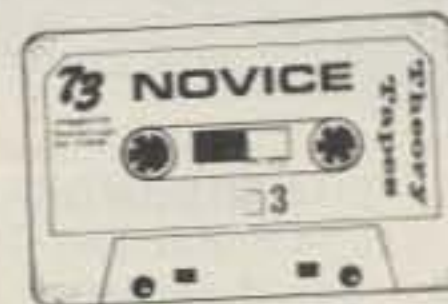

SSTV

● **SLOW SCAN TELEVISION TAPE—CT7350**—Prize-winning programs from the 73 SSTV contest. Excellent for Demo! \$5.95.*

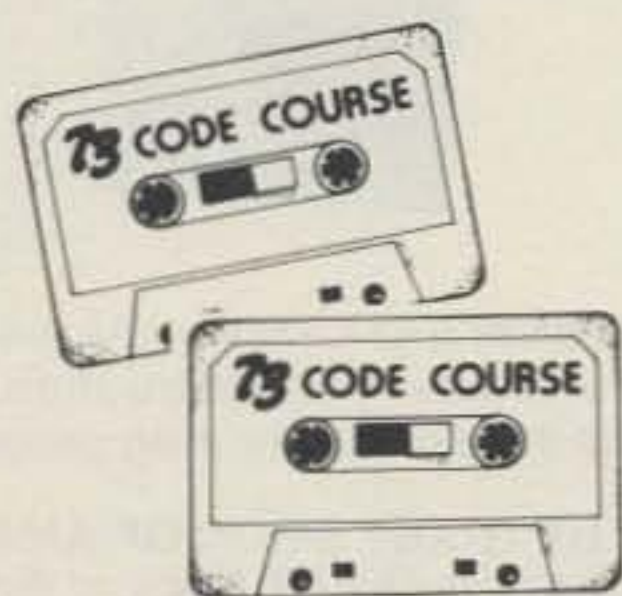

73 CODE SYSTEM TAPES

code, sent at the official FCC standard (no other tape we've heard uses these standards, so many people flunk the code when they are suddenly—under pressure—faced with characters sent at 13 wpm and spaced for 5 wpm). This tape is not memorizable, unlike the zany 5 wpm tape, since the code groups are entirely random characters sent in groups of five.

"COURAGEOUS"

20+ WPM—CT7320—Code is what gets you when you go for the Extra class license. It is so embarrassing to panic out just because you didn't prepare yourself with this tape. Though this is only one word faster, the code groups are so difficult that you'll almost fall asleep copying the FCC stuff by comparison. Users report that they can't believe how easy 20 per really is with this fantastic one hour tape.

Any Four Tapes For \$15.95! *
\$4.95 Each! *

"GENESIS"

5 WPM—CT7305—This is the beginning tape for people who do not know the code at all. It takes them through the 26 letters, 10 numbers and necessary punctuation, complete with practice every step of the way using the newest blitz teaching techniques. It is almost miraculous! In one hour many people—including kids of ten—are able to master the code. The ease of learning gives confidence to beginners who might otherwise drop out.

"THE CANADIAN"

10+ WPM—CT7310—73 hasn't forgotten the Canadian hams—our 10 WPM tape prepares you to breeze through your country's licensing exams. Like the other code groups, the tape is not memorizable and, once mastered, provides a margin of safety in the actual text situation.

"OUTRAGEOUS"

25+ WPM—CT7325—This is the tape for that small group of overachieving hams who wouldn't be content to simply satisfy the code requirements of the Extra Class license. It's the toughest tape we've got and we keep a permanent file of hams who have mastered it. Let us know when you're up to speed and we'll inscribe your name in 73's CW "Hall of Fame."

"THE STICKLER"

6+ WPM—CT7306—This is the practice tape for the Novice and Technician licenses. It is made up of one solid hour of

"BACK BREAKER"

13+ WPM—CT7313—Code groups again, at a brisk 13 per so you will be at ease when you sit down in front of the steely-eyed government inspector and he starts sending you plain language at only 13 per. You need this extra margin to overcome the panic which is universal in the test situations. When you've spent your money and time to take the test, you'll thank heavens you had this back-breaking tape.



Use the order card in the back of this magazine or itemize your order on a separate piece of paper and mail to:
73 Radio Bookshop • Peterborough NH 03458. Be sure to include check or detailed credit card information.

*Add \$1.00 handling charge. Note: Prices subject to change on books not published by 73 Magazine.

FOR CUSTOMER SERVICE CALL (603) 924-7298

Radio Bookshop

73 TECHNICAL LIBRARY

● **BEHIND THE DIAL**—BK7307—By Bob Grove. Get more fun out of shortwave listening with this interesting guide to receivers, antennas, frequencies and interference. \$4.95.*

● **THE CHALLENGE OF 160**—BK7309—is the newest book in the 73 technical library, dedicated to 160 meter operating. Si Dunn provides all necessary information to get started on this unique band. The all-important antenna and ground systems are described in detail. The introduction contains interesting photos of Stew Perry's (the King of 160) shack. This reference is a must for new and experienced "Top Band" operators. Price: \$4.95.*

● **IC OP-AMP COOKBOOK**—BK1028—by Walter G. Jung. Covers not only the basic theory of the IC op amp in great detail, but also includes over 250 practical circuit applications, liberally illustrated. 592 pages, 5½ x 8½, softbound. \$12.95.*

● **THE POWER SUPPLY HANDBOOK**—BK7305—Need a power supply for a gadget you're building? In the **POWER SUPPLY HANDBOOK** there are dozens ready-to-build, plus detailed steps for designing your own. There are circuits and parts lists for all kinds of supplies, ranging from simple DC types to highly stable regulated versions. If you need a circuit to convert a DC voltage to a higher or lower voltage, turn DC into AC, or AC to DC—then this is the book you need. With more than 400 pages, you should be able to find just the circuit you need. Without a doubt one of the best power supply source books available, compiled by the editors of 73. \$7.95.*



● **INTRODUCTION TO RTTY**—BK7380—A beginner's guide to radioteletype including teletypewriter fundamentals, signals, distortion and RTTY art. You can be a RTTY artist! A 73 publication. \$2.00.*

● **THE NEW RTTY HANDBOOK**—BK7347—is a new edition and the only up-to-date RTTY book available. The state of the art has been changing radically and has made all previous RTTY books obsolete. It has the latest circuits, great for the newcomer and expert alike. \$5.95.*

● **PROPAGATION WIZARD'S HANDBOOK**—BK7302—by J. H. Nelson. When sunspots riddled the worldwide communications networks of the 1940's, John Henry Nelson looked to the planets for an answer. The result was a theory of propagation forecasting based upon interplanetary alignment that made the author the most reliable forecaster in America today. The book provides an enlightened look at communications past, present, and future, as well as teaching the art of propagation forecasting. \$6.95.*



● **SSB... THE MISUNDERSTOOD MODE**—BK7351—by James B. Wilson. Single Sideband Transmission... thousands of us use it every day, yet it remains one of the least understood facets of amateur radio. J. B. Wilson presents several methods of sideband generation, amply illustrated with charts and schematics, which will enable the ambitious reader to construct his own sideband generator. A must for the technically-serious ham. \$5.50.*

● **SSTV HANDBOOK**—BK7354(hardcover), BK7355(softcover)—This excellent book tells all about it, from its history and basics to the present state-of-the-art techniques. Contains chapters on circuits, monitors, cameras, color SSTV, test equipment and much more. Hardbound \$7.00, softbound \$5.00.*

● **WEATHER SATELLITE HANDBOOK**—BK7370—Simple equipment and methods for getting good pictures from the weather satellite. Antennas, receivers, monitors, facsimile you can build, tracking, automatic control (you don't even have to be home). Dr. Taggart WB8DQT. \$4.95.*

● **73 DIPOLE AND LONG-WIRE ANTENNAS**—BK1016—by Edward M. Noll W3FQJ. This is the first collection of virtually every type of wire antenna used by amateurs. Includes dimensions, configurations, and detailed construction data for 73 different antenna types. Appendices describe the construction of noise bridges, line tuners, and data on measuring resonant frequency, velocity factor, and swr. \$5.50.*



● **THE GIANT BOOK OF AMATEUR RADIO ANTENNAS**—BK7304—With the **GIANT Book of Amateur Radio Antennas** by your side, antennas will become the least of your worries. Over 450 pages of design ideas, theory and reference data make this book live up to its title. The 7 chapters cover everything from basic antenna theory through designs for DIY accessories, as well as dozens of antenna designs. Whether planning to build or buy, design or admire, test or enjoy a ham antenna—this is the book for you. From the editors of 73; published by Tab Books. \$12.95 Hardback.*

● **73 VERTICAL, BEAM AND TRIANGLE ANTENNAS**—BK1069—by Edward M. Noll W3FQJ. Describes 73 different antennas for amateurs. Each design is the result of the author's own experiments covering the construction of noise bridges and antenna line tuners, as well as methods for measuring resonant frequency, velocity factor, and standing-wave ratios. 160 pages. \$5.50.*

● **VHF ANTENNA HANDBOOK**—BK7368—The **NEW VHF Antenna Handbook** details the theory, design and construction of hundreds of different VHF and UHF antennas... A practical book written for the average amateur who takes joy in building, not full of complex formulas for the design engineer. Packed with fabulous antenna projects you can build. \$4.95.*



Use the order card in the back of this magazine or itemize your order on a separate piece of paper and mail to:
73 Radio Bookshop • Peterborough NH 03458. Be sure to include check or detailed credit card information.
*Add \$1.00 handling charge. Note: Prices subject to change on books not published by 73 Magazine.

FOR TOLL FREE ORDERING CALL 1-800-258-5473

Radio Bookshop

TEST EQUIPMENT

● **RF AND DIGITAL TEST EQUIPMENT YOU CAN BUILD**—BK1044—Rf burst, function, square wave generators, variable length pulse generators—100 kHz marker, i-f and rf sweep generators, audio osc, af/rf signal injector, 146 MHz synthesizer, digital readouts for counters, several counters, prescaler, microwave meter, etc. 252 pages. \$5.95.*

● **VOL. I COMPONENT TESTERS**—LB7359—... how to build transistor testers (8), diode testers (3), IC testers (3), voltmeters and VTVMs (9), ohmmeters (8 different kinds), inductance (3), capacity (9), Q measurement, crystal checking (6), temperature (2), aural meters for the blind (3) and all sorts of miscellaneous data on meters... using them, making them more versatile, making standards. Invaluable book. \$4.95.*

● **VOL. II AUDIO FREQUENCY TESTERS**—LB7360—... jam packed with all kinds of audio frequency test equipment. If you're into SSB, RTTY, SSTV, etc., this book is a must for you... a good book for hi-fi addicts and experimenters, too! \$4.95.*

● **VOL. III RADIO FREQUENCY TESTERS**—LB7361—Radio frequency waves, the common denominator of Amateur Radio. Such items as SWR, antenna impedance, line impedance, rf output and field strength; detailed instructions on testing these items includes sections on signal generators, crystal calibrators, grid dip oscillators, noise generators, dummy loads and much more. \$4.95.*

● **VOL. IV IC TEST EQUIPMENT**—LB7362—Become a troubleshooting wizard! In this fourth volume of the 73 TEST EQUIPMENT LIBRARY are 42 home construction projects for building test equipment to work with your ham station and in servicing digital equipment. Plus a cumulative index for all four volumes of the 73 TEST EQUIPMENT LIBRARY. \$4.95.*



THE well-equipped HAM SHACK

● **73 MAGAZINE BINDERS**—Preserve and protect your collection for your lifetime! There's no excuse for lost issues when you have these handsome red binders with gold lettering. Order 1—BN1001—for \$6.50*; 2 or more—BN1002—for \$6.00 each.* (specify 1978 or 1979 binders)

● **QSL CARDS**—73 turns out a fantastic series of QSL cards at about half the cost of having them done elsewhere because they are run as a fill-in between printing books and other items in the 73 Print Shop. 250 Style W—QW0250—for \$8.95*; 500 Style W—QW0500—for \$13.95*; 250 Style X—QX0250—for \$8.95*; 500 Style X—QX0500—for \$13.95*; 250 Style Y—QY0250—for \$8.95*; 500 Style Y—QY0500—for \$13.95.*



● **HOW TO BUILD A MICROCOMPUTER—AND REALLY UNDERSTAND IT**—BK7325—by Sam Creason. The electronics hobbyist who wants to build his own microcomputer system now has a practical "How-To" guidebook. Sam Creason's book is a combination technical manual and programming guide that takes the hobbyist step-by-step through the design, construction, testing and debugging of a complete microcomputer system. \$9.95.*

● **1979 WORLD REPEATER ATLAS**—BK7346—With a new easy-to-use format, the 1979 World Repeater Atlas is the largest ever published by 73. More than 230 pages of repeaters, listed by both location and frequency, together with over 50 location maps—make this the best repeater atlas ever! Nearly 2000 separate repeater locations are shown on the maps, with greater accuracy than ever before. \$4.95.*

● **BACK ISSUES**—Complete your collection; many are prime collectables now, classics in the field! A full collection is an invaluable compendium of radio and electronics knowledge!

Single back issue—ST0000—\$3.00*;
 25 our choice—ST2500—\$12.00*;
 25 your choice—ST2501—\$25.00*;
 5 your choice—ST0500—\$8.50*;
 10 your choice—ST1000—\$14.00.*



Style X



Style W

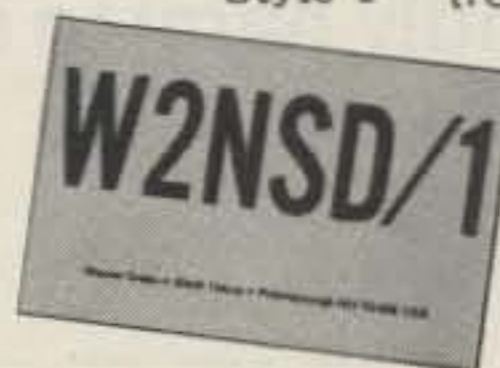

Style Y

● **OWNER REPAIR OF AMATEUR RADIO EQUIPMENT**—BK7310—Frank Glass shares over 40 years of operating, servicing, and design experience in this book. There are several books and numerous articles available on the subject of repairs to electronic equipment. The information within these books ranges from the elementary to the highly technical written for the top engineers in the field. But this book stands out from the rest in that it is written in narrative style aimed at conveying the concept of electronic servicing. A written discussion of how components work and how they are combined to provide communication equipment is used to help the reader understand the concepts required to service station equipment. \$7.95.*

● **A GUIDE TO HAM RADIO**—BK7321—by Larry Kahaner WB2NEL. What's Amateur Radio all about? You can learn the basics of this fascinating hobby with this excellent beginner's guide. It answers the most frequently asked questions in an easy-going manner, and it shows the best way to go about getting an FCC license. A Guide to Ham Radio is an ideal introduction to a hobby enjoyed by people around the world. \$4.95.*

● **LIBRARY SHELF BOXES**—These sturdy white, corrugated, dirt-resistant boxes each hold a full year of 73 or Kilobaud Microcomputing. With your order, request self-sticking labels for any of the following: 73, Kilobaud Microcomputing, CQ, QST, Ham Radio, Personal Computing, Radio Electronics, Interface Age, and Byte. Order 1—BX1000—for \$2.00*; order 2—BX2002—for \$1.50 each*; order 8 or more—BX1002—for \$1.25 each*.

Use the order card in the back of this magazine or itemize your order on a separate piece of paper and mail to:
 73 Radio Bookshop • Peterborough NH 03458. Be sure to include check or detailed credit card information.
 *Add \$1.00 handling charge. Note: Prices subject to change on books not published by 73 Magazine.

**22,650
pages.**



**That's the size of the world's
most comprehensive guide to
the subject of ham radio:
18 years of 73 Magazine.**

The back issues of 73 are a gold mine of interesting articles. Unlike the other magazines, which fill their pages with activity reports, there's little to go stale in 73. You'll find pioneering articles on SSTV, FM, repeaters, ICs, and computers. Even the editorials are fun as Wayne Green's dire predictions, like the debacle of incentive licensing, have come to pass.

Clip the coupon below and send for 73's new back issue catalogue. Treat yourself (or a friendly ham) to some fun, and a fantastic bargain to boot.

YES! Rush me 73's FREE Back Issue Catalogue!

Name _____

Address _____

City _____ State _____ Zip _____

73 magazine
PETERBOROUGH NH 03458

ALL NEW 1979 REPEATER ATLAS OF THE WORLD



The all new 1979 Repeater Atlas is now available as a result of the cooperation of hundreds of individuals, repeater groups, and coordinators. This is the largest atlas available anywhere. It includes 234 pages, 50 location maps, over 4,500 stations, and 9,000 entries, in a new, easy-to-use format indexed by location and frequency. Call Toll Free (800) 258-5473; have your credit card handy and order your 1979 Repeater Atlas (BK 7346) today. \$4.95

73 magazine

Peterborough NH 03458

PROPAGATION

by
J. H. Nelson

EASTERN UNITED STATES TO:

	GMT: 00	02	04	06	08	10	12	14	16	18	20	22
ALASKA	14	14	7A	7	7	7	7	14	14	21	21	
ARGENTINA	21	14	14	14	7	7A	14A	21A	21A	21A	21A	21A
AUSTRALIA	21	14	7	7B	7B	7B	7B	14	14	14	21A	21A
CANAL ZONE	21	14	14	7	7	7	14	21	21A	21A	21A	21A
ENGLAND	14	7	7	7	7	14	14	21A	21A	21A	14A	14
HAWAII	21A	14	14	7	7	7	7A	14B	14A	21	21A	21A
INDIA	14B	7B	7B	7B	7B	7B	14	21	14A	14	14	14B
JAPAN	21	14	14B	7B	7B	7B	7	7	14B	14B	14	21
MEXICO	21	14	7A	7	7	7	14	14A	21	21	21A	21A
PHILIPPINES	21	14	14B	7B	7B	7B	14B	14B	14	14	14	21
PUERTO RICO	14	14	7	7	7	7	14	14	21	21	21A	21
SOUTH AFRICA	21	14	7	14	14	14	21A	21A	21A	21A	21A	21A
U. S. S. R.	7	7	7	7	7B	7B	14	21	21A	21	14	7B
WEST COAST	21A	21	14	7	7	7	7A	14A	21A	21A	21A	21A

CENTRAL UNITED STATES TO:

	GMT: 00	02	04	06	08	10	12	14	16	18	20	22
ALASKA	14	14	7A	7	7	7	7	14	14	14A	14A	
ARGENTINA	21	14	14	14	7	7	14	21A	21A	21A	21A	21A
AUSTRALIA	21	14	14	7B	7B	7B	7B	14	14	14	21A	21A
CANAL ZONE	21	14	14	7A	7	7	14	21	21A	21A	21A	21A
ENGLAND	14	7	7	7	7	7B	14	14	21A	21A	14A	14
HAWAII	21A	21	14	14B	7	7	7A	14B	14A	21A	21A	21A
INDIA	14	14	14B	7B	7B	7B	7B	14	14	14	14	14B
JAPAN	21	14A	14	14B	7B	7B	7	7	14B	14	14	21
MEXICO	21	14	7	7	7	7	7	14	14A	21	21	21
PHILIPPINES	21	14A	14	14B	7B	7B	7B	14B	14	14	14	21
PUERTO RICO	21	14	7A	7	7	7	14	21	21	21	21A	21A
SOUTH AFRICA	21	14	7	7B	7B	7B	14	21A	21A	21A	21A	21A
U. S. S. R.	7	7	7	7	7B	7B	14B	14	21	14A	14	7B

WESTERN UNITED STATES TO:

	GMT: 00	02	04	06	08	10	12	14	16	18	20	22
ALASKA	14	14	14	7	7	7	7	14	14	14	14	
ARGENTINA	21	21	14	14	7A	7	7A	21	21A	21A	21A	21A
AUSTRALIA	21A	21A	21A	14	14	14	7	7	14	14	21A	21A
CANAL ZONE	21A	21	14	14	7	7	7	14A	21	21A	21A	21A
ENGLAND	14	7	7	7	7	7B	7B	14	21	21A	14A	14
HAWAII	21A	21A	21	14	14	14	7A	14B	14A	21A	21A	21A
INDIA	14	14	14	7B	7B	7B	7B	14B	14	14	14B	7B
JAPAN	21A	21A	14A	14	7B	7B	7	7	14	14	14A	21
MEXICO	21	14A	14	7	7	7	7	14	21	21	21A	21A
PHILIPPINES	21A	21A	21	14	7B	7B	7B	7B	14	14	14	21A
PUERTO RICO	21A	14	14	14	7	7	14	21	21	21	21A	21A
SOUTH AFRICA	21	14	7	7B	7B	7B	14B	14	21	21A	21A	21A
U. S. S. R.	7B	7	7	7	7B	7B	7B	14	14A	14	14	7B
EAST COAST	21A	21	14	7	7	7	7A	14A	21A	21A	21A	21A

- A = Next higher frequency may also be useful
- B = Difficult circuit this period
- F = Fair
- G = Good
- P = Poor
- SF = Chance of solar flares

september

sun	mon	tue	wed	thu	fri	sat
☉ 14 8	☉ 14 13	☉ 14 21	☉ 14 28			1 G
2 G	3 F/SF	4 F/SF	5 F/SF	6 F/SF	7 F	8 G
9 G	10 G/SF	11 G/SF	12 P/SF	13 P/SF	14 P	15 G
16 G	17 F	18 G	19 G	20 G	21 G	22 G
23 30 G/F	24 F	25 G	26 G	27 G	28 G	29 G

MOVING?

Let us know 8 weeks in advance so that you won't miss a single issue of 73 Magazine.

Attach old label where indicated and print new address in space provided. Also include your mailing label whenever you write concerning your subscription. It helps us serve you promptly. Write to:

73 magazine

Subscription Department
P.O. Box 931
Farmingdale NY 11737

- Address change only
- Extend subscription
- Enter new subscription
- 1 year \$18.00
- Payment enclosed (1 extra BONUS issue)
- Bill me later

If you have no label handy, print OLD address here.

Name _____ Call _____

Address _____

City _____ State _____ Zip _____

print NEW address here:

Name _____ Call _____

Address _____

City _____ State _____ Zip _____

AFFIX LABEL

S9-79

READER SERVICE

A46 ABC Communications..... 57	D23 Dovetron..... 166	M8 MHZ Electronics..... 170, 171	T18 Trac Electronics Corp..... 77, 157
A1 Adirondack Radio Supply... 125	D25 DSI Instruments..... 88, 89	M69 Micro Control Specialties... 18	T3 Tufts Radio Elec..... 164, 167
A24 Adva Electronics..... 186	E40 Electra..... 39	M95 Micro Management Systems... 18	U10 UDM Enterprises..... 125
A60 AED Electronics..... 7	F1 Fair Radio Sales..... 125	M109 Mil Industries..... 62	U13 Ultima Electronics, Ltd..... 125
A92 AHF Antennas..... 105	F5 Flesher Corporation..... 95	N22 Non-Linear Systems..... 23	U9 Unadilla/Reyco Division..... 31
A107 AJT Enterprises..... 31	G12 Germantown Amateur Supply	N4 Nye Company..... 24	U2 Unarco-Rohn..... 77
A2 Aidelco..... 188 127	O5 OK Machine & Tool..... 24, 85	U8 United Products..... 187
A40 Amateur Radio Supply of Nash-	G22 G.I.S.M.O..... 59	O3 Optoelectronics, Inc..... 13	V5 VHF Engineering..... 41
ville, Inc..... 65	G4 Godbout Electronics..... 178	O12 Outdoor Outfitters..... 27	V24 Vibroplex..... 15, 109
A21 Amateur-Wholesale Electronics	* HAL Communications..... 21	* Palomar Engineers..... 121, 166	V75 Vineyard Amateur Radio..... 125
..... 168, 169	H24 Hal-Tronix..... 107, 126	P20 para-graphs..... 127	W18 Western Electronics..... 135, 164
A106 AMC Engineering..... 161	H2 Ham Radio Center	P41 P.C. Electronics..... 84	W2 Wilson Electronics..... 3
* Amsat..... 99 7, 18, 51, 84, 95, 135, 146, 158	P44 Pickering Codemaster Company	W33 Wilson Systems, Inc..... 91-94
A6 Apron Laboratories..... 135	H16 Hamtronics, NY..... 173 107	X3 Xitex Corp..... 99
* Associated Radio..... 180	H8 Hamtronics, PA..... 18	P64 Rudy Plak..... 125	Y1 Yaesu Electronics Corp
A100 Auteck..... 22	H5 Heath..... 141, 158	P2 Poly Paks..... 181 CIII, 43, 75
B23 Barker-Williamson..... 164	H3 Henry Radio..... CII	Q3 Quest Electronics..... 165	From 73..... 79, 95, 130, 131-134, 189-194
B54 Barry Electronics..... 130	H44 HFT, Inc..... 125	R1 Radio Amateur Callbook..... 146	
B42 Brodie Electronics Co..... 117	* ICOM..... 19	* Radio World..... 95	
B8 Bullet Electronics..... 184	I32 Instant Software..... 86, 87	R8 Ramsey Electronics..... 172	
C88 C & A Electronics Enterprises	I43 Insta-Pac..... 24, 95	R27 RF Power Labs, Inc..... 145	
..... 31	I9 Integrated Circuits, Unltd..... 185	R35 Ross Distributing Corp..... 127	
C3 Clegg..... 27, 164	I27 IRL..... 35, 107	S100 Scott Manufacturing..... 130	
C21 Coakit..... 7	I44 International Electronic Corp.,	S110 Selectone Corp..... 47	
C106 Command Productions..... 18	Inc..... 145	S63 Semiconductor Surplus..... 183	
C58 Communications Center, NE	J1 Jameco Electronics..... 179	S3 Sentry Manufacturing..... 164	
..... 63, 90	J2 Jan Crystals..... 135	S33 S-F Amateur Radio Serv..... 7, 121	
C5 Communications Elec..... 18	J7 Jenson Tools & Alloys..... 125	* SoftSell Unlimited..... 49	
C115 Communications Electronics	* Kantronics..... 135, 146	S81 Spectronics, Inc..... 176, 177	
Specialties..... 164, 166	* Kenwood..... CIV, 5, 139	S8 Spectrum Communications..... 67	
C6 Communications Specialists	K14 Key Electronics..... 7	S10 SST Electronics..... 169	
..... 16, 17	* Kilobaud Microcomputing..... 83	S18 Standard Communications..... 84	
C105 Communications & TV Unltd	L25 The Logic Store..... 95	S43 Surplus Electronics..... 182	
..... 161	L9 Long's Electronics..... 110-115	S44 Swan Electronics..... 8, 9	
D6 Peter W. Dahl Company..... 55	L17 Lunar Electronics..... 24, 27	T64 Technical Clinic..... 125	
D35 Daytapro Electronics, Inc..... 7	M48 Macrotronics, Inc..... 105	T52 Tele-Tow'r Mfg. Co..... 121	
D29 Dielectric Communications..... 105	M35 Madison Electronics Supply	* Ten-Tec..... 11	
* Digital Research Corporation 27, 62, 71, 126, 160	T55 TET USA..... 29	
..... 174	M36 Maggiore Electronic Lab..... 146	T34 Thomas Communications..... 32, 33	
* Digital Research Parts..... 175	M52 MFJ Enterprises..... 25, 73	T48 Tower Electronics Corp..... 31	

*Reader Service inquiries not honored. Please contact advertiser directly.

BOOKS, ETC.

BK1016 73 DIPOLE & LONG WIRE ANTENNAS..... \$ 5.50	BK7305 POWER SUPPLY HANDBOOK..... \$ 7.95
ST0000 73 BACK ISSUE..... \$ 3.00	BK1015 PRACTICAL ANTENNAS FOR THE RADIO
ST2500 73 BACK ISSUES—25 OUR CHOICE..... \$12.00	AMATEUR..... \$ 9.95
ST0500 73 BACK ISSUES—5 YOUR CHOICE..... \$ 8.50	BK7302 PROPAGATION WIZARD'S HANDBOOK..... \$ 6.95
ST1000 73 BACK ISSUES—10 YOUR CHOICE..... \$14.00	QW0250 QSL CARDS—STYLE W—250..... \$ 8.95
ST2501 73 BACK ISSUES—25 YOUR CHOICE..... \$25.00	QW0500 QSL CARDS—STYLE W—500..... \$13.95
BK7307 BEHIND THE DIAL..... \$ 4.95	QX0250 QSL CARDS—STYLE X—250..... \$ 8.95
BN1001 BINDER—73—1..... \$ 6.50	QX0500 QSL CARDS—STYLE X—500..... \$13.95
BN1002 BINDER—73—2 AND UP..... \$ 6.00	QY0250 QSL CARDS—STYLE Y—250..... \$ 8.95
BK7309 CHALLENGE OF 160..... \$ 4.95	QY0500 QSL CARDS—STYLE Y—500..... \$13.95
CT7305 CODE TAPE—5 WPM..... \$ 4.95	BK7346 1979 WORLD REPEATER ATLAS..... \$ 4.95
CT7306 CODE TAPE—6+ WPM..... \$ 4.95	BK1044 RF DIGITAL TEST EQUIPMENT..... \$ 5.95
CT7310 CODE TAPE—10+ WPM..... \$ 4.95	BK7347 RTTY HANDBOOK..... \$ 5.95
CT7313 CODE TAPE—13+ WPM..... \$ 4.95	BX1000 SHELF BOX—1..... \$ 2.00
CT7320 CODE TAPE—20+ WPM..... \$ 4.95	BX1001 SHELF BOXES—2..... \$1.50 each
CT7325 CODE TAPE—25+ WPM..... \$ 4.95	BX1002 SHELF BOXES—8 AND UP..... \$1.25 each
CT7394 CODE TAPES (ANY FOUR ABOVE)..... \$15.95	BK7351 SSB THE MISUNDERSTOOD MODE..... \$ 5.50
BK7321 GUIDE TO HAM RADIO..... \$ 4.95	BK7354 SSTV HANDBOOK (HARDCOVER)..... \$ 7.00
BK7304 GIANT BOOK OF AMATEUR RADIO	BK7355 SSTV HANDBOOK (SOFTCOVER)..... \$ 5.00
ANTENNAS..... \$12.95	CT7350 SSTV TAPE..... \$ 5.95
BK7325 HOW TO BUILD A MICROCOMPUTER & REALLY	SG1081 STUDY GUIDE—ADVANCED CLASS..... \$ 5.95
UNDERSTAND IT..... \$ 9.95	SG1080 STUDY GUIDE—EXTRA CLASS..... \$ 5.95
BK1028 IC OP AMP COOKBOOK..... \$12.95	SG7358 STUDY GUIDE—GENERAL CLASS..... \$ 5.95
BK7380 INTRO TO RTTY..... \$ 2.00	SG7357 STUDY GUIDE—NOVICE CLASS..... \$ 4.95
CT7300 NOVICE THEORY TAPES..... \$15.95	LB7359 TEST EQUIP LIB V1—COMP TESTERS..... \$ 4.95
BK7310 OWNER REPAIR OF AMATEUR RADIO	LB7360 TEST EQUIP LIB V2—AUDIO TESTERS..... \$ 4.95
EQUIPMENT..... \$ 7.95	LB7361 TEST EQUIP LIB V3—RADIO EQUIP..... \$ 4.95
	LB7362 TEST EQUIP LIB V4—IC TEST EQUIP..... \$ 4.95
	BK7348 TOOLS & TECHNIQUES..... \$ 4.95
	BK1069 VERTICAL BEAM & TRIANGLE ANTNS..... \$ 5.50
	BK7368 VHF ANTENNA HANDBOOK..... \$ 4.95
	BK7370 WEATHER SATELLITE HANDBOOK..... \$ 4.95

ALL NEW FT-101ZD

HIGH-PERFORMANCE HF TRANSCEIVER

Today's technology, backed by a proud tradition, is yours to enjoy in the all-new FT-101ZD transceiver from YAESU. A host of new features are teamed with the FT-101 heritage to bring you a top-dollar value. See your dealer today for a "hands on" demonstration of the performance-packed FT-101ZD.

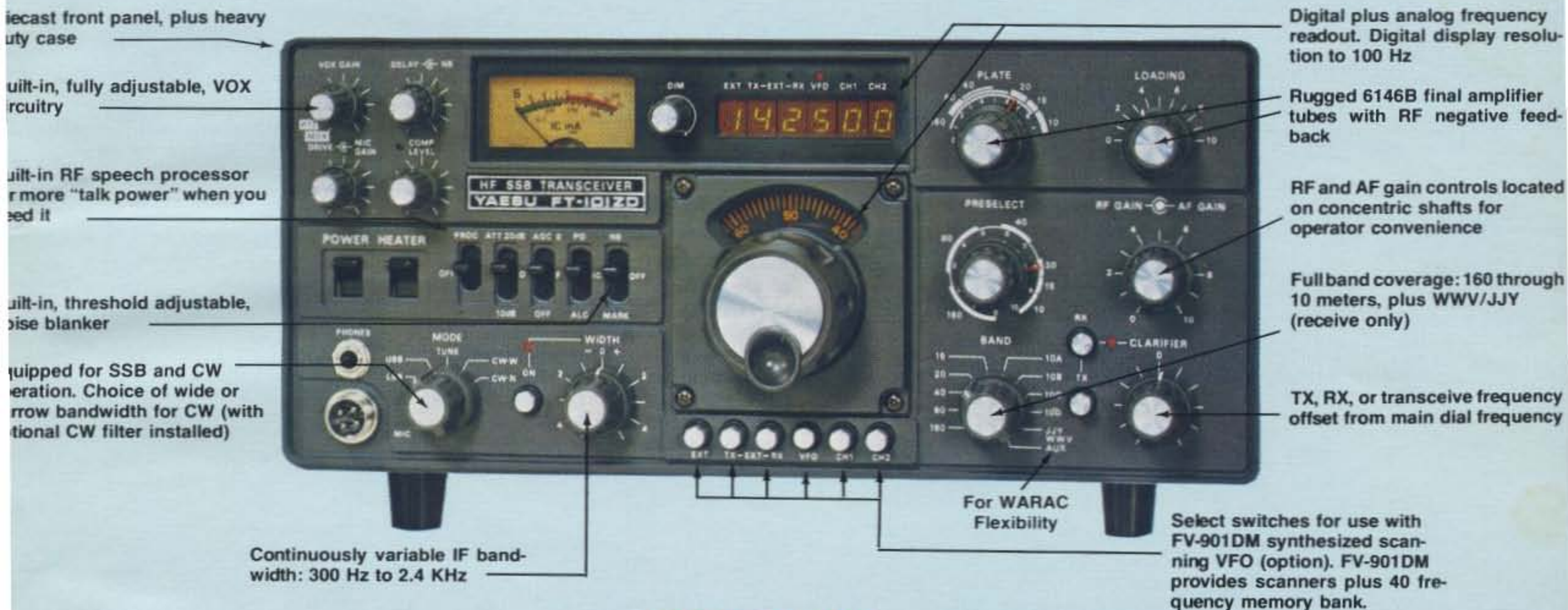

SPECIFICATIONS

TRANSMITTER

PA Input Power:
180 watts DC

Carrier Suppression:
Better than 40 dB

Unwanted Sideband Suppression:
Better than 40 dB @ 1000 Hz, 14 MHz

Spurious Radiation:
Better than 40 dB below rated output

Third Order Distortion Products:
Better than -31 dB

Transmitter Frequency Response:
300-2700 Hz (-6 dB)

Stability:
Less than 300 Hz in first 30 minutes after 10 min. warmup; less than 100 Hz after 30 minutes over any 30 min. period

Negative Feedback: 6 dB @ 14 MHz

Antenna Output Impedance:
50-75 ohms, unbalanced

GENERAL

Frequency Coverage:
Amateur bands from 1.8-29.9 MHz, plus WWV/JJY (receive only)

Operating Modes:
LSB, USB, CW

Power Requirements:
100/110/117/200/220/234 volts AC, 50/60 Hz; 13.5 volts DC (with optional DC-DC converter)

Power Consumption:
AC 117V: 75 VA receive (65 VA HEATER OFF) 285 VA transmit; DC 13.5V: 5.5 amps receive (1.1 amps HEATER OFF), 21 amps transmit

Size:
345 (W) x 157 (H) x 326 (D) mm

Weight:
Approximately 15 kg.

**COMPATIBLE WITH
FT-901DM ACCESSORIES**

RECEIVER

Sensitivity:
0.25 uV for S/N 10 dB

Selectivity:
2.4 KHz at 6 dB down, 4.0 KHz at 60 dB down (1.66 shape factor); Continuously variable between 300 and 2400 Hz (-6 dB); CW (with optional CW filter installed): 600 Hz at 6 dB down, 1.2 KHz at 60 dB down (2:1 shape factor)

Image Rejection:
Better than 60 dB (160-15 meters); Better than 50 dB (10 meters)

IF Rejection:
Better than 70 dB (160, 80, 20-10 m); Better than 60 dB (40 m)

Audio Output Impedance:
4-16 ohms

Audio Output Power:
3 watts @10% THD (into 4 ohms)



Price And Specifications Subject To
Change Without Notice Or Obligation

YAESU
The radio.



379X

YAESU ELECTRONICS CORP., 15954 Downey Ave., Paramount, CA 90723 • (213) 633-4007
YAESU ELECTRONICS Eastern Service Ctr., 9812 Princeton-Glendale Rd., Cincinnati, OH 45246



TS-120S



TS-180S with DFC*

TS-180S, featuring DFC* (Digital Frequency Control, with four digitally tuned memories), is an all solid-state HF transceiver specially designed for the DXer, contest operator and other Amateurs who enjoy working the 160 through 10-meter bands. Also available is a full line of matching accessories, including the PS-30 base-station power supply, SP-180 external speaker with selectable audio filters, VFO-180 remote VFO, AT-180 antenna tuner/SWR and power meter/antenna switch, DF-180 digital frequency control, YK-88CW filter and YK-88SSB filter. Stand-up microphone shown above is optional.

TS-120S, popularly referred to as "a big little rig," is a compact, up to 200 watts PEP input, all solid-state HF transceiver with such standard features as built-in digital readout, IF shift, new PLL technology and requires no tuning. It's ideal for car or ham shack use. Accessories available include the PS-30 base-station power supply, SP-120 external speaker, VFO-120 remote VFO, AT-120 antenna tuner/SWR meter, MB-100 mobile mounting bracket and YK-88CW filter. Hand microphone shown above is optional.

See the exciting TS-180S and TS-120S at your Authorized Kenwood Dealer!

 **KENWOOD**
...pioneer in amateur radio

TRIO KENWOOD COMMUNICATIONS INC.
1111 WEST WALNUT / COMPTON CA 90220