

73 Magazine

for Radio Amateurs

- 32 **Electro Sculpture**
—be a radio Rodin VP2DN
- 36 **The SUMSUE Method**
—determining code speeds ... accurately .. K1RH
- 38 **The UART Gear Shifter**
—for multi-speed RTTY KB8CE
- 42 **Silence Groaning Refrigerators**
—check your house wiring..... K4KI
- 44 **Bargain Preamp**
—multiple uses for this one..... W5REZ
- 48 **Murphy's Masterpiece**
—the lost weekend WA6PPZ
- 52 **How About Some Ham Shack Safety?**
—don't be a statistic W7FGD
- 56 **Head 'Em Off at the (High) Pass**
—improved filter design..... WB6GNM
- 60 **555 Basics—And More!**
—get to know this versatile IC..... WB4CEO
- 64 **Educate Yourself**
—an almost painless method WB1AHL
- 68 **Novel RTTY Autostart**
—we could write a book K2OAW
- 74 **The Easiest Offset Ever**
—a treat for 2 K4GOK
- 78 **The Chip Switch**
—a digital troubleshooting triumph..... WB2QEL
- 82 **Automatic Repeater Offsets**
—it's all so logical N2YK/WB2NYK
- 86 **CB to 10**
—part XIII: the Lafayette Telsat
SSB-75 DF1SP/W2
- 90 **The History of Ham Radio**
—part VII W9CI
- 94 **Build An FM Tweaker**
—simple deviation meter W3QVZ
- 96 **Another Surplus Treasure**
—convert the R-648/ARR-41 receiver ... McClellan
- 100 **Pffft—Zapped Again!**
—front-end protect your test equip-
ment WA6THG/KH6JSA
- 102 **One Meter—Many Jobs**
—an introduction to shunts Fletcher
- 104 **Who Uses All Those Frequencies?**
—the competition for radio spec-
trum WB6JPI, WB6HDB
- 106 **MDS: What Is It?**
—and what's in it for you Edwards
- 108 **FM Calibration on a Budget**
—why pay more? W9HDA
- 112 **Build the \$80 Wonder**
—a deluxe frequency counter/standard..... W3HB
- 116 **Add-A-Scanner**
—for any synthesized rig..... N2YK/WB2NYK
- 120 **CB to 10**
—part XIV: a Realistic PLL rig K0QLC
- 124 **No More Excuses!**
—get on RTTY with this simple demodula-
tor WB4MBL
- 126 **The Junk Box Station**
—ham ingenuity does it again WA4DQN
- 130 **R-X Bridge + Calculator = Vswr**
—antenna tuning without QRM WB5ILK
- 136 **High Seas Adventure—Ham Style**
—part II WA6FEI
- 142 **“Look What Followed Me Home!”**
—a PET of your very own Lilie
- 148 **A Hex on Your 8223**
—space-saving magic Schneider
- 150 **The Micro Maestro!** K6EW
- 168 **SSTV Meets SWTPC: Part 1**
—micro-enhanced pictures K6AEP
- 182 **Squelchifying Cheap Receivers**
—junk-box project WA1PDY
- 184 **Try FM On 29.6 MHz**
—no, it's not a CB channel WA7WYF
- 186 **Build the Brute**
—unique heavy-duty power supply N9KV
- 192 **The Multifunction Scan Can**
—another IC-22S goodie..... W11BI, W1HZH
- 198 **Be A Weather Genius**
—eavesdrop on GOES WB8DQT
- 208 **Happiness is a DMM Kit**
—Sabtronics makes a gem W7AAY
- 210 **Vintage Receiver Mods**
—new life for hamfest bargains W2OLU
- 212 **Deep, Dark Secrets of the TR-7500**
—exposing hidden talents WB9SEQ
- 216 **The TTY Lifesaver**
—saves money, too..... Sergo
- 218 **Build the “Version Three”**
—simple RTTY TU does it all Colby
- 222 **Heath's GR-88 Gets Religion!**
—convert it to 2 meters W2AOO
- 226 **Four Terminals Are Better Than Three**
—using the new voltage regulators..... W1SNN
- 238 **CB to 10**
—part XV: a Realistic HT..... K5UKH
- 240 **The Circuit Board Aquarium**
—no fish story WB9QZE
- 244 **Build A Decent Dummy**
—no oil, no light bulbs, no hassle..... K4IPV
- 250 **Who Needs Transistors?**
—you do! W5JJ
- 252 **A Junk Box Load Simulator**
—for battery testing..... W5JJ
- 254 **Blockbuster RTTY Article!**
—Selcal and W-R-U on a budget W9IF
- 266 **Automatic Autopatch**
—safeguard your health..... W6GJS
- 276 **Using Bargain Muffin Fans**
—a keep-cool idea K4SE
- 278 **Loran-C as a Frequency Standard**
—is 3 cycles a week good enough?..... WA4EID
- 286 **Ham Help!**
—a telephone aid for the blind N4AL
- 288 **An Experimenter's Delight**
—a lab bench with style..... WA1WLW

Before you buy an amplifier



Lift the Lid

Before you invest your hard earned money in a linear amplifier, consider what's inside. That's where the difference in quality is obvious. No lightweight, cheaply built components... In Henry amplifiers you will find only the best quality, heavy duty components. We build our amplifiers to perform at peak level month after month, year after year. Both the 2KD-5 and the 2K-4 will operate full legal power continuous duty on all modes. We offer the amateur the linear amplifier that we would want in our own stations.

At Henry Radio we know how to build only one kind of amplifier... the best!

2KD-5 GENERAL SPECIFICATIONS:

- * The 2KD-5 is a 2000 watt PEP input (1200 watt PEP nominal output) RF linear amplifier, covering the 80, 40, 20, and 15 meter amateur bands.
- * Two Eimac 3-500Z glass envelope triodes operating in a grounded grid circuit.
- * Pi-L plate circuit with a rotary silver plated tank coil for greatest efficiency and maximum attenuation of unwanted harmonics.
- * Full legal input in all modes. 2000 watts PEP input for SSB, 1000 watts DC input for CW, RTTY and AM.
- * Jumper for 115 or 230 VAC, 3 wire single phase.
- * 10.5" high x 15" wide x 17.5" deep
- * Price...\$895.00

2K-4...LINEAR AMPLIFIER. Offers engineering, construction and features second to none. Provides a long life of reliable service, while its heavy duty components allow it to loaf along even at full legal power. Operates on all amateur bands, 80 thru 15 meters. If you want to put that strong clear signal on the air that you've probably heard from other 2K users, now is the time. Move up to the 2K-4. Floor console...\$1095.00

TEMPO 6N2 brings the same high standards to the 6 and 2 meter bands. A pair of advanced design Eimac 8874 tubes provide 2,000 watts PEP input on SSB or 1,000 watts on FM or CW. Complete with self-contained solid state power supply, blower and RF relative power indicator. ...\$895.00

TEMPO 2002. The same fine specs and features as the 6N2, but for 2 meter operation only. ...\$745.00

TEMPO 2006. Like the 2002, but for 6 meter operation. ...\$795.00

TEMPO VHF/UHF AMPLIFIERS. Solid state power amplifiers for use in most land mobile applications. Increases the range, clarity, reliability and speed of two-way communications. FCC type accepted also.

| Model | Drive Power | Output Power | Price |
|--|-------------|--------------|--------|
| LOW BAND VHF AMPLIFIERS (35 to 75 MHz) | | | |
| Tempo 100C30 | 30W | 100W | \$159. |
| Tempo 100C02 | 2W | 100W | \$179. |
| Tempo 100C10 | 10W | 100W | \$149. |
| HIGH BAND VHF AMPLIFIERS (135 to 175 MHz) | | | |
| Tempo 130A30 | 30W | 130W | \$189. |
| Tempo 130A10 | 10W | 130W | \$179. |
| Tempo 130A02 | 2W | 130W | \$199. |
| Tempo 80A30 | 30W | 80W | \$149. |
| Tempo 80A10 | 10W | 80W | \$139. |
| Tempo 80A02 | 2W | 80W | \$159. |
| Tempo 50A10 | 10W | 50W | \$ 99. |
| Tempo 50A02 | 2W | 50W | \$119. |
| Tempo 30A10 | 10W | 30W | \$ 69. |
| Tempo 30A02 | 2W | 30W | \$ 89. |
| UHF AMPLIFIERS (400 to 512 MHz) | | | |
| Tempo 70D30 | 30W | 70W | \$210. |
| Tempo 70D10 | 10W | 70W | \$240. |
| Tempo 70D02 | 2W | 70W | \$270. |
| Tempo 40D10 | 10W | 40W | \$145. |

| | | | |
|-------------|----|-----|--------|
| Tempo 40D02 | 2W | 40W | \$165. |
| Tempo 40D01 | 1W | 40W | \$185. |
| Tempo 25D02 | 2W | 25W | \$125. |
| Tempo 10D02 | 2W | 10W | \$ 85. |
| Tempo 10D01 | 1W | 10W | \$125. |

TEMPO 100AL10 VHF LINEAR AMPLIFIER. Completely solid state, 144-148 MHz. Power output of 100 watts (nom.) with only 10 watts (nom.) in. Reliable and compact...\$199.00
TEMPO 100AL10/B BASE AMPLIFIER...\$349.00

Henry Radio also offers a broad line of commercial and FCC type accepted amplifiers covering the range of 3 MHz to 500 MHz. Henry amplifiers are in use all around the world. Commercial and export inquiries are invited.

Tempo solid state amplifiers are available at Tempo dealers throughout the U.S.

please call or write for complete information.

Henry Radio

11240 W. Olympic Blvd., Los Angeles, Calif. 90064 213/477-6701
 931 N. Euclid, Anaheim, Calif. 92801 714/772-9200
 Butler, Missouri 64730 816/679-3127

All of the above except the 6N2, 2002, and 2006 are available at Tempo dealers throughout the U.S.

Prices subject to change without notice.

THE SWITCH IS ON!

Not only is the big move to switch to the Wilson Mark Series of Mini-Hand-Held Radios, but now the switch is on the Mark!

Wilson Electronics, known for setting the pace in 2m FM Hand-Helds, goes one step beyond!

AT NO EXTRA CHARGE: all Mark Series Radios now will include a switch for you to control the power of operation. This will enable you to use the high power when needed, then later switch to low power to conserve battery drain for extended operation.

IN ADDITION: all Mark Series Radios now have an LED Battery Condition Indicator conveniently mounted on the top plate. A quick peek will reassure you of a charged battery in the radio.

Wilson hand-helds have been known world-wide for exceptional quality and durable performance. That's why they have been the best selling units for years.

Now the Mark Series of miniature sized 2-meter hand-helds offers the same dependability and operation, but in an easier to use, more comfortable to carry size . . . fits conveniently in the palm of your hand.

The small compact size battery pack makes it possible to carry one or more extra packs in your pocket for super extended operation time. No more worry about loose cells shorting out in your pocket, and the economical price makes the extra packs a must.

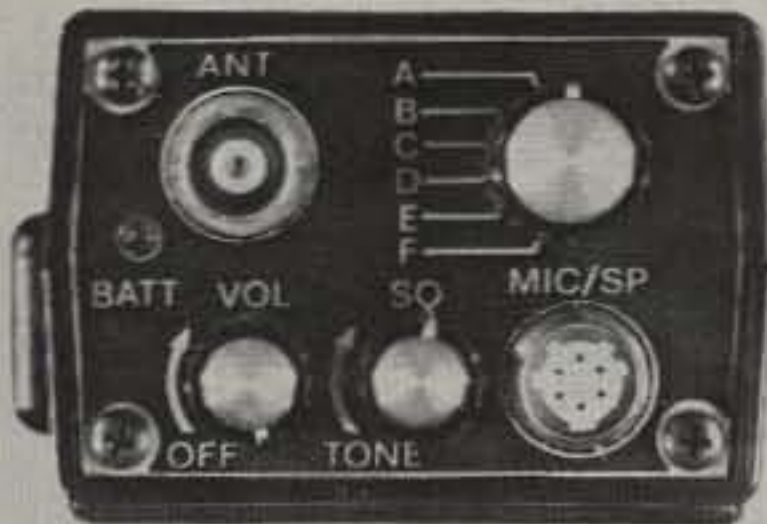

Conveniently located on top of the radio are the controls for volume, squelch, accessory speaker mike connector, 6 channel switch, BNC antenna connector and LED battery condition indicator.

Optional Touch Tone™ Pad available.

To obtain complete specifications on the Mark II and Mark IV, along with Wilson's other fine products, see your local dealer or write for our Free Amateur Buyer's Guide.

— NOW SWITCHABLE —

MARK II: \approx 1 & 2.5 watts

MARK IV: \approx 1.5 & 4.5 watts

SPECIFICATIONS

- Range: 144-148 MHz
- 6 Channel Operation
- Individual Trimmers on TX and RX Xtals
- Rugged Lexan® outer case
- Current Drain: RX 15 mA
 - TX - Mark II: 500 mA
 - TX - Mark IV: 900 mA
- 12 KHz Ceramic Filter and 10.7 Monolithic Filter included.
- 10.7 MHz and 455 KHz IF
- Spurious and Harmonics: more than 50 dB below carrier
- BNC Antenna Connector
- .3 Microvolt Sensitivity for 20 dB Quieting
- Uses special rechargeable Ni-Cad Battery Pack
- Rubber Duck and one pair Xtals 52/52 included
 - Weight: 19 oz. including batteries
 - Size: 6" x 1.770" x 2.440"
 - Popular accessories available: Wall Charger, Mobile Charger, Desk Charger, Leather Case, Speaker Mike, Battery Packs, and Touch Tone™ Pad.



Illustrated is Wilson's BC-2 Desk Top Battery Charger shown charging the Mark Series Unit or the BC-4 Battery Pack only.

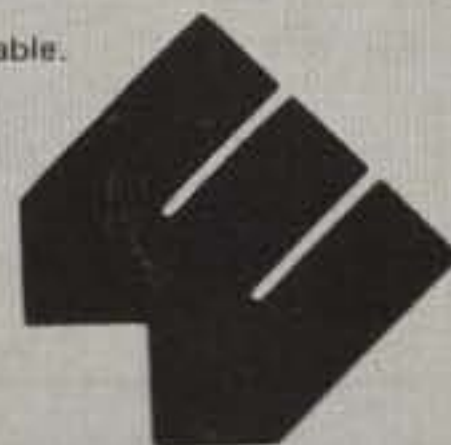

Consumer Products Division

Wilson
Electronics Corp.

4288 South Polaris Avenue • P. O. Box 19000 • Las Vegas, Nevada 89119
Telephone (702) 739-1931 • TELEX 684-522

Staff

EDITOR/PUBLISHER
Wayne Green W2NSD/1

EXECUTIVE VICE PRESIDENT
Sherry Smythe

ASSISTANT PUBLISHER
Jeffrey D. DeTray WB88TH/1

ADMINISTRATIVE ASSISTANT
Dotty Gibson

MANAGING EDITOR
John C. Burnett

ASSISTANT MANAGING EDITOR
Susan G. Philbrick

NEWS EDITOR
Gene Smarte WB6TOV/1

BOOK PUBLICATIONS
Beth Weston

PRODUCTION MANAGER
Lynn Panciera-Fraser

ART DEPARTMENT
Craig Brown
Gayle Cabana
Bob Drew
Bruce Hedin
Carl Jackson
James Lamothe
Dion Owens
Noel R. Self WB1ARP
Robin M. Sloan

PRINTING
Gary Steinbach
Dan Morgan

PHOTOGRAPHY
Bill Heydolph
Tedd Cluff

TYPESETTING
Barbara J. Latti
Mary Kinzel
Holly Walsh

BOOKKEEPER
Knud E. M. Keller KV4GG/1

CIRCULATION
Barbara Block
Laura Barnicle

DATA ENTRY
Mary Kinzel

DIRECTOR OF MARKETING
Robert R. LaPointe

BULK SALES MANAGER
Judy Waterman

SHIPPING
Ethan Perry
Bill Barry
Michelle Walsh

RECEPTIONIST
Denise Loranger

ASSOCIATES
Robert Baker WB2GFE
E. H. Barnett WB0IIX
Schley Cox WB9LHO
Tom DiBiase WB8KZD
Terry Fox WB4JFI
W. Sanger Green
Dave Ingram K4TWJ
Larry Kahaner WB2NEL
Joe Kasser G3ZCZ
Bill Pasternak WA6ITF
John Schultz W4FA
Waller Scott K8DIZ
Peter Stark K2OAW
Bill Turner WA0ABI

COMPUTER PROGRAMMING
Richard J. Dykema
Ron Cooke WB9WHX
Steven B. Lionel

CUSTOMER SERVICE
Florence Goldman
Joyce Tarr
Ellen Blanchard

ADVERTISING
Aline Coutu
Marcia Stone
William G. York
Nancy Clampa
Pat Theriault

W2NSD/1 NEVER SAY DIE

editorial by Wayne Green



RE-REGULATION VS. DE-REGULATION

The FCC's request for input on what rules we want for ASCII transmission is unfortunately typical of the FCC's response to any amateur need. They want to know what new rules to make.

The basic fact, which seems almost unable to perk through to them, is that we do *not* want more regulations. Our problem has been regulations prohibiting our experimenting with and using ASCII—and other modern techniques for information exchange. We want to have the rule prohibiting ASCII deleted—we are not looking for regulations to permit it.

We want to be de-regulated, not re-regulated.

Many of us remember just four years ago when the FCC decided that deregulation for all their services would be a good thing. The regulations were getting so profuse and confusing that it took a battery of lawyers to hack through them. And, since we hams had brought the matter up at a hearing before the FCC in January, 1974, they agreed that they would use amateur radio as a sort of pilot project of deregulation. Well, the pilot light went out somewhere and the FCC fell back into its old habit of generating rules instead of erasing them.

RADAR ZAPPING

How many of you are aware that every time the police zap you with their radar to check your speed, they are irradiating you with a dose of microwaves which is 5,000 times that permitted to leak from a microwave oven? It is no wonder that many policemen have been

having eye and ear troubles which they attribute to their mobile radar units.

Now, you may not care whether you are zapped or not, but would you want your wife and unborn child to get repeated doses of microwaves? We are just beginning to discover how sensitive the fetus is to microwave irradiation, to X-rays, etc. There are a growing number of scientists who are convinced that such unnecessary radiation should be prohibited. One dose might not cause anything discernible . . . nor two . . . but how many times do we get dosed with radar waves? I don't know about you, but I rarely am able to drive 20 miles in New Hampshire without one or two exposures to radar waves. This gives me a cumulative dose of hundreds of exposures, and, as far as we know, these things are cumulative.

With any encouragement, I would found a Church of the Pure Body and one of the basic religious rights I would demand would be a freedom from being irradiated by radar waves. I would print up pads of confession sheets for members of my Church to have with them. When their radar detectors indicate that they have been irradiated against their will and against their religious principles, they would stop and get the signature of the radar officer attesting that he had indeed violated their religious beliefs and had, against their will, irradiated them and their families.

Whether such violations of my belief in a Pure Body could be upheld in court or not, I don't know. But I do know that if enough people want to protest

irradiation, they can raise hell with the system.

VTR: TIME-SAVER

At first, I used the video tape recorder as a way of saving programs which I had been on . . . and as a way to keep from missing shows or movies which were shown while I was away at a ham or computer show, at a club meeting, or perhaps visiting an advertiser. Now I record almost all shows before watching them.

Perhaps you've noticed that the stations sell an incredible number of commercials to pay for those blockbuster movies. As you get on into the movie, you are stopped more and more often for larger and larger bundles of commercials. They run them so often that there is no way to go to the bathroom that much, or even to restock on snacks, so the only thing left is to watch the seemingly endless string of commercials. When watching a recorded movie, all I have to do is fast-forward the tape past the commercials and watch the film almost without interruption.

It didn't take very long before I got so used to avoiding the commercials that I hated to watch a movie directly . . . so now I record all of them. I find that it saves me about half an hour of time on a two-hour movie. That's more time for hamming or computerizing . . . and I still get to see the movie.

JULY WINNER

Our July \$100 bonus check goes to Karl Thurber W8FX/4, whose article "Enjoy All Five Bands" was voted most popular according to our Reader Service card ballots.

The evolution of the MLA

When the MLA-2500 was first introduced it was a new concept in high performance amplifiers. Low and sleek yet powerful enough for the military. Some wondered . . . needlessly.

A promise kept.

The MLA-2500 promised 2000 watts PEP input on SSB. A heavy duty power supply. Two Eimac 8875's. And as thousands of Amateurs across the world have proven, the MLA-2500 delivers!

Now DenTron is pleased to bring you **The new MLA-2500 B.** Inherently the same as the original MLA-2500, the B model includes all of the above specifications plus a few refinements. New high-low power switching for consistent efficiency at both the 1KW and 2KW power levels, and 160 - 15 meters.

Tested and proven.

What better test for an amplifier than the Clipperton DXpedition? Even after 32,000 QSO's, and an accidental dunk in the ocean, the same 3 MLA-2500's are still amplifying other rare DXpeditions around the world - listen for them.

Convinced? Isn't it time you owned the amplifier that powered Clipperton and thousands upon thousands of radio stations throughout the world?

MLA-2500 B \$899.50.



DenTron[®]
Radio Co., Inc.

2100 Enterprise Parkway
Twinsburg, Ohio 44087
(216)425-3173

WINTER '78/79 PRODUCT LINE

*Novice or Advanced...
you can own the world's most
popular transceiver*



AT-200

The AT-200 is an antenna tuner, but it's also much more. It's an antenna switch, an SWR bridge and an in-line wattmeter. The AT-200 reduces the clutter and increases the operating efficiency of your

SP-520

station... and at a surprisingly moderate price. The SP-520 matching speaker offers improved sound in a handsome cabinet. The DG-5 option gives you your exact frequency, while

TS-520S & DG-5

transmitting and receiving, in large easy to read digits by mixing the carrier, VFO, and heterodyne frequencies. The VFO-520 remote VFO is a perfect match for your TS-520S and provides maximum

operating flexibility. The TV-502S 2-meter transverter produces 8 watts on SSB and CW. It easily hooks up to the TS-520 and TS-820 series transceivers, providing an inexpensive method of get-

TS-520S

THE TS-520S SERIES LITERALLY TOOK THE AMATEUR WORLD BY STORM. NO OTHER RADIO EVER CAUGHT ON SO FAST AND THE REASONS ARE OBVIOUS... EXCELLENT PERFORMANCE CHARACTERISTICS, DEPENDABILITY, FLEXIBILITY, AND A VERY SOLID VALUE FOR THE PRICE. AND NOW THE TS-520S SERIES OFFERS THE MOST COMPLETE LINE OF ACCESSORIES AVAILABLE.

FULL COVERAGE TRANSCEIVER

The TS-520S provides full coverage on all amateur bands from 1.8 to 29.7 MHz. Kenwood gives you 160 meter capability, WWV on 15.000 MHz., and an auxiliary band position. And with the addition of the TV-506 transverter, your TS-520S can cover 160 meters to 6 meters on SSB and CW.

OUTSTANDING RECEIVER SENSITIVITY AND MINIMUM CROSS MODULATION

The TS-520S incorporates a 3SK35 dual gate MOSFET for outstanding cross modulation and spurious response characteristics. The 3SK35 has a low noise figure (3.5 dB typ.) and high gain (18 dB typ.) for excellent sensitivity.

NEW IMPROVED SPEECH PROCESSOR

An audio compression amplifier

gives you extra punch in the pile ups and when the going gets rough.

VERNIER TUNING FOR FINAL PLATE CONTROL

A vernier tuning mechanism allows easy and accurate adjustment of the plate control during tune-up.

FINAL AMPLIFIER

The TS-520S is completely solid state except for the driver and the final tubes.

Kenwood has employed two husky S-2001A (equivalent to 6146B) tubes. These rugged, time-proven tubes are known for their long life and superb linearity.

HIGHLY EFFECTIVE NOISE BLANKER

An effective noise blanking circuit developed by Kenwood that virtually eliminates ignition noise is built into the TS-520S.

RF ATTENUATOR

The TS-520S has a built-in 20 dB attenuator that can be activated by a push button switch conveniently located on the front panel.

PROVISION FOR EXTERNAL RECEIVER

A special jack on the rear panel of the TS-520S provides receiver signals to an external receiver for increased station versatility. A switch on the rear panel determines the signal path... the receiver in the TS-820 or any external receiver.

CW-520 — CW FILTER (OPTION)

The CW-520 500-Hz filter can be easily installed and will provide improved operation on CW.

AMPLIFIED TYPE AGC CIRCUIT

The AGC circuit has three positions (OFF, FAST, SLOW) for optimum operation on CW.

AC POWER SUPPLY

The TS-520S is completely self-contained with a rugged AC power supply built-in. The addition of the DS-1A DC-DC converter (optional) allows for mobile operation of the TS-520S.

EASY PHONE PATCH CONNECTION

The TS-520S has two convenient RCA phono jacks on the rear panel for PHONE PATCH IN and PHONE PATCH OUT.

The TS-520S retains all of the features of the original TS-520 that made it tops in its class: RIT control • 8-pole crystal filter • Built-in 25 kHz calibrator • Front panel carrier level control • Semi-break-in CW with sidetone • VOX/PTT/MOX • TUNE position for low power tune up • Built-in speaker • Built-in cooling fan • Provisions for four fixed frequency channels • Heater switch.



VFO-520S

ting on the 2-meter band. The **TV-506** is an equally practical way of getting on the 6-meter band, providing 10 watts on SSB and CW.

The **SM-220** is an extremely useful and unique station

monitor. It allows you to monitor your transmissions, monitor incoming signals and monitor the amount and strength of band activity* and performs as a general purpose 10 MHz oscilloscope, as well.

*With BS-5 or BS-8 pan display option

TV-506

SM-220

 **KENWOOD**
...pacesetter in amateur radio

The TS-820S... known worldwide as the Pacesetter. Amateur Radio Operators universally respect its superb quality, proven through thousands of hours of operating time under all environmental conditions. The TS-820S has every feature any Amateur could desire for operating enjoyment, on any band from 160 through all of 10 meters.



You can always tell who's running a TS-820S. Its superb quality stands out from all the other rigs on the band... and when the QRM gets heavy, the TS-820S's adjustable RF speech processor, utilizing a 455-kHz circuit to provide quick-time-constant compression, will get the message through. RF negative feedback is applied from the final to the driver to improve linearity, and third-order products are at least -35 dB. Harmonic spurious emissions are less than -40 dB and other spurs are less than -60 dB. RF input power is 200 W PEP on SSB, 160 W DC on CW, and 100 W DC on FSK. Receiver sensitivity is better than 0.25 μ V for 10 dB S/N. The TS-820S is known for its superb receiver selectivity, and its famous IF shift easily eliminates heavy QRM. That's why the TS-820S is the DXer's choice.

See your local Authorized Kenwood Dealer today.

TS-820S

The Perfect Station

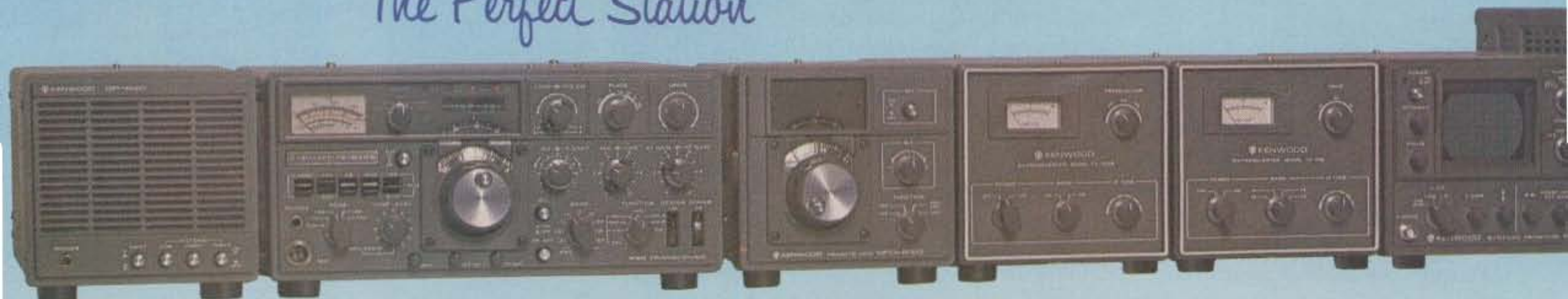

SP-820

TS-820S

VFO-820

TV-502S

TV-506

SM-220



Kenwood's matched pair...

Kenwood developed the T-599D transmitter and R-599D receiver for the most discriminating Amateur

The T-599D transceiver is solid-state with the exception of only three tubes, has built-in power supply and full metering. It operates CW, LSB, USB and AM and, of course, is a perfect match to the R-599D receiver.

The R-599D is the most complete receiver ever offered. It is entirely solid-state, superbly reliable and compact. It covers the full Amateur band, 10 through 160 meters, CW, LSB, USB, AM and FM.

T-599D

Your station isn't complete if it doesn't include the R-820



R-820

Introducing the ultimate in receiver design ... the Kenwood R-820.

With more features than ever before available in a ham-band receiver. This triple-conversion (8.33 MHz, 455 kHz, and 50 kHz IFs) receiver, covering all Amateur bands from 160 through 10 meters, as well as several shortwave broadcast bands, features digital as well as analog frequency readouts, notch filter, IF shift, variable bandwidth tuning, sharp IF filters, noise blanker, stepped RF attenuator, 25 kHz calibrator, and many other features, providing more operating conveniences than any other ham-band receiver. The R-820 may be used in conjunction with the Kenwood TS-820 series transceiver, providing full transceive frequency control.

Additional features include: A monitor switch which allows the user to hear his own voice when using associated transmitter. Either VFO control or crystal control on four selectable frequencies. Digital hold ... locks counter and display while VFO is tuned to another frequency ... facilitates return to "hold" frequency. RIT/notch control ... RIT allows receiver to be tuned off frequency, while not affecting transmit frequency when in transceive mode with TS-820S. Notch control tunes notch within IF passband for eliminating interference. Interfering signal remains notched even when IF shift is utilized. Built-in crystal calibrator, settable to WWV, provides signal every 25 kHz. Noise blanker/level control ... for maximum reduction of noise interference. A transceive/separate switch enables receive VFO to control the receiver and TS-820 (or TS-820S) frequency (or the TS-820 VFO to control both), or, of course, both can function independently.



TL-922A

for the most discriminating Amateur

If you have never considered the advantages of operating a receiver/transmitter combination ... maybe you should. Because of the larger number of controls and dual VFOs the combination offers flexibility impossible to duplicate with a transceiver.

Compare the specs of the R-599D and the T-599D with any other brand. Remember, the R-599D is all solid-state (and includes four filters). Your choice will obviously be the Kenwood.



R-599D

KENWOOD
...pacesetter in amateur radio



10 WATT
...KENWOOD
OFFERS A
CHOICE

TR-7600

...THE RADIO THAT REMEMBERS

Every feature you could possibly want in a 2-meter FM rig is available now in the Kenwood TR-7600...the RADIO THAT REMEMBERS!

Even without its optional "Remote Controller," the TR-7600 gives you...

- Full 4-MHz coverage (144.000-147.995 MHz) on 2 meters
- 800 channels
- Dual concentric knobs for fast frequency change (100-kHz and 10-kHz steps)
- 5-kHz offset switch
- MHz selector switch...for desired band (144, 145, 146, or 147 MHz)
- Mode switch for operating simplex or for switching the transmit

- frequency up or down 600 kHz for repeater operation...or for switching the transmitter to the frequency you have stored in the TR-7600's memory (while the receiver remains on the frequency you have selected with the dual knobs)
- Memory channel...with simplex or repeater (plus or minus 600 kHz transmitter offset) operation
- Digital frequency display (large, bright, orange LEDs)
- UNLOCK indicator...an LED that indicates transceiver protection when the frequency selector switches are improperly positioned, or the PLL has malfunctioned
- 10 watts RF

output (switchable to 5 watts low power)
• Noise-cancelling microphone • Compact size (only 6-7/16 inches wide, 2-7/16 inches high, and 9-3/16 inches deep)

The optional Remote Controller, with a built-in microprocessor, provides more operating features to the TR-7600 2-meter FM transceiver than found in any other rig! With the Remote Controller attached to your TR-7600, you can...

- Select any 2-meter frequency
- Store frequencies in six memories
- Scan all memory channels
- Automatically scan up all frequencies in 5-kHz steps
- Manually scan up or down in 5-kHz steps
- Set lower and upper scan frequency limits
- Reset scan to 144 MHz
- Stop scan (with HOLD button)
- Cancel scan (for transmitting)
- Automatically stop scan on first busy or open channel
- Operate on MARS (143.95 MHz)
- Select repeater mode (simplex, plus transmit frequency offset, minus offset, or any of six memory transmit offsets)
- Select transmit offset (1 MHz/600 kHz)

The Remote Controller's display indicates frequency (even while scanning) and functions (such as autoscans, lower scan frequency limit, upper scan limit, error, and call channel).

Subject to FCC approval.



TS-700SP

SP-70 VFO-700S

Still the same fine, time proven rig. But now with the simple addition of a plug-in crystal, the TS-700SP will be able to utilize the new repeater sub-band (144.5 to 145.5 MHz). Still features all of the fine attributes of the TS-700S: A digital frequency display, receiver pre-amp, VOX, semi-break in, and CW sidetone. Of course, it's all mode, 144-148 MHz, VFO controlled...and Kenwood quality throughout.

Features: 4 MHz band coverage (144 to 148 MHz) • Automatic repeater offset capability on all FCC authorized repeater subbands including 144.5-145.5 MHz • Simply dial receive frequency and radio does the rest...simplex, repeater, or reverse. Same features on any of 11 crystal positions • Transmit/Receive capability on 44 channels with 11 crystals • Operates all modes: SSB (upper and

lower), FM, AM and CW • Digital readout with "Kenwood Blue" digits • Receiver pre-amp • Built-in VOX • Semi break-in on CW • CW sidetone • All solid-state • AC and DC capability • 10 watts RF output on SSB, FM, CW • 3 watts on AM • 1 watt FM low-power switch • 0.25 μ V for 10 dB (S+N)/N SSB/CW sensitivity • 0.4 μ V for 20 dB quieting FM sensitivity.

OR **25 WATT** OUTPUT



TR-7400A

The fully-synthesized TR-7400A 2-meter FM transceiver operates on 800 channels and features repeater offset over the entire 144-148-MHz range, dual frequency readout, six-digit display, and subaudible tone encoder and decoder. RF output is at least 25 watts!

The TR-7400A 2-meter FM transceiver provides fully synthesized operation, including 600-kHz repeater offsets, over the entire 144-148-MHz range. It can operate on any of 800 channels, spaced 5 kHz apart. RF output is at least 25 W, and typically 30 W. A low power position produces 5-15 W (adjustable). Included is a dual frequency readout with large six-digit LED display plus a dial readout. The sub-

audible CTCSS signaling feature may be used on transmit and receive, or transmit only. Optional tone-burst modules are available. Receiver sensitivity is better than 0.4 μ V for 20 dB quieting. Large, high Q, helical resonators minimize interference from outside the band. A two-pole 10.7-MHz monolithic crystal filter provides excellent selectivity.

Intermodulation distortion is down more than 66 dB, spurious rejection is better than -60 dB, and image rejection is better than -70 dB. See your local Authorized Kenwood Dealer today, for a demonstration of the fantastic TR-7400A.



TS-600

Experience the excitement of 6 meters. The TS-600 all mode transceiver lets you experience the fun of 6 meter band openings. This 10 watt, solid state rig covers 50.0-54.0 MHz. The VFO tunes the band in 1 MHz segments. It also has provisions for

fixed frequency operation on NETS or to listen for beacons. State of the art features such as an effective noise blanker and the RIT (Receiver Incremental Tuning) circuit make the TS-600 another Kenwood "Pacesetter".

KENWOOD
...pacesetter in amateur radio



Give your signal extra muscle

TL-922A

The Kenwood name has grown to represent the finest Amateur Radio equipment available. The TL-922A linear amplifier carries on that tradition. As a linear it gets your signal through today's crowded bands and provides the power to reach those far away places with ease. And because it's Kenwood you can count on its dependability. The TL-922A is FCC type accepted. It runs the full legal limit on all ham bands from 160-15 meters and is compatible with most amateur exciters. Contact your nearest Authorized Kenwood Dealer for complete specifications and the best deal.

WHY SHOULD THE TL-922A BE PART OF YOUR STATION? COMPARE THESE FEATURES AND SPECS... THE ANSWER WILL BE OBVIOUS.

Instant heating filaments — The 3-500Z tubes require no warm up period. Just turn it on and go!

Time delay fan circuit — Even after you turn the TL-922A off, the super quiet fan continues to work for approximately 2 minutes to greatly extend tube life.

Adjustable ALC output voltage — Lets you tailor the ALC voltage to your exciter.

Standby position — Provides amplifier bypassing without having to turn the AC power off.

Two independent safety interlocks — One disconnects

AC line voltage and the second shorts B+ to ground when tripped.

Vernier plate control — For smooth, easy tune-up.

Diecast side panels — Includes functional carrying handles for easy transportation.

Thermal protection of power transformer — Amplifier automatically switches to standby if power transformer temperature exceeds 145°F.

Tuned Input Circuit — Means improved spurious characteristics.

Line voltage selector — Easily switched between 120 and 240 VAC.

Multimeter — Reads high voltage, relative output or grid current (selectable).

Plate Current Meter — Separate meter allows continuous monitoring of plate current.



For the best in world listening

R-300

Dependable operation, superior specifications and excellent features make the R-300 an unexcelled value for the shortwave listener. It offers full band coverage with a frequency range of 170 kHz to 30.0 MHz • Receives AM, SSB and CW • Features large, easy to read drum dials with fast smooth dial action • Band spread is calibrated for the 10 foreign broadcast bands, easily tuned with the use of a built-in 500 kHz calibrator • Automatic noise limiter • 3-way power supply system (AC/Batteries/External DC) ... take it anyplace • Automatically switches to battery power in the event of AC power failure.

Escape the rat race... try 440 MHz FM!



TR-8300

How would you like to work an uncrowded frequency... hear signals with less noise... or use a sophisticated repeater or remote base with better coverage? 440 MHz is the answer. It will surprise you. It will penetrate buildings where 2 meters won't, and often you can even work out from underground garages... where 2 meters is dead. Best of all, it's easy to get on 440 MHz (70 cm)... with a Kenwood TR-8300 transceiver. High quality is critically important on VHF bands, and the TR-8300 is just what you need to meet all technical requirements.

- 10 watts RF output (switchable to 1 watt)
 - 23 crystal-controlled channels (3 supplied)
 - 445.0-450.0 MHz transmit range
 - 442.0-447.0 MHz receive range
 - Transmitter and receiver adjustable over any 5-MHz segment from 440 to 450 MHz
 - 5-section helical resonator and 2-pole crystal filter in IF to reject intermod
 - SWR protection in final amplifier
 - Excessive-voltage and reverse-polarity protection circuits
 - 0.5 μ V for 20 dB quieting sensitivity
 - Better than -60 dB spurious radiation
 - 20 kHz (-6 dB), 40 kHz (-70 dB) selectivity
 - Monitor switch that lets you check modulation and frequency "netting"
 - Call CH switch that activates optional CTCSS (subaudible tone) function
 - Large S meter
- Move up to 440 MHz today... with a Kenwood TR-8300... for more reliable communications!*

Fine equipment that belongs in every well equipped station

HF LINES

- 820 Series**
 TS-820S... TS-820 with Digital Installed
 TS-820... 160-10 m Deluxe Transceiver
 YG-88A... 6-kHz AM filter for R-280
 YG-455C... 500-Hz CW filter for R-820
 YG-455CN... 250-Hz CW filter for R-820
 DG-1... Digital Frequency Display for TS-820
 VFO-820... Deluxe Remote VFO for TS-820/820S
 SP-820... External speaker with audio filters
 CW-820... 500 Hz CW Filter for TS-820/820S
- 520 Series**
 TS-520S... 160-10 m Transceiver
 DG-5... Digital Frequency Display for TS-520 Series
 VFO-520... Remote VFO for TS-520 and TS-520S
 SP-520... External Speaker for 520/820 Series
 CW-520... 500 Hz CW Filter for TS-520/520S
 DK-520... Digital Adaptor Kit for TS-520

599D Series

- R-599D... 160-10 m Solid State Receiver
 T-599D... 80-10 m Matching Transmitter
 S-599... External Speaker for 599D Series
 CC-29A... 2-meter Converter for R-599D
 CC-69A... 6-meter Converter for R-599D
 FM-599A... FM Filter for R-599D

HF ACCESSORIES

- TL-922A... 160-15 m kilowatt linear amplifier
 SM-220... Station monitor, 10-MHz scope

- BS-8... SM-220 pan display for TS-820 Series
 BS-5... SM-220 pan display for TS-520 Series
 AT-200... 200-W antenna tuner, SWR/power meter, switch
 DS-1A... DC-DC Converter for 520/820 Series

SHORT WAVE LISTENING

- R-300 General Coverage SWL Receiver

VHF LINES

- TS-600... 6 m All Mode Transceiver
 TS-700SP... 2 m All Mode Digital Transceiver
 VFO-700S... Remote VFO for TS-700S
 SP-70... Matching Speaker for TS-600/700 Series
 VOX-3... VOX for TS-600/700A
 TR-7400A... 2 m Synthesized Deluxe FM Transceiver
 TR-7600... 2 m FM transceiver with 800 channels and memory

- RM-76... Remote Controller for TR-7600 with six memories, scanning
 TR-8300... 70 CM FM Transceiver (450 MHz)
 TV-506... 6-m Transverter for 520/820/599 Series
 TV-502S... 2-m Transverter for 520/820/599 Series

POPULAR STATION ACCESSORIES

- HS-4... Headphone Set
 MC-30S... low-impedance mobile noise-cancelling microphone
 MC-35S... high-impedance mobile noise-cancelling microphone
 MC-50... Desk Microphone
 PS-6... Power Supply for TR-8300
 PS-8... Power Supply for TR-7400A

Trio-Kenwood stocks a complete line of replacement parts, accessories, and manuals for all Kenwood models.

MORE ACCESSORIES:

| Description | Model # | For use with |
|---------------------------|--------------------|-------------------|
| Repeater Subband Kit | RSK-7 | TS-700A/S |
| Rubber Helical Antenna | RA-1 | TR-2200A |
| Telescoping Whip Antenna | T90-0082-05 | TR-2200A |
| Ni-Cad Battery Pack (set) | PB-15 | TR-2200A |
| 4 Pin Mic. Connector | E07-0403-05 | All Models |
| Active Filter Elements | See Service Manual | TR-7400A |
| Tone Burst Modules | See Service Manual | TS-700A; TR-7400A |
| AC Cables | Specify Model | All Models |
| DC Cables | Specify Model | All Models |



The Kenwood HS-4 headphone set adds versatility to any Kenwood station. For extended periods of wear, the HS-4 is comfortably padded and is completely adjustable. The frequency response of the HS-4 is tailored specifically for amateur communication use. (300 to 3000 Hz, 8 ohms).



The MC-50 dynamic microphone has been designed expressly for amateur radio operation as a splendid addition to any Kenwood shack. Complete with PTT and LOCK switches, and a microphone plug for instant hook-up to any Kenwood rig. Easily converted to high or low impedance. (600 or 50k ohm).

TRIO-KENWOOD COMMUNICATIONS INC.
 1111 WEST WALNUT/COMPTON, CA 90220

But guess who's working on UHF SSB? Good old FCC. See IEEE *Spectrum*, July, 1978. And who is looking on this proposal with horror? General Electric. They are still in there fighting (but for FM this time). Maybe they'll win this one.

Jack Althouse K6NY
Escondido CA

SIBILANCE

I must say that the August "Never Say Die" may well be your best and eventually most fruitful editorial insofar as goes improving amateur voice communications and perhaps the entire commercial radiophone medium! It now seems clear that we were prematurely sold a bill of goods in SSB.

As a radioman in Alaska in the 1950s, I shared spectrum data with two visiting FCC frequency coordinators, Messrs. North and Krebs, to help them formulate recommendations on frequency changes in Alaska.

Mr. Krebs, now retired and perhaps still living in Silver Spring MD, had attended a symposium where the synchronous detection of DSB was demonstrated. Most enthusiastic over what he saw and heard, Mr. Krebs mailed us a set of technical papers on DSB which since have been lost. It is hoped his attention might be obtained through your editorial. Perhaps a ham in Silver Spring could locate Mr. Krebs and the technical material on DSB.

As an old hand of 25 years in the Alaskan commercial AM phone networks between canneries, it is most galling today to hear these same persons who used AM striving on SSB for accuracy by constantly repeating important figures and descriptions because of the transparent deficiencies of SSB.

If nothing else, DSB should greatly improve speech and, hopefully, elevate individual voices so that all of us do not sound as if we were born with identical vocal cords, devoid of the sibilance required to clarify speech. Twenty meters would be an ideal area to experiment with synchronous detection of DSB. Let's get cracking!

F. W. Anderson W7AR
Seattle WA

MISSIONARY TACTICS

Wayne, you are fast becoming a world traveler, but I think you should tour the U.S. a little more in order to completely

understand the attitude of the African black bloc as far as amateur radio is concerned.

While the dark continent thinks of ham radio as a white man's hobby, with negative feelings about the whole matter, there are those blacks in the United States who view the situation in pretty much the same way. And this view has blown itself across the ocean and displayed itself among African nations.

Having done research on black hams in America, it is quite interesting to learn just how few there are. The reason for this is that when white hams learn the operator is black, he has no particular desire to "buddy-buddy" with him or carry on a QSO. Therefore, potential black hams who could also contribute to the cause of amateur radio feel left out of the mainstream of another event. Do not for one moment think the African nations are not aware of such prejudices in amateur radio in this country.

I once lived in Chicago and actually witnessed these accounts. If Chicago has over 100 black hams, I would be certainly surprised. Rockford, Illinois, has only one active black ham (a city of 147,000 people). While we were doing a local area survey, it was discovered that only a minute percentage of black hams were what we term "gung-ho" active.

Wayne, before we go trying to convince the Africans how great ham radio is, we'd better practice some of those missionary tactics you are proposing to ARMA over here. I don't know how one would expect results from WARC next year if all hams do not feel united.

Jack Chancellor W9SON
Rockford IL

THE VILLAIN

Good for you, W0HKF—you took the words right out of my mouth. I could not have said it better. In its way, 73 is a really good magazine, but it could be better if Wayne Green would just lay off the ARRL. I wonder what his real aim or objective is. Is it to destroy the only real voice we have in amateur radio and try to replace it with his—heaven forbid! Wayne reminds me of little two-bit politicians just starting out—all they have to offer is criticism of the incumbent—nothing they do or have ever done is right. Possibly just to draw interest, is Wayne trying to be the villain in professional wrestling? I have been in amateur radio and a solid member of the ARRL for well over 50 years, during which time I have seen many other

ham magazines come and go. Most of the time they made the mistake of attacking the ARRL. They try to fool their readers into thinking the ARRL is asleep at the switch and doing nothing for amateur radio. Now, is there anyone better qualified to represent us? Wayne should lay off the ARRL and concentrate on improving his own magazine, or my present subscription will be my last.

Merrill Eidson W5AMK
Temple TX

IMPRESSED

I want to thank you for the hospitality shown by your people toward Karen and me during our visit to 73 in August. That's quite an operation you folks are running.

Our special thanks go to Ms. Doni Jarvis. Despite the fact that we simply dropped in on 73 with no notice, she broke her routine to give us the "twenty-five-cent tour" and made us feel welcome. We appreciate it.

For a long time now you've been raving about the Peterborough area. You certainly weren't kidding. It's probably the nicest area we've ever seen. I'm looking into buying some property there—that's how impressed we are.

My new 3-year subscription to 73 should tell you how impressed I am with your magazine.

So, from the snottiest human in the U.S. Army to the "snottiest SOB in the ham radio world"—thanks. Hang in there, and keep giving them hell.

Maj. Larry Palletti KA7ABC
Lt. Karen Palletti KA7AHZ
Sierra Vista AZ

6M GUIDANCE

Perhaps you could help to guide 6 meter FM out of impending trouble by publishing some frequency guidelines for those unfamiliar with the channel increments which have been in use throughout the country for the past 15 years. As you know, Wayne, being one of the "pioneers" yourself, the FM channels were set up in 20 kHz (or 40 kHz for WBFM) increments from the alternate national calling frequency of 52.64 MHz, with the exception of the primary national frequency of 52.525 MHz.

The repeater splits have not really been agreed to. Some have been running 200 kHz, 600 kHz, or 1 MHz. The problem that is occurring stems from a repeater plan using 1 MHz splits starting with 52.01/53.01, 52.03/53.03, etc. Some new-

73

Study Guides
and
Code Tapes —
The Best Available

see page 316

comers to 6 FM have been utilizing this plan, which puts repeater outputs 10 kHz away from established 20 kHz spaced channels. I would therefore suggest 52.02/53.02, 52.04/53.04, etc., as a modification of this plan for compatibility, since, as we have learned from 2 meters, 15 kHz is not ideal spacing for ± 5 kHz NBFM, to say nothing of 10 kHz adjacent channels.

John R. Haserick W1GPO
Tolland CT

TEXAS DEFENSE

I read Wayne's report some time ago about "unfriendly" repeaters in Texas. I can't imagine whom he talked to or which repeaters he meant, but please give us another chance some time. Friendly repeaters, hams, and people can be found in and around Austin TX.

Ron Johnson WA5RON
Austin TX

ADVANCED FREQUENCIES

I believe your printing company has made an error in the July, 1978, issue of 73.

On page 186, in the second column under "FCC," at paragraph 97.7 (the operator's privileges vs. licenses), your table shows that frequencies 3800-3890 kHz are for Extra licensees only. As a holder of an Advanced ticket, I am sure this privilege has not been taken from us!

The last four lines of this table should, I believe, be frequency privileges for amateur Extra and Advanced licenses.

Fred Collings W2GTN
Avalon NJ

Fred, you're not the only one who picked up the apparent error. However, it appeared exactly that way in the Federal Register. We're confident that it is a mistake, but with the FCC, you just never know.—J.D.

RTTY Loop

Marc I. Leavey, M.D. WA3AJR
4006 Winlee Road
Randallstown MD 21133

The winter is coming! With the change in weather should come increased on-the-air time for many of us on RTTY. The essence of receiving an HF RTTY signal has been covered here before, but one assumption was always made—that you started with a perfectly-tuned-in signal. This month we will discuss ways to achieve that goal.

For those of you working AFSK on the VHF bands, once you have acquisition of a signal, the tones are as correct as the transmitting station can make them. For you, there is no problem, so go read Wayne's editorial; the rest of you, stick with me. The goal here will be to tune the demodulated FSK to produce the proper audio tones for optimum converter performance. If you are blessed with perfect pitch, it's easy. Just have the sending station transmit a mark, tune to 2975 Hz, and you're all set. If you are not so blessed, however, it is not quite so easy. Yes, you could use a frequency counter on the output of your receiver to measure the frequency of the tone produced during mark. There are several reasons why this is not practical. To begin with, any static or garbage, anything less than a solid signal, would be difficult to count with the accuracy required for RTTY. Further, few stations routinely send long marks for you to tune on, unless you ask them. And if you ask them, you're already in communication, so why bother! What you need is a way to tell if you have tuned in an actively shifting FSK signal correctly, and maybe even some way of telling if the shift is appropriate.

One of the early solutions to this problem is evident in the

design of the W2PAT converter, a circuit first popularized in the 1950s. The output of each detector, mark and space, was fed through a neon bulb, such as an NE-2. This served two functions. First, the conductance characteristics of the bulb shaped the impulse to give a sharp edge to the keying impulse. Just as importantly, the lighting of the bulb gave visual proof that a signal was being decoded. By tuning the FSK signal until the mark and space lamps smoothly flickered back and forth, one was reasonably assured of a properly-tuned-in signal.

Hams being what they are, and the state of the art constantly thrusting forward, a tuning indicator using a 6AF6 "Magic Eye" was described in the late 50s by W1FGL. This simply used the eye tube to pick off and display the decoded pulses, much as the neon lamps had done earlier. Because they were not subject to the abrupt turn-on and turn-off points of the lamps, however, they were more sensitive in tracking a drifting or off-tune signal.

Another major modification to the indicator effort came about when it was realized that the signals available at the filter outputs of most converters could be fed to a conventional oscilloscope's horizontal and vertical inputs. The pattern produced is frequently called the "cross" or "+", with the mark signal typically represented by the vertical pattern and the space by the horizontal, although there is some individual variation about this. No special oscilloscope is needed for this, and it is very easy to implement. The diagrams show how to connect up a scope and some typical patterns.

Another kind of oscilloscope display, although appearing

similar to the above, is quite a bit more complex. This is the "X" display produced by a phase detector. Although popular some years back, the complexity needed to produce a display of two lines, at 45° and 135°, is more than most hams require.

A final kind of razzle-dazzle scope display is an audio spectrum analyzer, as described in 73's new *RTTY Handbook*. This displays the audio spectrum along a horizontal axis, with vertical pips representing each received frequency. Verrrry interesting!

Of course, one does not have to have an oscilloscope, winking eye, or flashing lights to tune RTTY. Meters are quite serviceable and can be used to receive a signal. Although most hams have a meter in the 60 mA loop, this really cannot be used to tune the signal. This is because the meter does not reflect the input, but rather the output after all processing has taken place. Also, the flickering of the meter, between nearly full scale and zero, is too rapid to be interpreted during normal transmissions. If, however, the output of one of the detectors is inverted so that they are both of the same polarity, they can be applied to a meter directly. This is the technique used in the popular HAL ST-6, designed by Irv Hoff W6FFC. The signal is tuned until the meter peaks and holds steady, indicating maximum output through both filters. The method is elegantly simple and works quite well.

Although this is, admittedly, a brief overview of the tuning and indicator devices in use and available to the amateur RTTYer, I hope it provides some guidance to the ham contemplating adding an indicator to his station. It would seem that, for general use, one of the oldest systems around, the "+" pattern scope, may be one of the easiest to implement and interpret. It requires a minimum of exotic equipment, the converter, and a garden-variety oscilloscope, which most hams

have around. Useful information is readily obtained from the display, and no changes are needed for different shifts, assuming the TU filters are changed appropriately.

THANKS TO THE READERSHIP DEPARTMENT

In July, 1978, we passed along the information that K4FRY needed information to run the Kenwood R599/T599 on RTTY. A letter received from Norm Tetreault KX6HC/W1FO passed along the following information:

"For reception, the R599 is in the LSB mode with CW filter switched in. This results in an audio output band of 1230-1770 Hz. I tuned the PLL in my TU to work in this band. An article in the September, 1973, issue of *RTTY Journal* (see below) describes a technique to move the band to about 2200 Hz.

"For transmission, the solution is simplicity itself. Both the R599 and the T599 use the identical vfo. The receiver has a front panel incremental tuning control (RIT), while the transmitter does not. Scrutiny of the receiver and transmitter schematics will show that both have an identical voltage regulator assembly (AVR) in the transmitter, point 'RT3' is unused. In the receiver, it is connected to the RIT pot. Connecting a resistor from RT3 (on the transmitter AVR) to ground causes the vfo to shift in frequency. A value of 39k causes about a 200 Hz shift. I installed a 22k right at the RT3 point and brought the lead out on a blank pin of the cable connector in the rear of the transmitter." Norm drove the modification with TTL logic, but there is no reason that a reed relay or similar circuit could not be used if your system is not TTL-based. A 50k pot or so is used in series with the 22k resistor to "fine tune" the shift to 170 Hz.

A review of the *RTTY Journal* article, entitled "Using Kenwood R599 Receiver for RTTY," by Bill Craig WB4FPK dem-

Continued on page 30

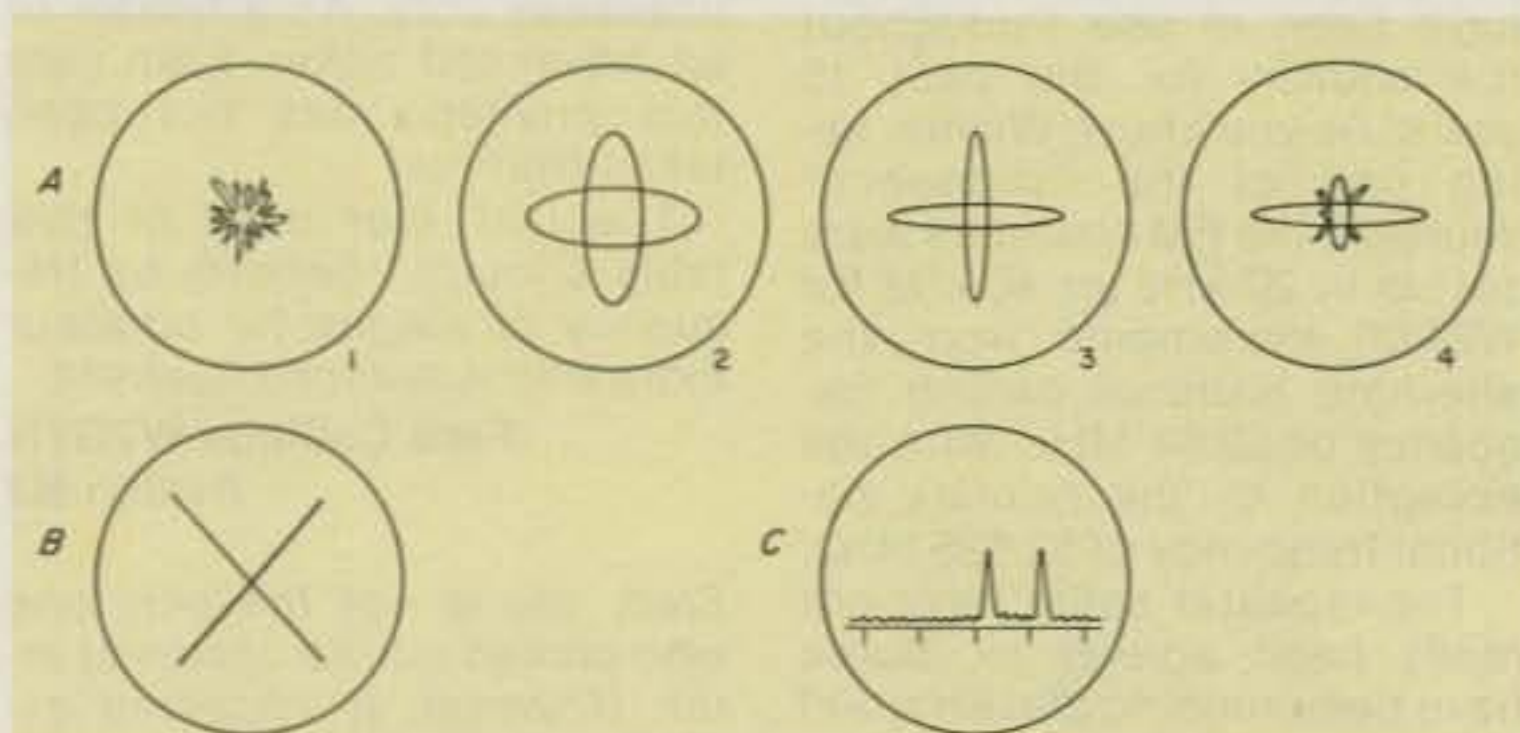

Fig. 1. Oscilloscope patterns. A: Common "+" patterns—1. No signal, just noise; 2. Good signal, broad filters; 3. Good signal, sharp filters; 4. Selective fade of space with noise, sharp filters. B: Cross pattern of phase detector. C: Spectrum analyzer display.

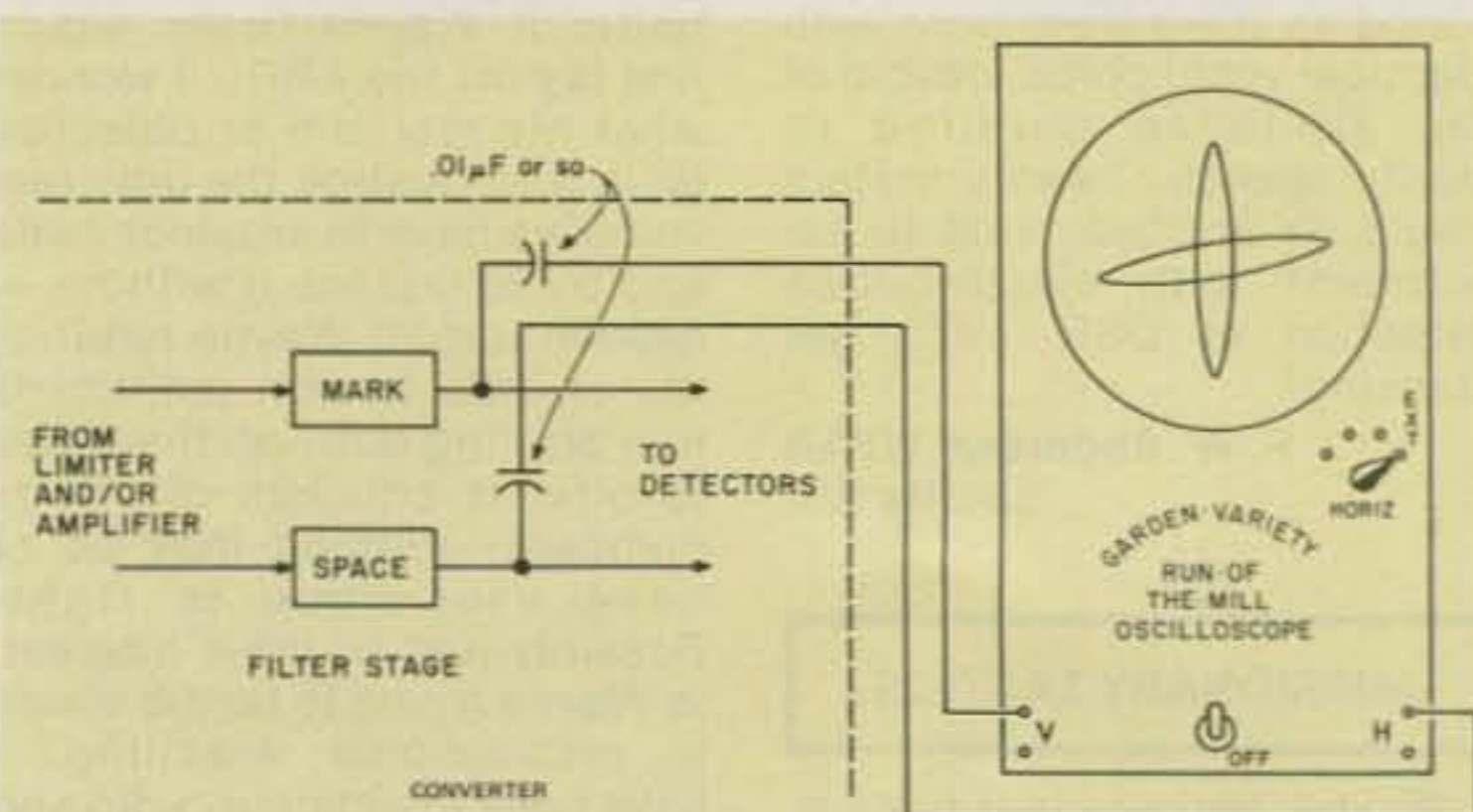

Fig. 2. Diagrammatic representation of how to hook up a garden-variety, run-of-the-mill scope to a converter.

ICOM stacks it all in your favor.



All ICOM radios significantly exceed FCC specifications limiting spurious emissions.

HF/VHF/UHF AMATEUR AND MARINE COMMUNICATION EQUIPMENT

DISTRIBUTED BY:



ICOM

ICOM WEST, INC.
Suite 3
13256 Northrup Way
Bellevue, Wash. 98005
(206) 747-9020

ICOM EAST, INC.
Suite 307
3331 Towerwood Drive
Dallas, Texas 75234
(214) 620-2780

ICOM CANADA
7087 Victoria Drive
Vancouver B.C. V5P 3Y9
Canada
(604) 321-1833

Looking West

Bill Pasternak WA6ITF
24854-C Newhall Ave.
Newhall CA 91321

With love in his eyes, he calls them "my kids." True, most of them are children, but there are a good number who are well past childhood. Whether two or sixty-two, they are all "his kids" and are held together by a common bond. They all suffer from a ravaging disease called muscular dystrophy. Many of the younger ones will never reach adulthood unless a miracle of medical science takes place—unless a cure is found for this "killer." It's Labor Day, 1978, and on the TV screen is the "clown." Possibly the greatest humanitarian this country has ever known stands before you in hope of raising enough money so that research into the cause of MD can continue, so that doctors can find a way to cure "his kids." It's the annual Labor Day MDA Telethon, and the host is a rare human being named Jerry Lewis.

About two years ago, I had the honor of briefly meeting Jerry in the lobby of the Sahara Hotel in Las Vegas. I was attending SAROC, and Mr. Lewis was the headline attraction at the hotel's "Congo Room." It was a very brief encounter, but as a result the idea hit me that there might be some way that this nation's 300,000 amateurs could take part in his next telethon. So, while in Las Vegas, Bill Orenstein KH6IAF and myself spoke with a person from the Telethon and made our suggestion.

Shortly after arriving back in L.A., we were contacted by the local MDA people. A meeting was arranged at the North Hollywood Holiday Inn between the MDA people and members of the local amateur community. We sat and discussed different ways in which amateur radio operators could involve themselves in the Telethon, and one thing was soon obvious. While the MDA needed our bodies, as individuals and collectively as clubs to solicit funds for them, they did not need our repeaters or HF SSB kW stations. They did not need that form of "communication." What they needed was for people like you and me to give of ourselves and to convince our friends and neighbors to give as well.

Ever try to sell such an idea to a group of hams? To tell them they, not their radios, were wanted? That though the event itself was necessary,

they could do little with their radios? It was an impossible sales job, and soon the idea died due to lack of support from the local amateur radio community. As a local CB club president came on camera and handed the local emcee a check for \$14,140 which his club had collected from local CBers, I again remembered our attempt two years ago to involve amateur radio in this worthwhile effort.

The rest of the afternoon, I was bothered by something. Why could "CB" be so successful in these ventures while amateur radio never seems to quite pull it off? Sure, we handle disaster communication better than CB could ever hope to. We seem to handle any type of communications effort with more proficiency, so why is it that in cases such as this CB has it all over us? Simply stated, it's that the MDA Telethon is not a communications effort in the same sense of the word "communications" as we amateurs know it. But communication is more than just speaking into a microphone or pounding brass in order to be heard by another amateur halfway around the world. There is another more important meaning—the ability of one human to interrelate with another.

In the case of Jerry's kids, the best way in which we can communicate is in the same way as that of the Los Angeles CB community and millions of other non-radio-oriented Americans: by pledging a few of our hard-earned dollars and then trying to convince our friends to do the same. There is no need for two meter handhelds or high power SSB stations. All we need is a little love in our hearts to become part of Jerry's "Love Network," a television network made up of 213 TV stations and millions of human beings like you and me who care about our fellow man.

I would like to suggest that local radio clubs who are interested in getting amateur radio involved in the MDA campaign contact either the local MDA people or the TV station which carried this year's Telethon. Don't try to tell them what a great communications vehicle you are. They don't need your local repeater or club station. What they need is you. The local fund-raising personnel from MDA will know how to direct you in fund-raising endeavors, and you can then modify things to suit your own talents. Some ideas I came up

with included radio equipment auctions, where the proceeds are donated to MDA in the name of your club, or T-hunts where there is an entrance fee which becomes your club's donation. Also, don't go into such a project seeking glory for yourself or the amateur service. To do so would be defeating the purpose of the whole thing. If you involve yourself and/or your club with MDA or any other worthwhile charity, there must be only one motive: love. If your devotion is real, recognition will come your way. You won't have to go looking for it.

THE SIMPLEX AUTOPATCH REVISITED

In the many years I have been writing Looking West, no one topic has ever brought the response that our reporting on John Walker's simplex autopatch has generated. The magazine had barely hit the newsstands when the letters started to roll in—and they have yet to stop. Most of them requested specific information as to how to build one, information I do not possess. I have tried to at least answer all requests and have forwarded same to John. Hopefully, he will soon have a technical article prepared; if all goes well, you should see it soon in 73.

In the meantime, I would like to request that any information requests on any topic be accompanied by an SASE; I also would like to thank all those who were thoughtful enough to enclose one. They're not for me—rather, I forward them along with information requests to the source from which such information must originate. With postal costs continually on the upswing, an SASE is one way to ensure getting an answer to your questions.

One piece of information that our postal person brought was that John is not the only person who has successfully developed a working simplex autopatch. In his note, Bob Nickels WA0OHO, owner of WR0AEA, let us know that he has had such a system in operation for some time and that "it works beautifully." Bob noted that he is involved in patent filings and did not detail the overall system, but he did note with some pride that his idea did not develop in "Silicon Gulch." So, thanks to Bob's works, Nebraska has one heck of a technological advancement as part of its area amateur operation. Kudos to people like John and Bob who consider the future a challenge and help take amateur radio and overall technology another step forward.

ANSWERING THE CRITICS DEPARTMENT

Bob's letter also took us to task a bit for limiting our coverage to the southwestern United States, with only occasional attention paid to happenings outside this area. I can't and won't deny that this is the case. As I wrote to Bob, and to others who have brought up this matter with me, it's simply a matter of economics. Unlike reporters who work for large national news gathering services or TV networks, I have no expense account. I do not work for 73, but rather function as an independent Associate Editor. Therefore, I must rely on input supplied from areas which are out of the reach of one or two tanks of gas. In other words, it is you who read Looking West who are my prime source of input for future columns. There is no way that I can come to you, so I must rely on you to come to me via the U.S. mail. I have said it before, but I'll say it again. If there is something which you feel is newsworthy, something you feel would be of interest to your fellow amateurs, something you feel would benefit all of us, send it to me. Send it directly to my home address and please enclose a phone number so that I can get back to you if I need more details. Also, don't get alarmed if you write me in mid-November and don't see your information in the December column. There is a sixty-day-plus lead time.

T-HUNTING AND DEALING WITH JAMMERS DEPARTMENT

The latest item to come into the search for those who would destroy the ability of this area's amateurs to communicate is known as the Doppler scan DF unit. This was first described in the June, 1978, QST, and a number of units were built and modified for even better performance by a number of local amateurs, including Paul W6AOP and Don WA6MHN. These two people have become L.A.'s resident experts on the unit. Not a day seems to go by when I don't overhear one or the other describing another improvement to the original design. Many such units are under construction or are in service already. It's interesting to note that as more of these units enter operation, the overall level of malicious interference drops. Whether it's directly related to the emergence of such units or mere coincidence is anyone's guess, but the fact remains that the overall interference level drops as a given system sets up to T-hunt with these units.

Paul Wirt W6AOP, who once

Continued on page 30

If you expect to invest in a new ham antenna in the next 90 days, invest 15¢ postage to get Antenna Specialists' brand new, complete ham catalog today.



FREE decal just for fun!

Name _____
 Address _____
 City _____ State _____ Zip _____



the antenna specialists co.

✓ A62 a member of The Allen Group Inc.
 12435 Euclid Ave. Cleveland, Ohio 44106
 Export: 2200 Shames Drive, Westbury, L.I., New York 11590
 Canada: A. C. Simmonds & Sons, Ltd.

Stop overfeeding your antennas.



only **\$29.95**

Kantronics Sky Switch antenna isolator

RG-58/U costs too much to use more than you need!

Kantronics Sky Switch antenna isolator can save you enough in RG-58/U alone to pay for itself*. With a Sky Switch mounted on your antenna tower, you can bring your HF and 2 meter antennas in on the same feedline! No special relays or control wires are needed, the Sky Switch chooses the proper antenna for you.

This means less coax, less wire hanging around, less cash outlay and less headaches for you! Put your antennas on a diet, order a Sky Switch today.

*Assuming you use a 40 foot tower, 20 feet from your station, and coax at \$.50 a foot.

✓ K13 **KANTRONICS**
 The Lightweight Champs.
 1202 East 23rd Street, Lawrence, Kansas 66044 Phone: 913-842-7745
 We accept Visa, Master Charge, check, and money orders.

new FROM ALLIANCE!



HD-73 HEAVY-DUTY ROTATOR

with exclusive **Dual-Speed Control!**

For antennas up to 10.7 sq. ft. of wind load area. Mast support bracket design permits easy centering and offers a positive drive no-slip option. Automatic brake action cushions stops to reduce inertia stresses. Unique control unit features DUAL-SPEED rotation with one five-position switch. SPECIFICATIONS: Max. wind load bending moment—10,000 in.-lbs. (side-thrust overturning); Starting torque — 400 in.-lbs.; Hardened steel drive gears; Bearings — 100-3/8" diameter (hardened); Meter — D'Arsonval, taut band (back-lighted). There's much, much more — so get the whole story!

Mail this coupon for complete details!

YES! Send me complete details on the new HD-73!
 Give me the name of my nearest dealer!

NAME _____
 ADDRESS _____
 CITY _____
 STATE _____ ZIP _____

 The **ALLIANCE** Manufacturing Co., Inc., Alliance, Ohio 44601
 A NORTH AMERICAN PHILIPS COMPANY ✓ A57
 Maker of the famous Antenna Rotator . . . Alliance Tenna-Rotor® . . . "TV's Better Color Getter!"

© 1978 The Alliance Mfg. Co., Inc.

Chuck Stuart N5KC
5115 Menefee Drive
Dallas TX 75227

DX PROFILE

If you regularly work the low end of the 20 meter phone band, then you have probably heard the booming signal of Don Winfield K5DUT, the Dirty Ugly Texan from Cowtown, Texas. Cowtown is a small rural village 30 miles west of Dallas, sometimes called Ft. Worth.

Don's interest in amateur radio began in 1956 when, as a teenager, he picked up a local ham breaking in over the music on a small crystal set he had built. When Don heard the local give his address, he jumped on his bicycle and rode over for a visit. From that visit came an intense interest in amateur radio, and a new Novice license soon resulted. His first rig, built on an old apple crate, was a 6L6 running 20 Watts on 80 meter CW. Hardly an omen of what was to come, it took Don a month to work out of Texas.

Don's interests in amateur radio over the years have been many and varied ranging from rag chewing to RTTY. He is currently on RTTY with a homebrew display system that will also copy and display CW at speeds up to 150 wpm. He is also active on 450 with fast scan TV and on the HF bands with high speed (60 to 100 wpm) CW with his video display and keyboard.

Don only became interested in DX about five years ago when he also began developing an interest in the mysteries and powers of the cubical quad antenna. He first began DXing on 40/80 with simple wire antennas, but soon found himself on the low end of 20 with a multi-element triband

beam. It was while he was sitting in a pileup one day calling and calling without results that he realized there had to be a better way.

He had heard that quads made good DX antennas, particularly at lower heights, so he decided to try one. Don soon replaced the multi-element triband beam with a two-element quad, and he says the difference was immediately apparent. Figuring that if a little was good, then more was better, the two-element quad was soon replaced with a four-element model. After a period of testing that included a four-frame expanded quad on 145 MHz, the four-element quad was replaced with the present six-element "Cowtown Monster Quad" shown in the photo. Don has written several articles describing this "Monster Quad," and many copies have been built and erected. Don not only has used this antenna to work some 300 countries, but also has obtained Single Band WAZ with it, as well.

Don also has several interests outside of amateur radio. His latest interest, and one that has taken up most of his time, is experimental aircraft and aerobatic flying. He says two meters is great from 10,000 feet, but the wind noise in an open cockpit is terrible.

Other interests include microprocessors (he is building a microcomputer) and playing the stock market. The stock market is the only form of gambling that is legal in Texas.

Don has held an amateur Extra Class license for several years as well as a Second Class Radio Telephone license which is required in his present employment. He is also single,

which is probably a requirement for his involvement in so many interests.

During his spare time, Don is putting together a magazine article describing the unique elevator system he uses to raise and lower his quad for tuning and adjustments. Look for it in a future issue of your favorite ham publication.

Next time you hear K5DUT on 20, give him a call and ask him to tell you about cubical quad antennas, if you have an hour or so to spare, that is.

NEEDED LISTS

"Needed Lists" are always interesting because you can compare them with what you need and see how you stand. They also show the difference in what is considered "rare DX" in different parts of the world. Caribbean island stations, for instance, are considered very rare DX in Japan, while HS and S2 are considered backyard DX. The following list was compiled by the VE "Canad-X" and shows how things look from a Canadian point of view.

1. 8Z4—Neutral Zone
2. VP8—South Sandwich (see text)
3. Y1—Iraq
4. BY—China
5. 3Y—Bouvet
6. SY—Mt. Athos
7. VS9K—Kamaron
8. Spratly
9. VU—Laccadives
10. XZ—Burma
11. 7J1RL
12. Geyser Reef
13. ZA—Albania
14. Abu-Ail
15. FR7—Juan de Nova
16. 7O—South Yemen
17. A51—Bhutan
18. FB8W—Crozet
19. XU—Cambodia
20. ST0—Southern Sudan
21. VU—Andamans
22. A7—Qatar
23. VK9—Cocos/Keeling
24. VK0—Heard Island

DX NOTEBOOK

South Sandwich—LU3ZY

This one showed during May and was worked by a number of Europeans. LU1DZ has confirmed that it is a legitimate operation and says there will be more to come. A permanent station will be set up in the South Sandwich group sponsored by The Grupo de Argentina Radio Club, which will also handle the QSLs. Watch for this one toward the end of the year.

Dodecanese—SV1JG

If you happened to work this one during the last couple of months, then you snagged a rare Dodecanese contact. If you haven't worked him yet, check 14200 after 1500Z and again after 0400Z. QSL to Box 564, Athens, Greece.

Ecuador—HC5EE

Rick was back in Michigan last August and hoped to be able to pick up some SSTV gear to take back to Ecuador. Check the regular SSTV frequencies to see if he found any.

Southern Sudan—ST0RK

Hans is back in the Southern Sudan and will be there for a couple more years. Beginning November 1st, the ARRL will accept ST0 cards for DXCC credit retroactive to May 7, 1972. ST0RK QSLs to DL7FT.

United Nations Building—4U1UN

This is another one that will be accepted for DXCC credit beginning November 1st. Hans de Henseler is the regular operator and the best time to look for a contact is during the noon lunch hour there in NYC. Max states that for the present time they cannot keep schedules and only those on the staff are allowed to operate the station. QSL to the United Nations Staff Recreation Council, Amateur Radio Club, United Nations, Box 20, New York, New York 10017.

South Georgia—VP8PL

Commercial duties take up most of his operating, but this one can still be found around 14220 in the evenings.

Serrana Bank—KS4

A group of W9s including W9UCW, WA9EYY, K9RA, K1PBW, and HK0BKX plan to activate this one in January. The plan is for a four-day operation. More on this one next month.

Burma—XZ2

Although there hasn't been any legitimate operation out of Burma in quite a while, some are still trying. Tomaz-Piotr Rogowski SP5AUC is reported to be headed there for a job in the Polish embassy. He expects to be there for several years and will be requesting permission to operate. While the chances are slim, he plans to take a transceiver along just in case.

Rwanda—9X5NH

This one is often found on 14265 at 0330Z working a list through DL8OA. He is still trying to fill out his WAS and needs both North and South Dakota. If you need Rwanda for a new one, just mention Dakota and you are sure to get attention.

Franz Josef Land—UK1PAA

It is time for the regular rotation of the crew manning this rare Russian outpost. It is hoped that the new crew will

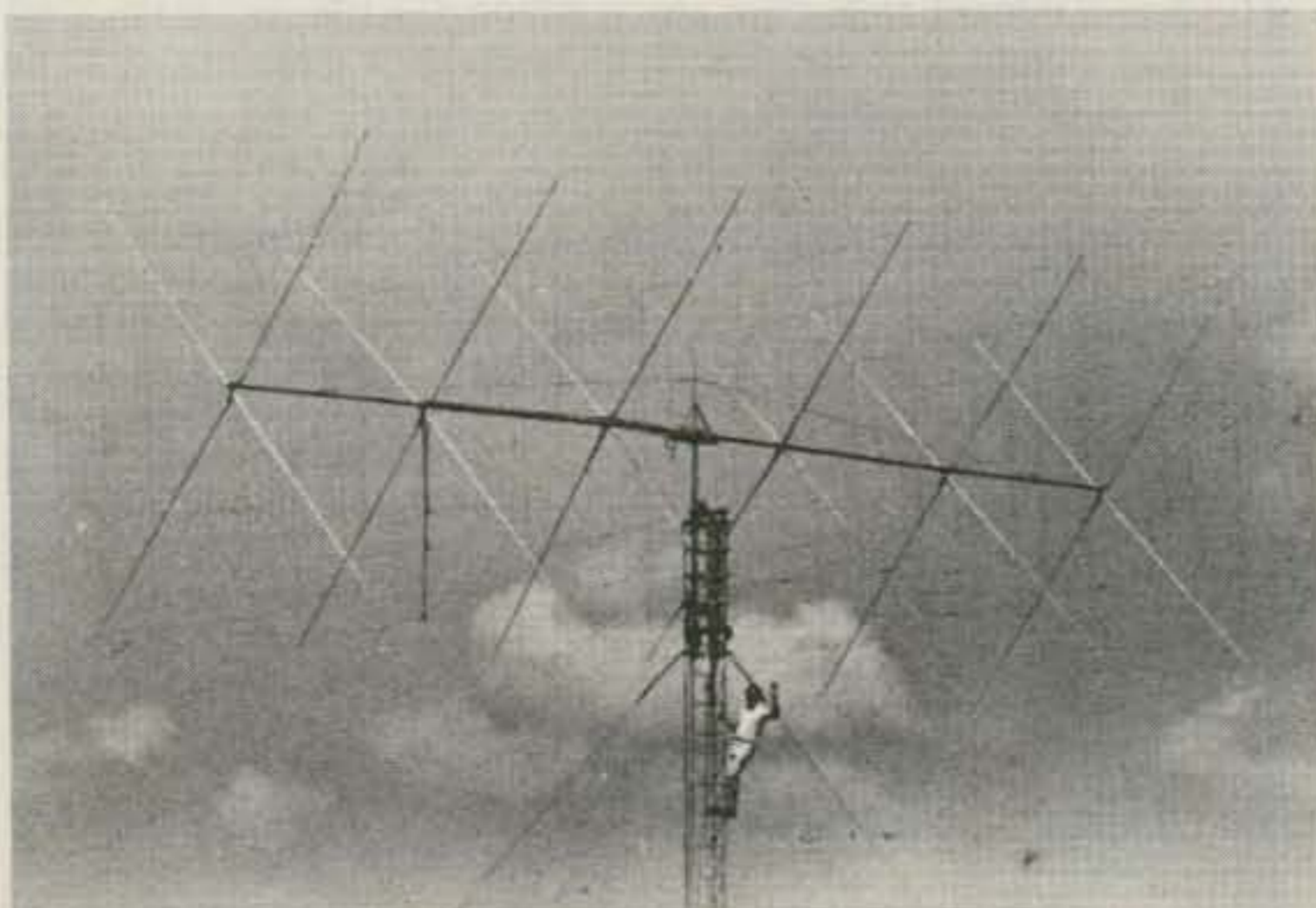

K5DUT and the original "Cowtown Monster Quad." Notice the unique system used for raising and lowering the quad.

Continued on page 30

CURTIS LSI's help you



Speak MORSE

★ 8044; **Keyer-On-A-Chip*** (Replaces 8043). \$14.95

Apr '75 HR, Feb '76 QST, Radio Hdbk '75, Apr Hdbk '77-78

★ 8044-3; IC, PCB, Socket, Manual 24.95

★ 8044-4; Semi-Kit 54.95

★ 8045; Morse **Keyboard-On-A-Chip** IC . . . 59.95

★ 8045-1; IC, PCB, FIFO, Sockets, Manual . . 89.95

★ 8045-2; Semi-Kit 159.95

★ 8046; **Instructokeyer-On-A-Chip** 49.95

★ 8046-1; Semi-Kit 79.95

★ 8047; Message **Memory-On-A-Chip** IC . . 39.95

★ 8047-1; IC, PCB, RAM, Sockets, Manual . . 69.95

(add \$1.75 on above for postage and handling)

EK-430; CMOS **Keyer*** (Feb '76 QST) 124.95

IK-440A; **Instructokeyer*** (Mar '76 QST) 224.95

*now with dash memory as standard

System 4000 Ham Computer (see Jan '78 QST) (write)

Curtis Electro Devices, Inc.

(415) 964-3136

Box 4090, Mountain View, CA 94040



BI-LATERAL

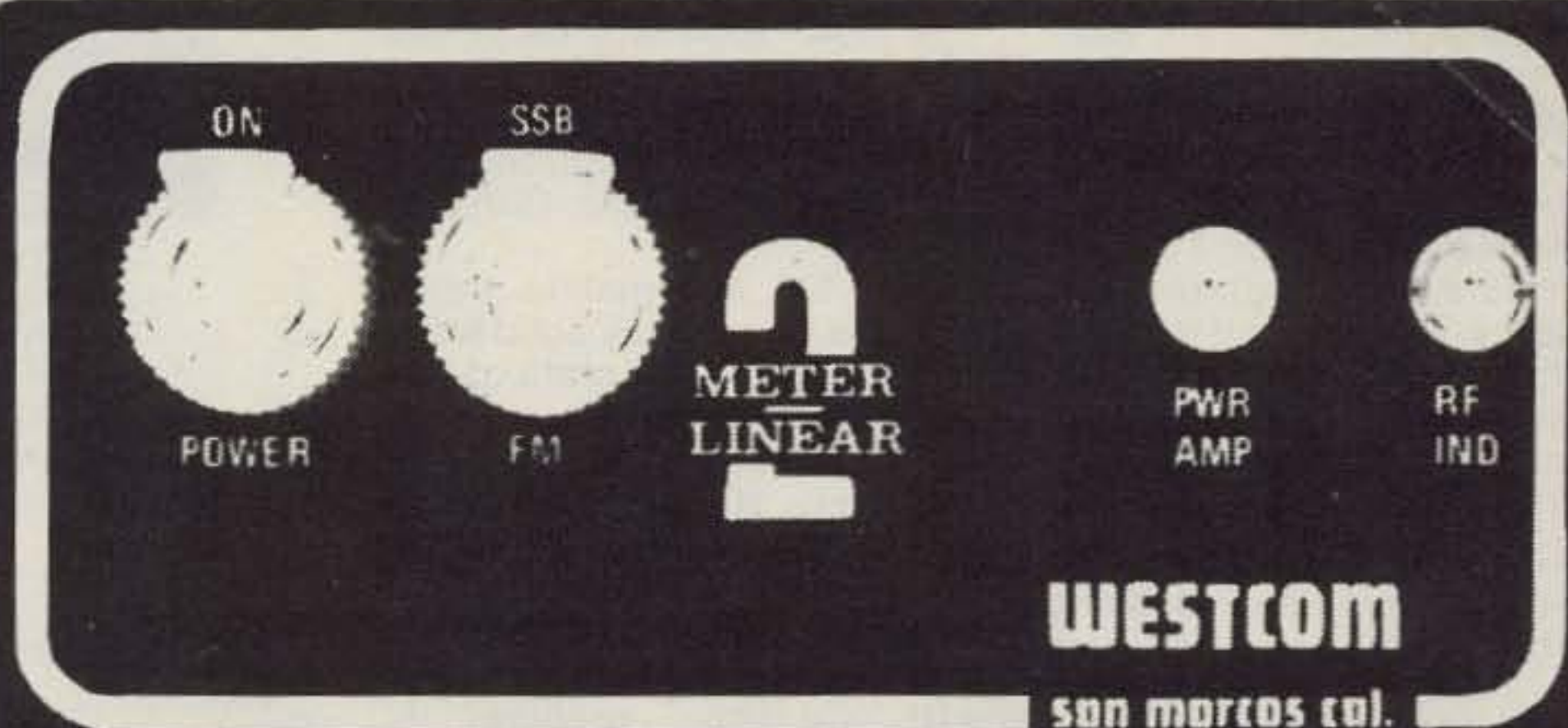

DIGS OUT THE WEAK SIGNAL AND BOOSTS THE POWER !!!

Now Westcom gives you twice the advantage . . . a low noise receiver preamplifier and an output power amplifier, all in the same package! No modification of your transceiver is required since it's all in one high performance, low cost unit. The low noise U310 J-FET yields 12dB gain, 2dB NF, and the receive amp may be used independent of power amp. This unit is a natural for OSCAR uplink or long haul weak signal TROPO work. Available in 90w or 125w.

- An add-on unit, no internal connections or adjustments required to associated equipment
- Standard Amplifiers operate FM, Linear. Models operate all modes: SSB, FM, AM, RTTY, CW.
- Diffused emitter ballasting resistors achieve extreme ruggedness under severe operating conditions
- Withstands 20:1 VSWR under specified operating conditions
- "Microstrip" design provides high stability and optimum performance over wide bandwidth
- Factory adjusted, no tuning required
- Mobile mounting bracket included
- RF sensing T/R switching, adjustable drop-out delay (SSB/CW Mode)
- Remote keying capability
- Thermally coupled biasing
- Reverse Voltage protected
- Detachable fused power connector
- Conservatively rated with oversized heat sink
- Compact: 4 1/8 x 5 1/2 x 2 5/8
- Red LED indicators for monitoring DC and RF
- One year material and workmanship limited warranty

| MODEL NO. (two meter) | INPUT POWER (watts) | MINIMUM OUTPUT W. (at max input) | MAXIMUM CURRENT 13.8 VDC | PRICE |
|---|------------------------|-------------------------------------|-----------------------------|----------|
| FM Mode | | | | |
| 2m 15x70 | 5-15 | 70 | 8 | \$119.95 |
| 2m 15x90 | 5-15 | 90 | 11 | \$134.95 |
| 2m 25x125 | 10-25 | 125 | 18 | \$164.95 |
| All Mode-Linearized | | | | |
| 2m 15x70L | 2-15 | 70 | 8 | \$129.95 |
| 2m 15x90L | 2-15 | 90 | 11 | \$149.95 |
| 2m 25x125L | 5-25 | 125 | 18 | \$179.95 |
| All Mode-Linearized with pre-amp | | | | |
| 2m 15x90BL | 2-15 | 90 | 11 | \$179.95 |
| 2m 25x125BL | 5-25 | 125 | 18 | \$209.95 |

*Linear, AM, CW, FM, SSB, RTTY. Linear models work well with low power transmitters of 2-3 watts to yield 30-40w output. Size: 4 1/8 x 5 1/2 x 2 5/8

If not available from your local dealer, contact:

WESTCOM

ENGINEERING ✓ W17

1320 Grand Avenue
California 92069

San Marcos
(714) 744-0728

JAN CRYSTALS HOLD THE FREQUENCY



- CB
- CB standard
- 2 meter
- Scanners
- Amateur Bands
- General Communication
- Industry
- Marine VHF
- Micro processor crystals

easy to charge



Send 10¢ for our latest catalog
Write or phone for more details
2400 Crystal Drive
Ft. Myers, Florida 33901
all phones (813) 936-2397



New Products

FAST SCAN ATV TRANSMITTER/CONVERTER

PC Electronics has put their ATV modules into a single attractive enclosure for those who are more interested in operating than building. All that is needed with the TC-1 is a Technician or higher-class license, a TV set tuned to channel 2 or 3, a 450 MHz antenna, and a video source such as a closed circuit TV camera, computer video, or tape recorder.

The TC-1 ATV transmitter/converter contains a sensitive tunable 420-450-MHz-to-channel-2-or-3 converter. No modification to your TV set is necessary to receive fast scan ATV, because the same standards as broadcast are used. DX with good antennas up at least 35 feet and 10 Watts of video is about the same as you get on 2 meter FM simplex with 25 Watts.

The transmitter section runs 10 Watts peak output on either 439.25, 434.0, or other specially ordered ATV frequencies. With this unit, computer alpha-numerics, graphics, and color can be transmitted, as the modulator has a bandwidth of 8 MHz. Play Pong, Star Trek, etc., over the air. Talk back on two meter FM. Also included is 4.5 MHz subcarrier sound with enough gain and compression to allow walking around the shack, camera in hand, with the microphone up to 25 feet away.

For the answers to any ATV questions or for their catalog of modules for do-it-yourselfers and cameras, send an SASE to PC Electronics, 2522 Paxson, Arcadia CA 91006.

NEW SSB MOBILE TRANSCEIVER FROM SWAN

A new 100-Watt minimum PEP single sideband mobile transceiver has been introduced by Swan Electronics, a subsidiary of Cubic Corporation.

The 100 MX mobile transceiver is completely solid state and incorporates state-of-the-art design and styling.

It features a highly reliable, extremely stable permeability tuned oscillator (PTO) with 1 kHz readout resolution, built-in noise blanker and VOX, semi-break-in continuous wave (CW) with sidetone, receiver incremental tuning (RIT) control, and 25-kHz built-in calibrator and preselector for transmit and receive.

Weighing 13 pounds, the 100 MX mobile transceiver measures only 3.75" H x 11.75" D x 9.75" W.

Modes of operation include USB, LSB, and CW.

Frequency ranges for the new unit are: 80 meters (3.5-4.0 MHz), 40 meters (7.0-7.5 MHz), 20 meters (14.0-14.5 MHz), 15 meters (21.0-21.5 MHz), and 10 meters (28.5-29.0 MHz).

Extended frequency coverage in 500-kHz segments of the 10 meter band (28.0-28.5; 29.0-29.5; 29.5-30.0) is achieved by replacing the standard crystal with an optional crystal for the desired segment. No realignment is required.

The receiver sensitivity is better than 0.35 μ V at 50 Ohms for 10 dB signal plus noise-to-noise ratio for all bands. Audio output is four Watts into a four-Ohm load. Audio bandpass



Swan's 100 MX.

response is 300 to 3000 Hertz.

Provisions for an external speaker or headphones are on the rear panel, and a gimbal-type mobile mount is included as standard equipment.

For additional information, contact: Chuck Inskip, director of marketing, Swan Electronics, 305 Airport Road, Oceanside CA 92054; telephone: (714)-757-7525.

operating range.

Complete and easy-to-follow illustrated assembly instructions are included, as well as an owner's manual describing operation of the probe.

For further information, contact Continental Specialties Corporation, 70 Fulton Terrace, New Haven CT 06509; (203)-624-3103.

CSC INTRODUCES \$19.95 LOGIC PROBE KIT

Continental Specialties Corporation is setting a lot of troubleshooting trends with the sleek, versatile logic probes already part of The Logical Force™ line of digital troubleshooting hardware. The newest of these logic probes is the LPK-1 Logic Probe Kit.

Features of this new probe include separately-driven high, low, and pulse indicator LEDs; .3 megohm input impedance; input overload protection; pulse stretching and indication for pulses as fast as 300 nanoseconds; reverse voltage protection; and a 0°-50° C.

NEW DIGITAL AC AMMETER IS FIELD-SCALABLE

The new Slimline ac ammeter can be easily field-calibrated to operate with any standard 5-Ampere secondary current transformer. The wide-range coarse and fine calibration controls will handle all standard transformer ratios, so these meters can be kept on the shelf and calibrated when they are put into service.

A built-in calibration source eliminates the need for external calibration standards or voltage sources. The installer simply adjusts the unit for the ratio of the current transformer.

Continued on page 227



PC Electronics' new ATV transmitter/converter.

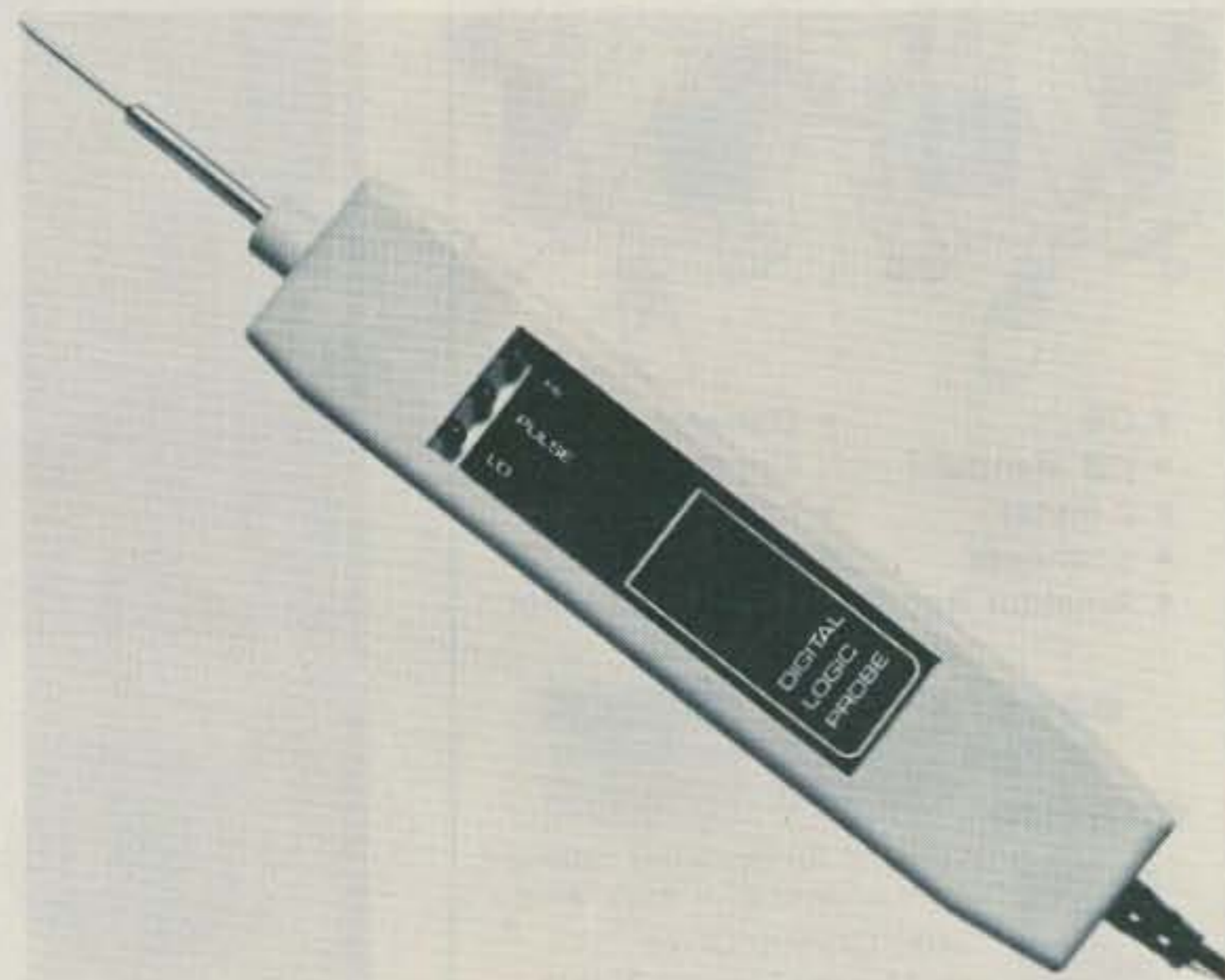

CSC's LPK-1 logic probe.

DSI COMMUNICATIONS SERIES

1.3GHz — 1GHz — 700MHz



MODEL C1000 10Hz to 1GHz

\$399⁹⁵

- AUTO ZERO BLANKING
- AUTO DECIMAL POINT

Accuracy . . . that's the operational key to this rugged advanced design Model C1000 1GHz frequency counter . . . a significant achievement from DSI. That's because you get . . . **.1 PPM** 0° to 40°C proportional oven time base . . . Built in 25DB preamplifier with a 60DB adjustable attenuator . . . x10 & x100 audio scaler which yields .01 Hz resolution from 10Hz to 10KHz equivalent to 10 sec. & 100 sec. Gate Time . . . Selectable .1 & 1 sec. time base and 50 ohms or 1 meg ohm input impedance . . . Built-in battery charging circuit with a Rapid or Trickle Charge Selector . . . Color keyed high quality push button operation . . . All combined in a rugged black anodized (.125" thick) aluminum cabinet. The model C-1000 reflects DSI's on going dedication to excellence in instrumentation for the professional service technician, engineer, or the communication industry.

MODEL C700 50Hz to 700MHz

\$299⁹⁵

- AUTO ZERO BLANKING
- AUTO DECIMAL POINT

ALL NEW! All UNPARALLELED DSI QUALITY! The model C 700 700 MHz frequency counter features . . . **.2 PPM** 0° to 40° C proportional oven time base . . . 25db preamplifier with a 60db adjustable attenuator. Built in battery charger with a rapid or trickle charge selector . . . Combined in a rugged (.125" thick) aluminum cabinet makes the C700 ideal for the communication industry and professional service technician.

3600A OWNERS: Up date your 3600A frequency counter to a C 700 includes, new back board, **.2PPM** proportional oven, 25db preamplifier, rugged .125" thick aluminum cabinet, order 3600A-700. Unit must be returned to DSI factory for modification.

DSI — GUARANTEED SPECIFICATIONS — FACTORY ASSEMBLED — MADE IN USA

| Model | Frequency Range | Proportional Oven Accuracy Over Temperature | 50Hz To 75MHz | 75MHz To 500MHz | 500MHz To 1GHz | Number Of Digits | Size Of Digits | Power Requirements | Size |
|-------|-----------------|---|---------------|-----------------|----------------|------------------|----------------|----------------------------|-------------------|
| C700 | 50Hz to 700MHz | .2PPM 0° to 40°C | 50MV | 10MV | NA | 8 | .5 Inch | 115 VAC-BATT 8 to 15VDC | 3"H x 8"W x 6"D |
| C1000 | 10Hz to 1GHz | .1PPM 0° to 40°C | 20MV | 1MV | >50MV | 9 | .5 Inch | 115VAC-BATT 8 to 15VDC | 4"H x 10"W x 7½"D |

— All Units Are Factory Assembled, Tested And Carry A Full 5 Year Limited Warranty —

- NO EXTRA COSTS •

FREE Shipping anywhere in U.S.A. & Canada. All other countries, Add 10%.

Strongest warranty in the counter field.
Satisfaction Guaranteed.

See Your Dealer
OR

Call Toll Free (800) 854-2049 **DSI Instruments, Inc.**
California Residents, Call Collect (714) 565-8402

VISA • MC • AMERICAN EXPRESS • CHECK • MONEY ORDER • COD
7914 Ronson Road, No. G, San Diego, CA 92111

| | |
|--|-----------------|
| Model C 700 | \$299.95 |
| 3600A-700 Factory update (3600A only) Includes Labor & Re-Calibration | \$124.95 |
| Model C 1000 | \$399.95 |
| Opt. 01 1.3 GHZ (C1000 only) | \$ 99.95 |
| Opt. 02 .05 PPM 10MHz Double Oven 0° to 50°C Time Base (C1000 only) | \$129.95 |
| Opt. 03 20 Hr. rechargeable Battery Pack | \$ 29.95 |
| Ant. 210 Telescopic Ant./BNC Adapter | \$ 9.95 |

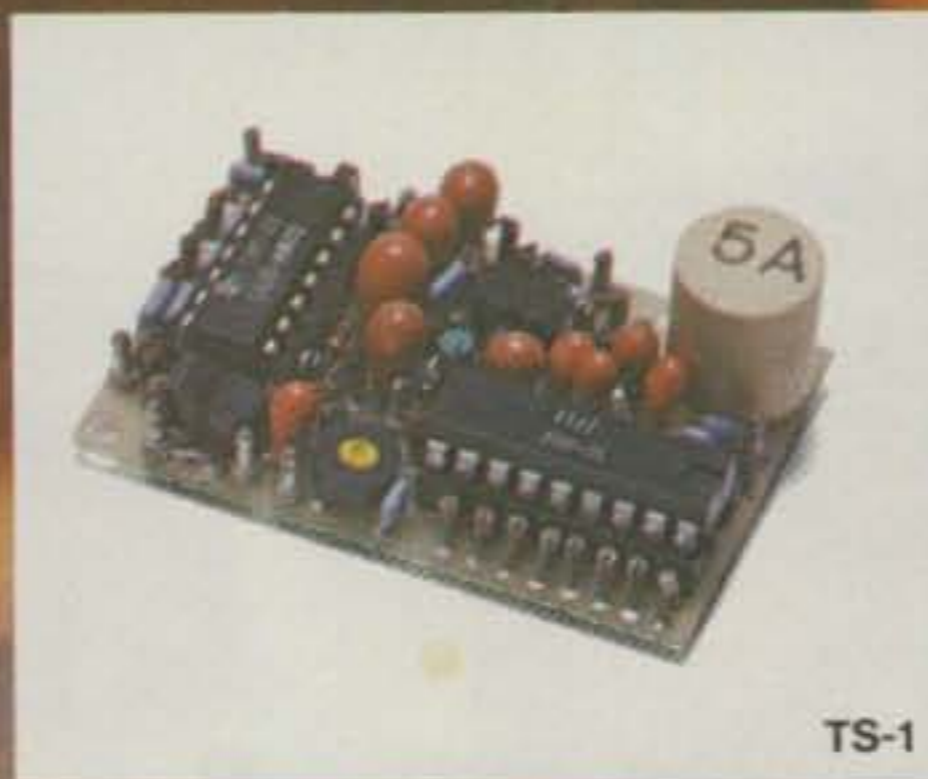

TS-1



TS-1JR

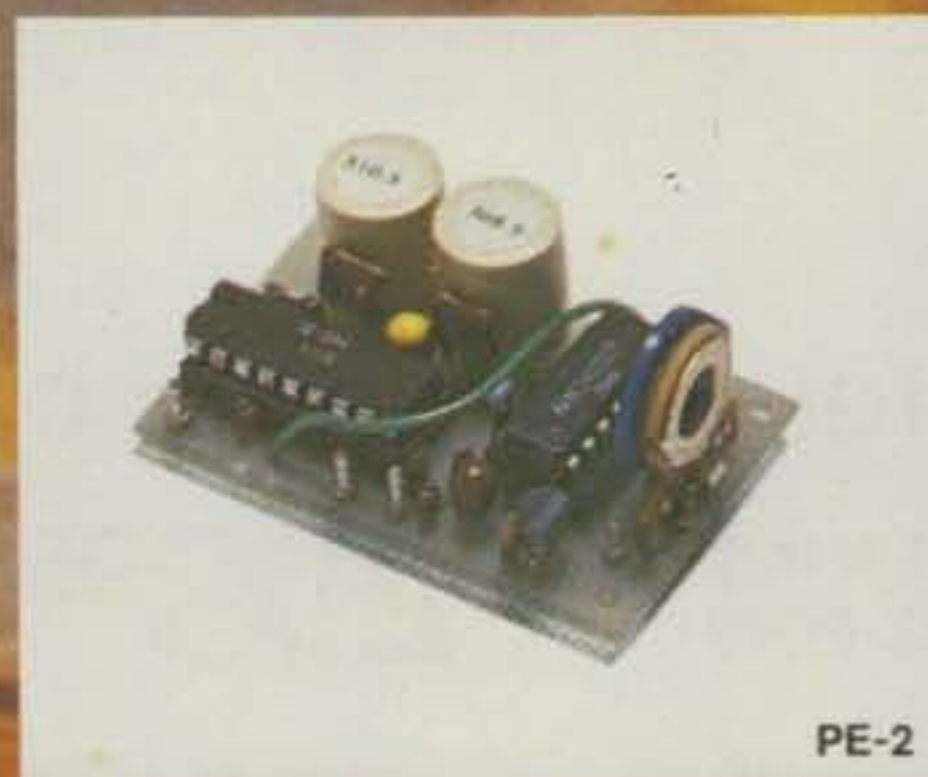

PE-2



SD-1

THE DAWNING

The age of tone control has come to Amateur Radio. What better way to utilize our ever diminishing resource of frequency spectrum? Sub-audible tone control allows several repeaters to share the same channel with minimal geographic separation. It allows protection from intermod and interference for repeaters, remote base stations, and autopatches. It even allows silent monitoring of our crowded simplex channels.

We make the most reliable and complete line of tone products available. All are totally immune to RF, use plug-in, field replaceable, frequency determining elements for low cost and the most accurate and stable frequency control possible. Our impeccable 1 day delivery is unmatched in the industry and you are protected by a full 1 year warranty when our products are returned to the factory for repair. Isn't it time for you to get into the New Age of tone control?



ME-3



TE-8

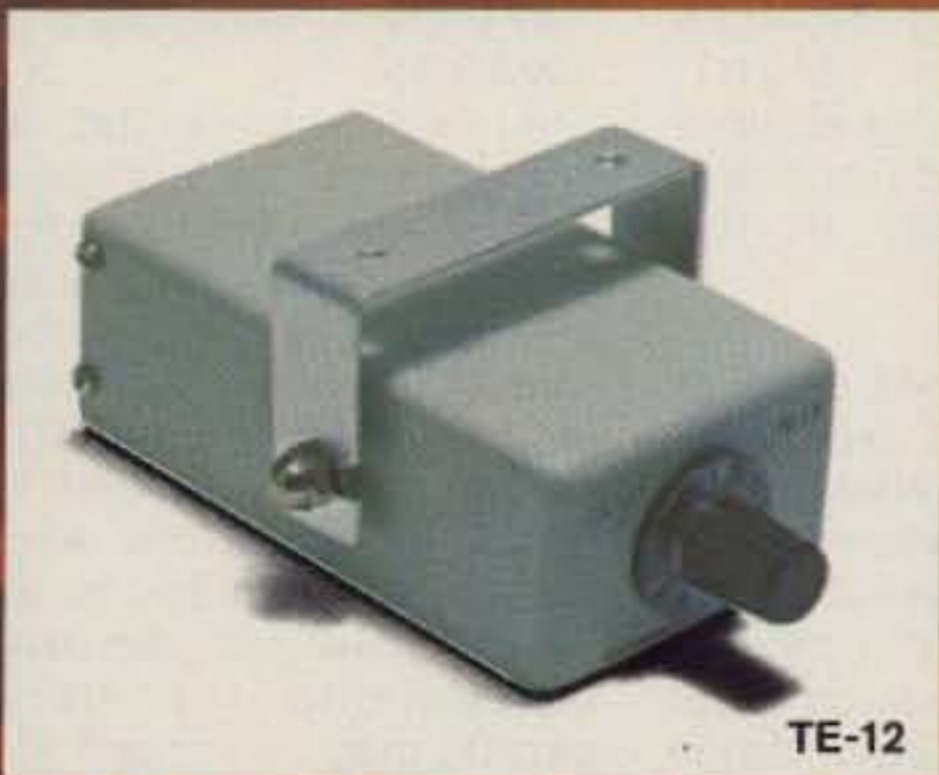

TE-12

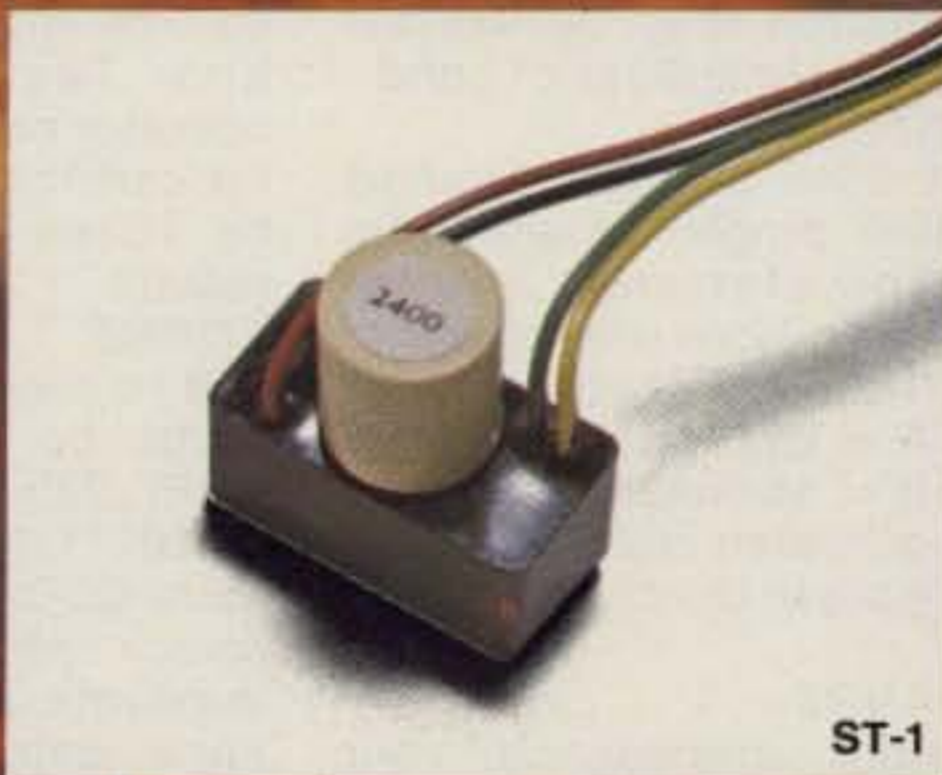

ST-1

OF A NEW AGE.

TS-1 Sub-Audible Encoder-Decoder • Microminiature in size, 1.25" x 2.0" x .65" • Encodes and decodes simultaneously • **\$59.95** complete with K-1 element.

TS-1JR Sub-Audible Encoder-Decoder • Microminiature version of the TS-1 measuring just 1.0" x 1.25" x .65", for hand-held units • **\$79.95** complete with K-1 element.

ME-3 Sub-Audible Encoder • Microminiature in size, measures .45" x 1.1" x .6" • Instant start-up • **\$29.95** complete with K-1 element.

TE-8 Eight-Tone Sub-Audible Encoder • Measures 2.6" x 2.0" x .7" • Frequency selection made by either a pull to ground or to supply • **\$69.95** with 8 K-1 elements.

PE-2 Two-Tone Sequential Encoder for paging • Two call unit • Measures 1.25" x 2.0" x .65" • **\$49.95** with 2K-2 elements.

SD-1 Two-Tone Sequential Decoder • Frequency range is 268.5 - 2109.4 Hz • Measures 1.2" x 1.67" x .65" • Momentary output for horn relay, latched output for call light and receiver muting built-in • **\$59.95** with 2 K-2 elements.

TE-12 Twelve-Tone Sub-Audible or Burst-Tone Encoder • Frequency range is 67.0 - 263.0 Hz sub-audible or 1650 - 4200 Hz burst-tone • Measures 4.25" x 2.5" x 1.5" • **\$79.95** with 12 K-1 elements.

ST-1 Burst-Tone Encoder • Measures .95" x .5" x .5" plus K-1 measurements • Frequency range is 1650 - 4200 Hz • **\$29.95** with K-1 element.



COMMUNICATIONS SPECIALISTS

426 West Taft Avenue, Orange, CA 92667

(800) 854-0547, California residents use: (714) 998-3021



Editor:
Robert Baker WB2GFE
15 Windsor Dr.
Atco NJ 08004

CONTESTS

MARC SILVER JUBILEE CELEBRATION

Starts: 0000 GMT November 4
Ends: 2400 GMT November 5
Sponsored by the Mountain Amateur Radio Club, Cumberland MD, to commemorate the club's Silver Jubilee. Stations may be worked only once regardless of band or mode. Repeater contacts are not valid.

EXCHANGE:

RS(T) and state or country.

FREQUENCIES:

3540, 3910, 7040, 7240, 14040, 14295, 21110, 21360, 28110, 28600.

AWARDS:

A special multi-colored QSL card for contact with W3YMW, the club station. Silver Jubilee Certificates will be awarded to any amateur who contacts five members of MARC. Mailing deadline is Dec. 31. Include a large SASE for QSL cards or certificates. Entries should be mailed to: John P. Fanelli, Jr. WA3WSW, 609 Piedmont Ave., Cumberland MD 21502.

ARRL SWEEPSTAKES

CW

Starts: 2100 GMT Saturday, November 4

Ends: 0300 GMT Sunday, November 5

Phone

Starts: 2100 GMT Saturday, November 18

Ends: 0300 GMT Sunday, November 19

Sweepstakes is sponsored by the ARRL and is open to all amateurs in the US, US possessions, and Canada. No more than 24 hours of operation are permitted during the 30-hour contest period. Time spent listening counts as operating time and off periods may not be less than 15 minutes. Times on and off as well as QSO times must be entered in the log. Each station may be worked only once, regardless of band.

CLASSES:

All entries will be classified as either single- or multiple-operator stations. Single-operator stations will be further classified by input power: Class A = 200 Watts dc or less, Class B = above 200 Watts. All ARRL-affiliated clubs may also participate in the club competition.

EXCHANGE:

Number, precedence, your call, CK, and ARRL section. Send A for precedence if power

is 200 Watts dc or less, otherwise send B. For CK, send the last 2 digits of the year you were first licensed.

SCORING:

Score 2 points for each completed QSO. Final score is sum of QSO points multiplied by the total number of ARRL sections plus VE8 (max. 75).

AWARDS:

Certificates will be awarded to the highest-scoring Class A entry and the highest-scoring Class B entry in each section, provided there are at least 3 single-operator entries or the score is 10,000 points or more. Certificates will also be awarded for high-scoring Novices and Technicians. Multi-operator entries are not eligible for certificate awards and will be listed separately in the results.

FORMS:

It is suggested that contest forms be obtained from the ARRL, 225 Main St., Newington CT 06111. All entries with 200 or more QSOs must have a cross-check sheet to check for duplicate QSOs. Each log must show date, QSO time, times on/off, exchanges sent and received, band and mode.

Note: These rules were taken from last year's contest.

INTERNATIONAL OK DX CONTEST

Contest Period:

0000 to 2400 GMT

Saturday, November 11

The participating stations work stations of other countries according to the official DXCC Countries List. Contacts between stations of the same country count only as a multiplier, but 0 points. All bands from 160 to 10 meters, CW and phone may be used. (OK stations are only licensed to operate CW on 160 meters.) Cross-band as well as cross-mode contacts are not valid.

EXCHANGE:

Exchanges consist of a 4- or 5-digit number indicating the RS(T) and ITU zone.

SCORING:

A station may be worked once only on each band. A complete exchange of code counts one point, but three points are awarded for a complete con-

tact with a Czechoslovak station (except as noted above for stations in the same country). The multiplier is the sum of the ITU zones from all bands. Final score is then the sum total of contact points times the multiplier.

CATEGORIES:

A — Single operator, all bands; B — single operator, one band; C — multi-operator, all bands. Any station operated by a single person obtaining assistance, such as in keeping the log, monitoring other bands, tuning the transmitter, etc., is considered as a multi-operator station. Club stations may work in category C only.

AWARDS:

A performance list of participants will be worked out by the contest committee for each country. A certificate will be awarded to the top-scoring operators in each country and each category. The "100 OK" award may be issued to stations for contacts with 100 Czechoslovak stations, and the "S6S" award (and/or endorsements for individual bands) may be issued to a station for the contacts with all continents. Both awards will be issued upon a written application in the log. No QSL cards are required for either award.

LOGS:

A separate log must be kept for each band and must contain date and time in GMT, station worked, exchange sent and received, points (0, 1 or 3), and ITU zone (with the first QSO for that zone only). The log must contain in its heading the category of the station (A, B, or C), name and callsign, address, and band or bands. Also, indicate the sum of contacts, QSO points, multipliers, and the total score of the participating station. Each log must be accompanied by the following declaration:

I hereby state that my station was operated in accordance with the rules of the contest as well as all regulations established for amateur radio in my country, and that my report is correct and true to the best of my belief.

Logs must be sent to: The Central Radio Club, Post Box

CALENDAR

| | |
|-------------|---|
| Nov 1 | YL/AP Phone |
| Nov 3-4 | Trilliums QSO Party |
| Nov 4-5 | ARRL Sweepstakes — CW RSGB 7 MHz CW MARC Silver Jubilee Celebration |
| Nov 11 | OK DX Contest |
| Nov 11-12 | IPA Contest Delaware QSO Party Missouri QSO Party |
| Nov 18-19 | ARRL Sweepstakes — Phone All Austria Contest Wellesley ARS Anniversary QSO Party |
| * Nov 25-26 | CQ Worldwide DX — CW |
| Dec 2-3 | ARRL 160 Meter Contest Connecticut QSO Party International Island DX Contest TOPS CW Contest VU2 DX Contest |
| Dec 3 | Flatland Farmer 10-X QSO Party |
| Dec 9-10 | ARRL 10 Meter Contest |
| Dec 16-17 | SOWP Christmas QSO Party |

* = described in last issue

A QUICK REMINDER !

Don't forget to send all 1979 contest information *directly to me* as soon as possible for announcement in this column. I should have the information at least three months prior to the event to ensure insertion in the calendar. Also, how about sending abbreviated results or any award information you would like published—as space permits.

HAM OF THE YEAR AWARD

Nominations for the award are due in to 73 Magazine by November 15, 1978, and are to be 500 words or less, giving the details of the reason for the nomination. See editorial in the September 73 for details.

The parameters of the Palomar PTR-130k are the outer perimeters of logic technology.

Never before has any transceiver approached the capabilities of the Palomar PTR-130k!

It's the first completely multi-functional transceiver ever made available to the public!

The Palomar PTR-130k is a miniaturized mobile transceiver

capable of operating in 100 cycle resolution from 100 KHz to 30 MHz in all modes of transmission and reception.

Instant frequency selection is available with the touch of a finger.

The Palomar PTR-130k.

technology is pure space age . . . the price is strictly down-to-earth.

Send for our full color brochure to:

Palomar Electronics Corporation
665 Opper Street

Escondido, CA 92025

Telephone: (714) 746-2666



TECHNOLOGY AT THE SPEED OF SOUND

DC



POWER!

Rugged, High Quality DC Power

SPECIAL FEATURES

- Solid state electronically regulated
- Fold-back current limiting protects power supply from excessive current and continuous shorted output
- Crowbar over voltage protection on all models
- Three conductor power cord
- One year warranty
- Made in U.S.A.
- Maintain regulation and low ripple at low line input voltage and rated load
- Heavy duty heat sink
- Chassis mount fuse

PERFORMANCE SPECIFICATIONS

Input voltage: 105 - 125 VAC

Output voltage: 13.8 VDC \pm 0.05 volts

Ripple: less than 5 mV peak-to-peak worst case (full load and low line)

Regulation: \pm .05 volts no load to full load and low line to high line

Shipping Weights
RS-7A 8# RS-20A 22#
RS-12A 17# RS-35A 33#

Technical data and specifications subject to change without notice.

FOUR POWERFUL MODELS

RS-7A

5 A Continuous
7 A Intermittant
Recommended for
50 W amps and 30
watt transmitters

\$49.95

RS-20A

16 A Continuous
20 A Intermittant
Recommended for
125 W amps

\$94.95

RS-12A

9 A Continuous
12 A Intermittant
Recommended for
90 W amps and 50
W transmitters

\$72.95

RS-35A

25 A Continuous
35 A Intermittant
Recommended for
250 W amps

\$136.95

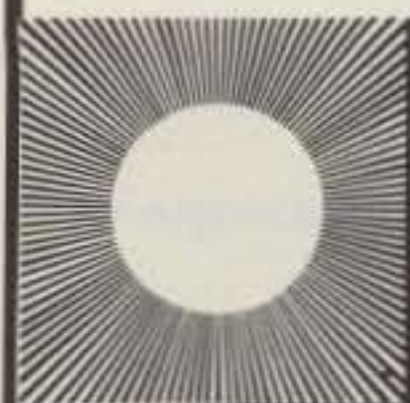

WESTCOM

ENGINEERING W17

1320 Grand Avenue
California 92069

San Marcos
(714) 744-0728

69, Prague 1, Czechoslovakia — postmarked no later than December 31. A list and map of ITU zones is available for 2 IRCs from the same address.

DELAWARE QSO PARTY
Saturday, November 11
 0001 to 0600 and
 1600 to 2359 GMT
Sunday, November 12
 0001 to 0600 and
 1600 to 2359 GMT

Sponsored by the Delaware ARC, the contest is open to all amateurs. Stations may be worked once per band per mode for QSO points.

EXCHANGE:

QSO number, RS(T), and QTH-county for DEL; ARRL section or country for others.

SCORING:

DEL stations score one point per phone QSO, 2 points per CW QSO, and multiply total by number of ARRL sections and countries worked. Others score 5 points per DEL QSO and multiply by the number of coun-

ties worked per mode per band (counties = Kent, New Castle, and Sussex).

FREQUENCIES:

CW — 3560, 7060, 14060, 21060, 28160.

Phone — 3900, 7275, 14325, 21425, 28650.

Novice — 3710, 7120, 21120, 28160.

ENTRIES AND AWARDS:

Appropriate awards are given to the top scorers and a special certificate is given to all stations working all three Delaware counties if requested. Logs with earliest postmark will determine award winners in event of tie! Mailing deadline is Dec. 15 to: Sandy Cuccia WB3ENF, 7 Sorrel Dr., Wilmington DE 19803. Include an SASE for results or W-DEL certificate.

IPA CONTEST

Saturday, November 11
 0800 to 1000 GMT,
 1400 to 1700 GMT,
 and

1800 to 2000 GMT
Sunday, November 12
 0800 to 1000 GMT,
 1400 to 1700 GMT,
 and
1800 to 2000 GMT

Sponsored by the International Police Association Radio Club — German Section (IPARC), the contest is designed to enable participants to work the Sherlock Holmes Award (SHA). The contest is open to all radio amateurs and SWLs. Members may work anyone; non-members may only work members. General call is "CQ IPA." Cross-band and cross-mode contacts are not allowed. All contacts must be on CW or SSB.

EXCHANGE:

Non-members send RS(T) and serial number. Members send IPA, RS(T), and serial number.

SCORING:

Every completed QSO counts 2 points on 80/40 meters, 4 points on 20/15/10 meters. Stations may be worked once per band. Multiplier is number of IPA countries per amateur band. Final score is QSO points times multiplier. An IPA country is counted for multiplier and QSO only if an IPA station in that country has been worked. Contacts with DXCC countries which are not listed in the IPARC membership list count 1 point but do not count as a multiplier.

FREQUENCIES (as allowed):

SSB — 3650, 7075, 14295, 21295, 28650.

CW — 3575, 7025, 14075, 21075, 28075.

AWARDS AND ENTRIES:

Certificates to winners and three highest scores. Any amateur fulfilling the condi-

tions of the SHA50, SHA100, or SHA200 during the contest may apply with application sheet. Approval of 2 licensed hams is not necessary for contest application. SHA rules, IPARC membership list, SHA application sheet, contest log sheet, and contest score or certificates are available from Vince Gambina WB4QJO, 7606 Kingsbury Road, Alexandria VA 22310 — include an SASE with 2 stamps or 2 IRCs, please! Contest entries must be postmarked no later than December 31 and sent to: Adolf Vogel DL3SZ, Ritter-von-Eyb-Strasse 2, D-8800 Ansbach, Germany.

MISSOURI QSO PARTY
Starts: 1800 GMT Saturday,
November 11
Ends: 2300 GMT Sunday,
November 12

The 15th annual QSO party is sponsored by the St. Louis Amateur Radio Club in an effort to activate some of the hard-to-get Missouri counties. The same station may be worked once per band and mode. Missouri mobiles will count separately from each different county.

EXCHANGE:

QSO number, RS(T), and QTH-county for MO stations; state, province, or country for others. MO mobiles start with #1 from each county activated.

FREQUENCIES:

3540, 3910, 7040, 7240, 14040, 14270, 21110, 21360, 28110, 28600, 50-50.5.

SCORING:

Score 1 point per QSO; MO stations multiply contact points times number of states, provinces, and countries; others multiply by number of MO counties (115 max.). MO mobiles total separate score

Continued on page 88

THE 73 MAGAZINE 10 METER AWARDS

The return of vigorous solar activity means that 10 meters is once again a band to be reckoned with. Ol' Sol's 11-year cycle of sunspot production is about to hit a peak, with the result that QRP 10 meter DX is possible.

Now's the perfect time to convert that old CB rig to 10 (or buy a brand new one from Bristol or Standard) and join the fun. We've had many articles showing you just how easy a CB-to-10 conversion really is. To give you an added incentive, 73 is offering two nifty Certificates of Achievement for 10 meter channelized communications.

For domestic types, there is the 10-40 Award. This one should be pretty easy—just work 40 of the 50 states. The DX Decade Award goes to DXers who work 10 or more foreign countries with a channelized 10 meter rig. We have endorsement stickers, too—the whole bit.

To give everyone an equal shot at award #1, only contacts made October 1, 1978, or after will be valid.

Well, don't just sit there. Get out your soldering iron, order some crystals, and put that CB rig on 10. This is going to be fun, so don't miss out!

RULES

1) All contacts must be made in the 10 meter amateur band using channelized AM equipment. Both converted Citizens Band equipment and commercially-produced units (such as those available from Bristol Electronics and Standard Communications) may be used.

2) To be eligible for award credit, all contacts must be made October 1, 1978, or after.

3) The 10-40 Award is available to applicants showing proof of contact with stations in at least 40 of the 50 United States. A special endorsement sticker will be available to those working all 50 states.

4) The DX Decade Award is available to applicants showing proof of contact with at least 10 foreign countries. Endorsement stickers will be awarded for 25, 50, 75, and 100 countries.

5) A log of stations worked, with the date, time, and type of equipment used for each contact, must be submitted when applying for each award or endorsement.

6) Each application for an award or endorsement must be accompanied by a signed statement that all claimed contacts are valid. No QSL cards need be sent, but they must be in the possession of the applicant.

7) To cover costs, a fee of \$5.00 must accompany each application for the 10-40 or DX Decade Award. The fee for endorsement stickers will be \$2.00 each.

8) All award applications should be mailed to: Chuck Stuart N5KC, 5115 Menefee Drive, Dallas TX 75227.

RESULTS

RESULTS OF THE 1ST ANNUAL 7-LAND QSO PARTY, 1978

Top Twenty

- | | |
|------------------|------------------|
| 1. WB7QEL—Wash. | 11. W7TYN—Mont. |
| 2. W7GHT—Idaho | 12. VE3KK—Ont. |
| 3. W7JYW—Mont. | 13. WB7STO—Mont. |
| 4. WB7EZO—Ariz. | 14. WB0JYF—Iowa |
| 5. W7YS—Ariz. | 15. W7IEU—Wash. |
| 6. N7SU—Idaho | 16. WB7WKP—Wash. |
| 7. W7WMO—Wash. | 17. WB7BFK—Wash. |
| 8. K7MM—Idaho | 18. W3ARK—Penn. |
| 9. W7HI—Nev. | 19. JR1UCQ—Japan |
| 10. WA7NXL—Ariz. | 20. WA4LWO—N.C. |

Top CW Entry — W7TYN, Montana

Top SSB Entry — W7YS, Arizona

Top Mixed Entry — WB7QEL, Washington

Highest Score, Worldwide — WB7QEL, Washington

Highest Score, Canada — VE3KK, Ontario

Highest Score, Foreign — JR1UCQ, Japan

CT-50 FREQUENCY COUNTER



**Outstanding
Performance
at an
Incredible
Price**

DESCRIPTION: The CT-50 is a versatile and precision frequency counter which will measure frequencies to 60 MHz and up to 600 MHz with the CT-600 option. Large Scale Integration, CMOS circuitry and solid state display technology have enabled this counter to match performance found in units selling for over three times as much. Low power consumption (typically 300-400 ma) makes the CT-50 ideal for portable battery operation. Features of the CT-50 include: large 8 digit LED display, RF shielded all metal case, easy pushbutton operation, automatic decimal point, fully socketed IC chips and input protection to 50 volts to insure against accidental burnout or overload. And, the best feature of all is the easy assembly. Clear, step by step instructions guide you to a finished unit you can rely on. Use the order blank below or call us direct and order yours today!

SPECIFICATIONS:

- Frequency range: 5 Hz to 65 MHz, 600 MHz with CT-600
- Resolution: 10 Hz @ 0.1 sec gate, 1 Hz @ 1 sec gate
- Readout: 8 digit, 0.4" high LED, direct readout in MHz
- Accuracy: adjustable to 0.5 ppm
- Stability: 2.0 ppm over 10° to 40° C, temperature compensated
- Input: BNC, 1 megohm/20 pf direct, 50 ohm with CT-600
- Overload: 50VAC maximum, all modes
- Sensitivity: less than 25 mv to 65 MHz, 50-150 mv to 600 MHz
- Power: 110 VAC 5 Watts or 12 VDC @ 400 ma
- Size: 6" x 4" x 2", high quality aluminum case, 2 lbs
- ICS: 13 units, all socketed
- CT-600: 600 MHz prescaler option, fits inside CT-50
- CB-1: Color burst adapter, use with color TV for extreme accuracy and stability, typically 0.001 ppm

OPTIONS:

CB-1 option: The CT-50 time base may be locked to an external frequency standard. The television networks maintain extremely accurate atomic based frequency standards to maintain color tint on TV programs. These standards are typically accurate to one part in 10 to the 12. By locking the CT-50 to one of these network standards, we are able to get super accuracy. The CB-1 adapter interfaces a standard color TV receiver to the CT-50 so that one can take advantage of the TV network frequency standards. The CB-1 requires connection to a color television for operation.

CT-600 option: The CT-600 prescaler option enables the CT-50 counter to measure frequencies as high as 600 MHz with sensitivity in the 20 to 150 mv range, depending upon frequency. Typical sensitivity at 150 MHz is 25 mv. The CT-600 mounts on the same PC board as the CT-50, no extra boxes or PC boards are required. The scaler utilizes a state of the art ECL IC chip and two transistor pre-amplifier, thus eliminating the need for external pre-amp devices.



| | |
|--|---------|
| CT-50, 60 MHz Counter Kit | \$89.95 |
| CT-50 WT, 60 MHz counter, wired, tested | 159.95 |
| CT-600, 600 MHz prescaler option for CT-50, add | 29.95 |

ACCESSORIES

| | |
|--|---------|
| DC probe, direct input, general purpose type | \$12.95 |
| High impedance probe, does not load circuit | 15.95 |
| Low pass probe, used when measuring audio | 15.95 |
| High pass probe, reduces low freq pickup | 15.95 |
| VHF flexible rubber antenna, BNC connector | 12.95 |
| Color burst adapter, for calibration, high accuracy typically 0,001 ppm accuracy, stability | 14.95 |

Ramsey Electronics
Box 4072 716-271-6487
Rochester, NY 14610 R8



78

| Quantity | Description | Price |
|----------------------------------|-------------------------------|--------|
| | | |
| | | |
| | | |
| | Shipping, handling, insurance | \$5.00 |
| | N.Y. state residents, add tax | |
| | Total | |
| Name _____ | | |
| Address _____ | | |
| City _____ State _____ Zip _____ | | |

ramsey electronics

Box 4072 Rochester NY 14610 (716) 271-6487

RTTY Loop

from page 16

onstrates a rather elegant solution to the problem of an "oddball" bandwidth. As stated above, the original center frequency is near 1500 Hz. This must be increased to around 2200 Hz if "standard"

RTTY tones are to be used. Kenwood uses a crystal bfo in the R599, with each crystal series resonated by a 22 pF capacitor and trimmed by a parallel trimmer. Recalling that the same vfo is used in both the transmitter and receiver, it stands to reason that some technique

must be used to offset reception on CW to produce a side-tone. What they do is short out that series capacitor! That lowers the frequency of the crystal by about 700 Hz (nice number) and makes for a nice tone in the ears. What's good for the goose, as the saying goes, and the LSB crystal can be similarly attacked. A simple SPST switch, connected to short out the series capacitor on the LSB bfo crystal, will

lower it by about 700 Hz and change the center frequency to 2200 Hz (sound familiar?). Like I said, elegant. Flip the switch open, and you're back in LSB. Take it out when you sell, and who's the wiser? They should all be that simple.

Test equipment and other goodies are on tap for the future, with more reader input and writer output. Maybe more microprocessor stuff, too; who knows?

Looking West

from page 18

headed the Mt. Wilson Repeater Association's "Jammer Hunting Effort" and is an expert T-hunter in his own right, was one of the first people to successfully build one of these units, debug it, and put it into operation. He is very excited about the way the Doppler scan system performs (in relation to more traditional T-hunting methods). In cases of unexpected interference, such a unit can be a real blessing since it does not lend itself to removal and reinstallation and therefore is usually left installed in a vehicle ready for operation. Also, since its direction readout is automatic, even "short-term" malicious interference, such as an obscenity or two during someone else's QSO, can be T-hunted with accuracy. Trying to T-hunt such would be difficult at best (and impossible in most cases) using the normal beam or loop technique. With the Doppler scan you merely note your indicator panel and the direction of your vehicle versus true (or magnetic) north, and compute the direction in your head. Readings are continuous, so you get position plots as you drive along. It's then a matter of plotting a number of "readings" to get a fairly accurate area fix.

This leads us to one very im-

portant question: "What do you do with him when you find him?" Let us set up a hypothetical case. "WR whatever" has been harassed for some time by someone who insists on wiping out as many stations as he can cover up with his unidentified carrier. The users have been instructed to ignore the interference, but as users will, whenever the interference starts, so do the discussions of it on the repeater—thus adding more fuel to the fire and inflating our jammer's ego. Finally, after months of work, the interference source is T-hunted down and positively identified. What next? Well, this is a hypothetical case, remember. So, let's assume that the nearest FCC office has been contacted and given the information. Some time elapses and there has been no action (as often has been reported to me by amateurs from various parts of the country). Remember, the FCC is a very busy bureaucratic organization with little funding. Amateur radio is getting less and less important to them as time goes on. They operate on a basis of priorities, and while amateur radio is very important to us, I suspect that it's kind of low on their list. So, in desperation, other government agencies are contacted—but none can or will help. Now, to complicate matters, our source of interference realizes that he

has been discovered, so he blatantly identifies exactly who and where he is and dares anyone to stop him from jamming. Now, that's as extreme a situation as can possibly develop. The jamming of "WR whatever" continues, though the source, unfortunately an amateur himself, is well known to all. Attempts have been made by the repeater's owner and other amateurs to "reason" with our pet menace—all to no avail. For some reason he hates "WR whatever" and is intent on driving it off the air. If you were facing such a situation, how would you handle it?

I am ending this discussion at this point and posing the above question to you. Without resorting to acts of violence, how would you resolve this situation? Next month I will present my view, and in months to come we will devote space to ideas which you furnish.

THE WALTONS AND AMATEUR RADIO

I was surprised the other evening when I picked up the mail for SCRA/SMA-144 at the Culver City Post Office. Among the many normal requests for repeater channel pairs and repeater lists was one rather interesting letter. It was from a local educator named Glen Woodmansee. He is the Los Angeles city schoolteacher assigned to educate the three children who play "Jim-Bob," "Erin," and "Elizabeth" on "The Waltons." In real life, that

is. Anyhow, as a result of exposure to the world of amateur radio, these children have developed an interest in getting their licenses. Hence the reason for the letter, which reads as follows:

Gentlemen:

The children on "The Waltons" television show go to school on the studio lot; a teacher is assigned by the L.A. School Board to teach them.

I am their teacher and I try to encourage their interests, although the Los Angeles schools don't have much money for such special school situations. My students have become interested in learning amateur radio in real life after being introduced to it in "The Waltons" scripts.

I have no budget for such projects, and thought perhaps the members of your club might be able to help.

Could your newsletter run the following?

Sincerely,
Glen Woodmansee

"Walton's Mountain School needs your old amateur radio gear. The young people who play the parts of Jim-Bob, Erin, and Elizabeth Walton on 'The Waltons' television show are studying amateur radio in their school on the studio lot, but have no equipment. Your donations to the school, which is administered by the Los Angeles School system, are tax-deductible for the full value of the equipment. Contact their teacher, Glen Woodmansee, at 843-6000, ext. 1403, 1402, or 1567; or write Lorimar Walton School, 4000 Warner Blvd., Burbank CA 91522.

"Also needed: Heathkit's Programmed Instruction Course for the amateur radio license, to borrow for a day. Thanks!"

DX

from page 20

contain some amateurs and that UK1PAA will again be activated.

San Felix—CE0XX

Although permission for this effort by K1MM and N4WW has been received, some thought has been given to avoiding the CQWW DX Contest and sched-

uling the operation for later in the year. If CE0XX doesn't appear during the contest, then the dates will have been moved back a bit.

Comoro Islands—D68AD

Robin reports that he now has 160 meter equipment and is listening for stateside. Robin is often on 80 CW 0300Z to 0330Z looking for stateside contacts.

Somali

The situation here continues to improve after a long DX dry spell. Several DXers in the area have applied for a 601 license now that political tensions in the area seem to be easing somewhat. Watch the low end of the 20 meter phone band for this one.

Peter Island

This one is beginning to shape up into a real possibility for early next year. The operator will be Willy DeRoos, a Belgian, who is the only person

ever to navigate the Northwest Passage single-handedly. Willy is taking along a Kenwood TS-500 and a three-element beam and plans to be there for about a year signing 3Y0BZ.

Ueno Island

This one would appear as a possibility for another new one. It is located in the far South Pacific and is sometimes hard to find on the map. A scientific group is scheduled to head that way sometime in the next year

Continued on page 46

MADISON ELECTRONICS SUPPLY, INC.

1508-F MCKINNEY HOUSTON, TEXAS 77002
713/658-0268 Nites 713/497-5683

MASTERCHARGE — VISA

NEW! EXCITING! BREAKTHROUGH! YAESU FT 225RD Transceiver & Accessories

| | |
|-------------------------------------|----------|
| FT 225RD w/2M Digital Speaker/Patch | \$895.00 |
| MU 225 Memory Unit | 74.00 |
| FT 625RD (pictured) | 165.00 |
| | 895.00 |

CALL FOR QUOTES ON:

| | |
|---|---------|
| YAESU | KENWOOD |
| FT901 DM | TS820S |
| FT625 | TS520S |
| FT225 | TR7400A |
| ALDA, AMCOMM, ETO ALPHA TEMPO VHF ONE PLUS | |



ANTENNAS

Model OJA-146

TWO METER AMATEUR BAND 146-148MHz

- NO GROUND PLANE REQUIRED
- USE FIXED, MOBILE, OR PORTABLE
- 5dB GAIN OVER ISOTROPIC IN MOST MOBILE APPLICATIONS
- OVERALL LENGTH: LESS THAN 64 INCHES
- COLLAPSIBLE TO 22 INCHES. MAY BE PACKED IN SUITCASE FOR THOSE OUT-OF-TOWN TRIPS
- STEEL WHIP AND ADAPTER INCLUDED FOR MOBILE AND FIXED APPLICATIONS
- VSWR: LESS THAN 1.2:1

PRICE \$39.95 UPS Prepaid
220 MHz — \$37.95 450 MHz — \$37.95

**CALL FOR FAST QUOTES
SPECIAL ORDERS WELCOME**

TERMS: All prices FOB Houston. Prices subject to change without notice. All items Guaranteed. Some items subject to prior sale. Send letterhead for Amateur dealers price list. Texas residents add 6% tax. Please add postage estimate.

W5GJ, W5MBB, K5AAD, N5JJ, W5IMJ, WD5DWL, WD5GDE, K5ZD, WD5ABR, WA5TGU, WD5BDX, WB5AYF, K5RC, K5BGB.

Have A Nice Day!
DLA.

BIG TURKEY SPECIALS

| | |
|---|------------------------|
| OMNI-J & heavy duty magnet mount complete | \$49.95 |
| TRIEX W-51 FT Self Support Tower (Reg. \$825.00) | |
| Your Cost (F.O.B. California) | \$725.00 |
| Tonna F9FT Antennas 144/16el. | \$65.95 |
| 9/19 OSCAR | \$63.00 |
| RIW 432/19el | \$59.95 |
| KLITZING VHF-UHF Amplifiers | |
| 2M 10W In — 100W Out | \$179.95 |
| 432 10W In — 50W Out | \$189.95 |
| BIRD 43 & Slugs, Stock, UPS Paid. | |
| Microwave Modules 432-28S, UPS Paid | \$259.00 |
| Telrex TB5EM, In Stock | \$415.00 |
| NEW Palomar Engr. Transceiver Preamp | \$89.50 |
| Bencher Paddles . . . \$39.95; Chrome | \$49.95 |
| ETO 76 Amplifiers | Stock |
| Lunar 6M-2M-220 In Line Preamps | \$49.95 |
| Lunar 2M Amp 10-80 with Preamp, UPS Paid | \$89.95 |
| Janel QSA-5, 6 | \$41.95 |
| CDE HAM-3 . . . \$129.00; HAM-X | \$249.00 |
| VHF Engrs. blue line amps | stock |
| Cetron 572B | \$27.95 |
| Raytheon 572B | \$24.95 |
| Motorola HEP170 | \$0.29 ea. |
| Aerovox 1000PF/500V Feed thru | \$1.95 |
| Ge 6146B/8950 | \$7.95 |
| Technical books: AMECO, ARRL, Sams, TAB, Rider, Radio Pub., Callbook, Cowan, many others | Call |
| NEW BELDEN 9405 (2#16) (6#18) 8 wire Rotor Cable, heavy duty for long runs | \$0.26/ft. |
| 8448, Std. 8-wire Rotor | \$0.16/ft |
| 9888, double shield RG8 Foam | \$0.39/ft |
| 8214, RG8 Foam | \$0.25/ft |
| 8237, RG-8 | \$0.21/ft |
| 8267, RG-213 | \$0.25/ft |
| Amphonor Silver Plate PL259 | \$0.59 |
| TIMES 1 1/2" Foam Hardline \$0.60/ft | Connectors \$15.00 ea. |
| 7/8" Hardline \$1.50/ft | Connectors \$25.00 ea. |
| BERKTEK RG-8X, 52ohm, KW | \$0.16/ft |
| Consolidated HD-18 Ga. Galv. Tower, 10' sec. | \$29.95 |
| Robot "Slow Scan" Now In Stock | Call |

THIS MONTH'S SPECIAL

Electra Bearcat 250 Scanner . \$299.00

16 ELEMENTS — F9FT — 144 MHz

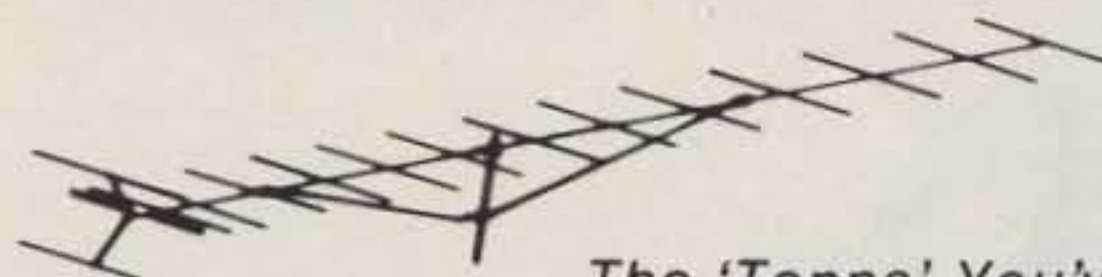

The 'Tonna' You've been hearing about

| | |
|-------------------------------------|-----------------|
| 17.8 dBi | SWR 1.2:1 |
| 144/146 MHz | Wt. 4.4 kg. |
| 50 ohms | Horiz./Vert. |
| length 6.4 m. | F/B ratio 22 dB |
| Horizontal aperture 2 x 16° (-3 dB) | |
| Vertical aperture 2 x 17° (-3 dB) | |
| Side lobe attenuation 60 dB | |

\$65.95

MADISON M35

ELECTRONICS SUPPLY, INC.

1508-F MCKINNEY HOUSTON, TEXAS 77002
713/658-0268 Nites 713/497-5683

MASTERCHARGE — VISA

John L. Webster VP2DN
University of the West Indies
St. Augustine
Trinidad, West Indies

Electro Sculpture

— be a radio Rodin

What do you — the average ham, electronics experimenter, or repairman — do with dud or defective components? Throw them in the dustbin? If your answer is yes, pause a while and look at the photographs in this article. With a little creativity and the junk collector's urge, both of which are essential prerequisites to being a good

ham, you can put these components to an interesting use and give them a second life. A life that may in many ways prove to be more interesting than the former one.

Actually, if you get the XYL hooked on this one and forget to keep the shack locked, then you may find your parts stock being rapidly and mysteriously depleted. You may even fire up the

trusty old rig one evening to be met by a barrage of sparks . . . close examination of the charred remains may reveal several of those beautifully striped resistors and brilliantly colored capacitors have taken up permanent residence elsewhere. But not to worry! Here again you can fall back on the old adage, "Prevention is better than

cure." Before you bait the line for the XYL, spend a few dollars on some of those "Barrel Kits" offered by firms like Poly Paks, Inc., at very reasonable prices. It's also a good opportunity to stock up on usable parts.

Poly Paks guarantees a 50% yield of functional, or part functional, devices, and, in my experiences, I have been very satisfied, with the guarantee being met and usually exceeded in most cases. Well, assuming that you have either accumulated a good collection of duds previously, or have purchased several Barrel Kits, you are ready for action. Take a close look at the photos and then get started.

The three musicians (not Musketeers!) illustrated here were made entirely from defective electronic components soldered together to produce the desired shapes. Almost anything may be

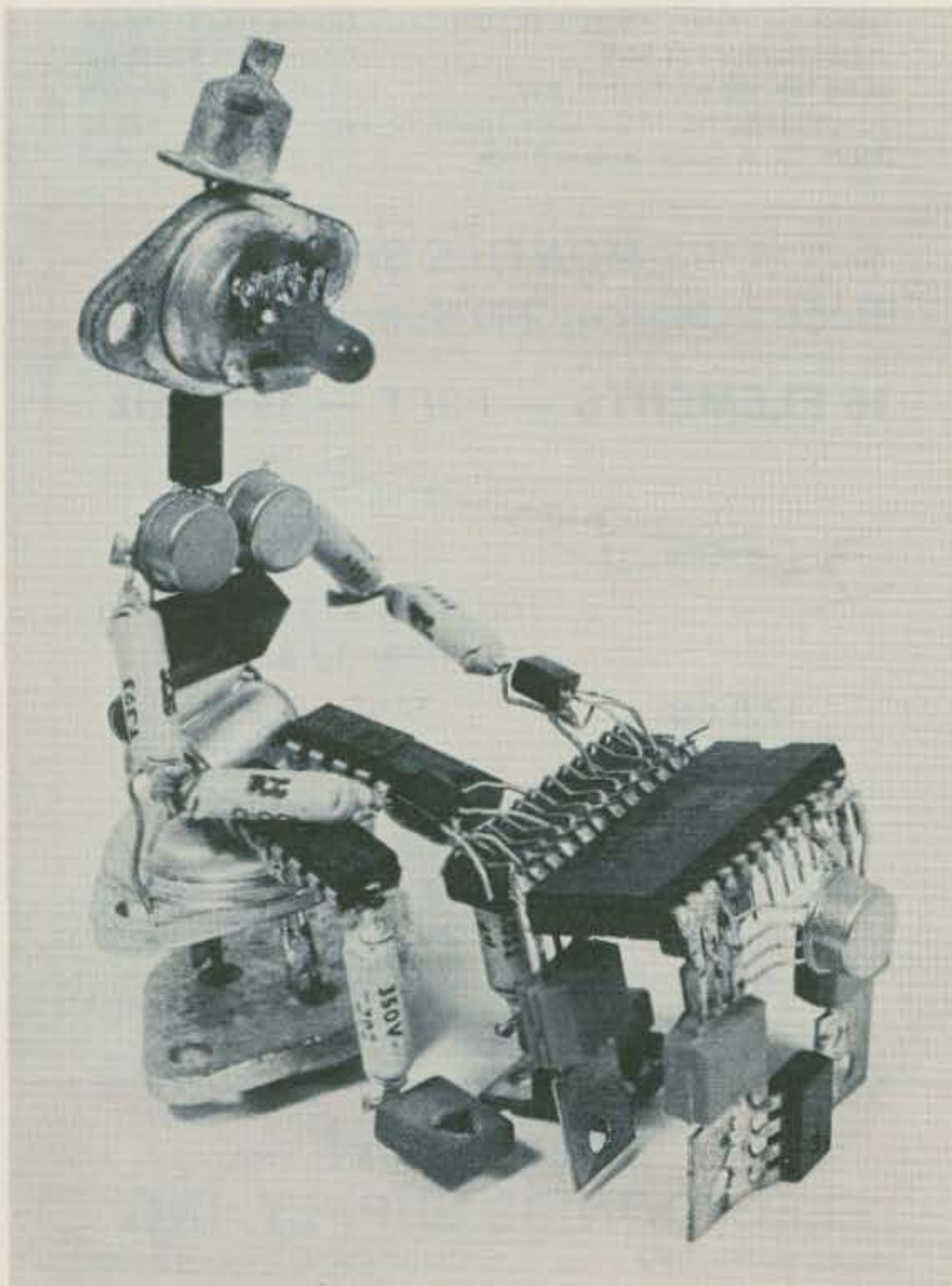

The Organist. Note use of DIP ICs and TO-220 transistors to form the organ.



The Drummer. Note use of TO-92 transistors to form hands and fingers. Drumsticks are diodes, cymbal is TO-3 case top, and drums are pill bottles.



The Guitarist/Vocalist. Note use of LED for nose and dipped tantalums for eyes. Guitar is made from TO-3 transistor, TO-220 transistor, and DIP ICs. Microphone is germanium transistor.

sculpted in this way, provided a pinch of creativity is added.

Previous experience has shown when sculpting figures that:

(a) Tiny dipped tantalum electrolytics, usually blue or green in color, make excellent eyes.

(b) LEDs are perfect for noses — Rudolph the red-nosed...?

(c) TO-92 transistors are ideal for hands, with the leads representing fingers (only three though, maybe Martians).

Unique greeting cards may also be made by gluing components onto sturdy cards in the desired pattern. Such a project may be given a finishing touch by including a functional crystal radio complete with earphone, which is revealed on opening the card. I once made such a card for the

XYL's birthday just after she became interested in amateur radio, but I do not have an illustration of it available. The same principle may be utilized to produce pictures to decorate the walls of your shack.

Those of you interested in the game of chess may create a rather original game, using "tired" thermionic valves as the chessmen. What a way to fire up those "soft" 807s you have hidden away in the garage! Also, it may be the only way to illustrate to your grandchildren what a thermionic valve looked like.

These ideas have been presented here to get you moving, and I hope the accompanying photographs will fire your imagination, encourage you not to dump your defective components, and start you soldering. ■

Call for the famous **HAM·KEY**™

JUST DIAL **1-800-325-3636** TOLL FREE



- Model HK-1**
- Dual-lever squeeze paddle
 - Use with HK-5A or any electronic keyer
 - Heavy base with non-slip rubber feet
 - Paddles reversible for wide- or close-finger spacing
- \$29⁹⁵**



- Model HK-2**
- Same as HK-1, less base for incorporation in own keyer
- \$19⁹⁵**



- Model HK-3**
- Deluxe straight key
 - Heavy base...no need to attach to desk
 - With navy type knob
- \$16⁹⁵**

- Model HK-3A**
- Same as above less base **\$9.95** Extra: navy type knob only **\$2.75**

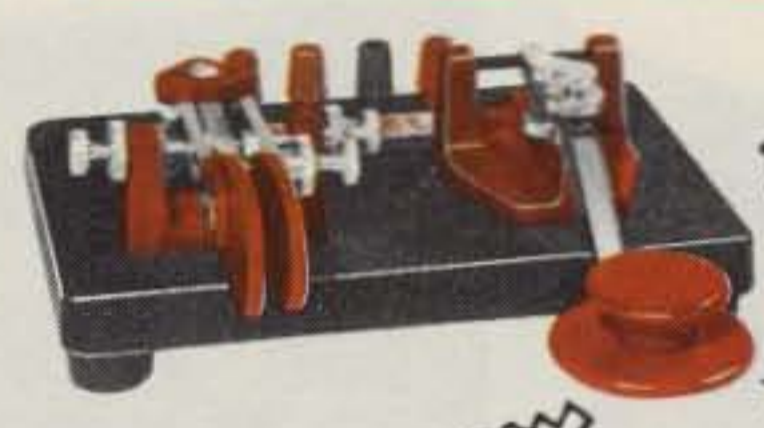

- Model HK-4**
- Combination of HK-1 and HK-3 on same base
- \$44⁹⁵**
- Base only with rubber feet **\$12.00**
 - Terminals, red or black. **\$.75** each



- Model HK-5A Electric Keyer**
- New Cabinet Colored-Keyed to Match most modern radio equipment
 - Iambic Circuit for squeeze keying
 - Self-completing dots and dashes
 - Curtis 8044 I.C. Keyer Chip
 - Battery operated with provision for external power
 - Built-in side-tone monitor
 - Grid block or direct keying
- \$69⁹⁵**

Same day shipment...PREPAID
So order today direct or from your favorite dealer

HAM RADIO CENTER armo

6340-42 Olive Blvd • P.O. Box 28271 • St. Louis, MO 63132

✓ H2

there's a world of difference
in TEN-TEC's *all-new*
hf transceiver—

 **OMNI**



OMNI—THE ALL-INCLUSIVE. Because OMNI has it all. Designed to give you every advantage, every capability, whatever your operating specialty. Designed to give you new conveniences and new levels of performance. Designed to give you the world of Amateur Radio with a world of difference—the OMNI world of unique features. An unusual combination not found in any other.

FUNCTIONAL STYLING. The "look" you requested. "Clamshell" aluminum case clad in textured black vinyl. Complementary nonreflective warm dark metal front panel. Extruded satin aluminum trim bezel and tilt bail. Convenient controls. Fully shielded. And everything in a larger, easier-to-use size: 5¼"h x 14¼"w x 14"d.

TOTALLY SOLID-STATE. Sharing the TEN-TEC heritage of solid-state design leadership with its companion transceivers, the highly successful 540/544, OMNI has all the advantages of proven solid-state technology—reliability, long life, cool performance, better stability.

8-BANDS. The world now and in the future. OMNI covers 160, 80, 40, 20, 15, and 10 meters now (crystals included for all present Amateur bands, 1.8-30 MHz). And it has convertible 10 MHz and "AUX" band positions for the future.

BROADBAND DESIGN. Permits changing bands without tune-up, without danger of out-of-resonance damage to the final stage.

ANALOG OR DIGITAL READOUTS. OMNI-A features an analog dial with 1 kHz dial markings. OMNI-D has 0.43" LED readouts with the 5 most significant in red and the 6th in green to show 100 Hz increments.

BUILT-IN VOX AND PTT. Smooth VOX action with 3 easy-to-adjust front panel controls. PTT control is available at both front and rear panel jacks; an external microphone switch may be used.

BUILT-IN SQUELCH. Unusual in an hf rig, but handy for tuning or monitoring for a net or sked.

BUILT-IN 4-POSITION CW/SSB FILTER. 150 Hz bandwidth with 3 selectable skirt contours for optimum CW reception.

8-POLE CRYSTAL FILTER. 2.4 kHz bandwidth, 1.8 shape factor.

SEPARATE MODE SWITCH. Permits using all filters in any mode.

2-SPEED BREAK-IN. Switch to "fast" or "slow" receiver muting to accommodate any band condition or mobile operating.

2-RANGE OFFSET TUNING. Switch-select the ±5 kHz range for off-frequency DX work or the ±0.5 kHz range for fine tuning.

OPTIMIZED RECEIVER SENSITIVITY. Ranges from 2 uV on 160 m to 0.3 uV on 10 m (10 dB S+N/N) to achieve ideal balance between dynamic range and sensitivity.

GREATER DYNAMIC RANGE. Typically exceeds 90 dB to reduce possible overload from nearby stations. Also includes switchable 18 dB PIN diode attenuator for additional overload prevention.

WWV RECEPTION. On the 10 MHz band switch position.

FRONT PANEL CONTROL OF LINEAR/ANTENNA BAND-SWITCHING. Auxiliary bandswitch terminals on back panel for simultaneous control of external relays or circuits with the OMNI bandswitch.

BUILT-IN PHONE PATCH JACKS. Provide interface to speaker and microphone audio signals for phone patch connection.

BUILT-IN "TIMED" CRYSTAL CALIBRATOR. In the OMNI-A a pulsed 25 kHz calibrator desensitizes the receiver and provides an automatic 5 to 10 second "on" time for easy two-hand dial skirt adjustment.

BUILT-IN ZERO BEAT SWITCH. Permits placing your transmitted signal exactly on the listening frequencies of CW stations.

BUILT-IN SWR BRIDGE. The "S" meter electronically switches to read SWR every time you transmit to provide a continuous antenna check.

FRONT PANEL MICROPHONE AND PHONE JACKS.

ADJUSTABLE AUTOMATIC LEVEL CONTROL. For setting output power level from low power to full output, for retaining low distortion at desired drive power to linear amplifier.

SEPARATE RECEIVING ANTENNA CAPABILITY. Rear panel switch and jack connect receiving section to common antenna or separate receiving antenna. Also acts as receiving antenna by-pass when used with instant break-in linear amplifiers.

BUILT-IN ADJUSTABLE SIDETONE. Variable pitch and volume.

DUAL COMPRESSION-LOADED SPEAKERS. Larger sound output, lower distortion, no external speaker needed.

POWER INPUT. 200 watts when used with 50 ohm load. Proven, conservatively-rated, solid-state final amplifier design with full warranty for first year and pro-rata warranty for 5 additional years.

100% DUTY CYCLE. Ideal for RTTY, SSTV, or sustained hard usage.

PLUG-IN CIRCUIT BOARDS. For fast, easy field service.

POWER. Basic 12 VDC operation for convenient mobile use; external supply required for 117 VAC operation.

OPTIONAL ACCESSORIES. As all-inclusive as OMNI is, there are a few options: Model 645 Keyer, 243 Remote VFO, 248 Noise Blanker, 252M Power Supply.

Model 545 OMNI-A \$899 Model 546 OMNI-D \$1069

Experience the world of difference of OMNI, see your TEN-TEC dealer or write for details.



TEN-TEC, INC.
SEVIERVILLE, TENNESSEE 37862
EXPORT: 5715 LINCOLN AVE., CHICAGO, ILL. 60648

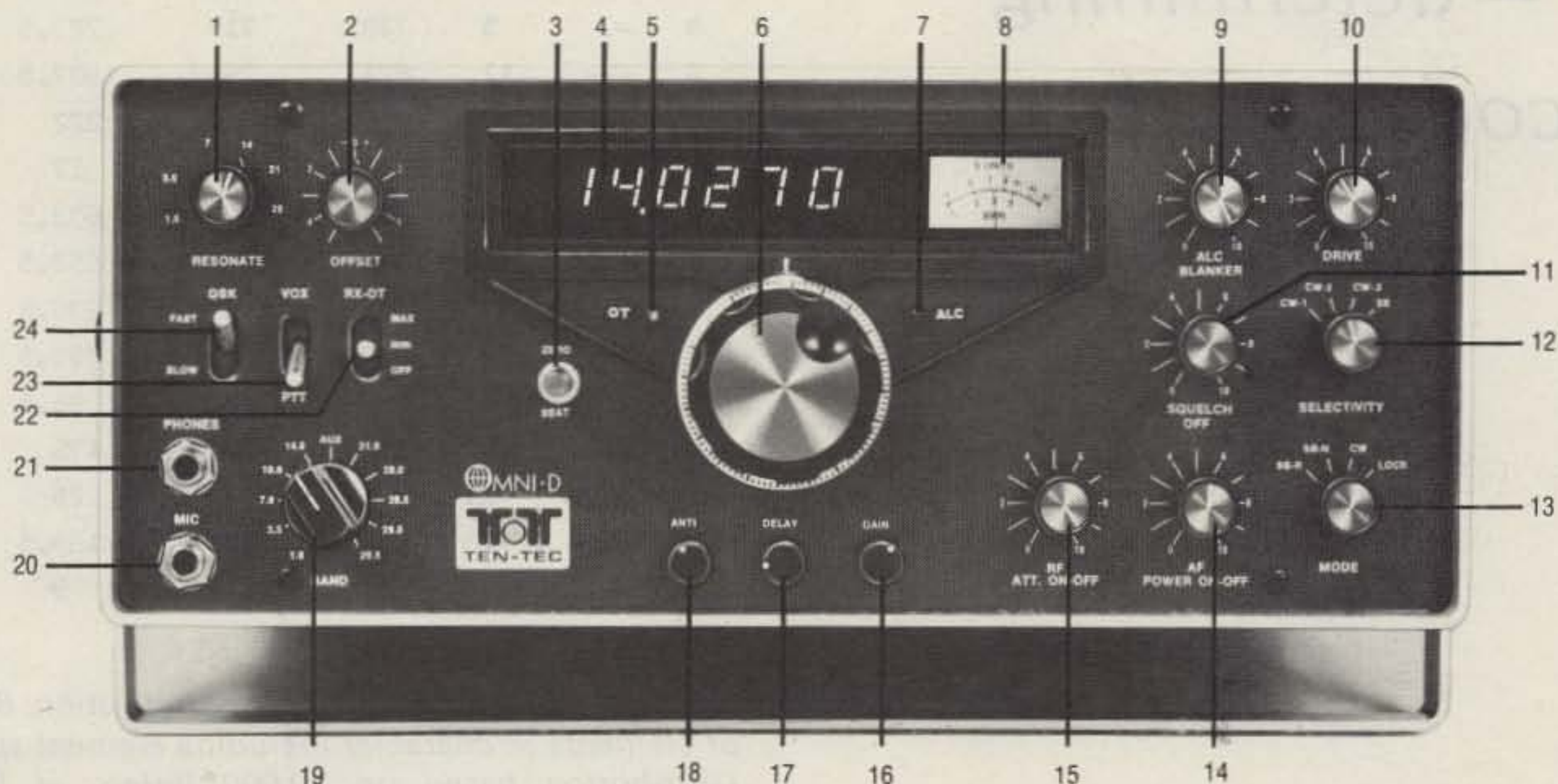

- 1 Receiver RESONATE control for peak sensitivity.
- 2 Receiver Dual Range OFFSET TUNING control for off-frequency work.
- 3 ZERO BEAT switch; spring-loaded, momentary contact.
- 4 6-Digit LED FREQUENCY READOUT for 100 Hz accuracy.
- 5 OFFSET TUNING LED indicates OT switch is "on".
- 6 MAIN TUNING KNOB; big, easy-to-grip with integral spinner.
- 7 AUTOMATIC LEVEL CONTROL LED indicates ALC-region operation.
- 8 Combination "S" and SWR METER; switches automatically.

- 9 Combination ALC control and NOISE BLANKER on/off switch.
- 10 DRIVE control for final stage.
- 11 SQUELCH combination on/off switch and control.
- 12 4-Position SELECTIVITY switch for SSB and CW.
- 13 4-Position MODE switch; automatic SSB Normal, Reverse, CW, and Lock (key down).
- 14 Combination push-pull POWER switch and AUDIO LEVEL control.
- 15 Combination RF ATTENUATOR on/off switch and control.
- 16 VOX GAIN control.

- 17 VOX DELAY control.
- 18 VOX ANTI-TRIP control.
- 19 11-Position BAND SWITCH.
- 20 MICROPHONE jack; hi-z input.
- 21 HEADPHONES jack.
- 22 RECEIVER OFF-SET TUNING SWITCH; 3-position: Max-Min-Off.
- 23 VOX-PTT SWITCH.
- 24 OSK (full break-in) SWITCH; 2-position: Fast-Slow.

Ralph M. Hirsch K1RH
 172 Newton Road
 Woodbridge CT 06525

The SUMSUE Method

— determining
 code speeds . . .
 accurately

Want to know how fast you sent that last QSO? Did you ever wonder how to adjust your keyer for an exact speed for CW practice? Here is a simple precise method that requires only an ordinary timepiece with a sweep second hand. No counters, no scopes, nothing fancy; just a clock and a curve.

What do we mean by CW speed, anyway? As far as ham radio is concerned, it is the number of five-letter words, in plain English text, that can be transmitted in one minute. We must also include certain mandatory spacing between characters, words, and even between the dots and dashes in the in-

| | <u>A</u> | <u>B</u> | <u>C</u> | <u>D</u> | <u>E</u> | <u>F</u> |
|-------|----------|----------|----------|----------|----------|----------|
| A | .- | 5 | 781 | 805 | 793 | 3965 |
| B | | 9 | 128 | 162 | 145 | 1305 |
| C | -.-. | 11 | 293 | 320 | 306.5 | 3371.5 |
| D | -. . | 7 | 411 | 365 | 388 | 2716 |
| E | . | 1 | 1305 | 1231 | 1268 | 1268 |
| F | ..-. . | 9 | 288 | 228 | 258 | 2322 |
| G | -. . | 9 | 139 | 161 | 150 | 1350 |
| H | | 7 | 585 | 514 | 549.5 | 3846.5 |
| I | .. | 3 | 677 | 718 | 697.5 | 2092.5 |
| J | .-. . | 15 | 23 | 10 | 16.5 | 247.5 |
| K | -. . | 9 | 42 | 52 | 47 | 423 |
| L | .-. . | 9 | 360 | 403 | 381.5 | 3433.5 |
| M | -. . | 7 | 262 | 225 | 243.5 | 1704.5 |
| N | -. . | 5 | 728 | 719 | 723.5 | 3617.5 |
| O | -. . | 11 | 821 | 794 | 807.5 | 8882.5 |
| P | .-. . | 11 | 215 | 229 | 222 | 2442 |
| Q | -. . | 13 | 14 | 20 | 17 | 221 |
| R | .-. . | 7 | 664 | 603 | 633.5 | 4434.5 |
| S | | 5 | 646 | 659 | 652.5 | 3262.5 |
| T | - . . | 3 | 902 | 959 | 930.5 | 2791.5 |
| U | .. . | 7 | 277 | 310 | 293.5 | 2054.5 |
| V | | 9 | 100 | 93 | 96.5 | 868.5 |
| W | .-. . | 8 | 149 | 203 | 176 | 1584 |
| X | -. . | 11 | 30 | 20 | 25 | 275 |
| Y | -. . | 13 | 151 | 188 | 169.5 | 2203.5 |
| Z | -. . | 11 | 9 | 9 | 9 | 99 |
| TOTAL | | | | | | 61781 |

Fig. 1. A = Character and code composition; B = Number of elements in character including element spacing; C = Distribution based on 10,000 letters of literary text (Ohaver); D = Distribution based on 10,000 letters of literary text (Meaker); E = Average distribution per 10,000 letters of literary text; F = Number of elements per 10,000 letters.

dividual characters. Unfortunately, not many of us have a vocabulary consisting of words with exactly five letters, so we must find some norm that will allow establishment of a standard. By definition, the dot is the basic element of a character upon which all other parts of the individual characters and the word structure are based. Alone, it cannot be called a baud, because it is really only half a baud. So, rather than confuse the issue, let's talk in terms of "elements," with the dot having a value of 1, the space between dots and dashes within the character also having a value of 1, the dash 3, the spacing between characters 3, and the spacing between words 7.

Okay, so how do we find out how long a "word" is? A mathematical analysis of the 26 letters of the English alphabet (Fig. 1, column B) shows the average length of a character to be 8.3 elements. Now, it would seem that if we simply multiply the average character length of 8.3 times 5 (41.5), then add 3 elements for each of the 4 character spaces (12), plus 7 elements for the word space since it must be included in our time frame, we end up with a word length of: $41.5 + 12 + 7 = 60.5$ elements.

Right? Yes, for 5-letter random code groups, but wrong for plain language. Hams speak in more or less ordinary English. Sure, we throw in lots of abbreviations, and perhaps more "Q", "X", and "Y" letters (such as XYL, for instance) than appear in English literary text, but nobody has compiled character distribution tables in "hamese," so we are forced to take the word of the experts for distribution of characters within 10,000 letters of standard English literary text. But even they

don't agree, as you can see in Fig. 1, columns C and D, so we averaged them out and came up with the distribution in column E, plus the element count in column F. Now we find that the average letter is about 6.18 elements, rather than 8.3. Substituting in the above formula, our word length is now: $31 + 12 + 7 = 50$ elements.

All we have to do is find a word that has exactly 50 elements in it, and we are in business. For years the word PARIS has been the standard. It contains 43 elements in character elements and character spacing, but it does require a rather accurate 7 element spacing between words, and it must be sent more than once. It is simpler to send PARISE, which contains exactly 50 elements whether sent alone or in strings. The standard word can be any which will add up to exactly 50 elements. I have chosen the word SUMSUE rather than PARISE, as it is easy to transmit and has a nice rhythm. However, to gauge your speed with only one SUMSUE is difficult. You have more accuracy and a better average when you send several, so I have plotted a curve, Fig. 2, which gives exact speeds based on a string of 5 SUMSUEs. To determine your speed for a specific keying device setting, send five SUMSUEs with no extra spacing between words, that is, one long word, and carefully note the time required in seconds. Then locate this time on the horizontal scale of Fig. 2, come up until you intersect the curve, move to the left, and read the words per minute (wpm) on the vertical scale. For example: If it takes 15 seconds to send 5 SUMSUEs, your speed is exactly 20 wpm. If you wish to set your device to a given speed, pick that

speed on the vertical scale, move to the right to intersect the curve, then move downward to find how many seconds it should take to send 5 SUMSUEs. If you wished to send at 13 wpm, speed up or slow down your device until you can send 5 SUMSUEs in 23 seconds and your speed will be precisely 13 wpm. Experiments with standard English text, actually counted after setting a keyer by the SUMSUE

method, proved the system works.

So the next time you are asked, "How fast are you sending?", you can say with confidence what you know your speed to be. You can also impress your fellow hams who have not read this article. But remember, for the curve to be accurate, you must have the proper weighting of your dot-dash ratio of 1:3 and your dot-element spacing must also be 1:1. ■

| Character | Elements |
|-----------|----------|
| S | 5 |
| (CS) | 3 |
| U | 7 |
| (CS) | 3 |
| M | 7 |
| (CS) | 3 |
| S | 5 |
| (CS) | 3 |
| U | 7 |
| (CS) | 3 |
| E | 1 |
| (CS) | 3 |
| Total | 50 |

CS = Character Space. Note: The 7 element word space is represented by the 1 element "E" and the CS preceding and following it.

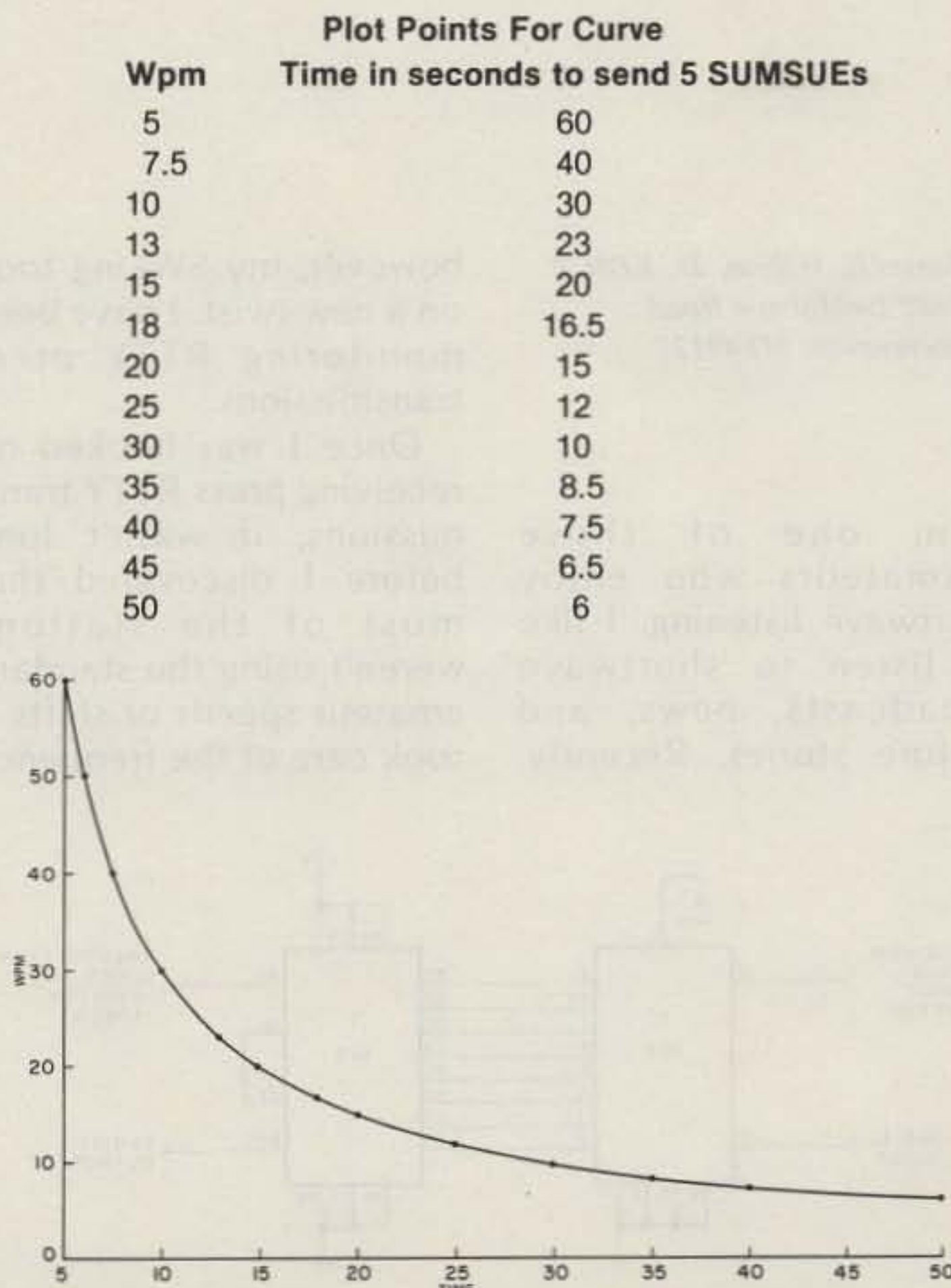

Fig. 2.

The UART Gear Shifter

— for multi-speed RTTY

James B. Wilson, Jr. KB8CE
5886 DeMorrow Road
Stevensville MI 49127

I'm one of those amateurs who enjoy shortwave listening. I like to listen to shortwave broadcasts, news, and feature stories. Recently,

however, my SWling took on a new twist. I have been monitoring RTTY press transmissions.

Once I was hooked on receiving press RTTY transmissions, it wasn't long before I discovered that most of the stations weren't using the standard amateur speeds or shifts. I took care of the frequency

shift problem by modifying my terminal unit for 425 Hz shift. This covers most of the press transmissions, with a few still using 850 Hz shift. My next problem was the speed. I looked into gears and found that it got kind of sticky trying to change gears for each new station! A Model 28 can be modified for a mechanical gear shift. However, the funds at my QTH indicated that a Model 28 was out of the question at the present time. I'm still saving for one! The only solution then was this thing called a UART.

When I decided to go with the UART, I started gathering all available information on this device. I

found out some very interesting things. Firstly, UART stands for Universal Asynchronous Receiver/Transmitter. It seems that this UART takes the serial input data, in this case from the terminal unit, and converts it to parallel data. This parallel data is then applied to the transmitter section, where it is converted back into serial data and then applied to the printer. The speed change occurs due to the clock rates. Both the receiver and transmitter have to be clocked by an external oscillator. The receiver is clocked at the incoming signal speed. The transmitter is then clocked at the *desired* output speed. This particular speed converter

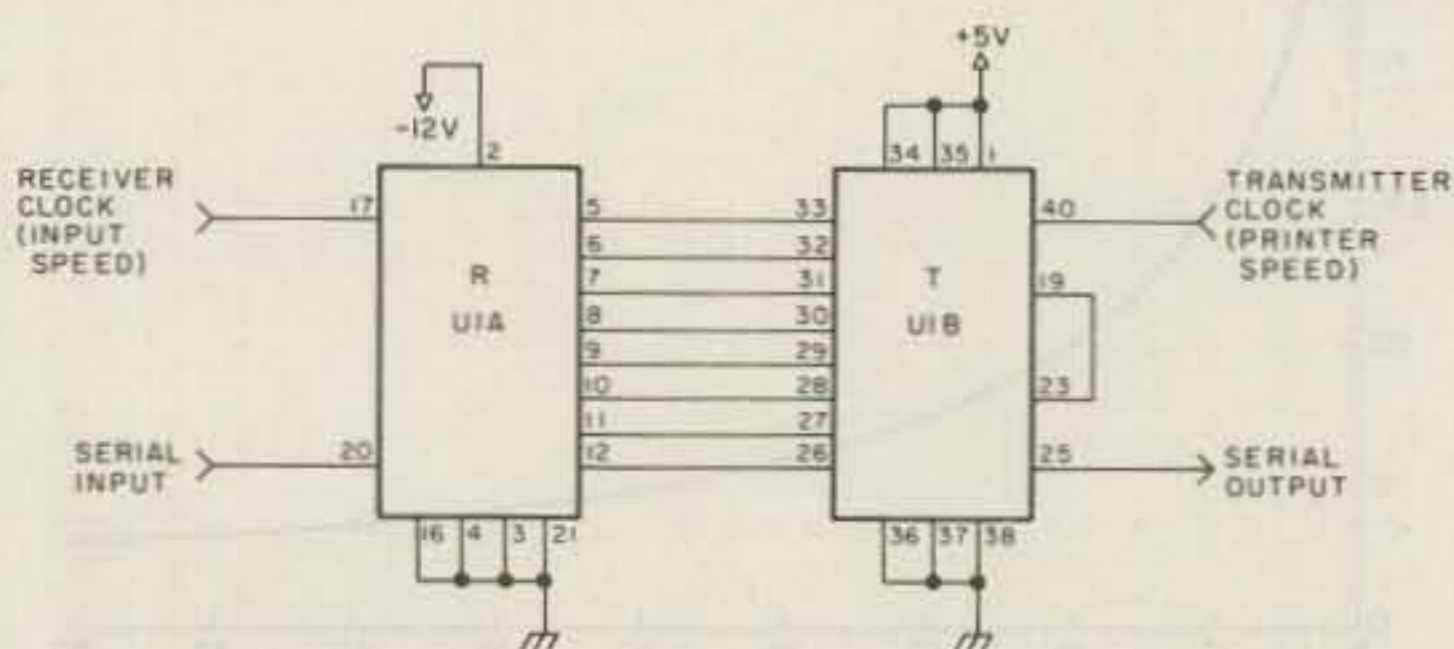

Fig. 1. AY-5-1013 UART.

has no provision for converting the speed down. That would require storage of data between the receiver and transmitter. If the receiver was taking in data at a speed of 100 wpm and the transmitter was reading it out at 60 wpm, there would soon be a pileup of data between the two. In the case of press transmissions, the input data would be at a constant speed. This would mean that an extremely large memory would be required to implement a down converter. If a Teletype™ keyboard is the input, as in some previously published articles, the memory could be much less, as the input data would not be at a constant 100 wpm.

Having thought all this through, my next step was to gear my Model 15 for the highest speed possible (at this time 75 wpm, although I have located some 100 wpm gears), and to build a speed converter using a UART. I wanted the speed converter to be a stand-alone unit, mostly because I didn't want to modify any existing gear and also because I had some extra rack space to fill! Making it a stand-alone unit meant that a power supply, Teletype loop, and input interface from the ST-5 loop would have to be included as well as the UART circuitry.

Fig. 1 shows the actual UART circuitry. Not much to it, is there? I'm using an AY-5-1013 UART, as it was available at a reasonable price. U1A represents the receiver section and U1B the transmitter. The connections 5 through 12 on the receiver and pins 26 through 33 on the transmitter are the parallel data lines. This one is shown connected for 8 bits of data. Since Baudot code uses 5 bits of data, it is only necessary to connect pins 8

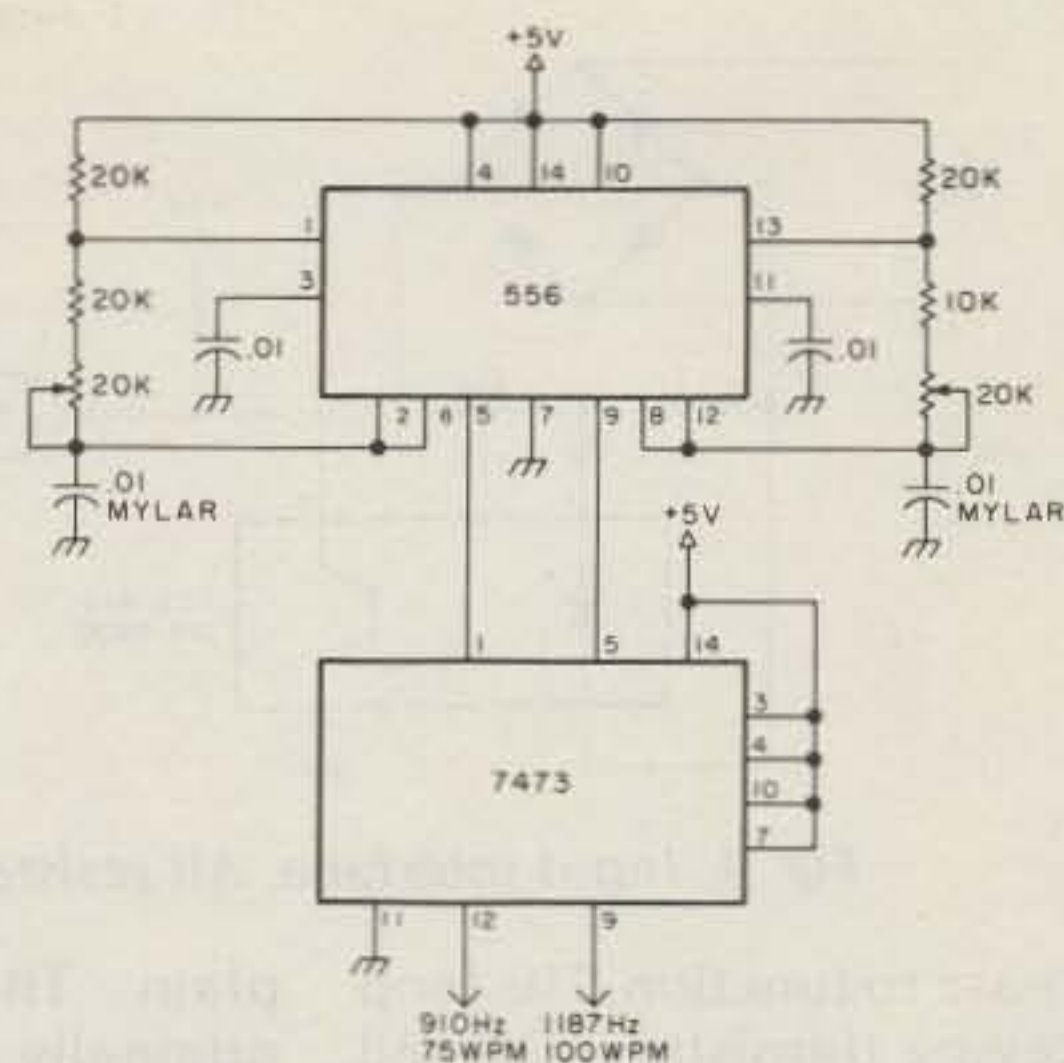
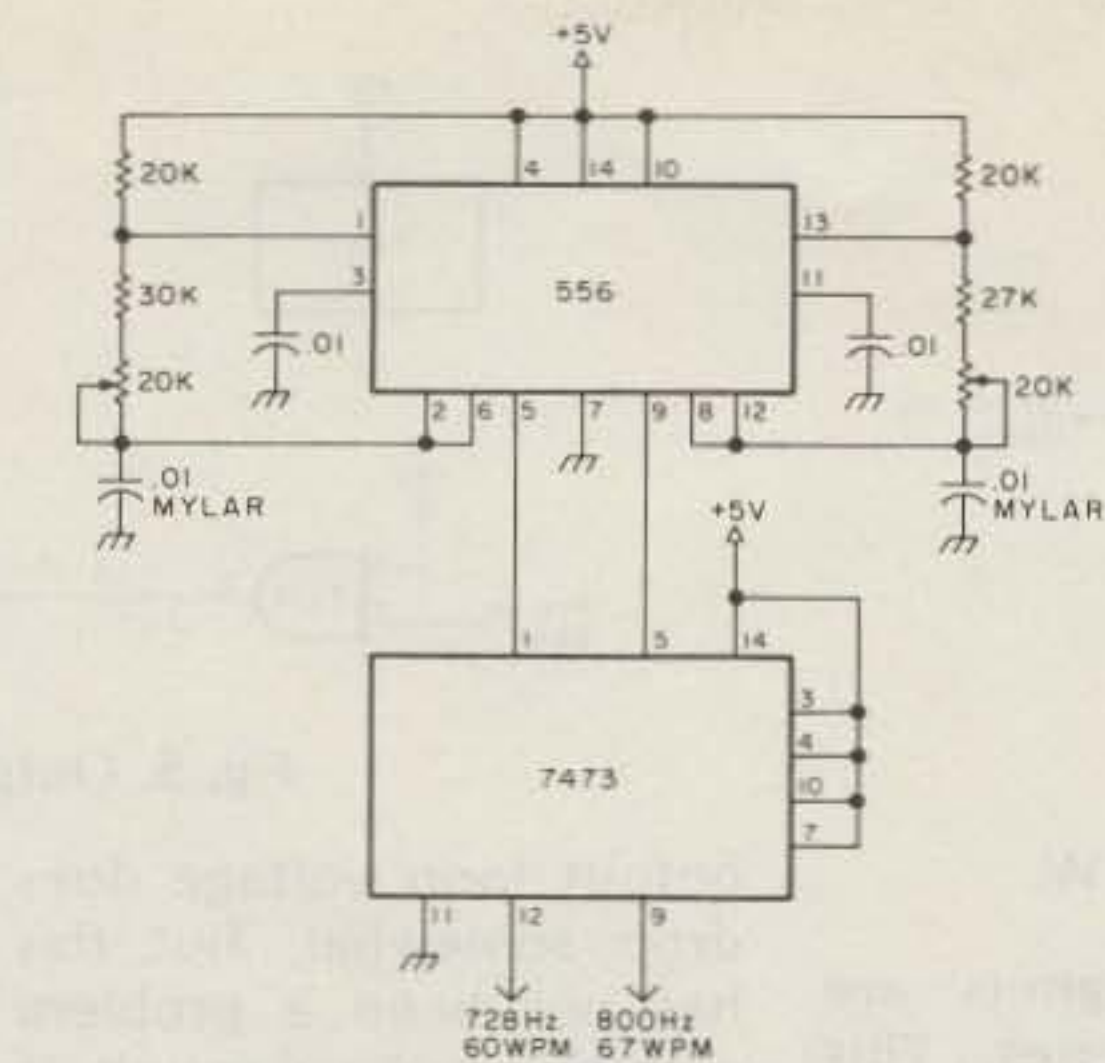

Fig. 2. Clocks. All resistors 1/2 W.

through 12 to pins 26 through 30. I have mine connected as shown for a possible change to ASCII.

If you are interested in the whys and wherefores of the other pin connections, I shall refer you to the references at the end of this article or, better yet, to the UART data sheet. The UART shown in Fig. 1 is connected for one stop bit, five data bits per character (Baudot), and no parity bit.

The clocks for the UART, shown in Fig. 2, were of particular concern to me. Originally I wanted to use a crystal-controlled clock. Nothing but the best for my project! But when I started to look for parts, I found them very difficult to obtain, if not downright impossible. A colleague convinced me that the NE555 timer was very stable and could be used in this application. So I decided to try the NE556 dual timer chip for my clock. I must report completely satisfactory results with these chips. They were very easy to design and set up. I added 7473 dual JK flip-flops as a buffer and to make the square waves symmetrical. However, this may not have been necessary. The frequencies shown are the frequencies at the output of the JK flip-flops. On initial setup of the speed converter, I used a frequency counter to set

the frequency and have not had to adjust it since, even after a 600-mile move and two months in cold storage! So I would say that the NE556 timers have worked exceptionally well.

The switching arrangement is shown in Fig. 3. It is fairly self-explanatory: one switch to set up the receive or input speed, and one to set up the transmitter or output speed. It is only necessary to set the transmitter speed once, as the printer is only geared for one speed. In an updated version, the transmitter or printer speed switch could be eliminated and its speed hard-wired.

The frequencies for the clocks were calculated using the formula: freq. = baud rate \times 16. The factor of 16 comes from the UART itself. The baud rates for 60 wpm = 45.5, 67 wpm = 50.0, 75 wpm = 56.9, and for 100 wpm = 74.2.

The input is designed to interface with a standard 60 mA loop, in my case directly from the ST-5. It

uses an optoisolator, in my case a GE 4N35 which I found at my local supply store, much to my surprise. Most any optoisolator should work in this configuration. The optoisolator takes the high voltage current loop and converts it down to TTL levels so that the signal will be compatible with the UART. Getting the RTTY signal down to TTL levels has proven to be quite useful. I have already added a TTL RY generator to the speed converter; it was extremely easy since I only needed to patch it into the input of the UART. This would be true for a lot of the other interesting RTTY projects that have been published. The circuitry for the input interface is quite simple and straightforward, as you can see from Fig. 4.

The output interface is shown in Fig. 5. It uses a 7437 as an output buffer for the UART. This is required because the UART output can only stand one TTL load on it or it will

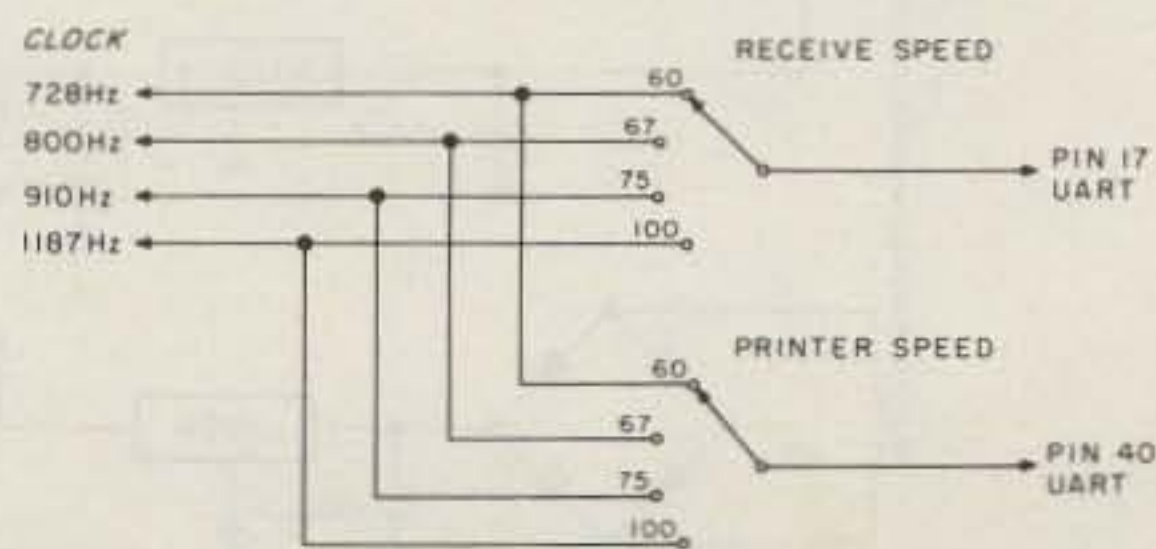

Fig. 3. Switching.

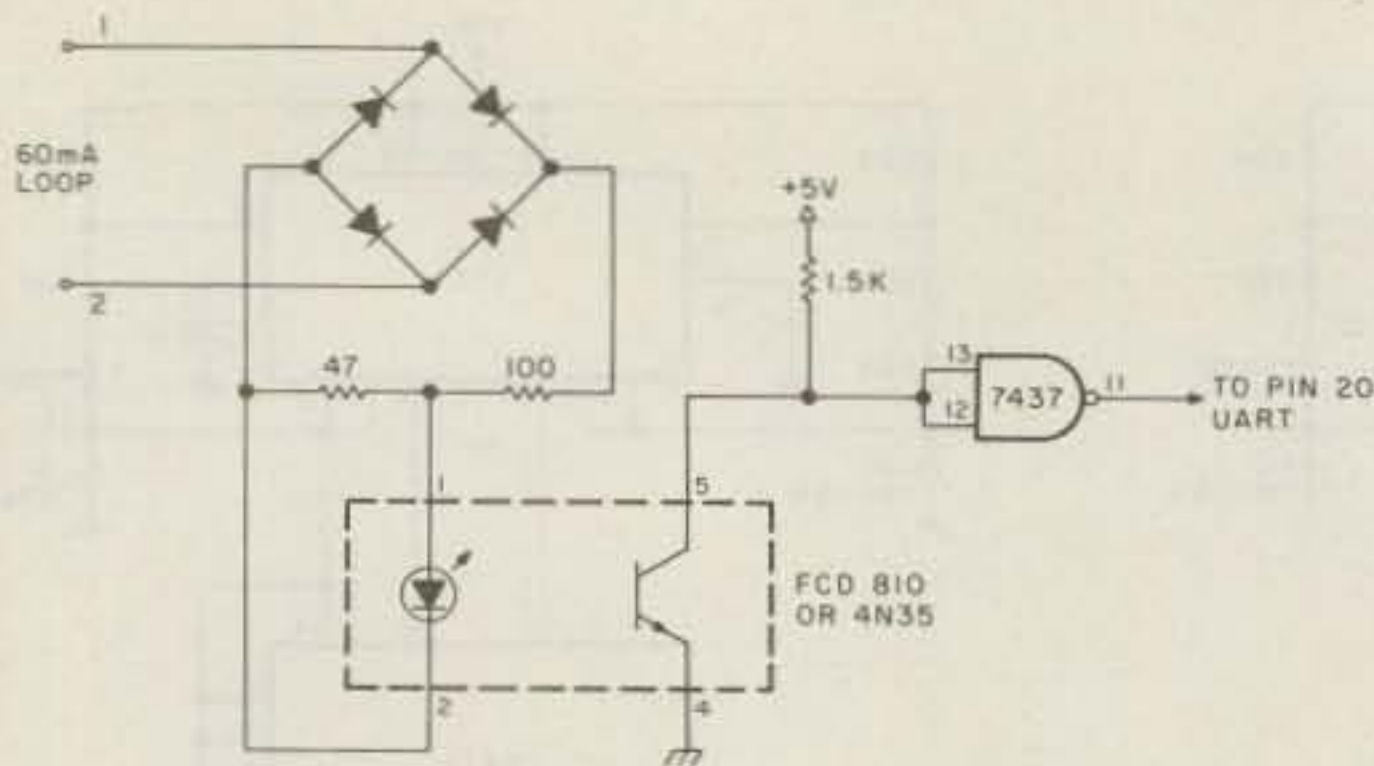

Fig. 4. Input interface. All resistors 1/2 W.

cease to function. The loop keying transistors, Q1 and Q2, are 2N2528s. These are some TO-3 case transistors I found in my junk box and they work quite well; they do require a sufficient heat sink. I used the chassis as a heat sink in this project. Other suitable transistors are 2N174s, 2N277s, 2N251s, and 2N1501s.

The unusual thing about this output interface is that it uses only a 40-volt supply. I did this to take advantage of the power supply transformer I already had in the unit to power the TTL components and the UART. To get away with using a 40-volt loop supply, I used a special transistor keying circuit and wired the printer magnets in parallel. Wiring the printer magnets in parallel meant that the loop current would have to go up to 120 mA. There are several advantages to be gained by this. When you place the printer magnets in parallel, the total inductance is cut by one-fourth! Let me ex-

plain. The magnets are originally in series. This means that the total inductance is the sum of both inductances. When we place them in parallel, the total inductance is reduced to half of one inductor's inductance, if both magnets are equal. This gives us a better keying waveshape on the loop. It also allows us to use a smaller, more convenient power supply. See reference 1(b) for a very interesting discussion of this circuit.

The power supply, shown in Fig. 6, is relatively straightforward. I try to make power supplies as simple as possible, primarily because it seems they are always the one to give me trouble. The UART requires -12 V dc and +5 V dc. These are both supplied by IC regulators. I use the hefty K series here, which may be just a little bit of overkill. The 40-volt loop supply comes off a capacitor which charges to the peak of the incoming voltage. In practice, the

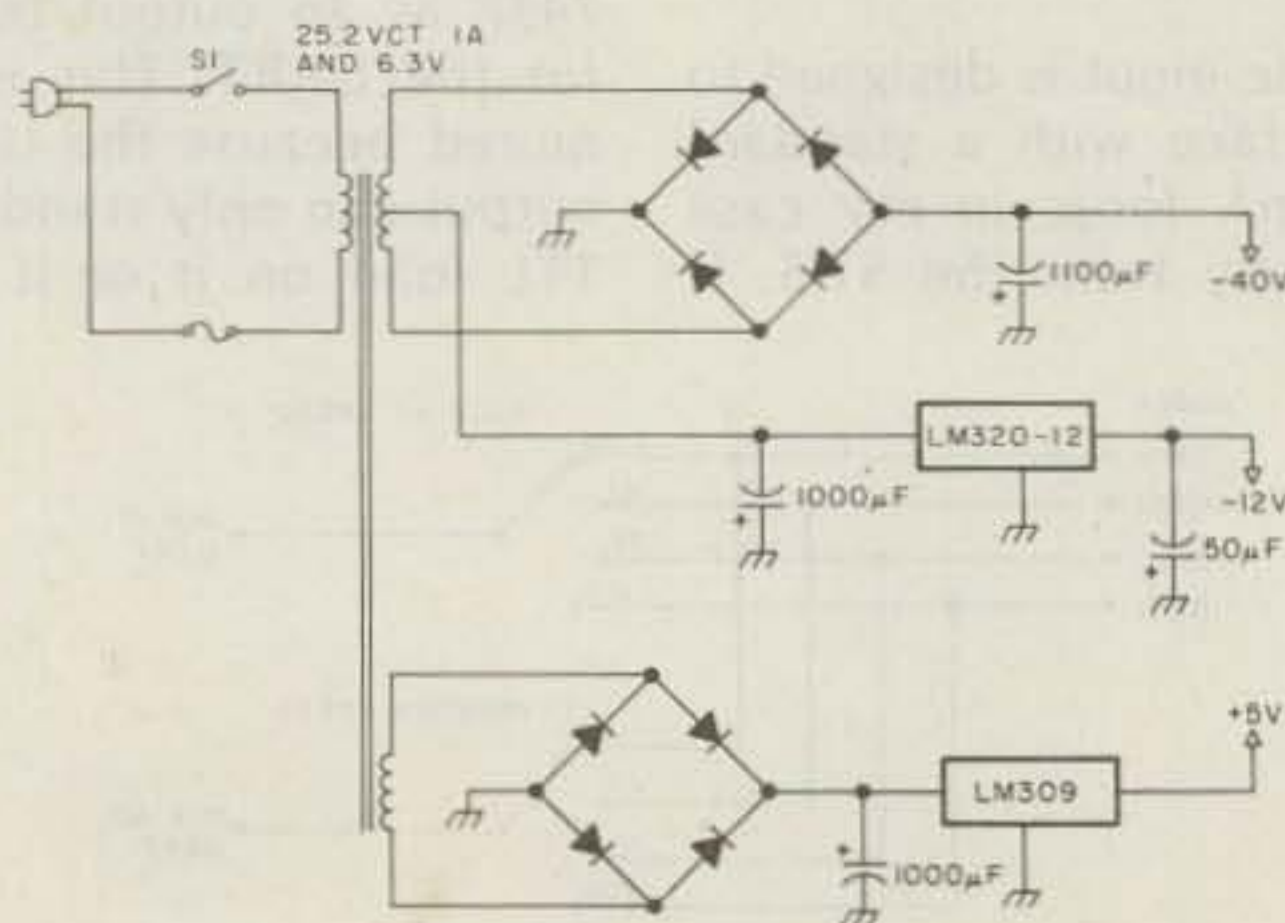

Fig. 6. Power supply.

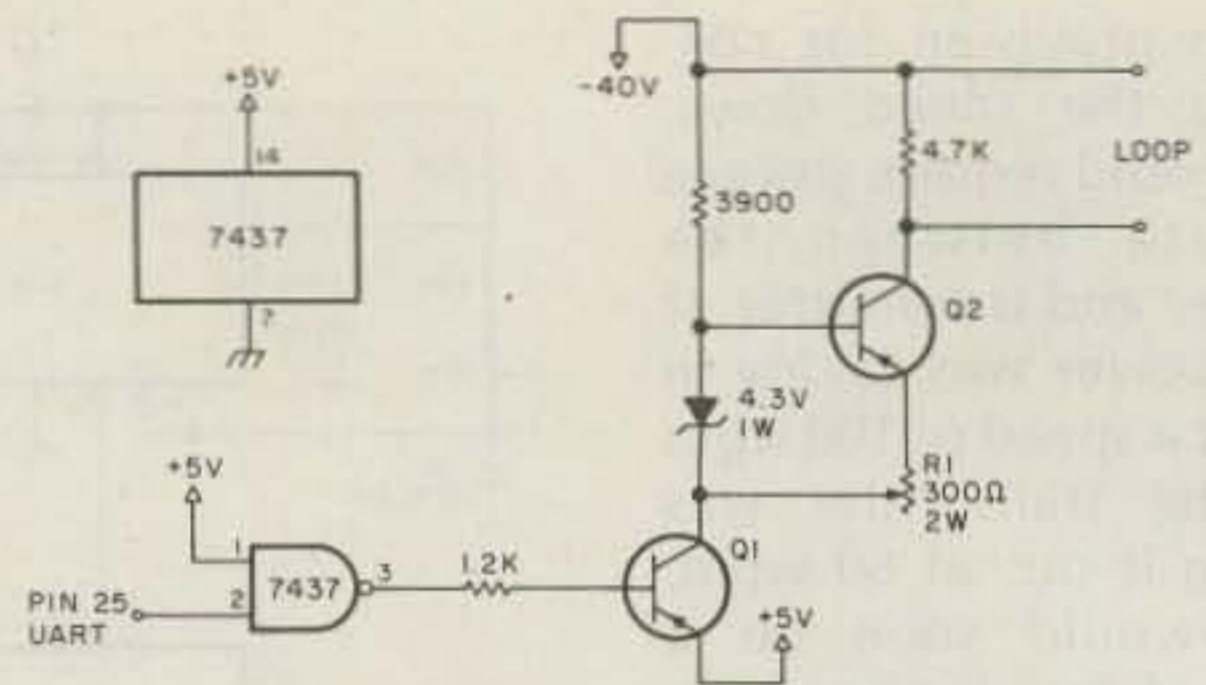

Fig. 5. Output interface.

output loop voltage does drop somewhat, but this has not been a problem with this particular unit. If there was a larger current drain on this supply, then it would be necessary to use a voltage doubler or separate transformer.

This unit was constructed using perfboard and point-to-point wiring. As I usually construct only one each of my projects, it has been much more convenient to use perfboard. It is also a lot easier to modify the unit when getting the bugs out, or when adding on or improving. The layout is not critical and any convenient method is acceptable.

Operation of the unit is relatively simple. On installation, check all power supply voltages to be sure they are correct. I did have a little trouble with the -12 V dc regulator; it oscillated! The addition of the 50 uF capacitor on the output terminal took care of that. Next you will want to connect your terminal unit's output loop to the input of the speed converter, and the printer to the speed converter's loop.

Wire an ammeter in series with the printer magnets. At this time you may also want to wire your printer magnets in parallel. This is what I have done to take full advantage of the low-voltage aspects of this particular loop keyer. I have used the keyer with the magnets in series and it did work; however, it is recommended that you

take the time to wire your magnets in parallel for optimum performance. Set your terminal unit to standby and turn on the speed converter. The loop should have current flowing at this time. Now adjust the 300-Ohm potentiometer, R1, for a loop current of 120 mA. If your magnets are still wired in series, set the loop current to 60 mA. No other adjustments are necessary, although you may need to do some fine adjustments to the timer frequencies for optimum reception at the particular speed.

That's all there is to it. Just set the printer speed to the speed your printer is geared for, ideally 100 wpm, and the receiver speed to the speed of the incoming RTTY signal. Then you can sit back and watch UPI, Tass, Ceteka, Reuters, or any other press service. It's a great way to get the news! ■

References

1. *The New RTTY Handbook*, 73, Inc., 1977. (a) "TU2 Terminal Unit," pp. 29-33; (b) "Watching Waveforms," pp. 39-41; (c) "UART Speed Changer," pp. 153-155; (d) "Speed Converter and Processor Using the UART and FIFO ICs," pp. 113-116.
2. *RTTY Journal*. (a) "UART," I. M. Hoff and H. L. Nurse, April, 1974; (b) "Using the UART," I. M. Hoff, H. L. Nurse, P. Satterlee, Jr., May, 1974; (c) "The Mainline UT-2," I. M. Hoff, Feb., 1975; (d) "The Mainline UT-4," I. M. Hoff, Mar., 1975.
3. ARRL Specialized Communications Manual.
4. Data Sheet, AY-5-1013/AY-5-1013A, General Instrument Corporation, March, 1974.

Yesterday you could admire LED digital tuning in short wave.* Today you can afford it.



Introducing Panasonic's Command Series top-of-the-line RF-4800. Everything you want in short wave. Except the price. Like a five-digit LED frequency display. It's so accurate (within 1 kHz, to be exact), you can tune in a station, even before it's broadcasting. And with the RF-4800's eight short wave bands, you can choose any broadcast between 1.6 and 31 MHz. That's the full frequency range. That's Panasonic.

And what you see on the outside is just a small part of what Panasonic gives you inside. There's a double superheterodyne system for enhanced reception stability and selectivity as well as image rejection. An input-tuned RF amplifier with a 3-ganged variable tuning capacitor for exceptional sensitivity and frequency linearity. Ladder-type ceramic filters to reduce frequency interference. And even an antenna trimmer that changes the front-end capacitance for maximum reception from minimal broadcast signals.

To help you control all that sophisticated

circuitry, Panasonic's RF-4800 gives you all these sophisticated controls. Like an all-gear-drive tuning control to prevent "backlash." Separate wide/narrow bandwidth selectors for optimum reception even in crowded conditions. Adjustable calibration for easy tuning to exact frequencies. A BFO pitch control. RF-gain control for increased selectivity in busy signal areas. An ANL switch. Even separate bass and treble controls. And if all that short wave isn't enough. There's more. Like SSB (single sideband) amateur radio. All 40 CB channels. Ship to shore.



Even Morse communications. AC/DC operation. And with Panasonic's 4" full-range speaker, the big sound of AM and FM will really sound big.

The RF-4800. If you had a short wave receiver as good. You wouldn't still be reading. You'd be listening.

*The ability to receive short wave broadcasts will vary with antenna size, time of day, operator's geographic location and other factors. You may need an optional outside antenna to receive distant short wave broadcasts.

Panasonic
just slightly ahead of our time.

Silence

Groaning Refrigerators

— *check your house wiring*

*William Vissers K4KI
1245 S. Orlando Ave.
Cocoa Beach FL 32931*

Finding and fixing one poor connection in our house wiring sure solved a lot of problems for me. A dangerous potential fire hazard was eliminated. Heavy QRM disappeared. We won't have to buy a new refrigerator, which means a few extra bucks in the ham budget. Our TV has less "hash" on it, which makes the XYL happy. And finally, I learned to never doubt Ohm's Law; it might be trying to tell you something important. It all started a few weeks ago.

Like most wives of radio hams, my XYL, Dorothy,

knows I'm never enthralled when I know that some appliance is getting ready to give up the ghost. So when she told me at dinner a few weeks ago that the refrigerator "sorta groaned" when it started up, I made a mental note that a few refrigerators in the near future could probably kill dreams of a two meter synthesized rig, as our budget couldn't hack both items this year. She also mentioned that another light bulb had burned out in her sewing table lamp. I muttered something about "Yeah, everything seems to be conking out lately."

A few nights later, Dot said, "That light bulb burned out again; maybe you should look at the socket or something." An examination of the socket

and plug seemed to indicate everything was okay, and so I sort of forgot about it.

Well, about a week later, I was told that the bulb had burned out again, and my wife casually said, "When I was sewing this afternoon, it seemed like the light got brighter when the refrigerator came on, and it burned out a few minutes later. I put in a new bulb and it's okay now." I said, "Dear, you probably mean that the bulb got dimmer instead of brighter when the refrig came on, don't you? I think that's the way Ohm's Law works." My XYL has a great respect for Ohm's Law, and she said something about maybe the bulb did get dimmer like I said, but I could see she had a rather puzzled

look on her face.

The very next day, my wife, with a look that implied, "Well, you may know about Ohm's Law, but I know what I saw," said, "I watched that bulb today and it got brighter and then burned out when the icebox came on. And I know the refrigerator was on because I got a glass of milk, and I could hear the motor running. And it sure groaned when it started up."

The burned-out bulb was still in the lamp, sure enough, but where was the high voltage coming from that was apparently blowing the bulbs? Didn't Ohm's Law teach that if a load was applied to a circuit, the IR drop in the line would cause the voltage at the load to drop? And a

drop in voltage sure wasn't going to burn out any lamps.

Suddenly, although the light didn't dawn because the bulb was burned out, my brain jumped into gear. Like almost all houses nowadays, we are on a 115/230-volt three-wire, grounded neutral system. Hadn't I once learned about unbalanced loads and a neutral wire? In some unexplainable fashion, the brain cells said something like this: "How about a resistance in the neutral line?" And no kidding, almost like a calculator with a fresh battery, the old brain started visualizing a few numbers representing Amperes racing around the house wiring.

I couldn't wait for the refrigerator to come on by itself. A new bulb was found. I turned the lamp on and told the XYL to turn the refrig to full cold. She did, and I could hear it groan when it started up. And the bulb really glowed a lot brighter, particularly when the icebox started up. I yelled, "Turn the refrig back down," and as she did and it went off, the light bulb went down to normal brilliancy. Eureka!! The problem was solved, at least from a theory standpoint. There had to be a resistance of some sort in the neutral line. But by now my brain had really warmed up and didn't want to stop. It whispered, "bad connection, bad connection; arcing wires; arcing wires cause noise; noise causes QRM." Could this be true?

For months, I'd been bothered by at times truly excessive QRM that sounded like power line noise. Often it would be 20 dB over. But, living in Florida, just a block from the ocean with power lines in front of and behind the house, you expect line noise and QRM. At times during humid weather when the

spray deposits salt on the pole insulators, you can actually see the corona at night and also often hear the soft accompanying hiss. What you generally do then is wait for a good rainstorm to wash the salt from the insulators, and quickly try to work some DX before the salt builds up again.

By now I could hardly wait. It didn't take long to make voltage load and no load checks in our house wiring system. Sure enough, up in the attic crawl space was a junction box. The neutral wires were so loose that the connector could be wiggled when I pulled on the cable. The wires were black and the insulation was charred where the poor connection had generated heat. It could easily have turned into a serious fire.

The first thing to do was kill the main power circuit breaker and go back up with a flashlight and some tools. *Never work on a hot circuit!* A good cleaning up and tightening job on all of the wires and connectors showed two others that seemed marginal. When I was through, I came down out of the attic and again enlisted the aid of my trusty wife. We made sure the refrigerator was turned off before turning the main power back on. Everything seemed normal. The lamp burned with normal brilliancy. So now when my wife turned the refrig back on, the lamp output stayed the same. And, better yet, the refrigerator came on with a soft purr—no groaning when it started up. My XYL looked at me as if I were a combination of Edison and Einstein. She almost yelled, "Hey, the icebox seems to work fine again; maybe we won't have to buy a new one!" The dreams of a two meter rig got back into focus again. Good old refrigerator!

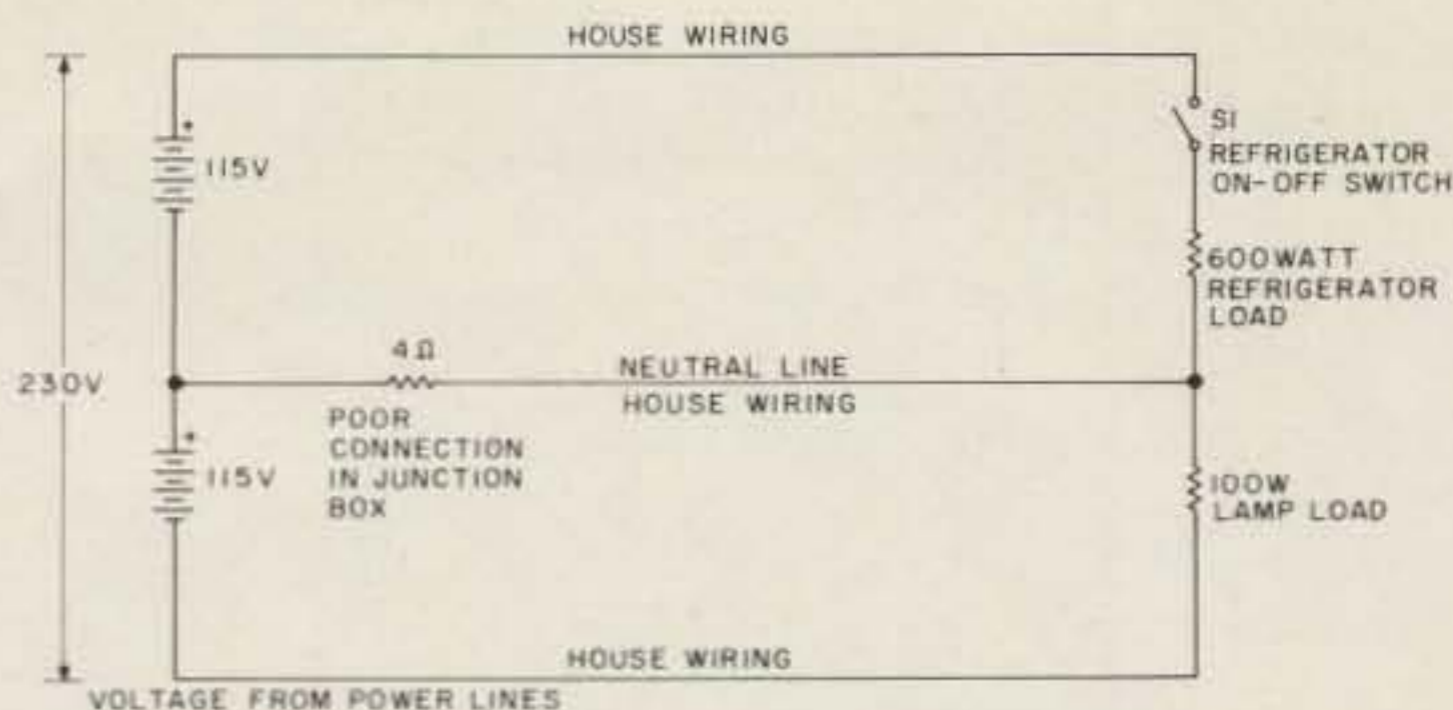

Fig. 1.

Well, now to see how the QRM situation was. I turned on the FT-101-B. At first I thought it had gone dead, it seemed so quiet. Noise was way down, and, although there was some QRM, it sure was a lot quieter than it had been for months. Fixing that one bad connection sure cured a lot of different problems.

After this experience, I talked to some other hams and also to a couple of electricians. It seems that mine wasn't just an isolated hazard, and house fires are often caused by any variety of loose connections. So tighten up and be on the safe side. I was specifically told that oxidation of wires with age combined with cold flow of the metal can cause originally tight connections to go bad. Any heat developed at a poor joint will soften up the metal and speed up the metal flow. It's a vicious cycle. Aluminum wire, because of its relative softness, is generally the worst offender.

A knowledgeable amateur can easily check for loose connections, but in case of any problem, a licensed electrician will do a professional job for you.

Finally, as the behavior of the light bulb seemed so strange when the problem was first discovered, I am presenting a simple three-wire circuit in Fig. 1 to illustrate what happened. Batteries are shown as voltage sources and loads are approximately those that were encountered.

The poor connection is shown as four Ohms in the junction box. Analysis of the circuit shows that when the 100 Watt bulb was in the circuit by itself, the voltage across it was 112 volts. But now when the 600-Watt load representing the refrigerator came on when switch S1 was closed, the voltage across the lamp jumped up to 129 volts. And the voltage across the refrigerator input would drop to 101 volts. As the starting current on an ice box is higher than the running current, it's no wonder it groaned. It was lucky that it started at all.

It is realized that the four-Ohm bad connection would vary in resistance, and even a momentary increase in its resistance could cause an even higher voltage across the lamp and an even lower voltage across the refrigerator input. In fact, the worst possible case would occur if a momentary open occurred in the four-Ohm circuit. The voltage across the lamp would skyrocket to 197 volts. And just imagine what such a surge would do to a small appliance or TV if it happened to be on the line. That is why a poor connection can be a real hazard in many ways. If your lights seem to flicker a bit too much when various appliances come on or off, make a few checks. The house and equipment you save from fire or other damage may be your own. ■

Bargain Preamp

—multiple uses for this one

Lou Dezettel W5REZ
3740 Mt. Rainier Drive, NE
Albuquerque NM 87111

Here is the world's best deal in an audio preamp. It has high input impedance for crystal and other high-impedance mikes. It has low output impedance so it will feed into just about any following amplifier, or even through a long shielded

cable to an amplifier. It uses a minimum of parts and a bargain op amp IC.

The circuit (Fig. 1) is based on the popular 741 op amp, the μ A741. While this number is a Fairchild origination, there are now many manufacturers and it is also part of the HEP line by Motorola, available almost anywhere. The one used in this preamp was purchased on sale from Radio Shack, marked 741C, for only 39¢. The HEP equivalent is Motorola

number C6052G, and it performed identically to the Radio Shack special. I tried the RCA CA3160, but it oscillated in this circuit until I added the 150 pF capacitor across the 1-megohm feedback resistor. The RCA CA3160 is a premium-grade op amp meeting military specifications which is cheap enough for this application. The 741 used is in a round TO-99 case and fits a round 8-pin socket. They are also available in an 8-pin mini-DIP form.

The use of the 741 was ideal for my application because it works so well into a low-impedance load. I am replacing a carbon mike used in an RCA Carphone converted to a 2 meter base station. The input impedance to the converted RCA rig is 1,000 Ohms. I could have removed that part of the circuit and fed a preamp directly into the grid of the first audio stage, but I wanted to retain the carbon mike jack and circuit

for a secondary mike input because plans call for the use of the crystal mike in a different mobile rig.

Measured frequency response of this circuit is 750 Hertz to 9 kHz at the 3 dB down points. This response is the same whether working into an infinite load or 1,000 Ohms, but gain measurements do differ with load. Voltage gain is 150 (43.4 dB) into a 1,000 Ohm load, but somewhat less into an infinite load. The gain of the amplifier is affected by the feedback resistor between terminals 2 and 6 on the IC. The lower the resistor value, the lower the gain. Without any feedback resistor, the gain can be as high as 100,000, which is obviously more than one needs or can handle without instability.

The 150 pF capacitor across the 1-megohm resistor stabilizes the IC against self-oscillation when using the CA3160, and may be omitted for other 741-type ICs. With the capacitor, the

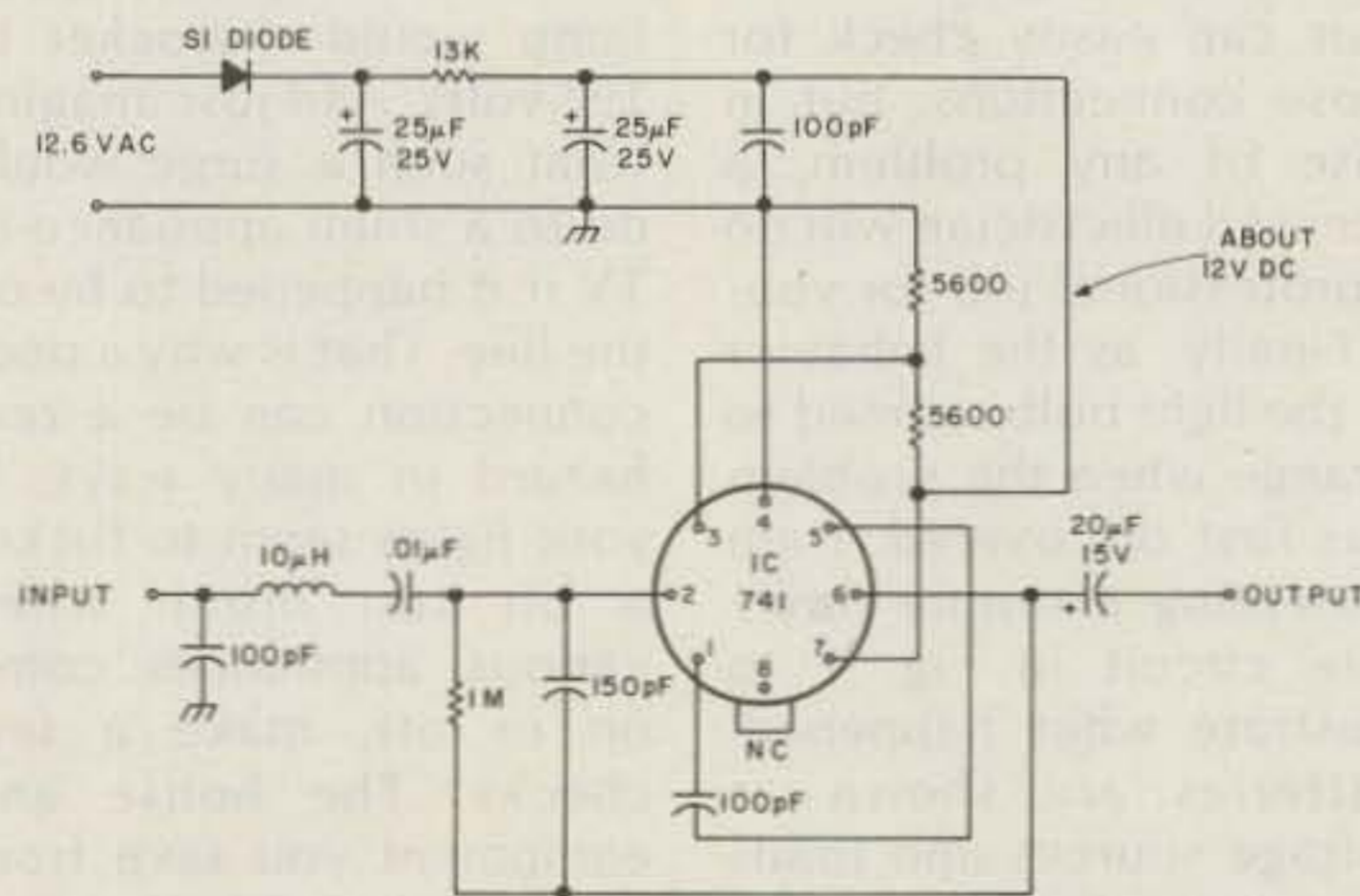

Fig. 1. Amplifier schematic diagram.

CA3160 replaces the 741 directly. The only apparent adverse effect is that it extends the frequency response to well over 100 kHz. There is no apparent effect on performance as, obviously, any response above about 5 kHz is lost in the associated circuitry of the equipment with which this preamp is used. On-the-air reports indicate that the voice is clean and crisp, with no distortion.

Because the preamp was designed for use on a 2 meter rig, the input rfc is only a 10 μ H (Miller #4612) choke. For lower frequency use, a 1 mH rfc is recommended. Also, a carbon 2,000 Ohm resistor might be just as good, but it was not tried.

The rectifier diode may be any silicon diode except small-signal types. The lowest voltage- and current-rated axial-lead diode will do. Other values of electrolytic capacitors than those listed may be used as long as the capacitance values are reasonably high and the voltage rating exceeds the voltage source by a factor of two.

An ac tap across one of the tubes in the rig is the source of the 12.6 V ac. This was convenient. If 9 to 12 V dc is available from other points of the associated circuit, use it. Omit the rectifier diode, but retain the filter to reduce hum.

Current drain is less than

Amplifier Parts List

- 1 741 IC
 - 1 Silicon diode, HEP R0050 or equivalent
 - 3 100 pF capacitors
 - 1 150 pF capacitor
 - 1 .01 μ F capacitor
 - 1 20 μ F, 15V dc electrolytic
 - 2 25 μ F, 25 V dc electrolytic
 - 2 5600 Ohm, 1/4 W resistors
 - 1 13k Ohm, 1/4 W resistor
 - 1 1 megohm, 1/4 W resistor
 - 1 10 μ H rfc
 - 1 8-pin IC socket
- Mike jack, PC board, and parts based on your choice.

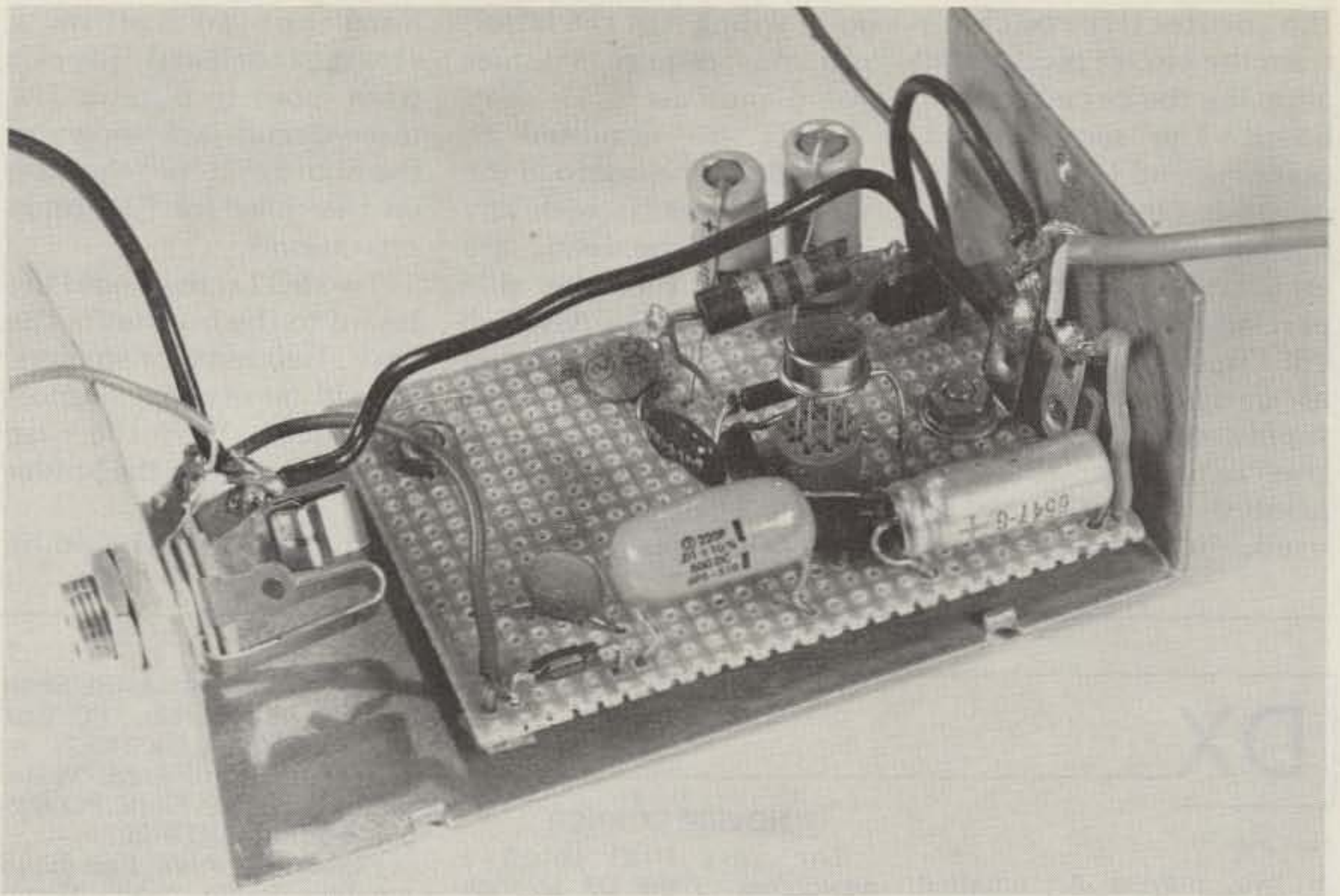

Completed amplifier with cover off 4" \times 2" \times 1½" aluminum case. The glass-epoxy board measures only 2" \times 1½".

.5 mA. A 9 V battery could be used instead of the ac source, and filtering could be left out. The battery would last a long time.

All small parts, including those of the rectifier-filter system, fit easily on a 2" \times 1½" PC board.

The PC board is not an etched-copper board, but a "PC-style" board using Circuitstik stick-on wiring elements. The system consists of pre-made circuit elements such as for transistors, ICs, multi-element connections, wire strips,

etc. These have adhesive backs and a protective backing over that. Their board is glass epoxy with perforated holes in a grid with .1" spacing. The hole spacing matches that of the circuit elements. A circuit is made by stripping

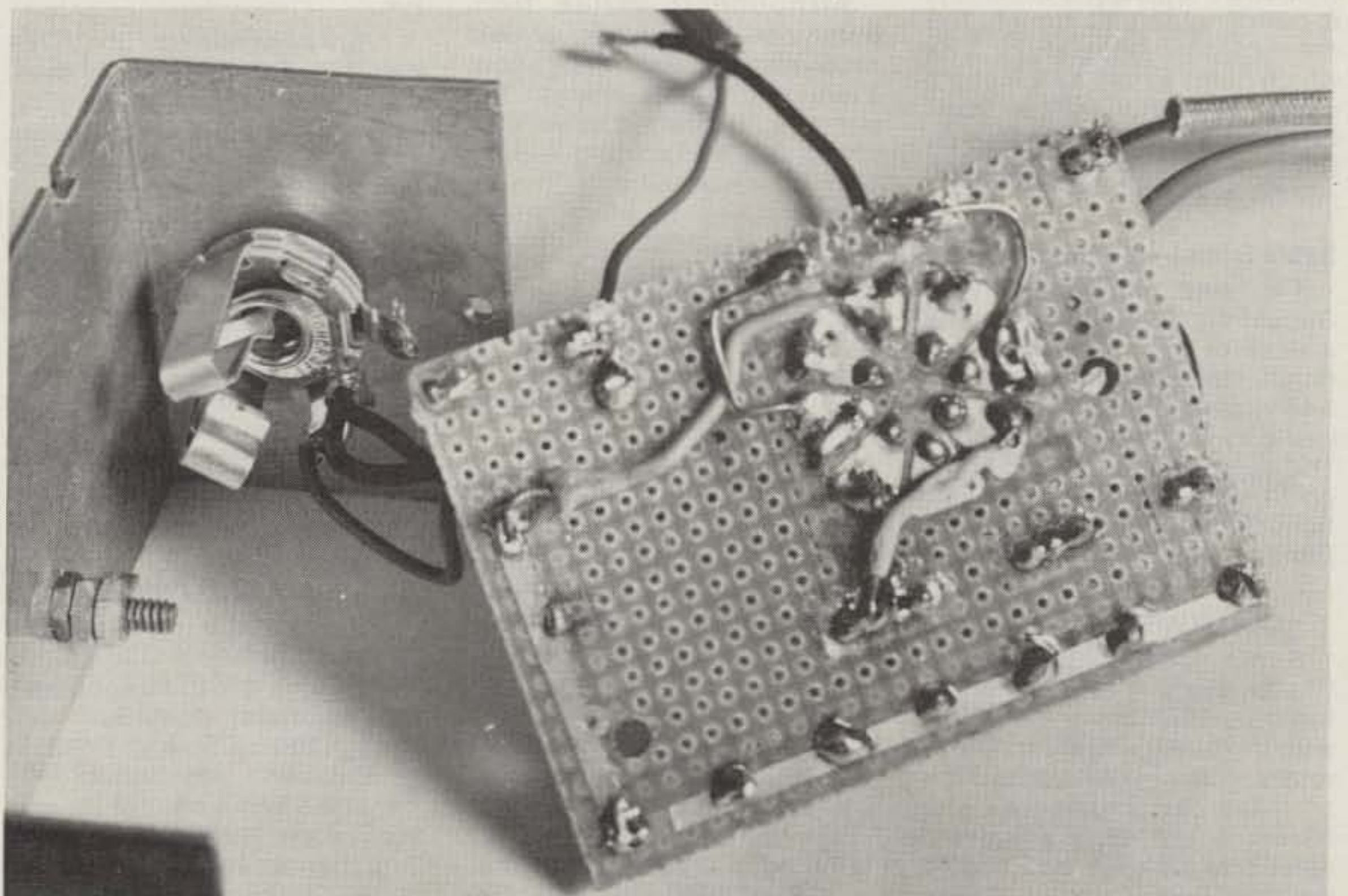

Bottom side of perfboard. The .1"-spaced holes match the Circuitstik wiring elements. It looks and works like etched circuitry, but the wiring elements are stick-on and eliminate etching.

the protective backing from the circuit pieces and applying the circuits to the board. The same circuit planning and layout as for printed circuitry is required, but the need to etch copper from a copperclad board is eliminated. Circuitstik is available at most large electronic supply stores. Of course, the usual etched-type printed circuit may be used, or even point-to-

point wiring. For the latter, you may require a larger board and case.

Parts are mounted to one side of the board in the same manner as with any PC board. The leads are soldered on the other side to the metal circuits, which are solder plated for easier soldering. A few jumper wires are located on the bottom side for convenience. Layout of parts is not critical, but it is pretty

hard not to follow a straightforward layout from input to output. The three-circuit jack shown in the photo matches the plug on the mike for PTT relay operation.

Two 6-32 screws hold the board to the bottom of the case. Two nuts, or spacers, should be used to support the board above the case bottom to clear the solder hills.

Shielded wire should be

used between the output and the input of the associated circuitry, if the distance is more than about six inches.

While the 4" x 2" x 1½" aluminum case into which this amplifier was built is not essential, it does provide good shielding against rf pickup. If the amplifier is made part of its associated circuitry, it may be necessary to add some form of shielding. ■

DX

from page 30

or two, maybe. An amateur could be in that group, maybe. File this one under futures.

Bouvet

Norwegians are planning to activate this one during January. Be prepared!!

Clipperton Island

The group that staged the very successful Clipperton Island DXpedition last March has put together a booklet of the trip. The booklet is soft-bound and runs 120 pages. It has 80 pictures of the operation, two in color, and the text is in both English and French. The cost of the booklet is \$10, which helps to defray the costs of the operation. Order from: Clipperton DX Club, 28 Rue de Savigny, BTA, 91390 Morsang sur Orge, France.

Sable Island—VE1MTA

This one showed early in August signing VGW211. After a week or so of operation and much speculation that Slim was vacationing in Canada, the call was changed to VE1MTA. The operator is Larry and QSLs go to VE1MTA, Upper Air Station, Sable Island, PO Box 40, Elmdale, NS, B0N 1M0 Canada.

CONSUMER REPORTS

Some of the CDR T2-X "Tailtwister" rotors manufactured in 1977 have a problem with the braking system. Those rotors with 1977 stamped on both the carton and the rotor have the old style powdered steel brake wedge and should be modified. Contact Gregg Dodson, the service manager at CDR, for information. The address is: CDR, Fuquay-Varina, North Carolina 27526.

NOVICE CORNER

The very first thing a newcomer to the DX science should do is send some self-addressed stamped envelopes to his district QSL Bureau. For many DX stations, this is the only available QSL route. Although long and slow, sometimes taking two years or more, "QSL via bureau" is a must in many instances. Envelopes should be 5" x 7½" with your call clearly written in the upper left corner in letters about ½" high. Place a single 15¢ stamp in the upper right corner, place the envelopes in another envelope, and mail them to the bureau.

Although it varies from bureau to bureau, you should receive an envelope back about every four to six weeks. The bureaus are staffed entirely by volunteers and sorting is done on a spare-time basis. If your bureau is in your area, volunteer to help. Extra hands are always needed and you get your own cards quicker.

Bureaus identified by a * sell stamped envelopes or postage credits. Send them an SASE for more information.

**First Call Area:* Hampden County Radio Association, Box 216, Forest Park Station, Springfield MA 01108.

**Second Call Area:* North Jersey DX Association, PO Box 8160, Haledon NJ 07508.

**Third Call Area:* Jesse Bieberman, RD 1, Box 66, Malvern PA 19355.

Fourth Call Area (W4, K4, N4): National Capitol DX Assn., Box DX, Boyce VA 22620.

Fourth Call Area (AA4, A4, WA4, WB4, WD4, WN4): Sterling Park ARC, PO Box 599, Sterling Park VA 22170.

**Fifth Call Area:* ARRL W5 QSL Bureau, Box 1690, Sherman TX 75090.

**Sixth Call Area:* ARRL Sixth District QSL Bureau, PO Box 1460, Sun Valley CA 91352.

**Seventh Call Area:* Willamette Valley DX Club, PO Box 555, Portland OR 97207.

**Eighth Call Area:* Columbus Amateur Radio Assn., Radio Room, 280 East Broad Street, Columbus OH 43215.

**Ninth Call Area:* Northern Illinois DX Assn., Box 519, Elmhurst IL 60126.

**Zero Call Area:* W0 QSL Bureau, Aksar-Ben Radio Club, PO Box 291, Omaha NE 68101.

**Puerto Rico:* Radio Club de Puerto Rico, PO Box 1061, San Juan PR 00902.

**U.S. Virgin Islands:* Graciano Belardo KV4CF, PO Box 572, Christiansted, St. Croix VI 00820.

**Panama Canal Zone:* KZ5 QSL Bureau, Box 407, Balboa CZ.

**Hawaiian Islands:* John Oka KH6DQ, PO Box 101, Aiea, Oahu HI 96701.

Alaska: Alaska QSL Bureau, 4304 Garfield, Anchorage AK 99503.

SWL: Leroy Waite, 39 Hanum, Ballston Spa NY 12020.

Canada: ARRL Central QSL Bureau, PO Box 663, Halifax, NS, Canada B3J 2T3.

Remember, stateside stations may send their QSL cards via the bureaus outside the U.S. plus Hawaii and Alaska, but do not send cards via the bureaus located in the U.S. They are for DX cards only.

BITS AND PIECES

In the book on the Clipperton Island DXpedition, Oliver Cado F6ARC has this to say concerning 80 meter operation: "Although the traffic with America on this band was without incident, the same cannot be said for Europe. There was too much impatience and lack of discipline." Jacky Billaud F6BBJ had this to say on the same subject: "...our expedition was European, so we wished to make as many contacts as

possible rather than make the easier contacts with North America... We were lucky indeed... But here again, indiscipline with European stations was a nuisance and our frequency was overloaded with words that should never be heard on amateur wave bands... Now, contrast those statements made by two who were there and have first-hand knowledge of American operating habits with Minute 56 from a recent ARRL Board Meeting: "56). On motion of Mr. Zak, seconded by Mr. Eaton, after discussion, *unanimously* VOTED that the board express its continuing concern over harshful operating tactics and procedures and improper language being heard with disturbing frequency on amateur bands, particularly during rare DXpeditions, and directs the General Manager to undertake suitable educational programs through channels available to the League so that the international image of Amateur Radio is not tarnished and so our stature at international Radio Conferences will be enhanced."

It has been reported that one high official of the ARRL was so upset over the activities during the Clipperton effort that he wanted to cancel all DXCC credit for the operation. Sure, during the heat of battle, especially with an operation like Clipperton or Iraq, things sometimes tend to get out of hand and tempers come to the boiling point. But the American DXer should not be held solely accountable for the actions of a very small minority. Tempers flare on traffic nets and two meter repeaters as well. It is just unfortunate that when one DXer makes an ass of himself, the whole world can hear him. We would do well to keep that in mind...

The ARRL rejected a recommendation by the DX Advisory

Continued on page 217

Cohoon Amateur Supply

NOW STOCKING THE INCREDIBLES



EDGECOM SYSTEM 3000A

- Twenty Memory Channels
- Memory Scanner
- Band Scanner
- Two Priority Channels
- Memory Channel Monitor
- Bargain Price: \$549

- Ten Memory Channels
- Band Scanner
- Any Transmitter Offset
- Full Coverage
- Small/Light Weight
- Only \$439



EDGECOM FMS-25

Both of these outstanding 2m FM transceivers offer you an unbelievable receiver, 25 Watts of power (adjustable), and advanced microcomputer-controlled frequency synthesizer, electronic push-button tuning, any transmitter offset and a FULL TWO-YEAR WARRANTY. Call, write or come in and compare for yourself. Find out why the Edgecom SYSTEM 3000A and FMS-25 are called the incredibles.

**Cohoon
Amateur
Supply**

Hwy. 475 Trenton, Kentucky 42286

502-886-4534

✓ C95

Murphy's Masterpiece

— the lost weekend

Kenneth S. Widelitz WA6PPZ
10405 Louisiana #8
Los Angeles CA 90025

I'd run into Murphy before. Almost every ham has. In my past experiences with Murphy, he has always struck quickly with a single debilitating blow. Aggravating, maddening, depressing, but always challenging, Murphy had always wreaked his havoc on me and moved right on to others. But for one long weekend in July, 1976, Murphy worked his masterpiece, temporarily destroying my spirit as well as a long-planned Bicentennial QSO Party camping trip to Nevada. It is only now, many months later, that I can finally bring myself to relate this saga of seemingly eternal torment.

Can it be that I hear the voice of an uninitiated asking "Who is Murphy?" Murphy (he has many first names, most of which are unprintable) is the ephemeral executor of Murphy's Law. Murphy's Law takes many forms and it has numerous corollaries. The basic law is "Anything that can go wrong will."

Murphy, as executor of that law, is the culprit that

does the dirty work. I can't tell you what he looks like, because I've never seen him in action. No one has. But he always leaves evidence of his visits.

This is a long story and a little background information is necessary. In May, 1976, I moved out of a large apartment complex and into a considerably smaller 10-unit building. The landlady was taken by the XYL and virtually "adopted" her as a granddaughter on first sight. In fact, after she showed us the available apartment, she kissed the XYL goodbye and said, "I hope you take the place." I saw the opportunity to take advantage of their relationship and get permission to put up an antenna on the roof so I could get back on the low bands. When I moved into the large apartment complex, I had traded my low-band gear in on a two meter unit, but I didn't enjoy two meters. I yearned to get back on CW and into some contests. Although she was at first hesitant, after showing her pictures of the proposed antenna, I got a positive response from my new landlady and proceeded to examine the transceiver market.

I decided on a Kenwood TS-520 because it had built-in ac and dc power supplies. It

would be the perfect rig to take along on a camping trip and set up in some rare county for a contest. Contest, did I say? That light bulb that hovers above my head like a halo flashed on — bells rang! The Bicentennial QSO Party was scheduled for July. Even allowing a few weeks for delivery, it appeared that there would be enough time to take advantage of the rig's portable capabilities immediately.

My mind set to work. Where would be the best place to operate from in the Bicentennial Contest? What state does every DX station need to complete its "Worked All States"? Why, that state just across the border — Nevada. "That's it," I shouted. "Nevada!"

"What?" The XYL turned and queried in consternation, "What's Nevada?"

"Margot (the XYL's name is Margot), we're going to take a camping trip to the highest point accessible by car in Nevada," I said. We had been on numerous camping trips before and had all the required gear. The XYL, while enjoying the comforts of home, often had proved to be a surprisingly good camper. I must admit that when we camp, we don't exactly rough it. We always find a

campground with toilets, preferably with hot water and showers. We always sleep in a tent. And none of that prefab food. We always bring a full ice chest containing thick steaks, chicken breasts, etc.

I had never involved the XYL in one of my amateur radio projects before. She had always made other plans on "contest weekends." However, I told her I needed some help on this one and she agreed to go along.

I explained to her about how the new rig should be in just in time for the *big* contest, the Bicentennial Contest, at that. There would only be *one* Bicentennial Contest, and I wasn't going to miss it. In fact, I was going to be on top of it all, the highest point in Nevada, the most-wanted state. The XYL shrugged her shoulders and simply said, "That's nice."

I ordered the rig from a mail-order house in the Midwest in mid-June. Then I turned my attention to the antenna problem. Looking through the want ads in the back of *QST*, I found a Joystick™ for sale very cheap. A Joystick antenna is a copper pole about 7 feet long and ½ inch in diameter. It "folds down" to 2 3-foot lengths, perfect for travel. It comes with a Joymatch™, a

tuning device, and will load up on 80 through 10 meters. The Joystick would be perfect for a field trip. I could operate every band and not have to worry about having to find trees to string up a longwire.

From the Automobile Club's literature, I found the highest campground in Nevada. Lee's Canyon, at 8300 feet, sounded pretty good. The site was picked.

As July approached, I began to wonder if I would be able to make the trip. Despite frequent calls to the mail-order house, the rig had not arrived. The Bicentennial Contest weekend was rapidly approaching. Then, on the Wednesday before the Friday we were planning to leave, the rig arrived. I opened the carton, hooked the rig up to the Joystick and made a quick contact just so I knew that it worked.

I then set about the task of modifying the dc power cable connector so I could run the rig out of the tent but off the car's battery. I had explored the possibility of renting a generator, but dismissed it as being too expensive, too bulky, and a potential target for Murphy. I had forgotten about voltage drops and those kinds of considerations, and was shocked when the guy behind the counter at Henry Radio told me I would need #8 wire and that it would run around \$15 for the cable alone. It was quite a job securely soldering #8 cable to a very small pin on the power connector. It was considerably easier hooking the other end of the cable to some large-sized battery clips stolen from a jumper cable.

Putting together the cable and loading the car with the camping equipment took me right up to 11:30 pm Friday evening, our time of departure. My plan was to drive all night, arriving at the campground at dawn's early light. That would give me first choice at a prime site and allow time for a few hours' sleep in addition to setting up

the rig and tent.

After checking a second time that I had everything and that it was securely packed, I hopped in the "Beady Eye." The "Beady Eye" is the XYL's solid, dependable and reliable 1970 grey Monte Carlo with a peeling black vinyl roof. The "Beady Eye" derives its name from its license plate, "976 BDI." The "Beady Eye" had taken us 8500 miles on a cross-country camping trip the summer before. While a rock had been kicked up and had cracked the windshield, and despite driving for one 36-hour stretch, the "Beady Eye" performed magnificently.

This night, however, when I switched on the ignition, a strange thing happened. The radio and the windshield wipers wouldn't work. It seemed to me it was pretty obvious what was the matter. A fuse had blown. It took us a few minutes to find a gas station that was open. I pulled in, found an attendant, stopped the car, and told him the problem. He suggested I pull the car nearer the station where the light was better so he could take a look. I started the car and all of a sudden the radio came on. I turned the windshield wiper switch and they started swishing across the windshield. "Well, that's Murphy's Law," I casually remarked to the gas station attendant. He shrugged his shoulders and we headed out on the freeway, barely 20 minutes behind schedule.

Lee's Canyon is located about 40 miles north and 20 miles west of Las Vegas. We rolled into Vegas at about 5:00 in the morning. There wasn't even the hint of sunrise on the horizon so we decided to gamble a little, grab some breakfast, and then be off.

The XYL and myself aren't what you would exactly call big gamblers. We each sat down at the blackjack table with \$20. Five minutes later we each got up

with \$0. We had never both lost 10 straight hands before. Nevertheless, I wasn't exactly shocked.

We had some breakfast and got on the road again, heading north out of Vegas. We reached the Lee's Canyon cutoff just as the sun came over the mountains. About 10 minutes after making the turn, I smelled some gasoline. I had bought two 5-gallon gas containers because I knew I would have to run the car while running the rig off the car battery so as not to let it completely discharge. I figured that the extra 10 gallons, plus having filled up in Vegas, would easily cover idling the car for an hour or so every other hour during the contest.

When I smelled the gas, my first thought was that the top on one of the containers was not as secure as it should be. I pulled over to the side of the road, opened the trunk, and found that, sure enough, just a little gas had spilled. Not even enough to damage any of the camping gear. I repacked the gas containers to make sure that a further leak would do minimal damage and started to get back into the car. As I was slipping behind the wheel, I heard a loud sound, not at all unlike a balloon popping. That sound was immediately followed by a strong, consistent hiss. Steam started pouring out from under the hood. Margot and I quickly jumped out of the car and opened the hood, only to see the steam whistling out a dime-sized hole in the radiator hose.

To say that we were in the middle of nowhere would be entirely accurate. We looked at each other forlornly. "Oh, no! We're in the middle of nowhere. What are we going to do?" moaned Margot. I was pretty upset myself, to tell you the truth. We hadn't seen a car since we made the turn on the cutoff, some 10 miles back. Then that light bulb went off again.

"Here I come to save the

day," I sang in Mighty-Mouse fashion. "I'm an amateur radio operator, Margot. I'll just fire up the rig and call for help. No problem!"

"My hero," crooned Margot as she held her hands to her fluttering heart.

I pulled the card table out of the trunk and started setting up my station by the side of the road in the middle of the desert. Fifteen minutes later I was ready. I plugged the coaxial connector into the back of the rig, stuck the battery clips on the car battery, and flipped the big switch. The rig was getting power, but all I heard was the receiver's hiss. It was like I had no antenna. I started to unscrew the coaxial connector. Just as I got the shield off, all of a sudden the rig came to life. I felt about two inches tall. In my haste in preparing the connector, I had done a poor soldering job. In being rolled up, the foot-long coaxial connector between the rig and the Joy-match had shorted. I wasn't going to be able to save the day. Beyond that, even when help came, how was I ever going to get on the air? I didn't have a soldering iron in the tool chest, let alone ac to use it. I was more concerned with that problem than with "being rescued" from the middle of nowhere.

After realizing that amateur radio was not going to help, I took a closer look at the hole in the radiator hose. Fortunately, it was only about 3 inches from the end of the hose. I pulled out a knife and cut the hose off just to the side of the hole. With a little bit of stretching, the remaining hose was just long enough. Now the only problem was that there was no water in the radiator. About that time, the first car that we had seen in an hour rolled by. It was a fellow in a pickup truck heading to work on a construction project in Lee's Canyon. He had some water in the truck. He also told me that there was a youth camp with an adequate

workbench up the road. He thought they had a soldering iron there. That was good news, indeed.

Just before the youth camp was a ranger station where I filled up the radiator and rechecked the success of my hose operation. Then we went looking for the youth camp. The fellow in charge of the youth camp was friendly and immediately agreed to allow me to use the workshop so I could fix the shorted cable. Five minutes later, that was done. Our attention then turned to finding the best location. At the youth camp we found out that Lee's Canyon is a ski area and that the ski lift operated during the day. That made me very happy. I imagined myself operating from the top of the mountain by stealing power from the ski lift. The XYL was less optimistic. "I'm not going to camp up there if they don't have bathrooms," she flatly stated.

By this time, it was about 9:00 in the morning. The ski lift was supposed to start operating at 10:00. We decided we would drive to the base of the ski lift and ask the operator, when he arrived, if there were bathroom facilities at the top of the lift. On the way up to the ski lift, the car overheated again. I opened the hood and found that I had forgotten to put the radiator cap back on, so it was back down to the ranger station for more water, and then back up to the ski lift.

Margot wasn't exactly disappointed when the ski lift operator told us there were no bathrooms at the top. She really didn't want to spend the night at the top of the mountain.

We headed into the campground and found a good location. As soon as the tent was erected, I was up in the trees. No sooner was I up in the trees than I was the center of attention of a dozen very young, very wondering eyes. I somehow got the feeling they were waiting for me to fall. Margot's constant

exhortations of "be careful" kindled the little group's excitement. It had been many years since I had climbed trees to put up antennas. Although somewhat scraped and cut up, I got the Joystick hung over one of the top limbs of a pretty good-sized tree. I finally got the station set up and then it was time to make a quick test QSO, and catch some sleep.

With many little kids crowded into the tent, I began to tune up. It was immediately obvious that I had problems. This time it appeared to be a short in the cable between the keyer and the rig. In coiling the cable for the trip, it, too, had shorted. So now it was back to the youth camp and another repair job. By the time I finished, it was the middle of the afternoon and I began to realize that there wasn't going to be much of a chance for a nap. I decided I'd just get in a quick QSO to check the installation, and then try to relax a little bit.

Tuning up was not exactly a breeze. I had only tuned the rig up once before. Now I was tuning up using the dc supply for the first time and with a different antenna. Needless to say, now, many months later, I can virtually tune up the rig blindfolded. That was not the case with the then new rig. Tuning that thing up under those conditions (with six little kids hanging all over me and asking all kinds of questions) started to get my dander up. The 349 signal report I got from Iowa didn't cheer me up at all. In fact, I was getting pretty depressed. After that report, I finally realized that I was, in fact, *in* the canyon portion of Lee's Canyon. Walls a thousand feet high surrounded me on three sides. I may have been at 8300 feet, but the summit of the ski area was 9300.

By this time, it was getting to be 4:00 in the afternoon. The contest was scheduled to start at 5:00 local time. I hadn't had a chance to sleep and I hadn't eaten since

Vegas. So I started a charcoal fire while the XYL seasoned the steak. I had a chance to relax for the first time during the day.

Just as the smell of the barbecuing 2-inch thick sirloin steak began to remind me how long it had been since I had eaten, the skies opened and it began to rain. No, it was doing more than raining, it was pouring, teeming, etc. The charcoal fire went out within 5 minutes.

The contest began. The tent started leaking. An hour went by and I had managed only six contacts. On the drive up, I was sure I would get 1776 QSOs operating in Nevada. I was tired, hungry, and totally disgusted. The XYL pulled a bottle of wine out of the ice chest and the contest was over. We decided we'd leave the first thing in the morning and spent the evening commiserating over my bad luck.

It stopped raining some time during the night and we quickly broke camp at dawn. I was out of the contest. The weekend was totally ruined. Little did I know that Murphy was not finished with me yet.

After two minutes on the road, the temperature light lit up bright red. It was like that for the entire next hour back to Vegas. The XYL was virtually panic-stricken. Even the "Beady Eye" breathed a sigh of relief when we pulled into a gas station in Vegas. It just so happened that the gas station was across the street from the Holiday Casino, one of the "more casual" places on the Strip.

The mechanic told us that the overheating on the way back had been caused by a problem with the fan. He said it would take a little over an hour to fix. Margot had had enough blackjack at breakfast the previous morning, but I hadn't. I sat down at a table and, after a few hands, settled into one of the greatest streaks that I've ever had in Vegas. As I said, I'm no big

gambler. My betting strategy at blackjack is to leave up half of my winnings until I lose, then I go back to my base bet of \$2.00. You figure you have to lose your biggest bet.

As I said, things went quite well at the tables. I pulled 8s to my 13s and tens when I split aces. I guess I had about \$200 on the line when I finally lost. In any event, I figured I had won about \$300 which certainly would cover the cost of the trip, including the car repairs.

I really don't know much about radio, but what I know about radio is considerably more than I know about cars. I won't begin to describe what the mechanic told me was wrong because I really didn't understand then and don't remember now. The bottom line was that the bill came to \$175. Easy come, easy go.

At least we were back on the road. That was short-lived. We pulled into a gas station in Barstow, the midway point between Vegas and Los Angeles, for gas. When the attendant opened the radiator to check the water, he found there was nothing there. Evidently, the problem with the fan had not caused the overheating. Rather, it was a hole in the water pump. It looked for a while like we would be stuck in Barstow for the day, but somehow the mechanic there came up with a temporary solution. At least it was good enough to get the "Beady Eye" hobbling home.

Well, that was Murphy's Masterpiece. He struck often that weekend, and in every vulnerable spot. No, you say. You *did* win some money in Vegas. Yes, I say. But the total of my automobile repair bills from Vegas, Barstow, and back home just coincidentally equalled the entire amount that I had won. Coincidence? No, just Murphy's way of letting me know that my winning at blackjack was not a victory over Murphy. ■

TWO OF THE THREE BEST THINGS IN LIFE COME FROM EDGECOM . . .



SYSTEM 3000A

Featuring: Twenty front-panel-programmable memory channels . . . Memory channel scanner . . . Band scanner . . . Two priority channels . . . Any transmitter offset . . . Full coverage (144-147.995 MHz) in 5 kHz steps . . . Memory channel monitor . . . Advanced microcomputer-controlled PLL synthesizer with electronic push-button tuning . . . Extraordinary receiver with five-pole front-end and ten-pole IF . . . 25 Watts output (adjustable) . . . MARS/CAP coverage optional (142-150.99 MHz) . . . Small, light weight . . . Full TWO-YEAR WARRANTY . . . An incredible bargain at \$549.

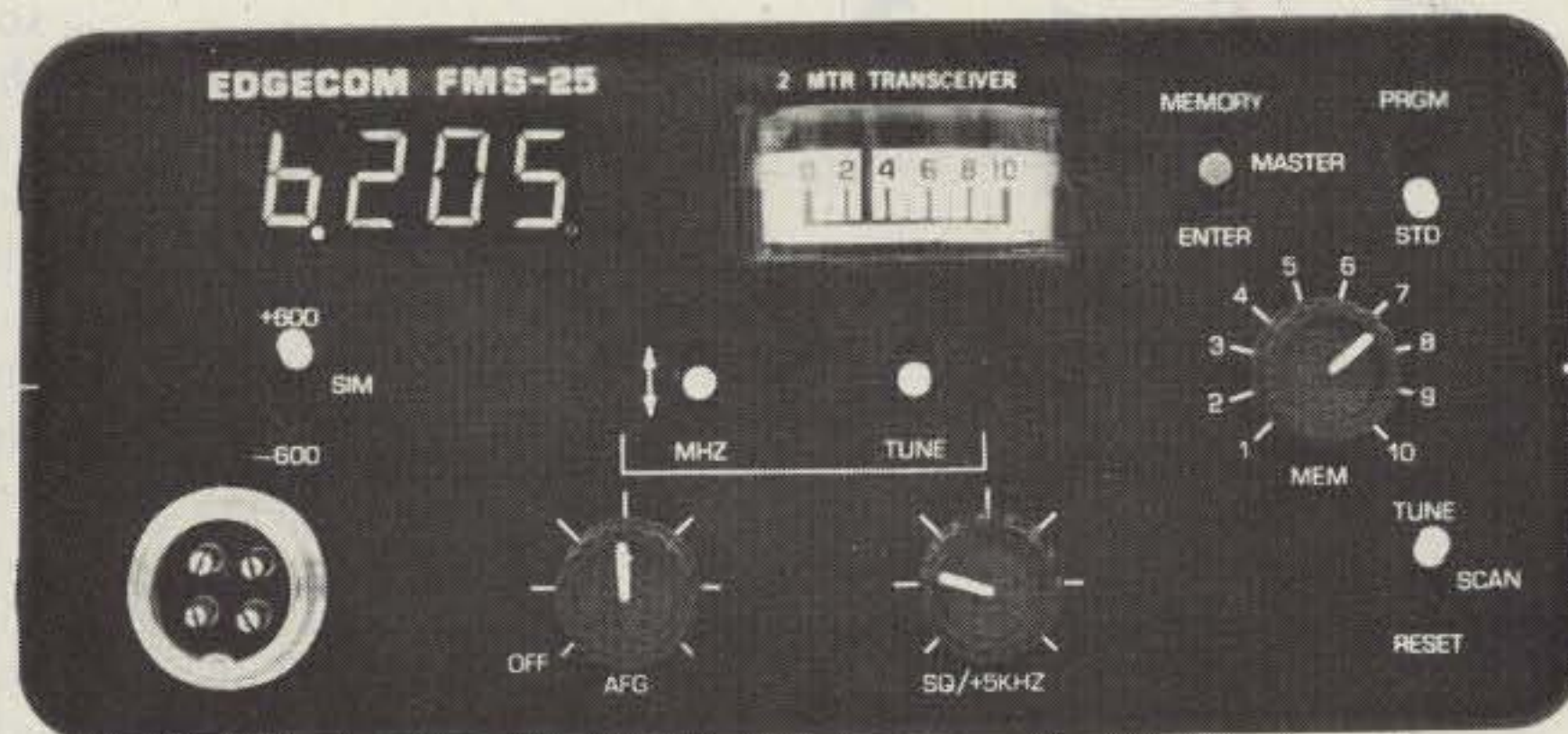

FMS-25

Features: Ten front-panel-programmable memory channels . . . Built-in band scanner . . . Any transmitter offset . . . Full 144-147.995 MHz in 5 kHz steps . . . Advanced microcomputer-controlled PLL frequency synthesizer . . . Electronic push-button tuning . . . The same fantastic receiver and transmitter as System 3000A . . . Full TWO-YEAR WARRANTY . . . Low price: \$439.

SYSTEM 3000A/FMS-25 . . . PERFORMANCE TO CHALLENGE YOUR IMAGINATION

See them at selected dealers or write for more information.

Edgecom Inc. ✓ E19

2909 Oregon Ct—A3, Torrance CA 90503 (213) 533-0433

How About Some Ham Shack Safety?

— *don't be a statistic*

I am a professional fire-fighter. I have seen the death and destruction that a fire can bring. I've seen dead bodies and the charred ruins of homes.

In your wildest imagination, can you conceive of a man breaking into your home and taking every single possession that you own? Probably not. But a fire can. Can you imagine a person coming into your home and murdering every member of your family, including the family pets? Again, probably not. But a fire can. It happens all the time.

My purpose in writing this article is to point out some dangerous practices and recommend some things that you can do to protect yourself, your family, and your ham shack.

I have been a ham for over twenty years, and in that time, I have done some crazy things. Things that I shouldn't have or wouldn't have done if I had just stopped to think. We all do dumb things sometimes. Sometimes in our anxiety to finish a linear or string up an antenna, we don't stop to consider the dangers that are lurking there. It's such a bother to have to turn off the power while you reach into the high-voltage compartment to get that screwdriver that you dropped there. It's so easy to just throw that dipole antenna up and over the top of your power lines coming into your home. Sometimes these things are so very easy to do; we just don't think about the possible consequences.

Fire — Who, Me?

On the average, there are \$11 billion in wasted resources, 300,000 people injured, and 12,000 lives lost each year to fire.¹ A large part of this is caused by carelessness, especially the smoker's carelessness.

But that's alright, because it will never happen to you—right? We all see pictures in the paper of bad fires and we read the stories about them, but it's all so impersonal and far away. Right?

I can well imagine that the 12,000 people who died last year felt exactly the same way. It would never happen to them. The same goes for the 12,000 who will perish this year. And the year after. It can happen to you.

As I said, the smoker's carelessness is a big cause of fires. So is defective heating and electrical devices. Firefighters constantly find pennies in fuse boxes and 30 Ampere fuses where 15 Ampere fuses belong. We find trash and flammable liquids stored near furnaces, overloaded electrical circuits, gas water heaters improperly vented, and clothing placed against baseboard or wall heaters. All these can and do start fires.

Hmmmm... how does that power cord on your ten-year-old VTVM look? Frayed cords can easily start fires. They start the kind of fires that sit and smolder in a rug or along the back of furniture. As they smolder they produce carbon monoxide and other toxic gases. These gases are the real killers in fires. Most people die in fires from these poison gases, without ever seeing the flames. They are dead long before the flames ever get to them, totally unaware of their presence. Well, if this is the case, what is there to do?

Fire Protection

Cheer up! There is one definite and positive thing you can do for your home or ham shack to protect you from the danger of these poison gases, smoke, and fire in general. Purchase a smoke detector.

A smoke detector is the cheapest and best insurance against fire that you can buy. It's a silent sentinel, on duty 24 hours a day, guarding you and your family from the ravages of fire. Detectors are now available almost everywhere. They can be obtained wired for 110-volt house power, as is usually used in new home construction, or battery-operated for existing buildings. There are several different types and over 50 different brands, but you can't go wrong as long as you get one that is capable of detecting gases and smoke.

Just what does this device do? It gives a loud warning the first instant it detects a sign of ionized particles, by-products of combustion, or heat and smoke. It gives you an early warning that you have a fire. It gives you time to get out of your home. It's worth every penny it costs and I personally know several families who owe their lives to a smoke detector.

The value of the device is obvious. The cost is minimal. I would urge you to get one and install it on the ceiling or high on the wall of the hallway that leads to your bedroom. Or just outside the bedroom itself. With this type of protection, you can rest assured that if a fire should break out in your home, you will have the earliest warning that is possible.

What To Do in a Burning Building

There are three general rules to follow if you find yourself in a burning building. The first is *get out!* If you see, smell, or hear any hint of fire, evacuate your family immediately, but don't attempt a rescue through a wall of flames or thick smoke. Call the fire department as soon as possible.

Don't attempt to extinguish a fire unless it is confined to a small area and your extinguishing equipment is equal to the task.

Secondly, before opening a door when you suspect fire in another part of a building, feel the inside of the door with the palm of your hand. If it's hot, don't open it. Summon aid, if possible, and go to a window and await rescue. If smoke is pouring into the room under the door, stuff bedding or clothing into the crack.

Lastly, if you *must* go through smoke, keep low. Gases, smoke, and air heated by the fire rise, and the safest area is at the floor. Cover your mouth and nose with a damp cloth if possible. Don't assume that clean air in a fire situation is safe to breathe. It could contain carbon monoxide, which, before it kills you, affects your judgment, hampering your escape.

Also, if your clothing should ignite, roll over and over on the ground or floor. Running will just fan the flames. Teach this proper procedure to your family.²

The Awesome Power of the Lowly Electron

One of the first things that the military teach their electronic repairmen is to remove all rings and wristwatches when they work on equipment. Boy, is that ever a good idea. It only takes one time to experience the thrill of having your hand become a better path to ground than the ones designed into the radio before you begin to appreciate such procedures. And that can be lethal. Every now and then I hear of a ham or a CBer who has electrocuted himself while working on equipment; it's very, very sad. And needless. Please don't let that happen to you.

I'll never forget the time we were called out on a rainy cold winter night because a 110,000-volt feeder line to our city had broken. As we approached the scene, the entire area was lit with a weird and eerie light. The feeder had broken in the middle, and the hot end was dancing a deadly dance of sheer power. Pink and white sparks were thrown everywhere as the wire writhed like a snake in its death throes. The main circuit breakers had failed to open and for twenty minutes we watched the unearthly scene until the power company finally arrived to cut the power. The next day I returned to the area and found holes, two and three feet in diameter and equally deep, burnt into the ground. The power that electricity has is awesome.

This power was brought home to me in a very personal way the day I melted my 75 meter dipole on the power lines feeding my home. I was aware of the danger of the lines, but I had taken precautions and had engineered my dipole so that I could raise it, carefully, over the top of the power feedline. (In retrospect, I can say don't ever do this!) All was going well until a support rope slipped out of my fingers and the whole thing came down on top of the power lines. There was a loud pop, a torrent of sparks, and suddenly the wire had been melted in two. A close examination of the number twelve copper-weld showed that the ends of the wire had truly melted. The ends were beaded into little balls. Copper melts at around 2,000° F.

The majority of house drops in the country are three-wire drops. If you look at them closely, you will see that they consist of two insulated wires (the hot ones) and a multistrand

cable (ground). However, that ground is not an earth ground! Induction can generate much current in that bare cable. Whenever you are doing antenna work, please pay attention to your power lines and be aware of the potential that is there. Don't ever connect an antenna to a power pole, and don't run antennas over the top of power lines. Watch out for tower guys, too. Don't leave an antenna connected to equipment while you are working on it.

While we are on the subject of antennas, let me tell you about another dangerous thing I did once. I had always wanted a good DX antenna to get into South America on 40 meters (I still do). One day I designed a three-element inverted vee wire beam which was to be strung over the apex of the roof. (This was before I ever became a firefighter, but still is no excuse.) I constructed it and placed it in service. Not only did the copper wires lay along the roof, but the ends extended down to the ground where any child, dog, etc., could accidentally come into contact with them. This was an extremely dangerous and foolish thing to do. No amount of DX is worth that kind of risk. I came to my senses and removed it the next day. I never calculated where the voltage and current peaks were, but I know that if I hadn't set the house on fire, I would surely have given someone a bad rf burn. Even wires extending through limbs of trees can be a fire danger in dry weather (besides skyrocketing your swr).

Please take care with open wire feeders, too. Use lots of standoff insulators and check the feedline periodically to make sure it hasn't sagged against the side of the house.

In the ham shack, common sense should prevail. It always seems that the quick little time-saving things that you do are the things that can lead to trouble. Like the time I adjusted the neutralizing capacitor of my 500-Watt rig without removing the case. I simply reached my screwdriver through the high-voltage housing to the capacitor. I didn't want to take the time to remove the case. And I learned the hard way. The screwdriver touched the side of the high-voltage cage (even though I was trying to be careful) and B+ went to ground. That lesson only cost me a fuse. I was lucky!

There are some things that really help as far as safety goes around the ham shack. Three-prong plugs (with a chassis ground) are great. A rubber mat on the floor of your work area helps to insure that you aren't going to end up a giant path to ground, from your fingers to your toes. A master power switch, one that will kill all power in the ham shack, and one that all members of the family are aware of, is a good thing to have. And a fire extinguisher isn't a bad idea, either. Let's quickly talk about fire extinguishers.

Fire Extinguishers For the Home

Fires are classified in four different categories—A, B, C, and D. Class A fires are fires in ordinary combustibles; wood, paper, and electrical wire insulation also falls into this category. Class B fires are in flammable liquids, gases, and grease. Class C fires are in energized electrical equipment. And Class D fires are those that involve combustible metals—magnesium, sodium, potassium, and zirconium.

Fire extinguishers are

rated with a number and a letter designation which indicates which types of fires they are effective for. The letter indicates which type or class of fire, and the number indicates the relative effectiveness.³ If you are shopping for an extinguisher, a 2½-lb. dry chemical with a tri-class rating (A, B, and C) is a good choice for a ham shack, your kitchen, or your car.

A tri-class extinguisher such as this would be effective in putting out fires in all three of its classes.

One thing to be aware of is that even though a Class C fire is electrical in nature, it is essentially a Class A fire involving energized electrical wiring; once the power is turned off, you have a Class A fire entirely. Please don't ever put water on an electrical fire while there is still power hooked up, lest you go to meet the Creator far in advance of His having planned for your arrival.

The Shocking Power of Lightning

Having been born in the midwest, I can well appreciate the thunder and lightning storms that abound in that region. We only get maybe one good lightning storm a year out here on the west coast. But that doesn't mean you shouldn't be prepared for it when it comes.

Two years ago, a brand new house was almost destroyed during a lightning storm in our area. Lightning struck the power lines coming into the home and every electric power-consuming device inside was destroyed—all appliances, radios, clocks—everything was damaged. The house wiring was completely gone and a portion of the house itself had to be rebuilt. Lightning is nothing to fool with.

You should be able to disconnect and ground all

antennas quickly. And by grounding I don't mean some dinky little wire. You should have the biggest ground strap that you can find. And it should run, in the shortest length possible, to the best cold water or ground connection that you can manage. When that storm comes, quickly turn everything off, disconnect and ground all antennas, pull all the plugs, and join the family (they will probably want you around).

In Summary

I have confessed to you some very stupid things that I have done. Laugh at them, as I do myself (with a shudder), but please remember them. Remember also the rules for getting out of a burning building:

- Don't go through thick flames or smoke.
- Feel all doors, and if hot, don't open them.
- If you *must* go through smoke, keep low.

Remember, too, that a smoke detector is the best insurance for the lives of you and your family that you can buy. They are saving lives and property all over the nation.

With the use of common sense, a high esteem for the destructive power of electricity in all forms, and a wary eye on housekeeping and electronic service practices, you will, I trust, live a long and full life. I hope never to have to see you in a professional capacity. Good luck and safe hamming! ■

References

1. *America Burning*, The Report of the National Commission on Fire Prevention and Control, p. 111.
2. *America Burning*, "Fire Dos and Don'ts," p. 115.
3. National Fire Codes, Vol. #8, "Portable & Manual Fire Control Equipment," p. 10-6.

IF YOU HAVEN'T USED EDGECOM EQUIPMENT, YOU JUST HAVEN'T LIVED

SYSTEM 3000A

- 20 Memory Channels
- Any Transmitter Offset
- Memory Scanner
- Band Scanner
- Two Priority Channels
- Memory Channel Monitoring
- Only \$549



FMS-25

- Ten Memory Channels
- Band Scanner
- Any Transmitter Offset
- Full Coverage
- Low Price: \$439

Both the System 3000A and FMS-25 provide you with an extraordinary receiver (five-pole front-end, ten-pole IF), 25 Watts of output power, advanced PLL synthesizer with electronic push-button tuning, small size, light weight and a full TWO-YEAR WARRANTY. Call, write or visit us for more information on these incredible 2m transceivers from Edgecom. It's time you really started to live.



**VHF
COMMUNICATIONS** ✓ V18

915 N. MAIN ST. JAMESTOWN NEW YORK 14701

[716] 664-6345

Head 'Em Off at the (High) Pass

— *improved filter design*

Paul Zander WB6GNM
86 Pine Lane
Los Altos CA 94022

A while ago, I had some TVI (television interference) due to front-end overload on the TV set. It should have been a simple matter to connect a

high-pass filter to the TV, but things did not work out that way.

First, I went to the local radio parts store to buy a filter. The increased activity of CB had increased the demand for filters beyond the dealer's ability to keep them in stock and they were not available. The next shipment was not expected for three weeks. I didn't want to wait that long.

When I got home, I opened my copy of *The Radio Amateur's Handbook* to the section of high-pass filters. I whipped-up a filter following the circuit I found, and put it on the TV. The interference was substantially reduced, but not eliminated.

I reasoned that if a sim-

ple filter was good, a more complicated filter should be better. I added more sections to the filter, but the interference remained the same. I tried various formulas for calculating the coil and capacitor values and built several more filters. They all worked the same. I then spent a lot of time looking elsewhere for the cause of the TVI. Finally, I removed the filters from the TV and took them into Hewlett-Packard, where I work, and measured the filter characteristics. I found the cause for the difficulty and designed an improved filter.

The key to this problem is that there are two modes in which signals can travel down the feedline of a TV set. One of these is the

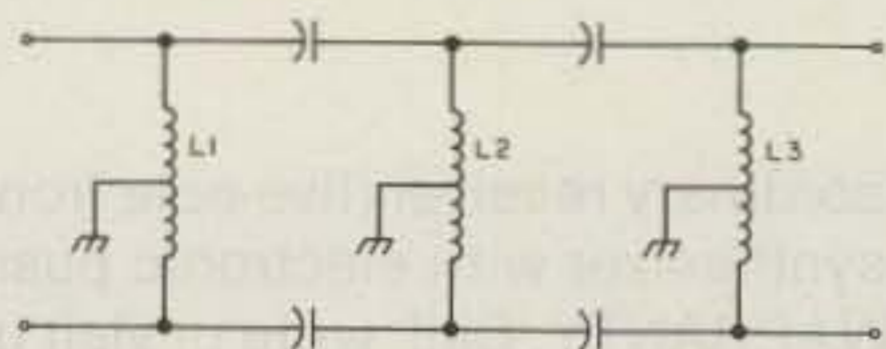

Fig. 1. Handbook high-pass filter schematic.

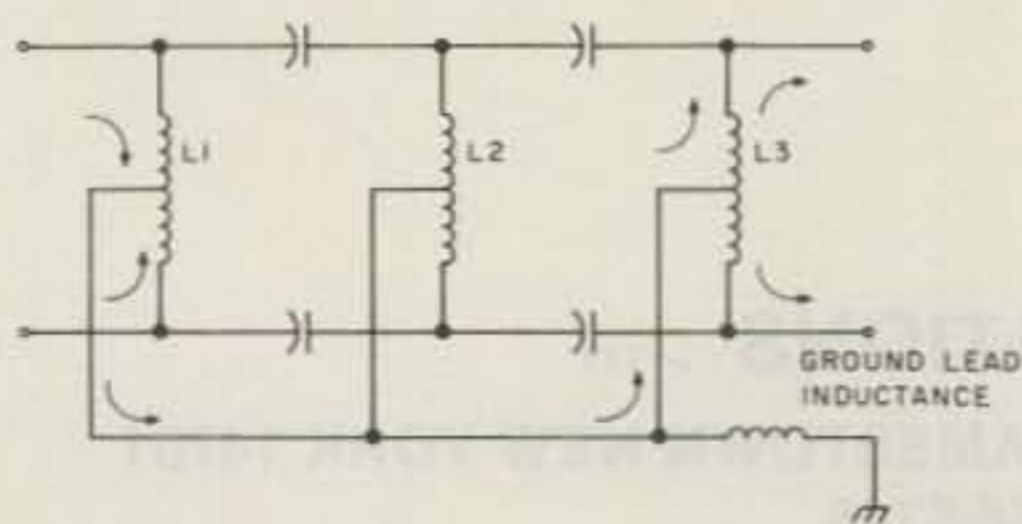

Fig. 2. Handbook high-pass filter schematic with non-ideal ground connection.

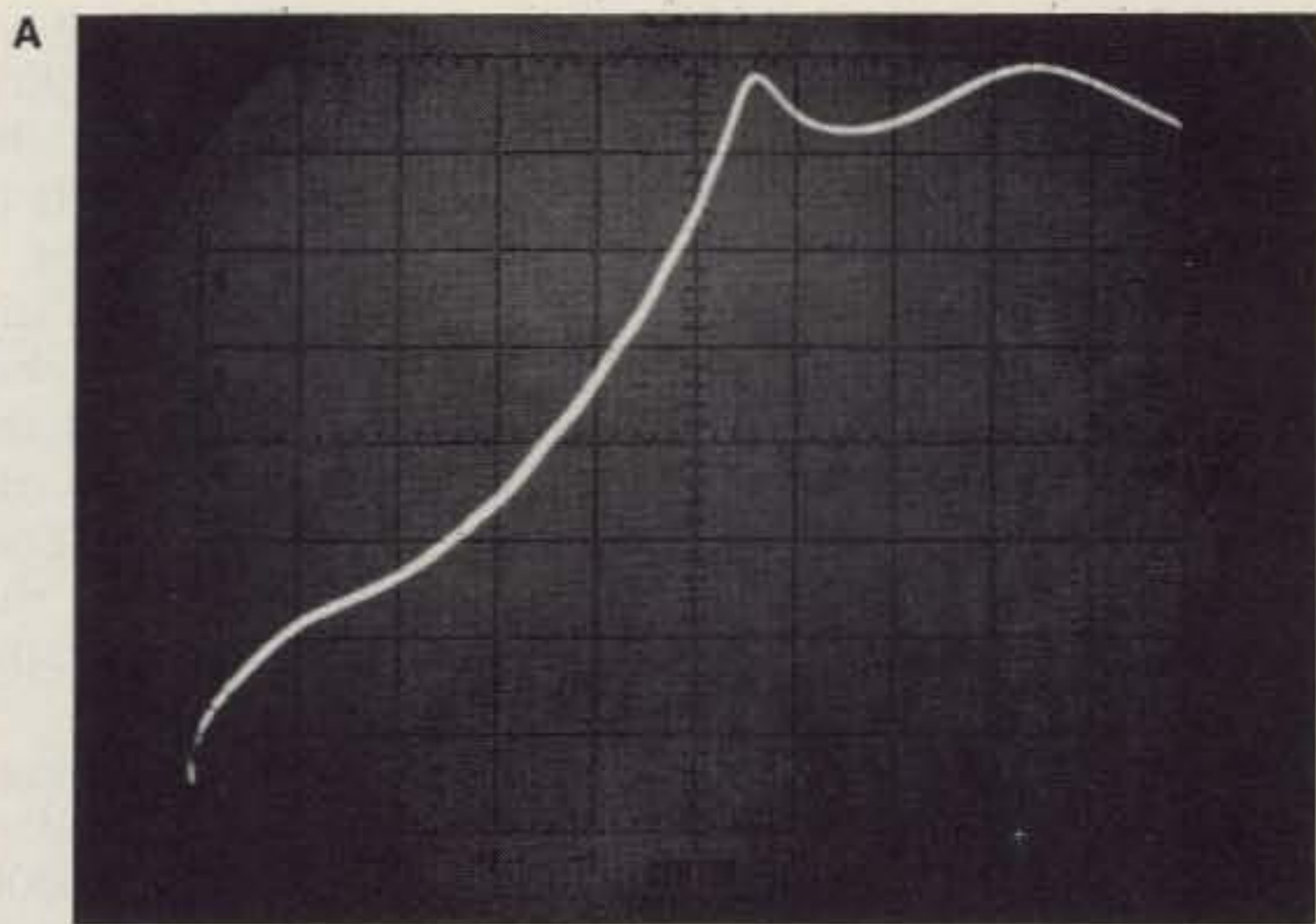

Fig. 3. Unbalanced-mode response of filter in Fig. 1. Measured with Hewlett-Packard 8553 Spectrum Analyzer and 8443 Tracking Generator. (a) Good ground; 1-inch ground lead. (b) 4-inch ground lead. (c) No ground. Vertical axis: 10 dB/division. Horizontal axis: frequency (0-100 MHz).

balanced mode, and the other is the unbalanced mode. Each mode reacts differently with the high-pass filter.

In the balanced mode, the currents on each side of the feedline are of equal magnitude and opposite phase. At any instant in time, a current traveling down one side of the feedline is matched by a current traveling up the other side of the feedline. The filter in Fig. 1 consists of capacitors in series with each side of the feedline (which impede low frequency signals), and inductors between the two sides (which tend to short out low frequency signals). At the TV frequencies, the capacitors have low reactance, and the inductors have high reactance. The TV signals can pass through the filter with little or no loss. If the signals are truly balanced, and the filter construction is perfectly symmetrical, the grounded center taps of the coils will have no effect.

On the other hand, in the unbalanced mode, the currents on each side of the feedline are in phase, so that a current traveling

down one side of the feedline is matched by an equal current traveling down the other side. The inductors between the two sides of the feedline have no filtering action because the same signal is already on both sides of the line. The filtering action is now dependent on the grounded center-taps of the inductors to short out low frequency signals. The reason that the unbalanced signals are of importance is that signals from the amateur transmitter tend to be picked up by the TV feedline in the unbalanced mode.

Now, how can a filter be connected to the TV set? Recent-model TV sets are much more compact than their predecessors. There is little or no extra room to put a filter inside. Furthermore, the tuner input terminals are usually the antenna terminals on the back of these sets. The only practical thing to do is to put the filter outside.

A ground connection to this filter might be made by attaching a wire from the filter to a mounting screw on the back of the TV. In this situation, the schematic in Fig. 2 is more accurate

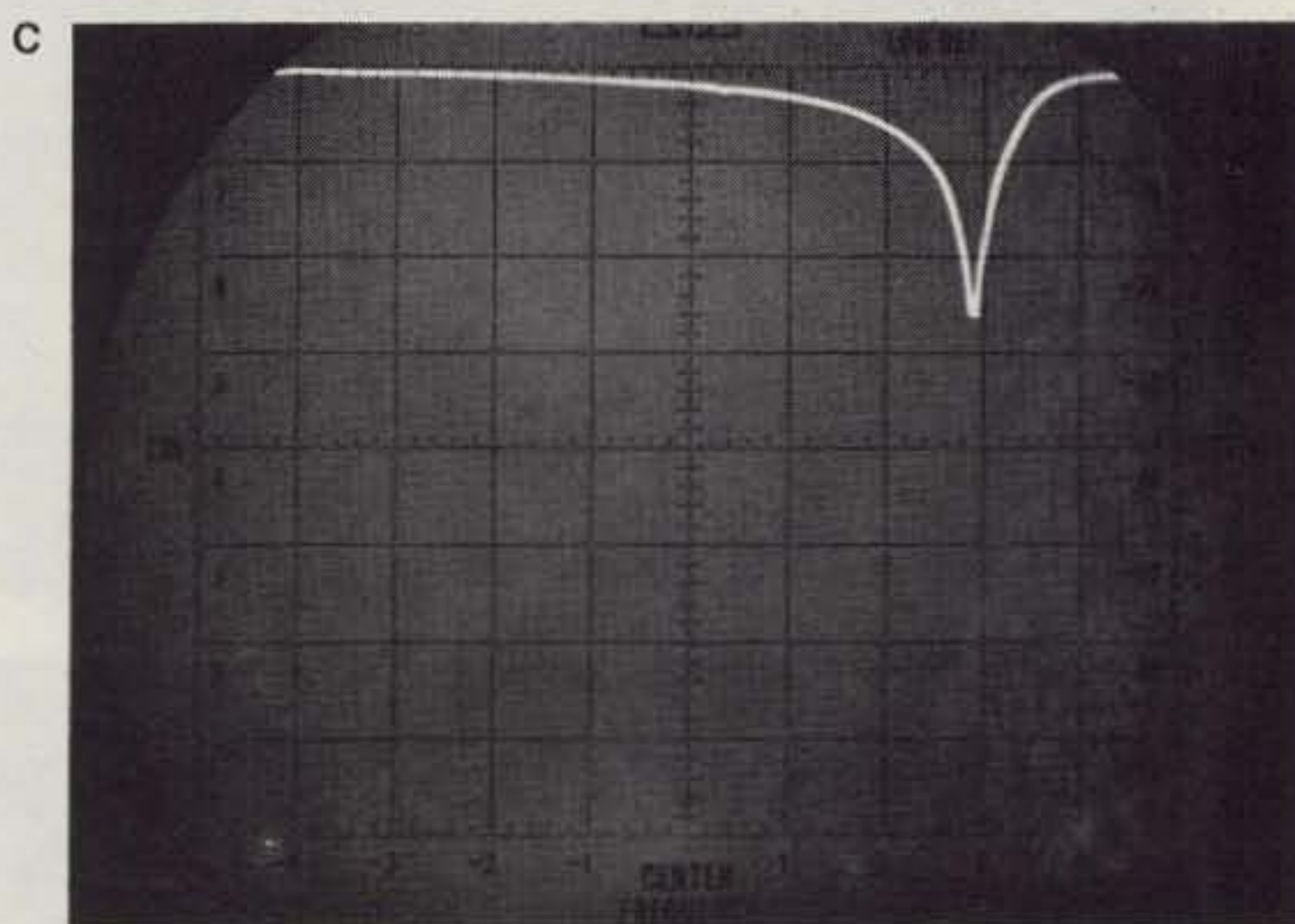
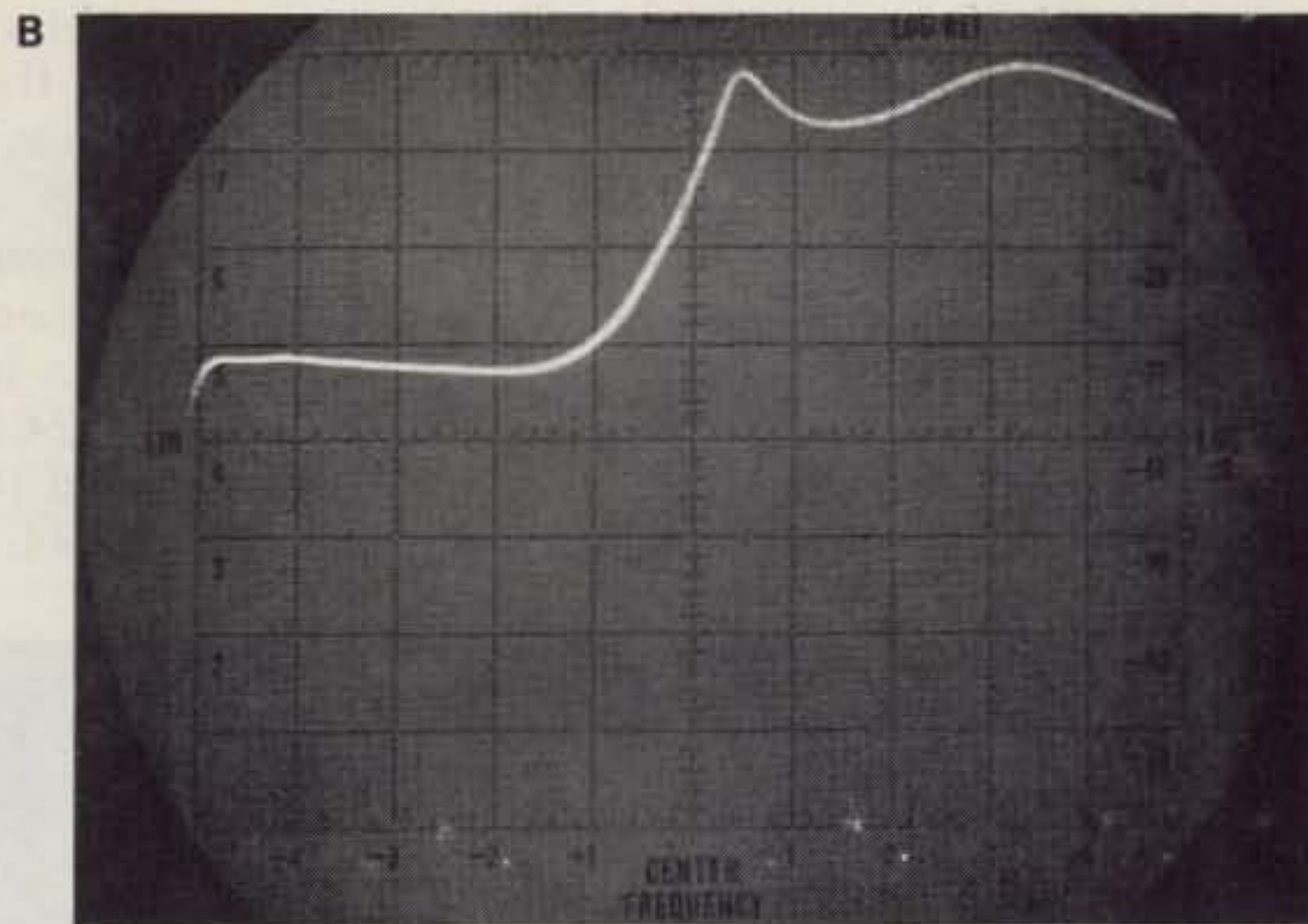

than Fig. 1. The center-taps of the coils, L1, L2, and L3, are connected together at the filter. This connection between the coils is then connected to the TV chassis ground through the inductance of the wire ground lead. If this ground lead is of any length, its inductance will be important when compared with the coils in the filter. If the ground lead inductance is too high, signals will flow through L1 to its center-tap, then to the center-tap

of L3, and finally out of the filter. This is demonstrated by the three unbalanced-mode attenuation curves in Fig. 3. In Fig. 3(a), the filter has a solid ground connection and low frequency signals are attenuated up to 70 dB. In Fig. 3(b), the ground lead is only 1 inch long, and the filter provides only 30 dB attenuation up to 70 dB. In Fig. 3(c), there is no ground connection to the filter, and the filter is totally useless for unbalanced sig-

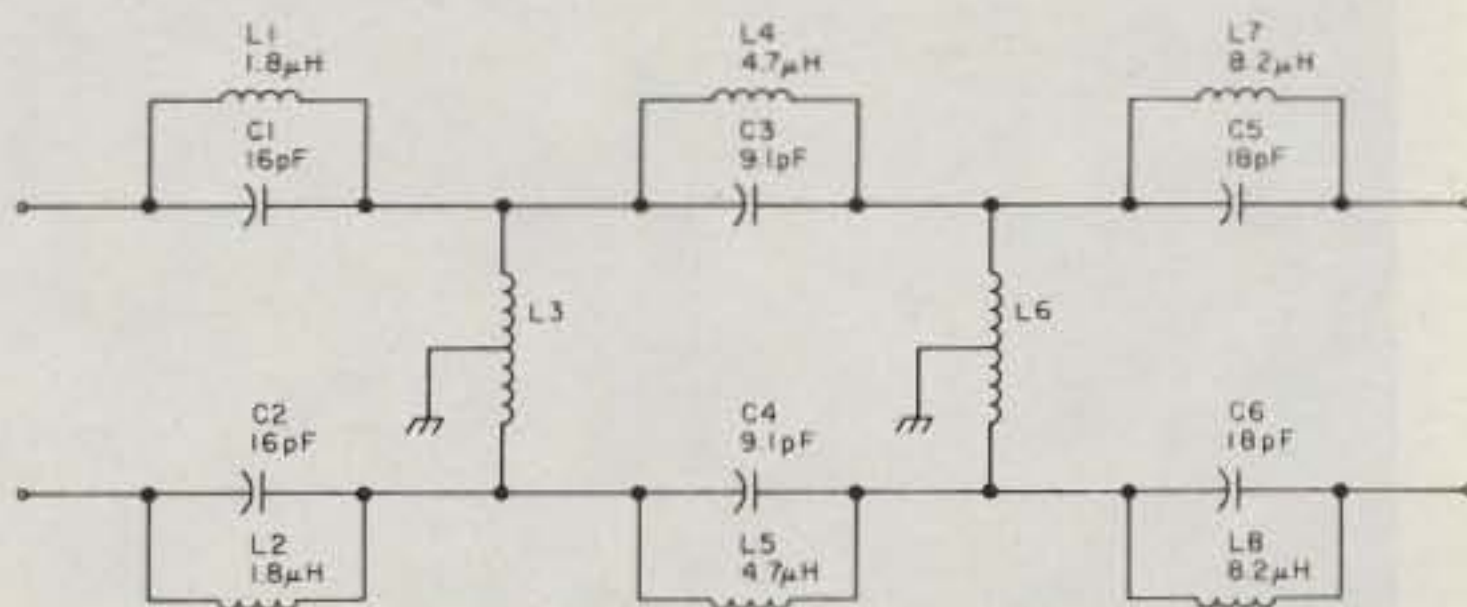

Fig. 4. Improved high-pass filter. L3 and L6 consist of 12 turns of number 24 close-spaced on a 1/4-inch diameter plastic rod.

nals. With a less than perfect ground, it makes little difference how many sections are in the filter; the signal can still sneak from the center-tap of the input coil to the center-tap of the output coil and bypass everything in the middle.

Since getting a better ground connection in the real world is not always easy, I have designed a filter that is less sensitive to the filter ground connection. My filter is shown in Fig. 4. Here, L1-C1 and L2-C2 form trap circuits tuned to 10 meters. Similarly L4-C3

and L5-C4 are tuned to 15 meters and L7-C5 and L8-C6 are tuned to 20 meters. Signals that might be able to sneak from the center-tap of L3 to the center-tap of L6 will still have to go through the high impedance of the resonant traps at the input or output of the filter. The proof of this is shown in Fig. 5. With a good ground connection, this new filter performs somewhat better than the design in Fig. 1. With a 1-inch ground lead, the response is almost identical to the response with a good ground, Fig. 5(a). If the ground lead is lengthened to 4 inches, Fig. 5(b), the filter is still useful against 20- and 10-meter transmissions. As previously discussed, keep in mind that most of the desired TV signals are in the balanced mode and are not affected by the filter ground lead. Therefore, the 60-MHz notch in Fig. 5(b) will not adversely affect TV reception.

Although I used a computer to optimize the component values of my filter, the final design is quite tolerant to variations in parts values and location. I used commercially wound coils except for L3 and L6. The other coils could also be hand wound on any reasonable size coil form in your junk box. It's desirable to use a grid-dip meter to make sure that the traps are resonant somewhere near the right band. L3 and L6 should resonate with 18 pF near 50 MHz.

A word of caution is in

order: Some TV sets have one side of the power line connected directly to the chassis. If your set falls in this category, connect a .001 uF capacitor of suitable voltage rating between the chassis and the filter ground lead. Be careful that nothing connected directly to the chassis is exposed to the touch.

After I had gone through all of this, a TV manufacturer sent a Drake TV-300-HP-F filter for one of my neighbors. Naturally, I had to see how it was built and how it worked. The schematic is shown in Fig. 6. The resistors shown apparently serve to prevent a static charge from building up on the TV antenna, and are not important to the normal operation of the filter. It is interesting to observe that their coils need to be intentionally deformed in the process of tuning the filter at the factory. When the case is directly grounded, the Drake filter gives 30 to 40 dB attenuation from 50 to 52 MHz, and up to 70 dB on the lower bands. Like the filter in Fig. 1, it is extremely sensitive to the length of the ground lead, and is useless against unbalanced-mode signals when it's not grounded. Ironically, the instructions supplied with the Drake filter discouraged grounding the filter to the TV chassis!

I hope my experience will help you cure your TVI problems. I would like to thank my wife for her time and effort in helping solve mine. ■

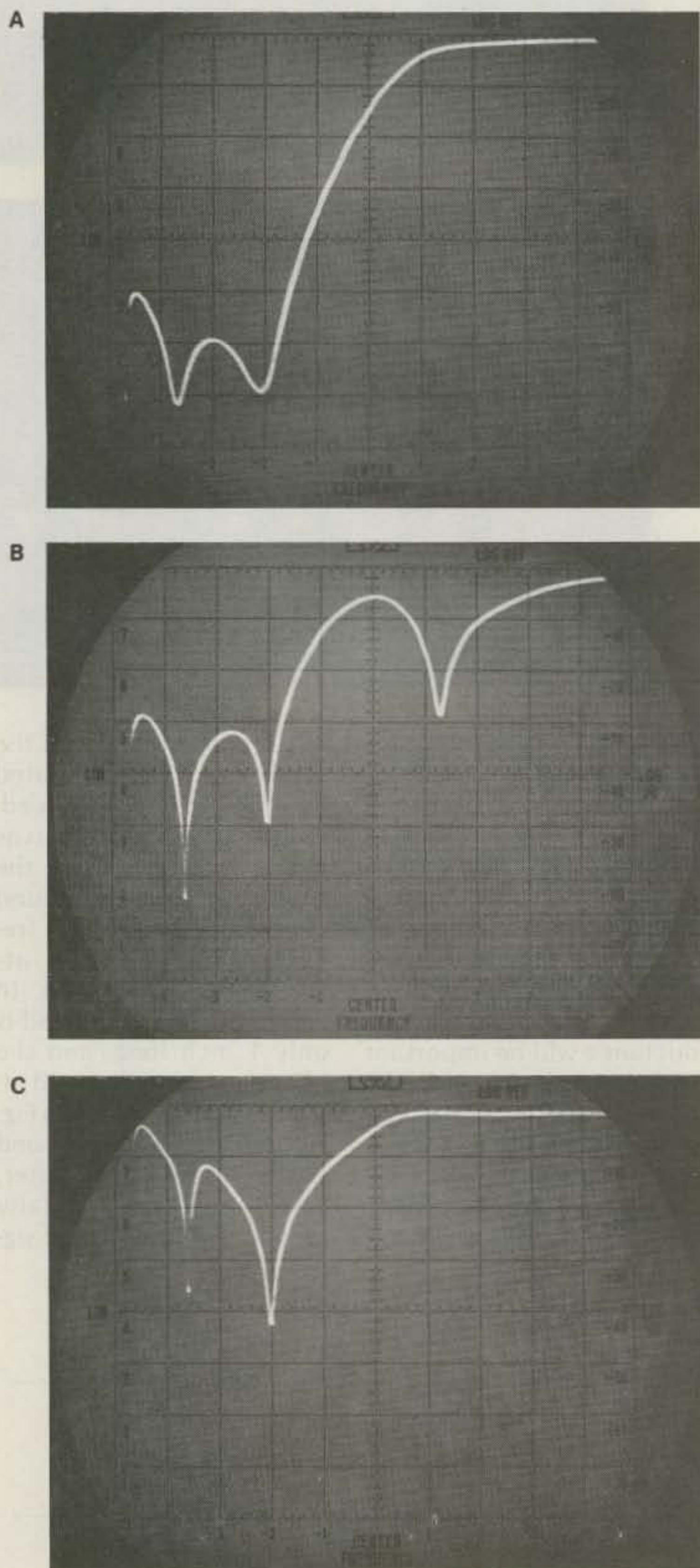

Fig. 5. Unbalanced-mode response of filter in Fig. 4. Same test setup as Fig. 3. (a) Good ground. (b) 1-inch ground lead. (c) No ground.

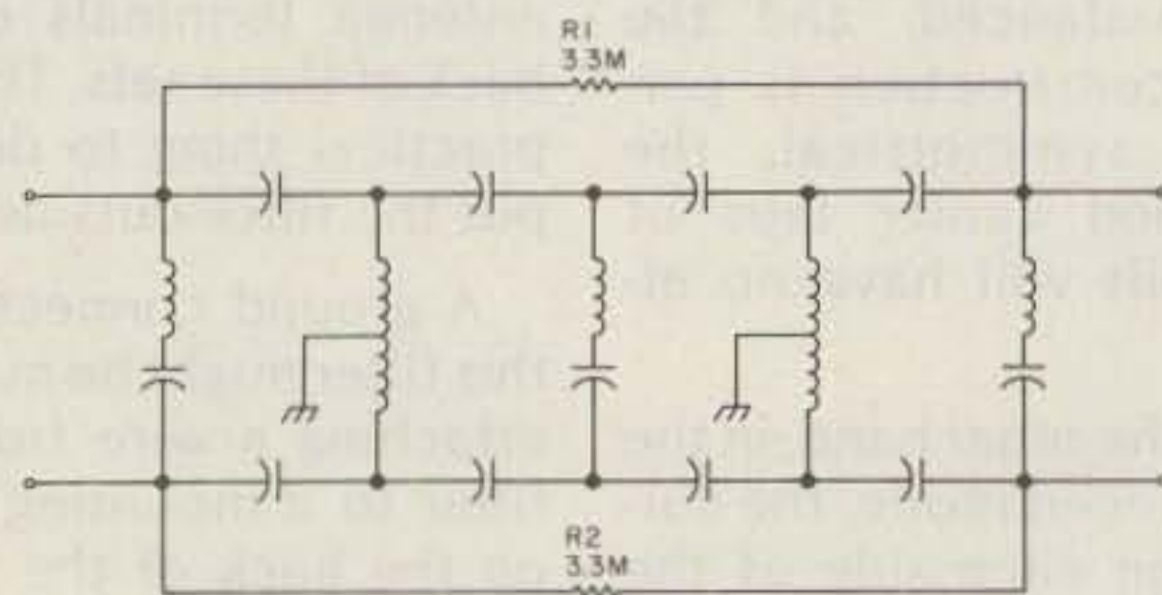

Fig. 6. Drake TV-300-HP-F high-pass filter.

EDGECOM SYSTEM 3000A AND FMS-25 ... PERFORMANCE THAT CHALLENGES YOUR IMAGINATION



SYSTEM 3000A: 144-147.995 MHz FM transceiver that features: • Twenty front-panel-programmable memory channels • Memory scanner • Band scanner • Any transmitter offset • Memory channel monitoring • Two priority channels • Extraordinary receiver • 25 Watts output • American made • Full two-year warranty • \$549.



FMS-25: Uses the same fantastic receiver and transmitter as System 3000A. Features: • Ten front-panel-programmable memory channels • Built-in band scanner • Full coverage in 5 kHz steps • Electronic push-button tuning • Any transmitter offset • Wired for commercially available Touchtone microphones • American made • Full two-year warranty • Only \$439.

Minimum \$3.00 for shipping & handling on ALL ORDERS.

Prices FOB Medford MA. MA residents add 5% sales tax.

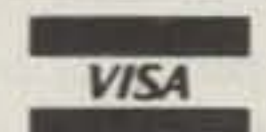

Radio Electronics
209 Mystic Avenue
Medford MA 02155
(617) 395-8280 ✓T45

555 Basics—And More!

—get to know this versatile IC

David Keeler WB4CEO
5204 Ferndale Avenue
Mobile AL 36618

There have been many articles recently in 73 Magazine and other ham radio magazines, as well as other electronics-related literature, about integrated circuits. It seems to me that one of the cheapest and most useful ICs has not received nearly enough coverage. This device is suited for many applications as a general purpose timer. A few of these will be covered in this article.

The device to which I am

referring is, of course, the 555 timer IC (it does have a big brother—the 556 dual timer, which is nothing more than two 555s in one package). The 555 usually sells for about 50¢ while the 556 sells for prices ranging from about 89¢ to over two dollars. Naturally, it is cheaper if you order them from some of the discount mail-order houses, rather than buy them at a local supply house.

In this article, we will take a look at some of the practical uses for the 555, plus the basics on how it works and how to apply this to some of your future construction projects. First, let's see how it works.

The Basics

The 555 timer is an eight-pin DIP package IC (see Fig. 1). Pin 1 is always connected to ground and pin 8 goes to the Vcc. The 555 will accept any voltage from a low of 4.5 V dc to a

high of 16 V dc. It works fine on 5 volts, even though this is close to the lower rating. It also works with no problems on a 6-, 9-, or 12-volt battery. And you can switch from one to the other as you wish because the timing period is independent of the supply voltage.

Pin 2 is the trigger pin. As the name implies, this pin is used to set (or trigger) the IC. Anything below $\frac{1}{3}$ of the Vcc qualifies as a low and is read by the chip as a trigger pulse. When using the IC, it is a good idea to tie this pin to Vcc through a resistor of about 1500 Ohms. The IC can be triggered by anything from your finger to stray rf if this pin is left floating.

Pin 3 is the output. The name speaks for itself. It is normally low and goes high during the timing period. The output can be used to drive other ICs or a low-current relay.

Pin 4 is the reset pin. This pin should be tied to Vcc if it is not used, which it often isn't. Its main purpose is to reset the IC to its static state before the timing period is over.

Pin 5 is the control voltage. It can be used to alter the output. For our general timing purposes, however, it is a good idea to simply tie this pin to ground through a .01 uF capacitor. If you fail to do this, the timer may not function properly.

Pins 6 and 7 determine the length of the timing period when tied to external resistors and a capacitor. More will be explained about the specific uses of these pins in the sections following.

Monostable Operation

There are basically two ways to use the IC as a timer: either monostable or astable. First, we will look at its use as a monostable.

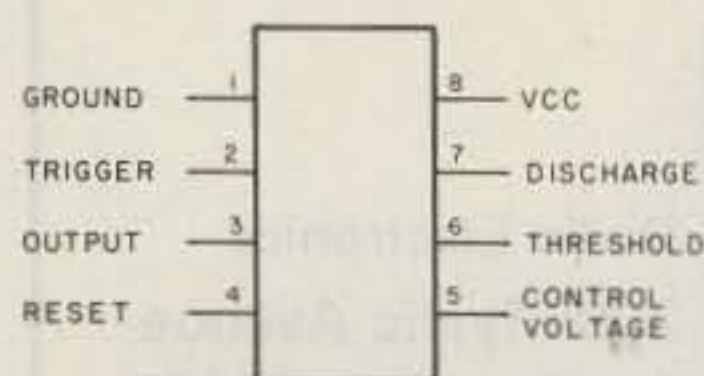

Fig. 1. 555 timer pin configuration.

Fig. 2 shows the proper way to wire the IC when using it as a monostable. Again, we will take it pin by pin.

As always, pin 1 goes to ground and pin 8 goes to Vcc. Pin 5 goes to ground through a .01 uF capacitor (any approximate value will do). Pins 2 and 4 are held normally high by two 1.2k Ohm resistors. The two normally-open momentary-contact push-buttons provide a means for grounding when desired. An indicator lamp is connected between ground and pin 3. Pins 6 and 7 are tied together. They go to ground through a capacitor and through a resistor to Vcc. Now we are ready to go!

The IC is in its standby state. The output (pin 3) is low, so the lamp connected to it is off. Pins 2 and 4 have a high on them. Pin 7 (and pin 6, since the two are connected) is held low by a transistor inside the timer, thus keeping the capacitor discharged.

Now push-button 1 is depressed, grounding pin 2. As soon as the voltage on pin 2 goes below $\frac{1}{3}$ Vcc, the IC sets a flip-flop inside it. This both removes the ground from pin 7 and drives the output high. The timing cycle has begun.

How long the cycle lasts, and thus how long the output stays high, is determined by the values of C1 and R1. Now that the short to ground is removed from pin 7, the capacitor begins charging through R1. It continues until it reaches $\frac{2}{3}$ Vcc on the chip. When this point is reached on the threshold pin (pin 6), the flip-flop resets and drives the output low again. It also grounds the capacitor and we are right back where we started again. The IC is in the standby state and ready for another trigger pulse.

As I mentioned before, the timing period is in-

dependent of the supply voltage. This is due to the fact that the period is determined by how long it takes the capacitor to charge to $\frac{2}{3}$ Vcc. The higher the voltage, the faster the capacitor charges, but the further it has to go to reach the $\frac{2}{3}$ level. Conversely, the lower the voltage, the slower it charges, but it doesn't take as long to reach $\frac{2}{3}$ Vcc. Simple, isn't it?

The reset pin serves an interesting purpose. After the IC has been triggered and the capacitor is charging, the flip-flop may be reset instantly to its standby state by applying a low to pin 4. This can be very useful if you want to stop in the middle of a timing period rather than wait for the IC to reset itself (especially if you are timing hours and not milliseconds).

Before you can use the 555 timer, you must know how to determine the length of the timing period. The formula for the monostable (Fig. 2) is as follows:

$$T = R1 \times C1 \times 1.1$$

where T is in seconds, R is in megohms, and C is in microfarads.

For example, if you use a 1 megohm resistor and a 2 microfarad capacitor, the timing period will be: $1 \times 2 \times 1.1 = 2.2$ seconds. Remember, this formula is only good for monostable operation.

Now we have seen how the 555 operates in the monostable mode. Perhaps even more useful is the astable mode, which will be discussed next.

Astable Operation

Referring to Fig. 3, we see that there is another common way to make use of the 555. When wired as shown, it is set to operate in the astable mode. This is a free-running situation in which the IC automatically retriggers itself. This can be

useful for supplying a series of pulses equally spaced, or for turning on something for a given period of time and then turning it back off for a different given period of time. Here, once again, is a pin-by-pin detail (Fig. 3).

Pins 1, 5, and 8 are connected in the usual manner. Pin 2 is tied to pin six (automatic retrigging) and pin 4 (reset) is tied directly to Vcc. The output goes wherever you want. In this example, it is tied to a lamp. Here is how the circuit works:

We start off with Vcc disconnected. As soon as we put power to the chip, the internal transistor grounds the capacitor as before in the monostable. But the trigger pin (pin 2) is tied to the top of the capacitor. So, as soon as the discharge pin (pin 7) goes low, the trigger senses it through R2 and sets the flip-flop. This removes the low from the capacitor and it begins to charge through both R1 and R2. It continues to charge until the voltage on the capacitor reaches $\frac{2}{3}$ Vcc. Then the flip-flop is reset and the voltage on pin 7 goes low. However, the capacitor is not immediately discharged since there is a resistor between it and pin 7. The voltage slowly goes lower until it reaches $\frac{1}{3}$ Vcc. As you remember, this is low enough to trigger the IC via pin 2, which also ties to the top of the capacitor. The IC is set again and the capacitor begins to charge. So, as you can see, the voltage on the capacitor goes back and forth between a high of $\frac{2}{3}$ Vcc and a low of $\frac{1}{3}$ Vcc (after the initial charge from zero).

As you might expect, there is a formula for computing the length of the timing cycles in astable mode, too. Here it is: Output high = $0.693 \times (R1 + R2) \times C$. Output low = $0.693 \times (R2) \times C$. Again, the

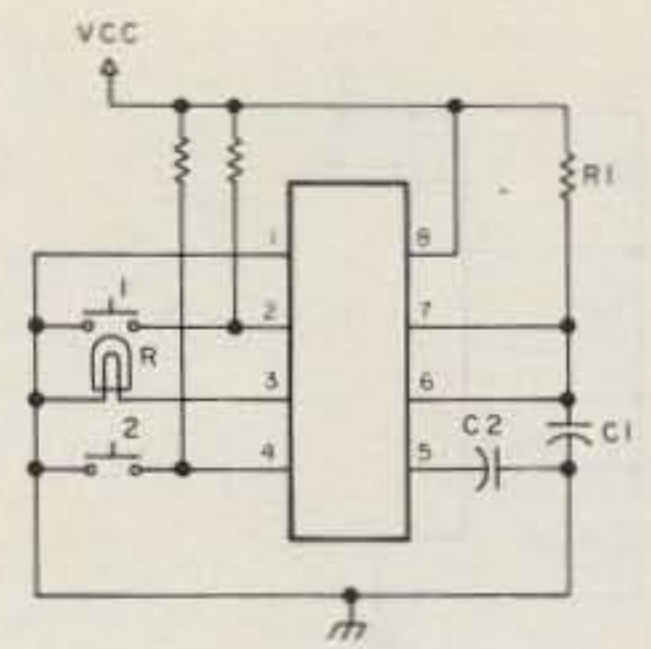

Fig. 2. Monostable operation.

output-high and -low times are in seconds, R is in megohms, and C is in microfarads.

As the formula points out, the capacitor must charge through both resistors while it only has to discharge through R2. For example, let's use the following values: R1 = 10 megohms, R2 = 4 megohms, and C = 2 microfarads.

The output-high time would be: $0.693 (10 + 4) 2 = 19.4$ seconds, while the output-low time would be: $0.693 (4) 2 = 5.5$ seconds. Again, the timing period is independent of supply voltage.

Audio Oscillator

Another excellent use for the 555 is as an audio oscillator. Although the 7400 TTL IC does this just as well for less than half the price (usually), it may be desirable to use the 555 instead in some cases. Remember, the 555 does not require five volts to operate as the 7400 does. Also, it is half the size.

Basically, the audio oscillator (Fig. 4) is nothing but operation in an

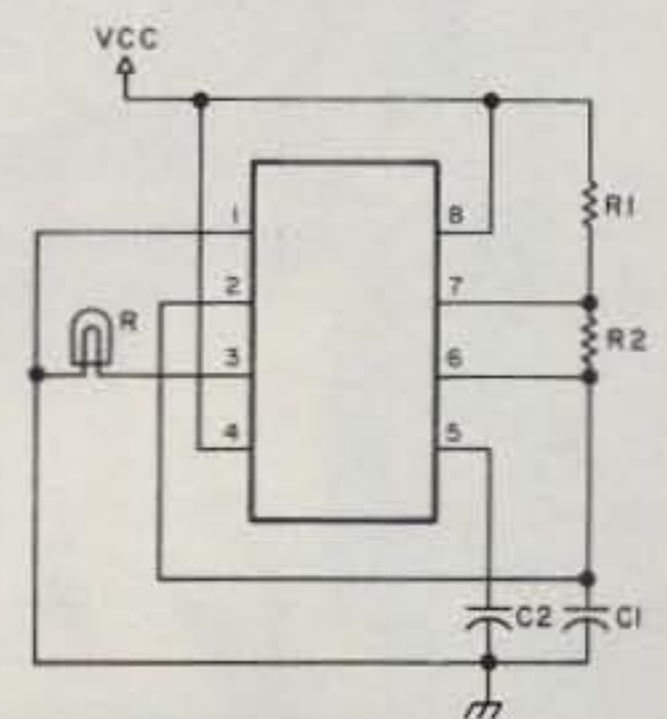

Fig. 3. Astable operation.

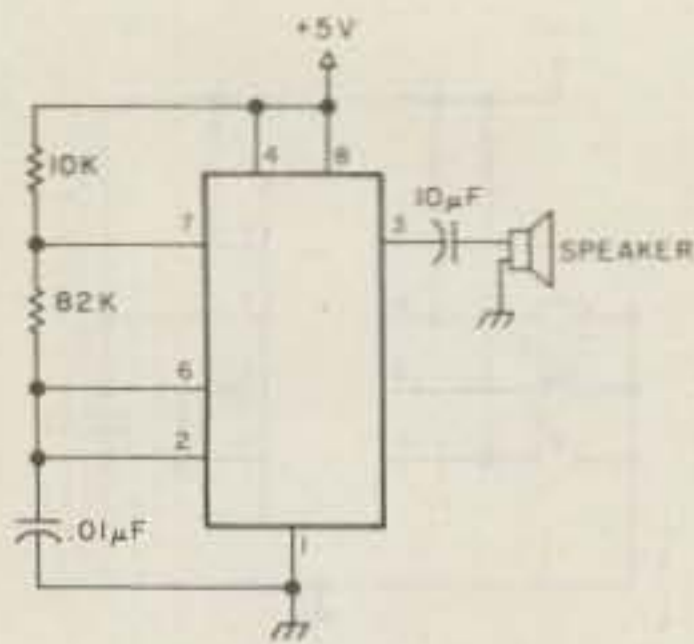

Fig. 4. 555 used as an audio oscillator.

astable mode with values that make the 555 turn on and off at an audio rate. Notice the values for frequency components R1, R2, and C1. Using the formula listed in the astable section, we see that the

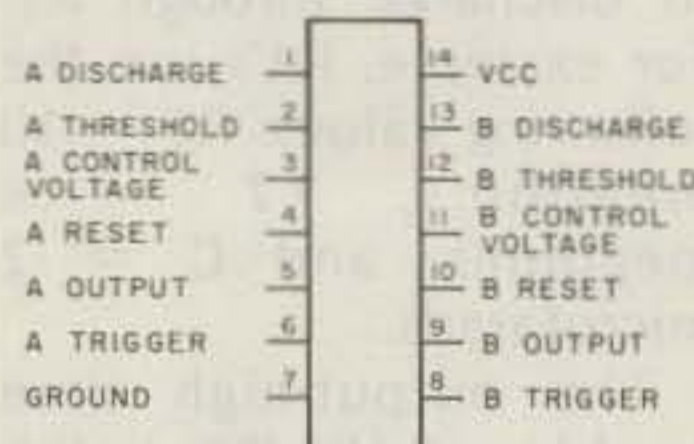

Fig. 5. 556 timer pin configuration.

output-high time is $0.693 \times .092 \times .01 = 0.0006$ seconds, while the output-low time is: $0.693 \times .082 \times .01 = 0.0005$ seconds. This gives us an audio rate of about 900 Hz. Since the high and low times are not exactly the same, some distortion will occur, but it is not bad. It's fine for a simple monitor, and you can always clean it up with a simple low-pass filter.

Notice that some differences exist between this and the other astable. The output goes to a speaker through a 10 uF capacitor. The output is nothing more than a series of highs and lows operating at an audio rate. It makes a fine little audio oscillator and it covers all audio frequencies with no problems. You can always change the frequency on this particular circuit by changing the 10k Ohm resistor for a pot of comparable value.

The 556

The 556 is nothing more than two 555s in a single fourteen-pin DIP package (Fig. 5). They are completely independent of each other as far as triggering, reset, output, and all other functions are concerned. The only things that they have in common are Vcc and ground.

Usually, the 556 costs much more than two 555s. This makes it cheaper to use the 555. But there are some advantages to the 556. Here are a few of the more important ones:

1. The 556 will take up less space on your circuit board and will require only one socket.
2. Since the power connections are common to both timers, you don't have to make separate power runs on your board. Also, both can be cut off by removing one power connection.

3. The two timers in the 556 are, of course, in the same chip. This makes the electrical qualities almost exactly the same. Naturally, each 555 is a little different. The 556 solves the problem.

So, considering the preceding factors, make your own decision. Both the 555 and the 556 are readily available to the hobby builder.

Conclusion

In conclusion, it seems accurate to say that the 555 is one of the best chips available today for general purpose timer applications. Books have been written on the various uses of the 555, but this article gives the basic ones that you are most likely to use. Hopefully, the reader will be able to use the guidelines in this article to formulate projects of his own. ■

Another S.G.C. breakthrough in Radiotelephone Communications

TEL-TWO[®] PHONE PATCH

By S.G.C., The Leader In HF Communication Design

The Tel-Two is designed and manufactured by S.G.C., the world leader in HF communications design. The SGC series of SSB radiotelephones provide marine and land communications throughout the world.

Tel-Two Features:

- Telephone Patch for use with any type of radio equipment and telephone line.
- Designed with the latest technology in communications.
- Totally automatic voice controlled switching.
- Application: VHF-UHF-FM-SSB-HF-AM.
- Price: \$495.00.



For more information, contact SGC, Inc., at (206) 746-6310 or the dealer nearest you.

SGC[®]

13737 S.E. 26th Street
Bellevue, WA 98005 U.S.A.

EDGECOM'S FMS-25 . . . THE FANTASTIC 2M FM MOBILE RIG



Edgcom's FMS-25 2m FM transceiver is nothing short of ideal for 2m mobile operation. Ten front-panel-programmable memory channels provide you with fingertip convenience for recalling your favorite frequencies, the microcomputer-controlled PLL frequency synthesizer gives you full coverage with any transmitter offset using push-button tuning, and the built-in band scanner lets you automatically tune the band. Add to these features an absolutely superior receiver, 25 Watts of output power and you have a combination that provides unexcelled performance at the low price of \$439.

FOR THE ULTIMATE IN FLEXIBILITY, THE INCOMPARABLE SYSTEM 3000A



The Edgcom SYSTEM 3000A 2m FM transceiver provides unequalled performance, incredible flexibility and several features that go beyond the imagination. Twenty front-panel-programmable memory channels, a memory scanner, a band scanner, two priority channels, any transmit offset, electronic tuning, 25 Watts of output power and the superior Edgcom receiver are a few of the several outstanding features that make the System 3000A the forerunner in the state-of-the-art in amateur communications.

MIDCOM

We'll Make You Glad You're A Ham
ELECTRONICS, INC. ✓ M62

Call Collect Now to Order (314) 961-9990

2506 S. BRENTWOOD BOULEVARD
ST. LOUIS, MISSOURI 63144

Educate Yourself

—an almost painless method

Ever since I got my ham license in 1976, I had been looking for a simple way to learn solid state electronics. You see, I learned radio and electronics in the 1960s while in college and high school. I had little experience with transistors.

When I came back to the electronics hobby in 1974, solid state had taken charge. With only my knowledge of tube-type circuits, I developed a dislike for anything made of silicon. But I soon realized that I would have to learn semiconductor technology. The question was how to go about it.

I decided to look into correspondence courses. Many are excellent; most are expensive. Also, you may find that the course includes training and equipment that you don't need or want.

The Heath Continuing Education Series is different in several respects. The individual volumes of the series can be purchased separately, if you desire. The individual volumes include *DC Electronics*, *AC Electronics*, *Semiconductor Devices*, and *Electronic Circuits*. Also available is a two-volume advanced course, *Digital Techniques*, and in the works are several hobby computer courses. All courses include text, records, final exam, and components for

the experiments. The Experimenter/Trainer is optional and is needed for the experiments.

Since I have a good background in dc and ac electronics, I bought only the *Semiconductor Devices* volume, at \$39.95, and the *Electronic Circuits* volume, at \$49.95. I also picked up the ET-3100 Experimenter/Trainer, which is reviewed at the end of this article.

Each chapter is introduced by a record or optional cassettes. Chapters are subdivided into sections, and after each section is a short exam. The sections can be completed in 20 to 30 minutes, so I found it easy to study for a short time and return later without becoming lost. The section exams quickly reveal any weak points before you move on. At the end of each chapter is a longer review guide and exam.

As I progressed, the chapters took longer to complete. More applications are given and experiments are more complex. Memorization is not really necessary; once you understand the basic concepts, you can always refer back to the text.

I started into the *Semiconductor Devices* course. As each new device is introduced, its construction, packaging, theory of

operation, and applications are explained.

The first chapter was a little boring. The theory of hole and electron current is explained. Semiconductor junctions are discussed in detail. These are the fundamentals and a necessary evil.

The text picks up momentum as you move on to diodes. Testing is demonstrated. In Chapter 3, I finally learned how to design a zener diode voltage regulator. And, most important, I found how to calculate the component values.

The chapter on "special diodes" discusses PIN diodes, tunnel diodes, varactors, IMPATT, Gunn, and hot-carrier diodes. Of these devices, the varactor and tunnel diodes are covered in detail. The other gadgets are discussed sufficiently so that now I can understand how the Gunnplexer operates. And I know why PIN diodes are used in my UHF transceiver.

Bipolar transistors are covered in two chapters. One chapter discusses basic operation, biasing, circuit configurations, and testing. The next chapter presents characteristics, operating frequencies, and maximum ratings. Highlights of these two chapters include testing of transistors, determining

whether a transistor is a PNP or NPN type, creating characteristic curves, and calculating input impedance. Two experiments are performed. A lot of information is presented, but not quite enough to start designing circuits. This will come much later.

The next chapter is devoted to field-effect transistors. Junction FETs and insulated-gate FETs (MOSFETs) are covered in detail. Experiments are performed for each. Characteristics, circuit configurations, and safety precautions are explained. Depletion-mode and enhancement-mode MOSFETs and applications of each are presented. This chapter was very easy to absorb after two chapters of bipolar transistors.

Thyristors also fill an entire chapter. In case you're wondering, thyristors are a family that's made up of SCRs, triacs, diacs, and unijunction transistors. These are mostly used in power control, switching, and generation of waveforms. Several experiments are provided.

Chapter 9 is an introduction to ICs, and believe me, it's only an introduction. There is just enough information given to familiarize the reader with the construction, packaging, and magnitude of uses for integrated circuits. A

bird's-eye view of digital and linear ICs and applications of each winds up the chapter.

The final chapter is a presentation of optoelectronic devices, beginning with a discussion of the physics of light. Photoconductive and photovoltaic devices are explained. Photodiodes and phototransistors are covered in great detail. LEDs round out the chapter. Two experiments are performed.

This also concludes the *Semiconductor Devices* volume. At this time, a progress report is in order. I now know how all of the important semiconductor devices are used, and how to choose, test, and handle them. I also have some idea of the framework of circuitry that the devices fit into. But it is now time to move on to the *Electronics Circuits* course.

The *Electronics Circuits* course is clearly the best of the group. This is where all of the previous tidbits of information are tied together for useful applications. The same format is used as before, with records, self-tests, summaries, and experiments. However, this course is on a higher level than *Semiconductor Devices* and requires more effort. The seven chapters average about a hundred pages each. The sections are longer. The experiments are more elaborate, too, and 110 components are provided for them. A calibrated scope is needed for some experiments, and this is mentioned in the catalog. I used an Eico 460, which lacks time calibration. I could display the waveforms but not make the measurements, and this bugged me. However, it was more of an annoyance than a real handicap.

The first two chapters are on amplifiers. Chapter 1 explains the basic theory

of amplifiers: biasing, classes of operation, applications. The theory is totally explained with no reference to vacuum-tube counterparts. This is a welcome change from most texts. Then, Chapter 2 details just about every type of amplifier you'll ever run into: i-f, rf, audio, video, differential, wide-band, dc, and others.

Just to pause for a moment: Most hams with at least a Tech license know something about amplifiers. But did you ever wonder, for example, why a volume control is placed where it is? Or how to design a bass or treble control? This chapter explains some of those finer points.

Not very many math formulas are given, but a lot of guidelines are presented to put circuit values "in the ballpark." I learned how various load impedances affect amplifier operation. I also discovered that voltage amplifiers always drive high-impedance loads, such as another amplifier, and power amplifiers usually drive low-impedance loads.

Push-pull amplifiers and their kissing cousins, the complementary and quasi-complementary configurations, are covered in much detail. An experiment is performed that makes use of these amplifiers.

The last sections of Chapter 2 discuss i-f and rf amplifiers and frequency multipliers. This section should be very useful to anyone working with receiving and transmitting circuitry. Subtopics include neutralization, bandwidth, coupling, automatic gain control, stagger tuning, and ceramic filters.

A total of four experiments are performed in the first two chapters.

Chapter 3 covers operational amplifiers. Op amps used to be too complex for most applications, since so many components are in-

cluded. Not so today. Now that entire op amps are packaged in IC form, they are as cheap as a single transistor. Uses of this device include analog circuits (adders, integrators, multipliers), oscillators, and differential amplifiers.

A novel use of the op amp is as an active filter. Essentially, the active filter is an RC-network-tuned op amp that behaves like a sharp-tuned LC circuit. Now the big deal is that at low frequencies, resistors can replace bulky inductors with no loss in selectivity. Thus, modern RTTY demodulators can be built without those 88 mH toroids, and with a lot fewer parts.

Four experiments are done in this chapter.

Back to the text. Power supplies take up a full 120 pages—the longest chapter in the entire course. Capacitor, RC, and LC smoothing filters are discussed to great length. Voltage multipliers and elementary regulator circuits are described. The more exotic circuits presented and detailed are the regulators—the emitter-follower, feedback, and op amp regulator. Most important, two experiments are provided for all this good stuff. This chapter winds up with a discussion of shunt regulators, IC regulators, protective circuits, and an analysis of actual TV and oscilloscope power supplies.

Chapter 5 is all about oscillators. Tank circuits are treated in detail and transformer oscillators are touched upon. Those LC oscillators most of you guys memorized for the exam—well, they're all here. And now you find out how the Hartley, Clapp, Colpitts, and Pierce circuits work. One special circuit presented is the Wien-bridge oscillator. Other topics well covered are crystals, tuning of oscil-

lators, and RC networks. Four experiments are performed on oscillators.

Chapter 6 is on pulse circuits. This stuff gets really heavy. The first section treats sine waves and goes on to explain how sine waves can be combined to form any other waveform. Then you move on to wave-shaping circuits, diode clippers, transistor clippers, and clamping circuits. The rectangular wave generators covered are the astable multivibrator, monostable multivibrator, bistable multivibrator, and Schmitt trigger.

The 555 IC timer is covered in great detail. This is the cheapest and one of the most versatile pulse generators available.

Ramp generators—widely used in TV and oscilloscope sweep circuits and lately in digital voltmeters—are described. Both the op amp and sawtooth types are detailed.

Pulse circuits are rapidly growing in importance and application. As digital technology advances, timing devices will replace analog-type circuits. There are three experiments on pulse circuits.

The very last chapter is on modulation. AM waves and sidebands are discussed at the start. An explanation of percent modulation and AM transmitters follows. Four modulator circuits are covered: emitter, base, collector, and differential.

Receiver circuits are analyzed. The trf receiver is touched on. But a lot of time is spent on superhet mixer and converter circuits. The AM section concludes with an analysis of SSB and the diode balanced modulator.

FM is the subject of the last section of this chapter. Text includes varactor modulators, receivers, slope detectors, discrim-

inators, and ratio detectors.

One experiment on AM is provided in this last chapter.

Well, class is over. Here are my own thoughts: I now have a lot more confidence when working with almost any circuit or project. When I see a project in a magazine, I can freely substitute components now that I know which ones are critical. Maybe I can even improve on the circuit. Soon, I hope to be designing projects of my own. This has brought me a long way, but I have also realized how much I have to learn.

In closing, the Heath series is *not* kid's stuff. The course requires diligent study. It took me about a month to complete each volume, working for around an hour every night. If you're a real hot-shot on semiconductors, you might try just the *Elec-*

tronic Circuits volume.

On the other hand, if you're *really* out of it, start out with *AC Electronics* or even *DC Electronics*.

The Heath Experimenter/Trainer

The Heathkit Model ET-3100 Experimenter/Trainer is intended for use with the Continuing Education Series. Although it is intended for performing the experiments, many features make the ET-3100 useful long after the course is completed.

First, there are the power supplies. The dc supplies are true (+) and (-) supplies, independently variable from 1.2 to 15 volts. From no load to full load, the regulation is 1%. Full load is 100 mA from each dc supply. The ac supply is fixed at 15 and 30 volts rms, with maximum load at 200 mA.

The signal generator is variable from 20 Hz to

20,000 Hz in two ranges. Sine and square wave outputs are available. A large breadboarding socket and panel-mounted 1k and 100k pots are included.

Assembly of the unit is not too difficult. Nearly all of the components mount on the large printed circuit board, which doubles as the front panel. There are a few minor annoyances during assembly: The breadboarding socket is fitted with ninety-six metal inserts, all of which are installed by the builder. Changing the fuse could be a career in itself, since it is hidden within the case in a separate compartment. During initial testing, the case halves had to be separated, and the case leads are not very long. Total assembly time for me was just under six hours. A VOM is required for testing.

The ET-3100 lived up to its specifications with no

defects noted. The (+) and (-) dc supplies were loaded to 111 mA and 119 mA before loss of regulation occurred.

General impressions: The ET-3100 at first appears toy-like, but its low profile reduces fatigue and is less tiring than other breadboard circuits. Non-skid feet prevent the unit from sliding around the bench. Plenty of hookup wire is provided for the experiments. Hookups are much easier than with the once-popular spring clips. The (+) and (-) power supplies are ideal for linear ICs. One feature lacking that would be handy is a built-in voltmeter. That would free my VOM for other uses. However, it is not a hardship.

All in all, the kit is worth the \$59.95 if you're any kind of an experimenter. It sure beats wrestling with several dozen wild alligator clips. ■

DEALER DIRECTORY

Fontana CA

We carry the following: ICOM, Midland, Amcom, DenTron, KLM, Swan, Drake, Ten-Tec, Wilson, SST, MFJ, Hy-Gain, Lunar, Nye-Viking, B&W, Redi-kilowatt, Cush Craft, Mosley, Big Signal, Pipo, etc. Full Service Store **Fontana Electronics**, 8628 Sierra Ave., Fontana CA 92335, 822-7710.

Santa Clara CA

Bay area's newest Amateur Radio store. New & used Amateur Radio sales & service. We feature Kenwood, ICOM, Wilson, Yaesu, Atlas, Ten-Tec & many more. **Shaver Radio**, 3550 Lochinvar Avenue, Santa Clara CA 95051, 247-4220.

Colorado Springs CO

Finest selection of amateur equipment, antennas, & accessories in southern Colorado, including Tempo, Wilson, Cush Craft, Newtronics, KDK, Amphenol, Astatic, Alliance, Ham Key, & Nye. **A.E.S. Communications**, 404 Arrawanna St., Colorado Springs CO 80909, 475-7050.

New Castle DE

Paul WA3QPX, Rob WA3QLS—Serving amateurs in southern New Jersey, Delaware, and Maryland with the largest stock of amateur equipment and accessories in Delaware. **Delaware Amateur Supply**, 71 Meadow Road, New Castle DE 19720, 328-7728.

Tell them you saw
their name in 73

Terre Haute IN

Your ham headquarters located in the heart of the midwest. **Hoosier Electronics, Inc.**, 43B Meadows Shopping Center, P.O. Box 2001, Terre Haute IN 47802, 238-1456.

Wichita KS

Microwave Modules—KLM—KDK—ICOM—Kenwood—Wilson—Standard—ICIR—SWAN—Lunar. We STOCK The Best Communications. **Revcom Electronics**, 6247 N. Hydraulic, Wichita KS 67219, 744-1083.

Dalton MA

Western Massachusetts. Complete 2 meter FM headquarters. Yaesu, KDK, Regency, Larsen, Cush Craft. All kinds of ham gear. **Blue Max Inc.**, Box 97, Dalton MA 01226, 684-0039.

Littleton MA

The ham store of N.E. you can rely on. Kenwood, ICOM, Wilson, Yaesu, DenTron, KLM amps, B&W switches & wattmeters, Whistler radar detectors, Bearcat, Regency, antennas by Larsen, Wilson, Hustler, GAM. **TEL-COM Inc. Communications & Electronics**, 675 Great Rd. Rt. 119, Littleton MA 01460, 486-3040.

This Directory will help you locate a dealer specializing in your needs, and you may be lucky enough to have one right in your vicinity. If not, just contact them at the number or address listed!

Laurel MD

We stock Drake, Ten-Tec, Wilson, ICOM, DenTron, Tempo, Hy-Gain, Midland, Mosley, Hustler. 40-page ham catalog available for \$1.00 (refundable with 1st purchase)—write for cash quote! **The Comm Center, Inc.**, Laurel Plaza, Rte. 198, Laurel MD 20810, 792-0600.

Camden NJ

X-Band (& other frequencies) Microwave Components & Equipment. Laboratory Grade Test Instruments, Power Supplies, 1000's in stock at all times. BUY & SELL all popular makes—HP, GR, FXR, ESI, Sorensen, Singer, etc. **Lectronic Research Labs**, 1423 Ferry Ave., Camden NJ 08104, 541-4200.

Syracuse NY

We Deal, We Trade, We Discount, We Please! Yaesu, Kenwood, Drake, ICOM, Ten-Tec, Swan, DenTron, Midland, Cush Craft, KLM, Hy-Gain, etc. Complete 2-way service shop! **Ham-bone Radio (div. Stereo Repair Shop)** 3206 Erie Blvd. East, Syracuse NY 13214, 446-2266.

Syracuse-Rome-Utica NY

Featuring: Yaesu, ICOM, Drake, Atlas, DenTron, Ten-Tec, Swan, Tempo, KLM, Hy-Gain, Mosley, Wilson, Larsen, Midland Southwest Technical Products. You won't be disappointed with equipment/service. **Radio World**, Oneida County Airport-Terminal Building, Oriskany NY 13424, 337-2622.

Souderton PA

Tired of looking at ads ??? Come and try our new and used equipment yourself—personal advice from our staff's 60 years combined ham experience. **Electronic Exchange**, 136 N. Main St., Souderton PA 18964, 723-1200.

Port Angeles WA

Mobile RFI shielding for elimination of ignition and alternator noises. Bonding straps. Components for "do-it-yourself" projects. Plenty of free advice. **Estes Engineering**, 930 Marine Drive, Port Angeles WA 98362, 457-0904.

DEALERS

Your company name and message can contain as many as 25 words for as little as \$150 yearly (prepaid), or \$15 per month (prepaid quarterly). No mention of mail order business or area code permitted. Directory text and payment must reach us 45 days in advance of publication. For example, advertising for the November issue must be in our hands by September 18th. Mail to 73 Magazine, Peterborough NH 03458, ATTN: Aline Coutu.

THE INCREDIBLES FROM EDGECOM ... NOW AT TOWER ELECTRONICS



FMS-25

Designed to be the perfect mobile rig, the FMS-25 provides you with the same outstanding receiver and transmitter as the System 3000A plus several operating features that provide the utmost in mobile operating convenience. Ten front-panel-programmable memory channels, a built-in band scanner, any transmitter offset, full coverage (144-147.995 MHz), electronic push-button tuning and an advanced PLL synthesizer are just a few of the operating features that make the FMS-25 a fantastic rig. At the low price of \$439 it leaves all the others behind.

TOWER ELECTRONICS CORP.

✓T44

24001 ALICIA PARKWAY
MISSION VIEJO, CALIFORNIA 92675

(714) 768-8900



SYSTEM 3000A

The incomparable System 3000A starts by giving you a receiver with absolutely unequalled performance. The five-pole front-end provides virtually intermod-free reception, even in the most populated areas. Images are at least -60 dB and desensing a minimum of -100 dB. The ten-pole IF filters make adjacent-channel interference a thing of the past (-80 dB at 15 kHz). Add a transmitter that gives you 25 Watts of power, fully adjustable, and advanced PLL synthesizer and you have a pretty good rig. But Edgecom didn't settle for "pretty good." System 3000A also features: Twenty memory channels, a memory channel scanner, a band scanner, any transmitter offset, two priority channels, memory channel monitor, electronic push-button tuning and a full TWO-YEAR WARRANTY. These, and all of the other fine features of System 3000A make it a pretty incredible rig. And at the bargain price of \$549, you're getting much more than your moneys worth.



Novel RTTY Autostart

— we could write a book . . .

Over the years, UARTs and other digital circuits have been used more and more for RTTY circuitry. But here is a new application for UART—a digital autostart. For those not familiar with RTTY or radioteletype, an autostart circuit is one which automatically turns on the motor of a teleprinter when RTTY signals are received. This means that you can leave your receiver tuned to a RTTY frequency continuously, and the teleprinter will automatically copy all RTTY activity on the frequency, even in your absence.

Most autostart circuits detect the presence of a carrier on frequency; they can easily be fooled by CW signals if they happen to be on just the right frequency. They will also turn on if a signal is too weak to be fully copyable, or if the transmission is sent too fast or too slow for the teleprinter to copy. But the circuit described here

doesn't have these faults.

Actually, this circuit can do several things in addition to its autostart ability, with slight modifications. It can convert the speed up or down. It can block out certain types of scrambled characters so they do not get printed. It can also be modified to automatically convert itself to copying just the mark or just the space, rather than both.

The heart of the circuit is the UART, or Universal Asynchronous Receiver-Transmitter. Though it has appeared in a number of amateur projects, here is a simple explanation of what it does. The UART is a 40-pin integrated circuit made in various forms by a number of IC manufacturers. Each manufacturer has his own number for it; some of the more commonly available ones are the S1883 by American Microsystems (AMI), the AY-5-1012 by General Instruments, the COM 2502 by Standard Microsystems,

the 6402 and 6403 by Intersil and Harris, and the TR1602 by Western Digital. Most of these are interchangeable except for some minor differences in power supply requirements and voltage levels. As shown in Fig. 1, the typical UART has two parts, the receiver and the transmitter.

When RTTY data is sent over the air, it consists of two distinct voltage levels called a mark and a space; each character consists of a particular combination of these levels, preceded by a start pulse and followed by a stop pulse. Since voltages cannot be sent over the air, they are converted into two different frequencies in the transmitter; these two audio frequencies or tones are sent over the air, received by the station receiver, and converted back into two voltage or current levels by the terminal unit or TU. As sent, each character consists of a start pulse, five data bits

each of which could be either a mark or space, and then a slightly longer stop pulse. These are sent in order, one after the other, and this process of sending the data bits sequentially is called *serial* data.

In the UART receiver, these serial bits of data are grabbed by flip-flops as they arrive and converted into a *parallel* signal, where all five of the data bits exit the UART at the same time over five different IC pins. (The UART is a universal device intended for other applications than just RTTY, and it can handle up to eight bits per character, so that it actually has eight parallel output pins rather than just five.)

When RTTY signals are sent out over the air, the exact spacing between bits is critical, since the transmitting teleprinter and the receiving teleprinter must operate at exactly the same speed. The most common amateur speed is 60 words per minute; in this

mode, each bit of the transmission lasts exactly 22 milliseconds. In order to time these bits properly, the UART requires an external pulse signal from a clock oscillator, and this sets the speed. This signal must provide exactly 16 pulses during each bit of the RTTY signal; in our case, it requires 16 pulses within 22 milliseconds, which works out to a frequency of 727 pulses per second.

In addition to receiving the data, the UART receiver circuitry checks for some simple errors, such as the absence of the proper start pulse for the required duration or the absence of the correct stop pulse. If the start pulse is wrong, then the UART simply ignores the following character. If the stop pulse is wrong, then the UART receives the character but provides an output on one of its pins to indicate that the stop pulse was wrong.

The transmitter portion of the UART is the exact opposite of the receiver portion. Starting with a parallel signal input and an external clock signal to set the output speed, it generates a serial output which includes first the start pulse, then the five data bits, and finally the stop pulse. For 60 wpm transmission, the clock again has to be at 727 Hz. The receiver and transmitter portions of the UART are independent and can be used separately or together at the same time.

Being a universal device, the UART has several modes of operation. First, it can handle codes of 5, 6, 7, or 8 bits. By just changing a few pin connections, it can handle 8-bit ASCII coding of the type used in computer equipment, 5-bit Baudot code of the type used in amateur RTTY, and other codes as well. It can also generate and receive

an extra bit, called the *parity* bit, which is used to detect errors in the transmission. Moreover, the receiver and transmitter can operate at different speeds so that it can receive at one speed and transmit at another. Not bad for an IC which typically costs between \$6 and \$15, depending on source!

Fig. 2 shows the block diagram of an autostart system based on the UART. The serial input to the UART is taken from the terminal unit or TU; as mentioned earlier, this is the converter which takes in audio tones from the station receiver and converts them into on/off keying signals for the teleprinter. The UART receiver converts these serial pulses into parallel data which is immediately fed over to the transmitter portion of the UART, which converts the signal right back into serial form. At first glance, it looks as though the output of the circuit is just a delayed form of the original.

Actually, in the simplest case, this is true. But if the input signal is distorted, then the output of the UART is a cleaned-up version which has been regenerated. Typically, the RTTY signal coming over the air may have some *bias distortion*. This is a distortion of the on/off pulses in such a way that they are not all equally long, with the

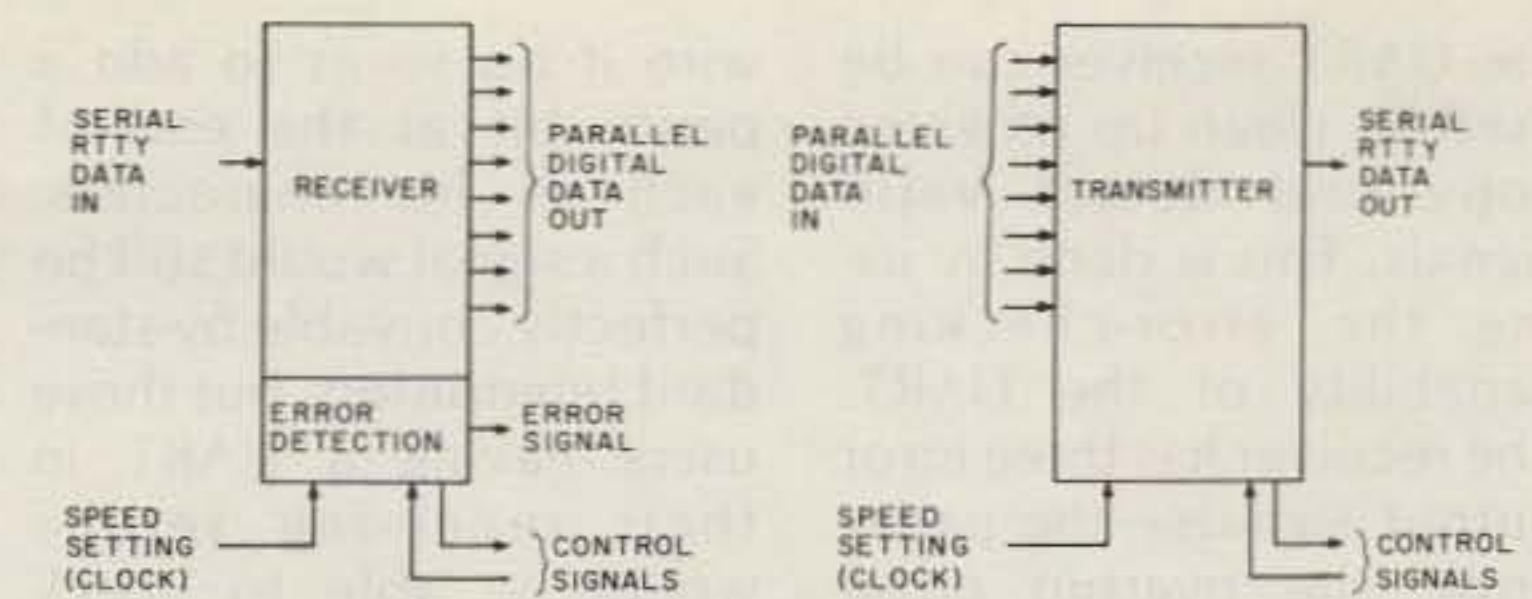

Fig. 1. UART block diagram.

result that the teleprinter may have trouble deciphering the correct letters. As long as the bias distortion is not so great that it succeeds in confusing the UART as well, it will be received by the UART receiver, converted into parallel, and then regenerated by the UART transmitter with no bias distortion whatsoever.

In the block diagram of Fig. 2, both the receiver and the transmitter are driven by the same 727 Hz oscillator; thus both are set up for 60 words per minute transmission. This oscillator is a simple circuit using a 555 timer IC, two resistors, and two capacitors. By simply building one more pulse oscillator such as this one, you can feed the receiver and transmitter from each and have the UART receiver operate at a different speed from the transmitter. A multi-function speed converter can be built if you build three or four such oscillators, one for each RTTY speed you intend to use, and then use

two SP4T switches to select one of the four for the receiver and another for the transmitter. A simple DPDT switch added to this will allow flipping the two speeds so that you can reverse the speed conversion for receiving and transmitting over the air. For example, you could set your teleprinter permanently for 100 wpm; to use 60 wpm over the air, you would speed up received signals from 60 to 100 to fit your printer. In transmitting to the other station, you would slow down the 100 wpm signal from your keyboard to 60 wpm over the air. The correct oscillator frequencies are 727.27 Hz for 60 wpm, 812.12 Hz for 67 wpm, 909.09 Hz for 75 wpm, and 1192.25 Hz for 100 wpm. An electronic speed converter such as this is a great improvement over the traditional solution—having a gearbox on your teleprinter for changing speed.

In addition to regenerating the signal and allowing the speed to be changed,

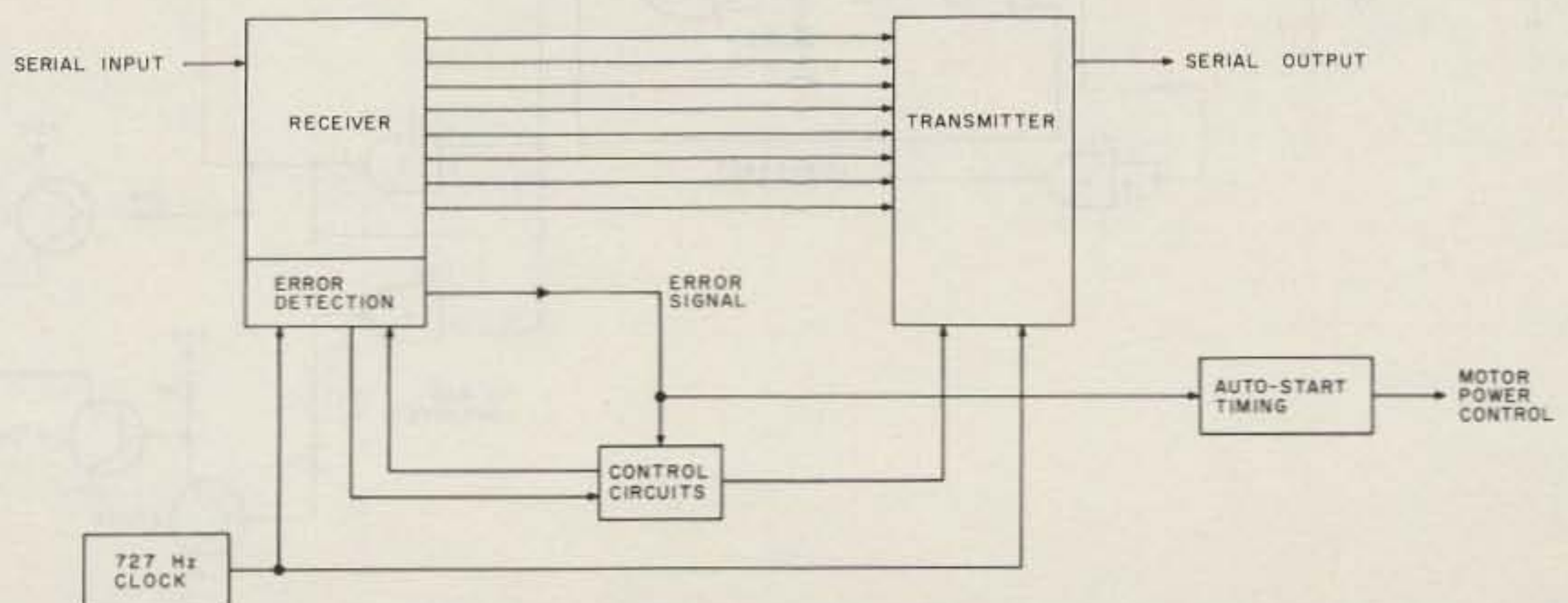

Fig. 2. System block diagram.

the UART receiver can be used to clean up received copy and detect valid signals. This is done by using the error-checking capability of the UART. The receiver has three error output signals—the parity error, the overrun error, and the framing error, on pins 13, 15, and 14 respectively. The parity bit is an extra bit that may be added by the transmitter depending on the particular bit pattern used by the character being sent; the receiver then checks that parity bit to make sure it is correct. If the parity bit is wrong, that indicates that one of the bits in the character has been changed—an error, which causes the parity error output to go positive. This is not very useful in amateur RTTY, since the Baudot code used does not include parity checking. (However, here is a great idea: If the station on the other end is using a UART to transmit, he could

wire it up so as to add a parity bit at the end of each of his characters. Such a signal would still be perfectly copyable by standard teleprinters, but those users having a UART in their receiving setups would be able to check parity. I am not sure whether current FCC regulations would permit the parity bit, but it should not bother the FCC monitoring stations since they could still copy on their standard machines without change.)

The second error output is the overrun error, which is also not of much use in typical applications as it simply means something is wrong in the control circuits connected to the UART.

The framing error output, on the other hand, is useful. This signal comes on when the stop bit, which is supposed to be at the end of each character, is missing or wrong. The UART actually checks

each and every character—be it letter, number, or punctuation mark—for the proper stop pulse. If the stop pulse is wrong, the framing error output on pin 14 changes from its normal 0 volts to approximately +5 volts and stays at the higher voltage until the next correct stop pulse on the following character.

The framing error output can be used in several ways. First, it can be used to turn off the UART transmitter so that it does not regenerate the scrambled character. In this way, only those characters received with the correct stop pulse would actually get through the UART. This can be good or bad, depending on how the character got garbled. Very sharp pulse-type noise such as ignition noise might affect only a very small portion of a character, with the result that the stop pulse might be wrong and yet the rest

of the character could be okay. On the other hand, the stop pulse may be correct and yet the rest of the character could be wrong. With atmospheric noise or fading, you have the other situation: If the stop pulse is wrong, it is quite likely that the entire character is wrong. As one of its features, this autostart has the capability to blank out (not print) those characters having the wrong stop pulse.

Finally, the framing error output is used to turn the teleprinter motor on and off, through appropriate timing and control circuitry. When receiving a clean, undistorted RTTY signal, the UART will never generate a framing error output. In this case, after a short delay, we turn on the teleprinter motor. When receiving a bad signal, on the other hand, the framing error output will periodically come on. In the presence of noise, CW, or RTTY signals of the wrong

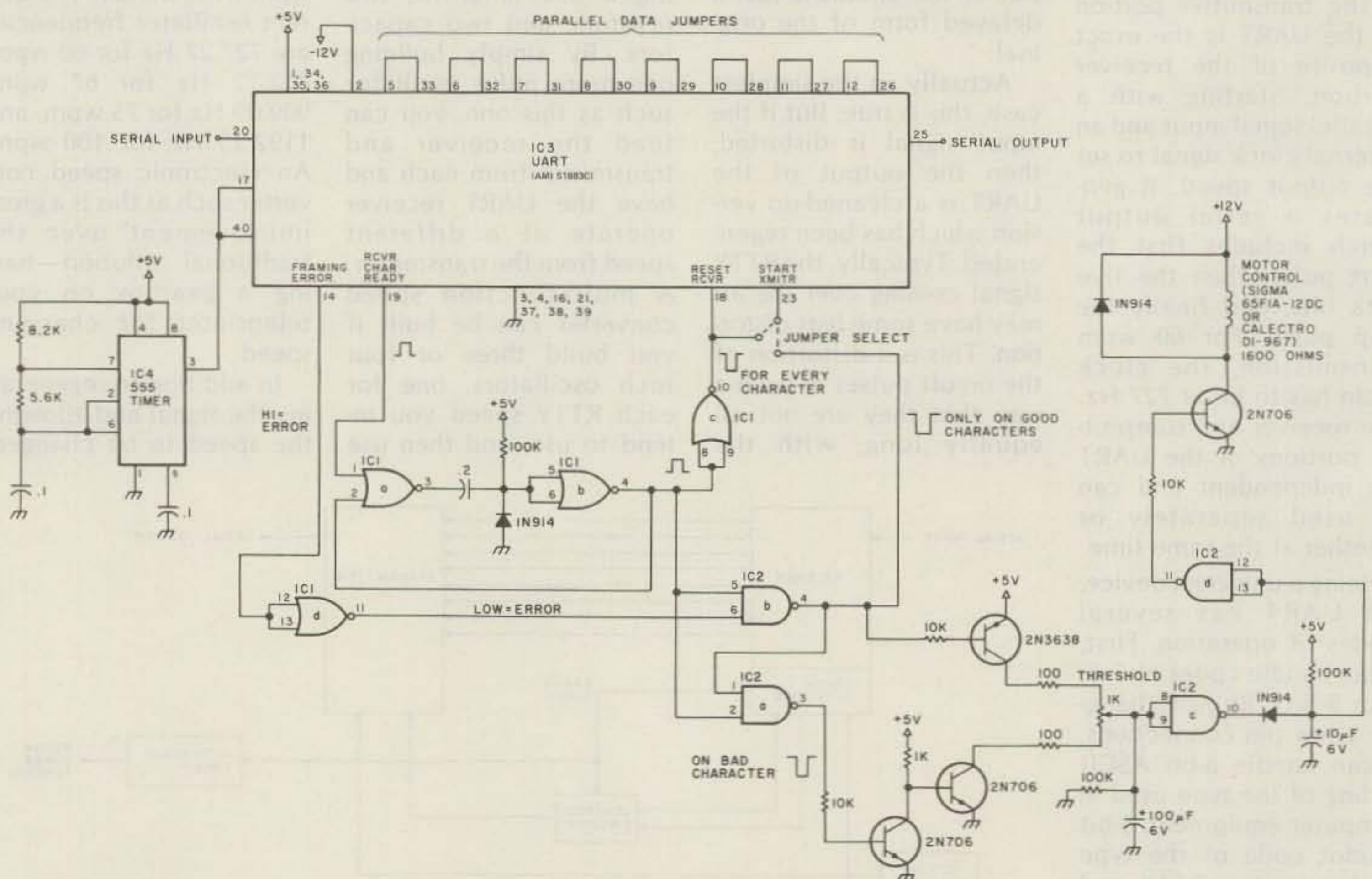

Fig. 3. Complete autostart diagram. IC1—4001 quad 2-input CMOS NOR. IC2—4011 quad 2-input CMOS NAND. Both ICs—ground pin 7, +5 V to pin 14.

speed, the framing error will continuously pulse on and off at random. If this happens, the timing and control circuits turn off the motor. The autostart timing circuit has a potentiometer which can be set to any threshold you wish. For example, it can be set so that out of any five characters received, at least three or four must have the correct stop pulse. In this way, it is possible to set the autostart so that it will be completely immune to CW or other interference and will copy only good signals.

There is another interesting possibility here, which I will mention to indicate how it may be done, but which I have not actually tested. In the autostart timing circuits, there is a capacitor whose voltage indicates how good the copy is. On bad signals or noise, its voltage will be near 0 volts; on good copy, it will read near +5 volts. Suppose you had two antennas, two receivers, and two TUs, each driving its own UART autostart circuit. Simply by comparing the voltages across the two capacitors, you could tell which receiver was getting a better copy and switch that signal to the printer. With two different antennas—perhaps one horizontal, the other vertical—you would get the effects of diversity receiving, since fading at the two might be different and at any given time one or the other antenna might provide a signal while the other is dead. Another possibility is to have one antenna and receiver, but three different TUs arranged so that one copies both marks and spaces, one copies only marks, and one only spaces. By comparing the voltages across this one capacitor in all three UART circuits, automatic switching be-

tween the TUs could produce the best copy. An even more complex circuit could compare the parallel outputs of the three UARTs and print only those characters that two out of the three UARTs agree on. But enough of this diversion—it's beyond the scope of this article. Perhaps next year...

Back to the autostart. Fig. 3 shows the complete diagram. Up at the top, we have the UART. The serial input is on pin 20 and the serial output is on pin 25. These are TTL-compatible outputs and connection to your own TU depends on the model, so it is not shown. *Do not connect into the loop supply.* Multiple power supply and ground connections are required as shown, and the parallel data jumpers are also shown at the top. For Baudot, only the jumpers connected to pins 8 through 12 are required, but in case you decide at some later time to use this for ASCII, you might as well connect all eight jumpers. In any case, it is not nice to leave inputs on MOS ICs unconnected because of the possibility of static damage, so these connections are important from a safety point of view.

A 555 timer, IC4, provides the 727 Hz pulses for UART timing. The values of resistors and the capacitor connected to pins 7, 2, and 6 are those which will cause operation near 727 Hz. For precise frequency adjustment, the 5.6k resistor could be replaced by a 10k pot. In my case, I simply tried several different combinations until I got one that hit 727 Hz exactly. This clock signal is connected to pin 17, which is the clock input for the UART receiver, and pin 40, for the UART transmitter. For multi-speed operation, pins 17 and 40 could be disconnected from each other and each driven from

its own oscillator.

Each time the UART receiver gets a new character on its serial input, it provides a narrow pulse on pin 19. This pulse is stretched to about 20 milliseconds by the one-shot made up of IC1a and IC1b. (IC1 and IC2 are CMOS gates and cannot be replaced by TTL without major changes, as the timing circuits connected to IC1b and IC2d would have to be changed completely.) The output of IC1b is a longer positive pulse which is inverted into a negative pulse and sent to UART pin 18, which resets the receiver so that it can accept the next character.

As each character is received, the framing error output on UART pin 14 goes low if the stop pulse is received correctly, and goes high if it is not. This is inverted by IC1d and gated with the positive pulse appearing for each character in IC2b. The output on pin 4 of IC2b is a negative pulse which appears only on good characters, that is, on characters which have been received with the correct stop pulse. This resulting pulse can be applied back to pin 23 of the UART, which starts the transmitter. A jumper connected to pin 23 allows one of two options. If the jumper is connected to pin 18, then all characters received by the UART will be sent out through the serial output, regardless of whether they are correct. On the other hand, if the jumper goes down to IC2b, then only correctly received characters would be output. In my system, this jumper is permanently connected to IC2b, but you might prefer an SPDT switch at this point. If so, connect a 100k resistor from pin 23 to ground to prevent static damage to the UART as the switch is changing.

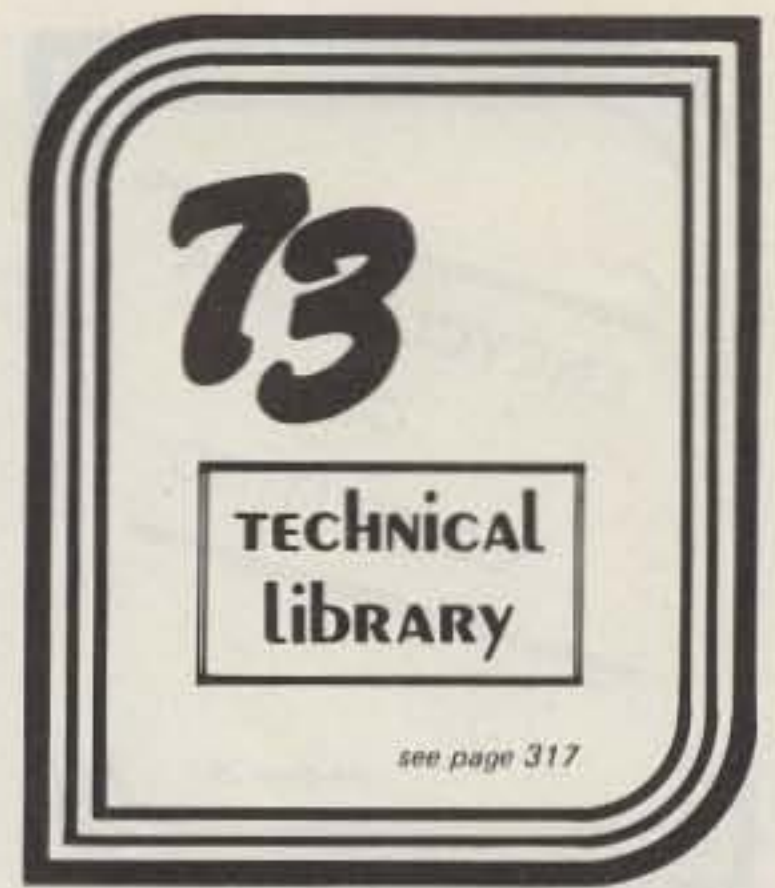

As mentioned before, the output of IC2b is a negative pulse which comes at the end of each correctly-received character. This is gated with the pulse coming from IC1b, which is a positive pulse appearing for every character. The result, at the output of IC2a, is a negative pulse which appears only on *bad* characters, that is, characters with the wrong stop pulse.

When a good character is received, the negative pulse turns on the 2N3638 PNP transistor, which goes on and feeds some current through the 100-Ohm resistor and the threshold pot into the 100-uF capacitor. Since the pulse only lasts about 20 milliseconds, the capacitor gets a shot of current which causes its voltage to rise slightly.

When a bad character is received, the negative pulse from IC2a turns on the second 2N706 transistor, which discharges the 100-uF capacitor through the 100-Ohm resistor and the threshold pot. Again, since the pulse only lasts a short time, the capacitor is not fully discharged; instead, its voltage just falls by a slight amount. How much the capacitor charges and discharges depends on the setting of the threshold pot. On the top end, it would charge rapidly from just a few good characters, while

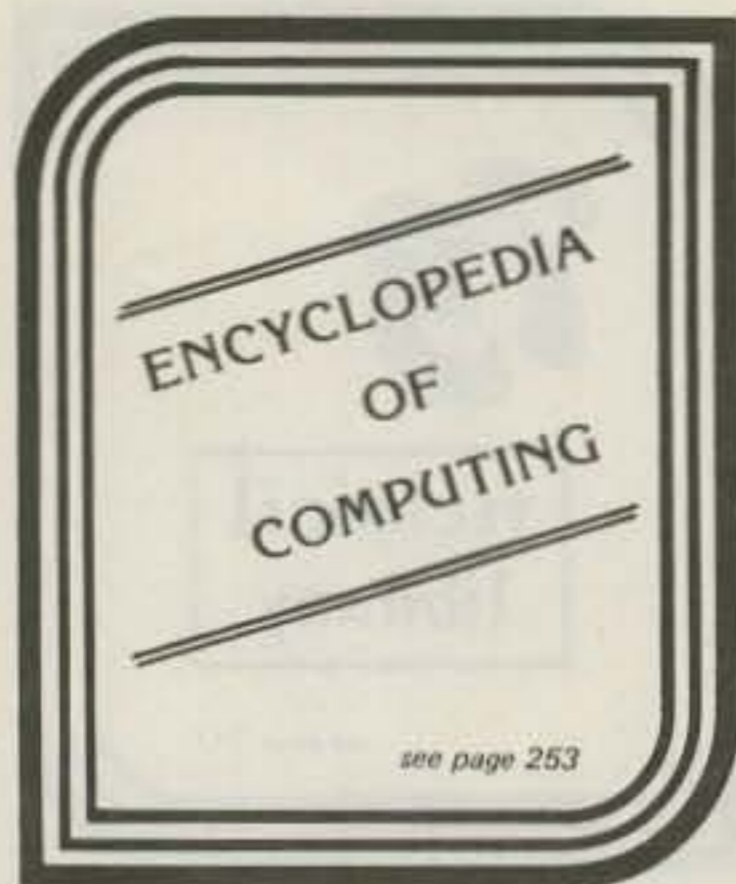

many bad characters would be required to discharge it. Adjusted to the bottom end, the pot would have the opposite effect—many good characters would be required to charge the capacitor, while just one or two bad ones would discharge it again. In the middle of the pot is a range of useful settings which allows a certain proportion of bad characters amidst the good, but not too many. In

the absence of any characters at all, the 100k resistor directly across the capacitor would discharge it in about 15 seconds (or less if the preceding copy had been bad, so that the capacitor was not fully charged to begin with). Thus the voltage across this capacitor indicates how good the copy is.

The capacitor voltage is monitored by IC2c and applied, through a simple time delay, to IC2d, which drives a keying transistor to control a low power relay. The purpose of the timing circuit between IC2c and IC2d is to prevent the power from going on and off too fast on marginal copy. Once the motor is on, it will stay on for a few more seconds even if the signal immediately gets bad. (But the bad characters will not be printed if the jumper on pin 23 of the UART is con-

nected to IC2b.)

The keying relay should be a low power model such as the Sigma 65F1A-12DC or Calectro D1-967, both of which have a 1600-Ohm coil, so that there is not too much of a load on the CMOS circuitry. Relays with lower resistance coils could be used if the 2N706 driver transistor is replaced with a Darlington transistor.

In operation, the auto-start circuit seems to work reasonably well. On the low bands, where noise is a problem, it works best when combined with a standard tone-activated autostart. It then reduces the probability of falsely turning on the printer motor in the presence of noise or CW. On VHF, where noise is not so much of a problem, it is much more valuable, especially since often phase-locked-loop or other simple TU

decoders are used, which are not readily usable with conventional autostart circuits; in that case, the UART autostart is extremely useful.

If better adjustment is desired, the 1k threshold pot may be replaced by two separate pots in the range of 1k to 10k each, allowing independent adjustment of the charging and discharging currents to the 100 uF capacitor. It is then possible to set the threshold for any ratio of good to bad characters and any time delay for turn-on.

I have my threshold control set so that one bad character out of every five is okay, but two bad ones out of every five turns off the motor. This seems to be an acceptable compromise. All in all, it is an interesting circuit, and it has many possibilities for expansion, some of which I hope to try soon. ■



The LEADER In the Northwest!

ATLAS • ICOM • KENWOOD • YAESU



KENWOOD Transceiver TS-520S 160 thru 10M



KENWOOD Transceiver TS-820S 160 thru 10M

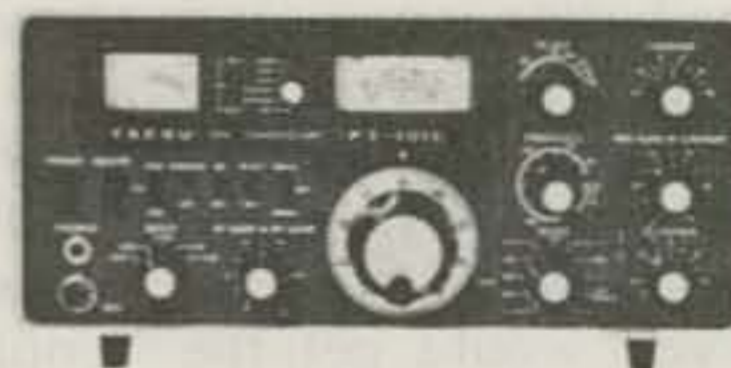

YAESU HF SSB 160 thru 10M FT 101F or FE



YAESU 901 DM



ABC
COMMUNICATIONS A46



17550 15th Ave. N.E. • Seattle WA 98155 • (206) 364-8300



Other locations: (Walk-in customers only) • Bellevue—12001 N.E. 12th • Everett—4610 Evergreen Way • Open Mon. thru Sat.

CALL TOLL FREE

1-800-228-4097

FOR EDGECOM . . .



THE INCOMPARABLE SYSTEM 3000A

- *TWENTY FRONT-PANEL-PROGRAMMABLE CHANNELS.
- *TWO BUILT-IN SCANNERS
- *MEMORY-CHANNEL MONITOR.
- *ANY TRANSMITTER OFFSET.
- *FULL TWO-YEAR WARRANTY.

LIST PRICE ONLY \$549

THE FMS-25 . . . ONLY \$439



- *BUILT-IN SCANNER
 - *TEN FRONT-PANEL-PROGRAMMABLE MEMORY CHANNELS
 - *ANY TRANSMITTER OFFSET
 - *ELECTRONIC PUSH-BUTTON TUNING
 - *25 WATTS OUTPUT
 - *SUPERIOR INTERMODULATION PERFORMANCE
- FMS-25 . . . PERFORMANCE THAT CHALLENGES YOUR IMAGINATION**

■■■■■ LOOK! ■■■■■

HOURS: Monday - Friday 8 a.m. - Midnight
 Saturday 8 a.m. - 8 p.m.
 Sunday Noon - 8 p.m.

Communications Center

The Radio Store

✓ C96



443 N. 48th, Lincoln, Nebraska 68504

In Nebraska Call (402)466-8402

The Easiest Offset Ever

— a treat for 2

Marion D. Kitchens K4GOK
7100 Mercury Ave.
Haymarket VA 22069

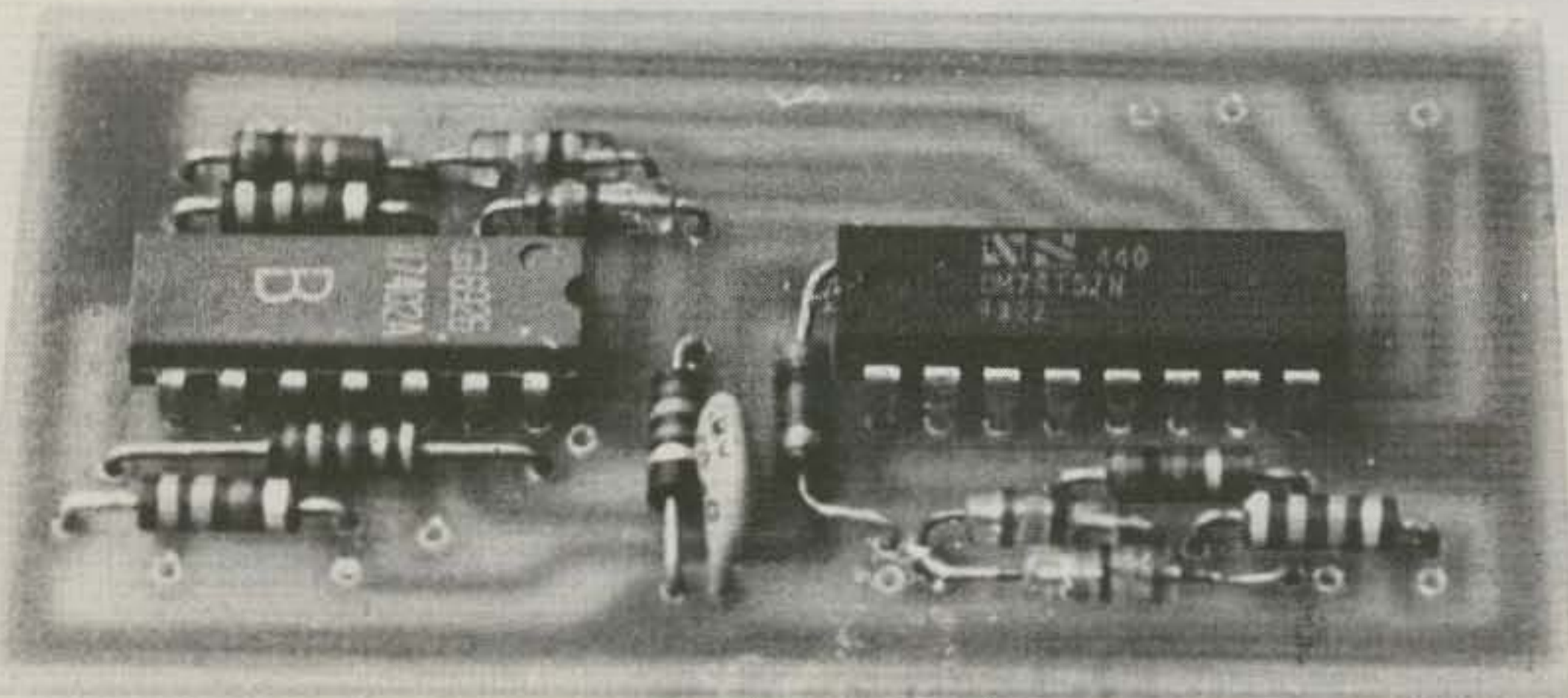

Assembled circuit board—standard TTL version.

This simple digital circuit automatically provides the proper 600-kHz offset frequency for use on standard 146-MHz and 147-MHz 2 meter FM repeaters. 600 kHz is subtracted for 146-MHz repeaters and 600 kHz is added for 147-MHz repeaters. Normal repeater, simplex, or inverted operation, is obtained by positioning a single switch. Simplex frequencies are automatically obtained on the standard 146-MHz and 147-MHz simplex frequencies, independent of the Repeater-Simplex-Inverted switch position. These functions occur automati-

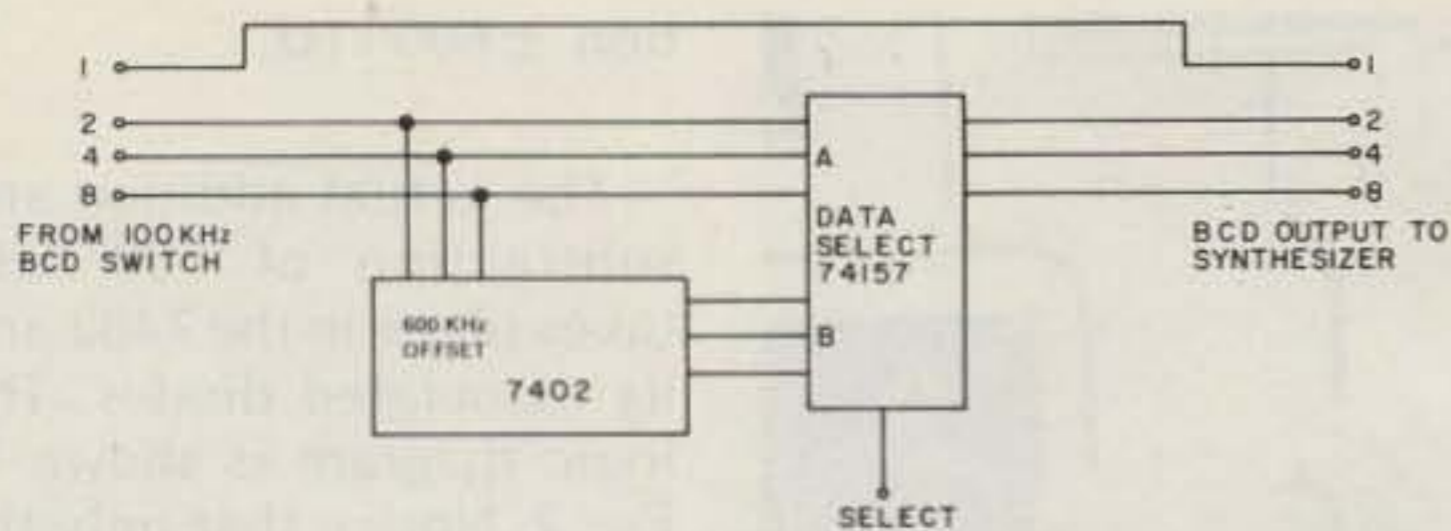

Fig. 1. Functional block diagram.

cally, requiring only selection of the receive frequency and operation of the PTT switch.

The circuit requires only one set of BCD switches, so synthesizers employing two sets of BCD switches can be set to two of your favorite repeater frequencies and then switched from one to the other by simply flipping the synthesizer receive switch from one set of BCD switches to the other. Likewise, the user can dial in a frequency, say 146.52 MHz, on one set of BCD switches, while transmitting on 146.37/.97 with the other set of BCD switches. Operation on either 146.52 MHz simplex or on 146.37/.97 MHz repeater is obtained by flipping the synthesizer receive switch to the desired frequency. This is fast, easy, and convenient operation as compared with the usual switching that must be done with most synthesizers.

The circuit presented here will operate with synthesizers that use standard BCD frequency-control switches and have TTL-compatible programmable dividers. The circuit is very simple, requiring only two IC chips and associated resistors and diodes. Two circuit variations are presented: one using standard TTL chips and one using the low-power 74L00 chips. Both variations use the same circuit board with only resistor value changes.

Circuit

This 600-kHz offset circuit is based on a similar

circuit by Paul Quinn WB4PHO.* WB4PHO's article was the first place that I had seen the required digital logic so simply implemented. He presents a very simple solution to what could have become a very complicated problem.

The 600-kHz offset circuit operates on the 100-kHz information from the synthesizer BCD switches. The circuit is connected between the BCD switches and the synthesizer programmable dividers. Fig. 1

*P. Quinn WB4PHO, "Automatic 600-kHz Up/Down Repeater-Mode For Two-Meter Synthesizers," *Ham Radio*, January, 1977, page 40.

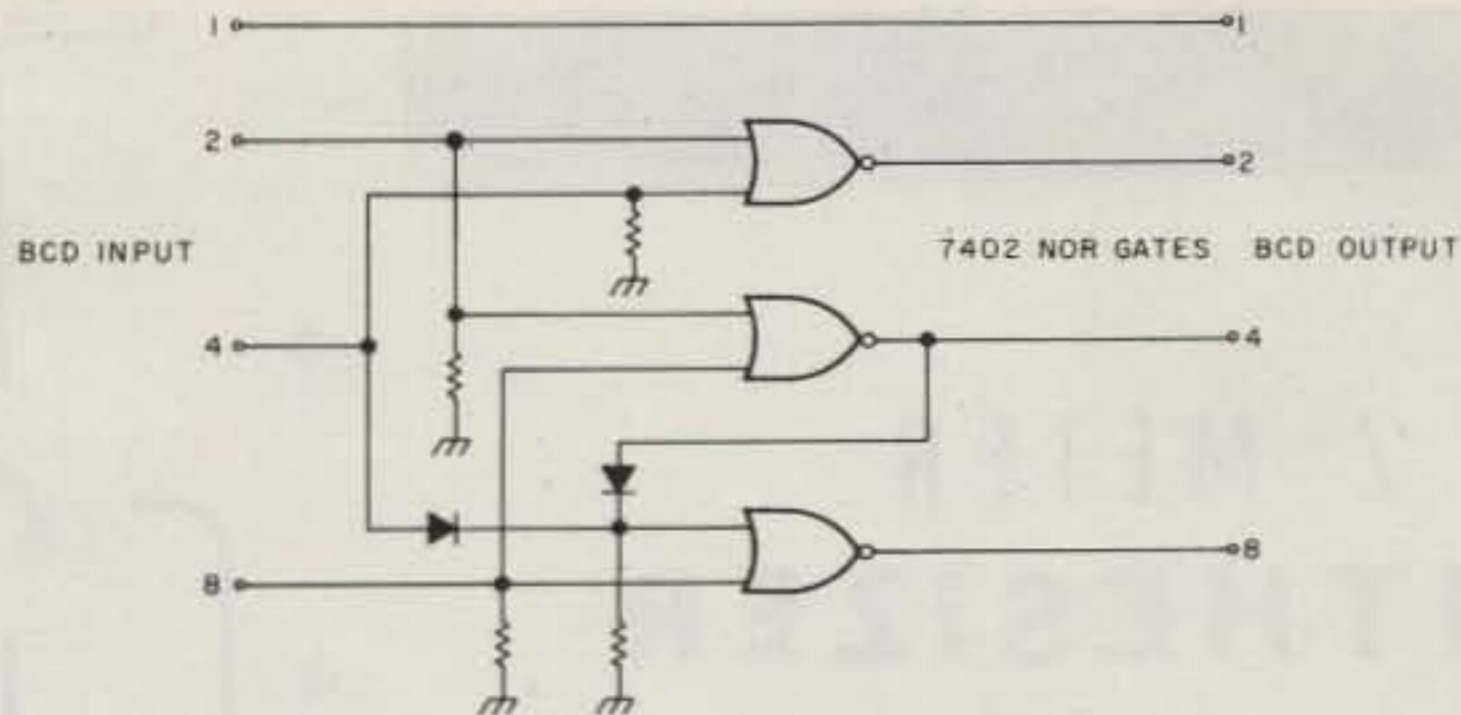

Fig. 2. 600-kHz offset logic diagram.

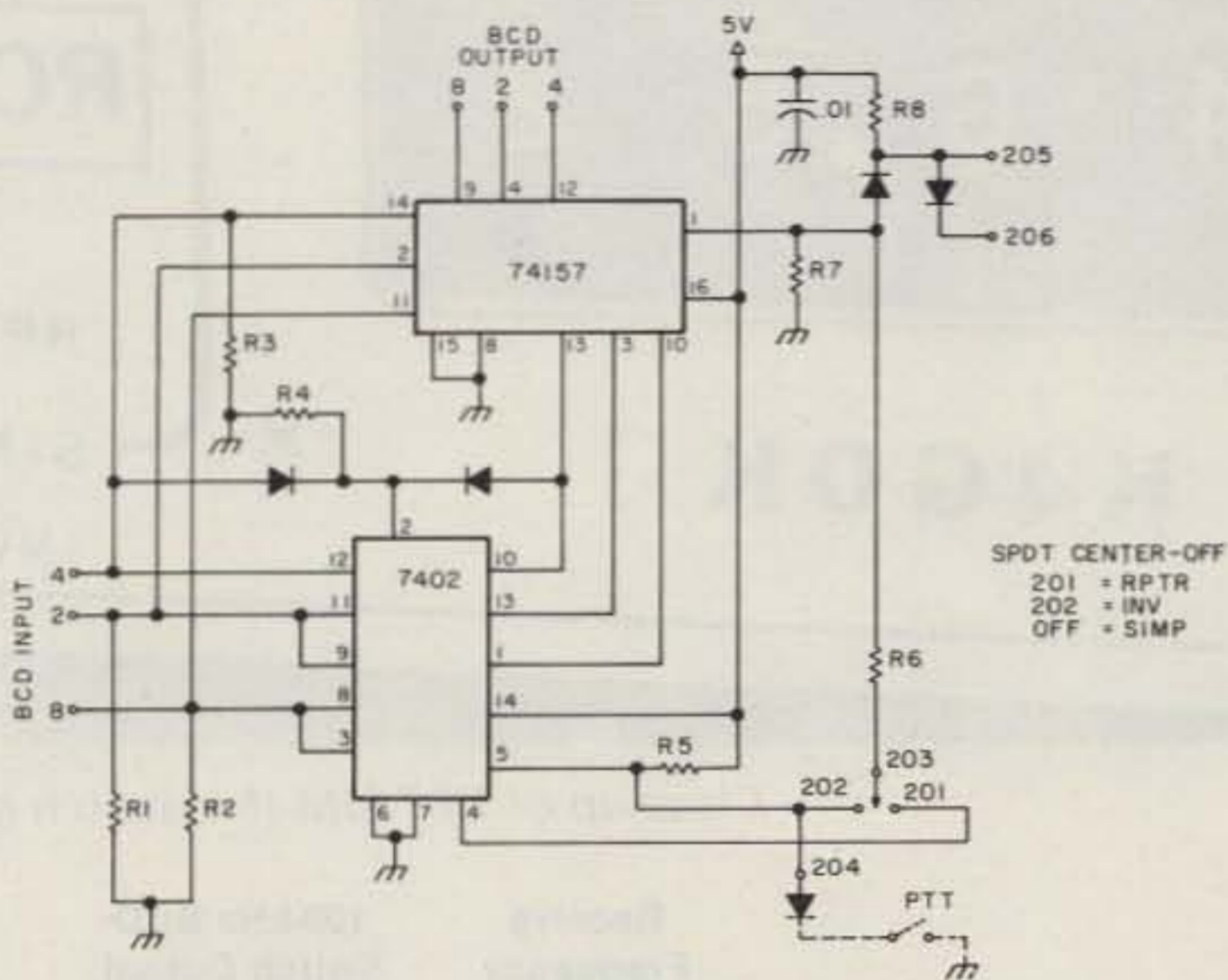
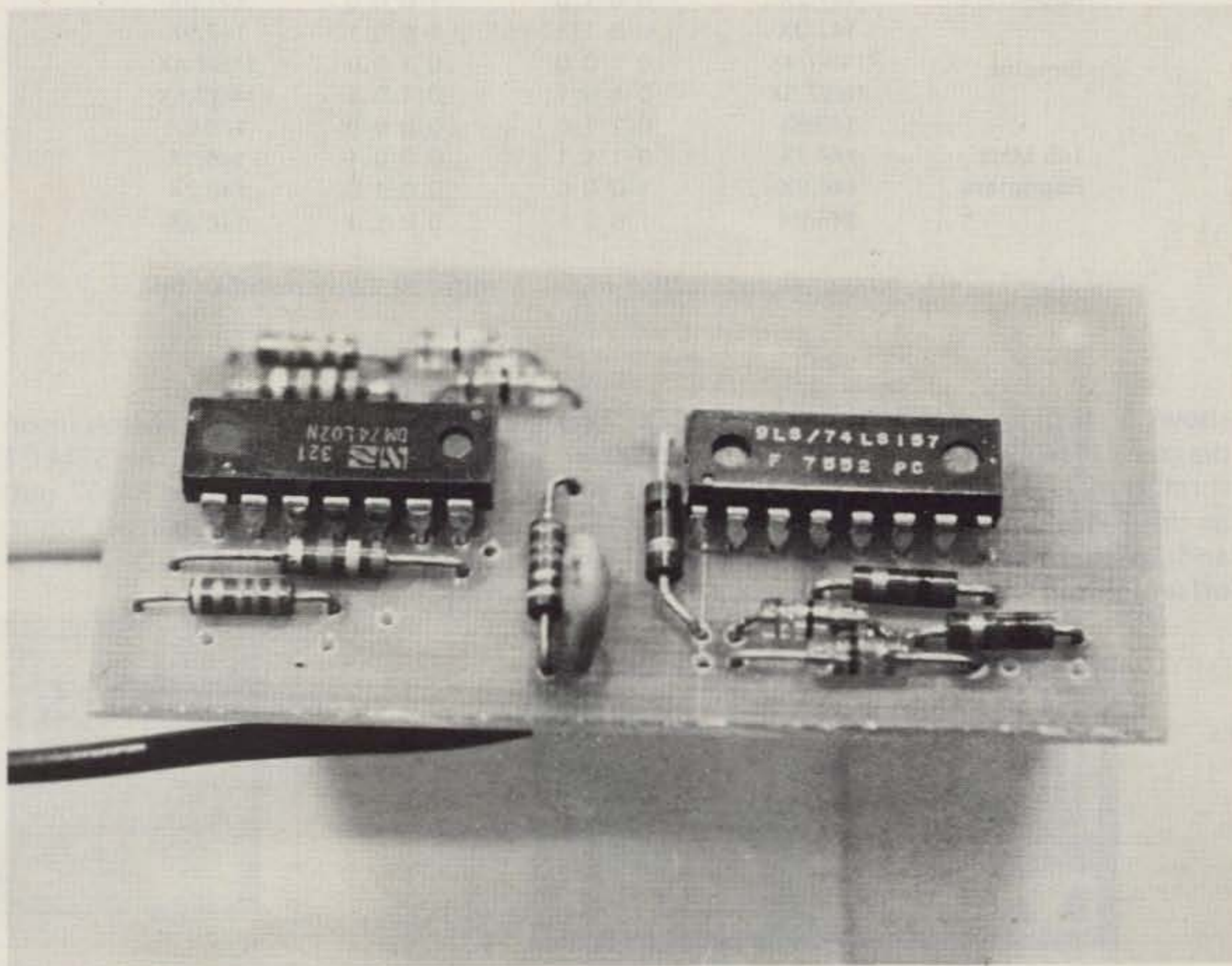
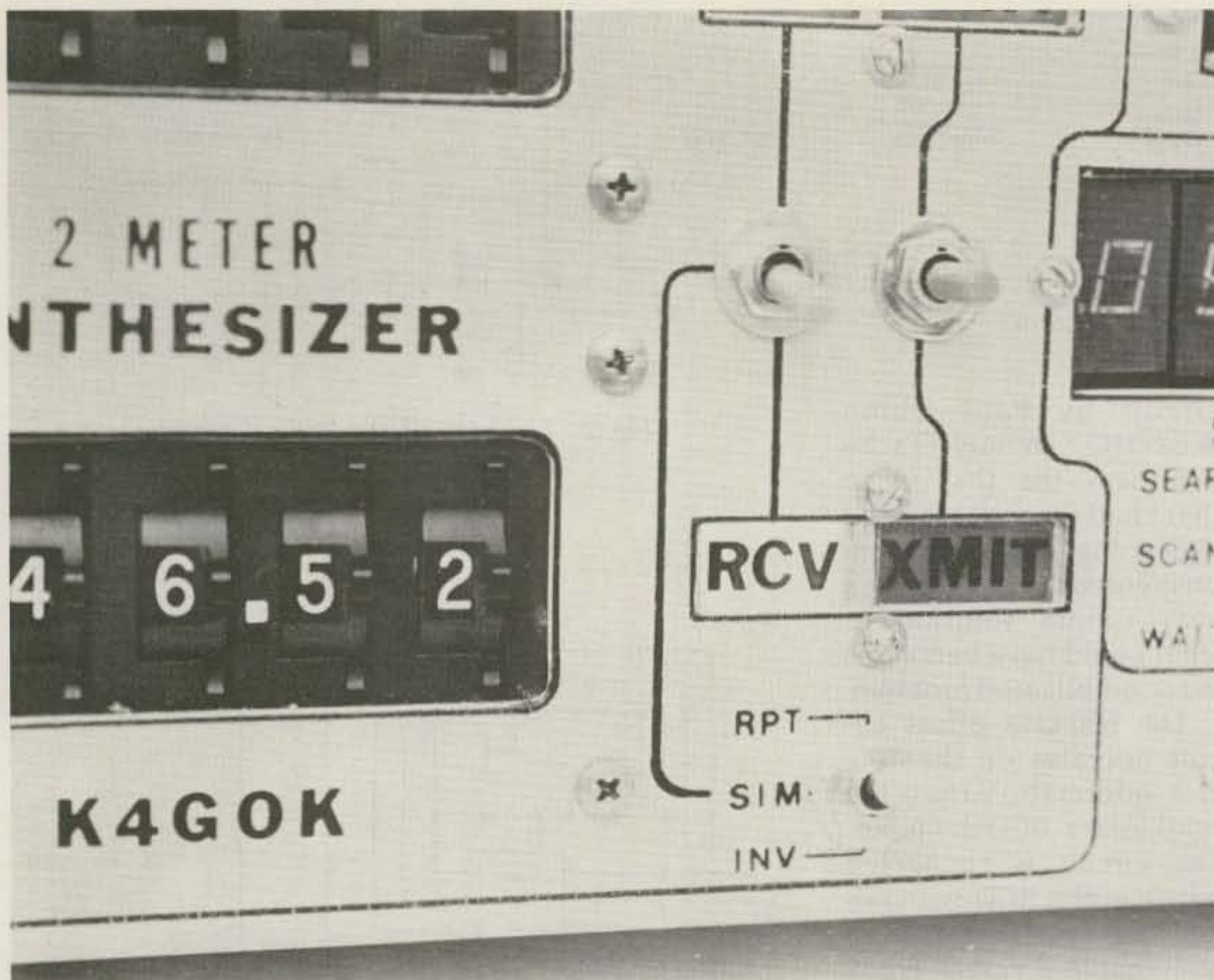

Fig. 3. 600-kHz offset schematic diagram.



Assembled circuit board—low-power version (74L00 series).



Close-up of RPT-SIM-INV switch installation.

| | Receive Frequency | 100-kHz BCD Switch Output D C B A | 7402 Output D C B A | Resulting Transmit Frequency |
|-------------------|-------------------|--------------------------------------|------------------------|------------------------------|
| 147 MHz Repeaters | 147.0X | 0 0 0 0 | 0 1 1 0 | 147.6X |
| | 147.1X | 0 0 0 1 | 0 1 1 1 | 147.7X |
| | 147.2X | 0 0 1 0 | 1 0 0 0 | 147.8X |
| | 147.3X | 0 0 1 1 | 1 0 0 1 | 147.9X |
| Simplex | 146/7.4X | 0 1 0 0 | 0 1 0 0 | 146/7.4X |
| | 146/7.5X | 0 1 0 1 | 0 1 0 1 | 146/7.5X |
| 146 MHz Repeaters | 146.6X | 0 1 1 0 | 0 0 0 0 | 146.0X |
| | 146.7X | 0 1 1 1 | 0 0 0 1 | 146.1X |
| | 146.8X | 1 0 0 0 | 0 0 1 0 | 146.2X |
| | 146.9X | 1 0 0 1 | 0 0 1 1 | 146.3X |

Table 1. 7402 circuit input/output logic. X indicates any number 0-9.

shows a functional block diagram. The 100-kHz information is applied both to the 74157 data selector and to the 7402 600-kHz offset logic. The 74157 per-

forms as a 4PDT switch (only 3 poles are actually used in this application). When the 74157 SELECT line is low, its output is equal to its A input, in this

case the BCD switch information. When the SELECT line is high, the 74157 output is equal to its B input, which is the BCD informa-

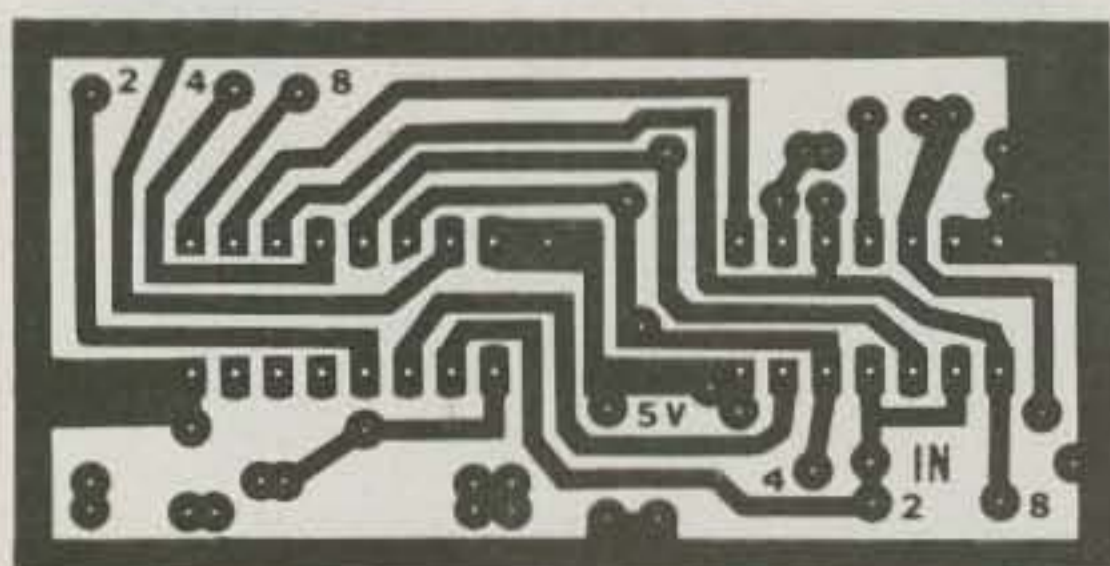

Fig. 4. 600-kHz offset circuit PC board.

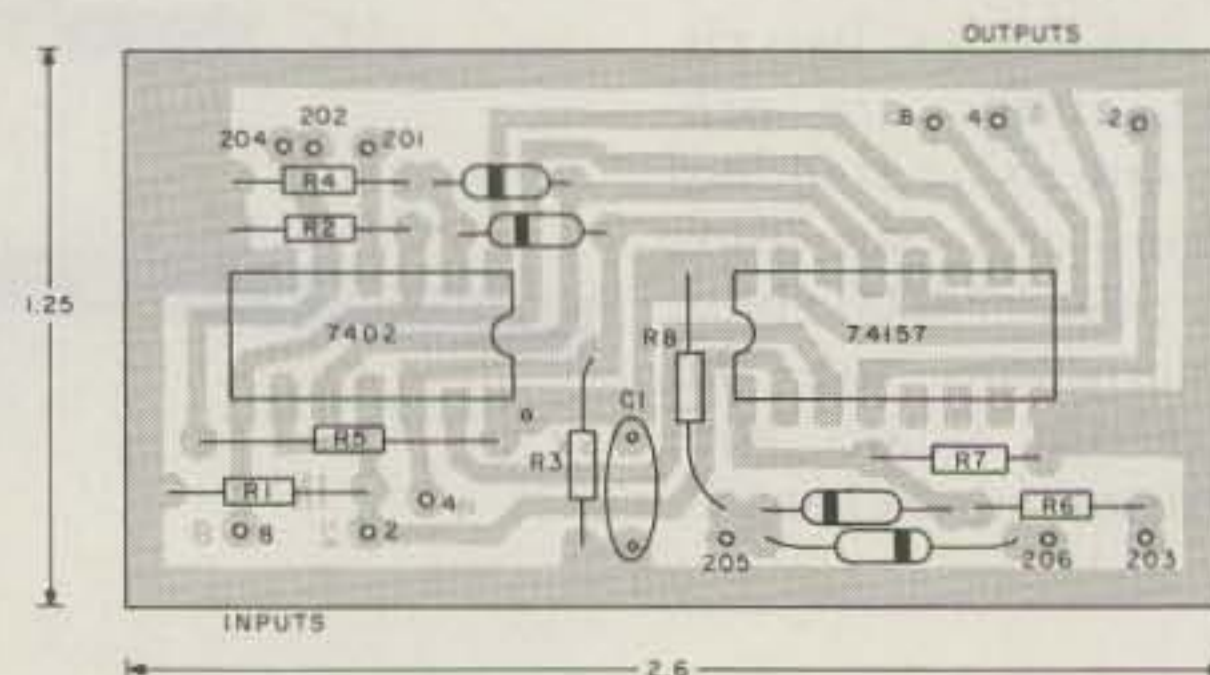

Fig. 5. 600-kHz offset circuit parts location.

tion ± 600 kHz.

The actual addition and subtraction of 600 kHz takes place in the 7402 and its associated diodes. The logic diagram is shown in Fig. 2. Notice that only the 2, 4, and 8 bits of the BCD information are used. The 1 bit is simply fed through. The truth table for this portion of the circuit is shown in Table 1. The table shows input frequencies and circuit BCD input and the resulting BCD output and frequencies. Note that for normal repeater operation, proper frequencies are obtained. A 146.97 MHz input (for receive) yields a 146.37 MHz output (for transmit); a 147.15 MHz (for receive) yields a 147.75 MHz output (for transmit). All input frequencies from 146.40 to 146.59 MHz and 147.40 to 147.59 MHz result in simplex operation, i.e., the input frequency equals the output frequency.

Since the circuit operates only on the information in the 100-kHz BCD switch, it cannot distinguish between 146 and 147 MHz frequencies. A 146.31 MHz input will then result in a 146.91 MHz output. This feature, when combined with the proper PTT switching logic, allows inverted operation. When the Repeater-Simplex-Inverted switch is in the Repeater position, the PTT switch causes the 74157 to provide the BCD-switch information to the synthesizer for receive and to provide

the 7402 output information for transmit. When the switch is in the Inverted position, the PTT logic is simply inverted to invert the above condition. When in the Simplex position, the BCD-switch information is fed through the 74157 independent of the PTT switch. Note that for the standard simplex frequencies (146.40 to 146.59 and 147.40 to 147.59), simplex operation occurs independent of the position of the Repeater-Simplex-Inverted switch, because the BCD-switch information and the 7402 output information are the same for these frequencies. The complete schematic diagram is shown in Fig. 3.

Construction

Construction is straightforward through the use of either the printed circuit board shown in Fig. 4 or with vectorboard or other means the builder may have available. Layout is not critical. Fig. 5 shows the parts location for the PC board. The synthesizer XMIT select switch (for selecting between the two BCD switch sets) must be replaced with a DPDT center-off switch and wired as shown in Fig. 6. This switch is set in its center (off) position for operation of the 600-kHz offset circuit. The 600-kHz circuit is disabled, and normal synthesizer operation is obtained with the switch in either of its other two positions.

Disconnect the 2, 4, and 8 leads between the 100-kHz BCD switches and the synthesizer programmable dividers and rewire according to Fig. 7. Then wire the Repeater-Simplex-Inverted switch, and the unit is ready to be tested. Power should be from a 5.0-volt regulated source. Circuit operation should be checked before on-the-air operation is tried. Make sure that the proper BCD information exists at the circuit output for all conditions of input frequencies, PTT-switch position, and Repeater-Simplex-Inverted switch positions.

If improper operation is experienced, check to see that the input pull-down resistors do pull the gate inputs to 0.8 volts or less. Also check to see that the BCD frequency switch output is capable of driving the gate inputs to about 1.5 volts. The standard TTL version requires about 10 mA total current at 1.5 volts input to the gates under worst-case conditions. The low-power version (74L00 series) requires about 2 mA at 1.5 volts. Table 2 shows the component values for both the standard TTL and the low-power versions.

Other Offsets

Offsets other than 600 kHz may be of interest to some readers. Fig. 8 shows a concept for a selectable

| Component | Description | |
|-----------|--------------|-----------|
| | Standard TTL | Low Power |
| U1 | 7402 | 74L02 |
| U2 | 74157 | 74L157 |
| R1 | 330 Ω | 2.2k |
| R2 | 330 Ω | 2.2k |
| R3 | 560 Ω | 2.2k |
| R4 | 1k | 4.7k |
| R5 | 1.8k | 2.2k |
| R6 | 470 Ω | 1k |
| R7 | 1k | 2.2k |
| R8 | 1k | 2.2k |
| C1 | .01 uF | .01 uF |

All diodes are 1N34 or similar.

Table 2. Component values.

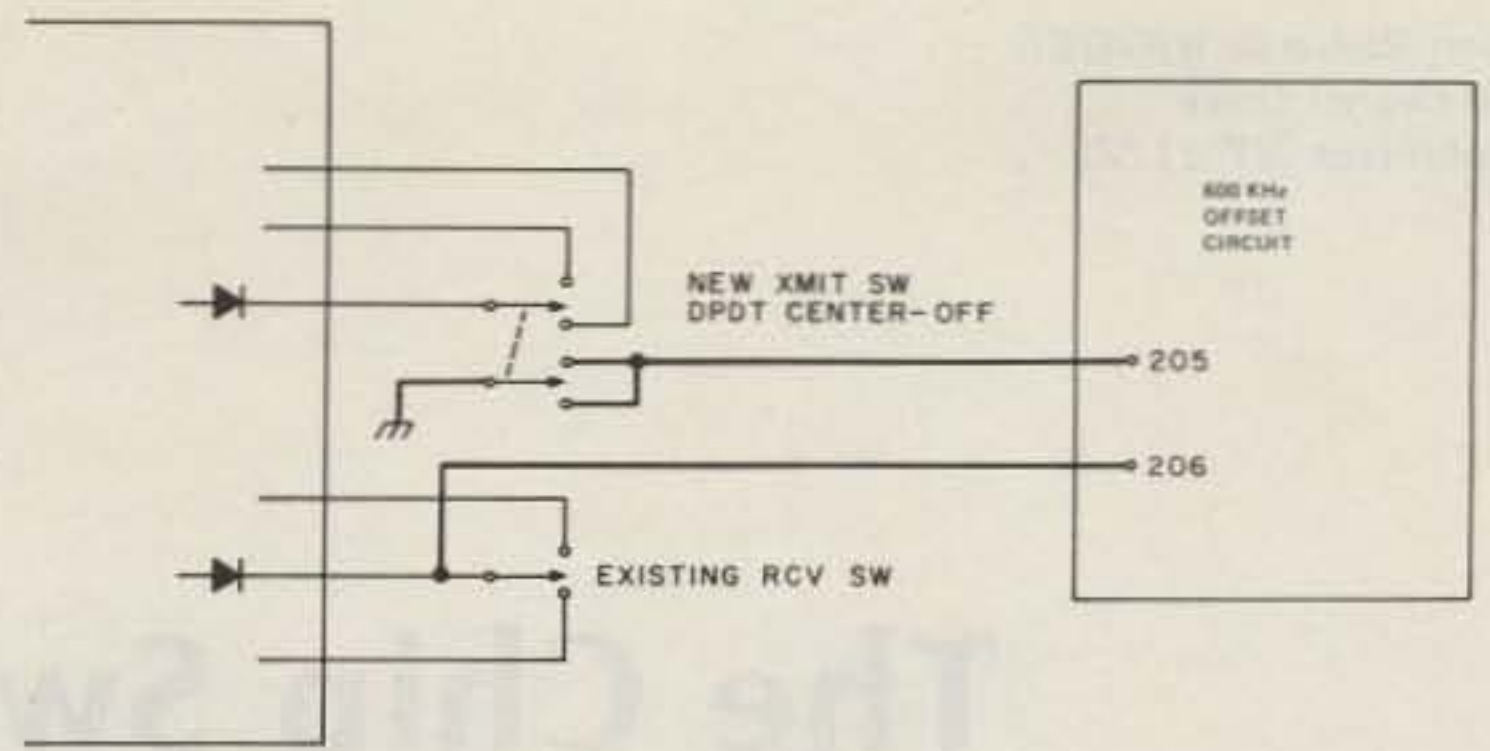

Fig. 6. Synthesizer switch wiring. Replace the transmit switch and add wiring shown in heavy lines.

offset circuit. The desired offset is selected by the BCD switch and is subtracted (for 146-MHz repeater frequencies) or added (for 147-MHz frequencies) by the 74181 arithmetic logic chip. The 7400 chip provides the control logic for transmit-receive and repeater-simplex-inverted operations. This concept is presented for the ex-

perimenter or home brewer who wishes to pursue it; it is a "paper design" at this time and has not been tested.

Acknowledgement

I would like to express my indebtedness to Paul Quinn WB4PHO, whose article in *Ham Radio* provided the basis for this circuit. ■

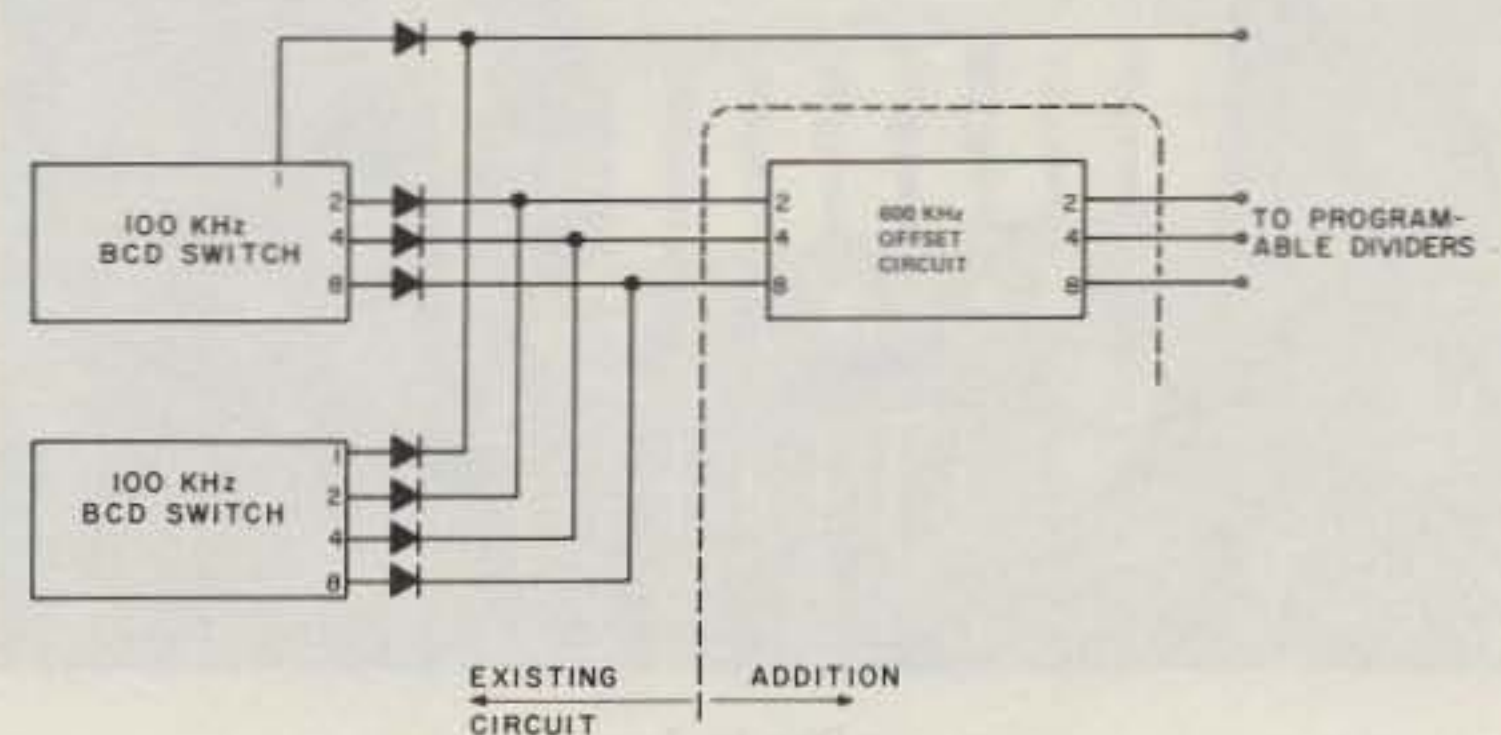

Fig. 7. Connection to synthesizer is between the BCD switches and the programmable dividers.

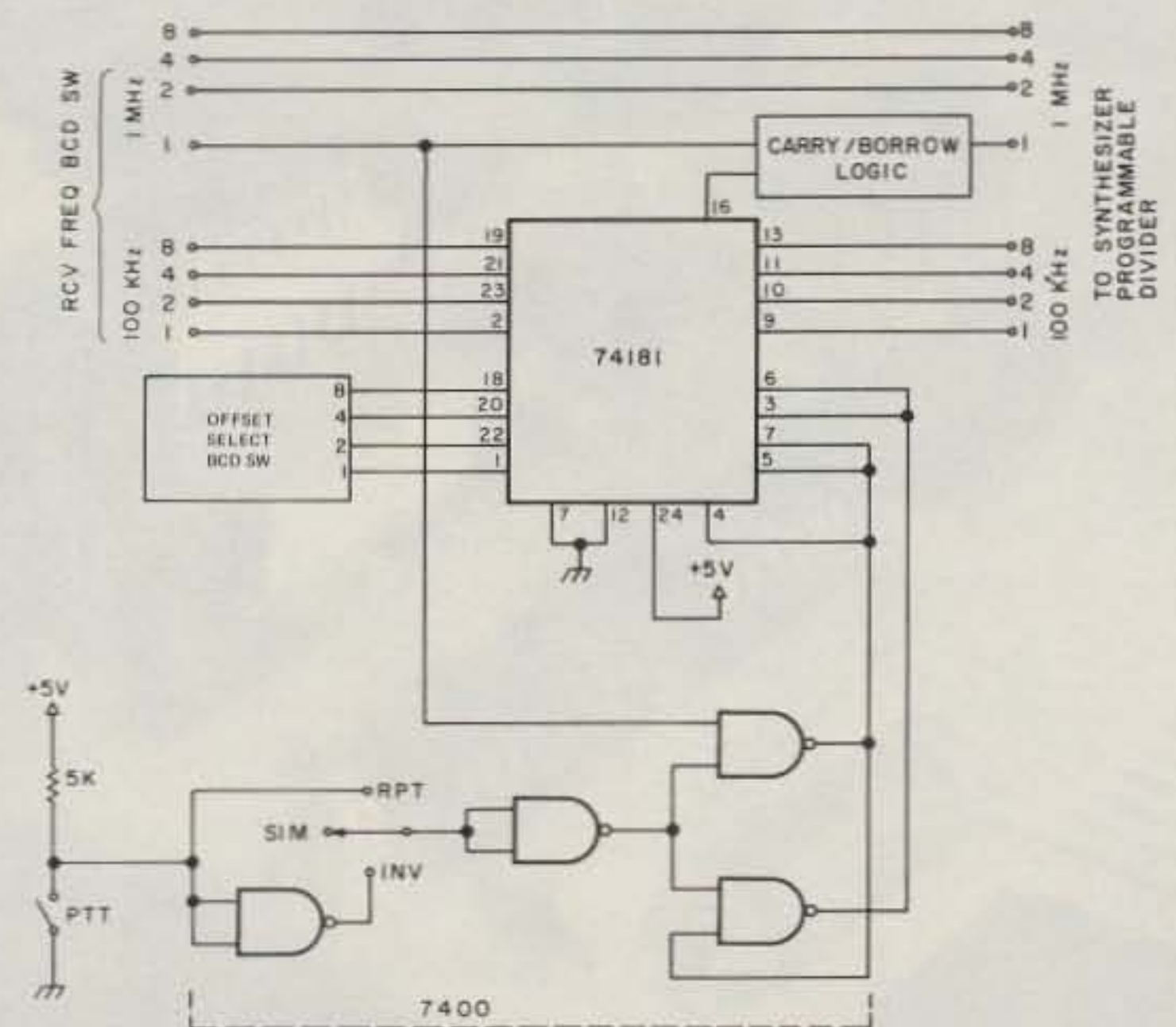

Fig. 8. Selectable offset circuit.

The Chip Switch

—a digital troubleshooting triumph

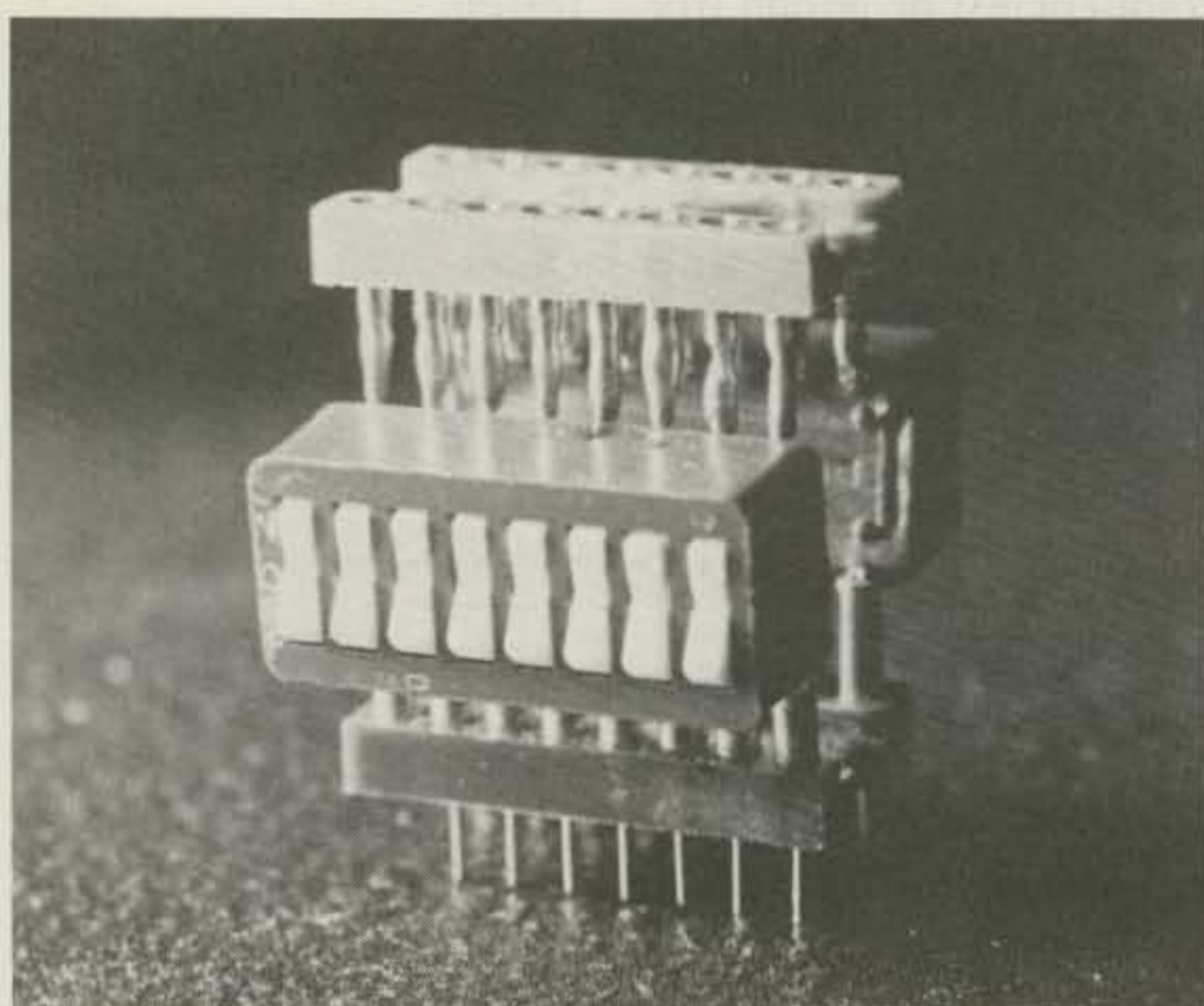

Photo 1.

Often, while troubleshooting or debugging a digital circuit, one finds it necessary to isolate one or several leads of an IC in order to examine the pins in question. Usually, the chip is removed from the socket, the desired pins are bent away from the package, and the device is replaced in the socket. This technique may work once or twice on the same chip, but, unfortunately, it may result in a broken pin. If the part is an expensive one, this can be catastrophic.

For this reason, the "chip switch" was developed. Fabricated from readily available

components, this tool will be a valuable addition to every digital workbench. It allows the experimenter to isolate any number of pins on an IC and, with the use of a DIP clip, patch any input to these isolated pins.

The chip switch is composed of a 16-pin header, two 8-position DIP switches, and a 16-pin socket. Photo 1 shows the typical construction. Each DIP switch is prepared by carefully bending the leads outward from the body of the switch, making them vertical when the switch is oriented in the position used. The lower contact row of each switch is soldered to the header. Finally, the DIP socket is positioned along the top contact row of each switch and then soldered in place.

Photo 2 shows the chip switch in actual use. It is ideal for changing parallel load bits to counters right in-circuit, or testing driver outputs with and without loads attached. When all the switch positions are on, the inserted IC will function as normal; by placing the desired position off, the associated pin is now open.

A few comments about parts selection should be made. First, the DIP switches are readily available, manufactured by AMP or Grayhill, and offered by several surplus houses. The 16-pin socket should be one with machined contact pins to assure a good solid mechanical assembly with the switches; the leaf-style socket contacts are too weak. The 16-pin header, normally used for wire-wrap panel installation of discrete components, is also comprised of the machined contacts and is available through parts distributors, manufactured by Augat or Robinson-Nugent.

After just a few minutes of assembly time, the chip switch will prove itself to be an outstanding little device that will make you wonder how you could have gotten along without it! ■

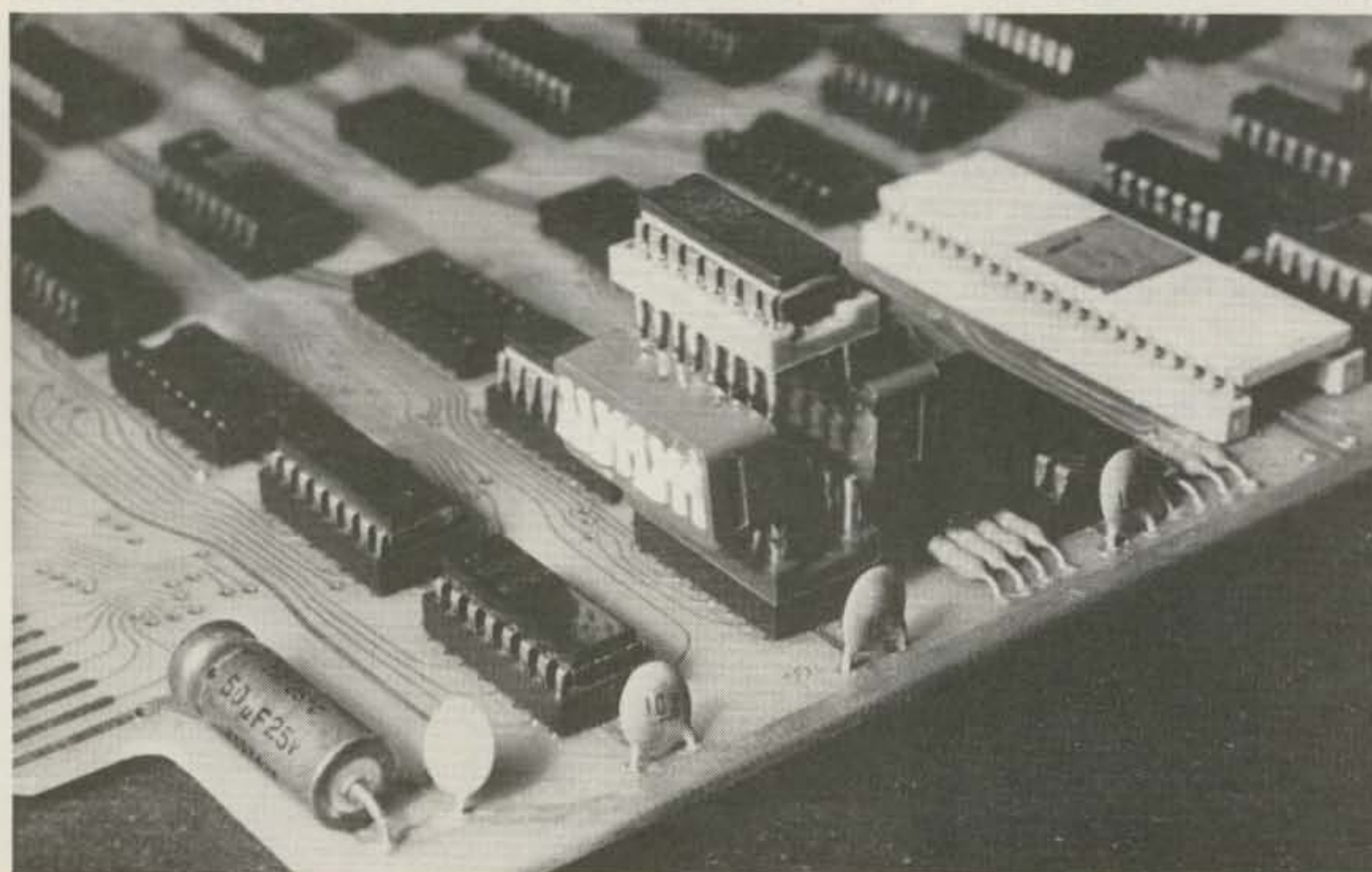

Photo 2.

EDGECOM SYSTEM 3000A

AND FMS-25...



INCOMPARABLE PERFORMANCE

AND FLEXIBILITY



SYSTEM 3000A

- Twenty Front-Panel-Programmable Memory Channels
- Any Transmitter Offset
- Built-In Memory Scanner
- Built-In Band Scanner
- Memory Channel Monitor
- Superior Receiver
- 25 Watts Output (adjustable)
- American Made/FULL 2-YEAR WARRANTY

INCREDIBLY PRICED AT \$549



FMS-25

- Ten Front-Panel-Programmable Memory Channels
- Built-In Band Scanner
- Same Fantastic Receiver/Transmitter as System 3000A
- Any Transmitter Offset
- Push-Button Tuning
- American Made/Full 2-Year Warranty



BARGAIN PRICED AT \$439



✓ A64



Aureus Electronics Inc.
 1415 North Eagle
 Naperville IL 60540
 (312) 420-8629

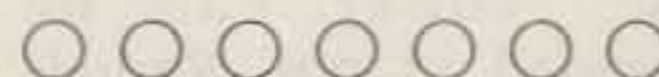

40-80-160 METERS TOWER TUNER

RESONATES YOUR TOWER

Now you can easily use your entire tower and present beam system as a complete low angle radiator on 40, 80 and 160 meters. It is common knowledge that a dipole or inverted-vee must be at least $\frac{1}{2}$ wave length high (120 feet on 80 meters!) in order for it to be a low angle radiator. But your existing tower, if fed with the Stuart Electronics TOWER TUNER, can be made to be an optimum low angle radiator on 40, 80 and 160 meters. The Stuart TOWER TUNER can be installed and easily adjusted to a low swr on any tower no matter what the size or type. Tower can be grounded or not. Radials not necessary. No more haywire appearance of dipoles and I-V's. Even your wife will love it. The

Stuart TOWER TUNER takes up virtually no extra space but greatly outperforms dipoles and I-V's at the same height plus it is easily adjustable from ground level. Start making better contacts on the 40, 80 and 160 meter bands with an antenna system that really gets out. The Stuart TOWER TUNER will handle 500 watts output.

The STUART TOWER/TUNER is a modern RF matching device designed to match virtually any antenna/tower system to 50 ohm coax and will present a 50 ohm load to the transmitter.

The Stuart Tower/Tuner is currently available in two models.

1. 40 and 80 meter model (#4080)
2. 80 and 160 meter model (#8160)

Each system comes complete with the following:

1. TOWER TURNER MATCHING DEVICE:

This device matches nominal 50 ohm coax to the lower portion of a vertical tower, pole or other object of similar shape. RF radiation is then emitted from and received by, the entire tower-beam/quad system. The device is housed in an all aluminum box which has been sealed by mechanical means as well as a chemical sealer to provide a weatherproof enclosure. The box is then painted "communications gray" with an epoxy based paint to give a truly attractive and mar-resistant finish. All tuning shafts

are rubber sealed to present an effective moisture barrier.

All outside connections are made through technically correct hardware which is sealed by the best sealant available.

2. MATCHING DEVICE HARDWARE:

An aluminum, horizontal support member which supports the Stuart Tower/Tuner Matching Device; and a heavily insulated stainless steel wire. The horizontal support member is made of aluminum to minimize corrosion as well as to enhance the already tidy looks of the Stuart Tower/Tuner. The Stuart Tower/Tuner matching device extends outward from the tower

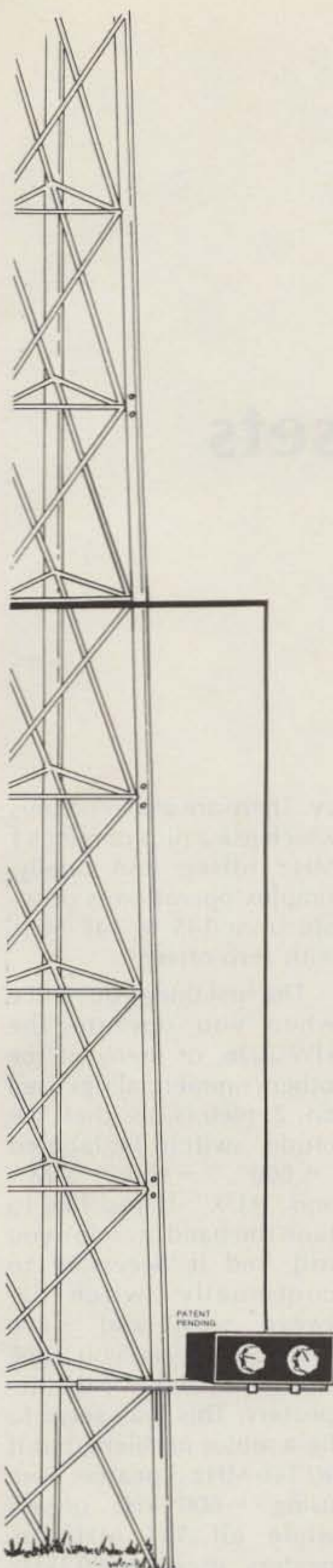

approximately 34 inches. The wire extends about 12 feet along the side of the tower. In addition, all hardware necessary to mount the Stuart Tower/Tuner on almost any standard tower is supplied. The hardware supplied is either stainless steel or cadmium plated steel

depending on the usage. The hardware provided will accommodate mounting on either vertical or horizontal members of the tower.

NOTE: RF voltages are present on the above mentioned wire anytime this system is in use. This device should be installed with this in mind. Precautions similar to those taken with all antennas should be followed (e.g., don't grab the wire while transmitting, etc.).

The Stuart Tower/Tuner has been tested on towers from 35 to 100 feet in height supporting both beams and quads. Rotor cables and existing coaxial lines have not interfered with performance, but it is suggested that these lines should be led out of the tower at ground level.

Telescoping towers, i.e., those which extend vertically by extending successive sections of tower are completely acceptable for use with the Stuart Tower/Tuner. No modifications need be made when using this type of tower.

The system will work with grounded or ungrounded antenna towers. Normally, guy wires will not interfere with performance of the Stuart Tower/Tuner. It is suggested, however, that as with any antenna system, the guys be broken up with insulators to prevent any resonance condition.

In our testing, The Stuart Tower/Tuner has not ever required the use of a radial system at the base of the tower to give both a good SWR and excellent signal reports. However, as with any vertical antenna system, some improvement can be expected when using a counterpoise arrangement.

Tuning of the system is a simple, direct procedure. After the apparatus is in-

stalled per the enclosed directions:

1. Install forward and reverse reading wattmeter or SWR meter of any kind between transmitter and Stuart Tower/Tuner.
2. Load transmitter at desired frequency to about 10 watts output (or enough to get reading on wattmeter).
3. Adjust tuner per directions (similar to any antenna tuner) for zero or lowest reflected reading or SWR.

Unit is now tuned to the desired frequency and the adjustments are completely repeatable.

In most cases, one setting of the tuning knobs will cover either 80 CW, 75 phone or the entire 40 meter band or the entire 160 meter band depending on which model you have with an SWR of less than 2:1.

WARRANTY

The Stuart Electronics Tower/Tuner is guaranteed for a period of one year from date of purchase. If anything goes wrong with the unit within that time, simply return the matching device to us prepaid with proof of purchase. We will take whatever steps are necessary to restore your Tower/Tuner to new specs and return it to you prepaid.

This warranty does not cover damage purposely inflicted or which results in damage or distortion of

the outer cover or controls or due to using power in excess of the rated amount.

30 DAY RETURN PRIVILEGE

If the Stuart Electronic Tower/Tuner does not live up to our claim or your expectations, simply return the unit to us:

1. Within 30 days
2. Prepaid to us — preferably by United Parcel Service.
3. Not damaged, not disassembled, etc.

PLEASE NOTE:

Disassembly of the Stuart Tower/Tuner not only ruins the weatherguard seal we worked so hard to give you . . . it also VOIDS this warranty and your 30 day return privilege. **RETURN THE UNIT INTACT.**

The Stuart Tower Tuner price has been reduced to \$99.95 for a limited time only. Save \$30 off the regular price of \$129.95. Offer expires Dec. 31, 1978. Don't miss out on this fantastic offer. Order yours today.

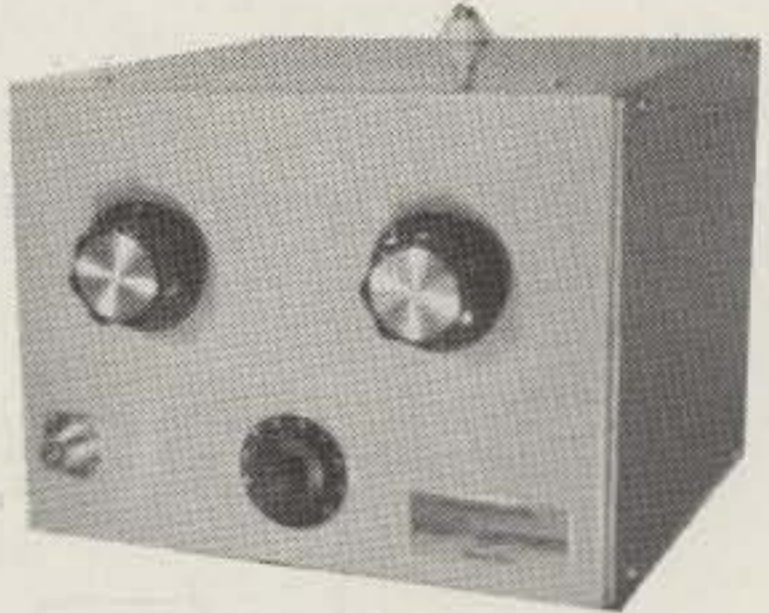

Fig. 1 Stuart Electronics 500W Tower Tuner

Name _____ Call _____
 Street _____
 City _____ State _____ Zip _____

I would like to pay for this purchase by:

- Total Amount Enclosed
- No money enclosed, C.O.D.
- M.C. VISA # _____ Exp. _____

Automatic Repeater Offsets

— it's all so logical

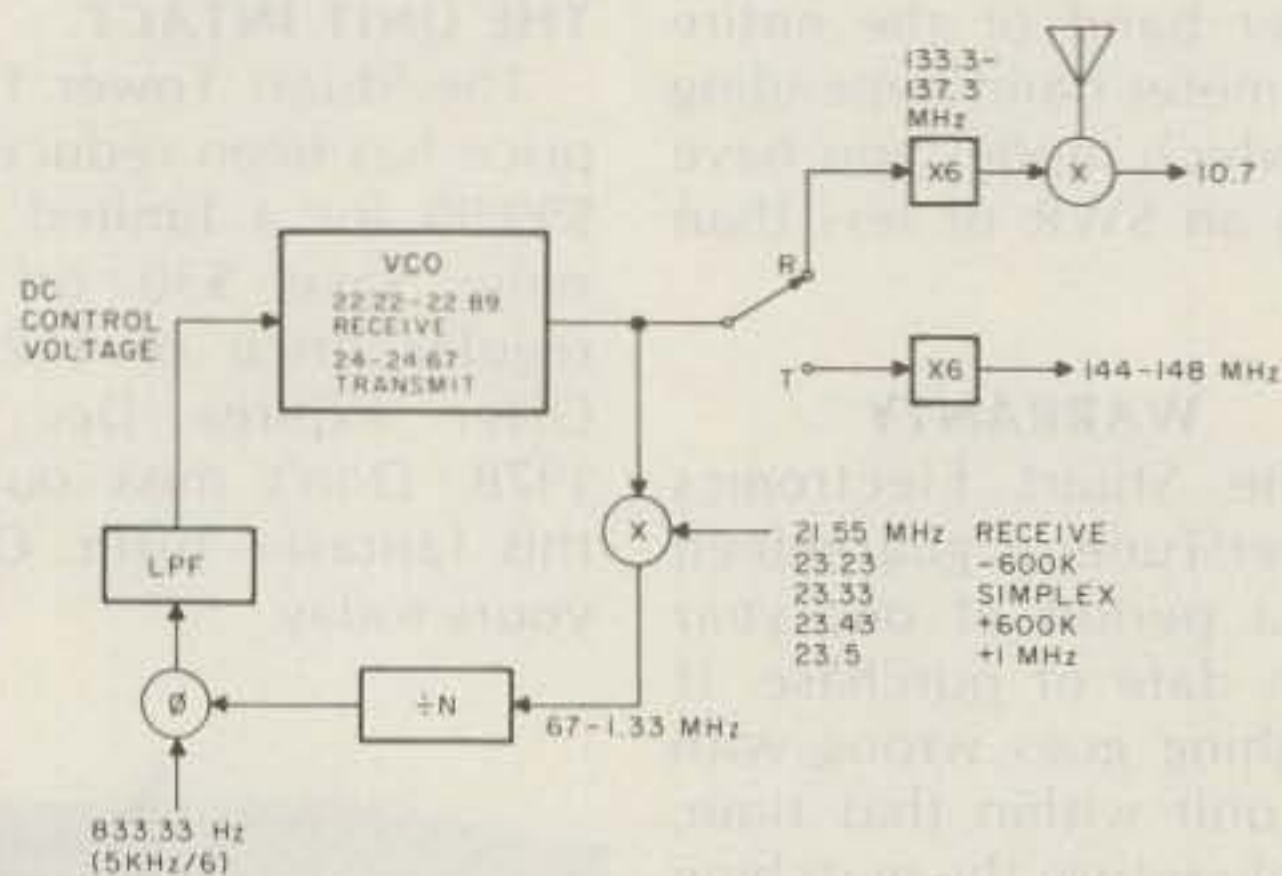

Fig. 1. Synthesizer block diagram (HW-2036).

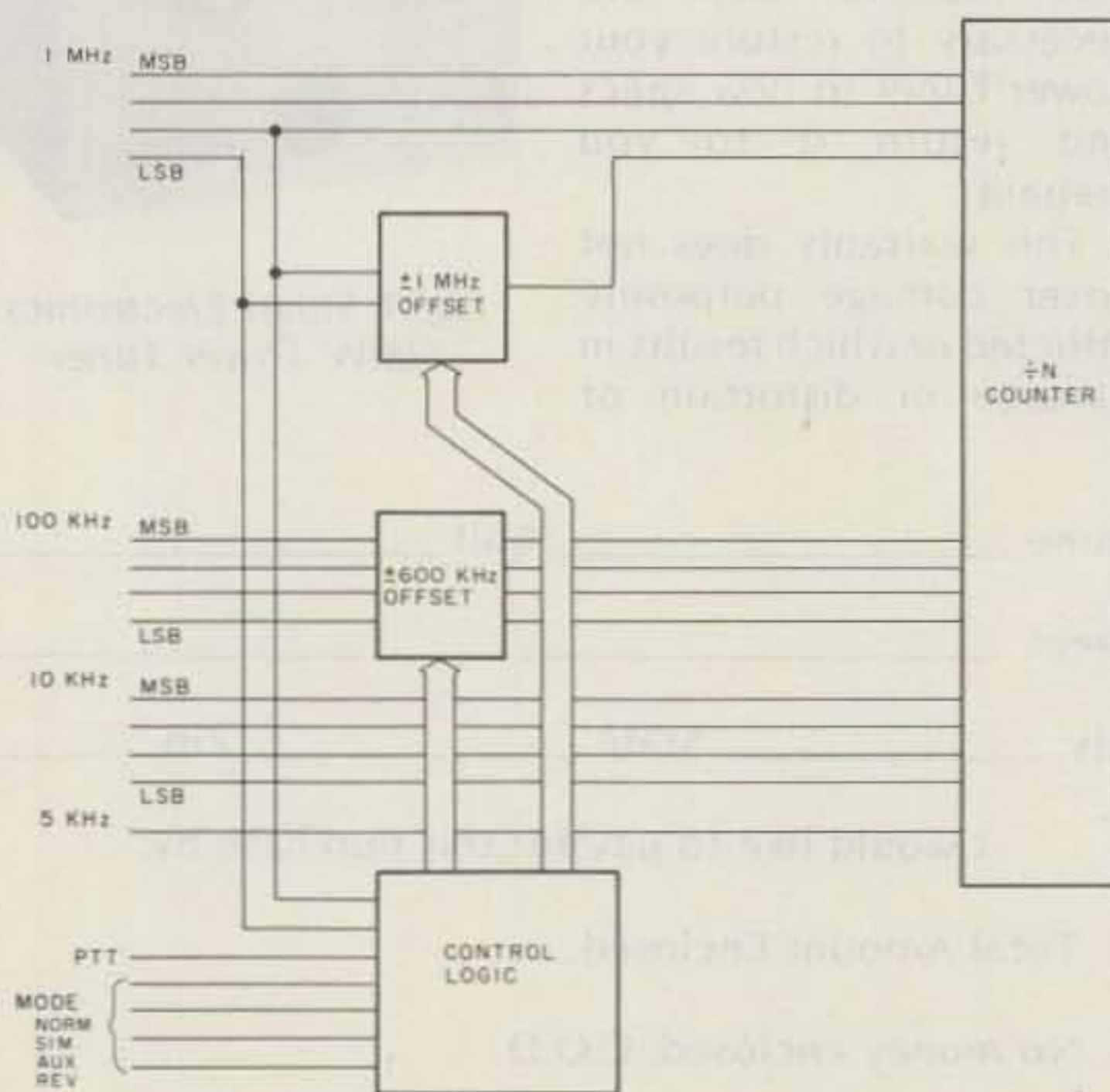

Fig. 2. Block diagram of offset circuit for 2 meters.

Bruce McNair N2YK/WB2NYK
12 Marion Avenue
Howell NJ 07731

If you either own or are contemplating adding a synthesizer to your 2 meter or 220 MHz rig, you must consider the method used to generate the frequency offset required for repeater operation. Many commercially-available transceivers and synthesizers generate this offset in a manner that does not allow for easy operating. The 2 meter offset circuit described below was originally designed to cure these problems in my HW-2036, although it could be used with most other synthesizers. After designing this circuit and talking with friends who are 220 MHz enthusiasts, the corresponding 220 MHz offset generator was an obvious alternative.

First, consider the offsets required for 2 meter operation. Depending on whether the repeater frequency is above or below 147 MHz, most repeaters require a transmitter offset of plus or minus 600 kHz from the receive frequen-

cy. There are also repeaters which use a plus or minus 1 MHz offset, and finally, simplex operation is possible from 145 to 148 MHz with zero offset.

The first thing you notice when you operate the HW-2036, or many of the other commercial rigs used on 2 meters, is that the mode switch is labeled "+600", "-600", "SIM", and "AUX". If you like to tune the band (as I do), you will find it necessary to continually switch between +600 and -600 kHz offsets as you tune from 146 to 147 MHz repeaters. This may seem to be a minor problem, but if all 146 MHz repeaters were using -600 kHz offsets while all 147 MHz repeaters used +600 kHz offsets, the offset could be switched with the changing of the "MHz" switch. This is the "Normal" operation in rigs such as the TS700.

While you're improving on the operation of your synthesizer, it would be convenient to be able to operate "Reverse." That is, if I were tuning 146.91 MHz receive and 146.31 trans-

mit, reverse operation would cause the rig to receive on 146.31 MHz and transmit on 146.91. There are a few instances when this capability would be helpful: (1) when the repeater is down—to talk to someone who is only crystallized up for the repeater frequency; (2) to check to see whether it is possible to switch from the repeater to a simplex frequency. As the HW-2036 (and many other rigs) was designed, to operate reverse it is necessary to offset the lever switches by 600 kHz and change from a + to a - (or vice versa) 600 kHz mode. Did you ever try to count 6 clicks on a lever switch while driving down a bumpy road, without missing too much of a transmission (or having an accident)? The design below allows you to make this change automatically by changing the mode switch one position—virtually instantaneously.

The third area for improvement is in generating ± 1 MHz offsets. Many rigs offer two switch positions which select one of the two offsets. Of course, any repeater transmitting above 147 MHz will be listening below 147 MHz, and vice versa. It would be nice to generate this offset automatically and to allow reverse operation.

The final area for improvement is concerned with operation below 146 MHz. Of course, there is no repeater operation allowed from 145 to 146 MHz, but FM emission is allowed when operating simplex in this uncrowded portion of the 2 meter band. Any repeater offset circuit design would not be complete unless 145 MHz transmissions were automatically made simplex.

These then are the inconveniences associated with many 2 meter synthe-

sized rigs in current use. Fig. 1 shows how transmit offset is generated in the HW-2036 so we can see how to change it.

Operation of Current System

For each offset used in the HW-2036, a different crystal tuned to f_{offset} is used to mix down the voltage-controlled oscillator (vco) to a range that the programmable counter can divide. If I were designing this synthesizer from the start, this would mean 5 crystals and 5 sets of discrete components to select the crystal. At an approximate cost of \$10 per offset, this would work out to about \$50. As it turns out, 2 will be required in either case, and 1 is supplied by the user, but still 2 extra crystals and associated components are included in the design (i.e., \$20).

Now consider GLB's alternative. You have two sets of thumbwheel switches. Either can set the transmit and/or receive frequency. Reverse operation is very easy; just interchange the purpose of each switch. Any repeater offset is possible (but are there enough repeaters in operation with odd offsets to use this justification?). The disadvantage of this approach is that to go from one repeater to another, both sets of thumbwheel switches must be changed. Incidentally, GLB uses the two crystal oscillators to provide transmit and receive mixing in the loop as Heathkit does, to lower the frequency the divide-by-N counter must divide. Still, the extra thumbwheel switches cost something—probably \$8 for reasonable quality switches.

The Alternative Method

The approach that I decided upon was less expensive than either of the

above. This should be especially desirable if you

are building your own synthesizer. The required fre-

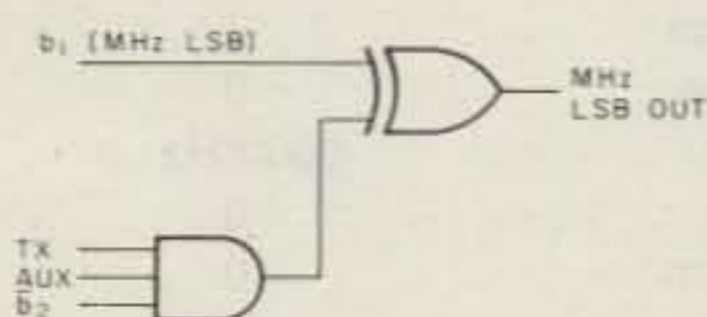

Fig. 3. ± 1 MHz offset circuit.

$$\begin{array}{r} 0110 \quad (6) \\ + 1010 \quad (-6) \\ \hline (1)0000 = 0 \end{array}$$

↑ carry into 5th bit (ignored)

Fig. 4. Adding 6 and -6.

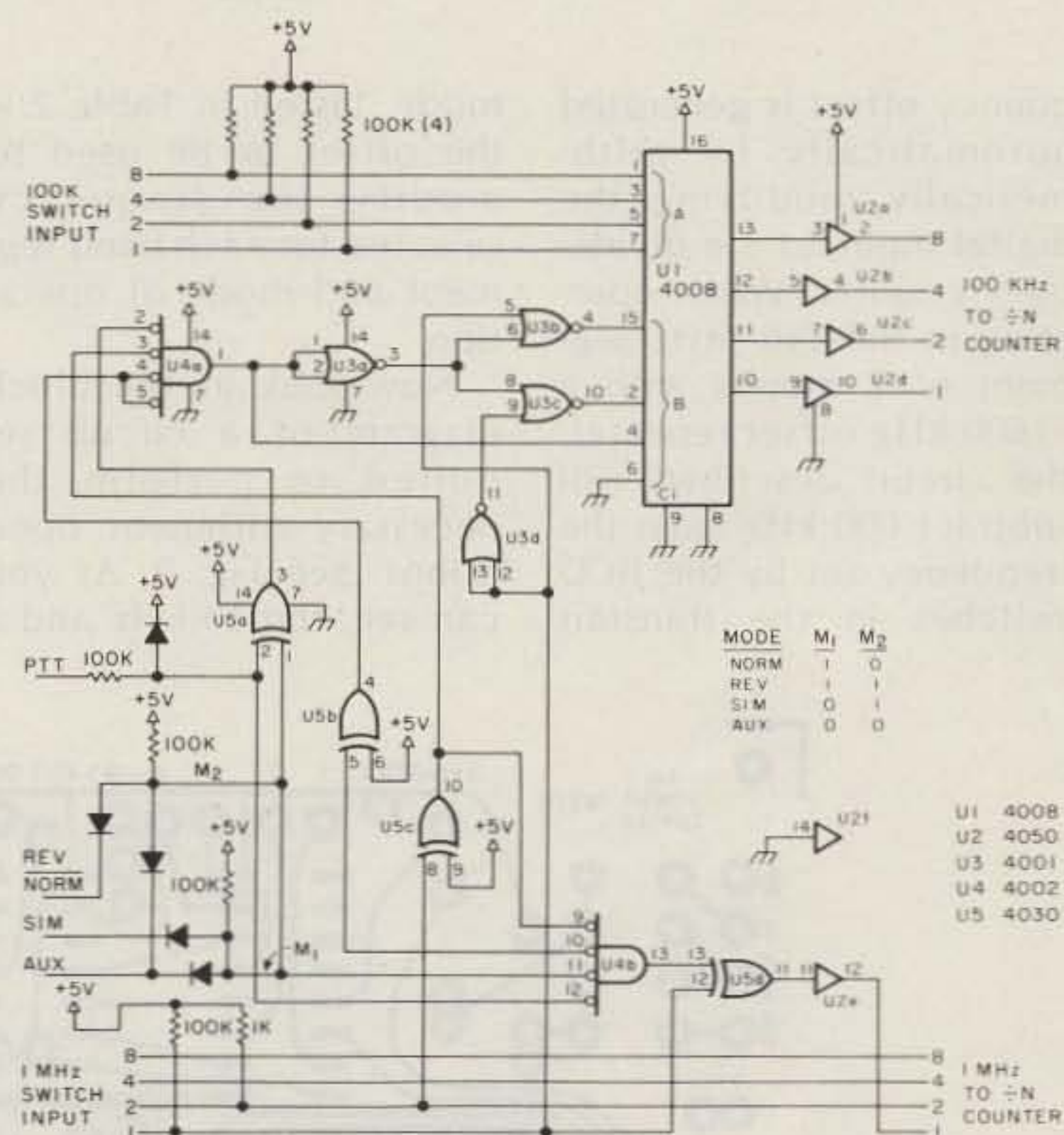

Fig. 5. 2 meter offset circuit.

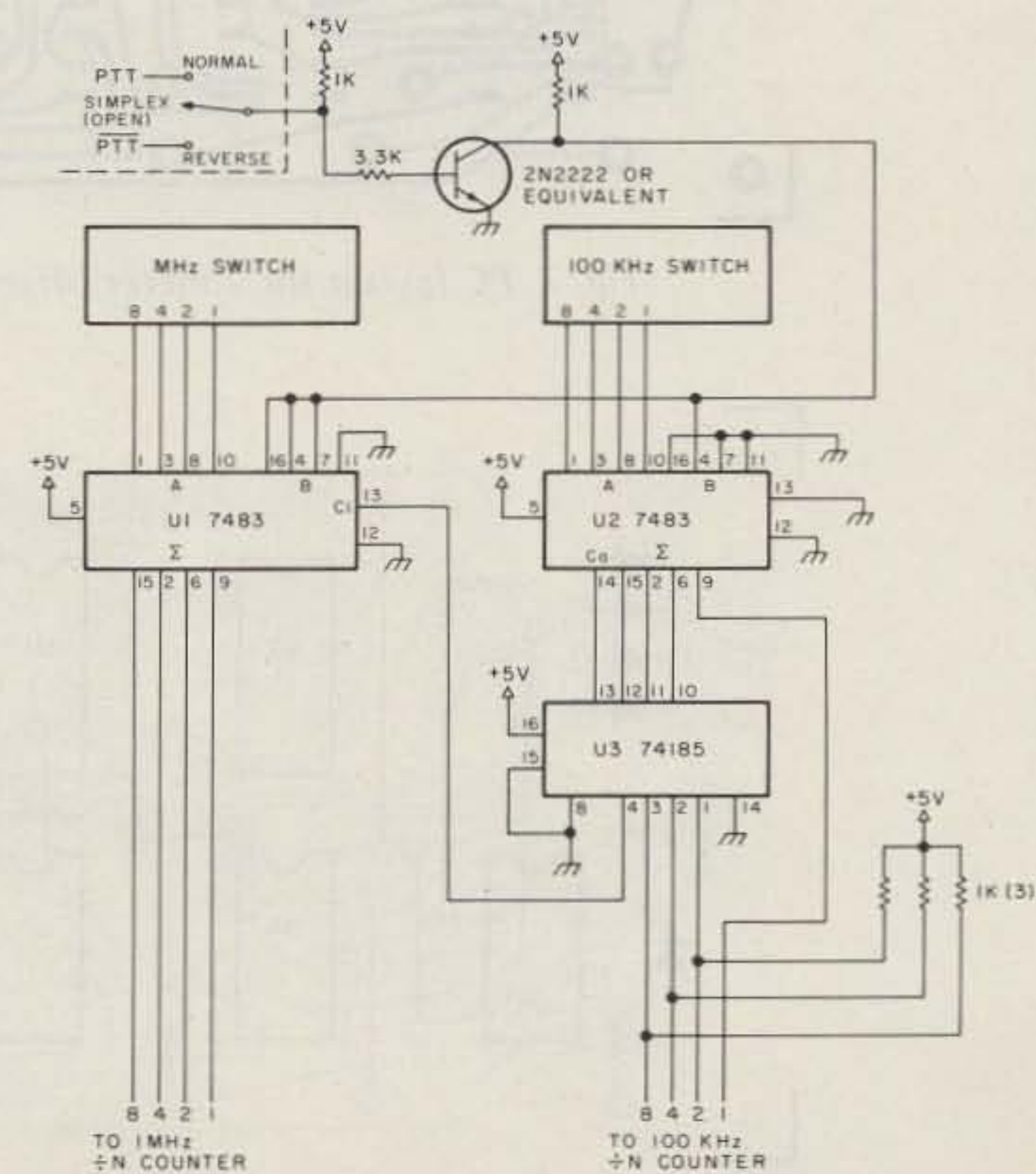

Fig. 6. 220 MHz offset circuit.

| Frequency | Mode | Offset | |
|-------------|------|----------|------------------|
| | | Receive | Transmit |
| 145-145.995 | any | 0 | 0 (simplex only) |
| 146-146.995 | Norm | 0 | -600 kHz |
| | Simp | 0 | 0 |
| | Rev | -600 kHz | 0 |
| 147-147.995 | Aux | 0 | +1 MHz |
| | Norm | 0 | +600 kHz |
| | Sim | 0 | 0 |
| | Rev | +600 kHz | 0 |
| | Aux | 0 | -1 MHz |

Table 1.

quency offset is generated automatically by arithmetically modifying the digital input to the divide-by-N counter. When operating in the 146 MHz segment of 2 meters with a -600 kHz offset repeater, the circuit described will subtract 600 kHz from the frequency set by the BCD switches in the transmit

mode. Listed in Table 2 is the offset to be used to modify the frequency selected for each band segment and mode of operation.

Now look at the block diagram of a circuit required to perform the necessary arithmetic operations. See Fig. 2. As you can see, the 10 kHz and 5

kHz lines are never changed (i.e., 146.165, 146.865) and the 100 kHz and 1 MHz lines are changed independently of each other. If you consider the states of the 1 MHz lines for 145, 146, and 147 MHz, you will see in Table 2 that b_2 , the second least significant bit, tells you whether or not operation is

below 146 MHz.

When $b_2 = 0$, the set frequency is from 145-145.995 MHz and there should be no offset. If $b_2 = 1$, then b_1 tells you whether 146 or 147 is selected. In fact, this is the way to generate 1 MHz offset as drawn in Fig. 3. The operation is as follows. If AUX is selected and the rig is transmitting and operation is above 146 MHz, then the least significant bit (LSB) of the MHz digit is "exclusive ORed" with 1—this has the effect of changing a 1 to a 0 and vice versa. In other words, 146 becomes 147 and 147 becomes 146, causing the 1 MHz offset on transmit. If AUX is not selected or if the rig is receiving or if operation is below 146 MHz, then the MHz digit is not changed. Notice that in either case, the other digits are unchanged.

Next consider the ± 600 kHz offset. Note that in Table 1, for various conditions, values of ± 6 have to be added to the 100 kHz input. Adding +6 is easy using a 4-bit adder chip. The input from the BCD switches is applied to one input while the binary equivalent of 6, that is 0110, is applied to the other input. Subtraction of 6 is just as easy, but it is necessary to calculate the equivalent of -6 and add. This is the binary code 1010. To verify this fact, add 6 (0110) to -6 (1010). The result is, in fact, zero, as shown in Fig. 4.

The Hardware

All that remains is to design the steering logic to apply the correct code to the adder to generate the proper offset.

I won't go into all the details of how this circuit is designed, but the 2 meter synthesizer offset generator is shown in Fig. 5.

Now it is time to interconnect everything and talk about the hardware used. For this project, I

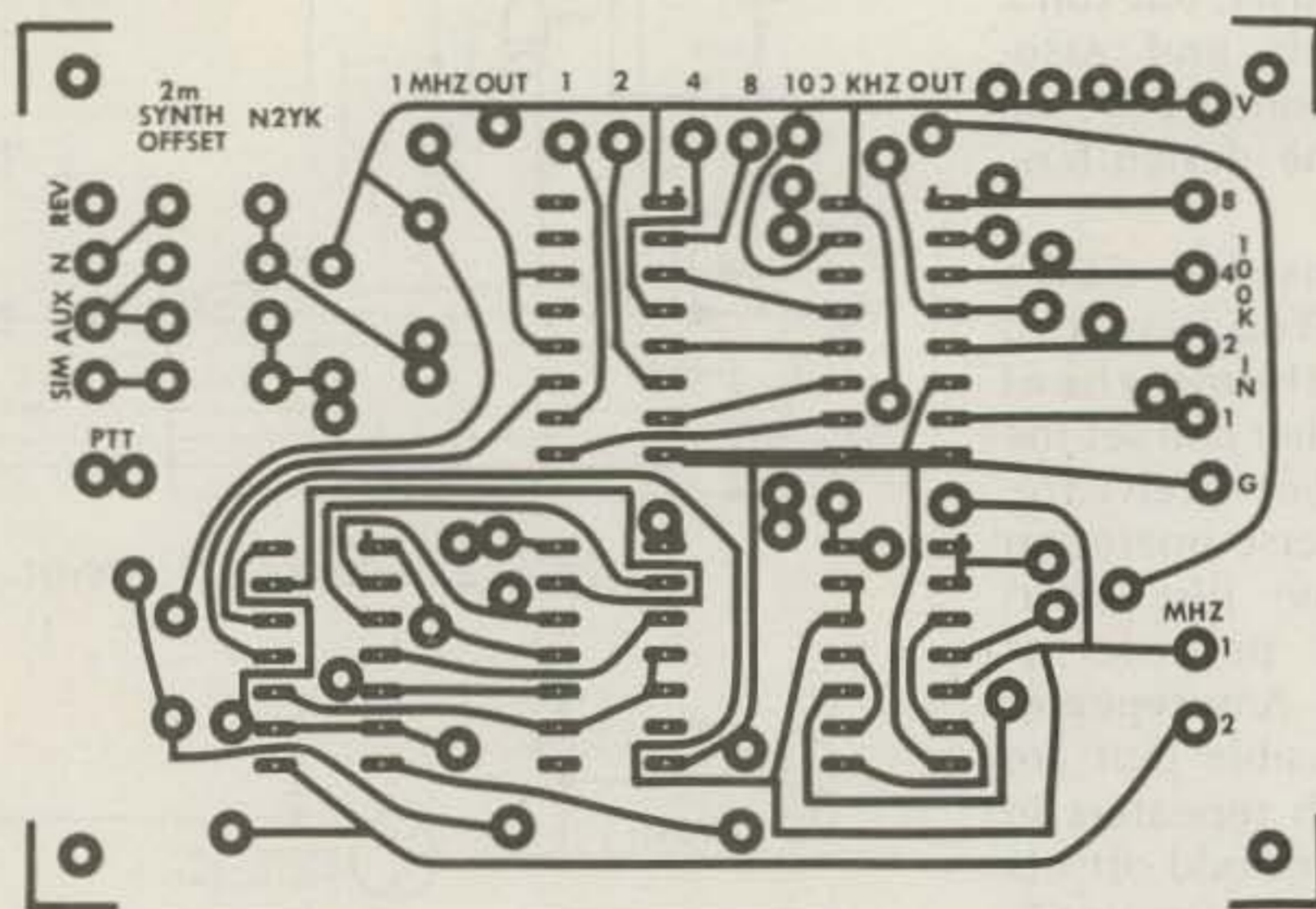

Fig. 7. PC layout for 2 meter offset circuit.

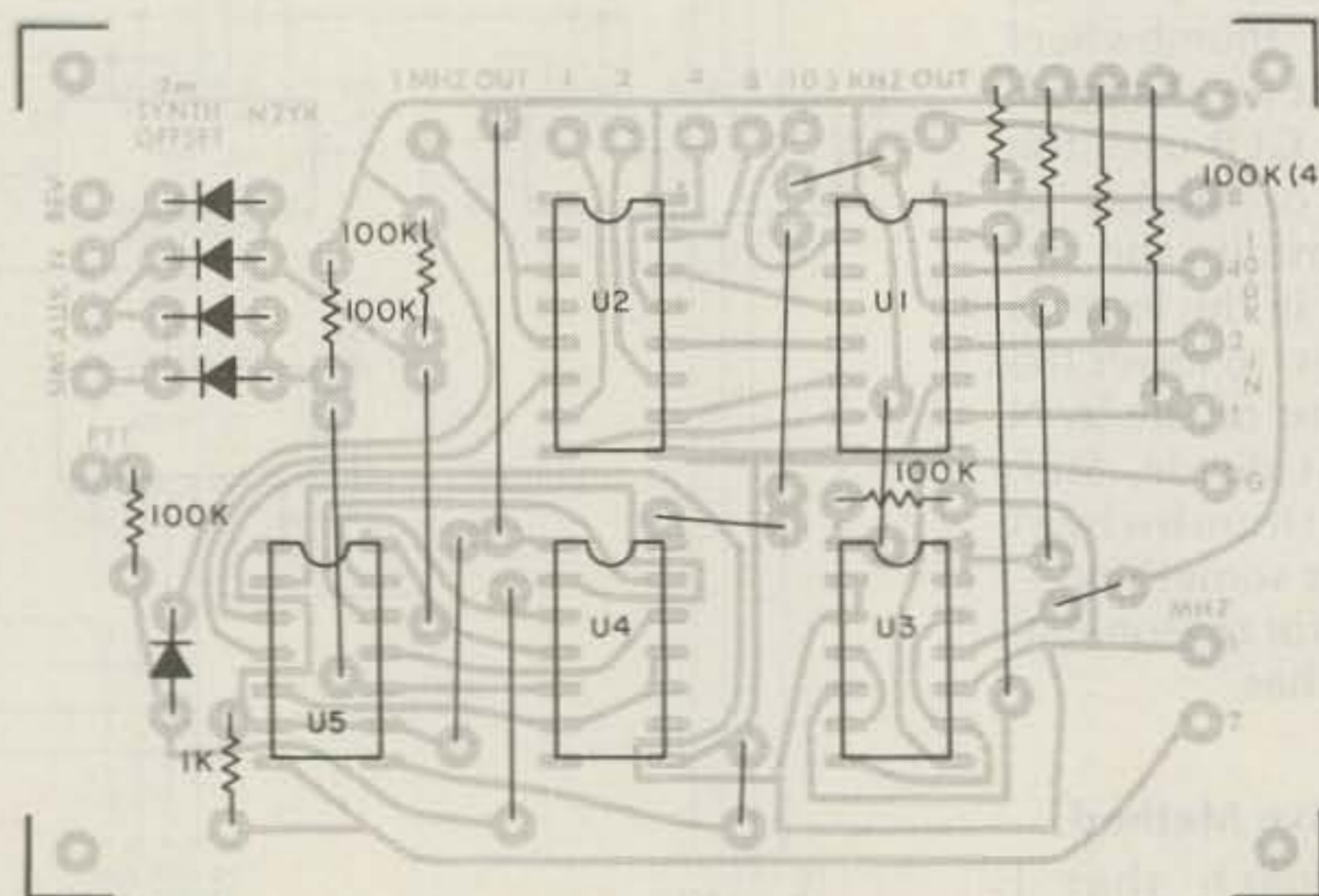

Fig. 8. Parts placement for 2 meter offset circuit.

used CMOS throughout for a number of reasons which are listed below.

- Power consumption is nearly zero. In fact, more power is used in the pull-up resistors than in the ICs.
- A 4-input NOR gate is required. CMOS 4002s are easy to get; the TTL equivalent is not.
- TTL would probably require separate power supply regulation unless you could steal a few hundred mA.
- The current prices of CMOS vs. TTL are almost comparable.

The one disadvantage of CMOS is that the 4008 adder used cannot drive TTL divide-by-N counters in the rig's synthesizer. One package is required for the 4050 that must be used. This could be eliminated, of course, if your synthesizer uses CMOS dividers.

Some explanation is in order for the mode switch. When I installed this circuit in an HW-2036, there was an existing switch labeled "-600, SIM, +600, AUX" which, on transmit, enabled the proper crystal in the offset crystal oscillator. In my HW-2036, the transmitter is now operated with the simplex always used. The mode switch is now labeled "AUX, SIM, NORM, REV" and switches a ground connection to the proper input of the offset generator board. If you follow the connections through the 4 diodes in the mode switch circuitry, you will see that the signals m1 and m2 take on the values shown in the table in Fig. 5.

220 MHz Circuit

After I got the circuit above installed in my 2 meter rig, it became apparent that the same idea could be used on other bands. Fortunately, the repeater offset situation is

a little more reasonable on 220. A transmitter offset of -1.6 MHz appears to be the standard. Still, it would be nice to operate "normal," "simplex," and "reverse" as above. All that is necessary is to subtract 1.6 MHz from the BCD switch settings as required. The most convenient method for accomplishing this function is (1) subtract 2 from the MHz switch, (2) add 4 to the 100 kHz switch, and (3) keep track of whether it is necessary to "carry" information from one digit to the next. TTL adders (7483s) are used to perform the additions while a 74185 binary-to-BCD converter is used to keep track of carry information. It is necessary to build this circuit with TTL devices because of the 74185—there is no readily-available CMOS equivalent. The schematic of this circuit is shown in Fig. 6.

Construction

Since only dc signals are present within both of these offset generators, layout is generally not critical. Both have been built on a piece of perforated board and have been working fine for a few months. If you would rather construct the circuits on a PC board, board layouts are shown in Figs. 7 and 9, while parts placements are shown in Figs. 8 and 10. Both circuit boards as well as parts kits are available from the author. Send an SASE for details.

Installation

Both offset circuits are easily installed in the rig. You must first cut the lines from the BCD switches to the divide-by-N counters, but only in the digits that get changed. For the 2 meter version, all the 100 kHz lines are cut, but only the least significant bit (LSB) for the MHz digit. For the 220 MHz version, all lines are cut for the MHz

| Band segment | MHz code (b ₈ ,b ₄ ,b ₂ ,b ₁) |
|--------------|--|
| 145 | 0 1 0 1 |
| 146 | 0 1 1 0 |
| 147 | 0 1 1 1 |

Table 2.

and 100 kHz digits. Next, the proper switch lines are connected to the inputs of the offset generator. The outputs of the offset generator are now used as the inputs to the divide-by-N counters. Mode switch information is applied to the proper inputs from a new mode switch or from a modified existing switch. Finally, the push-to-talk line (which goes to ground on transmit) is connected to the proper input. If

everything goes as planned, at this point you should be ready to get on the air.

Conclusion

If you decide to build this circuit, I hope you find automatic repeater offset as handy as I have. If there are any questions concerning operation, installation, or modification for different rigs (or bands), I will be happy to answer any letter including an SASE. ■

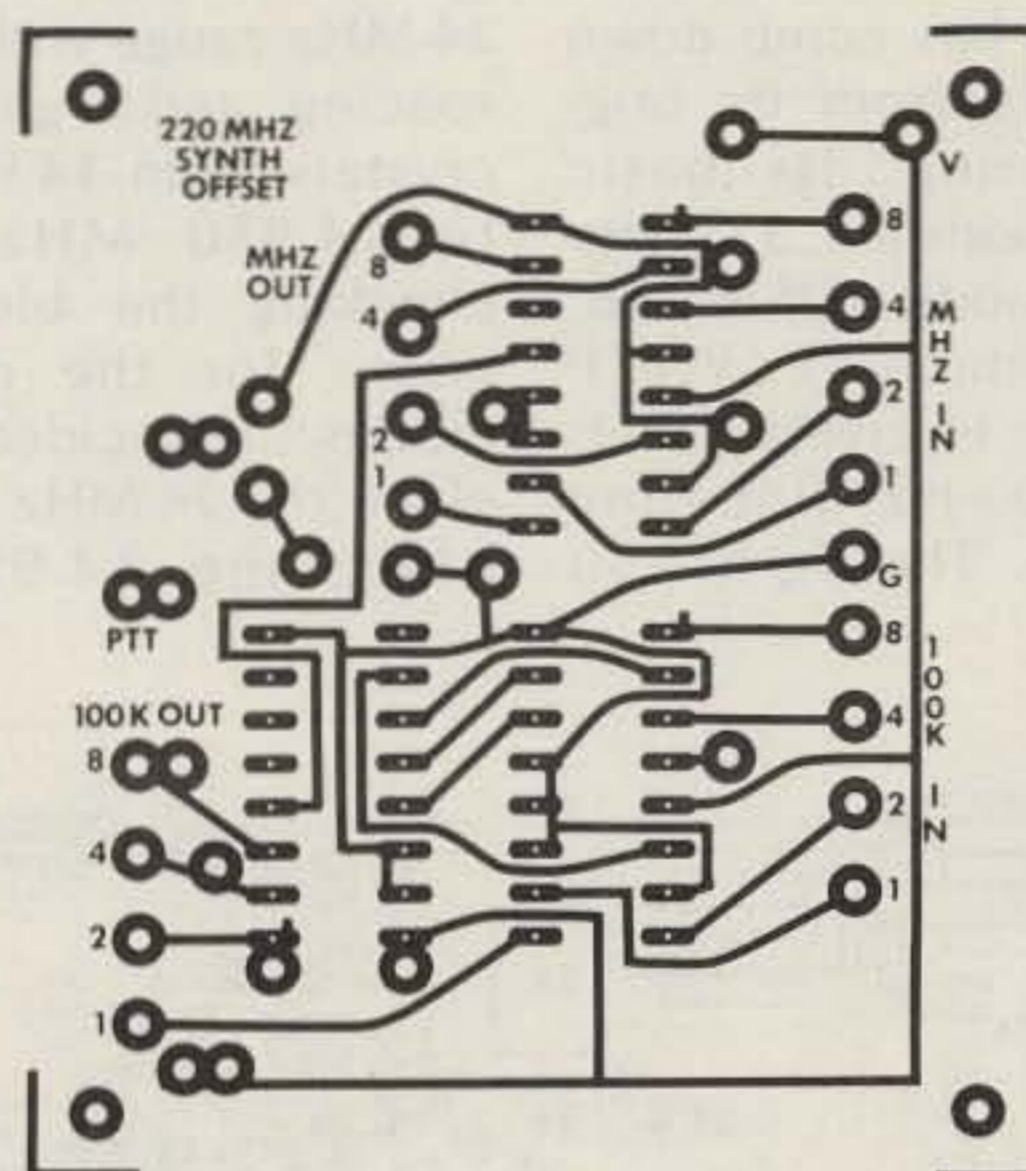

Fig. 9. PC layout for 220 MHz synthesizer offset adapter.

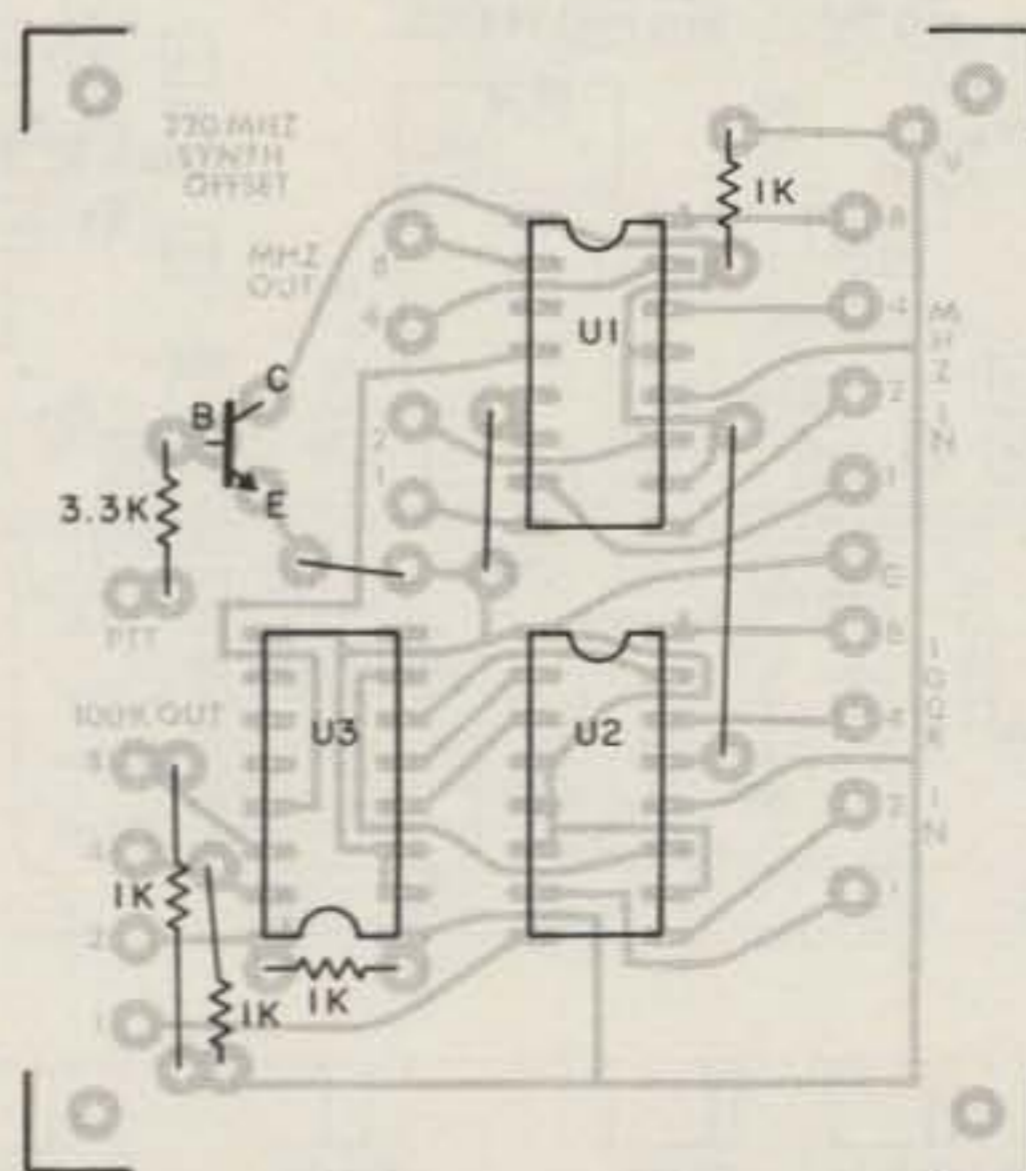

Fig. 10. Parts placement for 220 MHz synthesizer offset adapter.

CB to 10

—part XIII: the Lafayette Telsat SSB-75

This rig makes a very versatile all-mode mobile transceiver when converted to 10 meters. The price has come down remarkably from its original offering. Its basic specifications are: 23 channels, all modes (USB, LSB, AM), minimum 12 W PEP output, an i-f crystal filter, and ± 600 -Hz fine-tune capability. The rig has 10

crystals, which are divided into two groups for frequency synthesis: a group of six crystals in the 24-MHz range with 50-kHz spacing, and a group of 4 crystals from 14.910 MHz to 14.950 MHz. After checking the block diagrams for the different modes, I decided to replace the 24-MHz crystals. Also, the 14.950-MHz

crystal should be replaced by a 14.940-MHz crystal in order to get even 10-kHz spacing from channel to channel (originally 10-10-20-10 kHz). Every crystal of the first group yields four channels on 10 meters.

The formula $f_x = f_{op} + 11.275 \text{ MHz} - 14.910 \text{ MHz}$, where f_{op} = required operating frequency in MHz, gives the frequency for the crystals in the 24-MHz range. Remember: Each of these crystals gives four operating frequencies.

Example: The frequency 28.500 MHz shall be on channel one. Which crystal is necessary? $f_x = 28.500 \text{ MHz} + 11.275 \text{ MHz} - 14.910 \text{ MHz} = 24.865 \text{ MHz}$. This crystal replaces X205 as shown in the parts location diagram, Fig. 1. This crystal is in action from channel 1 to 4 on the selector switch. X206 responds to channels 5-8; X207 to channels 9-12; X208 to 13-16; X209 to 17-20; and X210 supplies 21, 22, no operation, and 23.

If you want all 23 channels in an uninterrupted order, all you do is add 40 kHz to the previous crystal's frequency.

Example: For 28.500 to 28.730-MHz coverage, you'll need:

- X205: 24.865 MHz
- X206: 24.905 MHz
- X207: 24.945 MHz
- X208: 24.985 MHz
- X209: 25.025 MHz
- X210: 25.065 MHz

No operation is possible on 28.720 MHz (between channel 22 and 23) because of the switching arrangement.

If you want to listen occasionally to OSCAR 7, just use a 25.835-MHz crystal for X210. Thus, channel 23 receives the 29.502-MHz beacon, and channels 21 and 22 receive 29.480 MHz and 29.470 MHz, respectively, in the CW subband.

If you prefer the 73 Magazine band plan (channel 1 at 28.965 MHz), you need to replace only the following crystals:

- X205: 25.330 MHz
- X206: 25.380 MHz
- X207: 25.430 MHz
- X208: 25.480 MHz
- X209: 25.530 MHz
- X210: 25.580 MHz

Crystal X204 remains unchanged, so delete step 1 in the following instructions. This set of crystals gives you the first 23 channels of the 73 band plan.

Some portions of the transceiver must be realigned, but the only components that must be changed are the crystals. A satisfactory alignment can

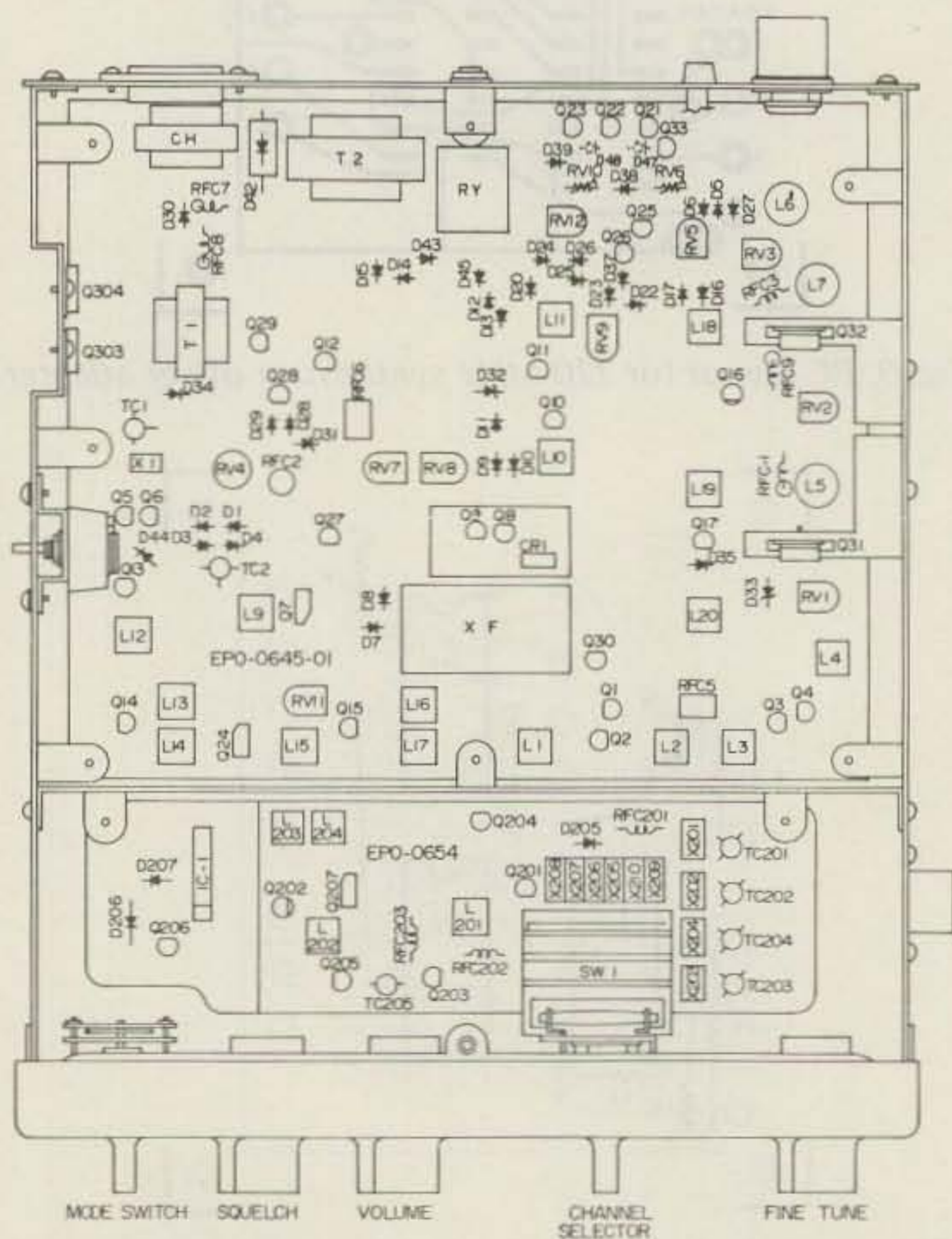

Fig. 1. Telsat SSB-75 parts location diagram.

be achieved using only a wattmeter and a 10 meter transceiver. You should have no problems if you follow these instructions.

1. Replace X204 with 14.940-MHz crystal.
2. Replace X205 through X210 as required.
3. Set mode switch to USB.
4. Plug in the microphone and turn the rig on. Turn the squelch fully counterclockwise.
5. Connect a 10 meter antenna through the wattmeter.
6. Provide a strong signal on one of the planned operating frequencies.
7. If you hear the signal already, rotate L201 clockwise until the signal disappears, and then counterclockwise until the signal returns. Continue one-half turn counterclockwise past the point of return of the signal. Go to step 9 if you were able to complete this step. If not, continue with step 8.

8. If you don't hear the signal, rotate L201 counterclockwise until you hear it, or check the frequency and strength of your reference signal. Go back to step 7.
9. Reduce the 10 meter reference signal amplitude until you barely hear it.
10. Adjust L202, L203, and L204 for best reception. Reduce reference signal level as required.
11. Adjust L18 and L19 for best reception.
12. Repeat steps 10 and 11.
13. Set mode switch to AM.
14. Press microphone push-to-talk button and adjust L2, L3, L4, L5, L7, and L6 for maximum indication on the wattmeter.
15. Repeat step 14 until power output is between 4 and 8 Watts.
16. Set mode switch to LSB.
17. Increase reference signal level until a weak signal is received. A slight frequency correction might be necessary.

18. Adjust L12 through L17 for best reference signal reception.
19. Remove reference signal and repeat steps 11 and 18 for maximum noise.

That's it! If you find it complicated—try it. It's really no problem.

The retuning was successful if there is practically no difference in noise received when you switch back and forth between USB and LSB and power output is nearly constant whether on upper or lower sideband. Better results might be obtained, however, if you have access to sophisticated test equipment.

The time required for the conversion/alignment is less than one hour.

Originally, the fine tuning control varied only the receive frequency. Soldering wire a to wire b (Fig. 2) provides fine tuning for transmit, as well.

I found this conversion very handy for strictly mobile use. For portable or fixed use, however, replacement of X201 through X204 with a 14.910-to-15.010 MHz vfo is feasible and certainly worthwhile. This will provide a 100-kHz-wide segment for each of crystals X205 through X210.

You will be surprised how often you get a DX contact with only 10 W PEP. Talking with W6s and W7s while driving around in upstate New York is "normal," and a contact with South America, the Caribbean, or even South Africa is not a rarity. Good DX! ■

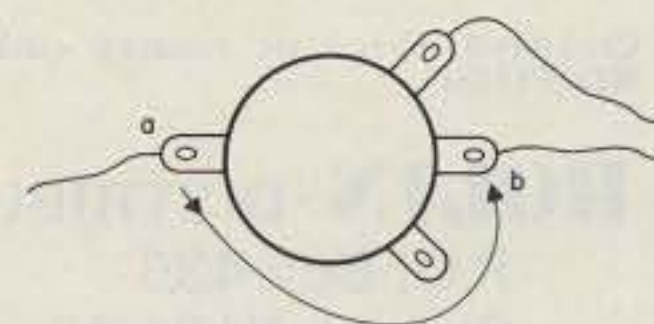

Fig. 2. Fine-tuning potentiometer.

Germantown Amateur Supply, Inc.
MEMPHIS, TENNESSEE

✓ G12

NO MONKEY BUSINESS!

- (A) Complete Service Facilities
- (B) Good Deals on most Brands
- (C) Shipping within 24 Hours
- (D) All inquiries handled by Active Hams with over 20 years experience in ham radio

CALL TOLL FREE
1-800-238-6168

IN TENNESSEE, CALL 901-452-4276
MONDAY - SATURDAY 8:30-5:30
FOR YOUR SPECIAL.

Write: 3202 Summer Ave., Memphis, Tennessee 38112

CUSTOM TRANSFORMERS

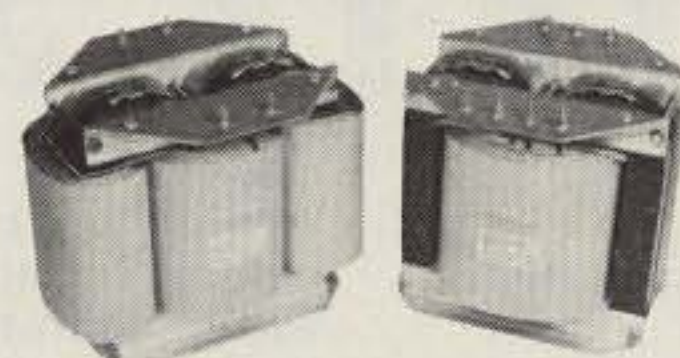

HEAVY DUTY REPLACEMENT TRANSFORMERS

| | | | |
|------------------------------|-------|---------------------------|-------|
| ALPHA A77D Power | \$135 | HEATHDX-100 Modl | \$ 95 |
| BTI LK-2000 Plate | \$135 | HEATH HX-10 Power | \$ 95 |
| COLLINS 30S-1 Power | \$215 | HEATH SB-220 Plate | \$125 |
| COLLINS KWS-1 Plate | \$135 | HENRY 2K Plate | \$150 |
| COLLINS 516F-2 Power | \$ 95 | HENRY2K-2 Power | \$155 |
| DENTRON 160-10L Power | \$125 | HENRY 2K-4 Power | \$165 |
| DRAKE L4B Plate | \$165 | HENRY 3K-A Plate | \$165 |
| GONSET GSB-100 Power | \$ 95 | HENRY 3K-A DC Choke | \$ 85 |
| GONSET GSB-201 Power | \$135 | EFJ T-BOLT Plate | \$125 |
| H-CRAFTERS HT-32 Power | \$ 95 | EFJ 500 Modulation | \$ 95 |
| H-CRAFTERS HT-37 Power | \$ 95 | EFJ 500 DC Choke | \$ 75 |
| HEATHDX-100 LV Power | \$ 95 | NATL NCL-2000 Plate | \$125 |

OFF-THE-SHELF SPECIALS

| | | |
|-------------|--|-------|
| PLATE XFMR: | 2400 VAC @ 1.5A ICAS 220/240 PRI-41LB | \$150 |
| PLATE XFMR: | 3000 VAC @ 1.5A CCS 230 PRI-60LB | \$195 |
| PLATE XFMR: | 3000 VAC @ 0.7A ICAS 115/230 PRI-27LB | \$115 |
| PLATE XFMR: | 3500 VAC @ 1.0A ICAS 115/230 PRI-41LB | \$150 |
| PLATE XFMR: | 4000/4600 VAC @ 1.5A ICAS 230 PRI-60LB | \$195 |
| PLATE XFMR: | 6000 VCT @ 0.8A CCS 115/230 PRI-41LB | \$150 |
| FILMT XFMR: | 5.0 VCT @ 30A 117 PRI-9.5LB | \$ 30 |
| FILMT XFMR: | 7.5 VCT @ 21A 117 PRI-9.5LB | \$ 30 |
| FILMT XFMR: | 7.5 VCT @ 55A 115/230 PRI-14.6LB | \$ 65 |
| FILMT XFMR: | 7.5 VCT @ 75A 115/230 PRI-20.2LB | \$ 95 |
| FIL CHOKE: | 30 AMP Bifilar Wound on 1/2"x7" rod | \$ 9 |
| DC CHOKE: | 8.0 Henries @ 1.5 AMP DC 41LB | \$150 |
| SWG CHOKE: | 5-30 Henries @ 1.0 AMP DC 23LB | \$100 |

ALL TRANSFORMERS & CHOKES GUARANTEED FOR 24 MONTHS
Many others also available. Write for free list or quote on any custom transformer, choke, or saturable reactor.

Peter W. Dahl Co. ✓ D6

4007 Fort Blvd. • El Paso, Texas 79930
Telephone (915) 566-5365 or (915) 751-4856



2 METER CRYSTALS MANY IN STOCK

FOR THESE RADIOS ON
STANDARD ARRL REPEATER
FREQUENCIES

| | |
|--------------------------------|----------------------|
| Clegg HT-146 | Regency HR-212 |
| Drake TR-22 | Regency HR-2B |
| Drake TR-33 (rec only) | Regency HR-312 |
| Drake TR-72 | Regency HR-2MS |
| Genave | S.B.E. |
| Heathkit HW-2021 (rec only) | Sonar 1802-3-4, 3601 |
| Heathkit HW-202 | Standard 146/826 |
| Icom/VHF Eng | Standard Horizon |
| Ken/Wilson | Swan FM 2X |
| Lafayette HA-146 | Tempo FMH |
| Midland 13-505 | Trio/Kenwood TR2200 |
| Regency HR-2 | Trio/Kenwood TR7200 |

\$3.95 EACH — IN QUANTITIES
OF 10 OR MORE, \$3.50 EACH

Certified check or money order only —
NO CODs

ROLIN DISTRIBUTORS
P.O. Box 436 ✓R15
Dunellen NJ 08812
(201)469-1219



HAM REPEATER AUTOPATCH

Offer your club **COMPLETE**
emergency communications

Commercial quality, gold plated contacts, plug in, epoxy glass PC boards. 12 volt DC or 115 volt AC operation — Power supply included. Four digit access — Single digit releases — field programmable. Hybrid network — No switching required. FCC certified telephone line coupler. Auxiliary "In Use" contacts supplied. Land line "call-in" signalling control contacts provided. Price complete \$498 + \$3 shipping & handling. Master Charge, Bank money order, or certified check acceptable.

Accessories: CES-300 powered tone pad — \$59 BUS-COM Soft-touch® telephone powered mike/pad element — \$34.95. ✓M76

ME **MONROE ELECTRONICS, INC.**
412 Housel Ave., Lyndonville, N.Y. 14098

The **RUGGED**



Dipole Antenna Connectors

Stand Up to
Winter's Worst

- Black die-cast aluminum body
- Steatite insulators with welded eyebolts
- Flat-top or Inverted-V
- Handle full amateur power

Commercial quality / Amateur price

B&W At your B&W dealer.

Barker & Williamson, Inc. ✓B23
10 Canal St. • Bristol, PA 19007
Telephone: (215) 788-5581

CONTESTS

from page 28

from each county activated.

AWARDS:

Certificates to top scores in each state, province, country, top 10 MO entries, and top 3 MO mobiles.

ENTRIES:

Mailing deadline for logs is December 15. Address all entries to: St. Louis ARC — K0LIR, 842 Tuxedo Blvd., Webster Groves MO 63119. Include an SASE for results.

WELLESLEY AMATEUR RADIO SOCIETY 27th ANNIVERSARY QSO PARTY

Special events station W1TKZ will be in operation for 42 hours beginning 0100 GMT November 18 and ending 1900 GMT November 19. A commemorative certificate will be awarded to those stations exchanging RS(T) and ARRL section or country with W1TKZ on phone or CW. Phone sweepstakes contest exchanges are also valid and welcomed. In order to qualify, stations must submit a completed QSL card and long SASE to Wellesley Amateur Radio

Society, 324 Washington St., Wellesley Hills MA 02181 before December 31. W1TKZ will be operating on the following frequencies: phone — 3950, 7250, 14310, 21400, 28600, 146.52; CW — 3720, 7120, 21120, 28120.

ALL AUSTRIAN CONTEST Starts: 1900 GMT November 18 Ends: 0600 GMT November 19

The contest is open to all amateurs; power input must be in accordance with licensing regulations. All contacts must be on 160 meters, on CW only. Foreign stations use the call "CQ OE," Austrian stations will use the call "CQ TEST." The authorized suballocations for Austria are: 1.823-1.838, 1.854-1.873, 1.873-1.900 MHz.

EXCHANGE:

RST and QSO number starting with 001. Each exchange must be confirmed by repeating the exchange code.

SCORING:

Every completely logged QSO (date, time in GMT, frequency in MHz, call of station, exchanges given and received)

counts one point. Club stations OE1XMA, OE3XMS, and OE5XAM count 10 points per QSO. Multipliers are 2 points for every Austrian "Bundesland" (OE 1-9), and one point for every prefix. Multiply QSO points times multipliers for final score. Every station can be contacted only once. If a station is contacted twice, the second QSO must be clearly marked as a duplicate and does not count.

ENTRIES:

Logs must be postmarked no later than December 15 and sent to: Austrian Military Radio Section — AMRS, "AOEC 1978," c/o Dr. Ronald Eisenwagner OE5REB, Fliegerhorst Vogler, A-4063 Horsching, Austria.

INTERNATIONAL ISLAND DX CONTEST Starts: 0001 GMT December 2 Ends: 2400 GMT December 3

Sponsored by the Whidbey Island amateurs with a special multiplier for QRP stations running less than 100 Watts. It is important to note that not all islands will qualify as IDX contacts. It is necessary for every contestant to have a copy of the (IDX) Island DX List on hand in order that QSO points and multiplier credit can easily be

tabulated. Enclose an SASE or 3 IRCs and write Bill Gosney WB7BFK, 2665 N. 1250 East, Oak Harbor, Whidbey Island WA 98277 for the IDX list and contest summary sheets.

Classes or operation include single- and multi-operator with single transmitters only. Mode categories include CW, phone, and mixed entries. Stations can be worked only once during the contest regardless of band or mode.

EXCHANGE:

Stations not on the IDX list give RS(T) and DXCC country. All stations on the IDX list give RS(T) and name of IDX island.

FREQUENCIES:

1805, 3555, 3715, 7055, 7115, 14055, 14155, 21055, 21155, 28055, 28155, 1825, 3815, 3895, 7215, 7285, 14215, 14285, 21315, 21385, 28515, 28585.

POINTS:

Score 10 points for each valid contact with an island listed on the IDX list which is not in your own DXCC country, 1 point for DX station contacts not on the IDX list. Count 1 multiplier point for each island shown on the IDX listing. An IDX island may be worked only once on each band for multiplier credit. Power multipliers are as follows: 500 Watts input or

Continued on page 283

This NEW MFJ Versa Tuner II . . .

has SWR and dual range wattmeter, antenna switch, efficient airwound inductor, built in balun. Up to 300 watts RF output. Matches everything from 1.8 thru 30 MHz: dipoles, inverted vees, random wires, verticals, mobile whips, beams, balanced lines, coax lines.



NEW, IMPROVED MFJ-941B HAS . . .

- More inductance for wider matching range
- More flexible antenna switch
- More sensitive meter for SWR measurements down to 5 watts output



\$89⁹⁵

Transmitter matching capacitor. 208 pf. 1000 volt spacing.

Sets power range, 300 and 30 watts. Pull for SWR.

Meter reads SWR and RF watts in 2 ranges.

Efficient airwound inductor gives more watts out and less losses.

Antenna matching capacitor. 208 pf. 1000 volt spacing.

Only MFJ gives you this MFJ-941B Versa Tuner II with all these features at this price:

A SWR and dual range wattmeter (300 and 30 watts full scale) lets you measure RF power output for simplified tuning.

An antenna switch lets you select 2 coax lines direct or thru tuner, random wire/balanced line, and tuner bypass for dummy load.

A new efficient airwound inductor (12 positions) gives you less losses than a tapped toroid for more watts out.

A 1:4 balun for balanced lines. 1000 volt capacitor spacing. Mounting brackets for mobile installations (not shown).

With the NEW MFJ Versa Tuner II you can run your full transceiver power output — up to 300 watts RF power output — and match your



ANTENNA SWITCH lets you select 2 coax lines direct or thru tuner, wire/balanced line, dummy load.

transmitter to any feedline from 160 thru 10 Meters whether you have coax cable, balanced line, or random wire.

You can tune out the SWR on your dipole, inverted vee, random wire, vertical, mobile whip, beam, quad, or whatever you have.

You can even operate all bands with just

one existing antenna. No need to put up separate antennas for each band.

Increase the usable bandwidth of your mobile whip by tuning out the SWR from inside your car. Works great with all solid state rigs (like the Atlas) and with all tube type rigs.

It travels well, too. Its ultra compact size 8x2x6 inches fits easily in a small corner of your suitcase.

This beautiful little tuner is housed in a deluxe eggshell white Ten-Tec enclosure with walnut grain sides.

S0-239 coax connectors are provided for transmitter input and coax fed antennas. Quality five way binding posts are used for the balanced line inputs (2), random wire input (1), and ground (1).

NEW 300 WATT MFJ VERSA TUNER II'S: SELECT FEATURES YOU NEED.

NEW MFJ-945 HAS SWR AND DUAL RANGE WATTMETER.

\$79⁹⁵



Same as MFJ-941B but less 6 position antenna switch.

NEW MFJ-944 HAS 6 POSITION ANTENNA SWITCH ON FRONT PANEL.

\$79⁹⁵



Same as MFJ-941B but less SWR/Wattmeter.

NEW MFJ-943 MATCHES ALMOST ANYTHING FROM 1.8 THRU 30 MHz.

\$69⁹⁵



Same as MFJ-941B, less SWR/Wattmeter, antenna switch, mounting bracket. 7x2x6 in.

ULTRA COMPACT 200 WATT VERSA TUNERS FOR ALL YOUR NEEDS.

MFJ-901 VERSA TUNER MATCHES ANYTHING, 1.8 THRU 30 MHz.

\$59⁹⁵



Efficient 12 position air inductor for more watts out. Matches dipoles, vees, random wires, verticals, mobile whips, beams, balanced lines, coax. 200 watts RF, 1:4 balun, 5x2x6 in.

MFJ-900 ECONO TUNER MATCHES COAX LINES/RANDOM WIRES.

\$49⁹⁵



Same as MFJ-901 but less balun for balanced lines. Tunes coax lines and random lines.

MFJ-16010 RANDOM WIRE TUNER FOR LONG WIRES.

\$39⁹⁵



1.8 thru 30 MHz. Up to 200 watts RF output. Matches high and low impedances. 12 position inductor. S0-239 connectors. 2x3x4 inches. Matches 25 to 200 ohms at 1.8 MHz. Does not tune coax lines.

For Orders **Call toll-free 800-647-1800**

Order any product from MFJ and try it. If not delighted, return within 30 days for a prompt refund (less shipping).

Order today. Money back if not delighted. One year unconditional guarantee. Add \$2.00 shipping/handling.

For technical information, order/repair status, in Mississippi, outside continental USA, call 601-323-5869.

Order By Mail or Call TOLL FREE 800-647-1800 and Charge It On

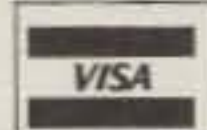

MFJ ENTERPRISES

P. O. BOX 494

MISSISSIPPI STATE, MISSISSIPPI 39762 ✓M52

The History of Ham Radio

—part VII

Reprinted from QCC News, a
publication of the Chicago
Area Chapter of the QCWA.



A WARNING

to Manufacturers
Importers
Dealers
Jobbers
Agents
Amateurs
Purchasers
Users of

Vacuum Tubes
The Marconi V.T. Patent is Basic

United States Letters Patent to Fleming, No. 803,684,
November 7, 1905, has been held to be valid by Judge
Mayer of the United States District Court for the
Southern District of New York, and by the United
States Circuit Court of Appeals for the Second Circuit.

It is a basic patent and controls broadly all vacuum tubes used as detectors, amplifiers or oscillators in radio work.

No one is authorized to make, sell, import or use such tubes for radio purposes, other than the owners of the patent and licensees thereunder. Any others making, selling, importing or using them alone or in combination with other devices, infringe upon the Fleming patent and are liable to a suit for injunction, damages and profits. And they will be prosecuted.

THE AUDIOTRON AND THE LIBERTY VALVE ARE NOT LICENSED UNDER THE FLEMING PATENT

The price of the genuine Marconi V.T. delivered is \$7.00 each. The standardized socket is \$1.50 additional. The standard resistance, complete, costs \$1.00 and is made in the following sizes: $\frac{1}{2}$ megohm, 1 megohm, 2 megohms, 4 megohms, 6 megohms.

Do not take chances by making, importing, selling, purchasing or using vacuum tubes for radio purposes not licensed under the Fleming patent. By selling, purchasing or using licensed tubes for radio purposes you secure protection under the Fleming patent and avoid the risk of litigation for infringement thereof.

This warning is given so that the trade and public may know the facts and be governed accordingly.

Send all remittances with order to COMMERCIAL DEPARTMENT

MARCONI WIRELESS TELEGRAPH CO. OF AMERICA
RADIO CORPORATION OF AMERICA
233 Broadway Woolworth Building New York

Sole Distributors for De Forest Radio Telephone & Telegraph Co.

Retail Office and Exhibition Room, 25 Elm St., New York
Insurance Exch. Bldg., San Francisco, Cal.
134 Federal St., Boston, Mass.
301 Commercial Bank Annex, New Orleans, La.
100 South 1st St., Philadelphia, Pa.

In the early 1920s, what effect did the emergence of radio broadcasting have on the amateur radio operator? Could it have been that he was directly responsible for the great popularity of this new entertainment field? Was amateur radio in some measure the instigator?

Amateur Radio Broadcasting

In 1919, Frank Conrad 8XK, one of our enthusiastic wireless amateur pioneers living in Pittsburgh, used his amateur station to entertain nearby listeners with musical renditions. He used an ordinary telephone mouthpiece as a microphone. This same station, with several modifications, went on the air as KDKA on November 2, 1920, known as the Westinghouse Pioneer Broadcaster.

Early Broadcasting

History records that, as far back as 1910 and 1911, there were voice-modulated signals heard via wireless. These emanated

from early experiments with the quenched arc-gap transmitters. Dr. Lee DeForest, the well-known inventor of the triode, had a voice-modulated vacuum tube circuit in operation in his laboratory in these early years.

With wireless broadcasting ushering in a complete new mode of living for millions, the old system of dots and dashes had to give ground to modulation of the ether waves by voice and music. Normal amateur communication now had company, as the general public suddenly took a fancy to this mysterious phenomenon. Such desirable services as weather and market reports, now via wireless, became an essential part of the daily menu for listeners, especially the farmers and the country folks. A new and exciting national pastime was ushered into being.

In the fall of 1920, station KDKA announced the first nationwide election returns of the Harding-Cox presidential contest. The immediate result of the over-the-air broadcast was hundreds of requests, directed to the Department of Commerce, for broadcasting station licenses. There could be no doubt that the entertainment factor suddenly stemming from dozens of stations would take over the airwaves. Experimenters, many companies, private organizations, and even individuals vied with each other to jump in and broadcast something, just to be heard.

Licensing

In the very beginning, the Commerce Department made available three general types of license permits. These were: 9XAF—experimental, designated by an X prefix; 9YAN—institutional and

training school, a Y prefix; 9ZHB—clubs and private organizations, a Z prefix.

The assigned frequency depended somewhat on the type of program the station intended to put on the air. The department issued such licenses for only three-month periods at a time. As the number of requests to broadcast mushroomed, all licenses to broadcast had more extended periods and were designated with either a W or a K prefix.

Amateur Radio Operators as Broadcast Listeners

There was no doubt that this newly discovered scientific wonder of broadcasting via radio had the amateur wireless operator deeply involved. He was found in the forefront of all the activity. With his innate knowledge of radio's mystery, he formed the nucleus of the listening public. He was in great demand to supply the information and, what then became necessary, the receiving devices to the nonamateur public. There soon appeared the first one-tube "music box," equipped with a pair of earphones or just a single earpiece. Where distance from the transmitter was short, many early listeners used ordinary crystal detectors. The music box became an addition to the household, often replacing the phonograph and/or the piano for the evening's entertainment. Concerts, lectures, recitals, and news were there to enjoy as these events took place. Naturally, these sudden changes thrust upon an unsuspecting public brought about an almost revolutionary altered standard of living.

Major problems in the overall radio field developed because of the wavelength allocations for hundreds of domestic sta-



RADIO CORPORATION OF AMERICA

JOINT PROGRAM

WEEK ENDING SATURDAY, JUNE 2nd

455 WJZ METERS
and
405 WJY METERS

Radio Broadcast Central

Issued by
Information Bureau
Radio Corporation
of America
Room 1840
233 Broadway
New York City

(Daylight Saving Time)

RADIO CORPORATION OF AMERICA



STATION "WJZ"
BROADCAST CENTRAL,
AEOLIAN HALL, N. Y. CITY
455 Meters

Saturday, May 19th

3:00—Soprano Solo by Helen E. Smith
Selected Program

3:15—"Book Review," by Grace Isabel Colbron

3:30—Piano Solo by Ida Kreshefski
Four Old Dutch Songs
.....arr. by Joseph Hoffman
"Nocturne, C Minor".....Chopin
"Le Coucou".....Daquin

3:45—Soprano Solo by Helen E. Smith
Selected Program

4:00—Piano Solo by Ida Kreshefski
"Scotch Poem".....McDowell
"Military Polonaise".....Chopin

4:15—Soprano Solo by Miss H. Rennyson
"The Star".....Rogers
"At Dawning".....Cadman
"One Fleeting Hour".....Lee
"Love Is a Bubble".....Allitsen

4:30—Violin Solo by Miss Ruby McDonald
Selected Program

4:45—Soprano Solo by Miss Helen Rennyson
"Bitterness of Love".....Dunn
"Believe Me if All Those Endearing
Young Charms".....
"Sonny Boy".....Curran

5:00—Violin Solo by Miss Ruby McDonald

6:00—Uncle Wiggley's Bedtime Stories

7:30—Soprano Solo by Mme. Jaillet

7:45—Fashion Talk by Harper's Bazar

8:00—Joint recital by Mme. Cecil Arden, Mezzo-Soprano, of the Metropolitan Opera, and Miss Carolyn Beebe, pianist, of the New York Chamber of Music Society.

9:00—Army Night Program
"Invincible Fidelity" (March).....Fraternach
"Isle of Beauty" (Overture).....Bernard
"The Commodore Polka".....Chambers
Cornet Solo by Staff Sergeant Herbert F. Davis
"Vera" (Waltz).....Lithgow
"Robin Hood" (Selection).....De Koven
"Salute to Dixie" (March).....Fraternach
(All numbers not otherwise noted by the Band of the 62nd Artillery, A. A.)

tions which were clamoring for space in the ether spectrum.

Toward the end of 1921, the Department of Commerce was compelled to appoint a committee to try to devise a new code of on-the-air ethics. This was an attempt to correct a situation brought about by radio phone, something which could not have been foreseen in the original established laws of 1912.

Now two important matters came up for consideration: (1) regulating amateur broadcasting, and (2) solving interference problems between amateur transmissions, commercial broadcasting, and the novice listener.

In January, 1922,

Herbert Hoover, Secretary of the Commerce Department, introduced proposed radio legislation requiring all transmitting stations used for broadcasting news, concerts, lectures, and similar programs to employ limited commercial license operators at the controls and to adjust wavelengths to 360 meters, with 485 meters to be used for issuing crop reports and weather forecasts.

Although the regulations issued by the Commerce Department were only temporary, they did cause concern among radio amateurs. They felt that some of their legitimate services were being curtailed, whereas the department always recognized

the great national asset of amateur activities. With the phenomenal growth of broadcasting, however, it became necessary to regulate operations before the situation got completely out of hand. It was reasoned that, as long as the general public interest was being served, broadcasting had to continue, but not merely to satisfy someone's personal amusement desire. Coupled with miserable plate supplies, some stations severely cluttered up the airwaves. Under these conditions, the amateur 200 meter band became so overloaded that amateurs were finally asked by Secretary Hoover to collaborate and collectively

come up with suggestions of their own for regulating the traffic in their own bailiwick. The understanding was clear to all. Between the telegraph and the phone, one necessarily must be subservient to the other. There was grave fear that the parting of the ways for amateur operation was imminent.

The First National Radio Conference

When the First National Radio Conference was called in Washington on February 27 to March 2, 1922, there was common agreement among all concerned in the final report that was issued: no more phone broadcasts by amateurs.

Although this verdict set certain amateur stations somewhat aback, they did come away from the sessions with a recommended wave assignment extended to a range between 150 and 275 meters. At the conference, an amateur was henceforth defined as follows:

"An amateur is one who operates a radio station transmitting or receiving or both without pay or commercial gain, merely for personal interest or in connection with an organization of like interest."

Amateur Phone Vs. CW

How did all this change affect the amateur who had used the ether as his own domain for so many years? There was no way in which he could escape this "invasion" of his accustomed privacy. An unavoidable controversy soon developed among the CW and the phone hams. Without customary cooperation, it was recognized that the ether waves were loaded with interference of a new kind. How could the relation between the amateur phone operator

and the dot and dash proponent avoid a serious break in the internal ranks, a situation which was evidenced in some QST correspondence between the older dyed-in-the-wool amateurs and the newcomers?

Added to this internal trouble of radio phone vs. code men, wireless had to come to grips with yet another problem, namely, citizen radio as distinguished from amateur radio. Would you believe that QST used its front cover page to designate its monthly magazine as follows: devoted exclusively to *citizen* radio (August, 1922); and the following month it came up with: devoted exclusively to *amateur* radio (September, 1922)? Typical amateur radio stood at the crossroads for a time.

To minimize chaotic interference, all phone broadcasts, those operating on virtually the same wavelength as the code stations, soon discovered that they were jamming each other unmercifully. What was pleasure turned into bedlam. All early courtesies of the ether waves, which had become recognized, were discarded and forgotten. To the technician who operated on phone, the code man was visualized as an ignorant brass-pounder. Among the old-time CW amateurs, it was suggested that the phone man join a radio club or visit another station and observe what was going on among us "amateurs."

The Need for Order

By the fall of 1921, the radio telephone had heavy competition. There was the commercial broadcaster, the amateur broadcaster, the code man, and the many thousand helpless novice listeners. The various problems that developed were rapidly

becoming more serious to amateur radio. Also apparent to everyone was the sudden upheaval in the transgression of existing legislation to control transmitters. For a number of years, no consideration had been given toward initiating revisions in the old 1912 law.

At the conclusion of the conference, all amateurs were informed that, effective immediately, a silent period must be observed from 8:00 to 10:30 pm daily and during Sunday morning church services. The First National Radio Conference placed commercial broadcasting into the 310 to 435 meter range. The amateur was not only assured his existence, but also came out ahead in the assigned wave-band territory in which he could operate. He was asked to so divide his newly designated territory to the satisfaction of all concerned.

The radio conference in Washington was well attended by all parties affected and served to allay a number of conflicts. The regulations proposed were only recommendations to be observed between many interests. All realized that this was no binding law, albeit it was a hope that all would cooperate. In an attempt to approve wavelengths, however, the allocations came to naught because the military interests still dominated the deliberations and a tentative international agreement drawn up was promptly repudiated.

Proliferation of Broadcasting Stations

By April, 1922, there were 60 large and powerful broadcasting stations operating on the air, with approximately 500 applications for broadcast licenses pending. Such proliferation of signals emanating from so many

stations in the assigned operating spectra, with no binding assigned frequencies, proved chaotic. More hearings were scheduled by the secretary, but, since recommendations did not carry legality, there could be no enforcement, so agreements were not respected.

The amateurs at the conference heard plenty of discussions about giving up spark transmitters altogether in order to alleviate interference. CW had come into its own in many stations. Just one paramount drawback, however, slowed the changeovers. The cost of the higher-power tubes for conversion necessary to compete with the power output of the spark was still a factor. New power supplies required a new approach to deliver a signal. Such costs put a decided crimp into the ham's pocketbook. The time was not ripe for abolishing one system for the other, as much as this was desirable. Patent litigations among the larger companies and corporations hindered many developments in equipment and accessory components, especially in the vacuum tube area, where competition for manufacturing rights was especially keen.

By now, there were approximately 14,000 licensed amateurs in the United States. The American Radio Relay League made a request at one of the regional conventions to lend a helping hand to the many broadcast listeners, who, like the farmer, his family, the grocer, and the banker, had no knowledge of adjusting even the simplest receiver. The receivers available on the limited market in many instances were still so primitive and crudely constructed that selectivity was impossible to attain, making elimination of in-

about 30 mV input. The meter deflection should then be reasonably proportional to audio frequency input.

I added RB in parallel with the meter to act as a linearity corrector. It corrects small segments of the meter scale for improved linearity. With RB set at a maximum of 10k, the meter linearity on any range is within 5 percent. By calibrating with a known audio frequency, the range linearity can be improved to about 30 to 60 percent of full scale meter reading. I would set the audio oscillator to 5 kHz, then reduce RB to make the meter read exactly half scale (remember to have the op amp clipping). The resulting linearity between 20 and 70 percent of full scale was improved. If desired, RB may be left out altogether with no great loss of linearity.

A simple check for sufficient input amplitude, whether from an audio oscillator or frequency modulated rf source, is to see whether increasing or decreasing the input amplitude of audio or modulated rf causes an appreciable change in meter deflection. On the 20 kHz range, the meter indication must be multiplied by two. For deviation measurements, rf pickup is provided to J1. A local oscillator (LO) is then provided by an appropriate crystal plugged into the crystal socket or an external LO signal can be applied to J2 with S_A in the external position. When using an external or internal signal source, it is required that a fundamental or harmonic output equal to the transmitter frequency and of sufficient amplitude to provide a detected signal that will cause the op amp to commence clipping be used.

When the transmitter is keyed, the meter will indicate any audio beat dif-

ference in frequency between the transmitter and deviation meter LO source. Adjust C_X for a minimum reading. Any hum, noise, or alternator whine will produce a residual reading on the meter. C_X is adjusted through a hole in the chassis bottom plate. If an external LO is used, the frequency is externally adjusted at the source for the lowest meter reading on the deviation meter. Steady tone modulation can be applied to the transmitter and the deviation control adjusted as indicated on the meter. Since the deviation meter circuit responds to average current, the readings obtained with voice will tend to be characteristically lower. This is a function of the ballistics of the meter used, and is also dependent on the waveform characteristics of the particular voice used.

Even though the deviation meter is not accurately peak reading, i.e., will follow instantaneous voice peaks, error can be minimized by adjusting the modulator clipping circuitry found on most transmitters. The modulator clipping circuitry should be adjusted to just commence clipping at the desired (steady-state tone modulation input) deviation meter reading. Several transmitters may be netted by setting the deviation meter LO at the desired frequency, then adjusting the frequency of each transmitter in turn, watching for a minimum deflection of the deviation meter.

As there is sufficient LO energy present at J1, receiver LO adjustment may be effected in the same manner. Another cross-check for calibration of the deviation meter could be made with the use of Bessel nulls ($B = \Delta f/f_m$). I performed this with a Heath S13-620 spectrum analyzer. The first Bessel

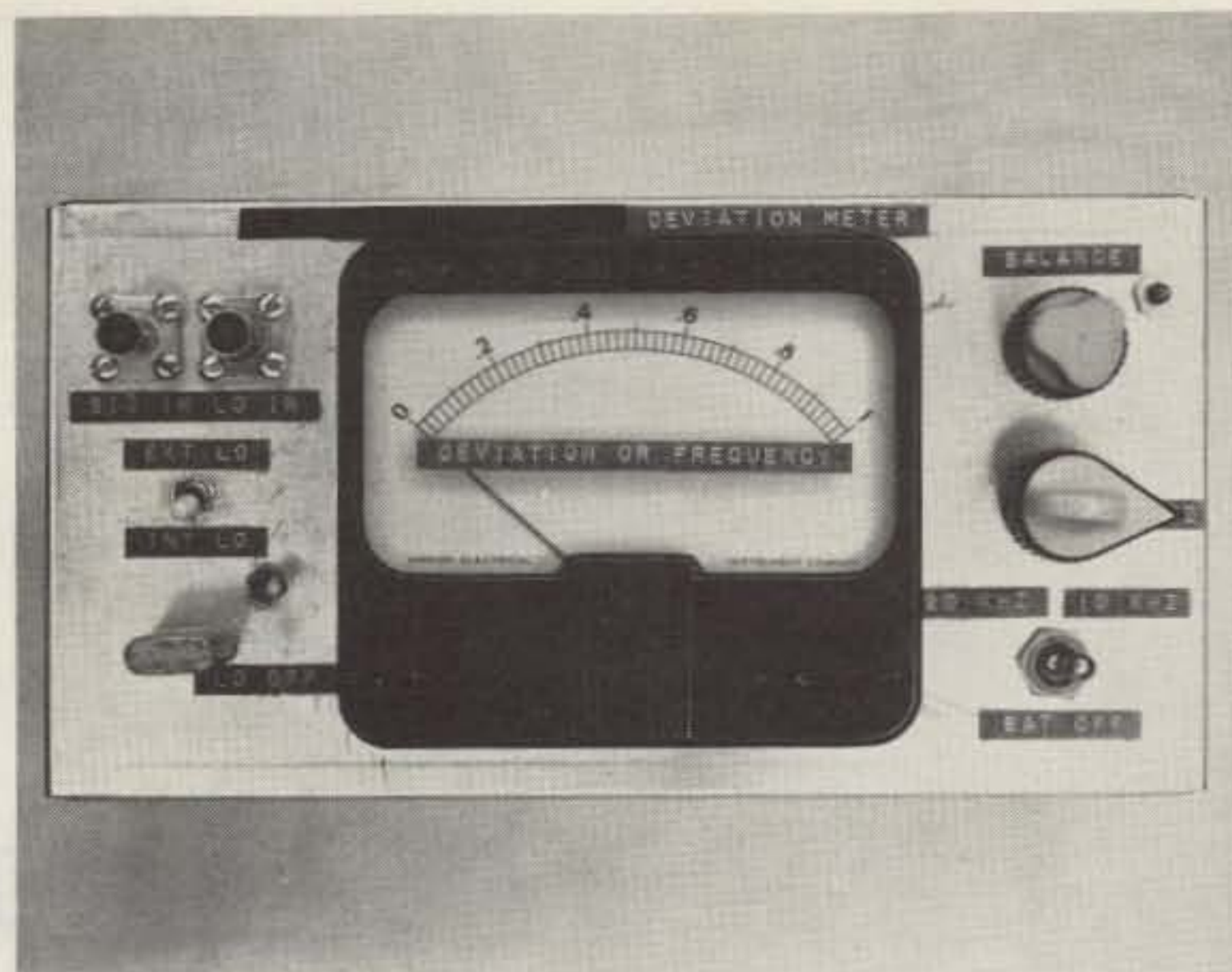

Front panel layout showing controls and functions. Control at upper right (marked Balance) was later changed to Linearity, which it is called in the text.

null or zero crossing occurs at a Bessel function value of 2.3. Then, using 4 kHz as a desired deviation, $2.3 = 4.0/f_m = 1.739$ kHz.

I then set my audio signal generator very accurately on 1.739 kHz. I have a method of doing this to .01 percent or better accuracy. I then increased the input to the 2 meter FM transmitter modulator, observing the spectral display on the analyzer until the carrier line nulled at the first Bessel crossing. You have now accurately produced 4 kHz deviation and the deviation meter should

indicate correspondingly. If no spectrum analyzer is available, one may use a very selective receiver tuned to the center frequency of the carrier or at the center of the 2 meter receiver's i-f. The transmitter deviation is then increased until the carrier nulls. The receiver must have a selectivity position appreciably better than 3 kHz in order to resolve the carrier null. Care must also be exercised to ensure the receiver is indeed tuned to the carrier and not one of the close-in upper or lower sidebands. ■

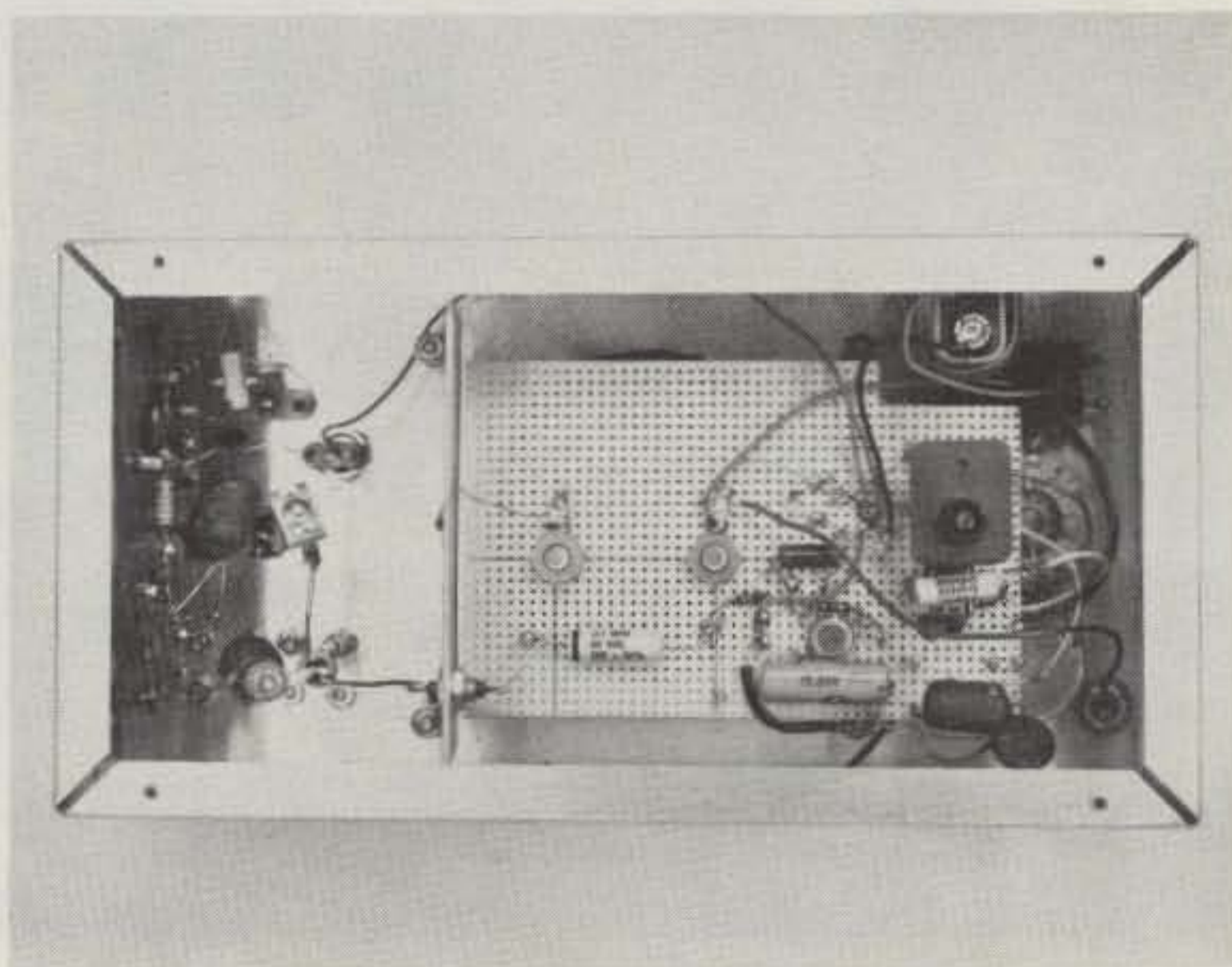

Bottom view of chassis. C_X is seen in center of chassis at far right. It should be adjusted with bottom plate installed.

Another Surplus Treasure

— convert the R-648/ARR-41 receiver

Gary McClellan
Box 2085
La Habra CA 90631

How would you like to have a general-coverage communications receiver that covers from 150 kHz to 25 MHz and features digital tuning for a bargain price?

The R-648/ARR-41 receiver has been showing up in surplus channels lately, and it has these requirements. For about \$100 to \$175 you get the above features and much more. Here are some other features it has: an oven-controlled crystal calibrator that generates calibration points every 250 kHz, double conversion on nearly all frequencies, switchable selectivity (via Collins mechanical filters), permeability-tuned vfo, modular construction, two rf stages, and so on. It's also easy to convert for home use, a definite boon in my opinion because that is where I do all my listening!

For years, I have been interested in SWling, and, since few ham band transceivers cover the international shortwave bands, I have been unable to do any SWling. Reviews in *73 Magazine* of shortwave general-coverage receivers had fired



me up enough to seriously look into buying one of these units — that is, until I checked prices. So I put off buying a general-coverage receiver for a while. Then Fair Radio Sales of Lima, Ohio, started advertising the military surplus R-648 radio receiver at a price I could afford to pay. Before long, the postman was delivering a large box, and that is what led up to this article.

Naturally, the first thing I did was unpack the unit and pull the cover off, exposing the works. It's a rather hefty set by today's standards, weighing about 30 pounds, and is about the size of the old BC-348 (remember that?) aircraft receiver. My unit was built for the Navy, apparently around 1961, according to the date codes on the various parts. So it is not too old. This set has a lot of interesting features, such as essentially all parts are contained in six plug-in modules. Each module comes out simply by removing the red painted screws. Even the front end comes out. Loosen a few screws and it lifts out, mechanical tuning section and all. I might add that this set is permeability-tuned like a car radio — there are a bunch of ferrite slugs moving in and out of coils on this set. The front panel can be swung down and unplugged from the receiver, too, a decided asset because my unit had a

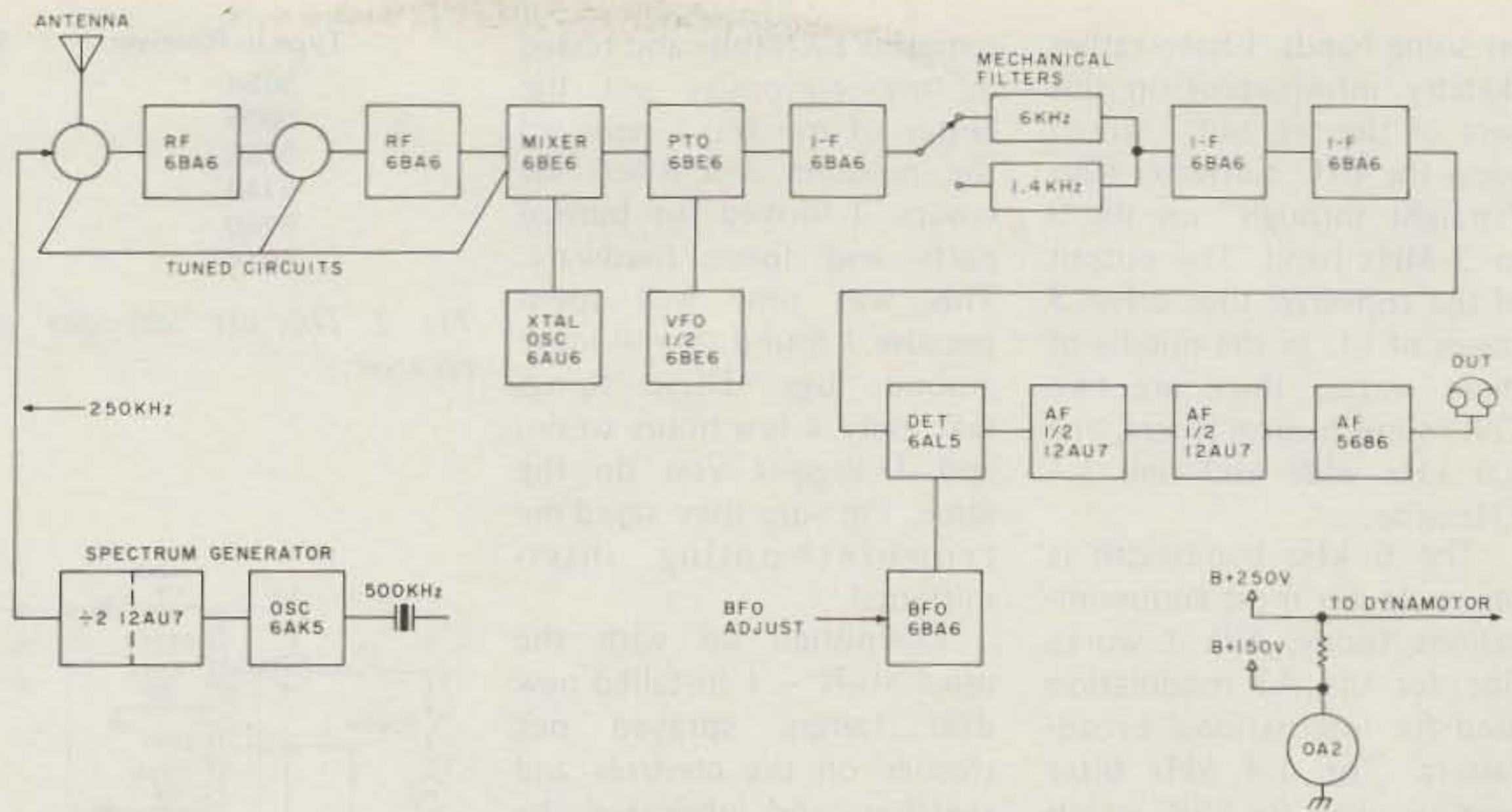

Fig. 1. Block diagram of R-648/ARR-41.

burned-out power switch. Replacement was easy.

I purchased a schematic diagram of this set from Fair, so I could figure out what I bought and how to convert it for home use. Fig. 1 shows a block diagram of the R-648/ARR-41. Two rf stages amplify the signal from the antenna and drive a mixer stage. If I remember correctly, two rf stages are not used for gain; they isolate the antenna from the local oscillator, preventing rf signals from reaching the antenna. This could give enemy forces a signal to track with. The mixer is driven by a crystal-controlled local oscillator. This is the first signal conversion. The output signal drives a converter stage, which is housed in the

permeability-tuned (PTO) vfo section. This section is tuned directly by the "Kilocycles" dial. The crystal oscillator crystals and the proper coils

are selected by the "Megacycles" dial, by contrast. The PTO converter accepts signals either from the mixer stage or directly from its rf amplifiers

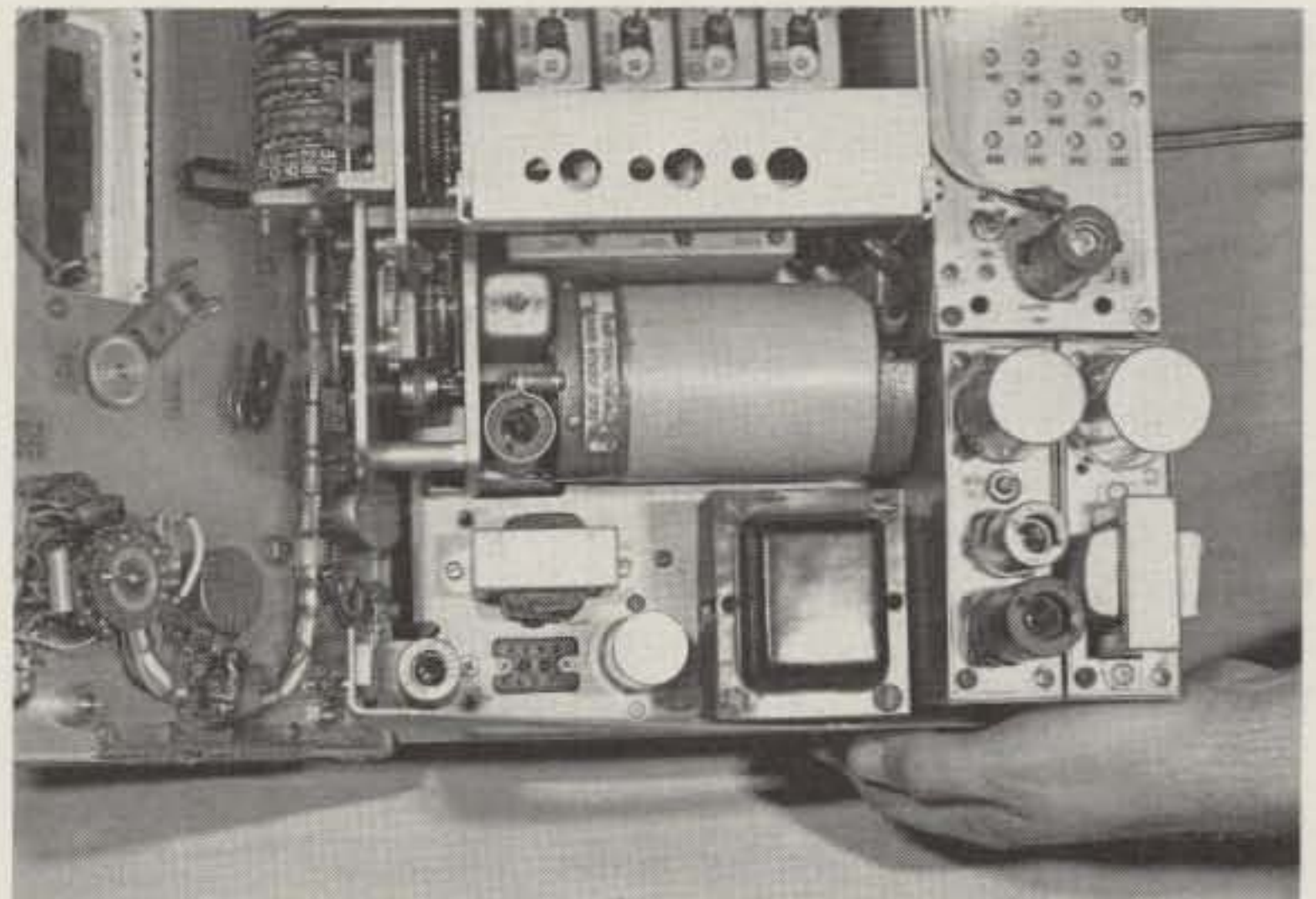

Top view again. Converted power supply is located next to hand in this picture.

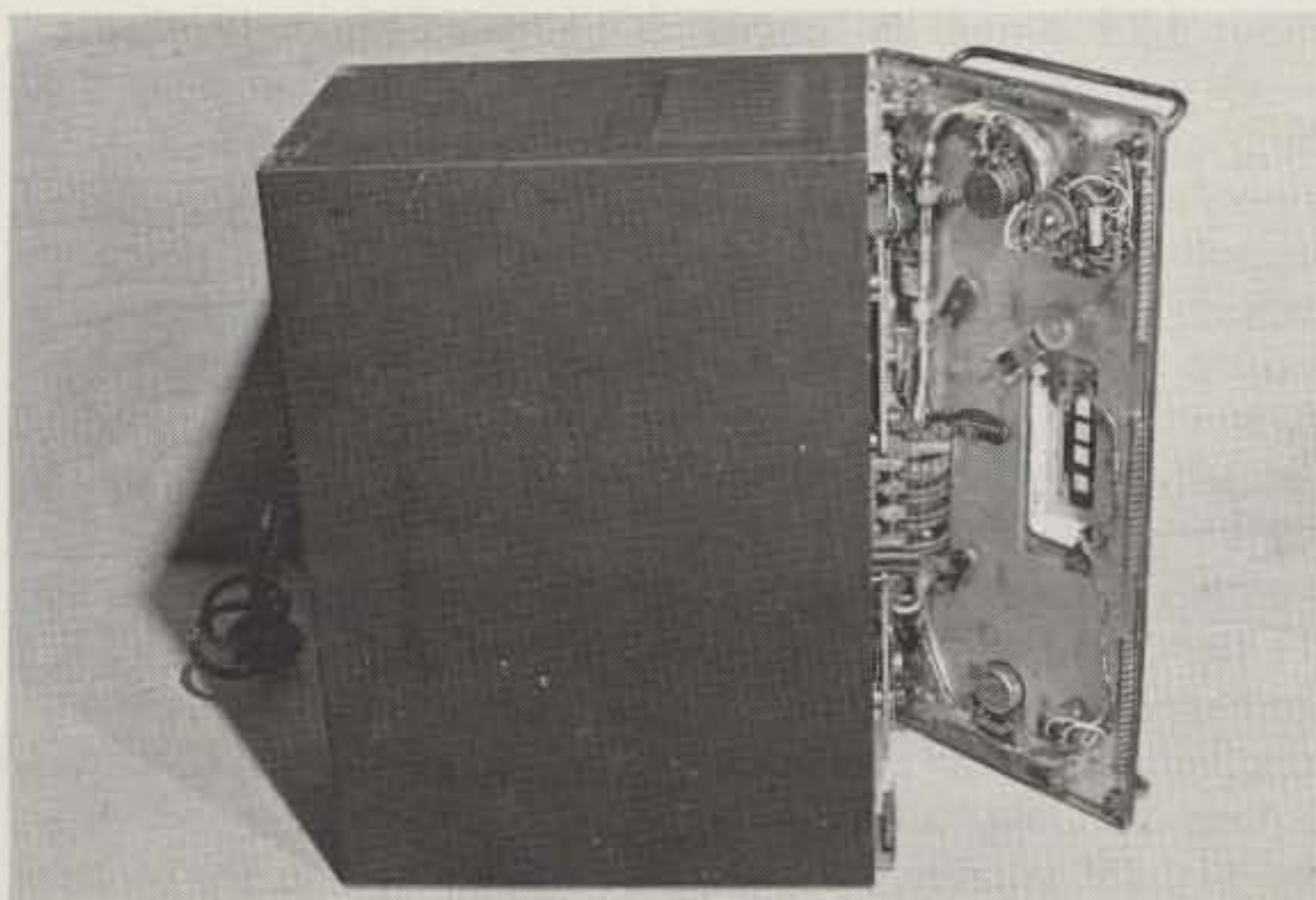

Top view of receiver. Front panel swings out and may be completely removed.

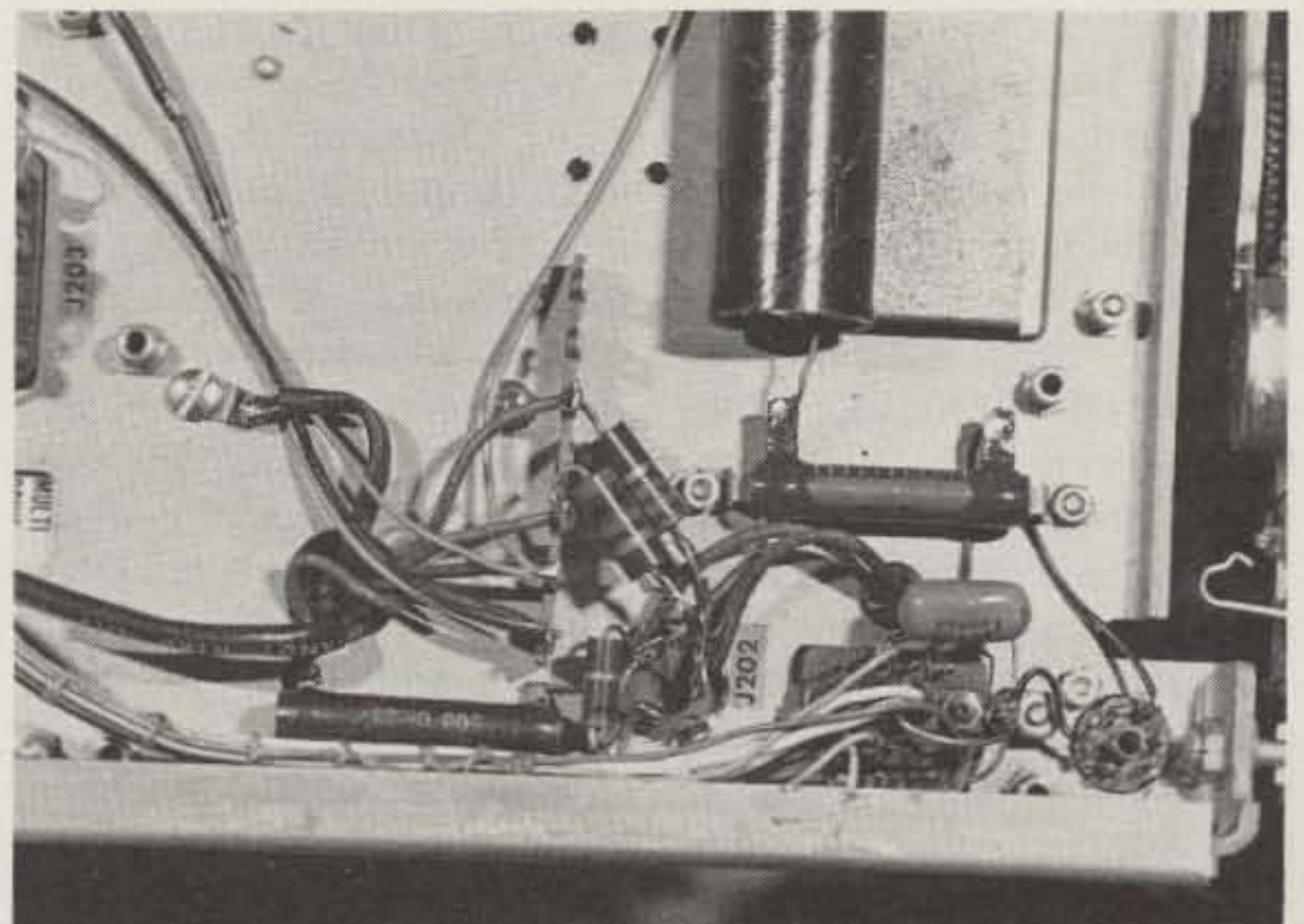

Close-up of power supply components under chassis.

on some bands. I have rather sketchy information on this part of the set, but I would guess the PTO converter runs "straight through" on the 2 to 3 MHz band. The output of the converter then drives 3 stages of i-f. In the middle of these stages, there are two Collins mechanical filters, one 6.0 kHz wide and one 1.4 kHz wide.

The 6 kHz bandwidth is too wide for most communications today, but it works fine for the A3 modulation used for international broadcasters. The 1.4 kHz filter worked okay for SSB, which was surprisingly easy to tune in on a surplus receiver (ever try an ARC-5?), but a sharper filter would be nice. The i-f frequency is 500 kHz, by the way. Following the i-f stages, there is a diode-tuned bfo (no tuning cap on the front panel), a detector, noise limiter, and avc gate. Nothing's really new here. Rounding out the set, there are three stages of audio. Surprisingly, this set suffered from the well-known "head-set audio" which surplus receivers seem to be prone to. After I had the set running, I modified it for more output. There is also a crystal calibrator (which they call a "spectrum generator"). It has a 500 kHz crystal in an oven, which is divided by two for the calibration markers.

That's a quick summary of what's inside the R-648 receiver. The next step is to convert it so you can use it.

Once I had an idea of what I'd bought, I decided to clean it up a little. You might want to do the same things I did; they may save you troubleshooting later. First, I removed each of the tubes and tested them. Since all of the tubes are numbered (e.g., 5750 instead of 6BE6), you'll need the chart of Fig. 2 to convert your tubes into ones that can be tested on most tube testers. You'll probably have trouble testing the 5686 — there is no equivalent for it. I had to test mine in an industrial tube tester. As I

removed each tube and tested it, my curiosity got the better of me and I removed the modules and lifted the covers. I looked for burned parts and loose hardware. This was time well spent because I found several loose ground lugs. These things take only a few hours to do, and I suggest you do the same. I'm sure they saved me troubleshooting intermittents!

I finished up with the usual stuff — I installed new dial lamps, sprayed pot cleaner on the controls and switches, and lubricated the tuning gears. If you are lucky enough to get a mint unit, you may not have to do all this. But it is easy work.

I looked into converting this unit and devised three ways. You are welcome to pick the one you like. They are arranged in the order of the amount of time they take to do, with the quickest one first.

The first method is hardly a conversion at all. You simply hang an antenna, a pair of 600-Ohm phones, and a 24-volt power source on the receiver. There is one flaw in this conversion; the dynamotor must be in place for it to work. I didn't get the dynamotor, so I couldn't try this method. Then you'll need 24 volts. Either get a 24-volt, 10-Amp power supply or two 12-volt car batteries in series. Connect the negative lead from the power supply/batteries to pins B and E on power jack J-301. Then tie the positive lead to pin D of the same jack. Plug in an antenna and headphones (stereo headphones will do in a pinch). Flip the power switch on, and you should be rewarded with a big squall from the dynamotor. A few moments later, you should get noise in the phones and then the usual SW-type stuff.

The next conversion method will probably follow after you or your wife gets tired of the racket from the dynamotor. You remove the

| Type in Receiver | Standard Type Replacement |
|------------------|---------------------------|
| 5654 | 6AK5 |
| 5686 | No sub. |
| 5726 | 6AL5 |
| 5749 | 6BA6 |
| 5750 | 6BE6 |
| 5814 | 12AU7 |

Fig. 2. This list "decodes" the numbered tubes found in the receiver.

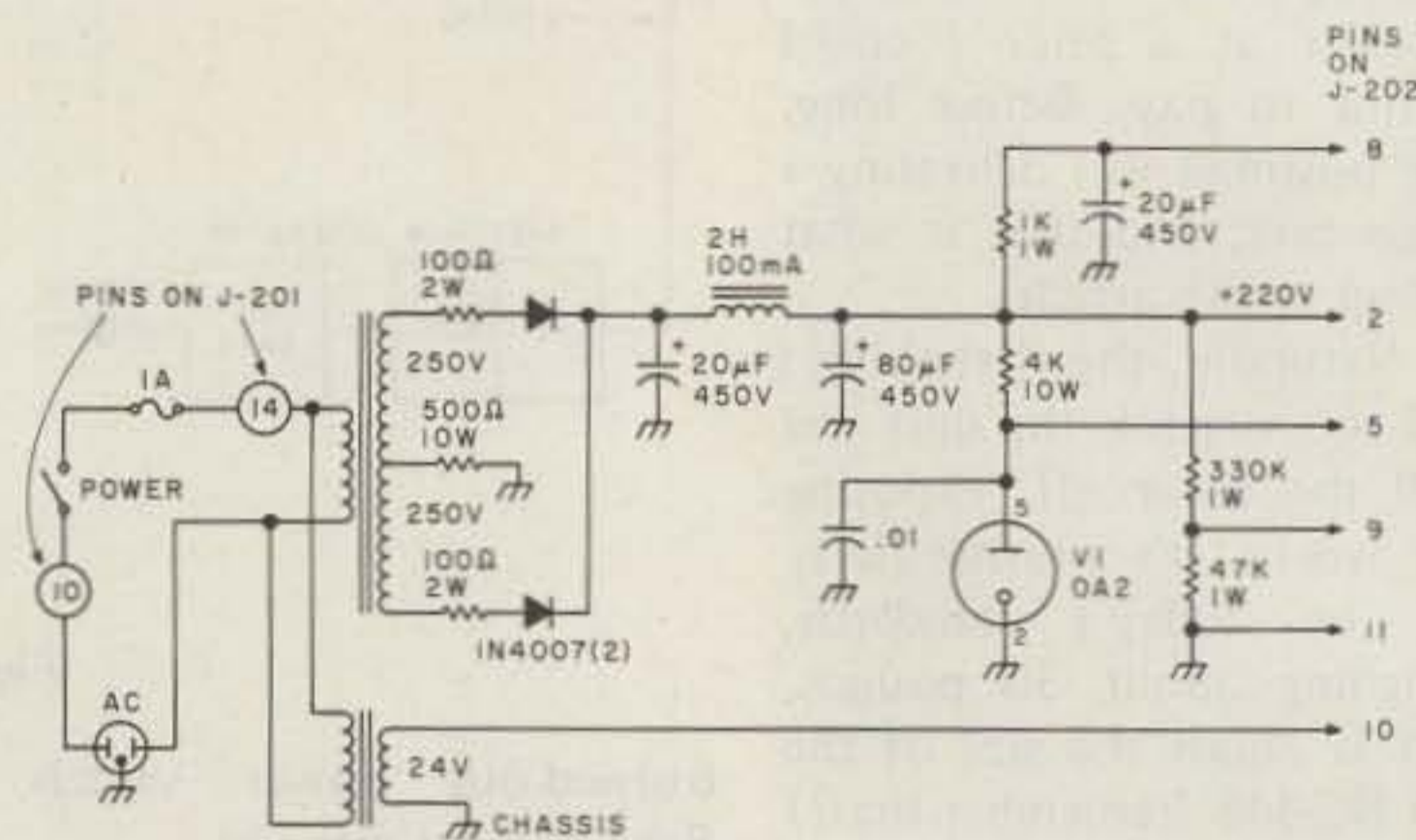

Transformer Requirements

| Minimum* | Suggested (get this one) |
|-----------------------------|------------------------------------|
| B+ 250-0-250 volts at 70 mA | = 250-0-250 volts at 100 to 120 mA |
| Fil. 24 volts at 1.25 Amps | = 24 volts at 2.5 Amps |
| or** | or** |
| 6.3 volts at 4 Amps | = 6.3 volts at 6 Amps |

*This is the current the set draws.

**Used in the last conversion method only.

Fig. 3. Power supply schematic. You may have to juggle some resistor values to get the correct output voltages, but get 220 to 250 volts on the main B+ line, and you are all set.

offending dynamotor and replace it with a power supply, naturally. If you choose your parts carefully, you can mount everything in the space left by the dynamotor. Fig. 3 shows the details. The first thing you do is find a 24-volt filament transformer. The filaments draw slightly more than an Amp — about 1.25 Amps, as I recall — so you would use a 2.5-Amp transformer. The B+ supply needs 250 volts at around 70 mA; a standard receiver power transformer would work here. Since power transformers are expensive, you will probably want to scrounge for one. Another prospect is the Fair Radio model 818 transformer. It has a 500 V c-t, 80 mA winding and a 24-volt, 2-Amp winding, and it sells for \$10.75. I haven't tried it in this application, but it looks small enough to fit in the dynamotor well and

provide all the voltages. I followed this method using the power supply shown, and you can see my handiwork in the photos. All of the parts mount directly on the chassis, as you can see. The 0A2 tube was used as per the original circuit. You might get a 150-volt, 10-Watt zener diode and use it instead.

I found the parts at a local flea market. Someone sold me an old Bogen AM/FM tuner for a dollar, and I ended up with the necessary 500-volt c-t transformer, a filter choke of about 2 henrys, and a set of spare tubes, which is not bad for a dollar. I did have to rewire the filaments for 6.3 volts, though, but the savings was worth it. I did include a 500-Ohm, 10-Watt resistor in the center-tap lead of the transformer. This was done so the receiver would run a little cooler — the B+ fell to 220 volts.

The third modification is

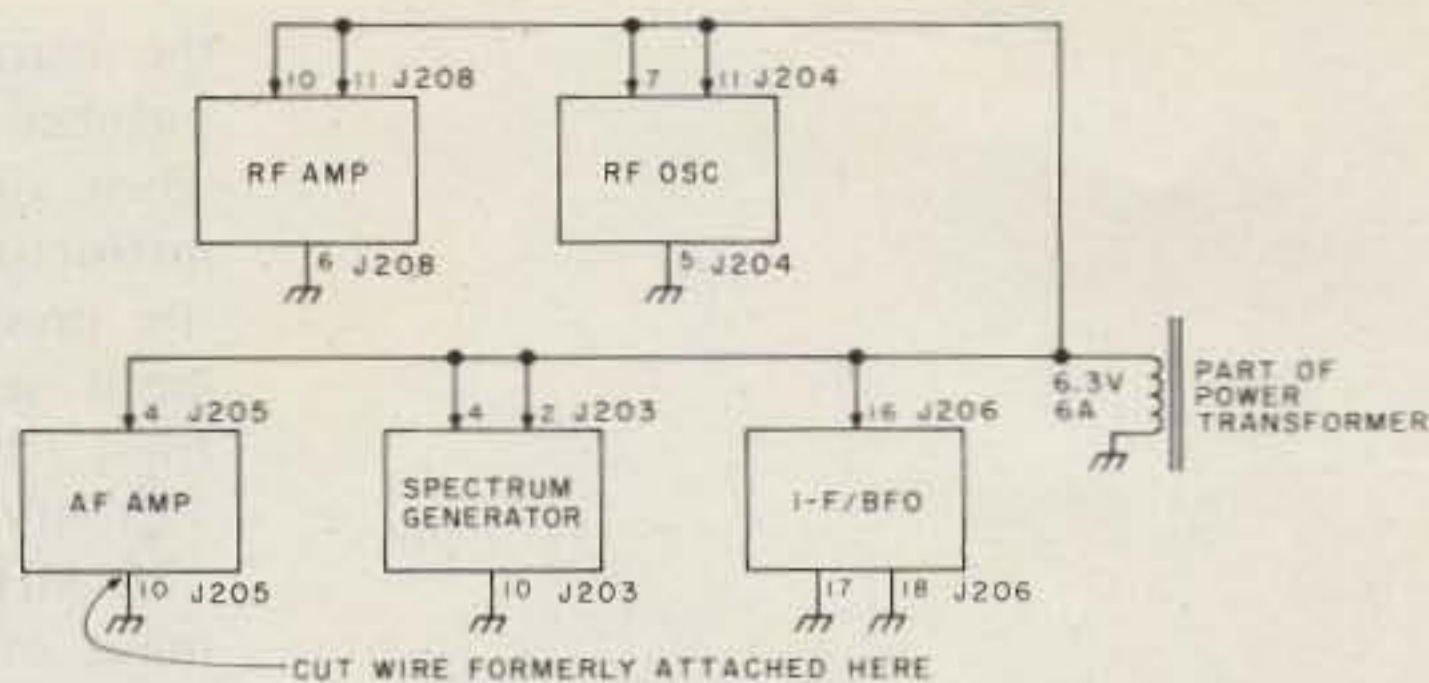

| Module | Conversion | Power input |
|-----------------------------|--|--|
| I-f bfo assembly | connect pin 3, V505 to pin 16, P-501 | 6.3 volts to pin 16, P501 ground pins 17 and 18, P501 |
| Af amplifier assembly | ground pin 9, V1301 | 6.3 volts to pin 4, P1301 ground to pin 10, P1301 |
| Rf oscillator assembly | no mod | 6.3 volts to pin 7 or 11, P601 ground to pin 5, P601 |
| Spectrum generator assembly | <ol style="list-style-type: none"> 1. jumper pins 4 and 2 on P750 2. remove R754 (39 Ohm, 2 W) 3. ground pin 4 of V750 or pin 9 of V751 | 6.3 volts to pins 4 and 2, P750 ground to pin 10, P750 |
| Rf amplifier assembly | <ol style="list-style-type: none"> 1. ground pin 4, V701 2. cut wire on pin 4, V702, then ground this wire 3. add jumper to pin 4, V702, and connect to pin 4, V703 4. jumper pins 10 and 11 of P701 | 6.3 volts to pins 10 and 11, P701 ground to pin 6, P701 |

Fig. 4. Wiring data for 6.3-volt filaments.

the most ambitious of all. I used the power supply discussed before, but I rewired all of the filaments. You may not want to do this if you don't care to tinker with the converted receiver; I like to tinker and I like to be able to remove modules without worrying if other tubes' filaments will not be lit if I pull a module. In other words, this is a bit of a job. But, since I made this conversion, I have switched to a solid state audio system (contained within the audio module) and eliminated two 6AL5 tubes, cutting several Amps of current drain off the filament line. This means a cooler-running set and better stability. You can see the solid state module in the photos. The calibrator will be converted next.

Fig. 4 shows a rundown of the filament conversion to 6.3 volts. Modify the modules first and check them out by applying power to the pins listed under "power in." Then turn your attention to the main chassis and bus the pins of each module together

using 16-gauge wire. This is about a two-evening job. You will then need a 6.3-volt, 5- to 6-Amp transformer, as the filaments draw about 4 Amps. It's not a job for everyone's tastes, but the flexibility may be worth it.

Now that you have done the conversion, a few improvements may be in order. The first thing you can do is change T1301, the output

transformer on the audio amplifier assembly. Get a small output transformer of 14k Ohms to 8 Ohms. A small universal output transformer will do if you select the right taps. Try to mount it in place of the old square transformer if you can, but, in all likelihood, you will have to mount it on its side or make a bracket or devise some other way to make it

fit. But, after it's installed, you will be able to drive a speaker to fair volume if you wish.

Another thing you will probably want to do is rewire the fuse holder and power switch on the front panel so that they control the ac power and not the filament line. Cut the leads on the power switch and splice them together. Then do the same with the fuse holder. This is so the dial lamps will continue to light. Run external wires between the fuse and power switch and the two unused connections on P-304/J201 connectors. Then run one side of your power transformer(s) to one connection, and one side of the ac cord to the other unused connection. In my unit, the pins used were 10 and 14. Oh yes, change the fuse to 1 Amp.

How well can you expect the receiver to work? It proved to be very sensitive over the tuning range. Selectivity was okay for SW but a little too broad for the crowded ham bands. Stability was quite good, and SSB stations tended to stay put for a while. In all, a successful conversion!

I will be happy to try to answer your letters, if you enclose an SASE. ■

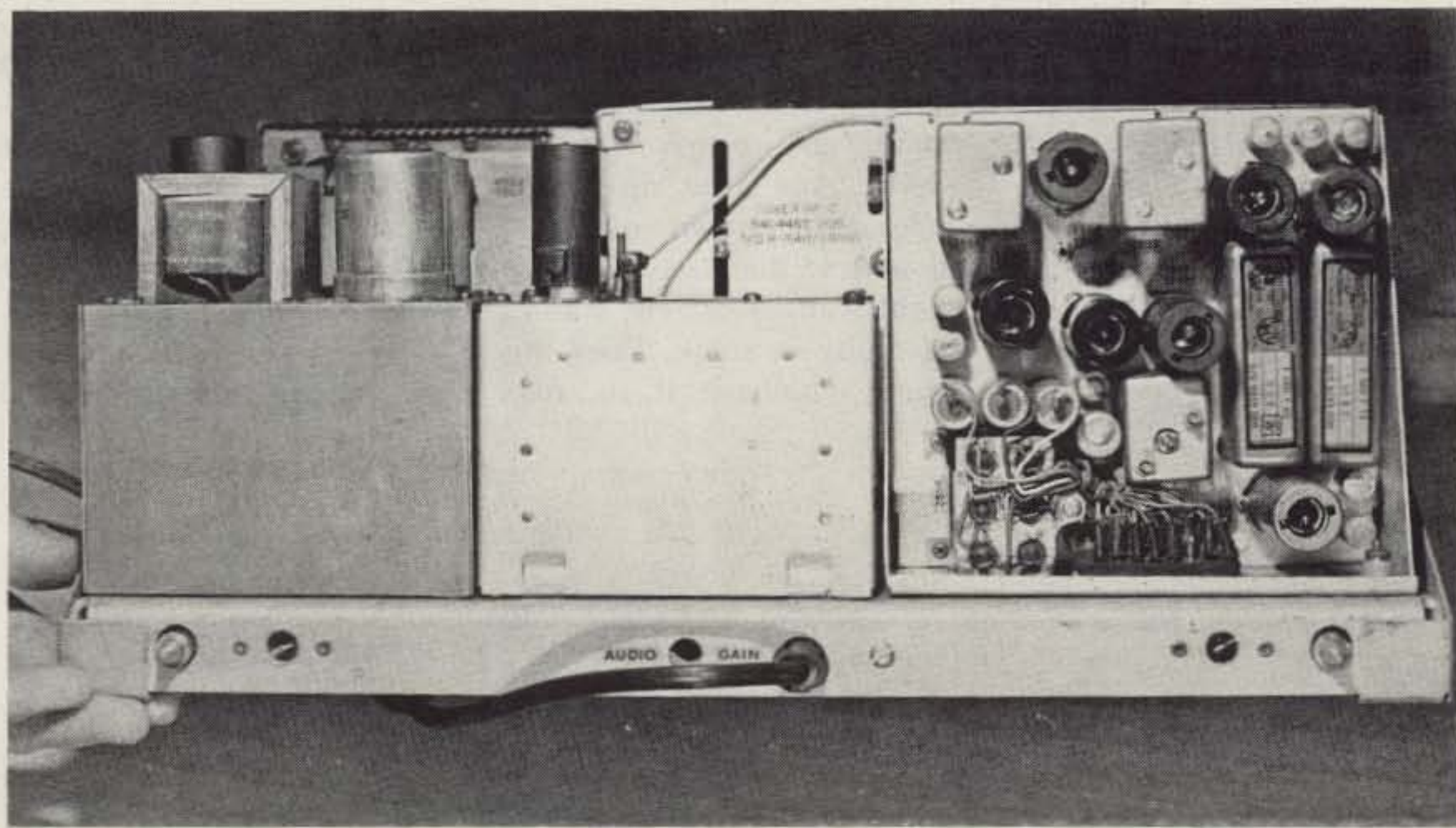

Rear view of receiver.

Pffft — Zapped Again!

— front-end protect your test equipment

There is some strange element that runs through my bones which upsets me terribly when my test equipment fails. Isn't it enough that some other problem has arisen to call for the test gear in the first place without finding that you have managed to vaporize the front end of that cherished frequency counter or prescaler (or worse still, that borrowed unit)?

I use a Heath IB-101 counter and its companion IB-102 prescaler and, although the input ratings of this equipment seem to be

more than adequate, I find myself invariably zapping the input gates, always at the most inopportune times. The project comes to a screeching halt because I have to fix the test equipment. Of course, as Murphy's Law comes into play, we find it to be Sunday, so everything is closed. Or the salesman says on the phone, "Yeah, come on out ... we've got plenty on the shelf." And after driving 15 miles across town, our hero discovers the salesman was slightly in error. He doesn't have any in stock. Does this sound familiar? If so, read

on...

After finding myself in this pickle a few times, the grey matter starts working: "Why do I let these things happen to me?" or "How did I manage to cremate that front end this time?" Usually the answers are very simple. The input voltage rating of the counter or prescaler was exceeded somehow, somehow. Once the smoke has cleared and the tears are dried, it no longer matters, because the project has come to a screeching halt.

Well, I gave this some serious thought and then pulled

the instruction books out (remember the old adage — when all else fails, read the instructions). The specs on the prescaler show that the input sensitivity is 50 mV from 2 through 100 MHz and 125 mV from 100 through 175 MHz with a maximum input of 3 volts rms (before smoke?).

A little conservative thinking is called for here. If I want to play it really safe, yet still have a sufficient signal into the prescaler or counter for easy operation, I figure a nice happy compromise would be an input of around 300 to 500 millivolts. That should be conservative enough for anyone's book. How, then, do I accomplish this?

I generally find that in using the prescaler or counter, I'm measuring the output frequency of either my Icom 22A on two meters, or the Collins S-Line on the low bands. There are two different power levels and two different frequency ranges, also.

In zapping the front end of the test equipment, my favorite method was to couple the dummy load by way of a clip lead to the input of the counter — very cheap, very dirty, and very dangerous, friends. A little Ohm's law quickly shows that the Icom with ten Watts out develops a smart 22 volts across that 50-Ohm dummy load, and the S-line cranking 100 Watts turns out a wallop of 70 volts across that same 50 Ohms. It's a small wonder that the input to the prescaler is smoking.

What was called for was some kind of voltage divider, but, in going back to Ohm's Law again, I discover that a voltage divider using resistors becomes cumbersome and somewhat expensive. Why not use capacitors?

I wanted to use commonly available units and not have to bother with any kind of variables which are expensive and difficult to mount, so I chose common, everyday,

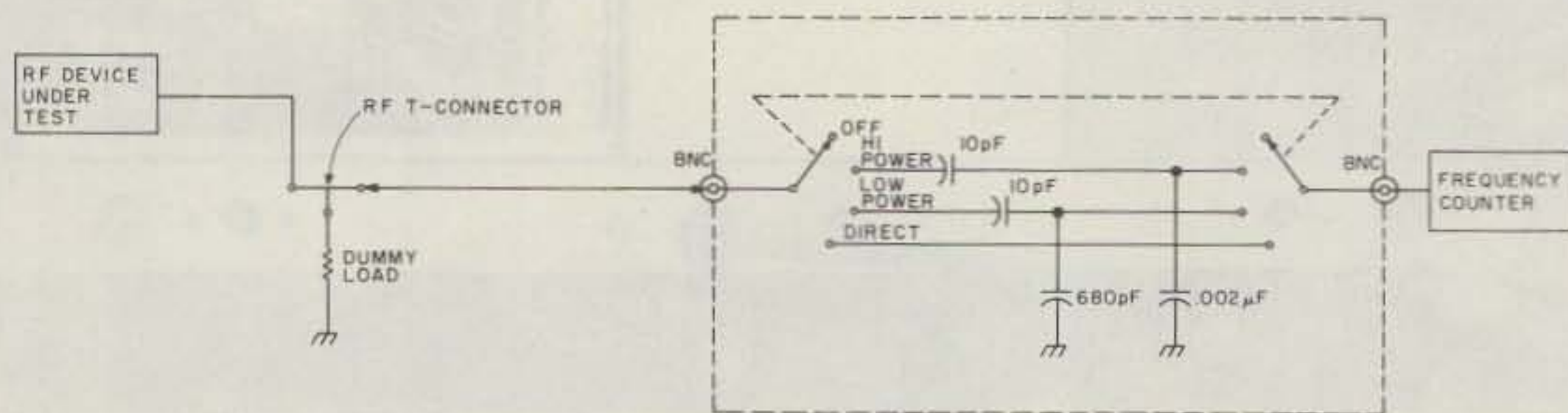

Fig. 1. All capacitors are 1000 volt disc ceramic units.

easily available disc ceramic units. Picking a number out of the air, the first value chosen was 10 pF. The books tell me that the voltage across an individual capacitor in a capacitive voltage divider is inversely proportional to its capacitance. Therefore, if I wanted 300 millivolts with 70 volts applied across the divider, the ratio was 70 divided by 0.3 or 233 to 1. If the first capacitor chosen is 10 pF, then the second capacitor must be 233 times bigger

or .002 mF, using commonly available items. For the second divider, using low power of 10 Watts, the same rules apply. 10 Watts is 22 volts across 50 Ohms. Therefore, still sticking to my first 10 pF value, the second capacitor in the low power divider must be 22 divided by 0.3, giving a ratio of 73 to 1. This means the capacitor value has to be 73 times 10 pF or 730 pF. The junk box gave up a 680 pF, which I called close enough for ranch work.

The complete unit is built into a small LMB box using a double-pole double-throw wafer switch. BNC connectors were added for convenience in cabling the unit up between the dummy load and the counter. I added an "off" and a "direct" position, as shown in the diagram. It works exactly the way it's supposed to work, and, since its conception, I have had no more failures with the counter or prescaler. It later occurred to me that the capaci-

tive reactance of two series capacitors across the dummy load could present, at 146 MHz, an swr problem. However, the calculator shows the impedance of the combination to present no more than a 1.44 to 1 swr. At frequencies below 30 MHz, it isn't worth worrying about. It does solve the problem of a convenient, safe, and conservative way of frequency measurement without the worry of test equipment failure. ■

DELAWARE AMATEUR SUPPLY

Factory authorized dealer for:

Amcomm, Ameco, Amphenol, ARRL, Astatic, Autek Research, B&W, Bencher, Bomar, Callbook, CDE, CushCraft, Dentron, Eico, Essex, Mosley, Hy-Gain, MFJ, Larsen, Midland, J.W. Miller, NPC, Nye Viking, Newtronics, Pipo, Radio Publications, Rohn, Phelps Dodge, Sams Books, Ten-Tec, Telex, Tempo, TRW, TPL, Wilson-Radios, Standard, Lunar, W2AU, W2VS, KDK, Russell. Trade-ins negotiated—used gear on consignment. Also in stock: Yaesu, Drake, ICOM, and Kenwood.

Store Hours

8am—6pm Monday thru Thursday

8am—7pm Friday

9am—5pm Saturday

Closed Sunday

We are 1/2 mile off I-95: From the Hot Shoppes on I-95 North take exit 5N, make first right onto Airport Road, continue on Airport Road 1/2 mile to Meadow Road turn right on Meadow Road and look for our sign.

We have the largest stock of amateur radio equipment and accessories in Delaware—there is no sales tax in Delaware—stop by and see us on your way through—special discounts for cash sales.

✓ D31



Paul WA3QPX
Rob WA3QLS

71 MEADOW ROAD
NEW CASTLE, DELAWARE 19720
(302) 325-7728

Build Your Own CW Keyboard Keyer



Save Over \$175

QSL for full details

ECM

ECM Corporation,
412 N. Weinbach Ave.,
Evansville, IN 47711
812-476-2121 ✓ E1

CIRCUIT BOARDS

- REPEATER CONTROL
- COMPUTER PROJECTS
- SENSITIZED BLANKS
- NEGATIVES/POSITIVES
- PROTO-TYPE BOARDS
- PARTS KIT
- CUSTOM ETCH/DRILL
- RCA 1802 MP BOARDS
- CIRCUIT BOARD DESIGN
- PROGRAMMING PADS
- ART MASTER PREPARATIONS

We can supply many of the items you need to make a p-c board. Send SASE + 25 cents for catalog.

O.C. Stafford ✓ S50

Electronic Service and Development
427 S. Benbow Rd.
Greensboro, NC 27401
919-274-9917 DAY/NITE
Serving Amateurs Around the World

Seze-Rose & Spencer Electronics ✓ S39

1465 WELLS STATION ROAD
MEMPHIS, TENN. 38108

PH (901) 683-9125—685-8461

Authorized Dealer

**DRAKE—ICOM—KENWOOD
REGENCY—TEMPO—DENTRON**

CALL OR WRITE
FOR BEST DEAL



TU-170 kit...\$149.95
wired...\$219.95

**RTTY
made
easy**

State of the art design features make the TU-170 ideal for HF and VHF autostart operation at an unchallenged price.

- SIZE: 7 1/4" W x 3 1/4" H x 7 1/2" D
- Proved 170Hz shift 3 stage active filter demodulator
- Lighted tuning meter for easy tuning
- Current regulated loop keyer and power supply
- Autostart with threshold control and solid state relay
- Stable audio frequency shift oscillator, produces phase coherent sine wave tones
- TTL compatible inputs and outputs for auxiliary equipment
- High level output for scope tuning

FLESHER CORP.

P.O. Box 976

Topeka, Kansas 66601

(913) 234-0198 ✓ F5

VISA



FLY YOUR RUBBER DUCKY !!

Get off the trunk lid and into the best location on the car... the center of the roof! Tests have proven that the low profile quarter-wave whip, or the rubber-ducky from a Handy-Talky, outperforms a 5/8 whip on the trunk. Take advantage of the super ground plane by converting to the FLYING-DUCKY magnetic mount. Although designed specifically for use with a H-T, it can be used with any mobile rig. Ten second installation.

FLYING-DUCKY magnetic mount consists of:

- Chrome-plated super magnet (holds 50 lbs.)
- Compatible coax plugs furnished to match rig requirements. Specify BNC, F type, PL259-SO239. For TNC Wilson type add \$3.
- Coax cable 105 in. long.

FLYING DUCKY MOUNT AND CABLE... \$13.95
QUARTER WAVE WHIP

(specify connector) \$ 5.95

RUBBER DUCKY to match

(specify connector) \$ 7.95

Pace-Traps
✓ P15

Box 234
Middlebury CT 06762
(203) 758-9228

One Meter—Many Jobs

—an introduction to shunts

While building a power supply, I ran into a problem that I'm sure others have encountered. It involved measuring the output voltage and current of my new power supply. I had only enough

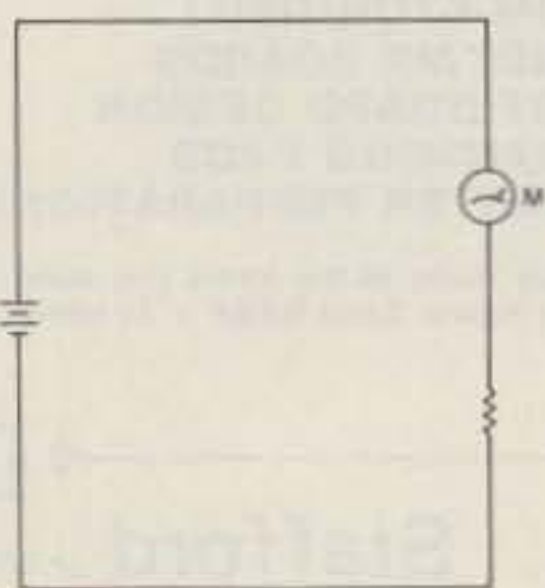

Fig. 1. A millimeter with a series resistor makes a voltmeter.

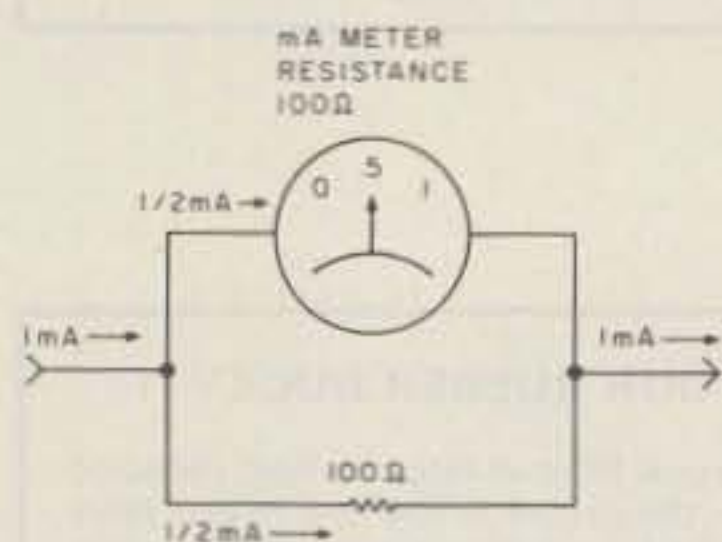

Fig. 2. Current will divide equally between the meter and its shunt.

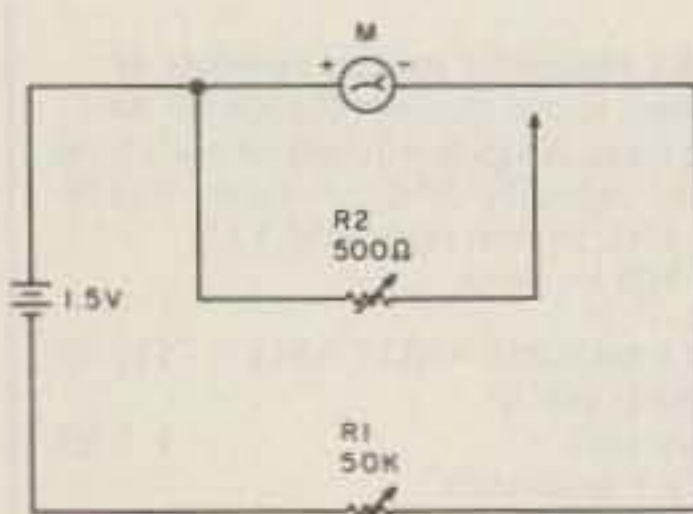

Fig. 3. This circuit can be used to determine the internal resistance of any meter.

room to mount one meter, and besides, I didn't want to pay the high price for two new meters. At today's prices, which run from \$7.00 to \$9.00 for a nice-looking meter, two meters can raise the cost of a power supply considerably. I'm sure I came up with the same solution others have, but, not having seen an article on it, I thought I would share my idea with you. My solution involves buying just one voltmeter (for the range intended) and converting it to also measure current. This not only saves space, but also money.

Theory

Basically, all dc meters used in radio applications are of the same general type, which is known as the moving coil meter or the D'Arsonval meter. This type of meter can be used as a dc ammeter, milliammeter, microammeter, voltmeter, and, with rectifiers, it can also measure alternating currents and voltages. The meter movement itself is actually a sensitive instrument, usually requiring currents of 1 mA or less for full-scale deflection. You will find that a voltmeter is nothing more than one of these sensitive meters with a current-limiting resistor in series with it (see Fig. 1). Say, for example, that a meter has a full-scale deflection sensitivity of 1 mA, and you want to make it into a voltmeter

with a range of 0-10 volts. You will need 1 mA of current flow (for full-scale reading) with 10 volts applied. If you connect the 10 volts directly to the meter, the only thing limiting the current is the internal resistance of the meter, which is usually less than 200 Ohms. If the 1 mA meter had 100 Ohms of resistance with 10 volts applied, the current through the meter would approach 100 mA. Needless to say, this would instantly destroy the meter. To get only 1 mA from 10 volts, you need a series or multiplier resistor to limit the current. From Ohm's Law, $R = E/I$, you get the value of this resistor, $R = 10/.001$, or 10,000 Ohms. With this resistor connected in series with the basic 0-1 mA meter, it has become a 0-10 V voltmeter.

If you want to use this same meter to measure current, it already does just that from 0-1 mA. If the coil of a 0-1 mA meter has 100 Ohms of resistance and a 100-Ohm resistor is connected across it (in shunt), half of any current flowing through this parallel circuit will pass through the resistor and half through the meter. (See Fig. 2.) In this case, if 1 mA is flowing in the circuit, 1/2 mA will flow through the shunt and 1/2 mA through the meter, giving 1/2-scale deflection of the meter needle. The meter will now read full scale when 2 mA flows in the

circuit. To make the meter read correctly, it would be necessary to replace the 0-1 mA scale with a 0-2 mA scale. To avoid all this work, you could, by using the correct value of shunt resistance, make the scale accurate for 0-10 mA, 0-100 mA, or even 0-1 Amp. This is the basis for this article, only I'll begin with a new voltmeter for the range intended.

Conversion Details

Let's say, for example, that you want to build a power supply with a meter that can measure 0-15 V, 0-150 mA, and 0-1.5 A. First you would buy a 0-15 V voltmeter, and that's half of the problem solved right there. Start by removing from the back of the meter the two screws that hold it together. Once the screws are out, take the movement out of the case. There will still be two wires connecting the case to the movement, and one will have a resistor in series with it. Unsolder this resistor, and replace it with a piece of wire. At this point, put the meter back together, being sure to keep this resistor because it will be used later. At this time, note the value of this resistor. For most 15 V voltmeters, it will be 15,000 Ohms, meaning that the meter takes 1 mA for full-scale deflection ($I = E/R = 15 \text{ V}/15,000 \text{ Ohms} = .001 \text{ A}$).

The following is not absolutely necessary, but I will show you how to determine the internal resistance of a meter and the values of shunt resistors for various current readings. Start by connecting the test circuit in Fig. 3 with both potentiometers set for maximum resistance. Decrease the value of R1 until the meter reading increases to full scale. Now connect R2, and adjust it for a half-scale reading on the meter. Next remove R2 without disturbing its setting, and measure its resistance with a ohmmeter. This value is the internal resistance of the meter; in my case, it was 150

Ohms. Now, if you desire to make this 1 mA meter read 150 mA full scale, the shunt will have to carry 149 mA and the meter 1 mA. Being in parallel, the meter and the shunt will have the same voltage across them. The current in any leg of a parallel circuit is inversely proportional to the resistance. Therefore, 1/149th of 150 Ohms will be required for the shunt, or 1.0067 Ohms. Now the meter's range of 0-15 has been expanded to read 0-150 mA; 15 on the meter equals 150 mA.

If the meter is to be used to measure 1.5 A, then the shunt must be 1/1499th of 150 Ohms, or .10006 Ohms. Now the 15 on the meter equals 1.5 A.

In reality, you can't just go out and buy 1.0067-Ohm and .10006-Ohm resistors. Here is an easy way I get around this. First, find an old ceramic wire-wound resistor with a value of 1-5 Ohms. If your junk box is like mine, you will have several (see Photo A). If not, maybe an amateur friend has one to spare. Take a hammer and chip the ceramic off a little at a time, being careful not to damage the wire. Once you have all the wire, clean it until it shines with sandpaper. Now connect it in the test circuit shown in Fig. 4. Here you will be calibrating your new ammeter to an accurate one, such as in your volt ohmmeter (VOM). Start with the smallest scale you want to calibrate — in the case of 150 mA or 1.5 A, it will be the 150 mA. Choose a battery and resistor combination that will give a close-to-center reading on the 150 mA scale.

Example: With a 1.5-volt battery, use a resistor of 20 Ohms, which will make the VOM read 75 mA. Now, with the VOM reading 75 mA, slide the jumper down the wire until your new meter reads 7.5 (75 mA) or whatever your VOM reads if you didn't use a 20-Ohm resistor. Cut the wire about a half inch beyond this point; this will be

the shunt for the 150 mA scale. You can use this shunt for the 1.5 A scale by tapping the correct amount of resistance from it. To do this, you would use the same procedure and wire as before, only change to a smaller load resistor. This will give more current to calibrate the larger scale of 1.5 A.

Example: Use the same test circuit as in Fig. 4, only change the load resistor to a 2-Watt, 5-Ohm resistor. The VOM will now read 300 mA, and you should slide the jumper down the 150 mA shunt wire until the new meter reads 3. Solder a wire at this point, and you will have two shunts in one. In my case, the total length of the shunt came to about a foot. You can either slide some insulation around the shunt wire or do like I did and make a plastic holder for it. Hopefully, if all went well up to this point, you have a dual shunt, the voltmeter resistor you removed, and a converted meter. All that's left to do now is to connect these according to Fig. 5. You can now measure voltage and two different ranges of current, just with a flip of a switch. ■

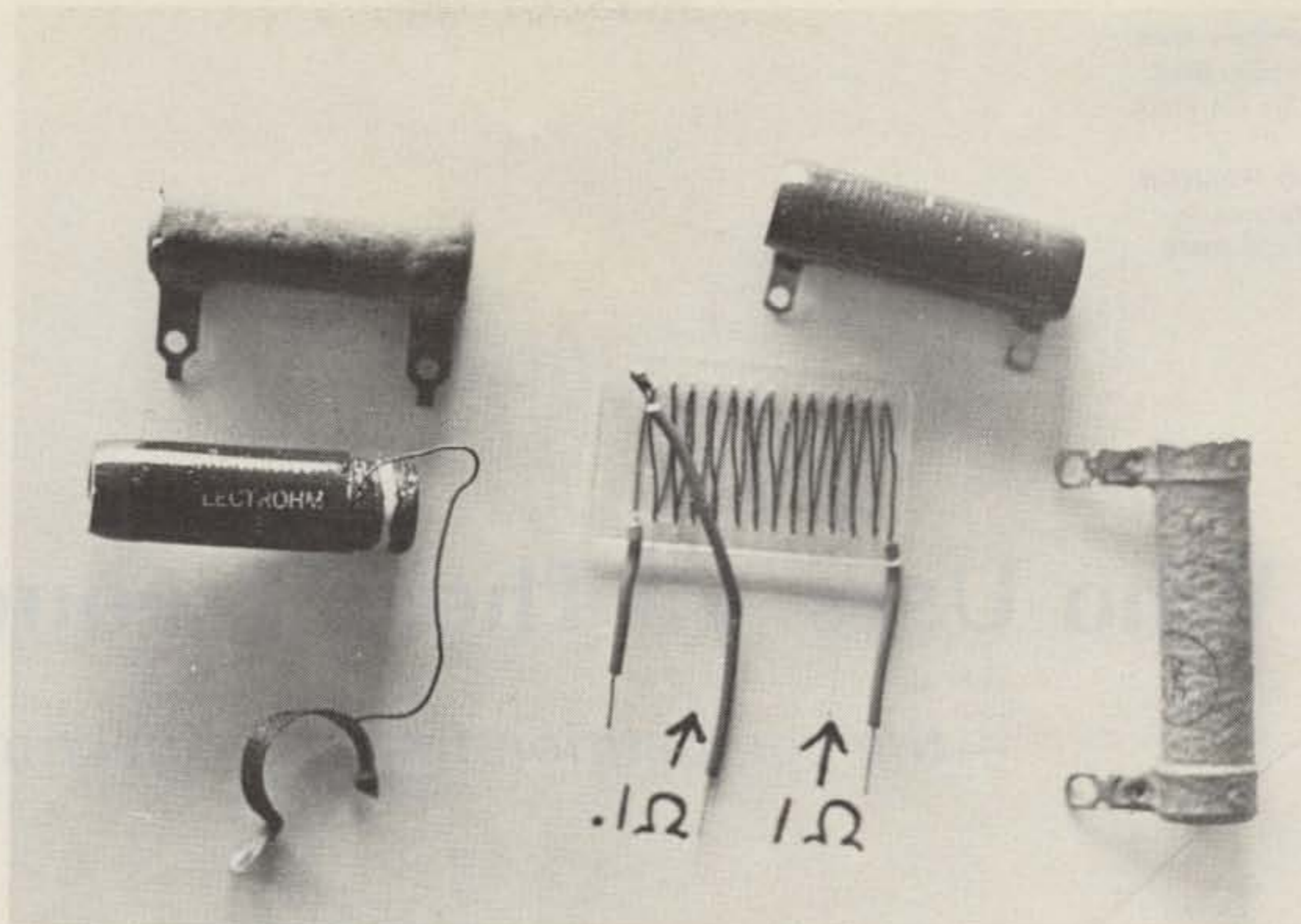

Photo A.

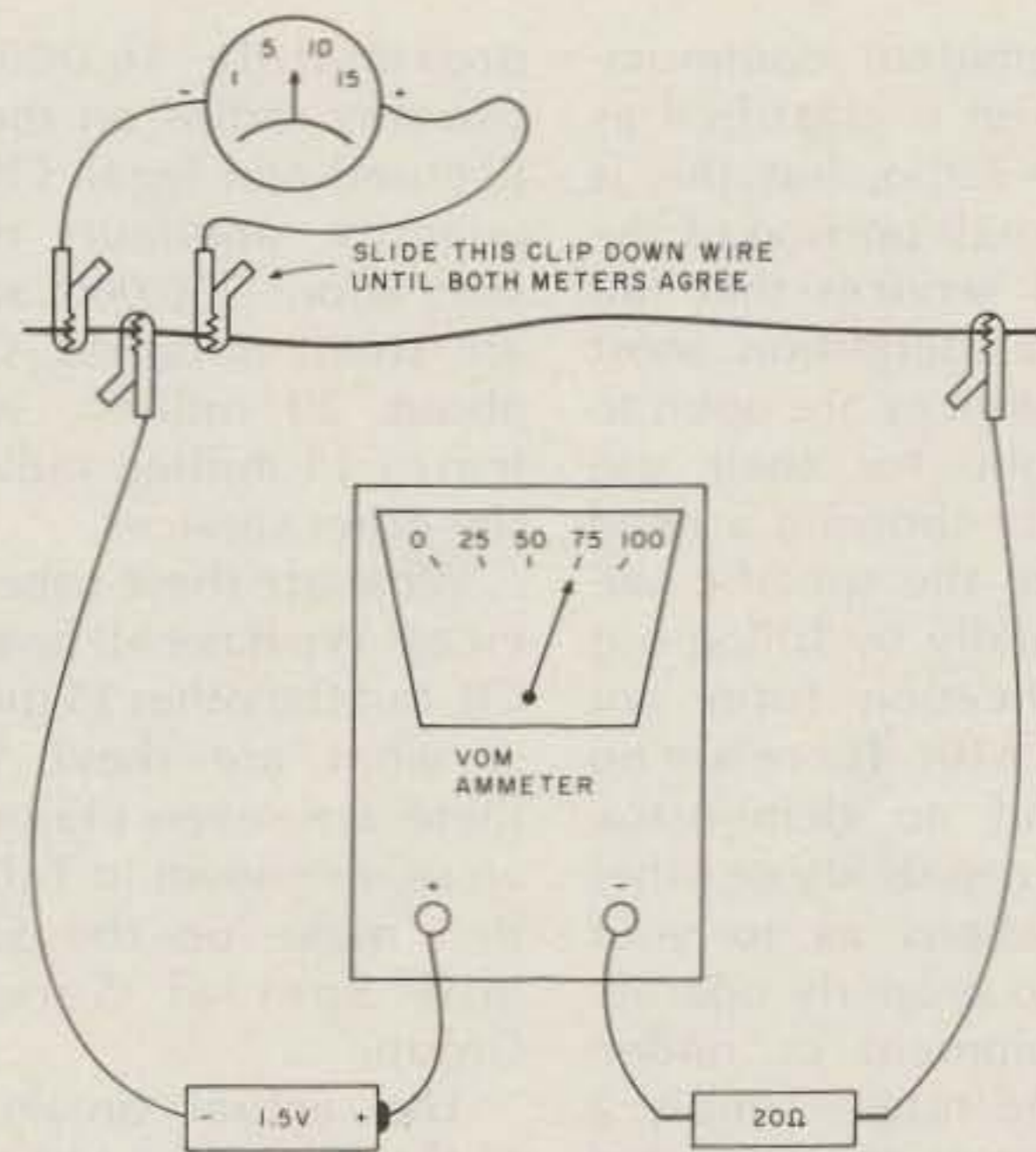

Fig. 4. The circuit used to make the shunts for ammeters.

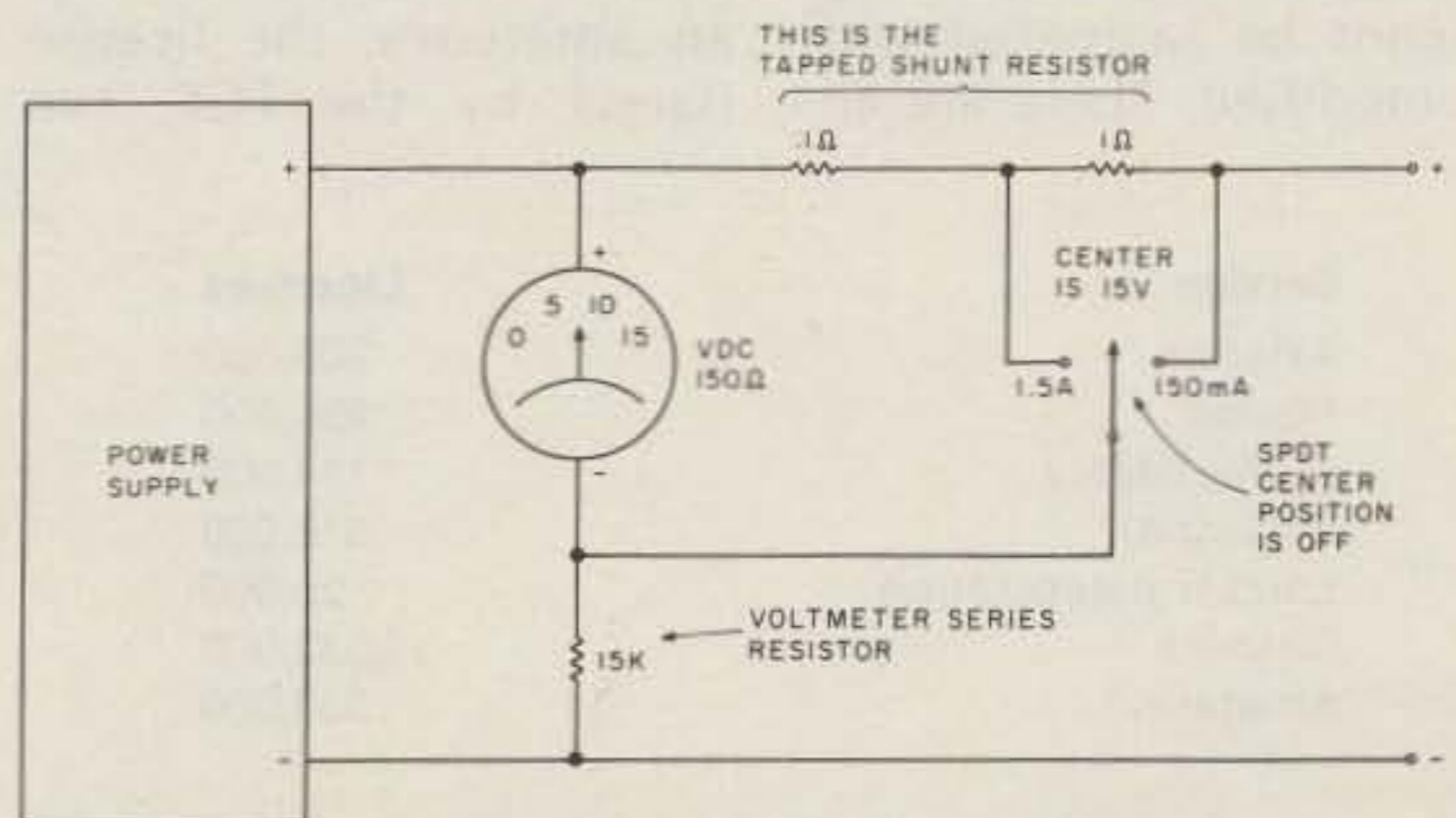

Fig. 5. The meter circuit schematic showing how to use one meter to measure voltage and two ranges of current.

Bob Thornburg WB6JPI
 13135 Ventura Blvd.
 Studio City CA 91604

Bill Brady WB6HDB
 14639 Maryton St.
 Norwalk CA 90650

Who Uses All Those Frequencies?

—the competition for radio spectrum

All amateur communication is classified as two-way radio, but this is only a small portion of the types of services that fall under this definition. Most of the services are open to the public for their use simply by showing a need to utilize the specific service (usually by filling out an application form not unlike a 610). There are no tests and no demonstrations of capability or other qualifications as to your ability to properly operate the equipment or understand the rules—simply a statement as to your need for the service. All of the equipment allowed is type-accepted by the FCC and cannot be tampered with or modified. There are ap-

proximately 36,000,000 two-way radios on the air, licensed and legal. Of this quantity, amateurs represent about 750,000, so we are small potatoes. CB is about 20 million, which leaves 15 million radios in the other services.

What are these other services? We have all heard of CB, but the other 15 million... what are they? Well, there are seven major services, as shown in Table 1, that make up the Safety and Special Services Group.

The actual breakdown of the 36 million radio sets is not easy to derive, but data is available on the licenses. Note that, as with an amateur's, the license issued by the FCC can

cover several radio sets and in some cases several hundred sets with a simple license. The actual number of radios per license depends upon the service and the use within the service.

The majority of the two-way services are used for people talking to people: airplane to tower, boat to boat, ship to shore, cement truck to dispatcher, taxicabs, police, tow trucks, fire trucks, ambulances, delivery trucks, AAA, convoys, security, etc. On VHF/UHF, repeaters are common; on HF, intercontinental traffic is common. CW is used on some marine and aeronautical bands.

The frequencies allocated to each of these services is difficult to tabulate, as many bands are shared, particularly between the Public Safety, Industrial, and Land Transportation services. Table 2 is a breakdown of allocated spectrum. Note that Aviation has the largest spectrum allocation, mainly due to their radar bands. Also note that Public Safety, Industrial, and Land Transportation have a large UHF allocation because they share the 470-512 MHz allocation with Broadcast (UHF TV channels 14 to 20).

As can be calculated, CB has the least spectrum

| Service | Licenses |
|---------------------|------------|
| Aviation | 206,000 |
| Marine | 296,000 |
| Public Safety | 114,000 |
| Industrial | 318,000 |
| Land Transportation | 25,000 |
| Citizens | 10,532,000 |
| Amateur | 339,000 |

Table 1. Safety and Special Services. Source: "Two-Way Radio Station Count," Communications News, August, 1977.

| Service | Below | | | |
|---------------------|--------|-------|---------|--------|
| | 10 GHz | 1 GHz | 100 MHz | 10 MHz |
| Aviation | 913 | 43 | 15.1 | 5.5 |
| Marine | 203.8 | 7 | 5.2 | 2.7 |
| Public Safety | 87.9 | 79.9 | 9.3 | 1.1 |
| Industrial | 79.1 | 71.1 | 7.51 | 1.31 |
| Land Transportation | 68.6 | 60.6 | 2.37 | -0- |
| Citizens | .98 | .98 | .58 | -0- |
| Amateur | 756 | 46.45 | 7.45 | 1.0 |

Table 2. Breakdown of spectrum. Source: Vol. II, Part 2, Frequency Allocations and Radio Treaty Matters; General Rules and Regulations; FCC Rules and Regulations, Sept., 1972, edition through Transmittal Sheet 9.

(below 10,000 MHz) per license and Aviation the most. Below 1,000 MHz, Land Transportation has the most, but below 10 MHz, Aviation once again has more.

CB and Amateur are familiar to you, but what are the others? Aviation and Marine are obvious; they have to do with the communications relating to these fields, but what are the other three services?

Public Safety includes police, fire, local government, highway maintenance, forestry conservation, special emergency, state Guard, and fixed public safety services. Of the 114,000 licenses, 35,000 are police and 26,000 are local government.

Industrial services include business, power, petroleum, manufacturers, forest products, special industrial, industrial radio

location, motion picture, relay press, telephone maintenance, and fixed industrial services. Of the 318,000 licenses, 212,000 are business.

Land Transportation services include railroad, taxicab, automobile emergency, buses, trucks, and fixed transportation services. Of the 25,000 licenses, 9,000 are railroads and 4,000 are taxicabs.

CB is the fastest growing service, having doubled

several times in the last few years. The principal utilization of CB and the primary reason for this growth is due to the effectiveness of mobile communication for the traveler. It would appear to me that the crowding and necessary expansion of spectrum for this service should come from the Land Transportation service, in contrast to the publicly discussed encroachment on the amateur bands. ■

Key Electronics



Full ASCII Professional Keyboard Kit, Model 756



● Full 128 Character ASCII ● Tri-Mode MOS Encoding ● MOS/DTL/TTL Compatible Output ● Two-Key Rollover ● Level and Pulse Strobe ● Shift and Alpha Lock ● Selectable Parity ● Positive or Negative Logic ● All New, OEM Grade Components ● Gold Contact, Low Bounce Key Switches ● Rugged G-10 Printed Circuit Board ● Low Power Consumption ... and More

Model 756 Keyboard Kit \$64.95
 Model 701 Plastic Enclosure \$14.95
 Model 702 Steel Enclosure \$29.95

Send for catalogue of other NEW merchandise, Semis, Sockets, ICs, Res., Caps, and MORE.

N.Y.S. Residents Add 4% Sales Tax

Send to: Key Electronics
 P.O. Box 3506
 Schenectady, NY 12303

✓ K14

DISCOUNT SCANNERS

The Touch.™



\$255.00

Prepaid USA



CHECK, M.O., MASTERCHARGE, VISA

BAY-COM ✓ B32

196 FRONT STREET
 SCITUATE MA 02066
 617-545-9700

Other Regency models at similar savings—send for list

...Mass. residents please add 5% tax...

Trans Com ✓ T35

Tone Signaling Equipment

Featuring the TG-1B Sub-Audible Tone Encoder
 Compatible with P.L., CG and other systems

Features:

- Low sine wave distortion of less than 1.5% THD
- Plug in tone element
- Excellent Temperature & frequency stability
- Low current draw using CMOS IC's
- Immunity to RF
- Two year warranty



Priced at \$27.95 wired and tested with tone element

Also Available

Touch tone encoders from \$29.95, touch tone decoders and two tone sequential tone encoders and decoders.

Order from or for further information contact

Trans Com

P.O. Box 120, Addison, Illinois 60101 312-653-6724

FOR THE HAM

A BELT BUCKLE

From The COLORADO SILVER CO



APPROX. SIZE 2 1/2 x 3 1/2 INCHES
 CAST IN SOLID BRONZE
 ENGRAVED WITH CARE

This buckle can be yours for only \$12.50, plus \$1.00 for postage.

COLORADO SILVER CO., DEPT. H
 P.O. BOX 1755, ASPEN, CO. 81611
 COLO. RES. ADD 3%



✓ C63

FAST SCAN ATV

ALL YOU NEED IN ONE BOX



Show the shack, home movies, computer games, etc. Connect to the ant. terminals of any TV set, add a good 450 antenna, a camera, and you are there ...

- 10 Watts peak RF output. Specify 434.0 or 439.25 MHz
- Subcarrier sound with plenty of mic gain for distance pick-up.
- 8 MHz bandwidth, high resolution necessary for computer alphanumeric and color.
- Tunable converter covers 420 to 450. (Covers CH 2, 3)
- Contains AC to 12VDC regulated 3 AMP power supply.
- Only \$399.00 direct mail. Check, Money Order, VISA. Send S.A.S.E. for catalog of ATV Modules and PC Boards.

P.C. ELECTRONICS

Maryann WB6YSS 2522 PAXSON ARCADIA, CA 91006 Tom W6ORG

COAKIT ✓ C21

RF ASSORTMENT



CONNECTOR ASSORTMENT

\$25.00 Postpaid \$23.50 each lots of three

Includes: 5- PL259, 5- SO239, 5- UG175, 5- UG176, 2- PL258, 1- DM, 1- M358, 2- M359, 1- UG255, 1- UG273, 2- PL259PO, 1- 1021-20, 1- Lightning Arrestor.

Master Charge & Visa accepted / Send for Free Catalog

COAKIT ✓ C21

P.O. Box 101-A Dumont, N. J. 07628

Circle C21 on Reader Service Card

MDS: What Is It?

—and what's in it for you

James Edwards
c/o 73 Magazine

If you've been to a large hotel or motel recently, there's a good chance that, for a few dollars, you had the option of seeing a current movie on your room television set. Although some places have been providing this entertainment via in-house video tape players, most are now receiving signals from a central location using the Multipoint Distribution Service (MDS).

First authorized by the FCC in July of 1970, MDS stations offer a low-cost common carrier service. MDS stations actually transmit over the air the movies and other programs to hotels and apartment complexes. (Beginning to sound interesting?)

Technical Details

MDS stations transmit a standard television signal in an omnidirectional pattern on one of two channels in the band from 2150 to 2162 MHz. "Two gigahertz—that's S-band microwave! I thought that was only good for point-to-

point with big dishes, big signals, etc." Well, there's no rule that says microwave has to be in one direction. In fact, MDS usually has a 360° omnidirectional transmit antenna located on one of the highest buildings in town. (Next time you're checking out your repeater's antenna, watch for a strange antenna that looks like a piece of sewer pipe with a funnel on top of it. If it has a cable running to it, it's probably the MDS transmit antenna.) The antennas are usually 10-dB gain jobs with 10 Watts running into them. That gives a 100-Watt erp radiated signal. In some cases, the FCC may authorize 100 Watts into the antenna for a 1000-Watt erp signal.

Receive stations are 2-foot or 4-foot dish antennas with a down-converter mounted on the back. A two-foot dish has about 20 dB gain at 2 GHz, so reliable range is about a 20-mile radius from the transmitter. The converter changes the MDS signal to an unused TV channel and feeds it into the hotel or apartment television distribution system.

Programs

Strictly speaking, an

MDS facility is a common carrier and has no control or interest in program content. A program syndicator contracts with the MDS owner and the hotels and apartment complexes to provide recent theater movies. These are uncut movies, with no commercials (sometimes "X" or "R" rated). Blacked-out or special sporting events and rock concerts are sometimes broadcast.

One movie per night with a matinee on the weekend is the usual schedule. Movies are repeated on varying nights, so you can expect about 10-15 new shows per month. During the daytime, the system is sometimes used by large multi-branch organizations (banks, schools, etc.) that want to distribute training and sales programs to a number of locations in a metropolitan area. City government and police departments are also daytime users in some areas.

"Star Wars" in Your Living Room?

If your city has an MDS system (check with one of the larger motels) and you can "see" the transmitting antenna, you can probably

receive the movies in your home. The signal is a standard NTSC color picture transmitted "inverted"—that is, the picture carrier is above the sound carrier. The picture carrier (for MDS "Channel One") is 2154.75 MHz. High-side injection will re-invert the signal for reception on an unused channel on your set. A simple diode mixer (like a UHF tuner) followed by a low-noise preamp is effective in many cases. Dish antennas are rather expensive, but a UHF TV dish can be converted to receive the higher frequencies. Mounting the converter at the dish and feeding power to it reduces feedline losses to almost zero.

Business Opportunity

You could use the information presented here to provide first-run movies in your home. However, you might want to investigate MDS from a business standpoint. The Multipoint Distribution Service is somewhat of a "monopoly" in a given area and an FCC license could prove very valuable. If your city doesn't have an MDS system, check out the FCC Rules, subpart K, paragraph 21.900. ■



IC-215 FM

PORTABLE/MOBILE

- 15 channels (12 on dial/3 priority)
- Fully collapsible antenna or "rubber duck"
- Compatible mount for mobile operation
- Dual power (3 watts high/400mw low)
- External power and antenna easily accessible for mobile operation
- Lighted dial and meter
- Double-size, long-lasting internal batteries with optional Ni-Cd pack and charger available

ICOM's **IC-215** is the FM radio that puts good times on the go. Now an outstanding mobile mount and quick-change features for external power, speaker and antenna conversions make moving from base, to vehicle, to hill top fast and easy: and the **IC-215 portable/mobile** provides continuous contact for even the busiest FM enthusiast.

The **IC-215's** three narrow filters provide quality not usually found in portable VHF equipment. With 15 channel capacity and an MOS FET RF amp with 5 tuned circuits in the front end, the **IC-215** gives optimum FM portable performance.

You'll be carrying quality, performance and versatility with your **IC-215 FM portable/mobile**.

Specifications: Frequency Range: 146-148 MHz Voltage: 13.8 VDC negative ground Size: 183mm(h) x 61mm(w) x 162mm(d)
 Weight: 1.9 kg Number of Channels: 15 total, 12 on main switch, 3 priority Power Output: 3.0 W or 0.5 W Microphone Impedance: 600 ohms Spurious Level: lower than -60 dB Receiver Sensitivity: 4 dB below 1 UV or lower Spurious Response: 60 dB or better

All ICOM radios significantly exceed FCC specifications limiting spurious emissions.

✓11

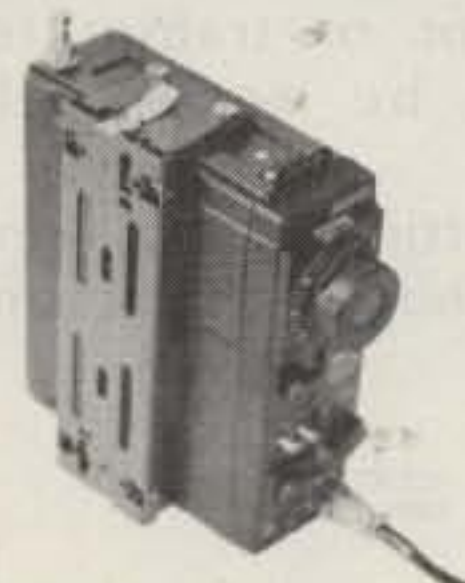

This new mobile mount is now available for your **IC-215**. Fast insertion and removal is a snap, and the mount is collapsible when not in use.

HF/VHF/UHF AMATEUR AND MARINE COMMUNICATION EQUIPMENT

DISTRIBUTED BY:



ICOM

ICOM WEST, INC.
 Suite 3
 13256 Northrup Way
 Bellevue, Wash. 98005
 (206) 747-9020

ICOM EAST, INC.
 Suite 307
 3331 Towerwood Drive
 Dallas, Texas 75234
 (214) 620-2780

ICOM CANADA
 7087 Victoria Drive
 Vancouver B.C. V5P 3Y9
 Canada
 (604) 321-1833

FM Calibration on a Budget

— why pay more?

James C. Chapel W9HDA
2349 Wiggins Avenue
Springfield IL 62704

With the strong trend to FM equipment on the VHF and UHF bands, the need for FM signal generators has grown in recent months. FM transmitter deviation (similar to AM modulation) must be set high enough so that the audio has some punch, but not set so high that the receiver on the other end cannot even detect the audio. The correct alignment of FM receivers is also critical—especially the detector stage. Thus, the deviation of a signal generator or transmitter should be accurately known.

This article covers a simple method of calibrating

or checking the calibration of FM signal generators, whether the generator is home brew, such as in this author's article in the January, 1978, issue of 73, purchased as war surplus, or obtained from the commercial market. It will also show how to directly check the deviation of an existing FM transmitter. The easiest way, if you have the cash, is to hire someone to calibrate your generator or transmitter or even buy a commercial unit already calibrated. If you do not have the cash or would rather put the money into the rig instead of calibration services, this article is for you.

Basics

This calibration method is based on the characteris-

tics of FM signals with various levels of deviation (modulation) applied. Unlike AM, FM has several (and can have dozens of) sidebands removed at fixed intervals from the carrier frequency. If an FM signal consisted of a single 1000 Hz audio frequency modulating the carrier, there would be sidebands at 1000 Hz on each side of the carrier frequency. Sidebands would also occur at 2,000, 3,000, 4,000, and 5,000 Hz, and even higher on both sides of the carrier, depending upon the deviation level. The magnitude of these sidebands and the carrier varies in a definite relationship with the magnitude of the audio signal. In other words, the carrier and all the sideband amplitudes vary as the deviation is increased or decreased. Most important is the fact that the carrier magnitude actually goes to zero at certain levels of deviation. By making use of this last fact, a crystal filter, and a mathematical concept called Bessel Functions, it is possible to accurately measure the amount of level of deviation of a signal.

Bessel Functions are very complex multi-dimen-

sional functions which, when graphed, look like a series of ocean waves rolling onto the beach. The important thing is that the functions define the sideband, carrier, audio frequency, and deviation relationships. Using these mathematical functions, it has been determined that with a single 1,000 Hz audio signal, the carrier goes to zero at about a deviation of 2.4 kHz. The carrier also goes to zero again at about 5.5 kHz as the audio level is further increased. Fig. 1 shows a carrier with sidebands each spaced 1 kHz (the audio frequency) away from the carrier or adjacent sideband. Similarly, Fig. 2 shows the sidebands and missing carrier at null. Since the point at which the carrier disappears is accurately known by mathematical relationships, it is easy to accurately determine the deviation calibration points.

In order to tell when the carrier has disappeared, it is necessary to use a frequency selective device which allows only the carrier frequency to pass, and eliminates the several sidebands. A single-crystal filter cut to the same frequency as the carrier fre-

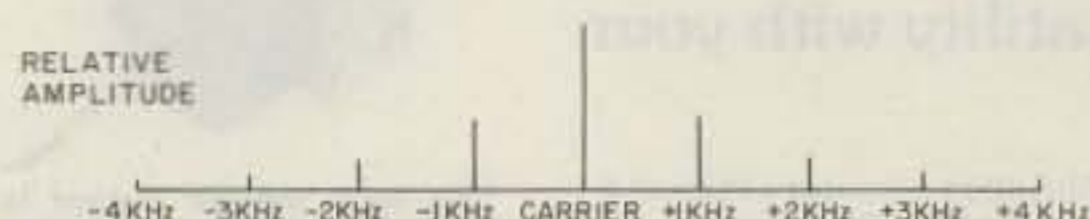

Fig. 1. Carrier and sidebands for 1 kHz single-tone modulation (not at carrier null).

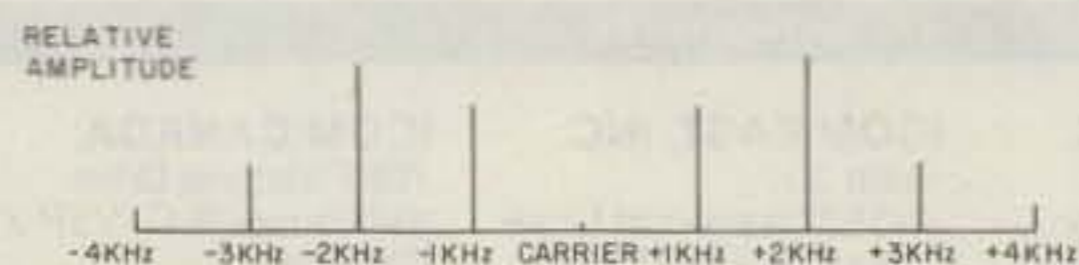

Fig. 2. Carrier and sidebands for 1 kHz single-tone modulation of carrier null.

quency appears in the receiver will accomplish the job. When the signal goes to null or approaches zero, the deviation level at that point is known.

Equipment

In order to accurately measure the deviation, a good receiver, a scope or ac VTVM, and the crystal filter are required. The FM generator under test is applied to the antenna input or i-f input at the proper frequency. The scope or meter is connected to the output of the filter. Fig. 3 shows the crystal filter circuit for a 455 kHz receiver i-f. The filter is connected to the last limiter stage before the detector. In the case of the popular quadrature detector, this must be the pin that is the input to the actual detector portion of the IC. In the case of an older transistorized receiver, it should be the output of the last transistor limiter stage.

Procedure

Allow all equipment to warm up for several minutes—especially if any is of vacuum-tube vintage. Apply the carrier only to the receiver input and tune the generator until a reading is observed on the filter output. Adjust the generator frequency so that the output is maximum and is, therefore, centered on the crystal filter frequency. Apply a 1,000 Hz audio signal by slowly increasing the deviation control on the generator. The crystal filter output should suddenly drop to near zero. This is the first null and, for a 1,000 Hz audio signal, represents a 2.4 kHz deviation. Continuing to increase the deviation will result in a second drop or null, not as sharp or pronounced. This, the second null, represents a 5.5 kHz deviation. A third null occurs at 8.7 kHz. This is

the range required for most ham radio equipment today. Two tables are provided to make it easy to calculate any of the three nulls, based on either a fixed known audio frequency or the frequency required to produce a desired deviation (Table 1 and Table 2 respectively).

Examples of Calibration

1. Using the author's home brew FM generator

In order to calibrate this generator, the output must be applied to the 455 kHz i-f strip of a receiver. The crystal filter is then connected to the last limiter stage and the scope to the filter output. The output frequency of the generator is adjusted so that it is exactly centered in the crystal filter. Since the audio frequency of this generator is about 1,000 Hz, Table 1 shows that nulls will occur at 2.4, 5.5, and 8.7 kHz. The deviation level is slowly advanced until each null is observed, and the position of the deviation control is so marked. Once these points have been determined, intermediate points can be estimated.

2. Using a military-type generator (such as the SG-3)

The output of the SG-3 FM generator is applied to the input of a 2-meter receiver. Filter and scope are connected as described earlier. The generator, with no deviation applied, is tuned until output from

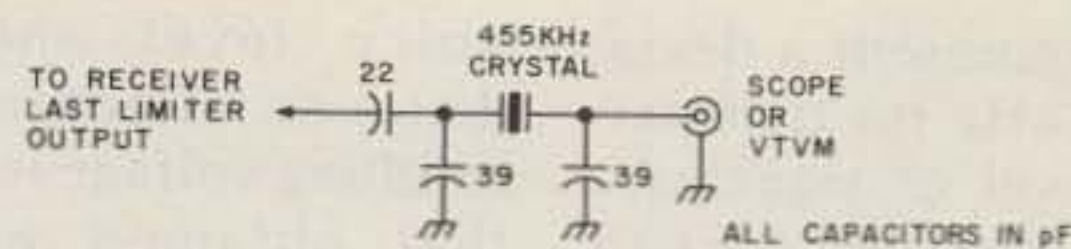

Fig. 3. Crystal filter used to detect carrier null.

the filter is obtained. This adjustment will be very critical, especially on a selective receiver, since the tuning has to be better than 1 kHz. An external audio generator is applied to the signal generator and the switch set to the external audio position. The frequency is set to 2,080 Hz, which provides a 5 kHz deviation on the first null. Increase the deviation until the null is observed. The deviation calibration pot can then be adjusted if required. Other points such as 10 and 15 kHz can be checked by the selection of 4,160 and 6,240 Hz frequencies, respectively, from Table 2. Internal signal generator frequencies could be used, but will result in values which are harder to work with, as shown by Table 1.

3. Using method for FM transmitter calibration

The same approach can be applied to an actual FM transmitter, with it being considered the "FM signal generator." A means of loosely coupling the trans-

mitter to the receiver is required—usually through a dummy load on the transmitter and a whip antenna on the receiver. The receiver, with the crystal filter attached, is tuned to the transmitter frequency, or if the transmitter is variable, it can be adjusted to the receiver frequency. Again, carefully center the transmitter in the receiver bandpass and, thus, the crystal filter window. Apply a known audio frequency to the microphone input of the transmitter. If the audio generator is frequency-adjustable, pick a frequency for a desired deviation, such as 5 kHz, from Table 2. In this case, the audio frequency should be 2080 Hz for the first null indication. Remember that most transmitter audio amplifiers have limited bandpass, usually about 300 to 3,000 Hz. The audio frequency chosen must be in that range.

Increase the applied audio frequency level until the desired null is observed. In the example given,

| Null | Deviation (kHz) for known audio frequency |
|--------|---|
| First | 2.4 × frequency (kHz) |
| Second | 5.5 × frequency (kHz) |
| Third | 8.7 × frequency (kHz) |

Table 1. Determination of deviation based on known audio frequency.

| Deviation | Signal generator audio frequency to produce stated deviation at null shown | | |
|-----------|--|-------------|------------|
| | First Null | Second Null | Third Null |
| 1 kHz | 416 | 181 | 116 |
| 2 kHz | 838 | 362 | 232 |
| 3 kHz | 1248 | 543 | 348 |
| 4 kHz | 1676 | 724 | 464 |
| 5 kHz | 2080 | 906 | 579 |
| 6 kHz | 2496 | 1086 | 696 |
| 7 kHz | 2912 | 1267 | 812 |
| 8 kHz | 3352 | 1448 | 928 |
| 9 kHz | 3744 | 1629 | 1044 |
| 10 kHz | 4160 | 1810 | 1160 |
| 15 kHz | 6240 | 2715 | 1740 |

Table 2. Determination of frequency to produce desired deviation.

this will represent a deviation of 5 kHz for that particular level of signal applied. To relate this back to the usual microphone input, measure the voltage level at the second or third audio stage (after the level or deviation control) with the fixed audio frequency applied at null. Next replace the audio generator with the regular microphone and give a long "ahhh" at your usual

voice level and mike distance. Compare this resulting voltage level with that obtained with the audio generator input. Adjustment of the deviation and/or audio control may be necessary to make the mike output produce the same output level. Alternate the audio generator input at null compared with the mike input until both outputs result in the same level as measured on

a scope or VTVM. The transmitter will then be adjusted to produce a deviation of 5 kHz (or whatever is desired) for normal conversation.

Conclusions

The accuracy of this method is far better than that required for most amateur work. The stability and setting of the signal generator are critical since the crystal filter has a

sharp cutoff on either side of the resonant frequency. Usually it is easier to work with the first or, at the highest, the second null, since these are much more pronounced. With this simple test procedure, it is readily possible to calibrate FM signal generators or FM transmitters so that the deviation is accurately known instead of only guessed at or adjusted by ear. ■

DOVETRON



MPC-1000C

Multipath Correction
In-Band Diversity &
AFSK Tone Keyer

Amateur Net: \$545.00

Standard features include CONTINUOUSLY tuneable Mark and Space channels (1000 Hz to 3200 Hz), Dual Mode (MARK or FSK) Autostart and internal high level neutral loop keyer (20 to 60 ml). Both EIA and MIL FSK outputs are provided for direct interface to microprocessor and video terminal peripherals.



MPC-1000CR

Signal Regeneration &
Speed Conversion

Amateur Net: \$645.00

A front panel switch permits internal TSR-200 Signal Regenerator-Speed converter assembly to electronically "gear-shift" between 60, 67, 75 and 100 WPM. All incoming and outgoing signals are regenerated to less than 0.5% bias distortion. Also available with DIGITAL Autostart (TSR-200D): Amateur Net: \$695.00



MPC-1000R/- TSR-500

Dual UART Regeneration,
Speed Conversion, 200
Char. Memory, Word Cor-
rection & DIGITAL
Autostart

Amateur Net: \$895.00*

The MPC-1000R/TSR-500 provides Preloading and Recirculation of the 200 character FIFO Memory, a keyboard-controlled Word Correction circuit, Variable Character Rate, Tee Dee Inhibit, Blank/LTRS Diddle, a Triple Tone-Pair AFSK Tone Keyer and a Character Recognition/Speed Determination DIGITAL (DAS-100) Autostart mode.

*The MPC-1000R is also available without a TSR assembly and functions as a MPC-1000C with a Triple Tone-Pair AFSK Tone Keyer. This "Basic-R" permits future expansion with a TSR-100, TSR-200, TSR-200D or TSR-500 by simply lifting the lid and plugging in the appropriate TSR assembly: Amateur Net (Basic-R): \$595.00

Your QSL will bring complete specifications, or call: 213-682-3705.

✓ D23

DOVETRON

627 FREMONT AVENUE
(P. O. BOX 267)
SOUTH PASADENA, CA. 91030

REGULATED POWER SUPPLY

- Fully regulated, dual protected, 13.8 volts
- Illuminated on/off switch
- Hammertone metal case

33 Amp (30 Amp continuous) .. \$119.95

20 Amp (16 amp. cont.) \$74.95

8 Amp (6 amp. cont.) \$39.95

TIMES CABLE

RG-8U - 100' multiples 18c/ft.

RG-213U - (Non-contaminating jacket)

-100' multiples 22c/ft.

1/2" Aluminum Jacketed hardline - 75 ohm.

1000' rolls only 29c/ft.

PL259 connectors 25/50c ea.

or 100/45c ea. POSTPAID

UNIVERSAL TOWERS

SUPER DISCOUNTS —

S.A.S.E. for brochure and prices!

Send S.A.S.E. for additional information. Include shipping charges with check or money order. (Ohio residents add 4 1/2% sales tax.)

JRS ELECTRONICS ✓ JB

P.O. Box 1893—Cincinnati, Ohio 45201

PCP™ TYPE-A PATENT PENDING

PCP TYPE-A TRANSFER FILM lifts the ink DIRECTLY from printed page!
(NO CHEMICALS or PHOTOGRAPHY required!)

Only additional materials required are: Sensitized boards, developer, & etchant!

SEE POPULAR ELECTRONICS FEB '78 ISSUE!

FINALLY you can make HIGH QUALITY printed circuit boards directly from magazine construction articles! Can also be used to make specialized meter faces, front panel decals, component placement decals & others.

Small Pkg. 6 pcs 4x6 \$5.49

Med. Pkg. 4 pcs 6x9 \$6.95

Large Pkg. 3 pcs 9x12 \$7.95

PCP

PRINTED CIRCUIT PRODUCTS CO.
P.O. BOX 4034

✓ P26 HELENA, MT 59601

FT-7 MOBILE/BASE HF TRANSCEIVER



Model FT-7 (20W PEP)

The all-solid state FT-7 transceiver provides high performance on the 80M-10M bands. Operating on upper or lower sideband and CW, the compact package provides many features engineered for convenience while mobile. A single knob provides all transceiver tuning, and the state-of-the-art noise blanker minimizes impulse-type noise found in mobile applications. The FT-7 is designed for operation directly from your car's 12 volt battery or from its matching DC Power Supply.

- Single knob tune-up eliminates fumbling around panel searching for load and plate controls
- Extremely compact size for installation under dashboard
- 100 KHz calibrator is built in
- Semi-break-in with sidetone
- MOS FET receiver front end
- Receiver offset tuning
- Provision for crystal-controlled operation
- Choice of frequency control between internal VFO, fixed channel, or external VFO
- Power consumption 3A transmit, 0.4A receive (13.5VDC)

NEW . . . FT-202R HAND HELD

Tops for emergency work, tower and antenna adjustments, the Yaesu FT-202R is what you have been asking for! Small (67 x 49 x 171 mm) and lightweight (only 400g, less batteries), it has full 6 channel capability (3 supplied, 3 optional) wrapped in a tough impact-resistant ABS case. Complete with flexible helical whip antenna, S/power meter, squelch and tone burst, it's the affordable Handie you have been waiting for! At your dealer's now, ask for the Yaesu FT-202R—"THE HANDIE".



✓Y1

Price And Specifications Subject To
Change Without Notice Or Obligation

YAESU
The radio.

YAESU ELECTRONICS CORP., 15954 Downey Ave., Paramount, CA 90723 ● (213) 633-4007
YAESU ELECTRONICS Eastern Service Ctr., 9812 Princeton-Glendale Rd., Cincinnati, OH 45246

ARMA
amateur radio manufacturers' association

Build the \$80 Wonder

—a deluxe frequency counter/standard

Now that integrated circuit technology has advanced to the point that the construction of a reliable and easy-to-use frequency counter and standard is within the means and budget of most experimenters, I decided to join the crowd and build my own. A review of the amateur literature showed several promising circuits, but most had features that I didn't want or lacked those qualities which I found desirable. However, segments of various circuits were easily modified

to meet the following specifications:

- HF range: up to 10 MHz (7 digits) without timebase switching
- UHF range: up to approximately 500 MHz
- Resolution: ± 1 Hz up to 10 MHz; ± 100 Hz with UHF prescaler
- Sensitivity: 100 mV rms up to 1 MHz; 200 mV rms up to 500 MHz
- Accuracy: better than 5 ppm at 1 MHz
- Frequency standard: switch selectable outputs of 30 kHz (for 2m FM), 10 kHz, 5 kHz, and 1 kHz

- Power: 120 V ac and 12 V dc (for use in automobile)
- Cost: about \$80

The Overall Design

As shown in the block diagram of Fig. 1, the overall design of the counter and standard is pretty much typical of the majority of the present day units. The input signal is fed first either to a UHF prescaler (10-500 MHz) or to an input amplifier (up to 10 MHz) which shapes the signal into a train of rectangular pulses. This in

turn is fed to the count gate controlled by the timebase. Prior to enabling the count gate, the display counters are reset to zero. At the end of a 1-second period, the LED display is frozen and the cycle is again repeated.

Timebase

Without the funds or the ambition to use a crystal oven, I used a standard TTL crystal-controlled oscillator as the heart of the timebase (Fig. 2). This 6 MHz source is a free-running astable multivibrator made up of two NAND gates, U1A and U1B. The 470 Ω resistors bias the gates as a linear amplifier so that the oscillator is self-starting. U1C buffers the oscillator's output from the loading effects of the stages that follow. The trimmer capacitor is used to zero the oscillator against WWVB or WWVH.

The remainder of the timebase consists of cascaded binary counters to divide the 6 MHz oscillator frequency down to 10 Hz, while at the same time providing selectable 30 kHz, 10 kHz, 5 kHz, and 1 kHz outputs for the frequency standard.

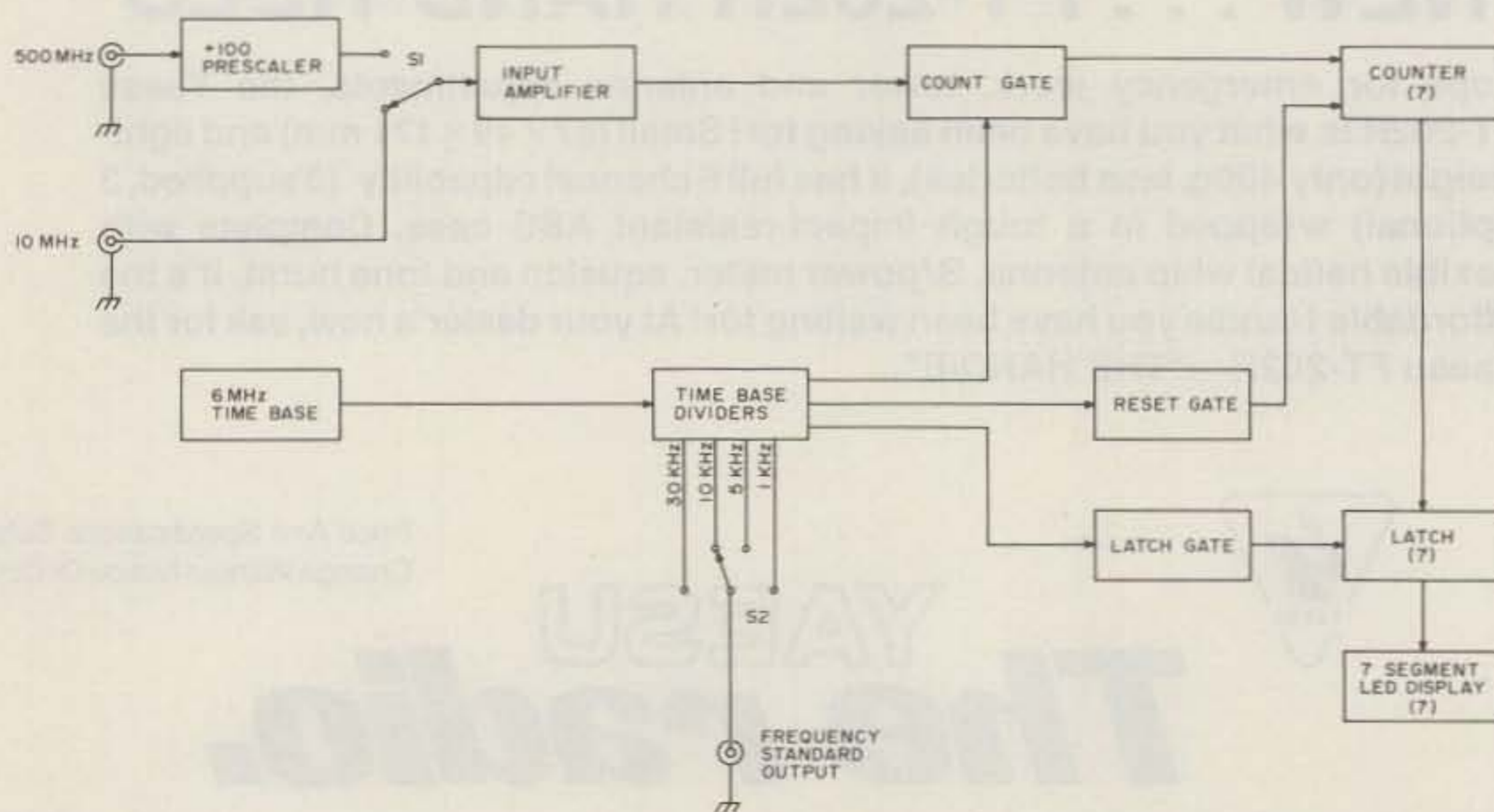

Fig. 1. Overall block diagram.

Count/Reset/Latch Gate

The basics for the gating circuit shown in Fig. 3 were described by K1PLP and WA6GVC in the 5th part of their *QST* article.¹ U9 divides the 10 Hz input from the timebase by 12 (in BCD) to control the count gate (U10B), the reset gate (U11B), and the latch gate (U12A).

As illustrated in the timing diagram of Fig. 4, the reset gate (pin 8, U11B) first goes high, then the count gate (pin 4, U10B) is enabled for 1.0 second, allowing the unknown input frequency from the input amplifier to pass through. Finally, the latch gate (pin 8, U12A) is disabled to freeze the display until the next cycle is completed. In the original circuit,¹ the 74LS series of TTL integrated circuits was used. However, to keep the cost down, I used the standard 74 series, finding no difference in the circuit's performance.

Counters/Latch/Display

The counter, latch, and display circuit shown in Fig. 5 is a standard design. There is a 7490 decade (BCD) counter, a 7475 latch (4 bit), a 7447 decoder/driver, and a MAN-7 common anode LED display for each of the seven digits. The inputs to the circuit are from points C, D, and E of the gating circuit of Fig. 3.

To reduce cost and space, I used a 47Ω ½-Watt resistor for the current-limiting resistor for each LED display instead of the more conventional practice of using a 220Ω resistor for each segment (a total of 7 for each display). In some cases, not all of the segments will have exactly the same brightness, but I found this to be hardly noticeable. In addition, the displays are wired so that the leading zeros are blanked, resulting in an

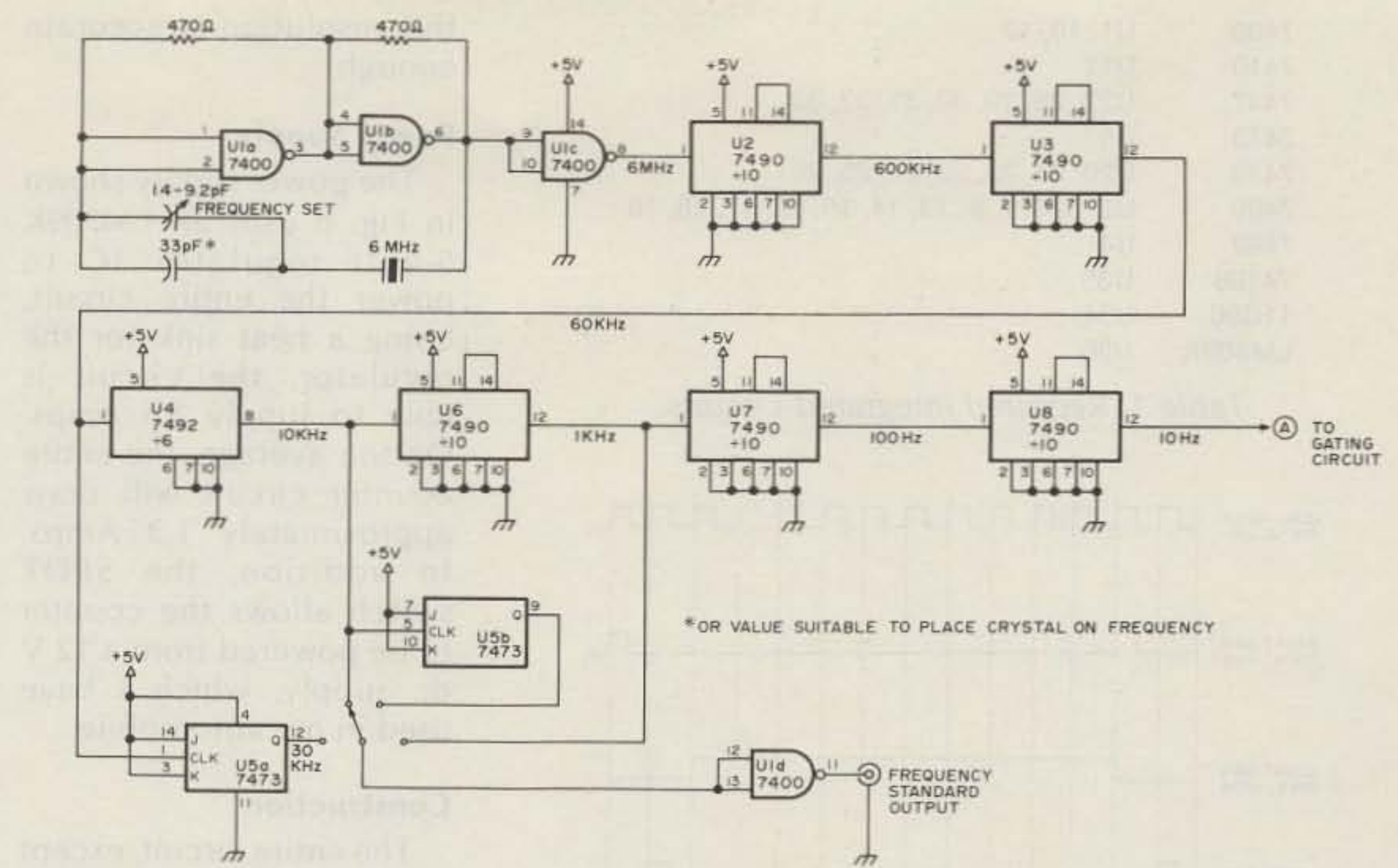

Fig. 2. Crystal-controlled timebase/frequency standard.

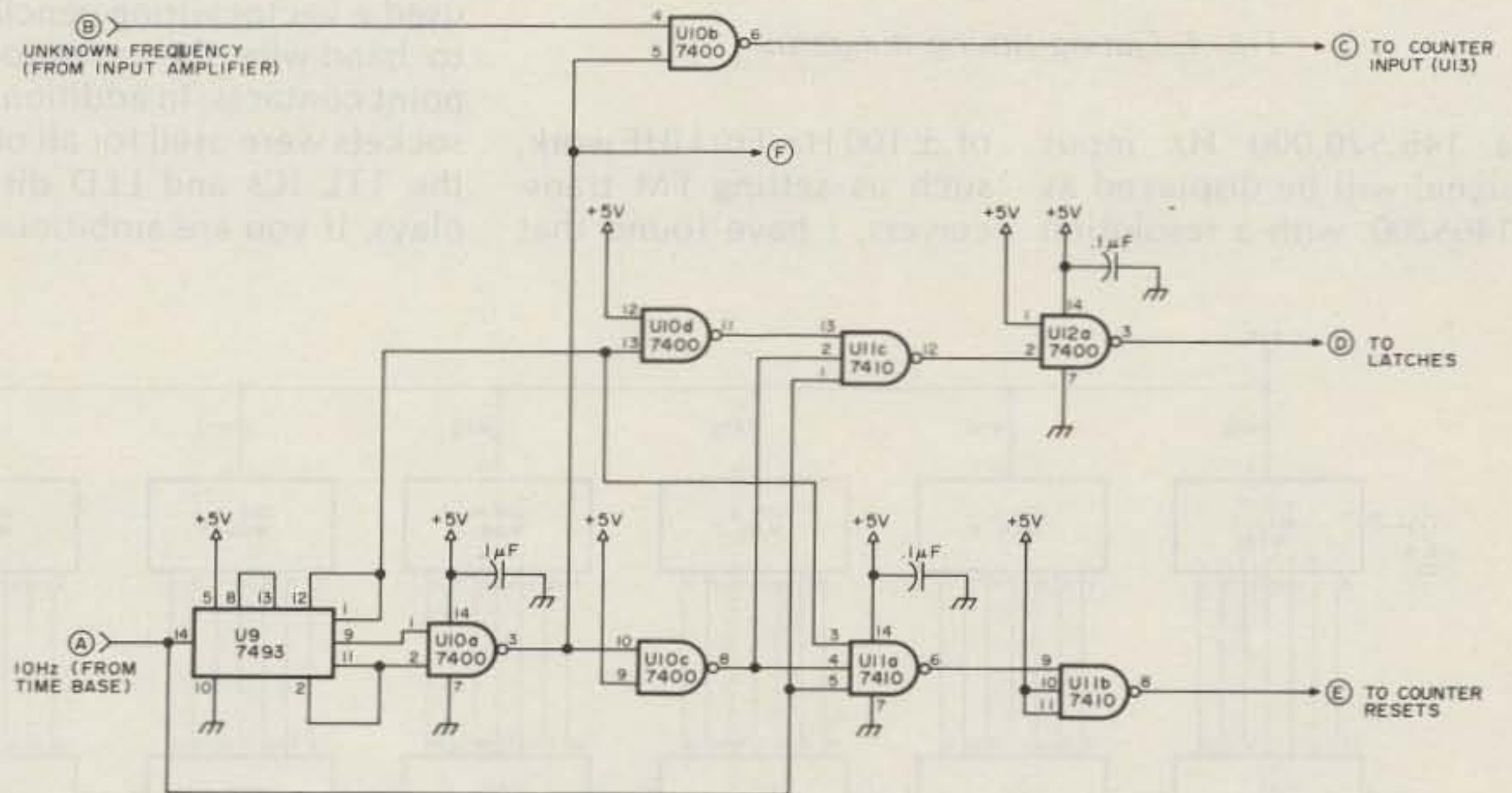

Fig. 3. The gating circuit.

easier-to-read display.

Input Amplifier

Several designs were originally tried, but they either lacked sensitivity or didn't work quite right, assuming that I wired them correctly. I finally used the input amplifier shown in Fig. 6, which is somewhat similar to the one used by Radio Shack in their counter.

The input is capacitance coupled to the N-channel FET (Q1), which provides an input impedance of ap-

proximately 1 megohm. The 2 kΩ potentiometer is the input sensitivity adjustment. In addition, the input to Q1 is protected from overload by the two 1N914 diodes connected back to back. After some amplification, the signal is "squared up" by the two NAND gates connected as a Schmitt trigger. The resulting TTL level output is then connected to point B in Fig. 3 (pin 4, U10B).

UHF Prescaler

The UHF prescaler sec-

tion (Fig. 7) is a straightforward design described by K2OAW.² It uses a Fairchild 11C90 ECL UHF decade counter having a guaranteed toggle frequency of 520 MHz. The input frequency to be scaled is coupled to the CP input of the device through a diode protection network, similar to that used for the input amplifier of Fig. 6.

A 74196 high-speed decade counter then divides the output signal of the 11C90, giving a total division of 100. Consequently,

short leads and a solid ground system is a must. Consequently, a printed circuit board is required to minimize capacitance effects at UHF. In K2OAW's article, an etched and drilled board is available for \$7 from Star-Kits, G.P.O. Box 545, Staten Island NY 10314. In my unit, the prescaler board is mounted inside the enclosure without any additional shielding. For the 11C90 IC, you should not use a socket; however, it is okay for the 74196 IC. The entire circuit was mounted in an LMB cabinet whose style matched perfectly with my Collins S-line. BNC-type jacks were used for the input and output connections and were connected to the circuit boards by RG174 coaxial cable.

There is no off/on light, but as shown in Fig. 5, the left-hand decimal point of the most significant digit (DIS 7) is connected to point F (pin 5, U10B). Consequently, the decimal point blinks every time the count gate is enabled in addition to serving as a crude off/on light.

Operation

Operation of the counter and frequency standard is simple. Just turn the unit on and feed the signal to either the Normal (up to 10 MHz) or the Prescale input and set the input switch for the desired range. For on-the-air frequency measurements, I connected a short collapsible antenna to a BNC male plug.

After calibrating the counter's timebase against WWV, I had the unit checked out at a local calibration laboratory. When the unit was first turned on, the error of the timebase was 0.2 ppm. After running for 4 hours, the error was 0.7 ppm, although at times the error

was as great as 1.5 ppm, as compared with a system whose accuracy is 1 part in 10^9 . The input sensitivity at 1 MHz was measured with a programmable millivolt source, giving a best reading of 98 mV rms after adjustment of the 2 k Ω potentiometer. Although the counter reads directly down to 1 Hz for frequencies up to 10 MHz, the counter was able to measure a 21 MHz transmitted signal, but with the loss of the most significant digit (i.e., "2"). For the UHF prescaler, it was capable of measuring frequencies as high as 560 MHz. However, care must be taken to not overload the prescaler's input. It was possible to read a 1 W 2m FM signal from a distance of about 15 feet.

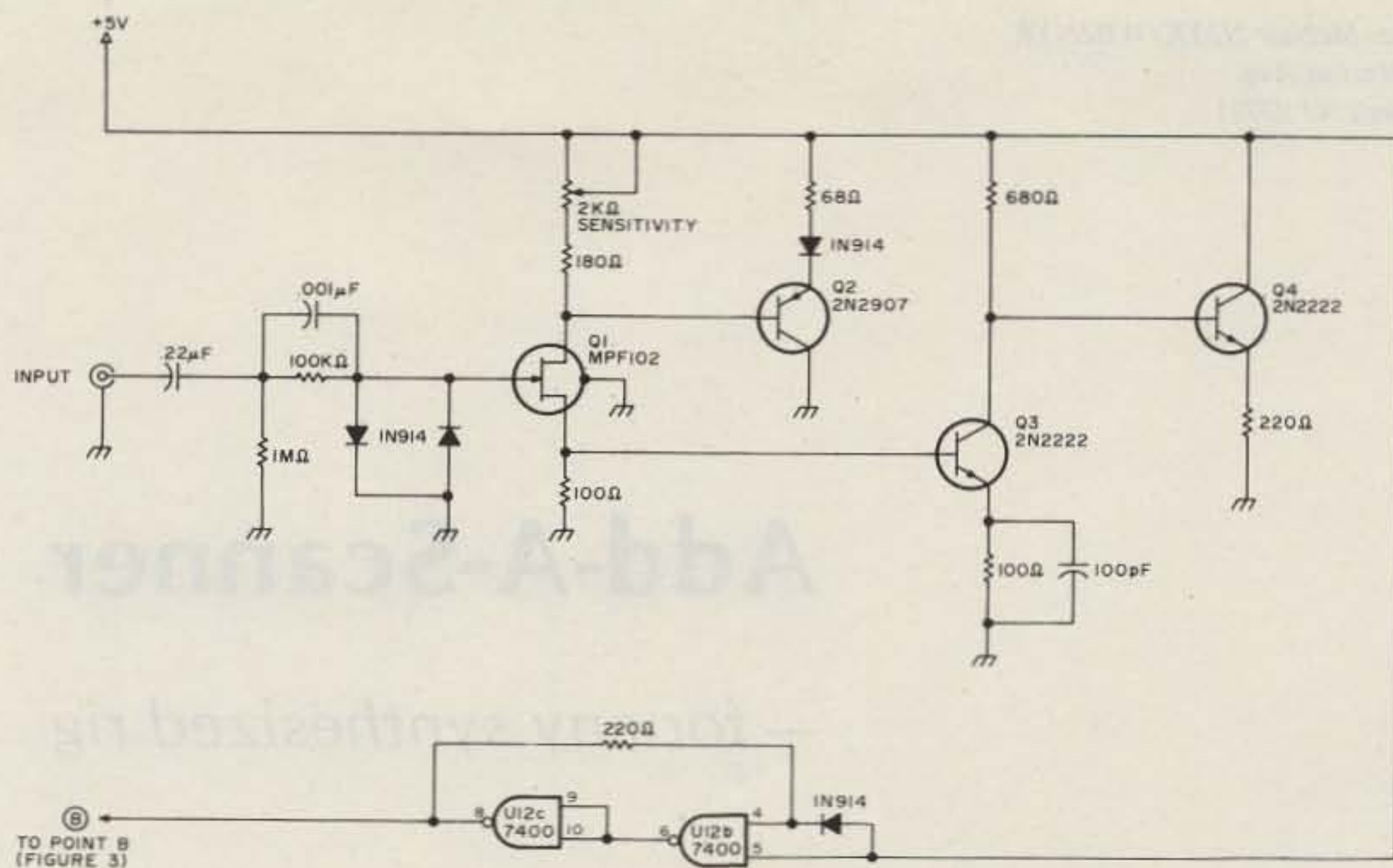

Fig. 6. Input amplifier.

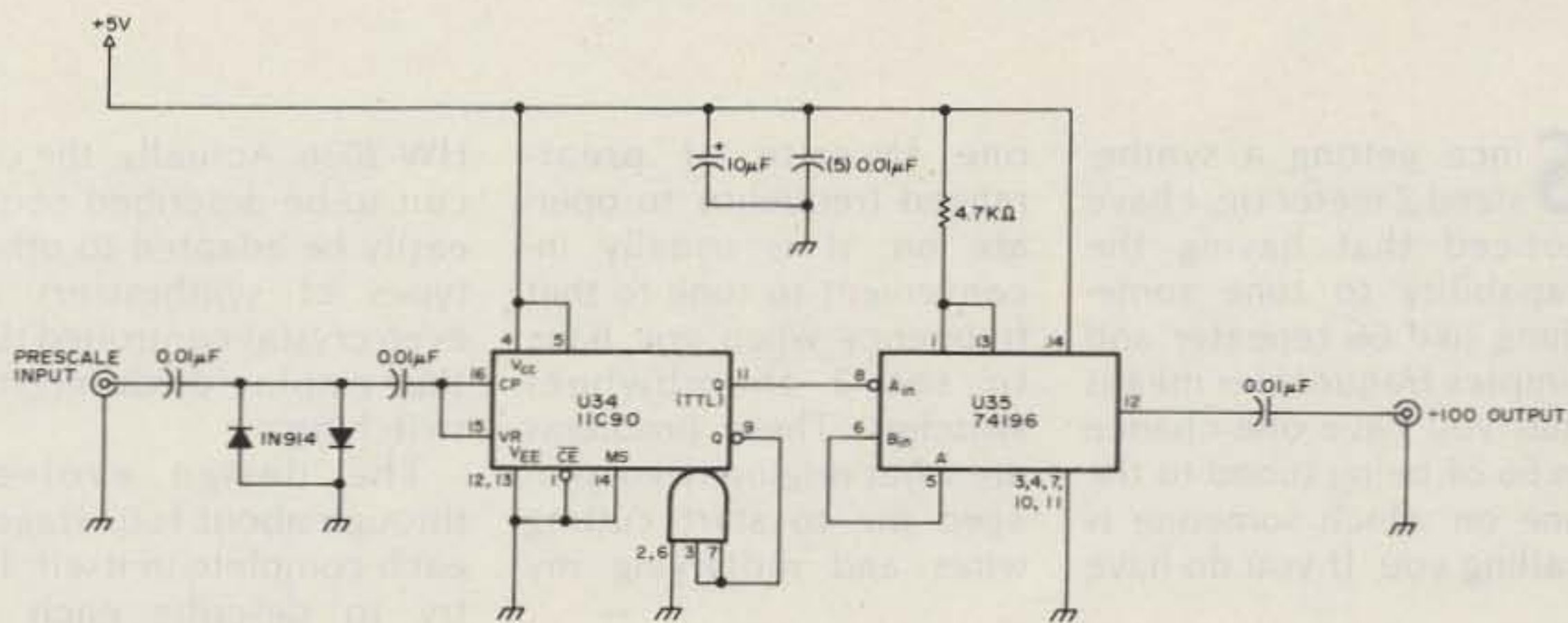

Fig. 7. UHF prescaler.

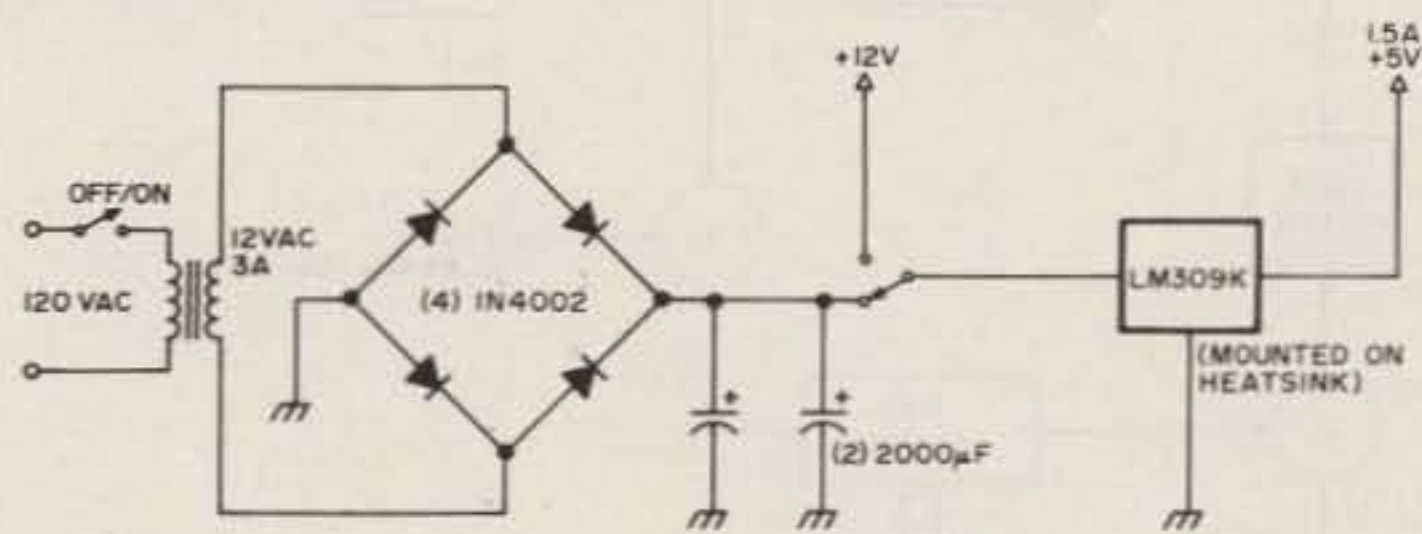

Fig. 8. Power supply for 120 V ac or 12 V dc operation.

As a first attempt to build a frequency counter and standard from scratch, I am very pleased with its performance, not to mention its cost. Using readily-available parts and the commercially-available printed circuit board described, I was able to build the entire unit for \$80, which should be within the budget of those desiring such a piece of

equipment. With careful shopping and the use of a homemade cabinet, it is possible to build it for even less. ■

References

1. J. Hall K1PLP, and C. Watts WA6GVC, "Learning to Work with Integrated Circuits," Part 5, *QST*, May, 1976, p. 17.
2. P. Stark K2OAW, "500 MHz Scaler," *73*, October, 1976, p. 62.

Add-A-Scanner

— for any synthesized rig

Since getting a synthesized 2 meter rig, I have noticed that having the capability to tune something like 66 repeater and simplex frequencies means that you have one chance in 66 of being tuned to the one on which someone is calling you. If you do have

one favorite or prearranged frequency to operate on, it is usually inconvenient to tune to that frequency when you have to set 3 thumbwheel switches. These problems are what originally encouraged me to start cutting wires and modifying my

HW-2036. Actually, the circuit to be described could easily be adapted to other types of synthesizers or even crystal-controlled rigs that employ diode crystal switching.

The design evolved through about four stages, each complete in itself. I'll try to describe each in enough detail so that you can stop at whatever point satisfies your requirements.

Trade-offs

What I really needed was a scanning circuit for my synthesizer which would alternately tune the frequency indicated on the front panel switches and at least one predetermined frequency. Following are a

number of alternatives for each portion of the design. The first shown is the one selected in each case.

1. Scanning

- a. Automatic — would scan when there is no activity and halt on the first busy channel. This approach requires only 2 (cheap) ICs and a handful of discrete components.
 - b. Manual — requires only an SPDT front-panel switch. Allows rapid frequency change between 2 channels.
- ### 2. Number of scanned channels
- a. 2 — front panel, plus one set internally. With more than two, it might be difficult

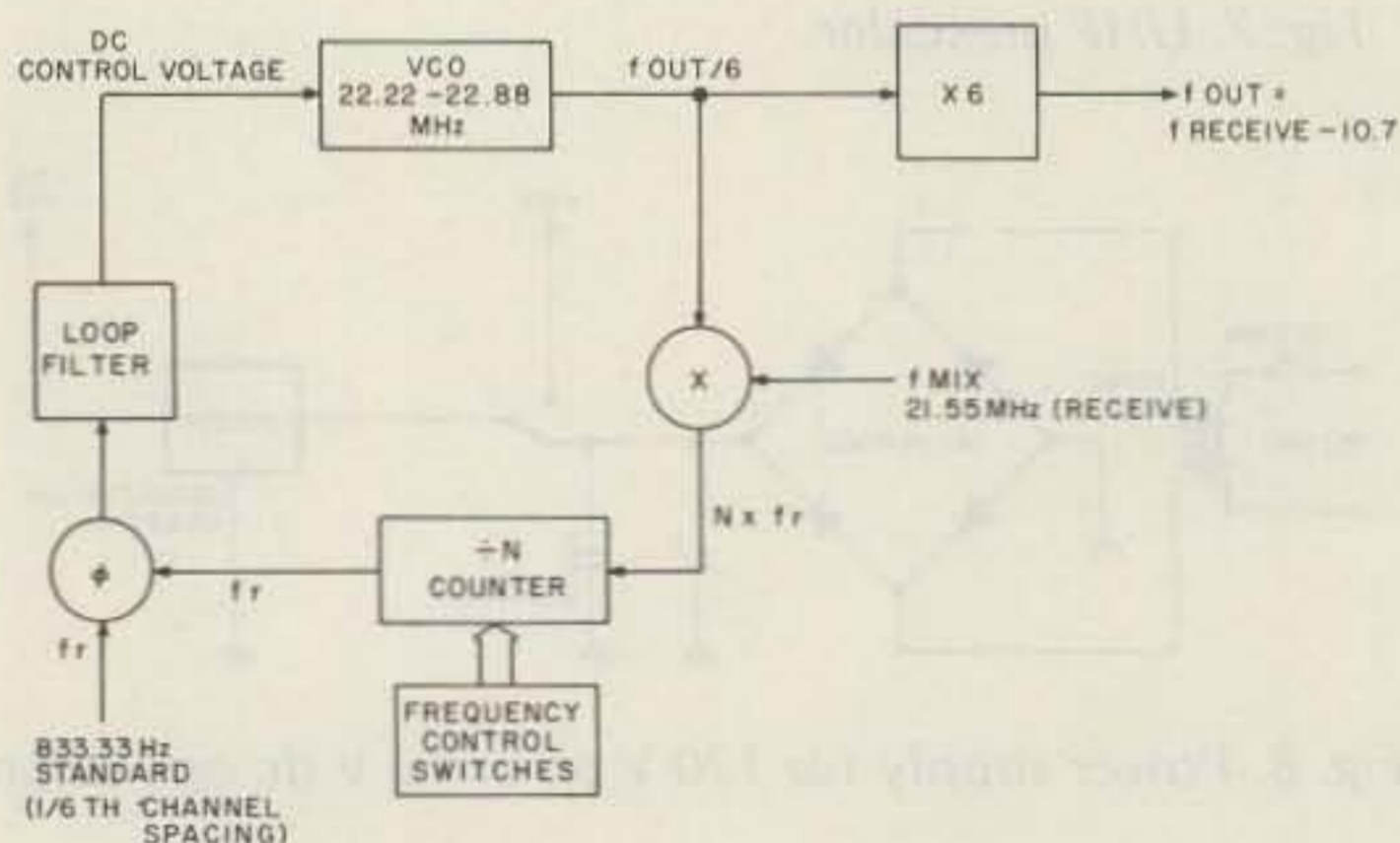

Fig. 1. Typical synthesizer block diagram.

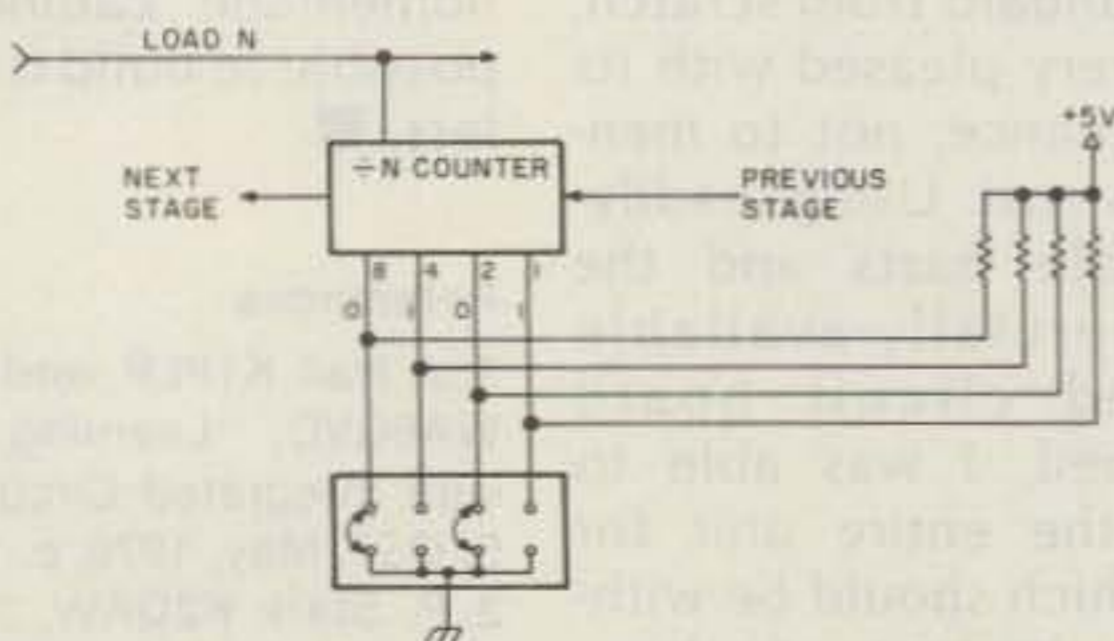

Fig. 2. One stage of ÷N counter.

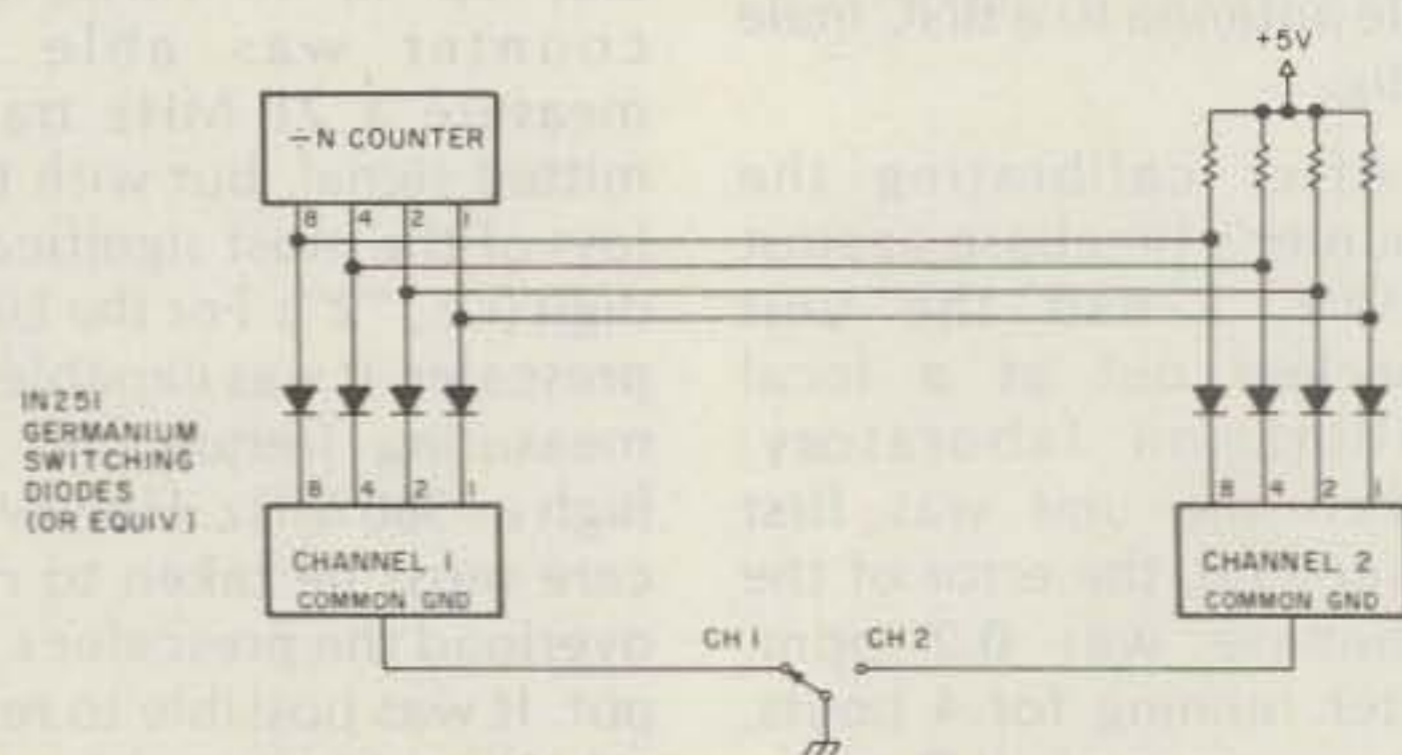

Fig. 3. Alternate channel selection.

to figure out where you are.

- b. 3 or 4—with automatic scanning. Only requires one more (cheap) IC and a few more discrete parts.

3. Method of channel entry/programming

- a. DIP switches—internal to rig. Allows easy reprogramming.
- b. Hardwired diodes—probably the best (i.e., cheapest) if you don't plan on changing frequencies often, or are using more scanned channels.
- c. Digital memory—programmed by front panel switches. Easy to reprogram, but relatively costly.

4. Scanning of receive-only or receive and transmit frequency

- a. Receive—if both the primary and secondary channels are either simplex or repeater frequencies, then the required offset is generated automatically. If modes are different, it is a simple matter to switch to the correct mode when activity is heard.
- b. Receive and transmit—many more components are, in general, required. There are easier ways to generate transmit offset.

Theory of Operation

Before I describe the scanner and how it gets connected to the rig, let me describe what a typical rig's synthesizer would look like. Fig. 1 is a block diagram of the HW-2036 synthesizer in receive mode. This diagram is representative of synthesizers used in amateur rigs for the purposes of this article.

When the loop is locked to the reference frequency, the loop output ($f_{out}/6$) is equal to $f_{mix} + N \times$

reference, where f_{mix} is the mixing frequency, reference is the crystal controlled reference, and N is the channel number, set by the front panel switches.

The digital number N is the only input to the loop and is the signal which controls the operating frequency. This is done by causing N to vary the division ratio of the $\div N$ counter.

Fig. 2 shows one stage of the $\div N$ counter used in the HW-2036. To cause the counter to divide by 5, for example, 5 (0101 in binary) is set by the BCD switch. Actually, the switch only sets the bits which are 0 by pulling those lines to ground. The 1s are pulled up to +5 volts by the resistors.

Implementing the Theory

This suggests a method for setting the second channel. If it were possible to disable the front panel

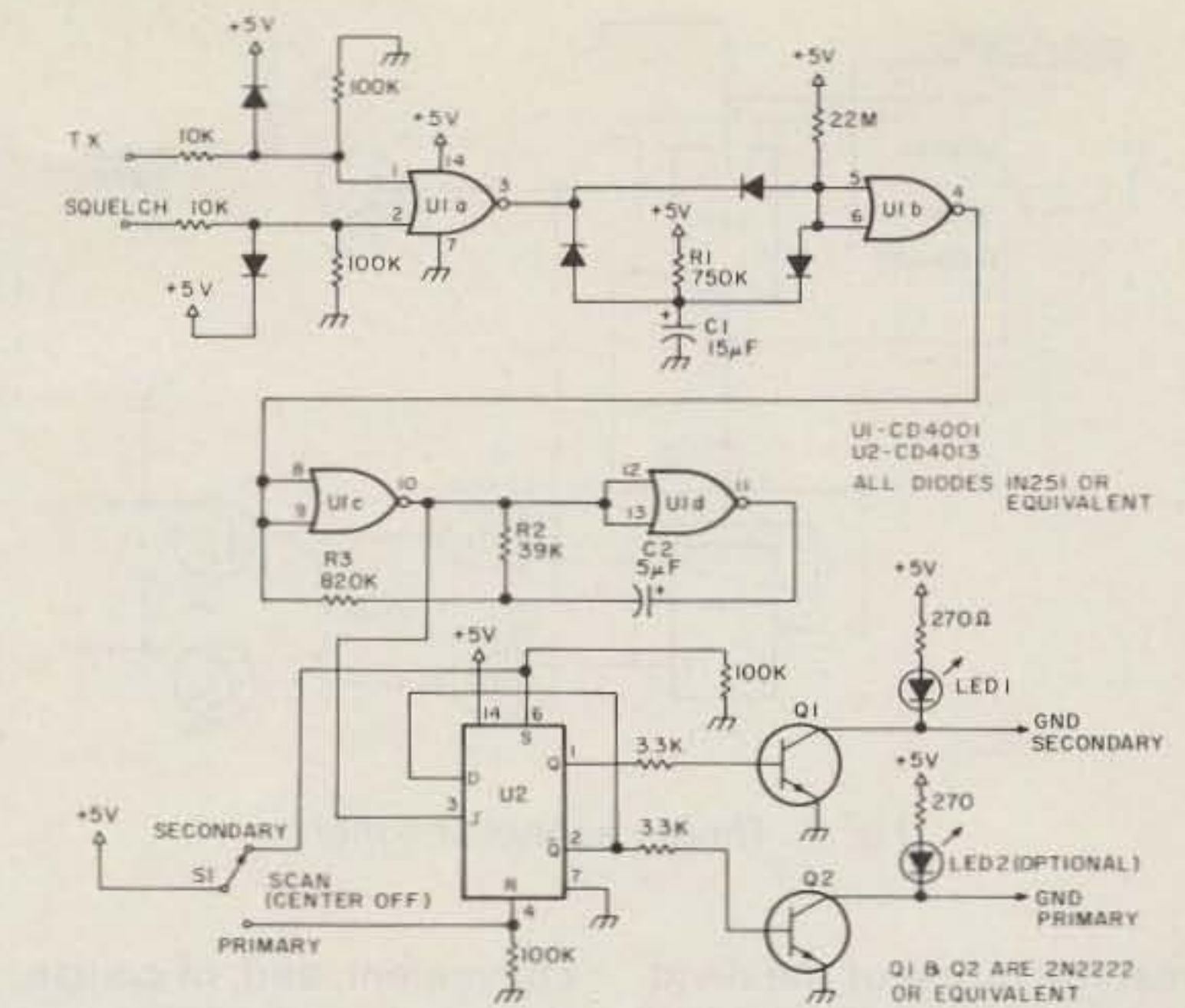

Fig. 4. Automatic scanning circuit.

switches from grounding the programming lines and provide an alternate ground path for the required lines, this could be used to program a secondary channel. It is not sufficient to disconnect the common ground connection on the switches

because, depending on the channel set on the front panel, some of the programming lines will be shorted together. This can easily be cured by inserting a diode in each line from the $\div N$ counters, as illustrated in Fig. 3. These diodes will not affect nor-

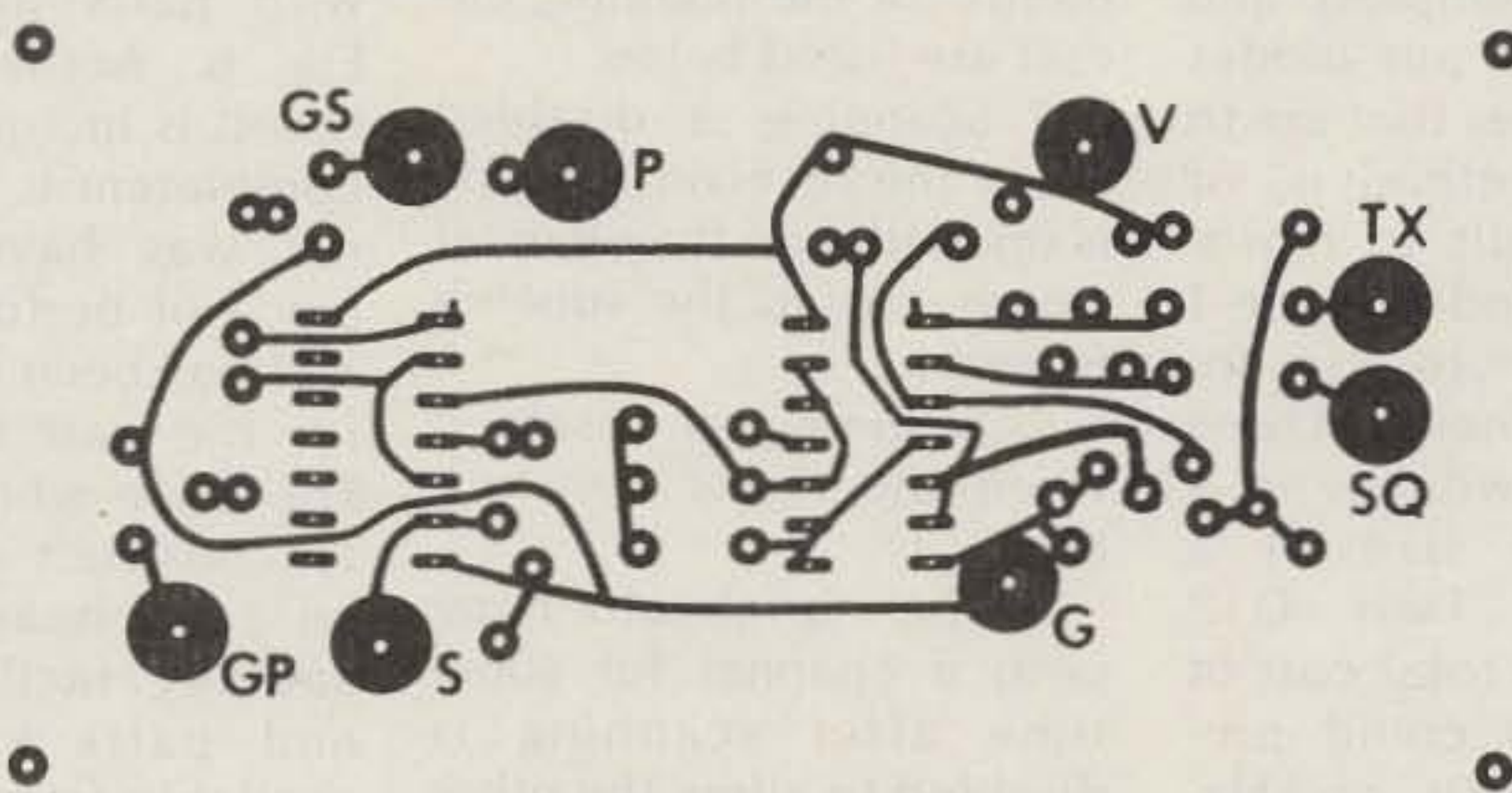

Fig. 5. PC board layout for synthesizer scanning adapter.

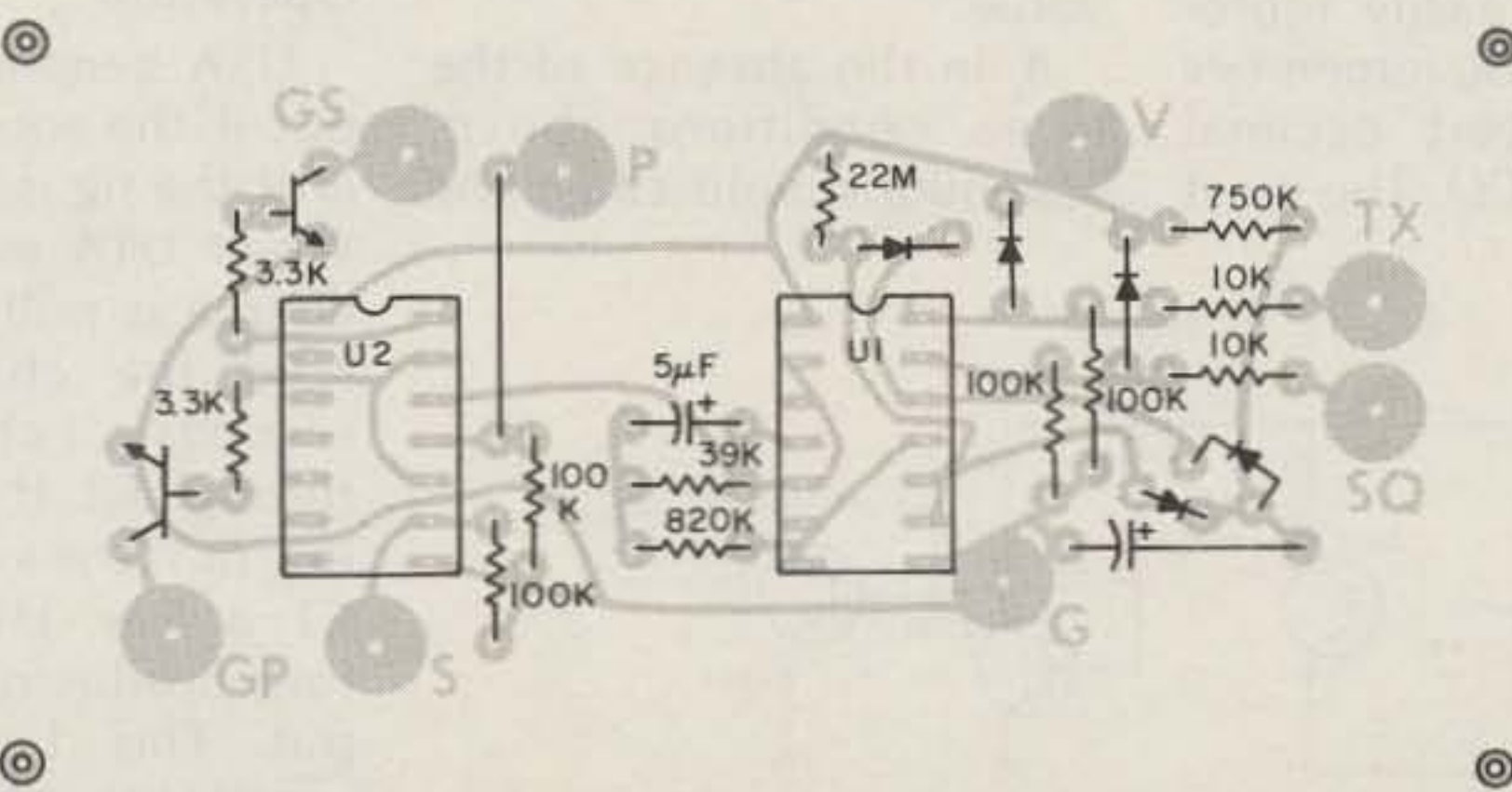

Fig. 6. Parts placement for synthesizer scanning adapter (foil side view).

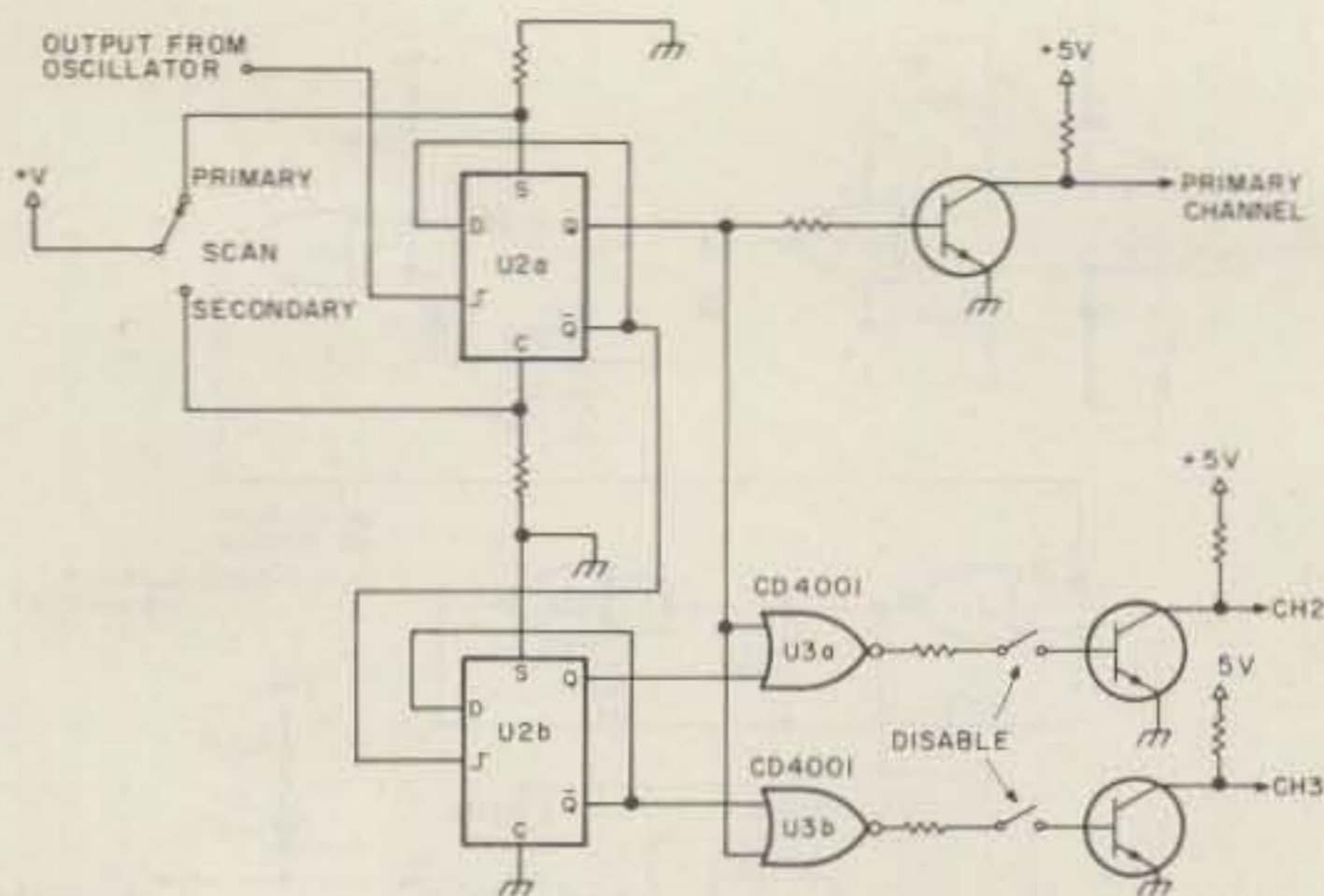

Fig. 7. Three channel scanner.

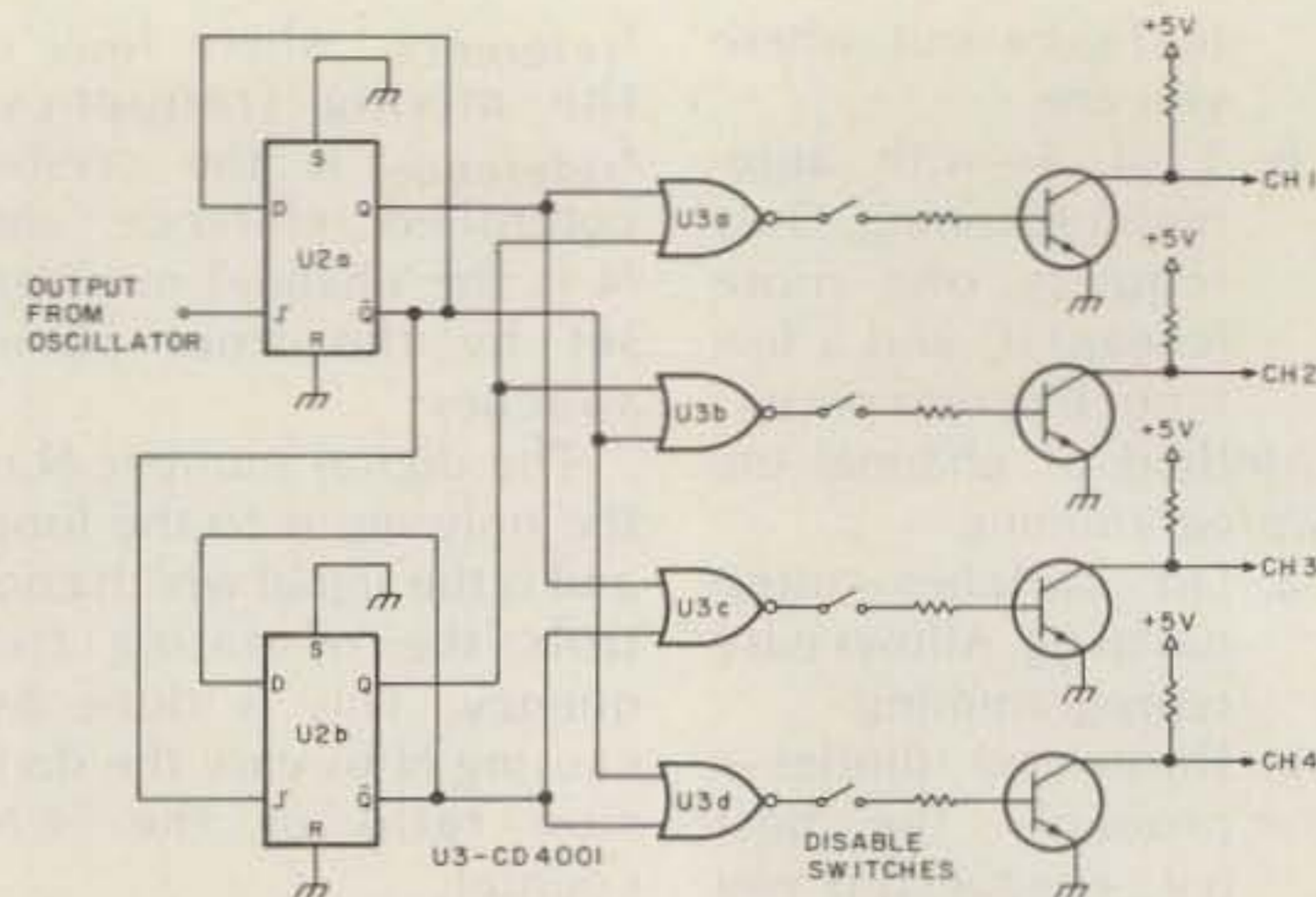

Fig. 8. Four channel scanner.

mal operation of the divider, as long as the logic 0 level does not exceed approximately 0.8 volts. Germanium diodes with a forward drop of 0.3 volts will help guarantee this condition.

This then gives all the information needed to build a manual 2 channel scanner, as shown in Fig. 2.

The switches used to select the secondary channel have many possibilities. The simplest and cheapest is to put diodes only in the lines that are to be 0. This method is, of course, difficult to reprogram. Next, and the one I have used, is to use so-called DIP switches. These are 8 SPST switches in a package the size of a 16-pin IC. Two DIP switches (at a total cost of less than \$5) could program MHz, 100s of kHz, 10s of kHz, and 5 kHz with 3 switches left over for other purposes. DIP switches are easily reprogrammed, if you remember how to convert decimal numbers to BCD. The most

convenient, and, of course, the most expensive, system is to use a second set of thumbwheel switches. I had no trouble finding room for 2 DIP switches, but would have been hard pressed to fit a second set of thumbwheel switches.

Automatic Scanning

The next thing to consider is how this scanning circuit can be made automatic. The requirements for the scanning circuit are listed below.

1. Scanning is disabled when the receiver squelch is opened—on the channel which caused the squelch to open.
2. Scanning is disabled when the rig is transmitting.
3. The rig should hang onto a channel for some time after scanning is disabled to allow the other side of the communication to start. Five seconds seemed to be a reasonable value.
4. In the absence of the three conditions above, scanning should cause the

transceiver to alternately select the programmed channels. The scan rate should be slow enough to allow for synthesizer lock-up time and squelch attack time. 250 ms per channel was chosen so that less than half the time is wasted for lock-up time.

Shown in Fig. 4 is the schematic of the circuit to accomplish automatic scanning. A PC board layout is shown in Fig. 5 with parts placement in Fig. 6. Actually, the PC board is included only for completeness as my scanner was haywired on a piece of perforated board and has been working fine for the past few months. For those who would like to construct this scanner on a PC board but don't have PC facilities, boards and parts kits will be available from the author. Send an SASE for information.

Operation

U1A generates a 0 output if the squelch is open or if the rig is transmitting. When U1A goes low, the charge is pulled off C1 to hold the channel for 5 seconds. C1 charges slowly through R1. If either U1A is low or if the voltage across C1 is low, U1B's input is low, producing a high output. This 1 disables the oscillator comprised of U1C, U1D, R2, R3, and C2.

R2 and C2 mainly determine the scan rate. The oscillator output, U1C, pin 10, drives a D-type flip-flop which alternates between turning on Q1 and Q2. When Q1, for example, is turned on, LED1 is lit, indicating that the secondary channel is enabled, and ground is provided to the secondary channel switches. I decided to use an LED to indicate only the secondary channel. There is no reason you couldn't use an LED for each channel, if you can remember which is which. A convenient place to mount the LED is in a hole drilled through the back of the S-meter. S1 is an SPDT center-off toggle mounted on the front panel. When switched to either on position, S1 forces the scanner to one of the selected channels by either setting or clearing U2. When switched to the center off position, the flip-flop toggles and, thus, scanning occurs.

This, then, is the entire scanner. Parts cost is very low even if you don't hunt for bargain parts or raid the junk box. Cost should be less than \$10.

Options

One option is to increase the number of scanned channels. As it happens, U2 is only half used. The other half, plus one other 20¢ IC

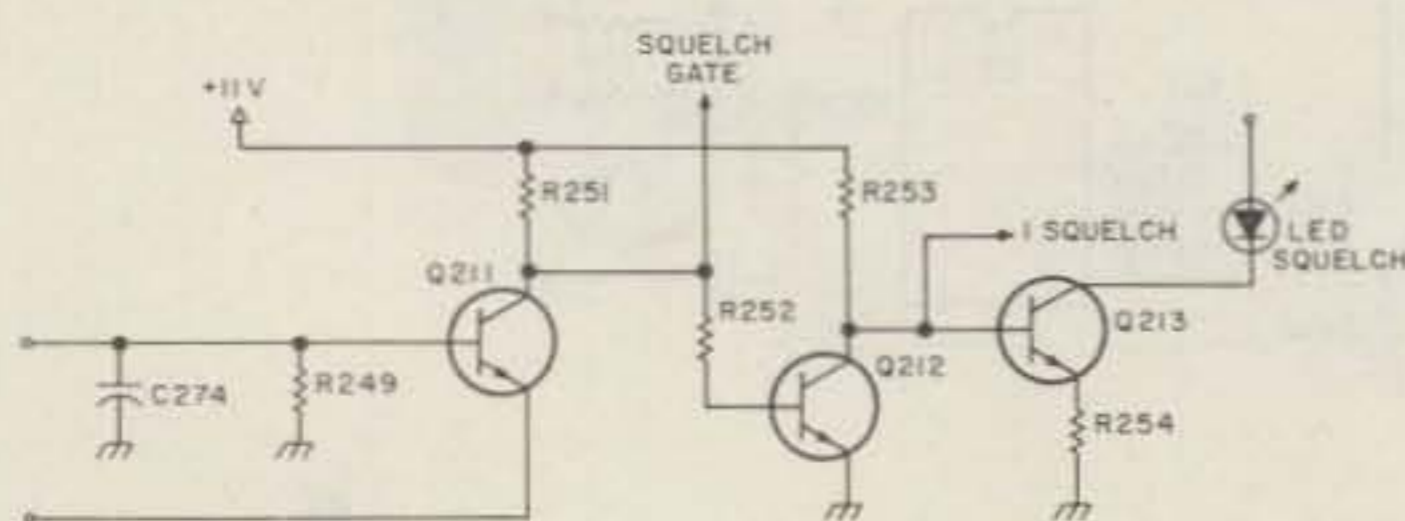

Fig. 9. HW-2036 squelch circuit.

and a few discrete components, gives you a three or four channel scanner. Two variations are shown in Figs. 7 and 8. Note that for the 3 channel scanner, two switches are provided to disable either secondary channel separately. As designed, the scanner will spend twice as much time on the primary channel as either of the secondary ones. The scan sequence will be: primary-secondary 1, primary-secondary 2, etc. In the 3 or 4 channel scanners, an additional CD4001 is used to decode scanning of the various channels.

Installation

Whichever scanning circuit is used, it will be necessary to obtain the required squelch and transmit signals from the transceiver. This will vary from one rig to another, but, as a guide, connections for the HW-2036 are shown in Figs.

9 and 10.

Note that on the scanner schematic the inputs to U1A have been connected through a series resistor with a shunt diode tied to +5 volts. This is because in the HW-2036, and probably most other rigs, the signals to indicate squelch and transmit may, at times, be greater than +5 volts. The input circuit will protect U1 from damage.

As I mentioned at the start of this article, the circuit is also usable on crystal-controlled rigs that employ diode crystal switching. If yours is such a rig, check to see if the schematic looks similar to that shown in Fig. 11. If it is, break the line connected to the indicated crystal (marked with an X) and connect it to the scanner primary and secondary ground lines.

Conclusion

I'll be glad to offer my

assistance in figuring out how to install this circuit in different rigs as long as no major redesign of the scanner or rig is necessary! I've already considered some of the commercially available rigs but would appreciate a copy of the sche-

matic and an SASE to return the details.

Thanks to Mike WB2BWJ for his constant, and occasionally useful, criticism during this project, especially as I started to cut up my HW-2036. ■

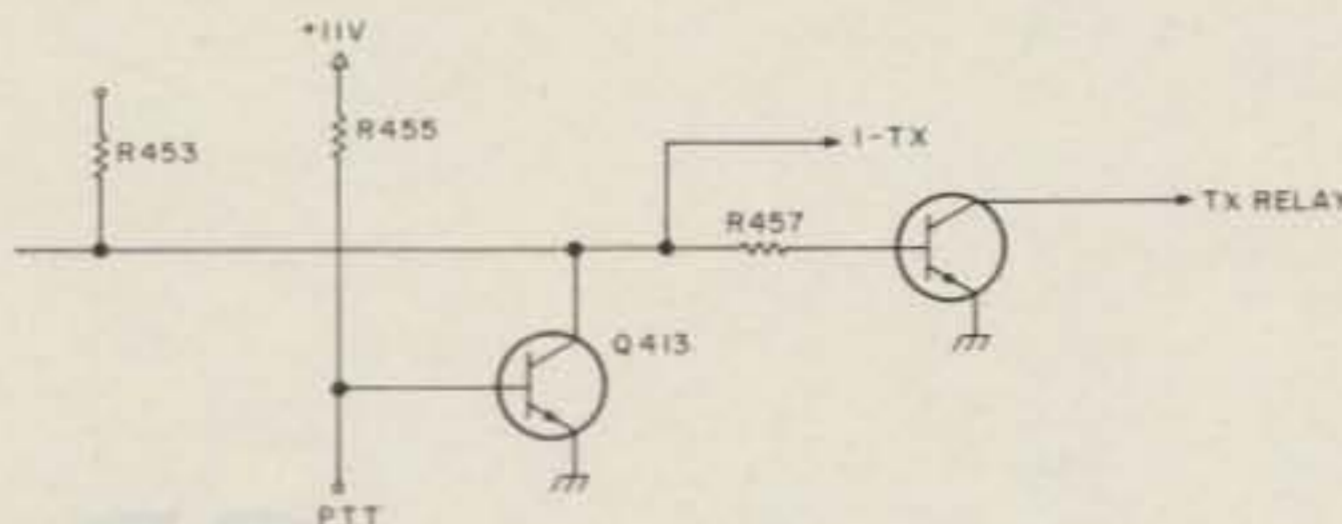

Fig. 10. HW-2036 transmit PTT circuit.

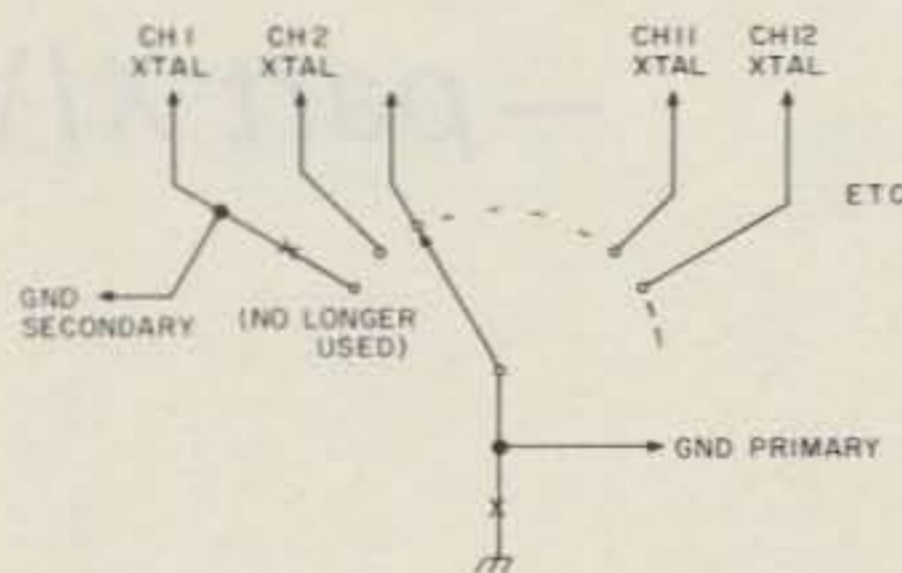

Fig. 11. Installation of scanner in crystal-controlled rig.

BRITT'S

2-Way Radio Service

✓ B29

2508 North Atlanta Road
Belmont Hills Center
Smyrna,
Georgia 30080
Phone (404) 432-8006

North Georgia's

only Authorized Yaesu Dealer

| | |
|----------------|--------------------------|
| Yaesu | Kenwood |
| Mosley Antenna | Vibroplex keys |
| Cush-Craft | B & W |
| Rohn-Tower | Swan meters |
| C.D.E. Rotors | Hustler |
| Shure | United Clocks and tuners |
| Call Books | ARRL Books |
| M F J | Saxton |

TPL 2 Meter Amplifiers

Complete service facilities

Call toll free 1-800-241-9961

Don't buy a box.

Try it out first.

ADIRONDACK

Radio Supply

Amateur Headquarters for the Northeast

185-191 West Main Street • P.O. Box 88
Amsterdam, N.Y. 12010 Tel. (518) 842-8350
Just 5 minutes from N.Y. Thruway - Exit 27

CB to 10

—part XIV: a Realistic PLL rig

Robert F. Grochowsky KØQLC
3553 SW 35th Terr.
Topeka KS 66614

A growing interest in CB-to-10 conversions, combined with a close-out sale at Radio Shack, resulted in the recent purchase of a Realistic TRC-452 40-channel CB. I had earlier obtained a 23-channel Royce set for conversion, but felt the cost for crystals was not justified to obtain only 23 channels. I must admit to a certain amount of blind faith in the TRC-452 purchase, but I figured a rig with only two crystals had to be both easier and cheaper to convert. This was later found to be true on both counts.

Although I had read all

the earlier conversion articles in *73 Magazine*, I had not studied them in great detail, except for my passing interest in the Royce. Another review of the articles showed little information on conversion of a phase-locked-loop (PLL) rig. This meant a great deal of studying digital frequency synthesis, and many hours spent in technical discussions with Gene Godsey KØBXJ and others. This article is intended to share the information gathered, and help others converting the PLL-type rigs.

Crystal Control

With crystal prices increasing and integrated circuit prices decreasing, it was only a matter of time before someone came up

with a better way to synthesize the necessary frequencies for CB. Crystalplex reduced the crystal count from 46 to 14, but the advent of the phase locked loop reduced the count to just 2 crystals in most of the newer rigs. At first glance, it may seem that these rigs are no longer crystal controlled, but further study shows that they are. Since the reference frequency is derived from a crystal oscillator, the tolerance and precision of the reference frequency and the output frequency will be that of a crystal.

Mixer Circuits

In order to understand PLL circuits, an understanding of mixer circuits is necessary. In the most

basic terms, a mixer has two input frequencies and four output frequencies. The frequency we will be interested in is either the sum of the original frequencies or the difference between the original frequencies. It is important to remember that either the sum or difference may be used, and they may be used differently in separate circuits within the rig.

Even the simplest single-conversion receiver in CB will normally use two mixer stages to arrive at the desired intermediate frequency (i-f) of 455 kHz. Two frequencies are mixed to arrive at the sum, and this signal, either 455 kHz above or below the received signal, will be mixed with the received signal to

arrive at 455 kHz.

Dual-conversion receivers use an additional frequency conversion stage for lower noise and less distortion of the received signal. Now we have two i-fs, and we may have additional amplifiers for each i-f. The first i-f is normally around 10 MHz and may be determined by close examination of the schematic.

Phase-Locked-Loop (PLL) Circuits

Most PLL circuits consist of 4 major components: a phase detector, a filter amplifier, a voltage controlled oscillator (vco), and a 1/N divider, plus other supporting components. Fig. 1 shows the diagram of these components as used in the TRC-452.

The phase detector produces a voltage proportional to the phase difference of two input signals. The low-pass filter (filter amp) integrates the output voltage of the phase detector and also filters harmonics of frequency components given to the phase detector. Then it produces a continuous voltage component in proportion to the phase difference. The vco is an oscillator whose frequency is controlled by the voltage applied to it. The vco frequency is fed back to the phase detector through the 1/N divider. (The constant, N, is given by the channel selector switch.) So, the output frequency from the vco becomes N times the input frequency.

The reference divider has two sections: One is a divide-by-2 circuit which produces 5.12 MHz; the other is a divide-by-1024 circuit which produces 10 kHz which is applied to one input of the phase detector. All PLL circuits studied use 10.24 MHz as the reference frequency. The 5.12-MHz output from the reference divider goes

through a filter which selects the harmonic produced at 15.36 MHz. The vco frequency is mixed with this 15.36-MHz signal, goes through IC2 interface, and is then divided to 10 kHz by the 1/N divider. This is applied to the other input of the phase detector. The phase detector detects the difference of these two input signals and produces a voltage which controls the vco frequency. When the phase of the two input signals to the phase detector is the same, this loop is "locked."

As mentioned earlier, the output frequency from the vco is N times the input frequency, 10 kHz. By varying the constant N, the output frequency can be varied one 10-kHz step at a time. The constant N is controlled by the channel selector switch (from 182 to 226).

Another output of the 10.24-MHz reference oscillator, not shown, is used to mix with the first i-f for the receiver. The incoming signal frequency (26.965 MHz for channel 1) is mixed with the vco output frequency (17.18 MHz for channel 1), which will produce 9.785 MHz as the first i-f. This 9.785 MHz is then mixed with the 10.240-MHz output of the reference oscillator to produce the 455 kHz second i-f.

Also not shown is the transmit local oscillator, which is set at 9.785 MHz. This signal is mixed with the vco output frequency to produce the transmit frequency. 17.18 MHz plus 9.785 MHz equals 26.965 MHz, which is the channel 1 frequency.

Now that we are familiar with PLL circuits, let's take a look at this circuit and see what we can change to provide the new operating frequency.

The first impulse is to change the 10.24 MHz crystal. But too many

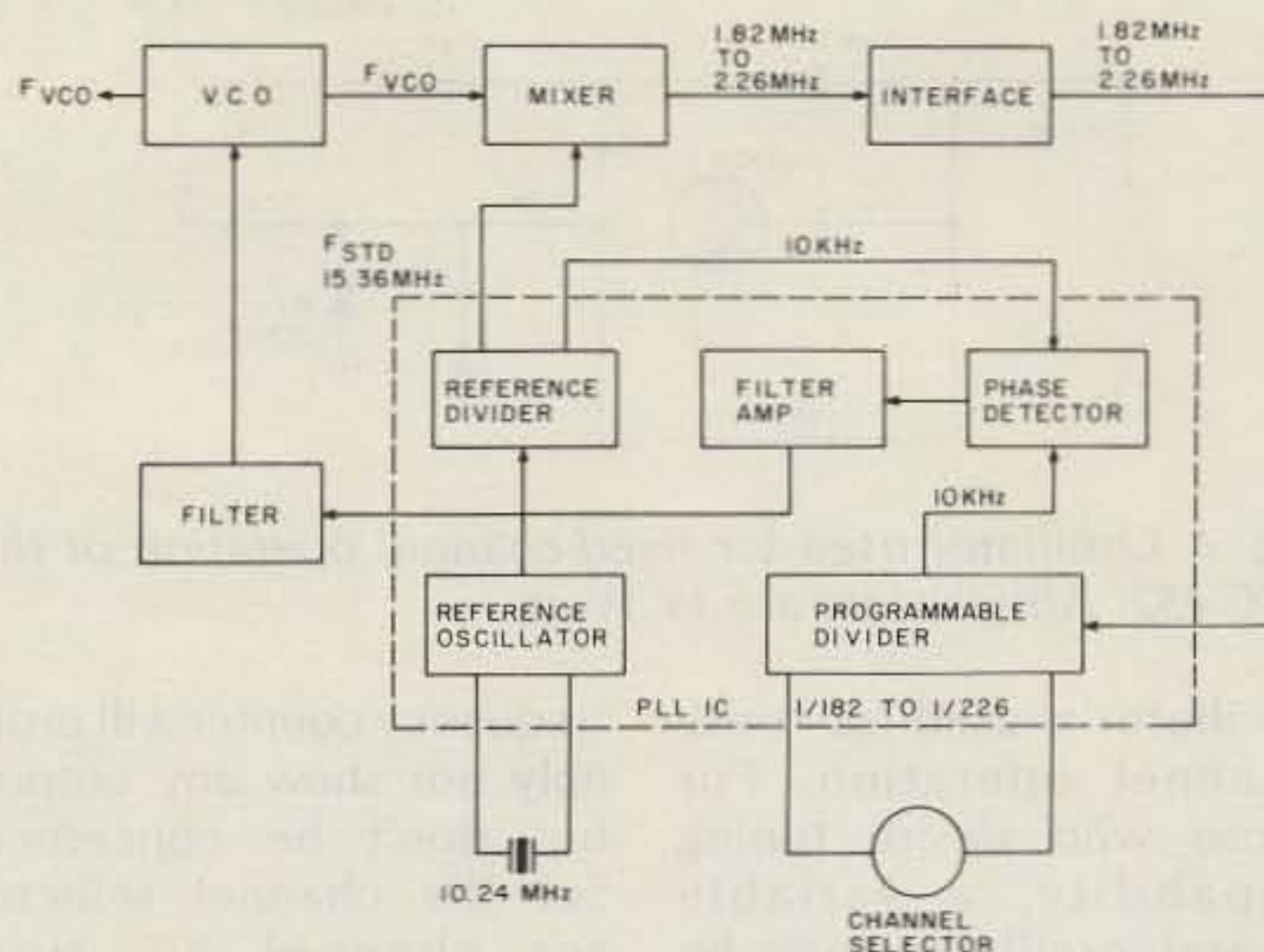

Fig. 1. Block diagram of the PLL components as used in the TRC-452.

things are dependent on this frequency. We are using a divide-by-1024 to provide the 10-kHz reference to the phase detector, so any change in the reference frequency will adversely affect our divider. We are also using a divide-by-2 to produce the 15.36-MHz harmonic which is mixed with the vco output.

By now, things seem pretty complicated. Any change in the 10.24-MHz reference changes the mathematical relationships between quite a few components. There seems to be no easy way to change the frequency of this rig. But further analysis shows that there is an easy way. Let's look at the way the vco changes frequency again.

10.24 MHz is divided by 1024 to produce a 10-kHz input to one side of the phase detector. If the channel selector switch is set to channel 1, which programs the divider to divide by 182, then the result of mixing the vco output with the 15.36-MHz reference must be 1.82 MHz to divide to the 10 kHz needed for the other input to the phase detector. The phase detector will detect any frequency difference, high or low, and adjust the vco up or down until the mixed output is exactly 1.82 MHz.

The key to the whole frequency change is tied to the 15.36-MHz reference. We can't change the reference divider, and we don't want to disable the whole reference divider, as we would kill our 10-kHz reference to the phase detector. Let's disconnect the 15.36-MHz reference from the mixer and replace it with a new oscillator set for 16.955 MHz. The vco will now be driven higher by the phase detector until the difference of 1.82 MHz is reached. The new vco output frequency will be 16.955 MHz plus 1.82 MHz, or 18.775 MHz. Mixing 18.775 MHz with the 9.785 MHz in the transmitter gives us a new frequency of 28.560 MHz for channel 1, which is right where we want to be. Mixing 18.775 MHz with the incoming signal of 28.560 MHz also keeps our first receiver i-f at 9.785 MHz, right where it was before. Everything else checks out, and all that we changed was the frequency reference applied to the mixer.

This works well in theory, so let's see how it works in practice. Fig. 2 shows the schematic for a simple crystal oscillator with no tuned circuit. This circuit and others are described in *Solid State Design for the Radio Amateur* (ARRL). This

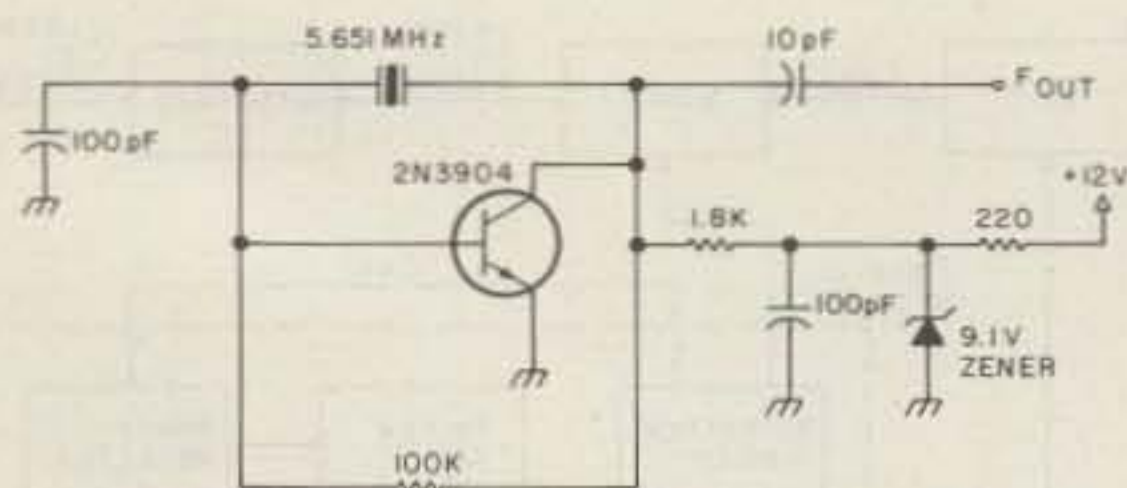

Fig. 2. Oscillator used for fixed-channel operation of the TRC-452. All resistors are 1/4 Watt.

oscillator is used for fixed-channel operation. For those who desire tuning capability, a variable crystal oscillator may be used.

Although some would say the oscillator output is dirty, I prefer to think of it as being rich in harmonic content. The circuitry of the TRC-452 is set up to use the third harmonic of 5.12 MHz, so a 5.651-MHz crystal will give a usable harmonic at 16.955 MHz. The combination of C3/L3 on the PLL board will filter all but the desired frequency, but it may be necessary to change the value of C3 to 30 pF to peak the filter at 16.955 MHz.

The first step in conversion is to remove the covers and locate the PLL board. It will then be necessary to remove the PLL board. In the TRC-452, the PLL board and side cover are soldered in place. Locate coupling capacitor C4 on the PLL board. Remove and discard this capacitor. Small shielded cable from the oscillator is now inserted in the C4 hole nearest the edge of the board and soldered in place. Reinsert the PLL board and tack in place. Be sure to connect all pins, as most of these are used in circuits as well as providing mounting stability.

Next, connect the oscillator to a well-regulated supply and apply power to both the oscillator and the rig. A frequency counter should be connected to the output of the 1st local oscillator. At this point, the

frequency counter will probably not show any output, but don't be concerned. Set the channel selector for channel 20. Now carefully adjust L2 on the PLL board and set it for the midpoint of the range where oscillation occurs. The frequency counter should indicate 19.115 MHz. Start with channel 1 and check all 40 channels. If the vco circuit, including L2, is functioning properly, we should show frequencies starting with 18.775 MHz for channel 1 and following normal CB channel spacing up through 19.215 for channel 40. If the oscillator drops out on either end, slight readjustment of L2 may be needed.

Now proceed with receiver alignment. Connect a signal generator to the antenna jack and set it for 28.800 MHz with 1-kHz modulation. Turn the channel selector to channel 20. Connect either an audio VTVM or oscilloscope to the external speaker jack. Now adjust L201 for maximum output. Set the channel selector to channel 40 and the signal generator to 29.000 MHz. Adjust the primary of L202 (black vinyl tube) for maximum. Set the channel selector to channel 1 and the signal generator to 28.560 MHz. This time, adjust the secondary of L202 (red vinyl) for maximum. Set up again for channel 20 and adjust L203 for maximum output. This completes the receiver alignment.

Transmitter alignment is the final step in conver-

sion. For this, I deviated slightly from the procedure given in the service manual. Connect either a wattmeter or swr bridge to the antenna jack and connect a dummy load. Again using channel 20, key the microphone and adjust L214 for maximum output. This will bring the final into resonance and prevent damage during extended key-down periods. Now adjust, in order, L208, L209, L210, L211, L212, and again adjust L214. These should all be tuned for maximum output. On the last adjustment of L214, detune slightly to extend the life of the final transistor. To complete transmitter alignment, modulate the transmitter with a 1-kHz signal at a level of 100 millivolts, and adjust VR207 to show 100% modulation on the oscilloscope.

The rig is now set up for 10 meters, and we must give some serious consideration to placement of the oscillator within the rig. Adequate shielding cannot be over-emphasized, and for this reason I chose to mount the oscillator on the top cover of the PLL board. Some angle stock and the rig cover will provide satisfactory shielding from rf. The shielded lead from the oscillator may be run down, and into, the PLL box between the two printed circuit boards. Since the oscillator has its own zener diode for voltage regulation, the power lead may be run to the switched +12 volts on the on/off volume control.

Whether you choose to convert a TRC-452 or some other PLL-type rig, the technique presented here should allow a quick, easy conversion.

If the vco refuses to drive up to the frequency needed, an alternative is to replace the transmitter crystal with one cut for

11.380 MHz, remove coupling capacitor C212 from the receiver, and use a separate oscillator set at 11.835 MHz to feed into the receiver mixer. Transmitter and receiver alignment should proceed as previously outlined.

Well, that's it. Replace the covers and you're set for a lot of activity on 10 meter AM. Or if you're like me, you can start planning for more modifications and accessories. A linear amplifier in the 20- to 25-Watt range would be nice. A variable crystal oscillator (vxo) circuit would allow shifting ± 10 kHz to completely cover this segment of the band. The rf gain could be hard-wired to allow using the control for the vxo. The PA function can be disabled and the switch used to apply a small amount of signal from the 9.785-MHz oscillator into the receiver to provide a beat frequency for SSB reception. And the list goes on.

Without a doubt, the TRC-452 proved to be both cheap and easy to convert. The crystal was my only expense as the junk box provided all other parts.

One last word of warning—10 meter fever is contagious and quickly spreads! On the day I converted my rig, I used 2 meters to tell KØBXJ to listen for me on 10. This immediately produced 2 hams talking back to me on 10 meter AM. One ham who listened got curious enough to visit me, and about 6 others who listened on 10 gave reports and suggestions on 2 meters. ■

References

"CB to 10" series, *73 Magazine*, May, July, December, 1977; February, August, September, October, 1978.

Realistic TRC-452 Service Manual, Radio Shack.

Solid State Design for the Radio Amateur, ARRL, 1977.

Now you have a friend in the business!



Planning to purchase a new Transceiver?
or a new Amplifier —
or an Antenna?

Talk it over with your friends at Clegg!

Shopping for Price?
Looking for Reliable Service?
Want Professional Advice?

Your friends at Clegg offer all this, and more!

Call us TOLL FREE TODAY (1-800-233-0250). We want to be your Friend. Let us Prove it!

Clegg

Communications Corp.
1911 Old Homestead Lane
Greenfield Industrial Park East
Lancaster, PA 17601

No More Excuses!

— get on RTTY
with this simple demodulator

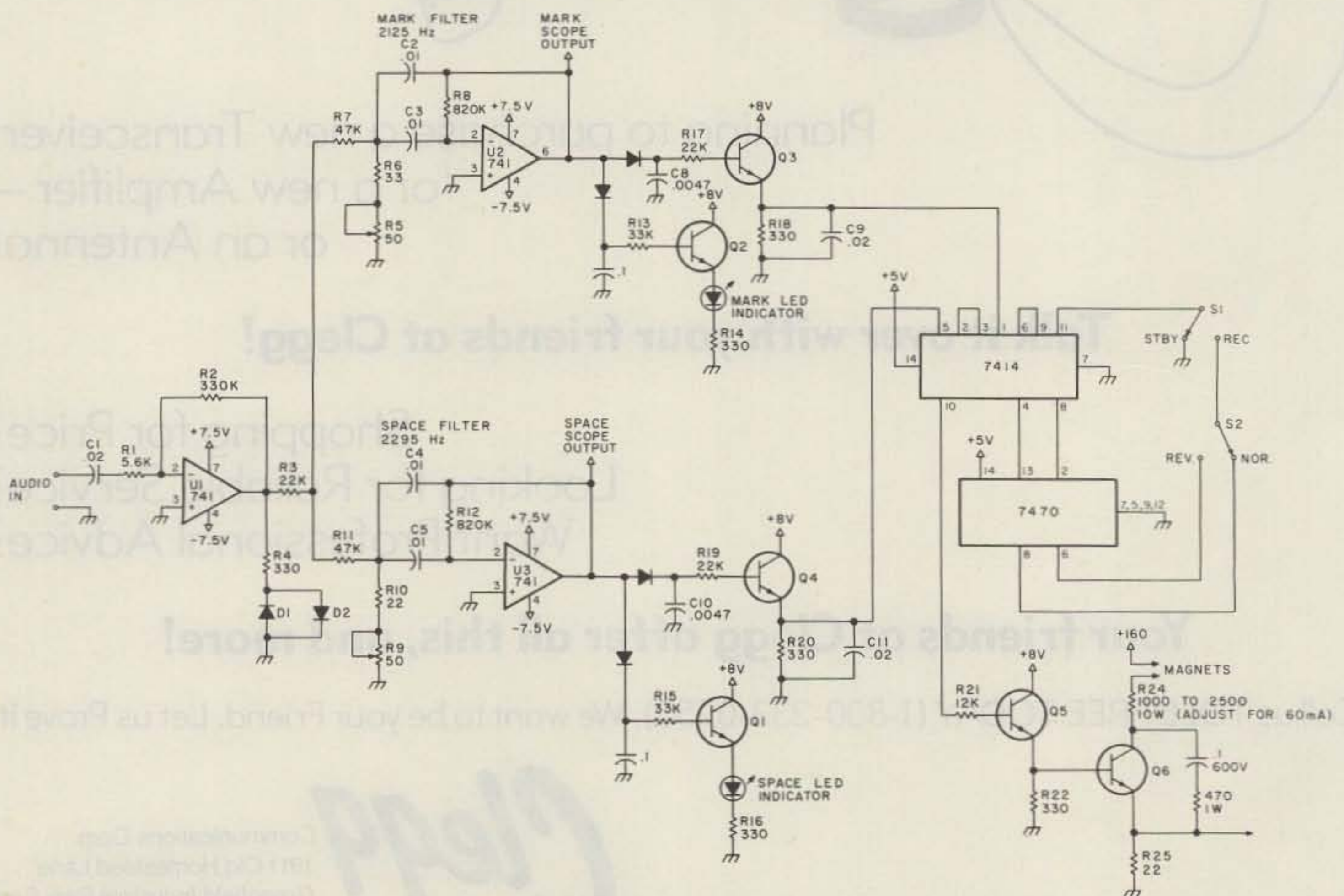

Fig. 1. Active filter RTTY demodulator schematic diagram.

Winford Rister WB4MBL
402 Alicia St.
Albertville AL 35950

After spending a lot of time looking for a circuit for a simple, easy-to-build, economical, good-performing RTTY demodulator, I decided to try designing my own. What resulted (besides pulling hair, etc.) was a relatively inexpensive unit which provides excellent copy, is easy to tune, and utilizes active filters. Of course, this is in addition to a swelled head and elated feeling which always arises when a circuit I design works well.

Theory of Operation

See Fig. 1. The main difference between this circuit and others I have read of is the use of active mark and space filters, LED indicators, and TTL switching logic. Circuit operation is very straightforward. The audio is applied to U1, where it is amplified, clipped, and fed to the mark and space filters, consisting of U2 and U3 and the associated RC networks. The filter outputs are shaped and amplified by Q3, Q4, and the Schmitt trigger, D4. The signal is double inverted here—once in obtaining the level detection and once to obtain the correct polarity to the flip-flop, U5. The flip-flop's outputs change state when the mark and space signals alternate. This output is inverted by another section of the Schmitt trigger chip. This prevents the machine from running open under no-signal conditions. (The Q and \bar{Q} out-

puts are both low under no-signal conditions.)

A reversing switch selects either the Q or \bar{Q} output for normal/reverse copy without having to switch to USB. This is an advantage for transceive operation. From the Schmitt trigger, the switching signal is applied to Q5, the switching follower/driver which drives the loop keyer, Q6.

Construction and Circuit Details

The complete unit, less the power supply, can be built on a 3" by 5" PC board. In the prototype unit, I use three boards: the power supply electronics, the demodulator, and the AFSK oscillator. Inexpensive, individual 8-pin op amps (741s) were used in the prototype unit, but some expense and trouble could be saved by using one of the quad op amp chips such as the LM324, which only requires a single polarity supply voltage.

The value for R4 was chosen experimentally for best performance, as were many of the other components of the unit. The filter circuit is taken from the January 15, 1970 edition of *EDN* magazine. The equations and parameters are listed in Table 1. There are two areas of caution: The feedback resistor R8 or R12 should not exceed 1 megohm because of large offset voltages. The frequency trimming resistors R5 and R9 should be as large as possible because

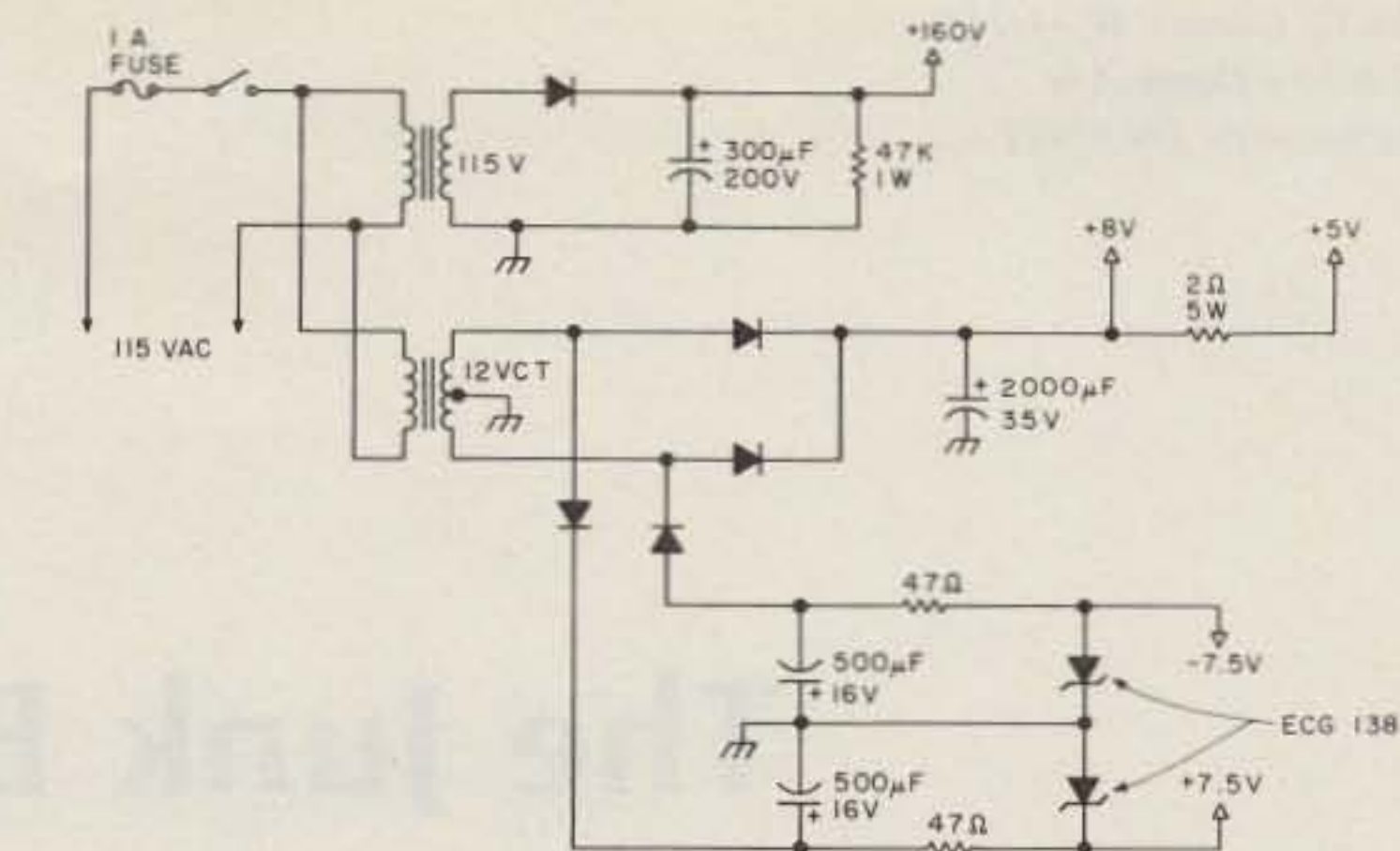

Fig. 2. Power supply schematic diagram.

of the attenuating effect they have on the input signal and the resulting possibility of the filter not being able to drive the following stage. R5 and R9 are of the miniature type and can be mounted directly to the PC board.

Q1 and Q2 are the LED drivers. Outputs for scope monitoring are taken directly from the filter outputs. Q3 and Q4 are emitter followers which drive the Schmitt trigger, which drives the keying follower/driver, which (finally) drives the loop keyer. All transistors are general purpose NPN silicon-type except for the loop keyer.

The output at the top of R22 must be amplified in order to drive an AFSK or FSK unit. I do this by using a separate transistor on the AFSK board.

Except for the loop supply, all the voltages are taken from one 12 V c-t transformer. The ± 7.5 volts is taken directly from the filtered output and

regulated as shown in Fig. 2. The 8-volt supply is simply the unregulated filtered output. The 5-volt supply is obtained by using series resistance from the 8-volt supply. Regulators for the 5- and 8-volt supplies were not used for economical reasons, and no problems have been encountered with them.

Conclusion

Active filters are the easiest type to tune and use, and, therefore, make this unit very easy to build. Also, the unit is compatible with the UT-4, if desired. As with anything new, it is often difficult to get started on the right foot. This demodulator will allow the newcomer to RTTY an inexpensive means to get his feet wet and still realize the full enjoyment of using a unit that performs well. I wish to give special thanks to Jimmy Straughn K4COV for his encouragement and assistance in writing this article. ■

| Mark filter U2 | | Space filter U3 | |
|----------------|---------|-----------------|---------|
| F | 2125 Hz | F | 2295 Hz |
| R7 | 47k | R11 | 47k |
| R8 | 820k | R12 | 820k |
| R5 | 69 | R9 | 59 |
| C2, C3 | .01 | C4, C5 | .01 |
| B | 39 Hz | B | 39 Hz |
| A | 8.68 | A | 8.68 |
| Q | 54 | Q | 59 |

Table 1. Active filter data, where: F = center frequency; B = 3 dB bandwidth; A = voltage gain of filter at F; Q = F/B; R7,11 = $(2\pi BAC)^{-1}$; R8,12 = $(\pi BC)^{-1}$; and R5,9 = $1/[2\pi c(2F^2/B - BA)]$.

The Junk Box Station

—ham ingenuity does it again

Since you ran that photo of my home brew transmitter in the May, 1977, issue of 73, I was surprised to receive letters of inquiry about it, especially since you printed only my name, city, and state without including my call or address. I don't know if it is due to the large circulation factor of 73 or whether there is actually a considerable number of readers who are interested

in what can be home brewed from junk parts. Anyway, assuming the latter to be correct, I thought I would send in a photo of my entire home brew station, which is just about as home brew as a ham like me can make it, from the keyer paddles on.

I can say that I had no trouble finding parts. The transmitter is made mostly from parts from my old black and white TV and the

receiver comes mostly from parts salvaged from a bunch of smashed-up or non-working transistor radios I purchased at a flea market for 25¢ apiece.

The transmitter, which uses a 6AU6 vfo, 6W6 driver/multiplier (TV audio output tube), and a pair of 6DQ6s (TV horizontal output tubes) in the class C final, can run up to 160 Watts input (if my little VOM is accurate) and

about 120 Watts output, judging from the brilliance of a 100-Watt light bulb used as a dummy antenna.

There was a lot of trial and failure in building this rig. I first tried a solid state vfo, then a tube type with a cathode follower and buffer; finally, I came up with the single 6AU6 in a Colpitts circuit which doubles in its output that gave my desired results and also simplified the design considerably. I have tried to make the transmitter sound as good as the best that is on the air, and with my hand-wound choke in the keying shaping circuit and the fact that I can detect no oscillator pulling or other shift, I believe I have had some success in my efforts.

I made a check of the harmonic output of this station by using another receiver with an S-meter. And by adjusting the rf gain until the meter read as near zero as I could get it on my second harmonic (20m), then flipping the bandswitch and tuning in the fundamental (40m), the meter read close to 70. So, if this means my second harmonic is 70 dB down, then I think the suppression is adequate. I have had no TVI complaints, even in my own house. And



UNFORTUNATELY...



**Radio
equip-
ment
doesn't
grow
on
trees!**

You have worked hard for your money—don't gamble when you buy that next rig, antenna or even accessories. Contact C&A where they have been serving the amateur and commercial market for almost two decades. C&A can offer you the best prices plus the assurance that they will be there to back up your purchase with their staff of experienced **LICENSED** technicians and a genuine desire to add your name to their long list of satisfied customers.

CALL OR WRITE for all your needs to:



C&A Electronic Enterprises

Distributors of Commercial and Amateur Radio Equipment ✓c88

Two locations to serve you better:

22010 S. Wilmington Ave., Suite 105
Carson, CA 90745
(213) 834-5868

5773 Overland
Boise, Idaho 83705
(208) 377-5274

my home brew TV yagi is right under my roof-mounted inverted vee and in the field of its current loop.

I mentioned the word "adequate" above, but with hams like me it is often a fluid expression. I know if I can get my harmonic down 70 dB, then why not 80 or more?

My receiver (the small box on the right in the photo) is an all-transistor dual conversion superhet with cascode FETs in the rf stage and a crystal-controlled first conversion oscillator. It also has a home brew double crystal 350 cps bandpass filter in the second conversion i-f. The receiver is completely self-contained with power supply, speaker, and everything (except the antenna) enclosed in its cabinet. That cabinet, incidentally, is a card index file box I bought at a dime store for \$1.49; this was the only ready-made cabinet I bought for this project. The transmitter chassis is made from a galvanized sheet I purchased from the roll at the hardware store, but I forgot where I got the aluminum to make the cover and vfo shield. But this card file box plus the dial on the front of it, and the crystals, pretty much represent my total cost layout for the receiver, discounting, of course, the parts from those 25¢ transistor radios and a few other parts from my junk box.

I work only CW, mainly because I seem to find that that is where most of the experimenters like myself operate. And because of my leanings toward CW, I have made no provisions to broaden the 350+ cps bandwidth of the receiver. Perhaps another reason is that I don't have room to stuff another switch in that little cabinet (which is already straining at its seams), and I fear with a



little too much encouragement, it just might let go and scatter about a bushel of parts all over the shack. I realize, of course, that the passband is too narrow for voice, even a little sharp for CW sometimes, and I often get the feeling I am copying code through a tin horn, but it really chops down the QRM.

I have had requests for schematic diagrams of my station, and these requests I have turned down—not that I am ornery, not that ornery—it is just that I doubt if I could draw a schematic of it, for it is so full of trial and error, unknown change, etc. I don't know how, for instance, I could advise the winding of the keying filter choke on a core whose use I did not even know in my old TV or the number of turns I put on it, and I don't cherish the idea of unwinding it just to count them. The rf output circuit is probably overly complex also, and throughout the rig there are clusters of resistors placed in series and/or paralleled to give the right values. In other words, if I could draw up a schematic and attempted to build this station again

from it, I have my doubts that it would work.

I recently overheard a conversation in a radio store discussing why in the world anyone would want to spend so much time, worry, and trouble building when the finished product could be purchased from the shelf. I think one of those involved in the conversation pointed a finger at the side of his head and made a circle with it.

Well, I suppose, there are all kinds of us hams. To me, plugging in ready-made gear and talking in an SSB round table would be something I would grow tired of quickly. But putting something on the air that is of my own creation is, to me, 90% of the fun of our hobby; besides, it has been quite an education for me.

Finally, and getting back to the original subject, I hope no one will judge the performance of my station by its appearance. If it sounded like it looks, my General class privileges would have probably been in trouble a long time ago. It is just that good orderliness doesn't seem to be one of my virtues. Besides, it is difficult to make

something pretty out of junk parts. And if the lettering shows up on my transmitter in the photo, it will read: "Built from genuine junk parts."

I did, however, try for compactness. Why? I have no idea, unless that seems to be the way they are doing things these days, and that is even a bigger "why" to me. Incidentally, my standard size clipboard is in the photo for size comparison, and I do believe that is the biggest-looking clipboard I ever saw; so, my transmitter is really not all that small.

But my "compact" (utterly congested would be a better description) transmitter and receiver have given years of trouble-free service, thank goodness, and I've received nothing but the best of reports on my signal quality.

So, if this article has given any of you hams who may be potential home brewers any ideas about getting the soldering iron out, good luck to you; be very careful of the high voltage hazards, and if you work 40 meters a lot, you may hear this rig on some-time . . . on CW, of course. ■

Clegg is...



...ICOM Headquarters

No one else offers as diversified a transceiver line as ICOM, and no one else can fill your ICOM needs better than Clegg!

Take your pick for your favorite mode and band:

IC-701 160-10 meters, Synthesized, Solid State Digital readout, 200 watt PEP input.

IC-211 144-148 MHz, Synthesized, FM/USB/LSB/CW Digital readout, 10 watt output Solid State, 13.8 VDC and 115 VAC operation.

IC-245/SSB 144-148 MHz, Synthesized, FM/USB/CW digital readout, 10 watts output, Solid State Multi-Mode Mobile.

IC-280 143.9-148.11, Microprocessor controlled memory. 1 and 10 watt FM'er. Remote controllable.

IC-30A 440-450 MHz FM, 22 Channels, 10 watts

IC-202S 2 Meter SSB Portable

IC-502 6 Meter SSB/CW Portable

IC-215 2 Meter FM Portable

IC-402 432 MHz SSB/CW Portable

Call us TOLL FREE for quote on the ICOM of your choice!

1-(800) 233-0250

(In PA call (717) 299-7221 collect)

Call Clegg for best price.

Clegg

✓ C3

Communications Corp.
1911 Old Homestead Lane
Lancaster, PA 17601

Looking for a different brand? Clegg also stocks all other major product lines including Dentron, Alpha, Yaesu, Drake, Wilson, KLM, Hustler and MFJ, and—of course—Clegg transceivers.

R-X Bridge + Calculator = Vswr

— antenna tuning without QRM

ment to the antenna is made. You microcomputer buffs will quickly recognize an application for your digital hardware to relate the vswr value to the input data via a short processing program. Most hams, however, do not as yet have a microcomputer, so we seek a less powerful but simpler and lower cost solution. Enter the programmable calculator.

Few of us need to be impressed with the phenomenal progress in hand-held calculators over the last few years. They have improved from simple arithmetic devices to "slide-rule" scientific and programmable units with magnetic card memories. Until recently, programmable calculators have commanded fairly high prices — not as much as the \$2000 and up microcomputer installation, but at least in the \$200-to-\$400 range, which is still a bit high for a casual buy. Recently, a low-cost programmable calculator, the National/Novus 4525, has been sold for less than \$40² (around \$50 with charger and case). So the programmable units seem to have entered the lower cost casual-buy phase. If you have never been involved in programming, would like to start somewhere, and would like a fairly powerful calculator, this unit can give a simple yet good introduction to the procedure of writing special programs to solve repetitive problems. If you are just curious, you can buy both the Palomar bridge and the calculator for less than a hundred dollars and make vswr measurements without putting a signal on the air.

The program given here can process the R-X bridge readings and give you the reactance value, normalized impedance values, reflection coefficient, and vswr value from a Palomar bridge reading in just a few seconds. The two small instruments together make a powerful team. The portability of the R-X bridge allows one to

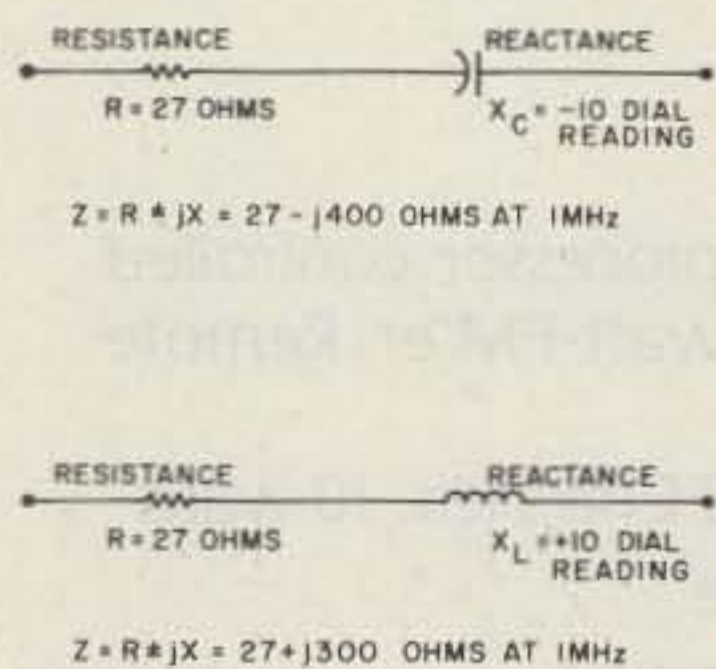

Fig. 1. Series impedance components.

The Palomar R-X bridge¹ is an excellent piece of equipment for amateur station use. It is battery operated, portable, small, handy, accurate when calibrated, and it will give actual impedance and vswr (voltage standing wave ratio) with a little calculation. It is sold as an antenna bridge, but it actually is a more general instrument, being capable of

resistance measurements from about 5 to 250 Ohms and reactance values of plus or minus 1200 to 12 Ohms at 1 to 100 MHz. Universal Radio recommends it for TripoleTM owners to check the vswr of their antennas on those frequencies just outside the ham bands where it is not legal for a ham to put a carrier on the air or on the SWL bands. It is also good for everyday use as an impedance bridge and as a double check on your vswr bridge readings. You might be surprised how inaccurate some vswr bridges are found to be.

To get the vswr from a bridge reading of, say, 27 Ohms and -10 pF requires some algebraic calculations. These are not really difficult, but they do become a bit tedious, especially if you are making a point-by-point plot of vswr data. The calculations must be repeated each time a new measurement or adjust-

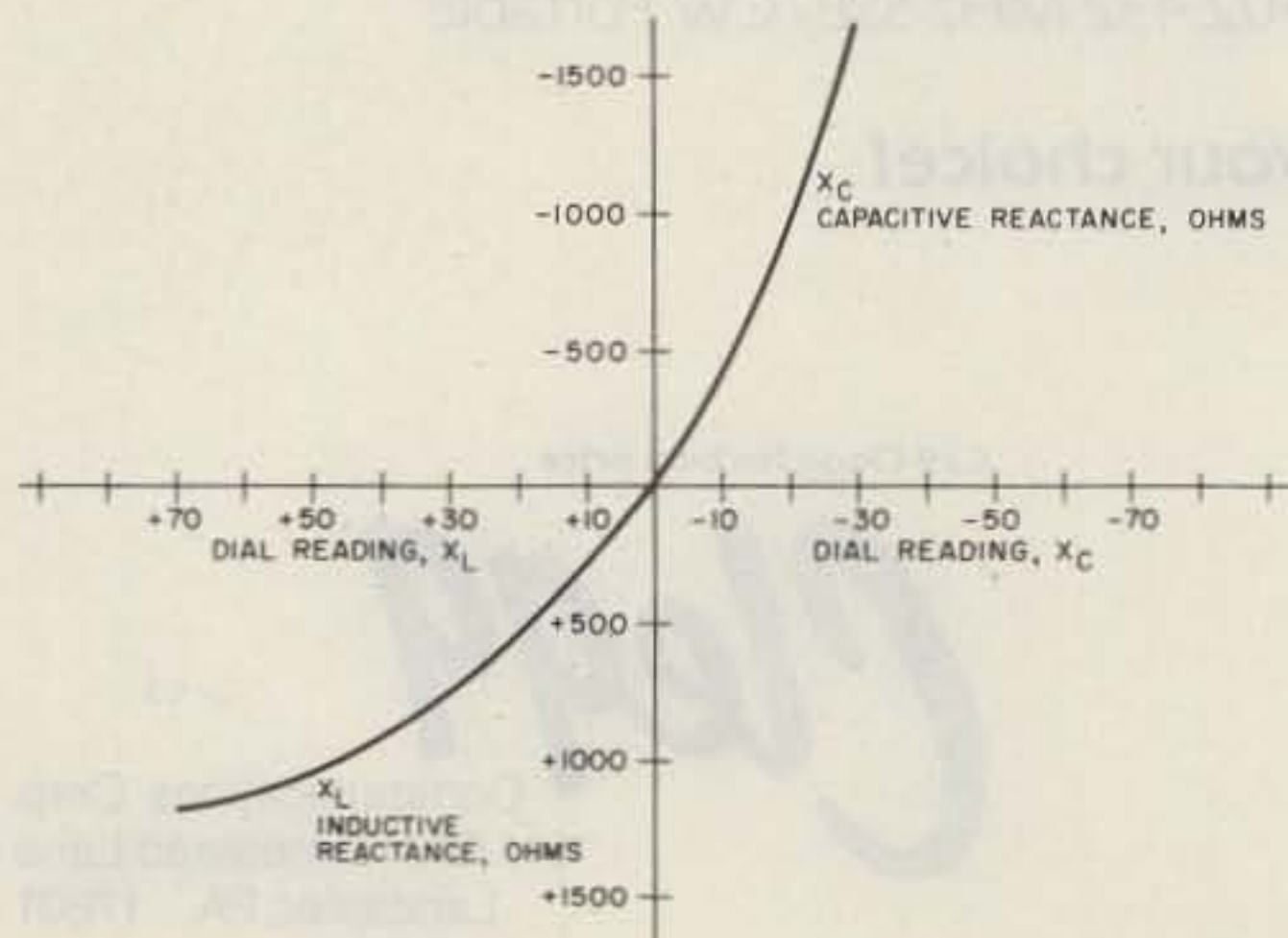

Fig. 2. 1 MHz calibration curve for Palomar bridge.

climb a tower, bridge in hand, and make measurements (a portable receiver is needed, too) directly at the antenna. The vswr may also be measured at the transmitter end of the feedline, as usual. The program itself should also be easily incorporated into some of the more expensive Hewlett-Packard programmable calculators, all of which use the same "reverse Polish" notation and keyboard. For example, the addition of a line 39A, which repeats line 39, allows the same steps to be used on a nonprogrammable HP-35 calculator, deleting, of course, the start and halt steps in the program.

R-X Measurements

The standard instrument for R-X measurements is the Hewlett-Packard 250B R-X meter. This is a large precision instrument which sells for over \$3000. It will be found in many engineering laboratories but not many ham stations. The Palomar bridge has less range and accuracy, but, at its \$50 cost, it is an ideal instrument for hams. The Palomar bridge indicates in terms of series impedance values, perhaps a bit easier to understand than the parallel values of the HP instrument. For one who wishes to know the actual impedance of an antenna, it gives a reasonably accurate answer, especially when calibrated with known standard resistors and reactances. The Palomar bridge measures resistance and reactance values from 1 to 100 MHz. The impedance reading is that of a series configuration as shown in Fig. 1. The resistance value is easy to comprehend. Resistance means the same thing at high frequencies as it does at dc. In series with the resistance component of a reading is a reactance component. The dial of the Palomar bridge is calibrated for the series reactance readings of zero to ± 70 picofarads. Understanding the bridge reading on the capacitive or

X_C side (say, -10 on the dial) is relatively easy. The impedance, such as the example in Fig. 1, is a resistance in series with a capacitive reactance of 400 Ohms at 1 MHz or 398 pF. On the inductive or X_L side (say, +10 on the dial), the impedance would be that of a negative 530 pF or 300 Ohms of inductive reactance at 1 MHz. If understanding the fact that a negative capacitance reading gives an inductive reactance value bothers your thinking, then you are a good candidate for using the calculator program which takes all this into account and gives the correct answer each time. The 1 MHz reactance values are given by the calibration curve of Fig. 2. This curve is derived from the design of the bridge, and the equations are the basis of the calculator program. The same curve appears in the Palomar instruction manual.

To determine the reactance value at any frequency, one must divide the value read from the curve of Fig. 2 by the actual frequency of the measurement in MHz. That is, the readings from the curve of Fig. 2 would be divided by 10 if the measurement had been made

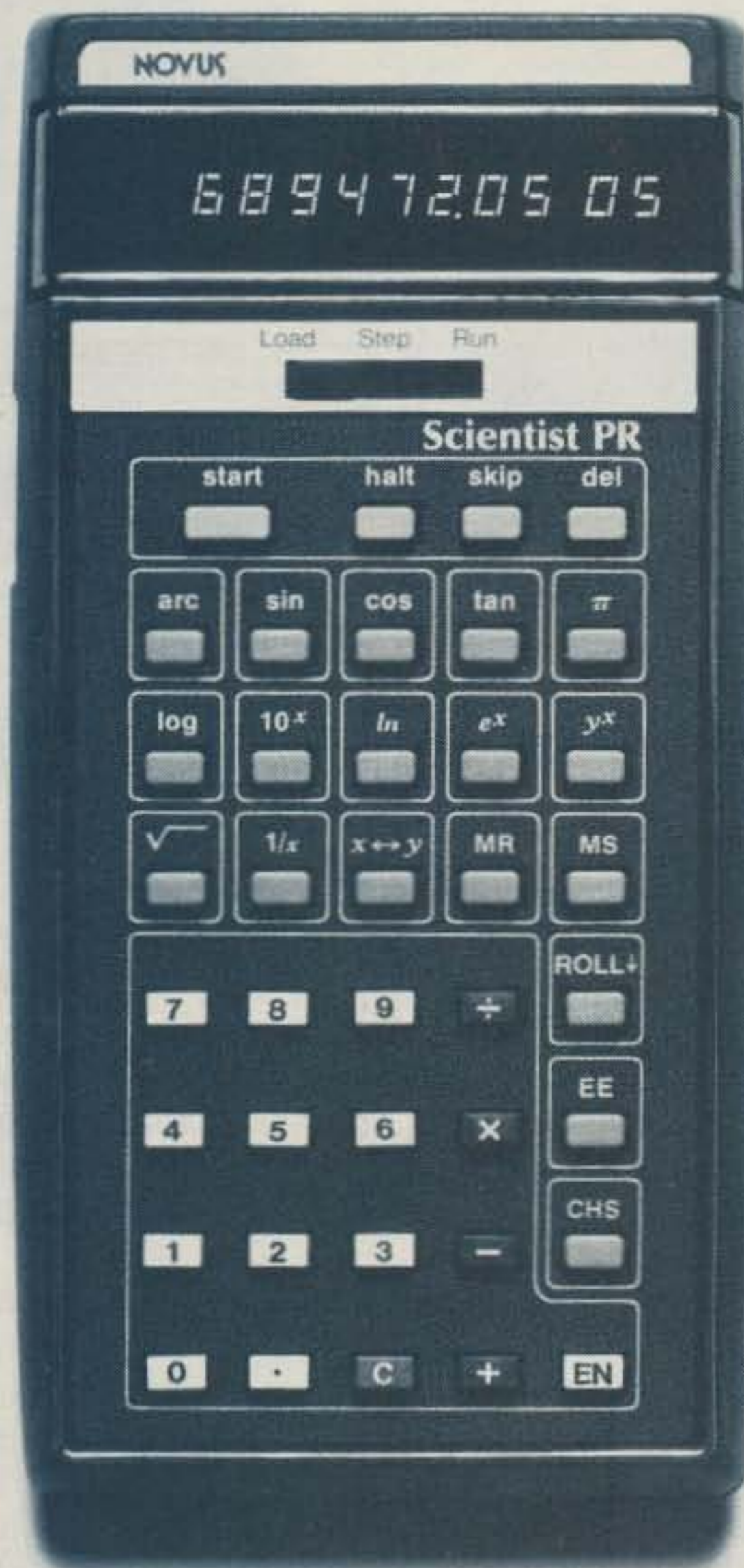

The Novus 4525 programmable calculator.

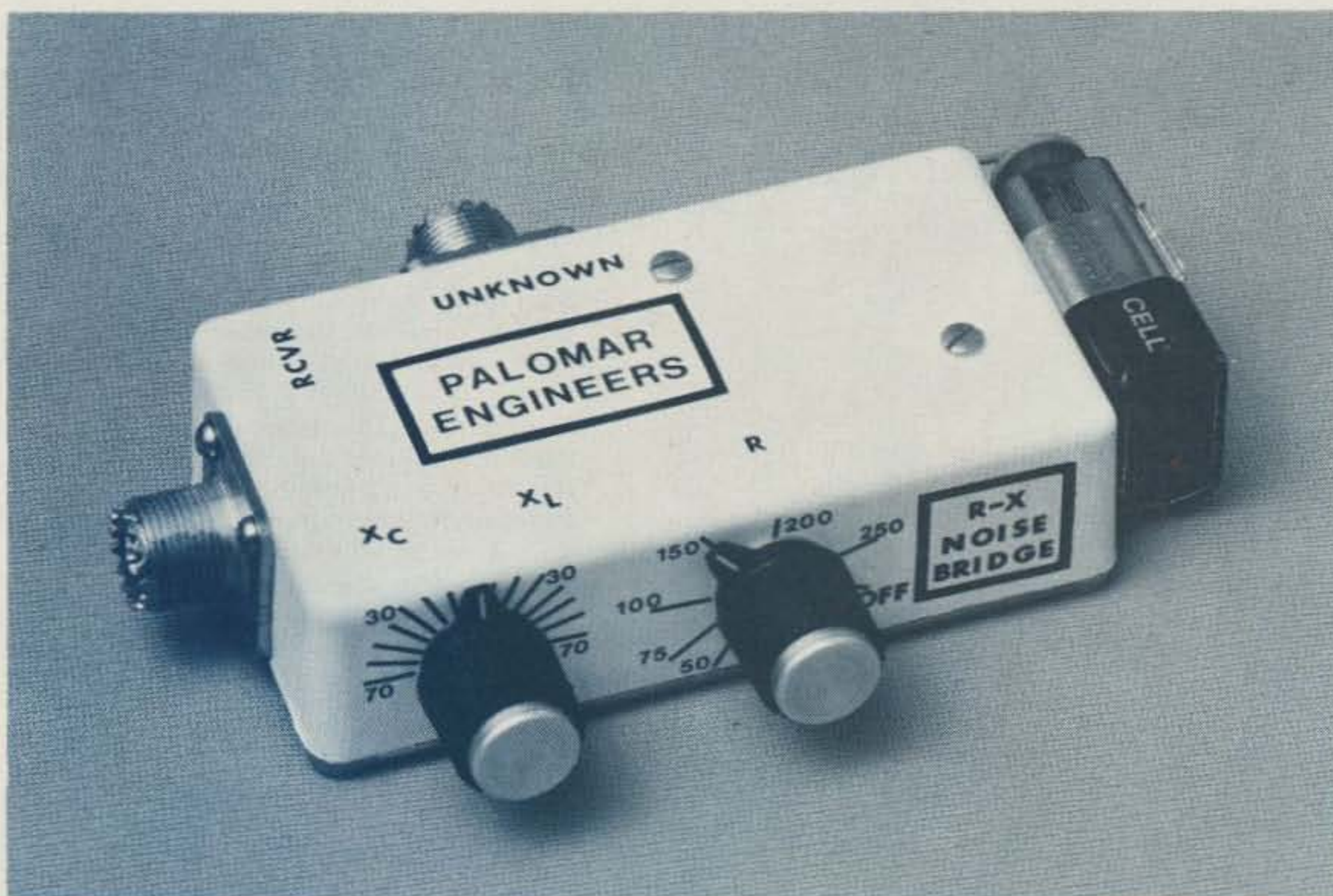

The Palomar R-X bridge.



Measuring an impedance with the R-X bridge and a battery-operated receiver.

at 10 MHz. All this takes more time to describe than it does to actually do it. It is a fairly simple procedure to get an actual resistive and reactive value from the readings, aided by the graph.

Calculating the vswr from the bridge reading, on the other hand, is a bit tedious. It is necessary to calculate the normalized impedance values, relative to the transmission line characteristic impedance,

the magnitude of the reflection coefficient on the line, and then the actual vswr itself. The same would be true of any impedance bridge, including the aforementioned HP unit. This is really where the calculator program shows its worth. However, since the program is written to speed up the job, it is better to include the steps of actually finding the reactances and eliminate any

need to look them up on the graph of Fig. 2. Interpolation errors and errors due to misreading the graph are eliminated, too. So, by entering the dial readings and frequency into the program, the impedance values are given, as is the vswr. For completeness, it will be mentioned that it is also possible to use a Smith chart to get the vswr graphically. It is still tedious, however, and subject to the above

errors, especially if you really don't understand a Smith chart very well.

You might think a simple calculator would be unable to properly manipulate the data since, after all, it involves complex numbers in the impedances. The calculator manipulates real numbers only. This turns out to not be a problem in vswr calculation because the vswr may be calculated from the magnitude of the reflection coefficient.

The Program

The instructions in a calculator program are simply the list of those buttons which you push, in the order in which they are to be pushed. The calculator remembers these instructions and executes them automatically in later runs of the program. In a calculator which employs reverse Polish notation, as do the Novus 4525 and HP calculators, there is no equal sign, and you start calculations by use of the EN (enter) button. Much of the program itself is concerned with manipulating and storing the data into positions where it can be used in proper sequence in the equations being solved. These equations are given in Fig. 3, and the program itself is the listing of 90 steps given in Fig. 4.

To load the program into the calculator, put it into "load" mode and key in the program with a dummy variable being used in each of the positions where data will be inserted later. If the program gives the correct answer with the dummy variable, you will know the loading has been performed correctly. Switch to "run" mode, push the start button twice, and the program runs.

Input Data

The program requires three values of input data: the resistance dial reading, the reactance dial reading, and the frequency of the measurement. Initially, the calculator stops with a 68 displayed. You insert the

| Equation solved by program | Remarks |
|--|---|
| Equation 1: $C_2 = \frac{68 C_1}{C_1 - 68}$ | This solves the value of the unknown series capacitance from the setting of the variable C_1 and the bridge fixed capacitor 68 pF. |
| Equation 2: $X_{C2} = -\frac{1}{2\pi f C_2}$ | The reactance of the load is calculated with the standard formula. Note that when C_2 becomes negative, the sign changes and the reactance becomes positive, that is, inductive. |
| Equation 3: $Z_N = \frac{R}{Z_0} \pm j \frac{X_{C2}}{Z_0}$ | The normalized impedance Z_N is the value divided by the characteristic impedance Z_0 of the transmission line. In this program, Z_0 is fixed at 50 Ohms but may be changed to any Z_0 at line 37 when the program is initially loaded. |
| Equation 4: $\Gamma = \frac{Z_N - 1}{Z_N + 1}$ | Here, Γ is the magnitude of the reflection coefficient. |
| Equation 5: $vswr = \frac{1 + \Gamma}{1 - \Gamma}$ | Vswr calculation from the magnitude of the reflection coefficient. |

Fig. 3. Equations solved by the program.

| Instruction | Remarks | | |
|---------------------------|--------------------------------------|---------------------------|--|
| 1. Start | | 46. MS | |
| 2. 68 | Bridge uses 68 pf. | 47. R+ | |
| 3. EN | | 48. R+ | |
| 4. Halt | Stop for first input. | 49. EN | |
| 5. R | Use R=27, dummy variable | 50. EN | |
| 6. MS | first time, otherwise any | 51. EN | |
| 7. x \leftrightarrow y | value of R. | 52. 1 | |
| 8. EN | | 53. - | |
| 9. EN | | 54. EN | |
| 10. EN | | 55. x | |
| 11. Halt | Stop for second input. | 56. MR | |
| 12. ΔC | Use $\Delta C = 15$, dummy variable | 57. EN | |
| 13. + | first time, otherwise any | 58. x | |
| 14. EN | value of ΔC . | 59. + | |
| 15. R+ | R+ key is labelled ROLL+ | 60. $\sqrt{\quad}$ | |
| 16. x | on the Novus 4525 | 61. MR | |
| 17. R+ | | 62. R+ | |
| 18. - | | 63. MS | |
| 19. EN | | 64. R+ | |
| 20. R+ | | 65. 1 | |
| 21. R+ | | 66. + | |
| 22. R+ | | 67. EN | |
| 23. x \leftrightarrow y | | 68. x | |
| 24. \div | Gives C2 here. | 69. R+ | |
| 25. 2E-6 | Entry is: 2, EE, CHS, 6. | 70. R+ | |
| 26. x | | 71. EN | |
| 27. π | | 72. x | |
| 28. Halt | Stop for third input. | 73. EN | |
| 29. F | Use frequency = 7, dummy | 74. R+ | |
| 30. EN | variable first time, otherwise | 75. R+ | |
| 31. R+ | any value of F, in MHz. | 76. R+ | |
| 32. x | | 77. + | |
| 33. x | | 78. $\sqrt{\quad}$ | |
| 34. 1/x | | 79. MR | |
| 35. Halt | Display X_C value. | 80. x \leftrightarrow y | |
| 36. EN | | 81. \div | |
| 37. 50 | Choose $Z_0 = 50$ ohms here. | 82. Halt | Display reflection coefficient Γ |
| 38. EN | | 83. MS | |
| 39. MR | | 84. 1 | |
| 40. x \leftrightarrow y | | 85. + | |
| 41. \div | | 86. 1 | |
| 42. Halt | Display normalized R/ Z_0 | 87. MR | |
| 43. R+ | | 88. - | |
| 44. \div | | 89. \div | |
| 45. Halt | Display normalized X/ X_0 | 90. Halt | Display VSWR, answer with dummy variables is 4.892 |

Fig. 4. Program listing.

resistance dial reading and push start. It stops again with a 68 displayed, you insert the reactance dial reading (positive for X_L values and negative for X_C values), and push start. It stops with pi (3.1415927) displayed, and you enter the frequency and push start. The dimensions used are Ohms, picofarads (up to plus 68 on the dial), and megahertz. A typical entry would be: 27, 15, 7.

Output

The first output given by the program is the result of the calculation of the reactance value as shown in equation 2 in Fig. 3. This reactance will be positive for

inductive impedances and negative for capacitive impedances. It is given in Ohms. The calculator stops with the reactance value displayed, and you may write it down at that time or just go on to the next output by pushing the start button again. For example, with 27 Ohms and +15 pF at 7 MHz, the display reads 60.4 (Ohms).

The next two outputs are the values of the normalized impedances, as shown in equation 3, Fig. 3. These are useful for entry into a Smith chart, if you are using one to design a matching network or some similar application. The resistance is given first. For the example problem, the

output is 0.54, and, after the next push of the start button, it reads 1.208, the normalized reactance value.

The next output is the reflection coefficient magnitude, as given in equation 4 of Fig. 3. It reads 0.66 in the example problem.

Finally, the last push of the start button yields the value for vswr, which is 4.892 in the example.

All of these inputs and outputs may be processed in just a few seconds, much more easily than the pencil and paper method. You learn the bridge and calculator are worth their cost after only a few uses. Also, at current prices, both of these instru-

ments are best buys.

A Listing Form

Fig. 5 is a listing sheet for the program steps. Such a sheet is desirable when writing your own programs or recording others for future use. You not only list the steps but also show the status of the "stack" registers at each step and include remarks about data entry and outputs. It is left blank, so you can copy it on a copy machine and make as many more forms as you wish.

Limitations

The limitations in the calculator program are such that you should not insert a

YOU ASKED FOR IT YOU GOT IT DSI QUIK-KIT®

550 MHZ COUNTER KIT *Performance You Can Count On*



OPERATES ON

- Batt 6-C Size
- DC 8.2 To 14.5 VDC
- AC Batt. Eliminator

\$99.95
MODEL 3550 KIT

DSI OFFERS THE BEST OF TWO WORLDS . . .

An unprecedented DSI VALUE . . . in a high quality, LSI Design, 550 MHZ frequency counter kit. And, because it's a DSI innovation, you know it obsoletes any competitive makes, both in price & performance. The basic 550 MHZ counter & time base are factory assembled, tested and burned-in. The problems of bad LEDs, IC's, capacitors, are a thing of the past with DSI QUIK-KIT®. But you can take pride in assembling the power supply, PC mounted selector switch, input connectors, and the final mechanical assembly of your 550 MHZ counter, into its' handsome cabinet. **GO WITH THE LEADER . . . BUY A DSI FREQUENCY COUNTER KIT. SAVE TIME & MONEY AND BE ASSURED IT WILL WORK THE FIRST TIME.**

SPECIFICATIONS

Time Base TCXO 1PPM 65° to 85°F
Frequency Range 50HZ to 550MHZ
Resolution 1HZ to 55MHZ, 10HZ to 550MHZ
Gate Time 1 second - 1/10 second
Sensitivity 25MV 150 & 250MHZ 75MV 550MHZ
Display Eight 1/2-inch LEDs
Input Two SO239 Connectors
Power 6C-Size Batt., 15HR, or 8.2VDC to 14.5VDC
Current 150 Ma standby 300 Ma operational

3550 KIT INCLUDES

- Pre-assembled, tested counter board
- Case, power supply, connectors, hardware
- Built-in prescaler & preamp
- Gate Light - Automatic Zero Blanking
- Automatic Decimal Point
- One to two hours assembly time
- One Year Warranty on all parts
- All new parts - not factory seconds or surplus

| | |
|--|---------|
| 3550 Kit | \$99.95 |
| T-101 Telescopic Antenna | 3.95 |
| AC-9 Battery Eliminator | 7.95 |
| Cigarette Lighter DC Adapter | 2.95 |

TERMS: Orders to U.S. and Canada, add 5% to maximum of \$10.00 per order for shipping, handling and insurance. To all other countries, add 15% of total order. California Residents add 6% State Sales Tax.

SEE YOUR LOCAL DEALER
OR

CALL TOLL FREE (800) 854-2049
California Residents, Call Collect (714) 565-8402

DSI INSTRUMENTS, INC.

7914 Ronson Road No. G, San Diego, CA 92111

VISA • MC
AMERICAN EXPRESS
CK • MONEY ORDER
COD

High Seas Adventure — Ham Style

— part II

James E. Seidel WA6FEI
1066 N. Westside St.
Porterville CA 93257

As dawn broke on the morning of April 19, 1977, a small blip appeared on the *Trader's* radar. Dis-

tance — 16 miles. The passengers could see it from the deck of the ship as it loomed up from the sea like a

crouching lion. It was the home of Tom Christian VR6TC, a direct descendant of Fletcher Christian of *HMS Bounty* fame. It was Pitcairn Island.

Photos by Jules Wenglare W6YO



Welcome to Pitcairn, home of the descendants of "Mutiny on the Bounty." Tom Christian VR6TC can be seen in one of the longboats as it is being pulled onto the island for shelter.

For Jules Wenglare W6YO, this would be one of the many stops being made in his 10-month around-the-world cruise. He had left Freeport in the Bahamas on February 15 to adventure into the world's greatest ports of call and to operate amateur radio from the four corners of the globe. He visited and met other hams in such places as Haiti, Bonaire, the Canal Zone, Ecuador, and the Galapagos. When he arrived on Easter Island, Jules met Father Dave Reddy CEØAE, a world renowned ham operator.

Jules was on board the *Yankee Trader*, a 176-foot-long motor-sailer out of Windjammer Cruises, Miami Beach, Florida. The first two months of his around-the-world cruise were covered in a previous issue of 73. In this part, he goes ashore on Pitcairn Island and has a face-to-

face QSO with one of the most sought-after contacts in amateur radio — Tom Christian VR6TC. Later, stops are made in Tahiti, Cook, Samoa, and even Australia. His adventure-chasing experiences to these exotic ports of call will be covered here.

On the tape I received from Jules on his visit to Pitcairn, he stated: "We finally got into anchorage at Pitcairn Island. Because of bad weather, we were told it would be best to anchor near Young's Rock on the west end of the island about a mile from Bounty Bay. We waited there for a long time before the longboats could get out to us." (The longboats are the only means of entry or exit from Pitcairn. They are diesel powered, measure 38 feet long and 9 feet wide, and can carry up to 5 tons of cargo.) "Two longboats arrived, swung up alongside, and the people began waving.

"After the boats were secured, the people of Pitcairn — men, women and youngsters — began climbing aboard the *Trader* with their bags of wares." (The Pitcairners sell stamps, booklets, carvings of sharks and birds, woven baskets, etc.) "After they were aboard, I went over and asked someone who Tom Christian was. He was pointed out. We talked for awhile, and, at about 11 o'clock, the captain announced that we would now go ashore. It was touch and go getting everything loaded; the sea didn't want to cooperate.

"When we arrived at Bounty Bay, the longboat engines were reversed just before we made the run in. It's very clever how they are so careful in making the run through the surf because the waves are always breaking. If they pick the wrong wave, it could break over the boat and cause it to capsize."

If you read "Pitcairn Island — an inside look at VR6TC," which I wrote for the March, 1977, issue of 73, you'll know what occurred

on June 23, 1972. On that date, a longboat attempted to go out in violent seas and was capsized. Tom broke his right leg and almost lost his life.

"We waited . . . and all at once the motor went wide open and, boy, there we went. It looked like we were riding a wave but had plenty of time to get in before the next wave came. We came in, scooted around the breakwater and then reversed the engine to keep from ramming ashore. Everyone got wet from the splashing water," Jules said, "even before we rushed into the bay."

Most of the cargo was taken ashore, with the exception of a 500-pound generator and the tower from Tri-Ex. These were brought in later. The tower was one that Frank W6KPC of Tri-Ex donated to Tom.

Jules met Andrew Young VR6AY, the first ham operator on Pitcairn (1938). They had worked each other in that same year. Jules said, "It was something meeting him. We had a very interesting conversation. He is a very jovial man."

Tom had his motorbike loaded up with cargo. "So much, in fact," Jules mentioned, "that I didn't think he would have room for me to get on, but he did . . . I didn't think we could get up the hill, but we chugged away. We almost lost our balance a couple of times, but we made it up. We went straight to Tom's home and unloaded.

"I met Tom's wife, Betty, a really pleasant person. I saw their little baby and the three other little girls. Tom then showed me his ham room and the room where I would spend the night."

If you read the March article on Tom you'll remember only three children being mentioned. I knew of the upcoming event but didn't mention it. On March 28, 1977, at 4:40 am Pitcairn time (1310 UT), Tom and Betty Christian became the proud parents of a 7 lb., 4½

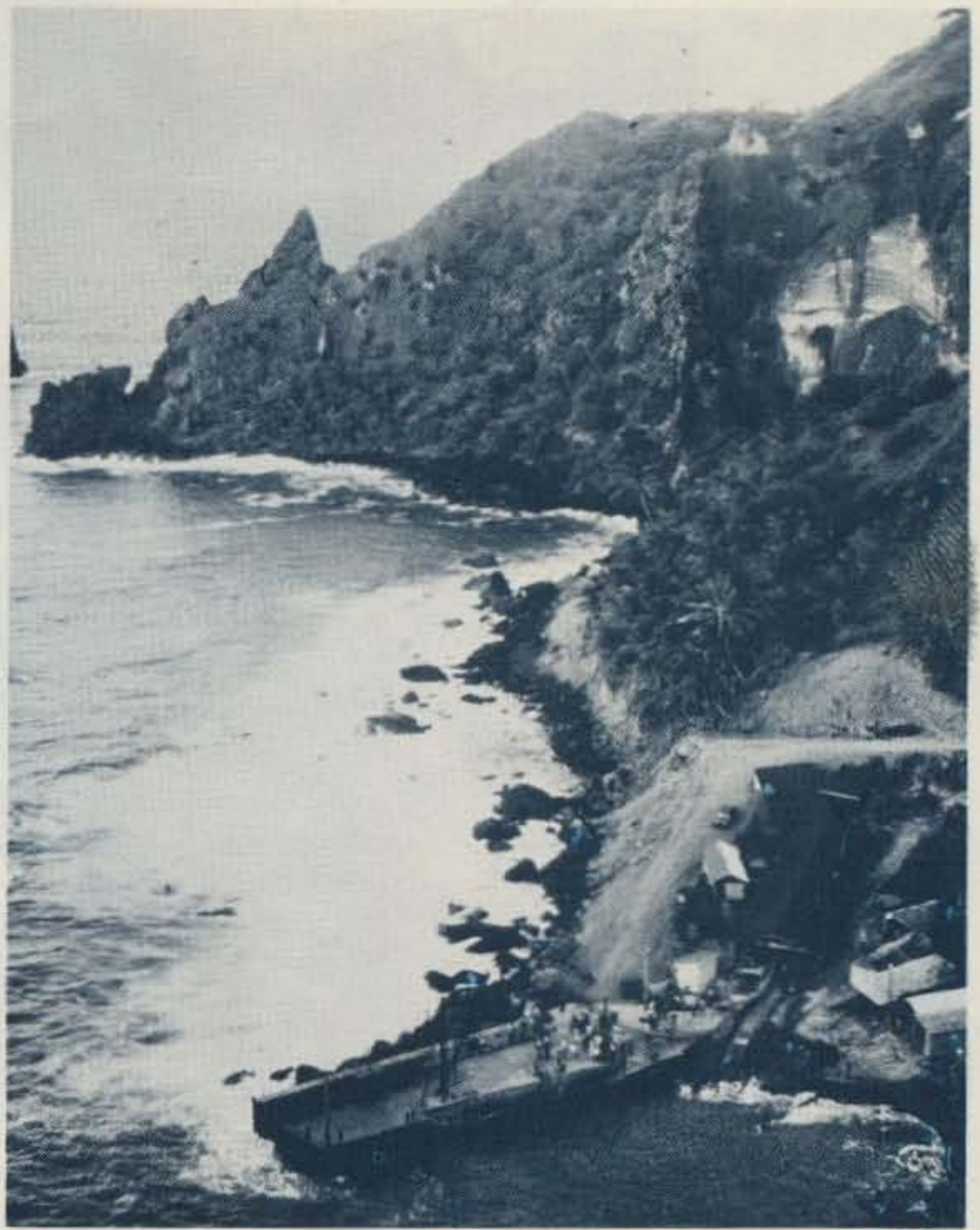

Bounty Bay, the only entrance and exit from Pitcairn Island. It was here on January 23, 1790, that the HMS Bounty was set afire and sunk. The ship was discovered in January, 1957, in less than 50 feet of water.

oz. baby girl whom they named Darlene Michelle. Congratulations.

"Tom had to go to the post office," Jules said, "so I rode with him on the motorbike and he dropped me off at the village square. I saw one of the most prized possessions of the island right here in the square — the *Bounty* anchor. It is a real relic.

"I heard a putt-putt-putt and saw Tom coming up past the square. He had a new beam antenna on the bike, driving with one hand and holding this twenty-foot-long box with the other as it was slung up over his shoulder."

A little later, Jules and Tom headed for the island's commercial radio station "ZBP." It is located at Taro Ground, about a mile and a half from the village of Adamstown.

"The station was at a good location; you could see the

ocean in practically all directions. It was a sight to behold. The buildings were nicely situated on several acres. Inside the station building was quite an installation of equipment. Most of the gear was in six-foot racks . . . I'm sure this equipment really sings when Tom gets on it. He has a good fast fist, even on the hand key." (Betty is one of Tom's staff members and she, too, operates this station. Her code speed is 25 wpm.)

Jules had received prior permission from Tom and the Administrative Headquarters, New Zealand, to operate amateur radio on Pitcairn.

On April 19 at 2315 UT, Jules made his first contact as W6YO/VR6. It was none other than Frank W6KPC of Tri-Ex Towers. His second contact was Dick W6OV from Jules's home QTH. Jules, Frank, Dick, and myself are all members of the Central



On the left is the first amateur radio operator on Pitcairn (no longer active), Andrew Young VR6AY. Next to him is Jules Wenglare W6YO, with Tom Christian VR6TC to his left. They are aboard the Yankee Trader, anchored off Pitcairn Island in the South Pacific.

Valley Radio Club, Inc., in Delano. Even though W6YO/MM and I had worked each other several times, and I was on the air when Jules keyed up for the first time on Pitcairn, I didn't get a W6YO/VR6 contact. I had to leave the air for an appointment after only a few minutes of trying. I guess it just wasn't my day.

Jules worked a VR3, UK9, VK2, FO8, JAs, and many U.S. hams, all on SSB. When he went down into the CW portion, the receiver would go dead. He finally had to give up on CW, temporarily. After supper, he tried the rig again — nothing. "I was set to stay up all night," Jules said, "and work as much as possible, but the propagation was gone; the band was dead. With no 40 meter antenna, there was nothing I could do."

At 1900 UT the following morning, W6YO/VR6 was back on the air. "I was on continuously until I left," Jules said. "But due to con-

ditions, I didn't work much. I had logged 303 contacts in eight hours of operation."

Jules worked SSB and CW on both 15 and 20 meters. He even listened for and CQed Novices only on 15. "The fellows really behaved well," Jules stated, "when I sent directional CQs."

Jules bid farewell to Betty, and he and Tom headed for *Bounty* Bay. "I was the last one to get aboard the longboat," said Jules. "It was a sentimental feeling stepping off, knowing that I was leaving Pitcairn soil."

Back on the *Trader* again, Jules talked to several of the islanders until it was time to leave. The island magistrate gave a little speech, and the islanders sang three songs. Then the captain thanked everyone for their hospitality. Tom and Jules shook hands for the last time and bid farewell. It was a very emotional moment for them.

In Jules's final comment, he said: "Tom's a wonderful person, very generous. Betty

is very charming and a wonderful cook. I'll never forget the hospitality that Tom and Betty extended."

Jules and Tom had a schedule set up for the following day, which they made. He said it was a relief to hear Tom, due to the rough seas and entry into *Bounty* Bay during darkness after the longboats left the ship. He also worked a 4X4 and an EA8, all with good reports.

On the night of April 22, en route to Tahiti, the *Trader* ran into a very bad storm. At 3 am the next morning, the first mate woke Jules and advised him that the captain would like to get some weather reports, if possible.

"I thought 20 meters would be dead at that time of the morning," Jules replied, "but it wasn't. I heard WB9HAK working ZL2NY, broke in, and asked for assistance in WX reports. WB0SQT broke and said he would call the weather control, which he did. Static made it almost impossible to

copy and was occasionally wiping out the signals. K4RTA and WASLEE came on and helped to relay. After a half hour, I finally got the reports which were gathered from the National Weather Service in Kansas City MO. I got the position of the center of the storm, direction of movement, and even what direction to go to get out of it."

That storm front was 200 miles wide, moving at a rate of 23 knots per hour with winds up to 60 knots.

"I am very proud of the ham fraternity who came to the rescue in getting these weather reports to us," Jules said. "It was very gratifying."

As the writer of this article, I believe this incident reflects the true spirit of amateur radio. This dedication so often displayed depicts the value of our fraternity. It makes me even more proud when I tell someone, "I'm a ham."

Talking on one of the tapes about the storm, Jules brought out this: "A 17-foot runabout with a big outboard motor was secured to the stern of the *Trader*. At about 5 am, I came down from the bridge and looked at it for awhile and it seemed to be riding pretty good. I went to my cabin and, shortly thereafter, I heard a big 'crunch.' I went out on the deck and saw that the boat had broken loose and was hanging by only one end. It was partly in the sea, just bouncing up and down. I summoned help and some of the crew members came out, but it was too late. The other end of the steel cable broke and off she went, free into the sea. We lost sight of it very quickly."

I found out from Tom VR6TC, during one of our QSOs, that this same storm hit Pitcairn pretty hard. He said that all transmission lines for the antenna system at "ZBP" were broken loose. The complete roof was lifted up and half of it ended up more than 100 feet away, and some water got inside the

station. Fortunately, no other damage was done to anything else on the island.

The *Trader* finally tied up at the main pier, downtown, Papeete, Tahiti. "We couldn't leave the ship," Jules stated, "until customs made their rounds. Someone came over to me and said a man was looking for me. I went over and here's this husky fellow who said he was Shan FO8DP whom I had talked to before on the air. We talked for awhile and later that evening met again.

"The next day, I went for a walk, and, a block and a half from the ship, I saw this tri-band antenna atop a second story building. I couldn't find a front entrance, so I went around back. I found some people, but they didn't speak English." (When there's a problem, leave it to a ham and he will come up with a solution. Jules did.)

"I said, 'Radio amateur?' This one chap goes, beep-beep-beep . . . beep-beep. I nodded my head yes and he pointed to a door leading inside. After entering, I talked to a woman, who didn't speak much English either. Finally, she called someone and out he came. He said he was Coco FO8BX. I said, 'My goodness, I've worked you many times and we've QSLed.'"

Jules spent some time with Coco working on his rig, which had quit a few weeks earlier. After replacing a few tubes and aligning it, Jules got the rig going again. That night, Jules went to the local radio club meeting and met about a dozen FO8 hams. He said it was a very enjoyable evening.

The next day, Geneclaud FO8EU came aboard the *Trader*. Later, Jules went to his home right up on top of a 900-meter-high mountain, a very nice place overlooking Papeete, with a straight shot in all directions. They checked the bands but found nothing into the States. About 10 pm, they both

came back to the ship and Jules gave him a QSL card for an earlier contact.

The *Trader* set sail about midnight, and, after two more ports of call, Huahine and Raiatea, and several ham contacts into Europe, Asia, and the Far East, the ship arrived at Bora Bora.

Jules spent several hours there snorkeling and saw some beautiful tropical fish. They were blue, orange, black, and even zebra striped. He said the fish were in abundance; some were almost transparent.

Along with another passenger, Jules took an excursion up a 700-foot-high mountain. "We found these two huge cannons," Jules said, "big 25-foot-long, 7-inch muzzle coastal guns overlooking the harbor. We walked down to an observation point and found the date, April 26, 1942, engraved in concrete. The view down to the village and harbor was absolutely beautiful."

Several of the passengers went to a luau at the Bora Bora Hotel. Jules said that some islanders came right up onto the beach in their outrigger canoes with flaming torches held in their hands. Since it was at night, the scene was even more dramatic.

At this point on the tape received from Jules, he said: "And here's a bit of the local native music." Well, I can't put music here, but I can say it was very beautiful — South Pacific style, with three electric guitars, drums, etc. It was recorded in the Bora Bora Hotel.

After three more days at sea, the *Trader* arrived at Rarotonga in the Cook Island group. After docking, Jules was summoned and introduced to Tuatai ZK1CY who wanted to meet the "ham" aboard. "Tuatai," Jules wrote, "is the island health officer, and he did look it in his neat Bermuda shorts, white socks, and shirt . . ."

Jules showed Tuatai his



Jules W6YO in the home of Tom Christian VR6TC. He logged 303 contacts using Tom's equipment when he operated here on Pitcairn as W6YO/VR6. Contacts were made using SSB and CW on 15 and 20 meters.

cabin and radio setup. He later realized that Tuatai was the most popular Pacific Island ham when he was on the island of Manihiki.

Later, at one of the buildings near town, Jules saw more than a dozen antennas scattered all around. Inside there were numerous pieces of equipment. The installation was that of Stuart ZK1AA, who wasn't there at the time. Jules left his QSL card with a note and headed back into town to eat.

A little later, Stuart found Jules, introduced himself, and said he found the QSL card and had been looking all over town for him. They both jumped on Stuart's motor-scooter and headed for the airport. Here, Jules met Trevor ZK1BA and another ham (no name or call given). They and a technician were working on a frequency counter that was giving them problems. Trevor is in charge of the communications and navigational aids department.

Jules spent most of the day with Stuart and later met his XYL, Terenpii. "Their home," Jules said, "is right on the beach on the north coast, a couple of miles from town. The satellite station Stuart operates and maintains is a complex setup of nearly a dozen antennas — yagis,

helixes, and even a rhombic, all for VHF communications with the ATS-1 satellite up 23,000 miles above the equator in the central Pacific area."

Terenpii handles the circuit with Suva, Fiji, and other outlying stations as far north as Alaska, the Western Carolines, and back east to Washington, D.C. Stuart has equipment from WWII and is still a firm user of time-proven older tube-type equipment for VHF work.

There's one more item that Jules mentioned that was very interesting. "In their home, Stuart has one of the largest great circle world maps I've ever seen. On their living room floor, inlaid in linoleum, is the map Stuart cut out, with Rarotonga in the middle."

The *Trader* finally set sail for Fiji and Jules got back on the air. "It is something," Jules wrote, "to listen at times in the morning and to hear a few stations coming through, only to be in 4X4 or SV land or some other place on the opposite side of the Earth. These South Pacific places must really have some wonderful propagation."

During one of my contacts with W6YO/MM3, he gave me some information and mentioned an unknown island

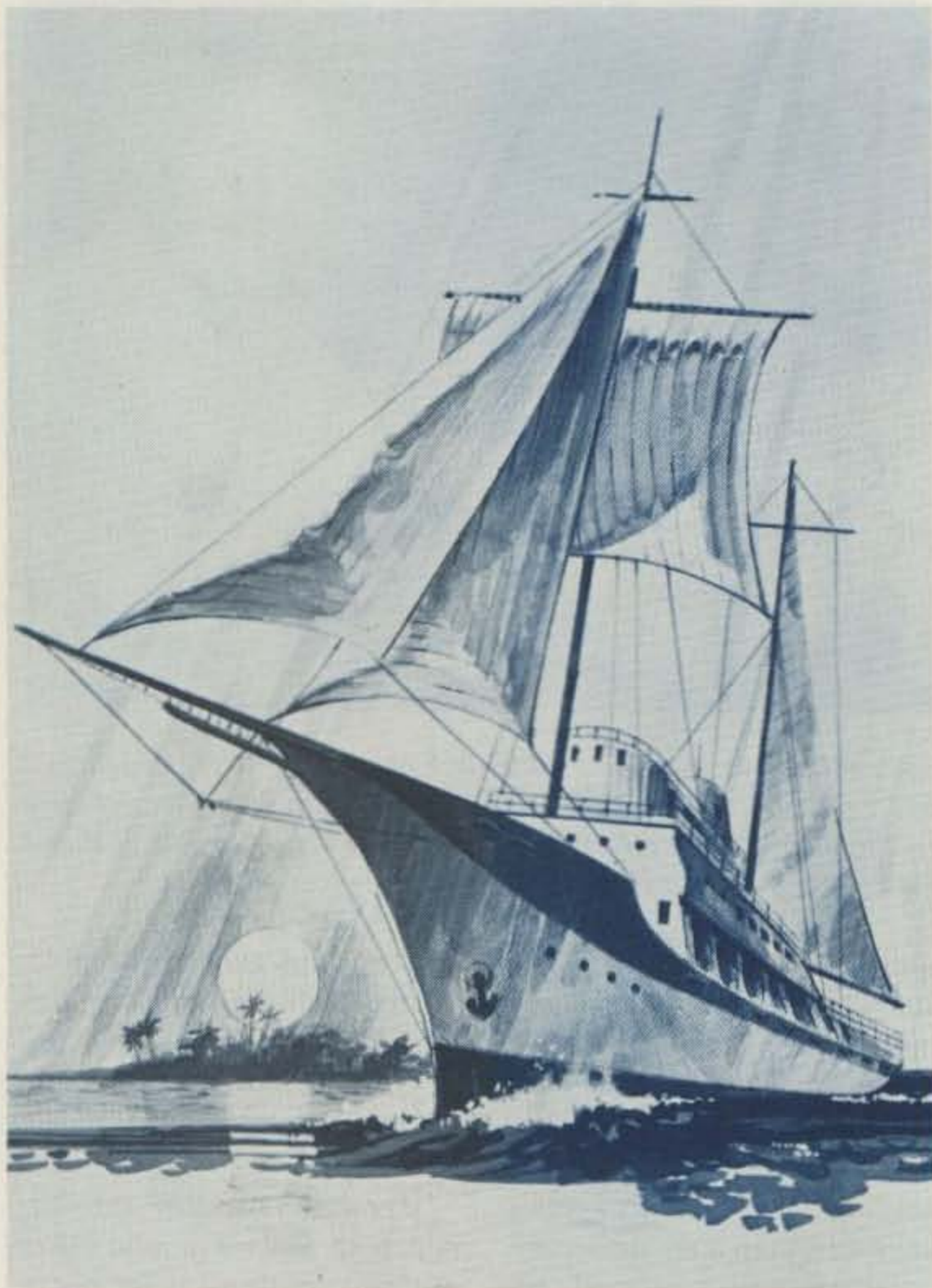

This is the motor yacht Yankee Trader. Each year she sets sail for a 10-month around-the-world cruise to strange and remote ports of call. For the year 1977, Jules Wenglare W6YO was the "ham" aboard. (Photo courtesy of Windjammer Cruises)

name. I didn't know where it was, so I asked him to spell it so I wouldn't make a mistake in identification or location. He told me I had better learn where these places were. In a letter received after that date, Jules wrote: "By the way, you'd better brush up on your geography. Any DXer should know these islands without me having to spell them out to you."

As much as I hate to admit it, especially here in print, he's right. And, I now have my second "Elmer." Thanks, OM.

"I was very fortunate to QSO Rod 3D2RM and Dale 3D2DM a few days prior to our arrival at Fiji. Rod was helpful in advising the Port Captain of our arrival and other pertinent information.

"Raj 3D2ER met me at the dock at Suva, Fiji, and

graciously drove me around to see their large satellite and communications system. The 80-foot satellite dish and what's under it was most interesting and educational. Raj," said Jules, "is a very knowledgeable engineer for cable and wireless..."

Jules visited with 3D2RM and his XYL, Lou. "He speaks seven languages," Jules said, "including Russian. He taught English before his assignment as a linguistics professor at the University of South Pacific, Suva."

One morning aboard the *Trader*, Jules had breakfast with Dale 3D2DM, a Yank working for the Peace Corps. "He spends time," Jules said, "teaching natives the care and maintenance of outboard motors."

Jules also met Upali, a 4S7 ham from Colombo, Ceylon.

Jules said, "With his beautiful hilltop location and know-how, he should become a big signal from Suva."

Before leaving Fiji, Jules was the dinner guest of Rod, Raj, and Upali. He said he had great praise for their lovely wives and children.

Captain Paul Maskell, Master of the *Yankee Trader*, had sailed his ship more than 10,000 miles before he brought her into port at Pago Pago, American Samoa. This would be the first port Jules could operate in other than Pitcairn.

After meeting Larry KS6DV at the pier, he met his XYL, Uti KS6FO. Both were to extend an ultimate offer of hospitality.

"They were wonderful," Jules wrote. "Larry let me operate his station right across the highway from the beach, four miles out of Pago Pago. Larry's ham shack is really a den, with a well-stocked bar, lounge, radio gear, 2-meter stuff, and loads of extra equipment, all in a paneled, blue-carpeted basement room. It was the first time in my life I had three drinks at once in front of me while working the gang back in the U.S.A.

"Their choice for dining out was the best place in Pago Pago — Soli's. The seafood dinner with wine was great. The four-piece band and smooth music added to the unique local charm and atmosphere."

While Jules was here on the island, he wanted to take a ride on the cable car that goes across the whole bay of Pago Pago up to a height of 1700 feet. When he got there, it was learned that they had experienced a power failure and the car was stuck midway across. Inside were a couple of the *Trader* passengers. They were suspended for over an hour before being rescued. Unfortunately, Jules didn't get to take this very scenic ride.

Before the *Trader* left, Larry and Uti spent some time aboard ship visiting with

Jules. They received a guided tour and saw the "ham headquarters" Jules uses in cabin 25 to work the operators around the world before he arrives there to meet them.

Jules didn't give too much information on his next few stops other than whom he met. On Apia, Western Samoa, he met Phil 5W1AU. When the *Trader* arrived on New Hebrides, Jules met Ken YJ8KM and his XYL, Marg. Later, he met Jock YJ8JH.

When Jules arrived in the Solomon Islands, he said, "It was great to receive permission to operate ashore from VR4-land." Wes VR4DX let Jules use his station, but the propagation wasn't very good. The two of them stayed up until 2 am chewing the fat and drinking tea. Jules also met Dick VR4DH and Barry VR4BT.

When the *Trader* dropped anchor at Port Moresby, New Guinea, Jules took a side trip by air to Australia. There he operated from the stations VK2AOK, VK2AHA, and VK2XT.

"While staying with Harold VK2AHA," Jules wrote, "he had me make two tapings at the broadcast station where he and his son, Allan, are on the technical staff. One tape was an interview regarding my recent visit on Pitcairn Island with Tom Christian VR6TC. Another tape was for the Hunter Branch of the Wireless Institute of Australia, Newcastle, N. S. W., Amateur Radio Club."

Jules spent some time in Sydney, Newcastle, Ipswich, and Gold Coast, Queensland. He met some more hams, such as VK4KO and VK4MW. After catching the *Trader* in Darwin, Australia, he set sail for Bali, Indonesia.

In issue #7 of the *Trader Tales* (the newsletter printed aboard ship), Jules wrote an article. Here is part of it:

Maritime Mobile.

"This is the designation used by hundreds of amateur radio operators who utilize their as-

signed radio call letters when transmitting aboard any type of floating vessel. . . .

"As of July 4th, aboard the *Yankee Trader*, I have made over 125 phone patches for 48 of the passengers and 2 crew members, logging over 500 hours on the air during 1600 hours at sea and several ports of call.

"Official permission was granted to use my callsign on the 5th day side trip in the Galapagos Islands, also at Pitcairn, New Hebrides, Solomons, Papua, New Guinea Islands, and Darwin, Australia.

"Some 1550 contacts, mostly on single sideband and CW, have been made (including 300 ashore on Pitcairn) with 70 countries; the majority were with the United States. One con-

tact was with a ham station at the South Pole.

"Also I have had eyeball (meeting a ham in person) contacts with 56 radio amateurs at their homes and radio clubs.

"The best known hams I met were Tom Christian VR6TC on Pitcairn and Father Dave Reddy CEØAE on Easter Island."

At 1742 hours on July 5 — after sailing some 15,237 miles since leaving Freeport in the Bahamas — the *Trader* anchored off Benoa Port, Bali, Indonesia.

One of the things Jules did here was see the "Ketchak" (monkey) dance, a Hindu dance depicting one of the stories of this country. He also, by way of a very narrow road, journeyed to the rim of Mt. Batur, a volcano. Lake Batur, about two miles in length, is inside this

large crater.

Jules spent about a week here on Bali and took in many of the sights and attractions on this very colorful island. There were people everywhere, with dozens and dozens of them selling carvings and souvenirs. "It was almost impossible," Jules said, "to get away from them." But he did, only after adding some souvenirs to his own collection. He even had time to do some more snorkeling at one of the beaches.

Every time Jules went anywhere on Bali, he looked for a ham antenna but had no luck. There were no hams to be found.

For Jules Wenglare W6YO, the 5 months to that point had been a "ham paradise" aboard the *Yankee Trader* on this 10-month around-the-world cruise. He met many people in amateur radio during stops at exotic ports of call along the way. But, we've got a long way to go before the list is complete.

The following is an excerpt from a tape recording made of several hams when Jules was in the home of John Lamar 4S7JD. All will appear in part 3 of this story.

"Good evening, friends. This is 4S7 Victor George, and we are having a very fine time with old man Jules here. I would hope to meet many of the boys on the air soon. 73 and wishing you eyeball from Sri Lanka. 4S7VG, off."

When the *Trader* docked at Male, Maldives, Jules was told by customs that no transmissions of any type were allowed from the island or from a ship in the harbor. This didn't stop him from trying to obtain permission to operate amateur radio from here. He went to the Director of Communications and . . . well, when you read the next installment, the whole story of 8Q will unfold.

See you next time with W6YO, when the *Yankee Trader* drops anchor in Singapore. ■

There's a new, eighth OSCAR satellite in orbit, and the AMSAT team helped put it there!

Your help is needed for future satellites. Join AMSAT and support the new, advanced Phase III series of OSCARs, engineered to provide communications over transcontinental distances for hours at a time.

Send \$10 membership dues to AMSAT, P.O. Box 27, Washington, D.C. 20044. Life membership is available for a tax-deductible donation of \$100 or more, payable in quarterly installments if you wish.

Phase III satellite solar cells may be sponsored for \$10 each, and we'll send you a certificate specifying the cells you are sponsoring.

For a tax-deductible contribution of \$1,000 or more, we'll even inscribe your name on a plaque to be placed in orbit aboard the Phase III spacecraft for posterity, and we'll send you a replica honoring your contribution.

Dues and contributions may be charged to VISA or Master Charge. Phone us at (202) 488-8649.

Radio Amateur Satellite Corporation
P.O. BOX 27, WASHINGTON, D.C. 20044



50 144

REPEATERS

220

450 Mhz

Available Separately:

COR Identifier: All on one board, programmable, Fully adjustable, time out (.5-7 min.), hang time (0-1 min.), identifier (1-10 min.), tone, speed, volume, L.E.D. outputs, low current drain CMOS logic, plugs for easy installation and removal plus much more. \$79.95

Basic Repeater \$499.95

2M 130-175 MHz Basic Repeater for 2 meters with all the features of the Hi Pro Mk I less the power supply and front panel controls and accessories.

OPTIONS

Duplexers
Basic auto patch
Matching cabinet
.0005% High stability crystals

Hi Pro Mk I

50 MHz \$789.95 450 MHz 799.95

144 + 220 MHz \$699.95 PLUS SHIPPING PA Res. add 6% tax



Maggiore Electronic Laboratory

845 WESTTOWN RD.

WEST CHESTER, PA. 19380 PHONE 215 436-6051

"Look What Followed Me Home!"

—a PET of your very own

About four years ago, the company I worked for bought a desk-top computer which had BASIC on ROM, a line printer, and 8K bytes of RAM. It was a superb machine and soon paid for itself in saved time-sharing charges. It cost \$13,000. From the first day I saw it, I have been looking for the same sort of thing at a personally-affordable price. About a year and a half ago, I began seeing news releases about a personal computer to be introduced by Commodore Business Machines.

If I could believe half of what I read, the new machine, called a PET, was just what I'd been looking for. It was going to be a desk-top computer, self-contained, with a full keyboard, built-in-cassette, 40 x 25 character display, 8K BASIC on ROM, 4K (8K optional) of RAM, and many other goodies.

The first announcements predicted a \$500 price and "midsummer" deliveries. By midsummer, the price

had gone to \$595 (\$795 for the 8K option) and delivery was "90 days." One of the guys I work with brought back some literature from a computer show which included an order form. On July 25, 1977, I summoned up my courage and \$595 and sent in the order.

The 90 days came and went and several letters came from Commodore, keeping me informed of delays. Having witnessed a few new-product introductions from the inside, I was not surprised at the frequent revisions of the expected delivery date. In November, they announced that they were going to concentrate on getting out the 8K versions first and offered to let me order the more expensive version. I hung on grimly to my original 4K order and finally my patience was rewarded.

I seemed to hear the faint jingling of sleigh bells as I drove down to pick up my package on Christmas Eve. It had been a long wait, but I was sure it

would prove worthwhile.

The machine was packed very professionally with molded foam supports and lots of "crush space" in the heavy cardboard box. I pulled it out, plugged it in, and turned it on (after finding the switch, which is located on the back panel, safe from accidental turn-offs). After waiting a few seconds to warm up the CRT, there it was:

```
***COMMODORE BASIC***  
3071 BYTES FREE  
READY
```

The cursor blinked invitingly. I dived for the instruction book and came up almost empty-handed. The only book was a small "temporary" pamphlet which did little more than list the BASIC commands and statements. The user who is unfamiliar with BASIC will need a good instruction book to learn from. The "real" booklet, which came a few weeks later, also assumes that you know BASIC, but lists a number of suitable in-

troductory books on its last page.

Since I knew enough BASIC to get along, I was soon programming away like mad. It was kind of fun to find out for myself some of the things the manual didn't mention. I've had the PET for almost a year now, and am still finding cute things to do with it. I think it's just great. Commodore can't fail to sell these things as fast as they can turn them out.

It seems to me that when future historians talk about the computer revolution, they will date its beginning from the introduction of the PET. This kind of self-contained machine is what will bring personal computing power to the public. To paraphrase somebody or other, "I have seen the future—and it RUNS!"

Let's talk about the PET in a little detail. First we'll look at the hardware.

The case is fabricated from steel, with flat, planar surfaces instead of the curved ones of the plastic case. It looks very good

and rather expensive. I imagine (on the basis of absolutely no hard knowledge) that Commodore has had production or supplier problems with the plastic cases and is using metal only as a temporary measure. Four screws under the edge of the case are easily removed to give access to the "innards." The keyboard and display hinge up and a handy built-in prop keeps them from falling back down while you're working inside.

The cassette recorder utilizes the housing and mechanical components from an ordinary cassette recorder. The case is still marked "condenser microphone" where the mike used to be. The cable attaching the cassette to the computer PC board is a bit short, and should be disconnected before opening the case fully. The early literature promised a "cassette drive modified by Commodore for much higher reliability..." but it just looks like an ordinary drive to me. The standard electronics has been replaced by a Commodore circuit board, and that certainly looks more reliable than the usual solder-blobbed phenolic PC board.

The power supply looks simple and rugged, but I have made no tests and have no idea whether it will also supply power for accessories. I would guess not, since none of the accessory connectors seem to have power supply connections.

The video unit is enclosed in its own housing at the top of the computer. The only control is for brightness, and it is accessible from the back of the cabinet. The display is sharp, clear, and flicker-free. It is usually one of the first things mentioned by people seeing the PET for the first time.

The computer itself con-



Photo 1. External appearance of the PET, showing keyboard, cassette, and display.

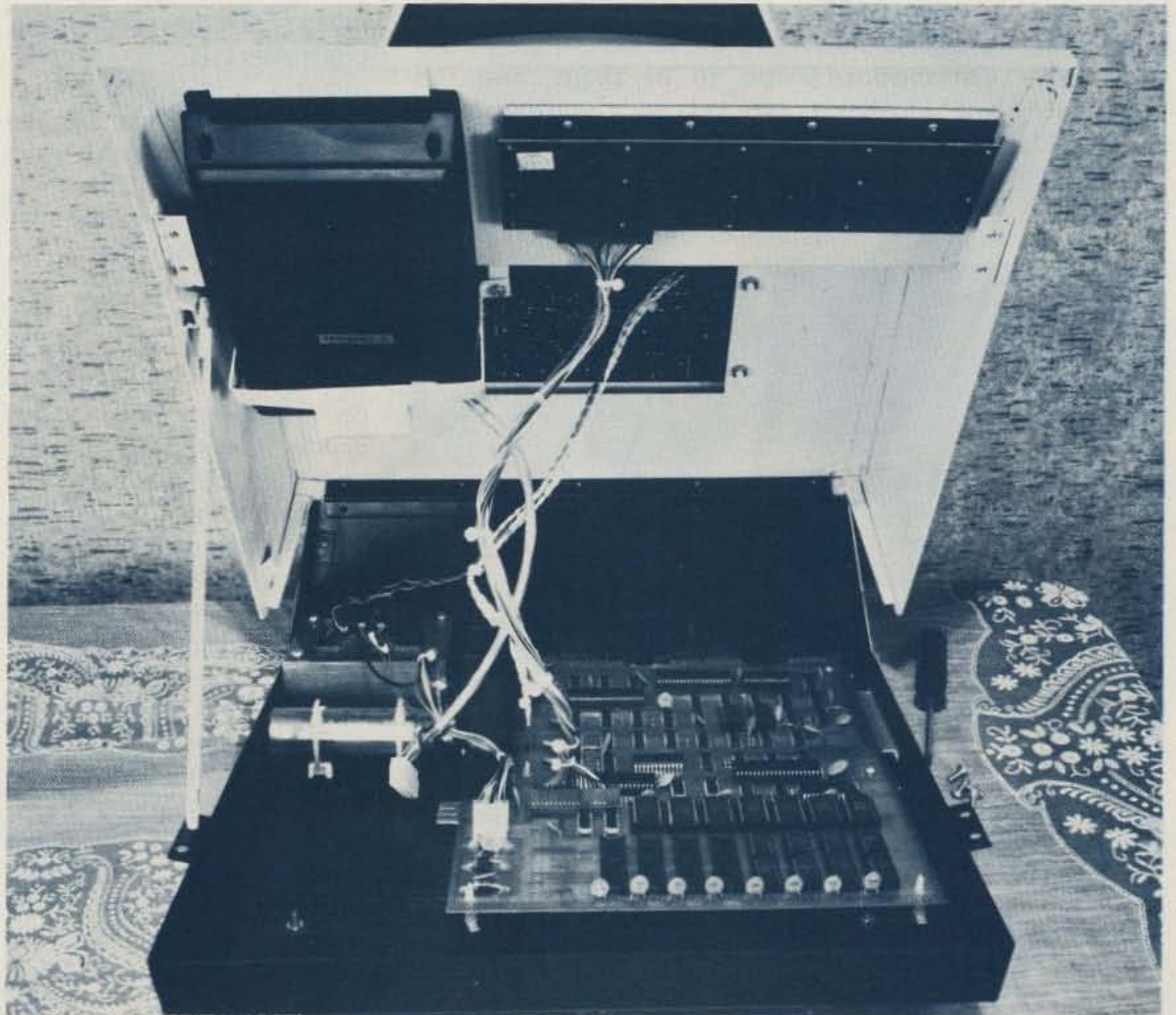

Photo 2. View of interior case. Note single-board CPU, simple power supply, cassette recorder mounted by a bracket, and general ease of access.

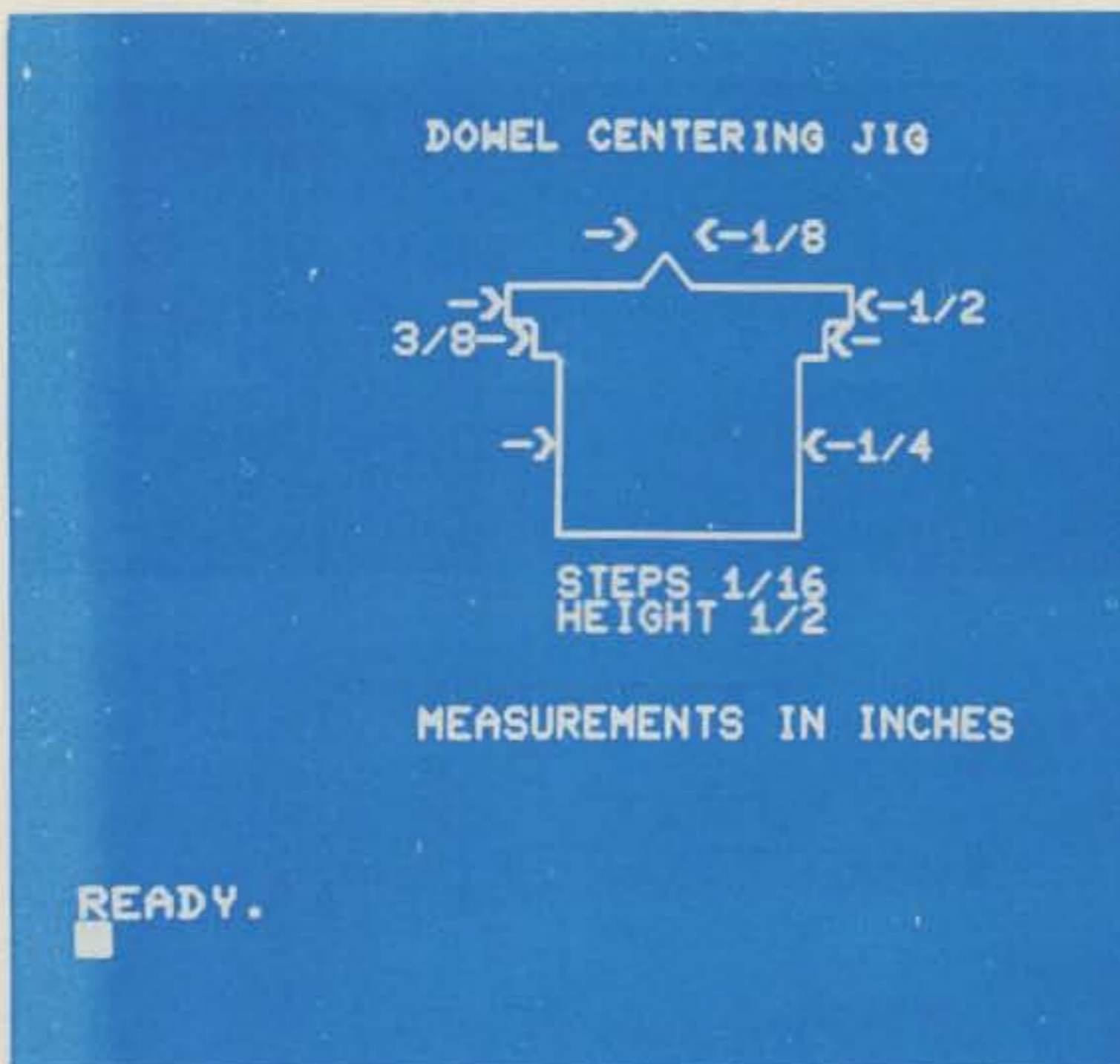

Photo 3. Sample of PET graphic capability. Courtesy of Paul Davis.

sists of one PC board holding about 70 integrated circuits, of which a surprising (to me) number are ordinary 74LS-series. The microprocessor is a MOS Technology 6502. (MOS Technology is now owned by Commodore.) There are two 6520s, a 6522, and 8 ROM chips. Seven of the ROMs make up the 14K bytes of ROM

programming, while the eighth, all by itself away from the others, must be the character generator for the display. The RAMs are eight MPS6550 chips at the front edge of the board. On the 8K version, there would be 16 of them, and the sockets for the other 8 are already there on the 4K machine. The instruction booklet suggests a method

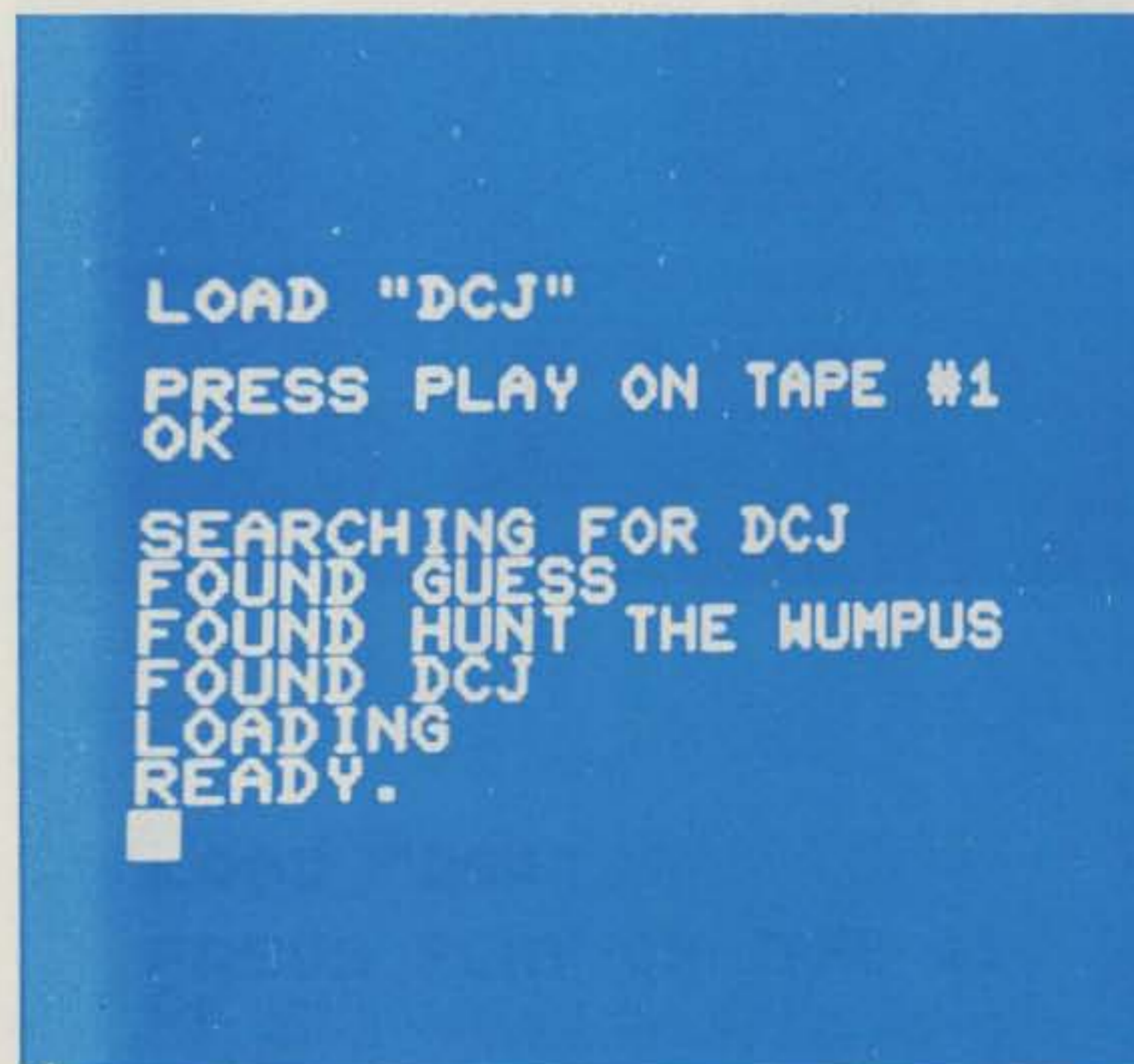

Photo 4. Video display showing sequence of operations to load a program "DCJ." Programs preceding it on the tape are listed, but not loaded. Sequence is fully automatic after user presses "PLAY."

of locating the bad chip if you should have memory trouble. When the machine is turned on, it will print a message giving the number of bytes of RAM available. If a chip is bad, that chip and all the ones at higher addresses will not be counted. By noting the number of bytes available and exchanging chips, the bad one can be quickly located.

Along the back edge and right-hand side of the board, pins are brought out through the cabinet to connect external devices. Across the back are a second cassette interface, a 24-contact parallel user port, and an IEE-488 interface. The connector on the side is a 40-contact memory expansion port.

The IEE-488 bus is a unique feature of the PET and should make it very attractive to industry. Also known as the GPIB and HPIB, it is a standard means of interconnecting controllers (such as computers) and instruments (such as programmable counters and digital voltmeters) so that an endless variety of automated test setups can be made by simply connecting the proper instruments to the bus. All the programming, sequencing, calculations on measured data, go/no-go decisions, and so forth can then be made by the controller, which is programmed quickly and simply, often in BASIC. Almost every instrument introduced in the last few years can be supplied with IEE-488 bus capability.

The bus has dedicated lines for addressing up to 15 devices. Data is transferred over another eight parallel lines, a byte at a time. Most of us don't need (and can't afford) the kind of test equipment used with this bus, but there's no law that says you can't have a printer or high-speed tape reader designed

to work with the bus.

The memory-expansion connector has enough select lines to address 44K bytes of memory (100 through BFFF).

The quality of materials and workmanship seems to be quite good, especially for an early production unit. So far, I have found only one manufacturing defect. When it arrived, the keytops for C and D were reversed. These are printed aluminum squares glued to the tops of the keys. D was loose and easy to remove, but C took some prying. I pressed them back in their proper places and the adhesive seemed to hold. They have held in warm, humid conditions with no sign of loosening, and I have stopped worrying about them. I thought I had another problem when the clear plastic sheet covering each keytop began peeling off, but the booklet explained that it was just for protection during shipping and is supposed to be removed by the user.

So far, I have refrained from saying anything about the keyboard. People are either indifferent to it or they hate it. I hate it. It is nicely made, QWERTYUIOP and so forth are in the right place, but it is *too darn small*. There isn't enough room for your fingers to go where they should. You cannot touch-type on it. If you hunt and peck, it doesn't make much difference, but I believe everyone (especially computer nuts) should be able to type.

The keyboard is a matrix type, laid out as 10 x 8 lines. It would be very easy to connect a full-size keyboard in parallel with the original, so you could type on the full size and do graphics on the original.

Let's move on to the software. Fig. 1 is a rough map of the memory.

The instruction booklet

SALE S-100 BUS EDGE CONNECTORS SALE

NLS MS-215 DUAL TRACE MINISCOPE \$435.00



1c SALE

- LM3A 3 dig 1% DC \$134.00
- LM3.5A 3 1/2 dig .5% DC \$158.50
- LM40A 4 dig .1% DC \$209.00
- LM4A 4 dig .03% DC \$250.00
- Rechargeable batteries and charger included
- Measures DC Volts, AC Volts, Ohms and Current
- Automatic polarity, decimal and overload indication
- Rechargeable batteries and charger
- Measures DC Volts, AC Volts, Ohms and Current
- Automatic polarity, decimal and overload indication
- No zero adjustment and no full-scale ohms adjust
- Battery-operated — NiCad batteries; also AC line operation.
- Large LED display for easy reading without interpolation
- Size: 1.9"H x 2.7"W x 4"D
- Parts & labor guaranteed 1 year
- Tilt stand option \$ 3.50
- Leather case \$20.00

Purchase any of the LM series Meters and buy the LEATHER CASE for 1c



MS-15 MINISCOPE With Rechargeable Batteries & Charger Unit

- 15 megahertz bandwidth.
- External and internal trigger.
- Time base — .1 microsec. to 0.5 Sec/div - 21 settings ±3%.
- Battery or line operation.
- Automatic & line sync modes.
- Power consumption < 15 watts.
- Vertical Gain — 21 to 50 Volts - 12 settings ±3%.
- Viewing area 1.1" x 1.35".
- Case size 2.7"H x 6.4"W x 7.5"D, 3 pounds.
- Parts & Labor guaranteed 1 year
- 10 to 1, 10 meg probe
- Leather carrying case

PROBE 1c with the purchase of SCOPE and the MENTION of this MAGAZINE

MS-215 Dual Trace Version of MS-15 \$435.

3 LEVEL GOLD WIRE WRAP SOCKETS

Sockets purchased in multiples of 50 per type may be combined for best price.

| | 1-24 | 25-49 | 50-99 | 100-249 | 250-999 | 1K-5K |
|---------|------|-------|-------|---------|---------|-------|
| 8 pin* | .41 | .38 | .35 | .31 | .27 | .23 |
| 14 pin* | .39 | .38 | .36 | .32 | .29 | .27 |
| 16 pin* | .43 | .42 | .39 | .35 | .32 | .30 |
| 18 pin | .63 | .58 | .54 | .47 | .42 | .36 |
| 20 pin | .80 | .75 | .70 | .63 | .58 | .53 |
| 22 pin* | .90 | .85 | .80 | .70 | .61 | .57 |
| 24 pin | .90 | .84 | .78 | .68 | .63 | .58 |
| 28 pin | 1.10 | 1.00 | .90 | .84 | .76 | .71 |
| 40 pin | 1.50 | 1.40 | 1.30 | 1.20 | 1.04 | .89 |

All sockets are GOLD 3 level closed entry * End and side stackable. 2 level. Solder Tail, Low Profile, Tin Sockets and Dip Plugs available. CALL FOR QUOTATION

LIQUID CRYSTAL DIGITAL CLOCK-CALENDAR

- For Auto, Home, Office
- Small in size (2x2 1/2 x 1/2)
- Push button for seconds release for date.
- Clocks mount anywhere with either 3M double-sided tape or VELCRO, included.
- 2 MODELS AVAILABLE
- LCD-101, portable model runs on self-contained batteries for better than a year.
- LCD-102, runs on 12 Volt system and is back-lighted.
- LCD-101 or LCD-102 your choice

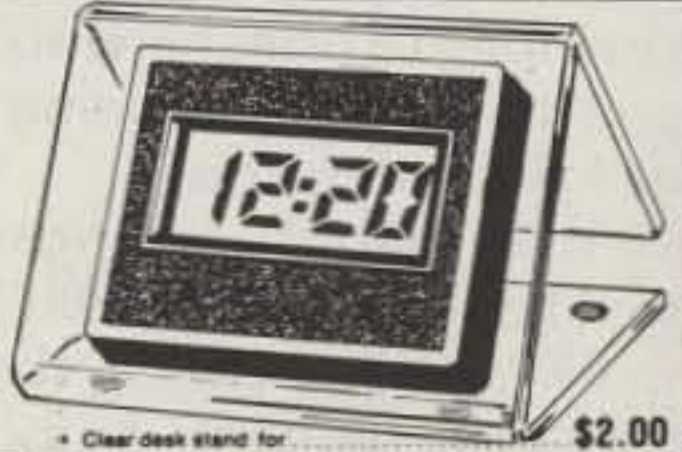

\$34.95 ea. Clear desk stand for \$2.00

SALE S-100 BUS EDGE CONNECTORS SALE

| Part No. | Description | Price |
|---|--|----------------------|
| S100-WWG 50/100 Cont. 125 ctrs. 3 LEVEL WIRE WRAP .025" sq posts on 250 spaced rows. GOLD plated. | S100-STG 50/100 Cont. 125 ctrs. DIP SOLDER TAIL on 250 spaced rows for VECTOR and MASI motherboards GOLD plated. | \$4.00 \$3.75 \$3.50 |
| RGB1G 50/100 Cont. 125 ctrs. DIP SOLDER TAIL on 140 spaced rows for ALTAIR motherboards. GOLD plated. | R681-3 50/100 Cont. 125 ctrs. PIERCED SOLDER EYELET tails. GOLD | \$5.00 \$7.35 |
| R644-G 22/44 Cont. 156 ctrs. PIERCED SOLDER EYELET tails. | R644-3 22/44 Cont. 156 ctrs. WIRE WRAP tails. GOLD | \$4.71 |

Other Popular Edge Connectors

| | | |
|---|--|--------|
| R644-G 22/44 Cont. 156 ctrs. PIERCED SOLDER EYELET tails. | R644-3 22/44 Cont. 156 ctrs. WIRE WRAP tails. GOLD | \$4.71 |
|---|--|--------|

ATTN: OEM'S and Dealers, many other connectors available call or quotation.

8803 MOTHER BOARD FOR S100 BUS MICRO-COMPUTERS

- All includes 12 tantalum capacitors for +5, +12, -12 buses and insulated mounting spacers.
- Wiring side shown. Component side bare epoxy glass with white markings for component locations.
- S10 epoxy glass board with 2 ounce copper, solder plated and .038 diameter holes for leads.
- Solder mask with solder windows on etched circuits to avoid accidental short circuits.
- Mounts 11 receptacles with 100 contacts (2 rows) on .125 centers with 250 row spacing. Vector part number R681-2, or mounts 10 receptacles plus interconnectors to smaller mother board for expansion.
- Includes etched circuits and instructions for options of active, pull-up, or floating terminations.
- Large buses: +5V and GND (10 AMP), ±12V or 18V (2 AMP). Current ratings are per MIL-STD-275 with 10°C rise.
- Fits in Vector-pak enclosures.
- Fits in IMSAI 8080 microcomputer as expander board.

Price: \$29.50

Vector Plugboards

8800V Universal Microcomputer/processor plugboard, use with S-100 bus. Complete with heat sink & hardware. 5.3" x 10" x 1/16"

| | | |
|---------|---------|---------|
| 1-4 | 5-9 | 10-24 |
| \$19.95 | \$17.95 | \$15.95 |

8801-1 Same as 8800V except plain; less power buses & heat sink

| | | |
|---------|---------|---------|
| 1-4 | 5-9 | 10-24 |
| \$14.95 | \$13.45 | \$11.95 |

3682 9.6" x 4.5" \$10.97

3682-2 6.5" x 4.5" \$9.81

Hi-Density Dual-In-Line Plugboard for Wire Wrap with Power & Grd. Bus Epoxy Glass 1/16" 44 pin con. spaced .156

3677 9.6" x 4.5" \$10.90

3677-2 6.5" x 4.5" \$9.74

Gen. Purpose D.I.P. Boards with Bus Pattern for Solder or Wire Wrap. Epoxy Glass 1/16" 44 pin con. spaced .156

3662 6.5" x 4.5" \$7.65

3662-2 9.6" x 4.5" \$11.45

P pattern plugboards for IC's Epoxy Glass 1/16" 44 pin con. spaced .156

3690-12 CARD EXTENDER

Card Extender has 100 contacts-50 per side on .125 centers-Attached connector-is compatible with S-100 Bus Systems.....\$25.00

3690 6.5" 22/44 pin .158 ctrs. Extenders.....\$12.00

1/16" Vector BOARD

.042 dia holes on 0.1 spacing for IC's

| Phenolic | Part No. | Size | 1-9 | 10-19 |
|----------|------------|----------|--------|-------|
| | 64P44XXXP | 4.5x6.5" | \$1.49 | 1.34 |
| | 169P44XXXP | 4.5x17" | \$3.51 | 3.16 |

| Epoxy Glass | Part No. | Size | 1-9 | 10-19 |
|-------------|----------|----------|--------|-------|
| | 64P44 | 4.5x6.5" | \$1.70 | 1.53 |
| | 84P44 | 4.5x8.5" | \$2.10 | 1.89 |
| | 169P44 | 4.5x17" | \$4.30 | 3.87 |
| | 169P84 | 8.5x17" | \$7.65 | 6.89 |

SLIT-N-WRAP

Wraps insulated wire on .025" square posts FOUR TIMES FASTER than regular manual wrap-and-lead tools

P180 with two 100' spools of 28 ga. wire \$24.50

P160-4T Includes charger, wire \$75.00

NO PRE-STRIPPING* NO PRE-CUTTING* SPOOL-FED WIRE

*The spooled wire passes through the tool past a slitting edge next to the wrap post. A narrow longitudinal cut is made in the insulation where it presses the square post corner. The bare copper is initiated by the sharp edge. (7 turns = 28 contacts)

Insulation is slit where wrapped but not between terminal points when 90° straight out of the tool

SLIT-N-WRAP WIRE NO. 28 GAGE INSULATED WIRE, 100' SPOOLS

W28-2-A-Pkg. 3. Green W28-2-C-Pkg. 3. Clear W28-2-B-Pkg. 3. Red W28-2-Pkg. 3. Blue

2708 8K 450 ns EPROM

FACTORY PRIME \$9.00 EA.

25 + Call For Price

14 & 16 PIN GOLD 3 LEVEL WIRE WRAP SOCKETS

14 - G3 100 for \$30.00

16-G3 100 for \$30.00

50 of each for \$32.00

Sockets are End & Side stackable, closed entry

PANAVISE

P.C. BOARD HOLDER 315 PRICE: \$16.95

315-S same as 315 but with 14" bar to accommodate "S100" boards. PRICE: \$17.95

STANDARD VISE HEAD 304 PRICE: \$12.95

HORIZONTAL JAW VISE HEAD 304 PRICE: \$12.95

STANDARD VISE HEAD 303 PRICE: \$12.95

VISE HEAD (Screws and Tin) 303

LOCK SCREW BASE 303

PANAVISE TILTS, TURNS, AND ROTATES TO ANY POSITION. IT HOLDS YOUR WORK EXACTLY WHERE YOU WANT IT.

LOW-PROFILE BASE 305 PRICE: \$11.95

STANDARD BASE 300 PRICE: \$11.95

VACUUM BASE 380 PRICE: \$16.95

WIDE OPENING VISE HEAD 366 PRICE: \$12.95

LEDU MG 10A

Perfectly balanced, fluorescent lighting with precision magnifier lens. For prof'l, techn'l & hobbyist. Has die cast protective shade, inst. start 3 diopter lens. 42" reach.

\$44.95

with T-8 fluorescent lamp (included) \$48.95

Colors: Gray or Black Chrome or Brown 2 CHOICES

\$44.95 SPECIAL

SC-5 With Rechargeable Batteries & Charger Unit \$98

FM-7 With Rechargeable Batteries & Charger Unit \$215

Features include: * By using the new NLS SC-5 Prescaler, the range of the FM-7 Frequency Meter, which is 10 Hz to 60 MHz, may be extended to 512 MHz (the upper VHF & UHF frequency bands). * The FM-7 utilizes an LED readout, providing 7-digit resolution. * The FM-7 can be calibrated to an accuracy of 0.00001%. * The SC-5 is accurate to one part per million. * Each unit has 30 millivolts sensitivity, is battery powered and has a charger unit included. * Dimensions of each are 1.9" H x 2.7" W x 3.9" D. * The units may be obtained separately or as a "Frequency Duo." * Parts & Labor guaranteed 1 year.

Tilt stand option..... \$ 3.50

Leather case..... \$20.00

Price Breakthrough! \$17.50

MA1003 CAR CLOCK

Bright Green Fluorescent Display Crystal Time Base Assembled, just add switches and 12 VDC.

SPECIAL

14CS2 100 for \$14.99

16CS2 100 for \$16.99

14 pin CS2 10 for \$2.99

16 pin CS2 8 for \$2.99

These low cost DIP sockets will accept both standard width plugs and chips. For use with chips, the sockets offer a low profile height of only .125" above the board. These sockets are end stackable.

Vector WRAP POST

for .042 dia. holes (all boards on this page)

T-44 pkg. 100 .. \$ 2.28

T-44 pkg. 1000 .. \$14.00

A-13 hand installing tool \$ 2.80

PRIORITY ONE ELECTRONICS

10031 W Woodley Ave. Sepulveda CA. 91343

Terms: VISA, MC, BAC, check, Money Order, C.O.D., U.S. Funds Only. CA residents add 6% sales tax. Minimum order \$10.00. Orders less than \$75.00 include 10% shipping and handling; excess refunded. Just in case please include your phone no. "Sorry, no over the counter sales"

GOOD THRU NOVEMBER 1978

phone orders welcome (213) 893-8202

OEM and Institutional inquiries invited.

24 PIN DIP PLUGS WITH COVERS

3 / \$1.00

40 / \$10.00

SALE S-100 BUS EDGE CONNECTORS SALE

NLS MS-215 DUAL TRACE MINISCOPE \$435.00

gives no hint on how to use the machine-language monitor or the diagnostics.

The more I use the PET's BASIC, the better I like it. Calculations seem to be made to 10 significant digits, then rounded to nine for display. The largest number it will handle is about 10^{38} , the smallest positive number is about 3×10^{-39} . Floating-point, integer, and string variables can be used.

A complete list of the BASIC commands would be too long to print here, so Fig. 2 just mentions some that I find interesting.

Arithmetic functions are: ABS, ATN, COS, DEF FN, EXP, INT, LOG, RND (generates random numbers), SGN, SIN, and TAN. Trig functions are all in radians. If x is in degrees, use, for example, $\text{SIN}(\pi * X / 180)$.

Other commands are: PEEK, POKE, ON...GOTO, LEFT\$, MID\$, RIGHT\$, and LEN.

Logical expressions, such as $(X > Y)$ or $(A \text{ AND NOT } C)$, are given the value 0 if they are false, and given the value -1 if they are true. It seems like 1 would have been more "logical" for true, but that's not the way it is. This feature can be used in the following way: Suppose you want to go to line 1300 if A equals 0 and line 1330 otherwise. You could write: 1200 GOTO (1330 + 30 * (A = 0)).

Several "benchmark" programs have appeared which have been run and timed on various computers. Included in the list is a prototype PET. I ran the same programs on mine, and they all ran about 10% slower than the times given for the prototype. (With its built-in clock, the PET can be made to very neatly time itself.) I am happy with the speed. One observer (who is in a position to know) told me that it ran faster than a PDP-8.

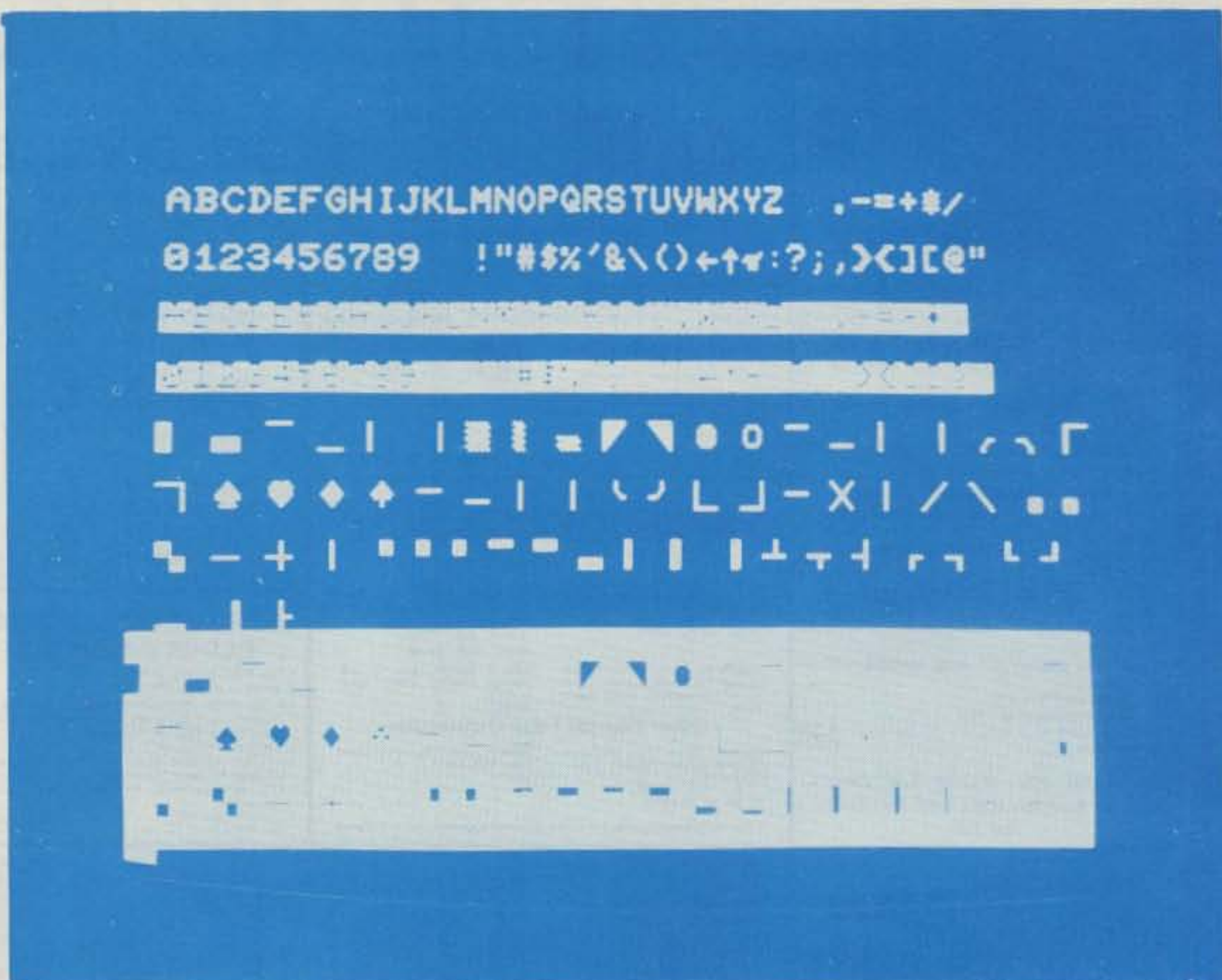

Photo 5. Display of the PET character and graphic symbol set.

The command PRINT is abbreviated by $?$, which is a real time-saver when writing programs. When the program is LISTed, PRINT is printed out in full. By using $?$, it is possible to use the PET as a scientific calculator. When you type $?$ followed by an arithmetic expression, hitting RETURN causes the value of the expression to be printed. For example, $?5 - 3$ RETURN causes 2 to be printed.

If you have hit STOP in the middle of a program and want to find the values of certain variables at that point in the program, say X , $X1$, and C , just type $?X, X1, C$ RETURN and they will be printed out. Then type CONT and the program continues from where it stopped. Great for debugging.

Editing lines is very easy. The cursor moves up, down, forward, and back on the screen. When the cursor is positioned at the error you want to correct, you can change a

character, delete it, or insert new characters at that point. When the line is correct, hit RETURN and the corrected line replaces the old one in memory. To delete an entire line, just type the line number and hit RETURN.

The screen has what I call "semi-graphic" capability. There are "characters" based on the 8×8 dot matrix which consist of lines, blocks, arcs of circles, and so forth. By printing these characters in the proper order, a surprising variety of pictures can be drawn on the screen. It's easy to lose yourself for hours at a time drawing things on the screen—the "Etch-a-Sketch™" syndrome. Though not nearly as flexible as a good graphic capability, this seems to me to be a very good compromise—you get quite a lot of capability for little extra cost.

The cassette has several good features. Programs and files can be SAVEd and LOAded by name. If you

ask it to LOAD "CAL1," it will search past CAL and CAL12 until it finds CAL1. It will note on the screen in passing that it FOUND CAL and FOUND CAL12.

Unfortunately, the computer cannot control the cassette except to stop the motor. When you ask it to LOAD, it will tell you to PRESS "PLAY" ON TAPE # 1. The tape will then be searched at regular playing speed until the desired program is found. If the program is at the wrong end of a C60 cassette, you could wait a half hour for it to be found. If you started searching at a point on the tape after the program you want, you could wait forever, since the machine will search to the end of the tape and then just sit there with the motor stalled. If you have more than one program on the tape, it's fairly easy to start searching in the wrong place since there isn't even a tape counter to give you a hint of where you are. The problem of what to do

| Location | Contents |
|-----------|---|
| 0000-0FFF | User's BASIC text and variables, cassette buffers, operating system working storage |
| 1000-1FFF | User's BASIC text and variables (8K version) |
| 2000-7FFF | Expansion RAM |
| 8000-83E7 | Video display RAM |
| 9000-BFFF | Expansion ROM |
| C000-DFFF | BASIC ROM |
| E000-E7FF | Screen editor ROM |
| E800-E8FF | I/O and expansion I/O |
| F000-FFFF | I/O, diagnostics, and machine-language monitor ROM |

Fig. 1.

when you have program A in memory and want to record it on a tape that already contains program B is almost too horrible to discuss. There doesn't seem to be any way to find out where B ends (so you

| | |
|----------|---|
| FRE | Returns number of bytes of available memory. |
| SYS X\$ | Complete control of PET is transferred to a subsystem located at the hex address contained in the string X\$. |
| TIS | Crystal-controlled real-time clock. |
| USR | Transfers to a program whose address is at locations 1 and 2. |
| POS | Gives position of cursor on screen. |
| VERIFY | Checks the program just recorded on cassette against the version still in memory. |
| CHR\$(N) | Returns the character corresponding to ASCII code N. |

Fig. 2.

don't inadvertently let them overlap) except to go play it on an audio cassette player and listen for the end of the noise.

In summary, I can only find three things to gripe about on the PET. They are the keyboard, which is a matter of personal taste and can be replaced easily, the cassette file-searching system, which may not be that bad compared to other microcomputer cassette interfaces (I'm not familiar with them and I'm judging it against the \$13,000 job), and the documentation. I know it's a new product, and I know the documentation is always the last part of a job to get done, but it seems to me that a machine that is projected toward fairly-sophisticated users (machine-language accessibility, etc.) ought to come with some machine-language documentation. How hard could it have

been to throw a 6502 programming manual and a 6500-series hardware manual into the shipping box? You get them if you buy a KIM, and that costs less than half as much.

On the other hand, I can find hundreds of things to rave about. The PET is just a great machine. But the best thing about it, I think, is the way it was done. (Just let me get up on this soapbox, here.) The PET was done *right*. The people responsible for the concept made the decision to build a *real* computer that would be useful in a wide variety of ways, that would not be easy to outgrow. Compare it to the other approach to a mass-market computer—the \$250 programmable TV game with the \$20 cartridge that turns it into a four-function calculator. I like what that says about the way the PET people look at things. ■



IC INSERTION TOOL 36-40 PIN CMOS-SAFE

Unique new insertion tool. Also aligns bent-out pins. A twist of the handle compresses the pins to proper .600 inch spacing and locks the IC into the tool. Then simply place the tool on the socket and depress the plunger for instant and accurate insertion. Features heavy chrome plating throughout for reliable static dissipation. Includes terminal lug for attachment of ground strap.

MOS-40
36-40 PIN CMOS SAFE
INSERTION TOOL

\$795
EACH

MINIMUM BILLING \$25.00 ADD SHIPPING CHARGE \$1.00
NEW YORK STATE RESIDENTS ADD APPLICABLE TAX



OK MACHINE & TOOL CORPORATION
3455 CONNER ST., BRONX, N.Y. 10475 U.S.A.
TELEX 125091

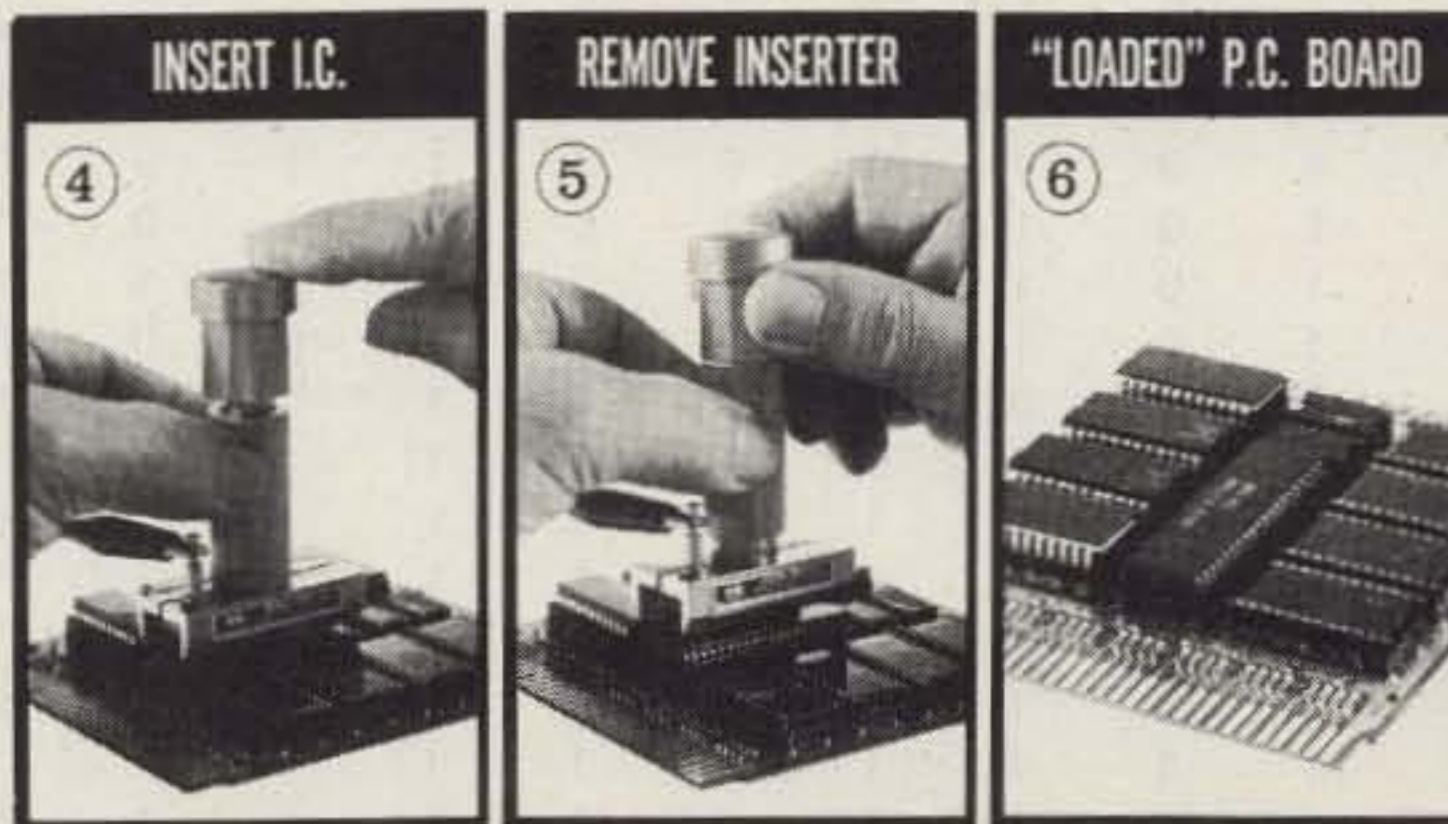

A Hex on Your 8223

— space-saving magic

Editor's Note: Since this article was written, Fairchild has developed the 9368, a chip which accomplishes the segment encoding described in this article—but which will not encode the decimal point for accent.

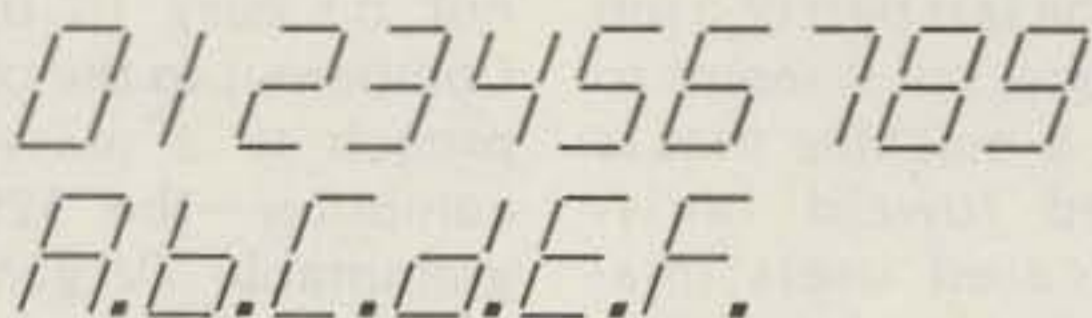

Table 1. Human readable hex characters are possible with 7-segment displays. The decimal point is used to accent alpha characters.

Hex smex! It seems that hex notation is the national language of microprocessors. This is understandable, with two hex digits fitting neatly in an eight-bit byte. But oh, my head, after about ten

minutes of converting front-panel binary into hexadecimal. The obvious solution is a hexadecimal front panel. A hex keyboard is no problem, but the hex display is another matter. It's better to have a little skull sweat in the design stage than the long hours of headache during program debugging.

A few minutes of checking prices on hexadecimal readouts proves that their use can be rather expensive. Being the miser that I am, seven-segment displays seem to be the only practical way to go. While most BCD-to-7-segment decoders have unique patterns for the representation of the numbers from 10 through 15, these patterns are almost as difficult to memorize as the binary LED patterns. A little special encoding is required to represent the letters A through F in a human

| A4 | A3 | A2 | A1 | A0 | p B7 | g B6 | f B5 | e B4 | d B3 | c B2 | b B1 | a B0 |
|----|----|----|----|----|---------|---------|---------|---------|---------|---------|---------|---------|
| 0 | 0 | 0 | 0 | 0 | 1 | 1 | 0 | 0 | 0 | 0 | 0 | 0 |
| 0 | 0 | 0 | 0 | 1 | 1 | 1 | 1 | 1 | 1 | 0 | 0 | 1 |
| 0 | 0 | 0 | 1 | 0 | 1 | 0 | 1 | 0 | 0 | 1 | 0 | 0 |
| 0 | 0 | 0 | 1 | 1 | 1 | 0 | 1 | 1 | 0 | 0 | 0 | 0 |
| 0 | 0 | 1 | 0 | 0 | 1 | 0 | 0 | 1 | 1 | 0 | 0 | 1 |
| 0 | 0 | 1 | 0 | 1 | 1 | 0 | 0 | 1 | 0 | 0 | 1 | 0 |
| 0 | 0 | 1 | 1 | 0 | 1 | 0 | 0 | 0 | 0 | 0 | 1 | 0 |
| 0 | 0 | 1 | 1 | 1 | 1 | 1 | 1 | 1 | 1 | 0 | 0 | 0 |
| 0 | 1 | 0 | 0 | 0 | 1 | 0 | 0 | 0 | 0 | 0 | 0 | 0 |
| 0 | 1 | 0 | 0 | 1 | 1 | 0 | 0 | 1 | 0 | 0 | 0 | 0 |
| 0 | 1 | 0 | 1 | 0 | 0 | 0 | 0 | 0 | 0 | 0 | 1 | 1 |
| 0 | 1 | 1 | 0 | 0 | 0 | 0 | 0 | 0 | 0 | 1 | 1 | 0 |
| 0 | 1 | 1 | 0 | 1 | 0 | 0 | 1 | 0 | 0 | 0 | 0 | 1 |
| 0 | 1 | 1 | 1 | 0 | 0 | 0 | 0 | 0 | 0 | 1 | 1 | 0 |
| 0 | 1 | 1 | 1 | 1 | 0 | 0 | 0 | 0 | 1 | 1 | 1 | 0 |
| 1 | 0 | 0 | 0 | 0 | 0 | 0 | 1 | 1 | 1 | 1 | 1 | 1 |
| 1 | 0 | 0 | 0 | 1 | 0 | 0 | 0 | 0 | 0 | 1 | 1 | 0 |
| 1 | 0 | 0 | 1 | 0 | 0 | 1 | 0 | 1 | 1 | 0 | 1 | 1 |
| 1 | 0 | 0 | 1 | 1 | 0 | 1 | 0 | 0 | 1 | 1 | 1 | 1 |
| 1 | 0 | 1 | 0 | 0 | 0 | 1 | 1 | 0 | 0 | 1 | 1 | 0 |
| 1 | 0 | 1 | 0 | 1 | 0 | 1 | 1 | 0 | 1 | 1 | 0 | 1 |
| 1 | 0 | 1 | 1 | 0 | 0 | 0 | 0 | 0 | 0 | 1 | 1 | 1 |
| 1 | 1 | 0 | 0 | 0 | 0 | 1 | 1 | 1 | 1 | 1 | 1 | 1 |
| 1 | 1 | 0 | 0 | 1 | 0 | 1 | 1 | 0 | 1 | 1 | 1 | 1 |
| 1 | 1 | 0 | 1 | 0 | 1 | 1 | 1 | 1 | 0 | 1 | 1 | 1 |
| 1 | 1 | 0 | 1 | 1 | 1 | 1 | 1 | 1 | 1 | 1 | 0 | 0 |
| 1 | 1 | 1 | 0 | 0 | 1 | 1 | 1 | 1 | 1 | 0 | 0 | 1 |
| 1 | 1 | 1 | 0 | 1 | 1 | 1 | 0 | 1 | 1 | 1 | 1 | 0 |
| 1 | 1 | 1 | 1 | 0 | 1 | 1 | 1 | 1 | 1 | 0 | 0 | 1 |
| 1 | 1 | 1 | 1 | 1 | 1 | 1 | 1 | 1 | 1 | 0 | 0 | 1 |
| 1 | 1 | 1 | 1 | 1 | 1 | 1 | 1 | 1 | 0 | 0 | 0 | 1 |

Table 2. 8223 PROM encoding data for hex-to-7-segment decoder.

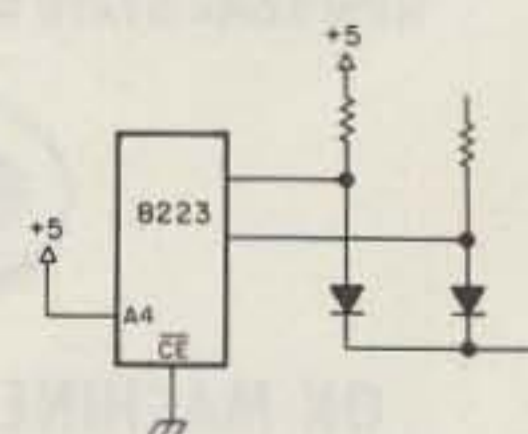

Fig. 1. Output connection for common cathode displays.

readable form. Table 1 shows the proposed character representations for 7-segment displays. These characters are further encoded with the decimal point active for A through F to accent these unusual patterns.

Try as I might, I could not find a standard encoder that so much as comes close to such a pattern. Normally, this situation would call for a 4-to-16 decoder and a handful of

diodes to implement such a character generator, but space considerations in my application require a different approach. What is required is a hex-to-7-segment decoder/driver.

8223 to the Rescue

The 8223 is the ideal PROM for such a circuit. Its eight outputs provide control for all segments, including the decimal point. Decoding hexadecimal data uses only 16 of the 32

memory words available in the 8223. By inverting the data for the second 16 words, the encoder is able to drive low or high active 7-segment displays. A0 through A3 define the hex input data, while A4 selects the type of display. With A4 high, the outputs are active high for driving common cathode displays as shown in Fig. 1. Fig. 2 details the common anode connection with A4 active low. Programming code for

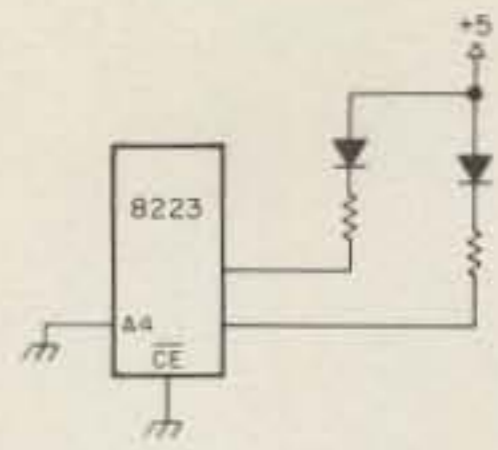



Fig. 2. Common anode connection.

the 8223 PROM is shown in Table 2. Now, all that is required is some enterprising person to make such an item for off-the-shelf delivery. ■



THE COMM CENTER

Send S.A.E. for spec sheet
U.S. patent pending
Dealer inquiries invited

✓ C75
Laurel Plaza—Rte 198
Laurel MD 20810 301-792-0600

THE BANTAM DIPOLE

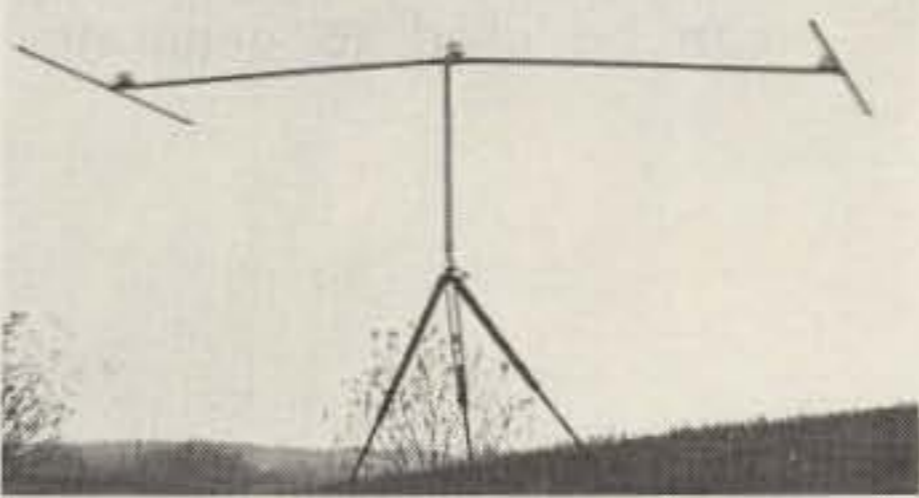

30-day money back guarantee. \$59.95, plus UPS shipping

The HF BANTAM DIPOLE is a truly portable all-band miniature dipole complete with its own carrying case and mast/hardware to mount on a camera tripod (3/8" x 24" adaptor available). High performance is obtained on 80-10 meters at its normal 13 foot length or the same antenna may be shortened to 7 feet for 75-10 meter coverage. Polarization is quickly interchangeable from horizontal to vertical. No ground system necessary. The BANTAM DIPOLE is ideal for camping, traveling, mountaintopping, apartment living, or if you're stuck with building code restrictions. Construction is of high quality 6061-T6 aluminum and stainless steel hardware.

DRAKE • ICOM • TEN-TEC • TEMPO • Wilson

CLIP AND STRIP





Model CAS-130

\$198

- CUTS AWG 30 WIRE TO DESIRED LENGTH
- STRIPS 1" OF INSULATION

MINIMUM BILLING \$25.00
ADD SHIPPING CHARGE \$2.00
NEW YORK STATE RESIDENTS
ADD APPLICABLE TAX



OK MACHINE & TOOL CORPORATION

3455 Conner St., Bronx, N.Y. 10475 • (212) 994-6600 • TELEX 125091

The Micro Maestro!

Sam Creason K6EW
2940 Arlington Ave.
Fullerton CA 92635

There are any number of digital processes which can be used to generate

musical notes. In a recent article in *Kilobaud*, Ken Winograd presented an interesting and inexpensive approach to the problem. A microprocessor (uP) is used to control the timing of a frequency generator circuit. The output of the circuit is a lightly-filtered square wave with a fundamental frequency which corresponds to that of the desired note. The square wave is turned full on for the entire duration of a note and then it's turned full off. Such a device is very entertaining and a lot of fun to use, but it does have some limitations. What's described in this

article overcomes some of those limitations.

To begin, let's note that the switched square wave which is output from Winograd's device is a rather good choice for a waveform. One of the characteristics of a musical note which makes it interesting to the ear is its harmonic content, and a square wave is rich in harmonics. If we examine any periodic waveform, we'll find that we can describe it as the sum of a set of sine waves of different frequencies and amplitudes. A square wave, for example, is made up of a sine wave at the fundamental fre-

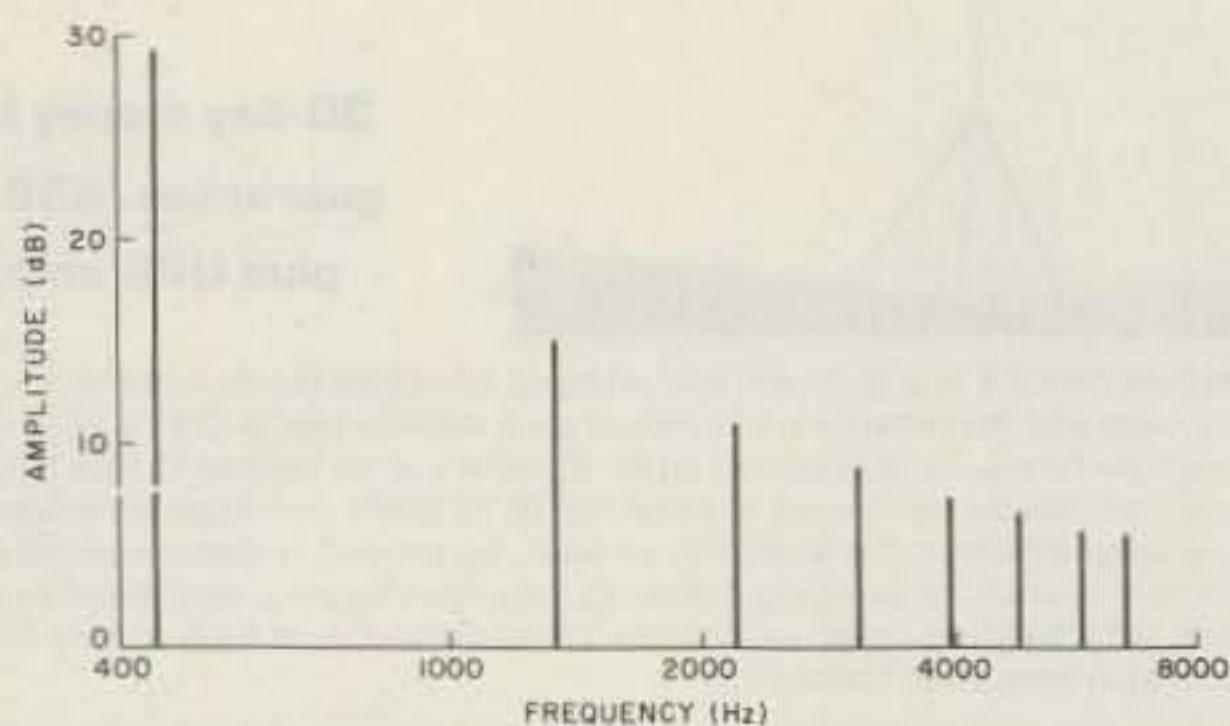

Fig. 1. Spectrum of square wave, showing first few harmonics. Fundamental frequency is 440 Hz.

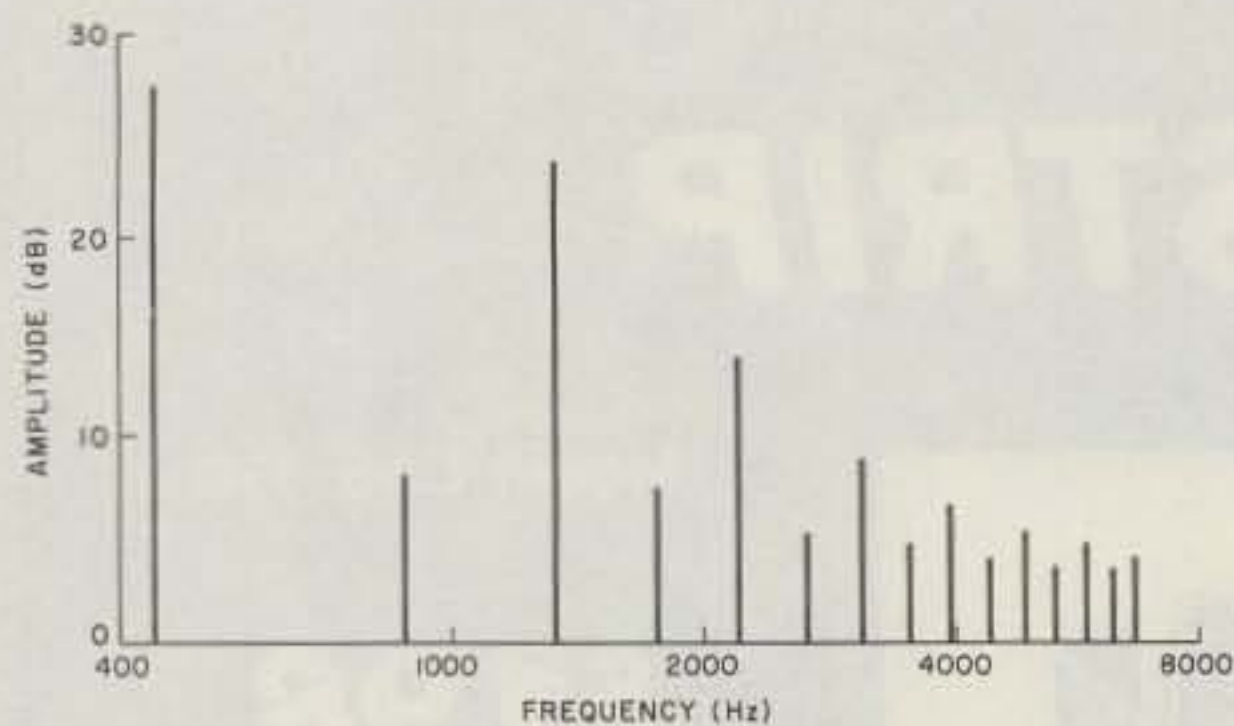

Fig. 2. Spectrum of steady-state sound from a clarinet, showing major harmonics. Fundamental frequency is 440 Hz.

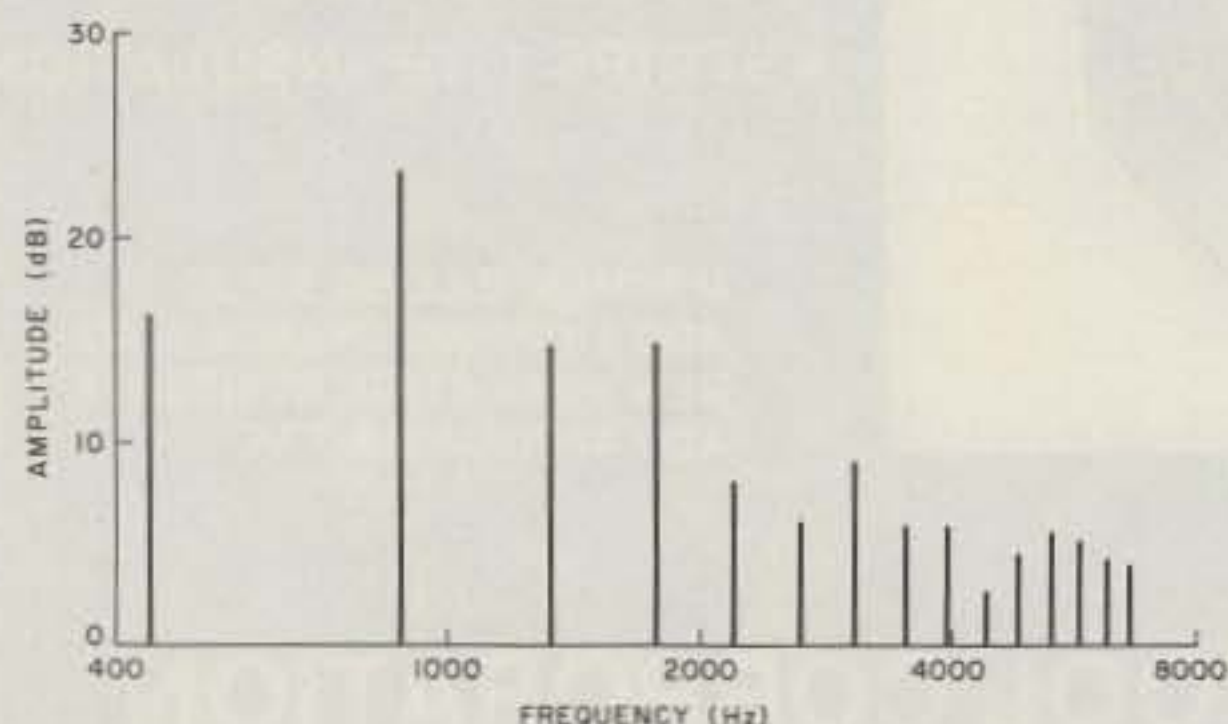

Fig. 3. Spectrum of steady-state sound from a trumpet, showing major harmonics. Fundamental frequency is 440 Hz.

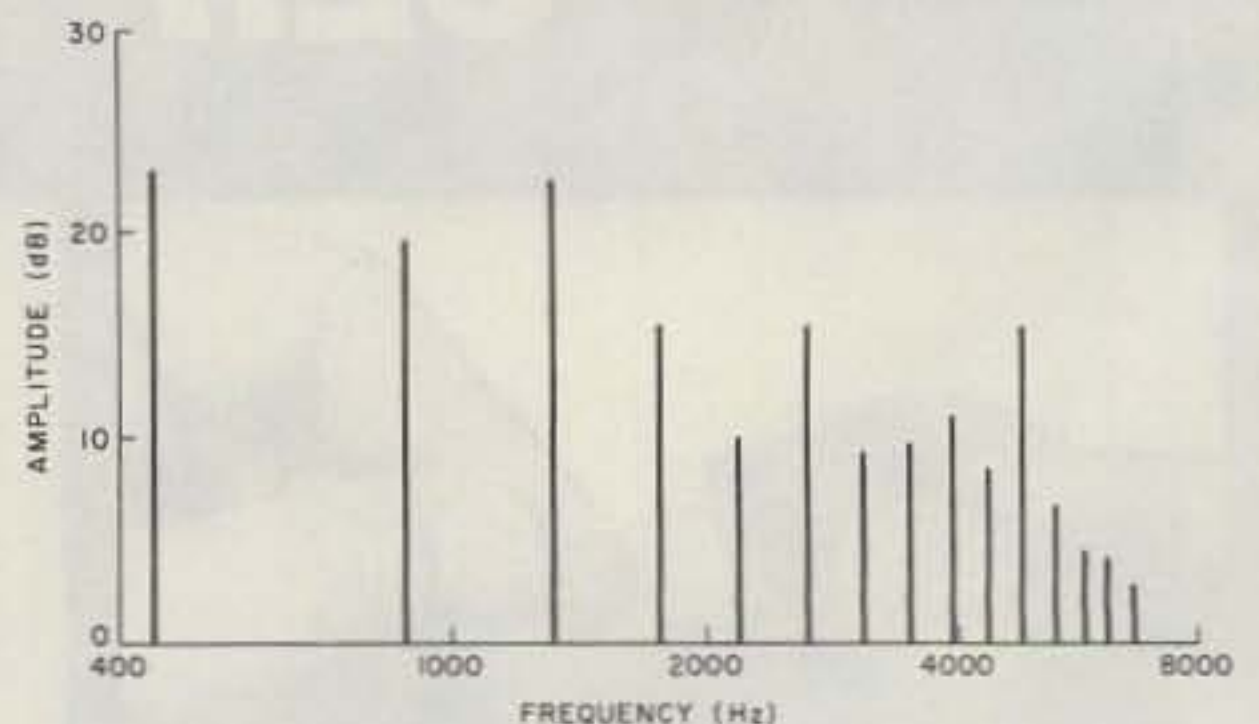

Fig. 4. Spectrum of steady-state sound from a violin, showing major harmonics. Fundamental frequency is 440 Hz.

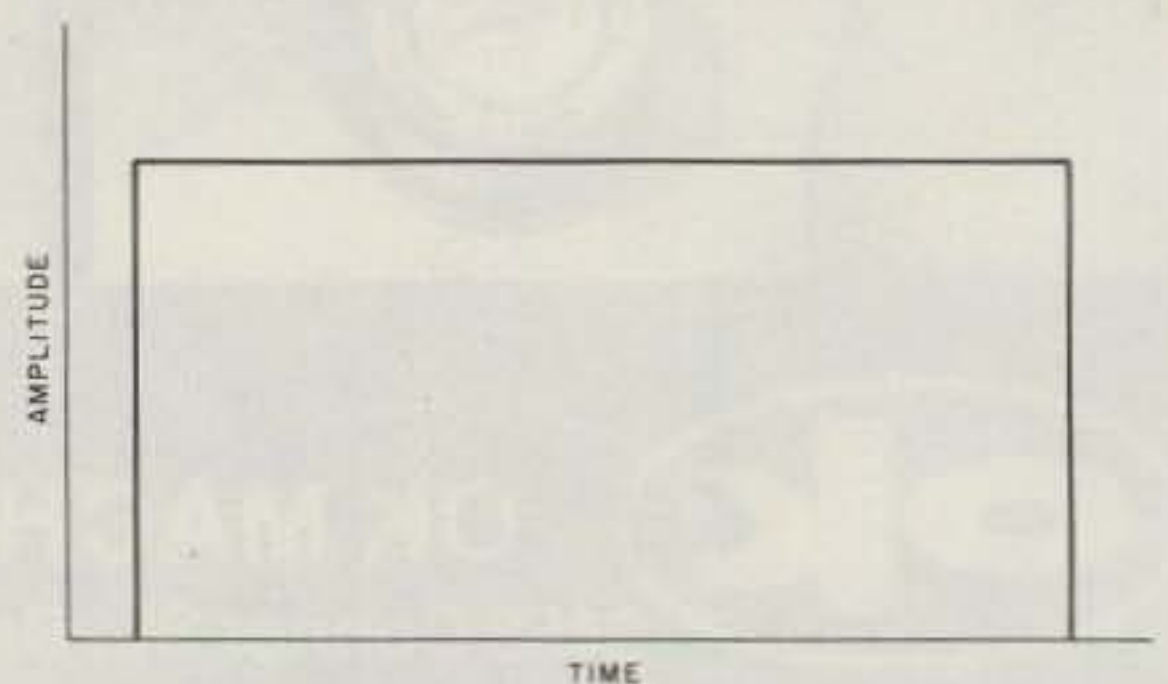

Fig. 5. Envelope of an abruptly-switched note.

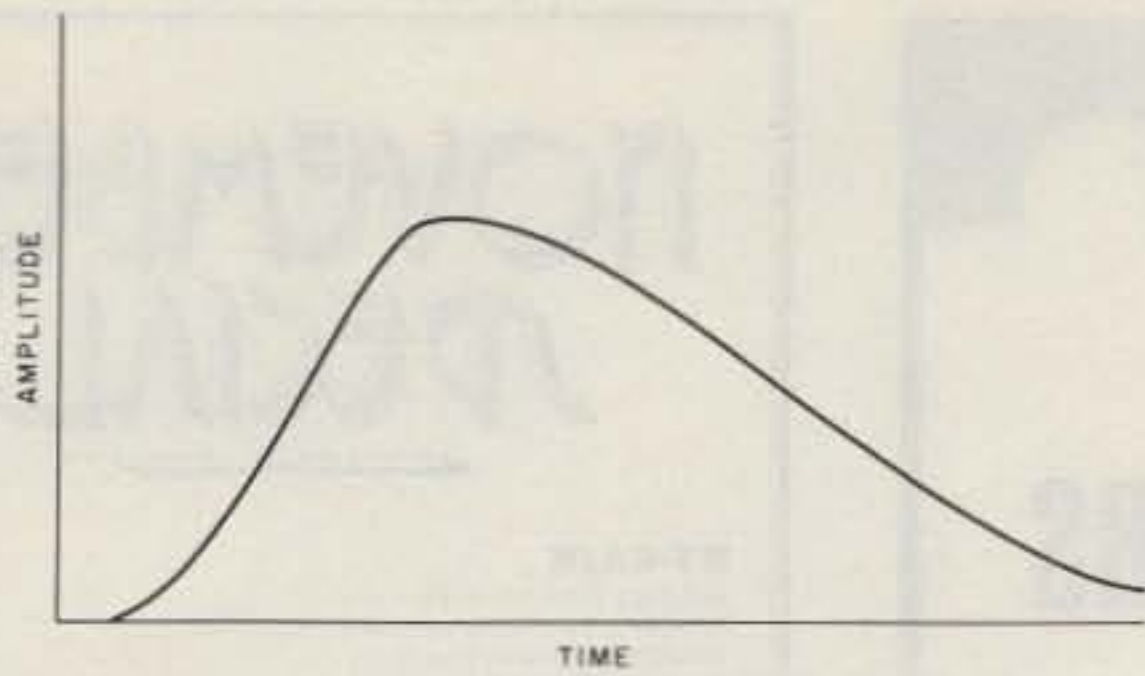

Fig. 6. Envelope of the note from a cello.

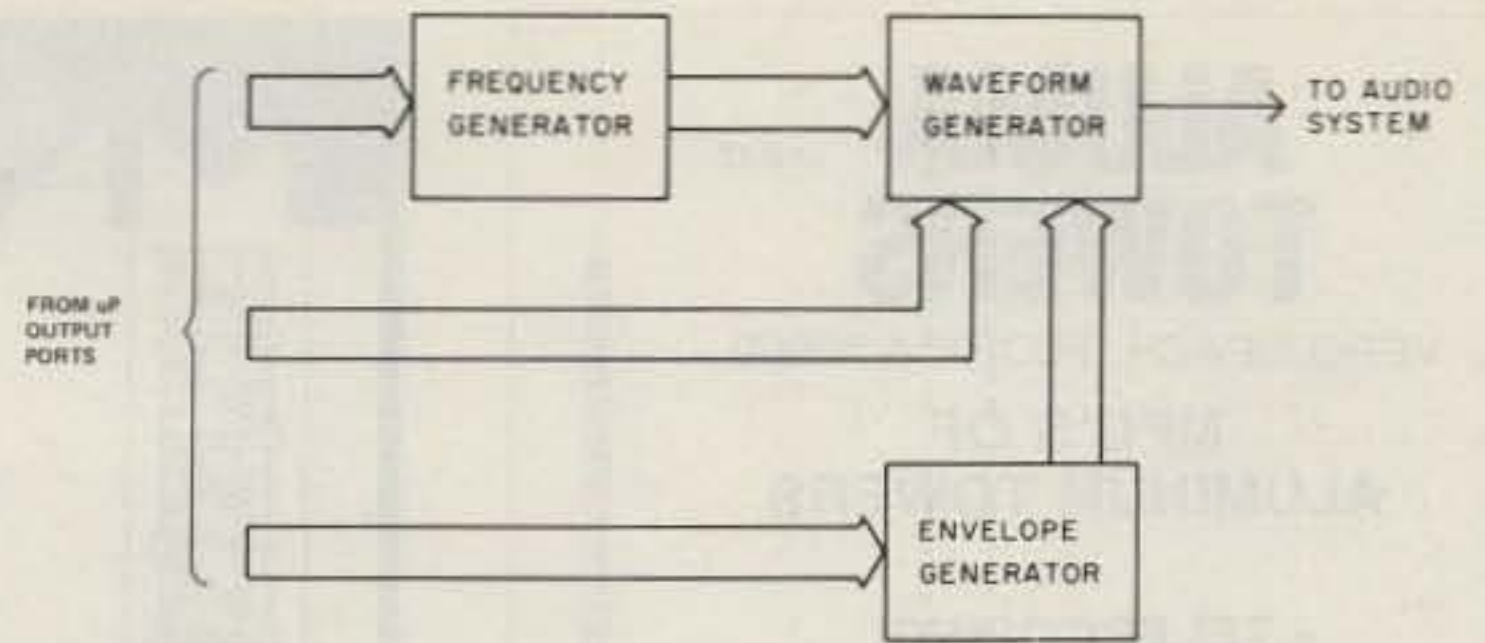

Fig. 7. Block diagram of the synthesizer.

quency and sine waves of progressively lower amplitudes at each of the odd-harmonic frequencies. This is shown in Fig. 1. The spectrum of the sound of a clarinet is similar, except that very weak components are present at the even-harmonic frequencies as well, as shown in Fig. 2. Not surprisingly, if we apply a square wave to the input of a sound system, we hear a fairly realistic clarinet-like sound. The spectra of the steady-state sounds from a trumpet and a violin are shown in Figs. 3 and 4, respectively, for comparison. Clearly, at least part of the reason why a clarinet sounds like a clarinet lies in the harmonic content of the sound which it produces. Just as clearly, we'd like to be able to manipulate the harmonic content of the sound which our synthesizer produces.

Another reason why one instrument sounds different from another involves the envelope of the note (the amplitude of the note vs. time) which each produces. If we switch a sound on abruptly and

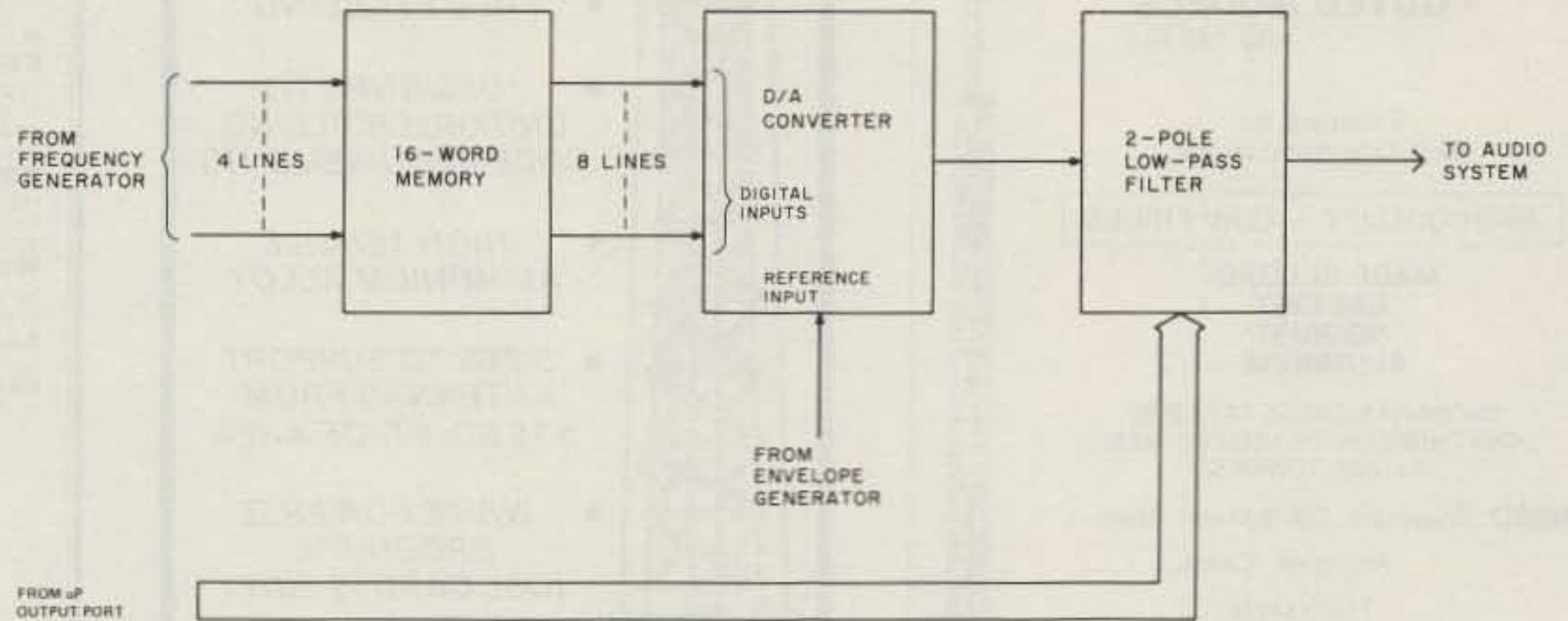

Fig. 8. Block diagram of the waveform generator.

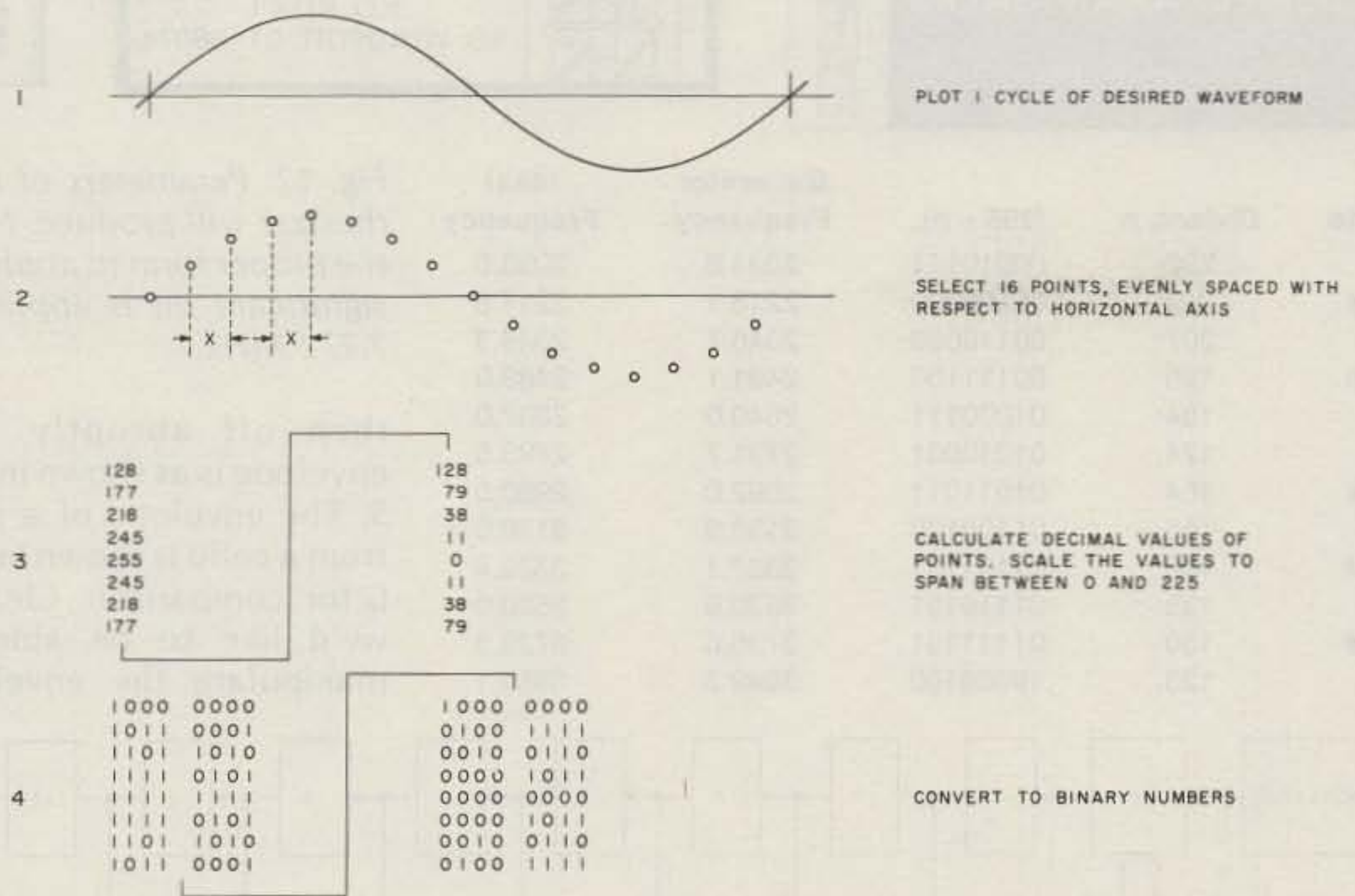

Fig. 9. Construction of a sixteen-word, eight-bit sine wave.

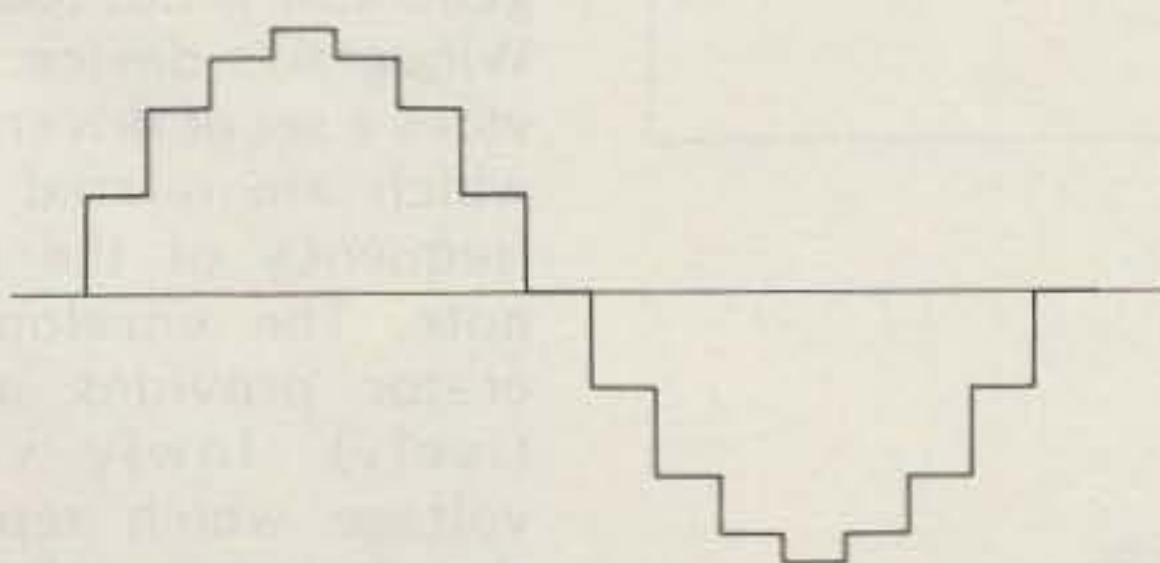

Fig. 10. Approximation of sine wave at output of D/A converter.

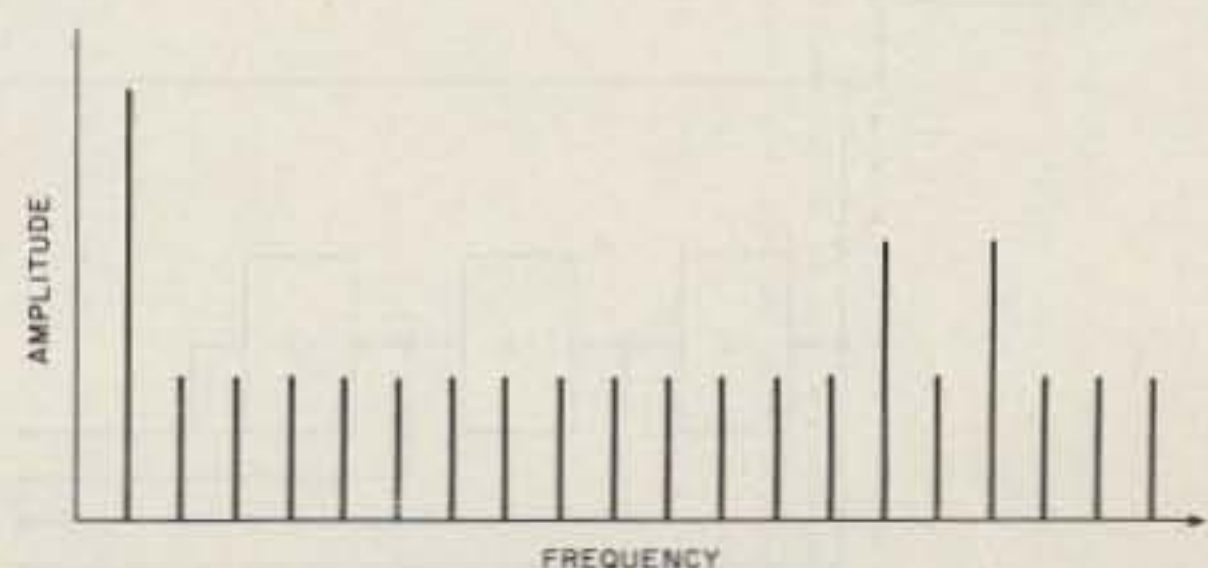

Fig. 11. Spectrum of D/A converter output.

ALUMA TOWERS

✓ A47

VERO BEACH, FLORIDA 32960

MFG'S OF ALUMINUM TOWERS

- ★ TELESCOPING (Crank Up)
- ★ WALL MOUNTED
- ★ TILT-OVER
- ★ GUYED MODELS (to 100 Ft.)

Excellent for Ham Communications.

HIGH QUALITY — LOW PRICES

MADE IN LONG-LASTING NO-RUST ALUMINUM!

McCLARAN SALES TAKES IN ANYTHING ON TRADE FOR NEW ALUMA TOWERS.

NEED: Scanners, CB, 2 Meter, Marine, Antiques, Coins, Ham Gear.

We accept Master Charge & Visa Cards

FOR SALES & TRADES CONTACT
R.D. McCLARAN SALES

430 Franklyn at Beach
Indialantic, Florida 32903
(305) 723-4793



TOWERS

- FREE STANDING
- DESIGNED TO UNIFORM BUILDING CODE REQUIREMENTS
- HIGH TENSILE ALUMINIUM ALLOY
- SIZES TO SUPPORT ANTENNAS FROM 5-15 SQ. FT. OF AREA
- WRITE FOR FREE BROCHURE (QSL CARD IS FINE)

MARKO MFG. INC.

P.O. BOX L ✓ M56
SO. WINDSOR, CT 06074

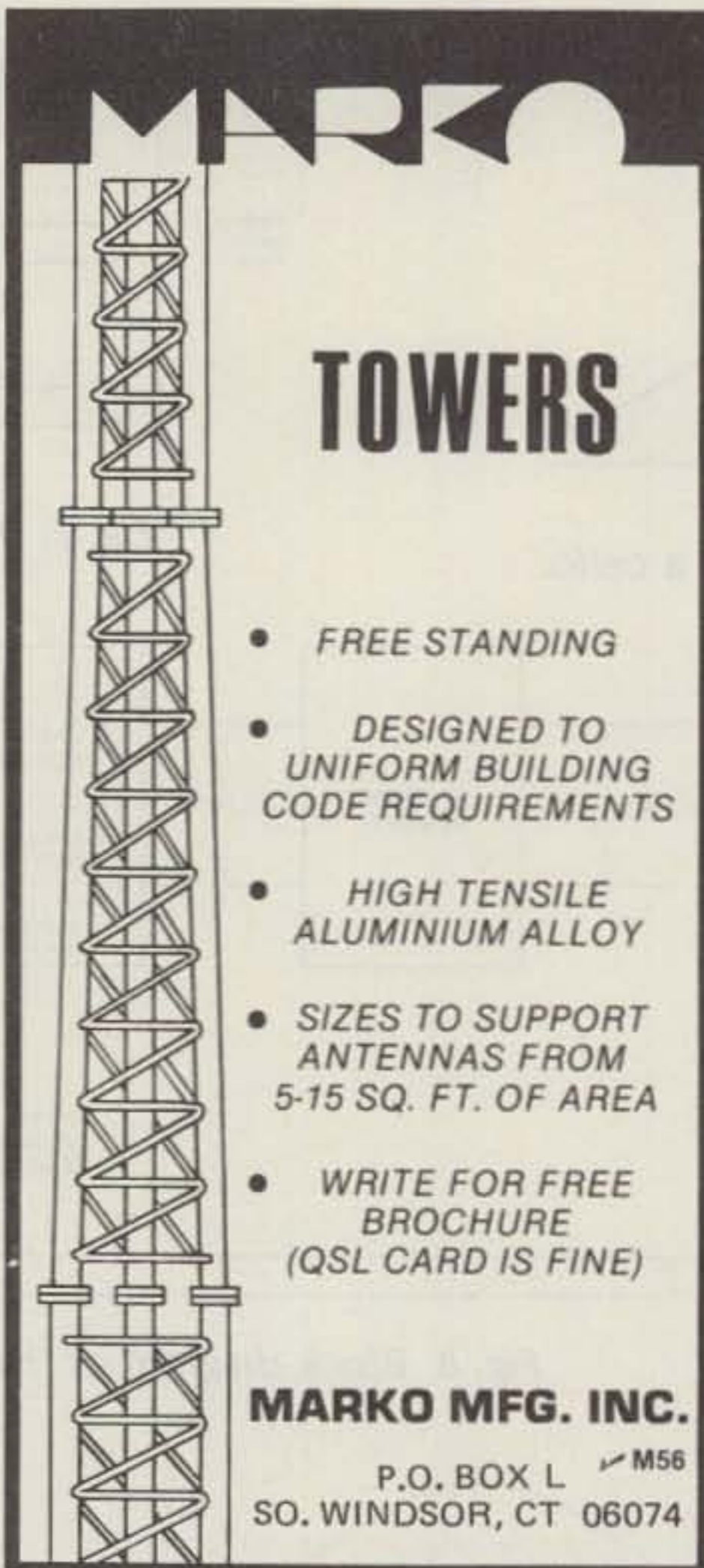

NOVEMBER SPECIALS

HY-GAIN

| | |
|-------------------------------|----------|
| TH6DX 6 element tribander | \$195.00 |
| TH3MR 3 element tribander | 158.50 |
| TH3JR Low Power Beam | 104.00 |
| 18AVT WB 10-80 Meter Vertical | 70.00 |

MOSLEY

| | |
|---------------------------|----------|
| TA-33 3 element tribander | \$109.95 |
| TA-33JR Low Power Beam | 129.00 |
| CL-33 3 element tribander | 199.00 |
| CL-36 6 element tribander | 249.95 |

CUSHCRAFT

| | |
|----------------------------|----------|
| ATB-34 4 element tribander | \$180.00 |
| A147-11 11 el. 2 M. Beam | 25.00 |
| A147-22 22 el. 2 M. Beam | 71.25 |
| ARX-2 Ringo Ranger 2M. | 20.50 |

ROTORS

| | |
|----------------|----------|
| Ham III | \$117.00 |
| T2X Tailwister | 217.00 |
| Alliance HD-73 | 99.00 |

WILSON

| | |
|------------|----------|
| System One | \$209.00 |
| System Two | 167.00 |

SAXTON WIRE & CABLE

See Sept. Issue
CLOSE OUT ON DISCONTINUED ITEMS—send stamp for list. Quantities limited.

COMMUNICATIONS SERVICES



✓ C89

326A WEST MAIN STREET
PHILADELPHIA MS 39350
PHONE: 601-656-5345
HOURS: 8-5 Mon-Fri.

Send stamp for price list or \$1 check for full line catalog. \$1 refundable on first order. We ship only to 50 states. All shipping is FOB.

| Note | Divisor, n | (255 - n) ₂ | Generator Frequency | Ideal Frequency |
|------|------------|------------------------|---------------------|-----------------|
| C | 232 | 00010111 | 2093.8 | 2093.0 |
| C# | 219 | 00100100 | 2218.1 | 2217.5 |
| D | 207 | 00110000 | 2346.7 | 2349.3 |
| D# | 195 | 00111100 | 2491.1 | 2489.0 |
| E | 184 | 01000111 | 2640.0 | 2637.0 |
| F | 174 | 01010001 | 2791.7 | 2793.8 |
| F# | 164 | 01011011 | 2962.0 | 2960.0 |
| G | 155 | 01100100 | 3133.9 | 3136.0 |
| G# | 146 | 01101101 | 3327.1 | 3322.4 |
| A | 138 | 01110101 | 3520.0 | 3520.0 |
| A# | 130 | 01111101 | 3736.6 | 3729.3 |
| B | 123 | 10000100 | 3949.3 | 3951.1 |

Fig. 12. Parameters of the highest octave which the synthesizer will produce. Numbers listed as $(255 - n)_2$ are in the proper form to apply to the 74LS161 dividers. The most significant bit is applied to D7. Oscillator frequency is 7.772 MHz.

then off abruptly, the envelope is as shown in Fig. 5. The envelope of a note from a cello is shown in Fig. 6 for comparison. Clearly, we'd like to be able to manipulate the envelope

of the notes which our synthesizer produces.

A Simple System

The block diagram of a synthesizer which will allow us to manipulate the frequency, harmonic content, and the envelope of a note is shown in Fig. 7. It consists of a frequency generator, an envelope generator, and a waveform generator. The frequency generator is not too unlike Winograd's device. It provides a set of driver signals which are related to the frequency of the desired note. The envelope generator provides a (relatively) slowly varying voltage which represents the desired amplitude of the note as a function of time. The waveform

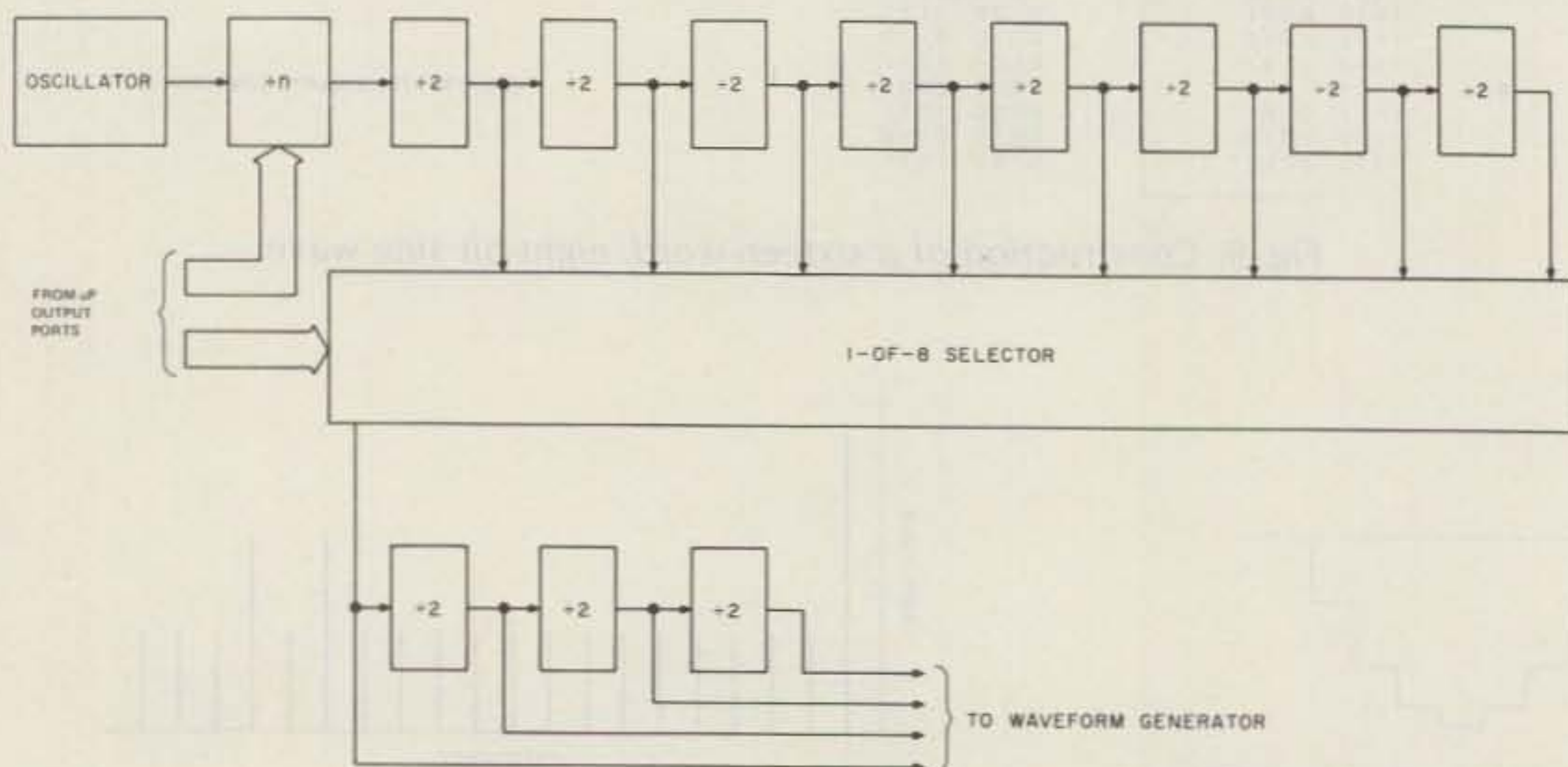

Fig. 13. Block diagram of frequency generator.

generator accepts the outputs of each of the other generators and synthesizes the desired note. A uP system controls the generators by means of its output ports.

Waveform Generator

Since the waveform generator is the heart of the synthesizer, let's begin our more detailed discussion with that module. A block diagram is shown in Fig. 8.

An effective way of generating an audio waveform is to construct the digital representation of the waveform, store that representation, and convert the stored information to an audio signal. The last task is accomplished with a digital-to-analog (D/A) converter. The entire process involves calculating the binary numbers which must be successively applied to the D/A converter in order to produce one cycle of the desired waveform. That same set of numbers is then applied over and over again to the D/A converter, producing many cycles of the desired waveform. This is the basis for our waveform generator.

Construction of a sixteen-point, eight-bit digital representation of a sine wave is illustrated in Fig. 9. The procedure involves plotting one cycle of the desired waveform and selecting sixteen evenly-spaced points on the curve for digitization. Decimal values between 0 and 255 are then computed for each point (to accommodate the characteristics of our particular D/A converter). Finally, the binary equivalents of each decimal value are calculated. In order to generate the sine wave, we store the sixteen eight-bit words in a memory and apply the output of the memory to the digital inputs of the D/A

converter. If we then cycle the memory sequentially so that the binary numbers are output in the proper order, something approximating a sine wave will appear at the output of the D/A converter. It will not be a perfect sine wave, because we've used only a discrete small set of numbers to represent it. Rather, the output will resemble what's shown in Fig. 10, and the spectrum

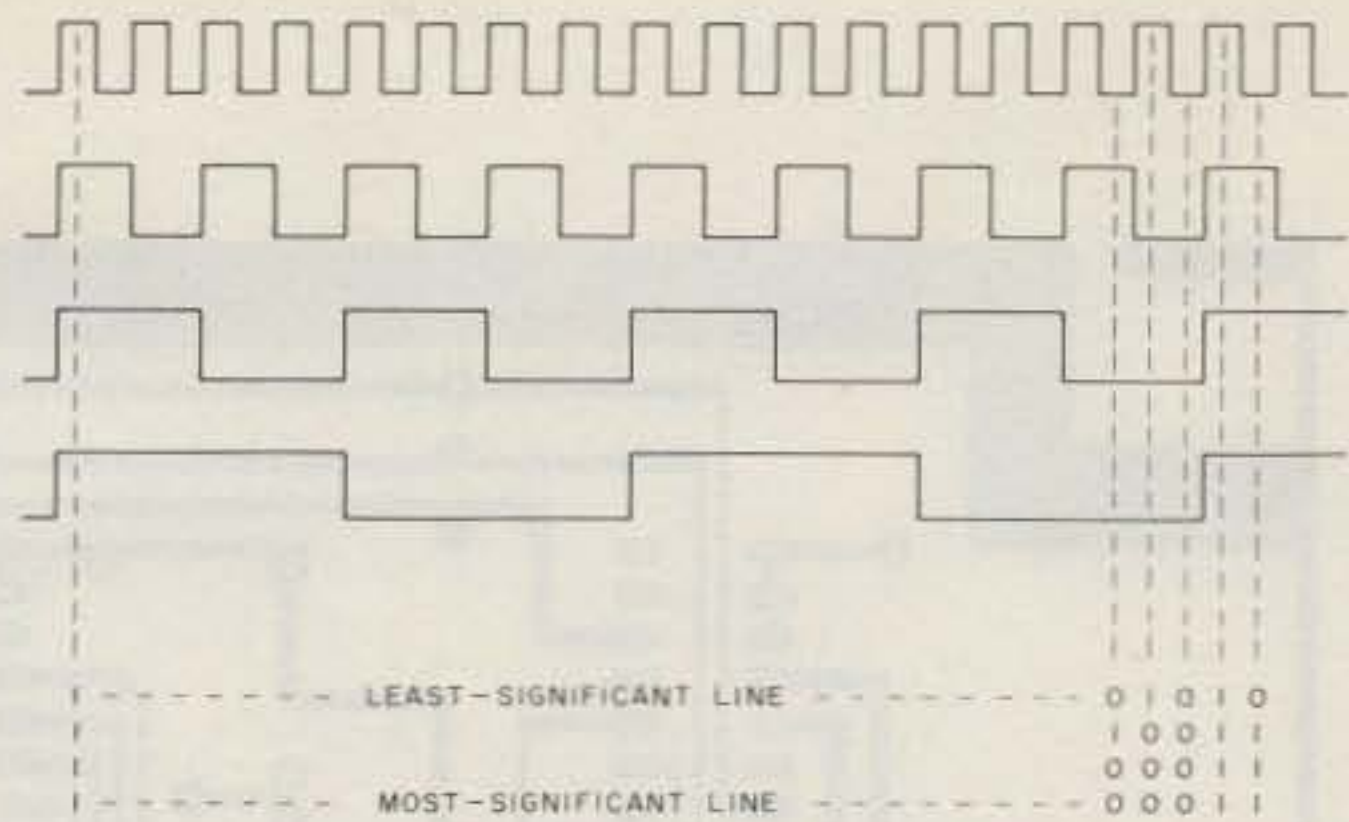

Fig. 14. Timing of square waves which drive the waveform storage memory.

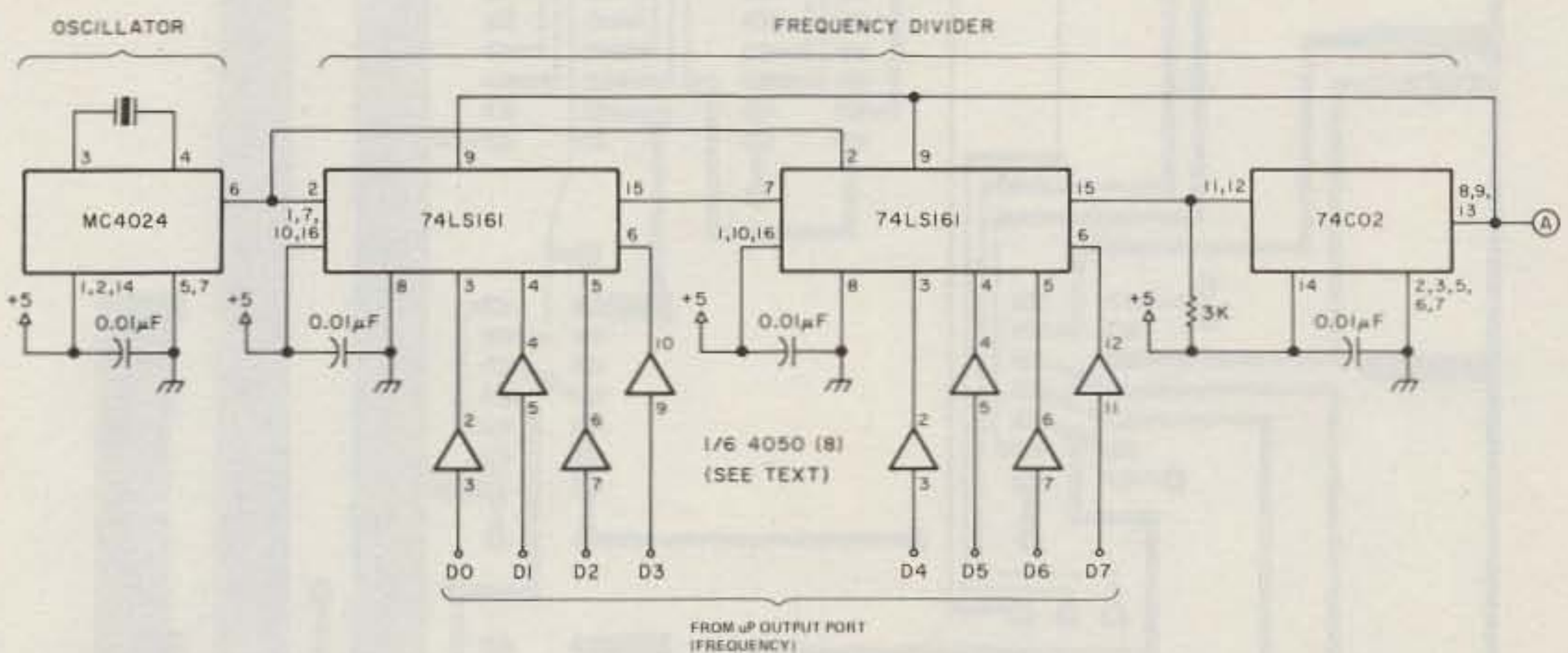

Fig. 15(a). Partial schematic of frequency generator. Note that the MC4024 is not the same as a CMOS CD4024. XTAL may be replaced with a 100-pF variable capacitor.

of the output will be as shown in Fig. 11. There are components at most harmonic frequencies. However, except for the fifteenth and seventeenth harmonics, their amplitudes are low enough to be relatively unobjectionable. We have to deal with the two high-level harmonics, though. Otherwise, if we attempt to generate a low-frequency sine wave, we'll

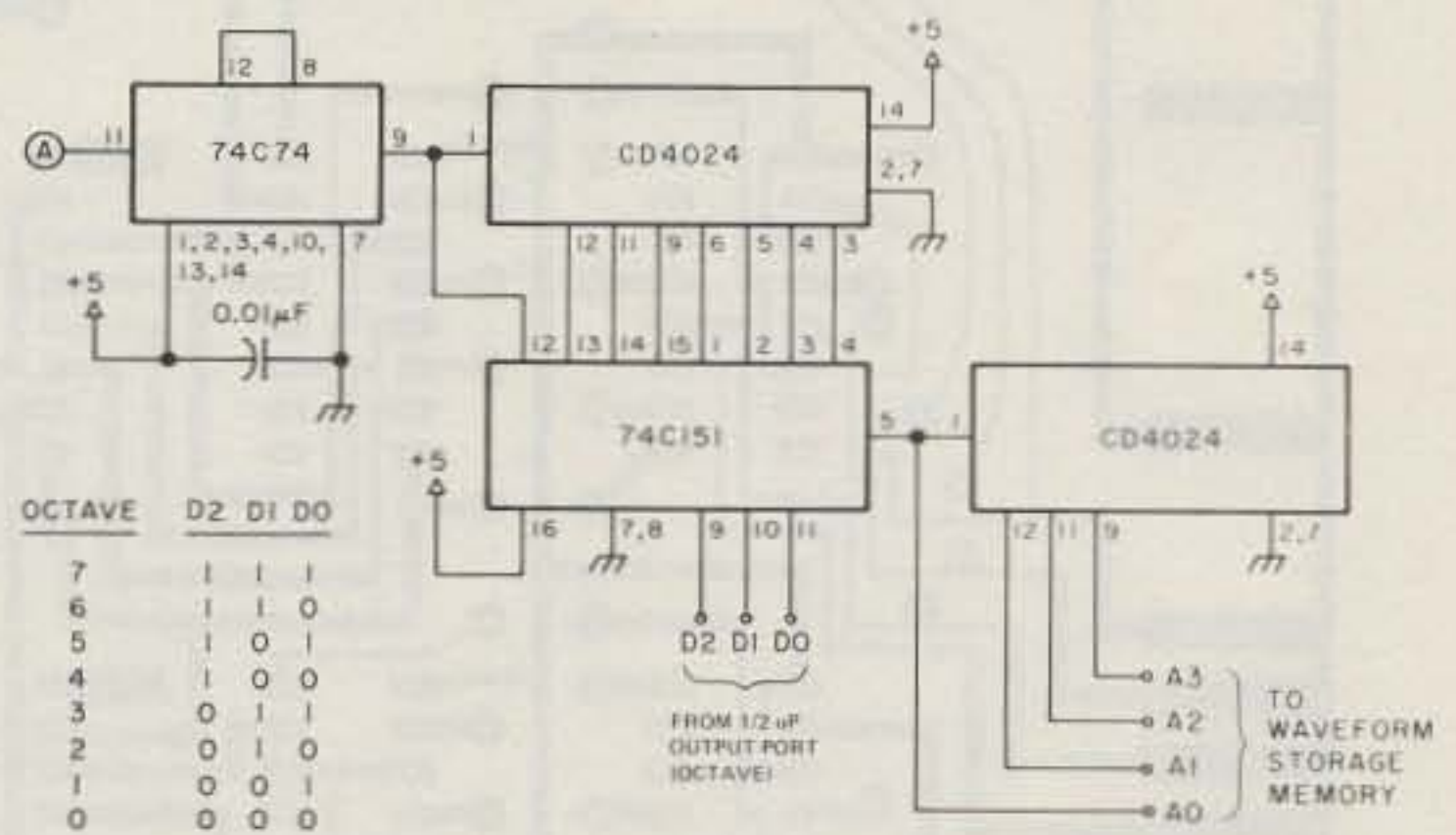

Fig. 15(b). Partial schematic of frequency generator.

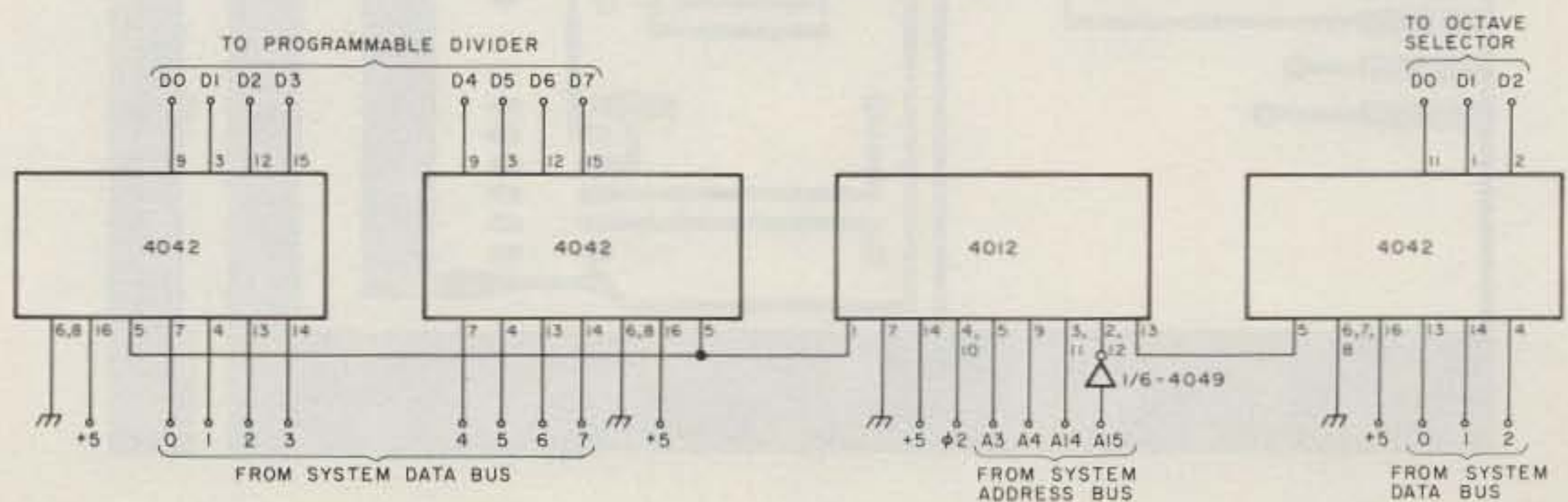

Fig. 16. Circuit to interface frequency generator to BMPS.

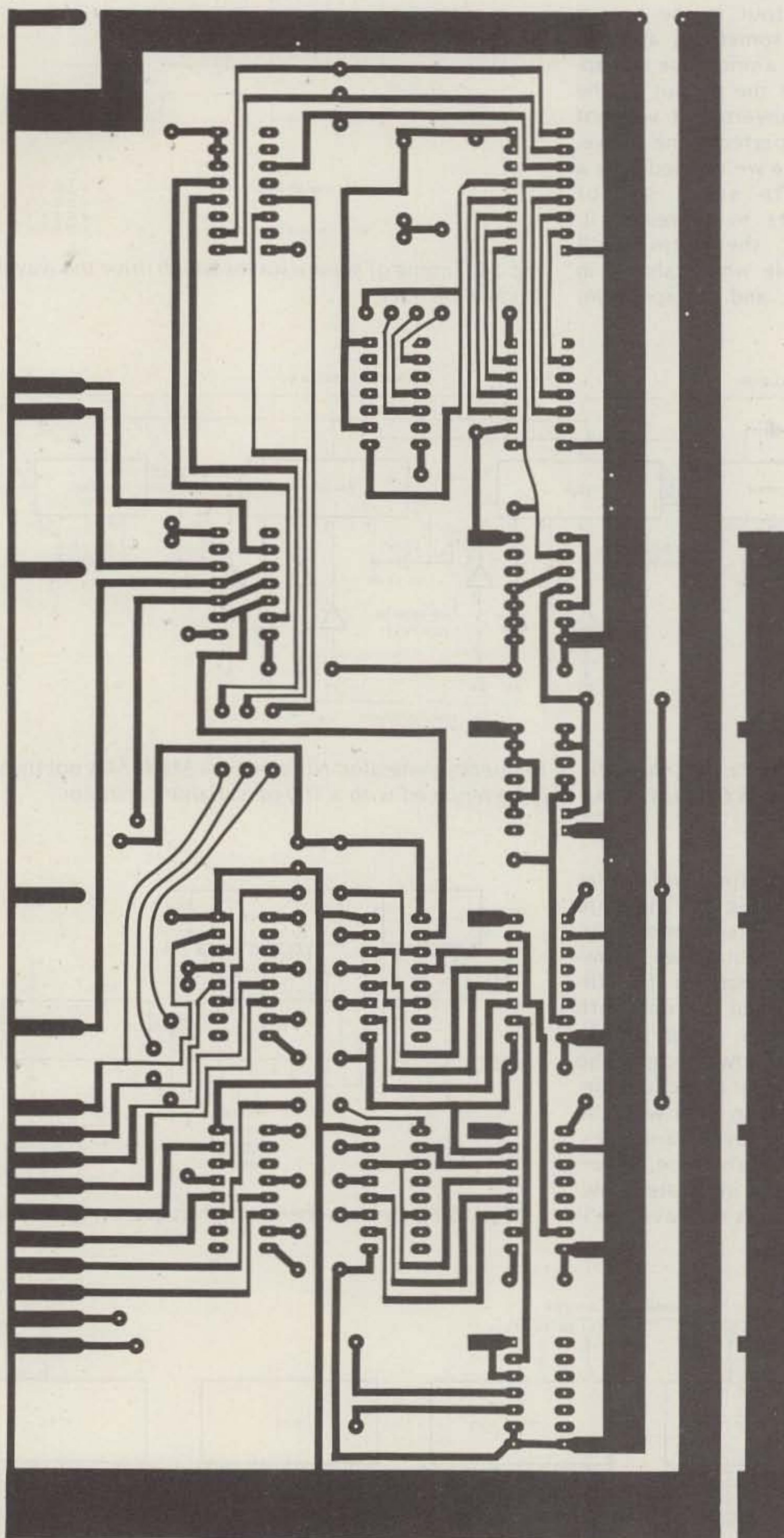

Fig. 17. Foil side of PC board, frequency generator.

find a high frequency "whistle" superimposed upon it.

One way to deal with the problem is to use more points in the digital representation. This will reduce the magnitude of each harmonic, since the step changes in the waveform will be smaller in amplitude. This will also move the high-level harmonics toward the higher (perhaps inaudible) portion of the spectrum. However, if we use more points, the frequency generator must provide a higher-frequency output in order to produce a note of the same fundamental frequency. We'll settle on a sixteen-point waveform, although the synthesizer can be modified to accommodate, say, a sixty-four-point waveform.

To accomplish the task of harmonic rejection, we'll use a set of low-pass filters, any one of which can be selected by the uP. Of course, if we deliberately add harmonics when we construct the digital representation of a waveform, we don't filter them out.

The remaining input to the D/A converter is the so-called "reference" input. The output of the converter is proportional not only to the magnitude of the binary number which is applied to the digital inputs, but to the magnitude of the voltage which is applied to the reference input as well. For example, if we apply zero volts to the reference input, the output will be zero volts, regardless of the value of the number which is applied to the digital inputs. In short, we have a means to control the envelope of a note.

The Envelope Generator

The envelope generator closely resembles the waveform generator, except in two respects. First, a constant voltage is

applied to the reference input. Second, the binary numbers which represent the desired envelope are stored in the memory of the uP rather than in a dedicated memory. This is permissible because the timing requirements for the envelope generator are considerably less restrictive than those for the waveform generator.

Frequency Generator

The remaining module in the synthesizer is the frequency generator. Its purpose is to drive the waveform storage memory. Before we examine how it functions, however, we should discuss the properties of the conventional musical scale.

The scale is divided into octaves. A note which is one octave above another has a fundamental frequency which is twice that of the other. Each octave contains twelve notes which are equally spaced in frequency. Given these two facts, it follows that the frequency of each note is the twelfth root of two times the frequency of its lower neighbor.

A common method of generating the required set of frequencies from a single reference is to drive a programmable divider with a high-frequency oscillator. If the frequency of the oscillator is high enough and the divisors are large enough, then the resulting notes will sound on key. Within the limits of an eight-bit system (divisor = 1 to 255), the results are quite acceptable, but not perfect. A nine-bit system would satisfy even someone with perfect pitch.

The fundamental frequencies of the notes in the highest octave which our synthesizer will produce are shown in Fig. 12, along with the appropriate divisors and the theoretically perfect set of frequencies

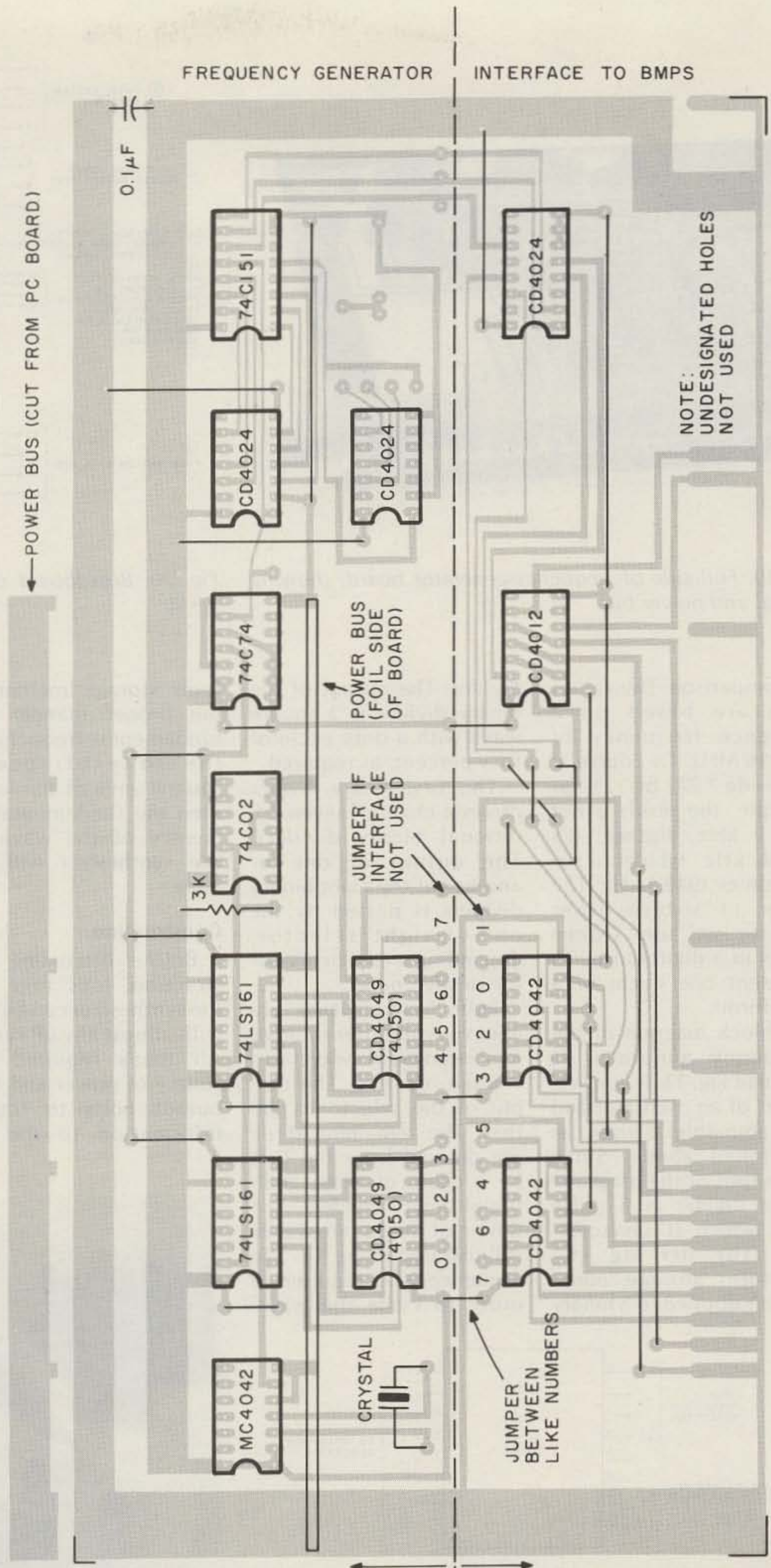

Fig. 18. Component side of PC board, frequency generator. Note: Bypass +5-volt terminals of MC4024 and 74LS161 ICs to ground using 0.1 uF disc ceramic capacitors (foil side of board).

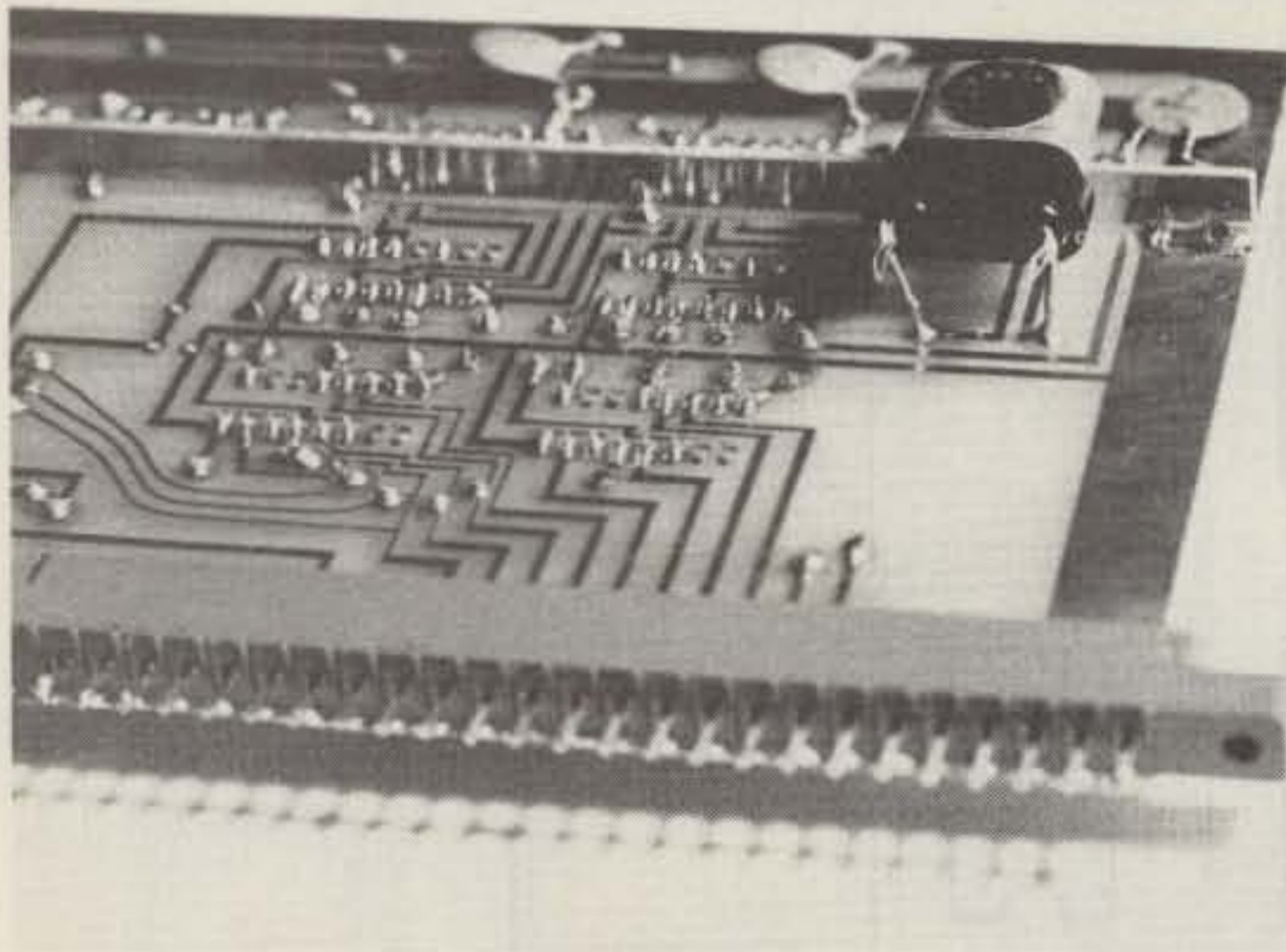

Fig. 19. Foil side of frequency-generator board, showing crystal and power bus.

for comparison. The values of n are based on a reference frequency of 7.77216 MHz. Of course, if we divide 7.772 by 123, for example, the result is not 3949.3 kHz. Rather, it's 63.188 kHz, which is sixteen times 3949.3 kHz. The factor of sixteen arises because we use sixteen points in a digital array to represent one cycle of a waveform.

A block diagram of the frequency generator is shown in Fig. 13. It consists in part of an oscillator and programmable divider as mentioned above. Since the output of the programmable divider is a pulse train (which is unacceptable for driving the waveform storage memory), it's applied to a binary

divider. The output of the binary divider is a square wave with a duty cycle of fifty percent, as required.

This first binary divider drives a chain of seven additional binary dividers. The output of one or another of the eight binary dividers is passed by the one-of-eight selector, depending on the octave of the desired note.

Four square waves are necessary in order to drive a sixteen-word waveform storage memory. The output of the selector is the first. The remaining three are derived from the first by a chain of three additional binary dividers. The timing of the square waves is illustrated in Fig. 14. The sequence is as required in order to cycle the wave-

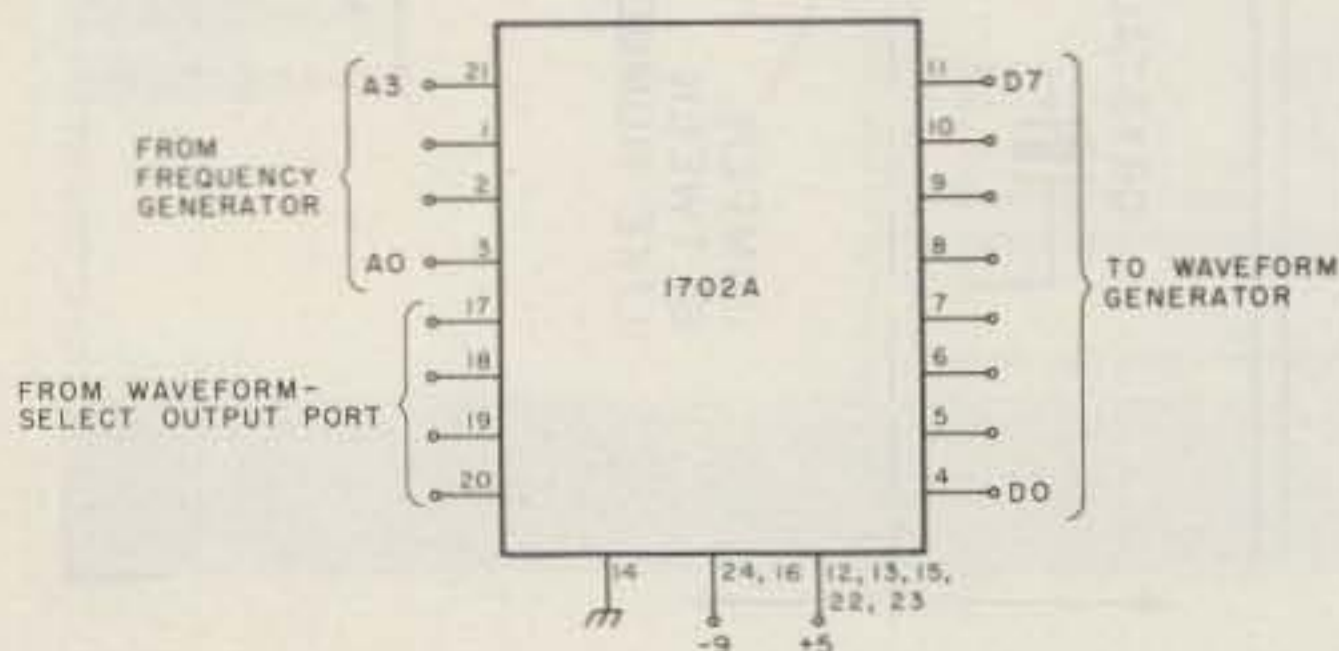

Fig. 21. Breadboard circuit of waveform memory using ROM.

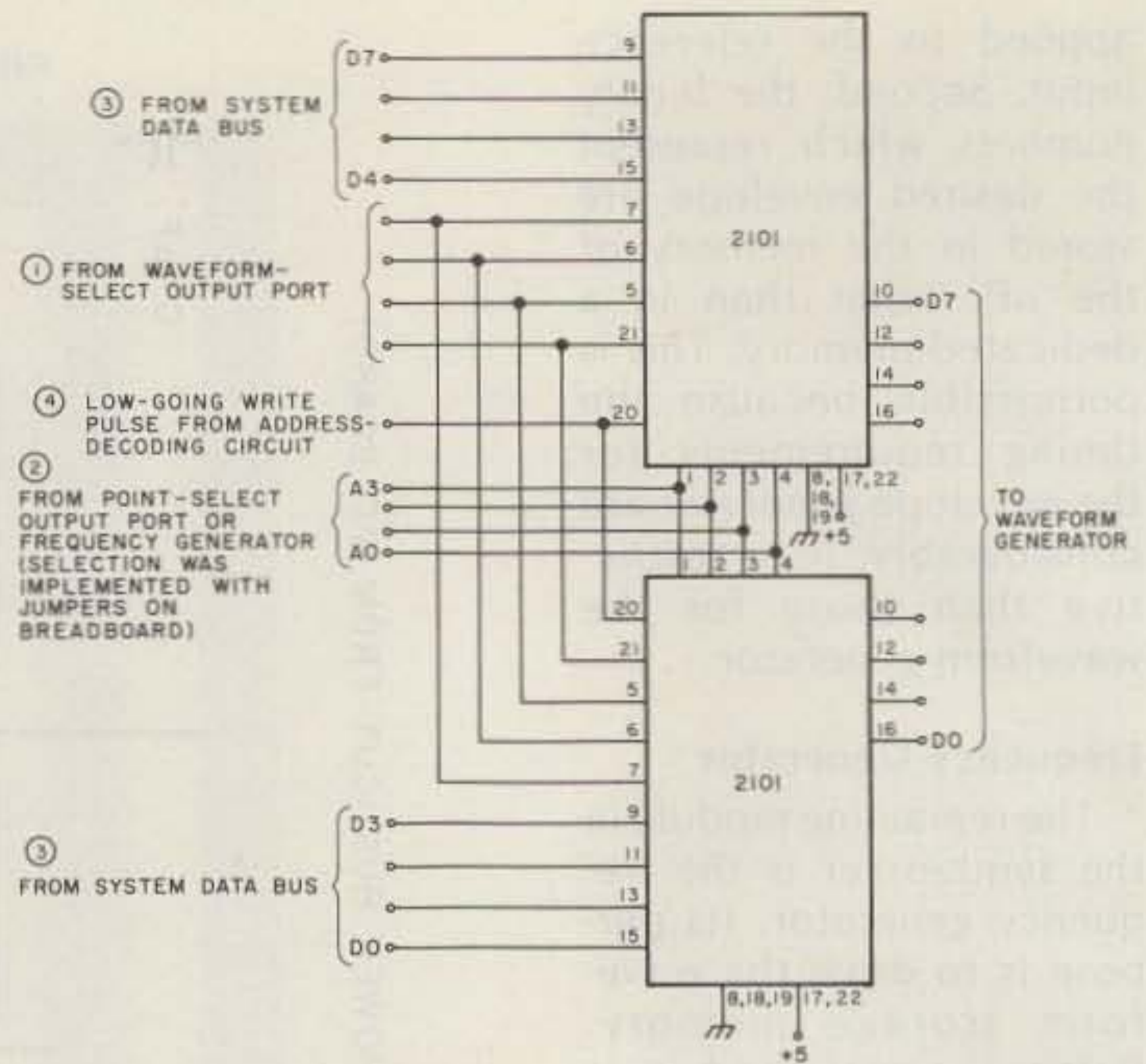

Fig. 20. Breadboard circuit of waveform memory using RAM.

form storage memory in the proper manner. The fundamental frequency of the lowest-frequency square wave of the four is then the fundamental frequency of the waveform the synthesizer will produce.

Construction

Before discussing construction, let's note that the synthesizer can be used with almost any uP system. All that's required is a source of power and three output ports to transfer information to the syn-

thesizer. The schematics and PC-board layouts reflect this. However, the synthesizer was developed in connection with my own particular uP system, what I call A Beginner's Microprocessor System (BMPS, a 6502-based computer).² For those who will use the synthesizer with a similar system, the schematics and PC-board layouts contain additional details. Those who will use a different uP system or those who expand their BMPS to include three output ports should ignore the additional

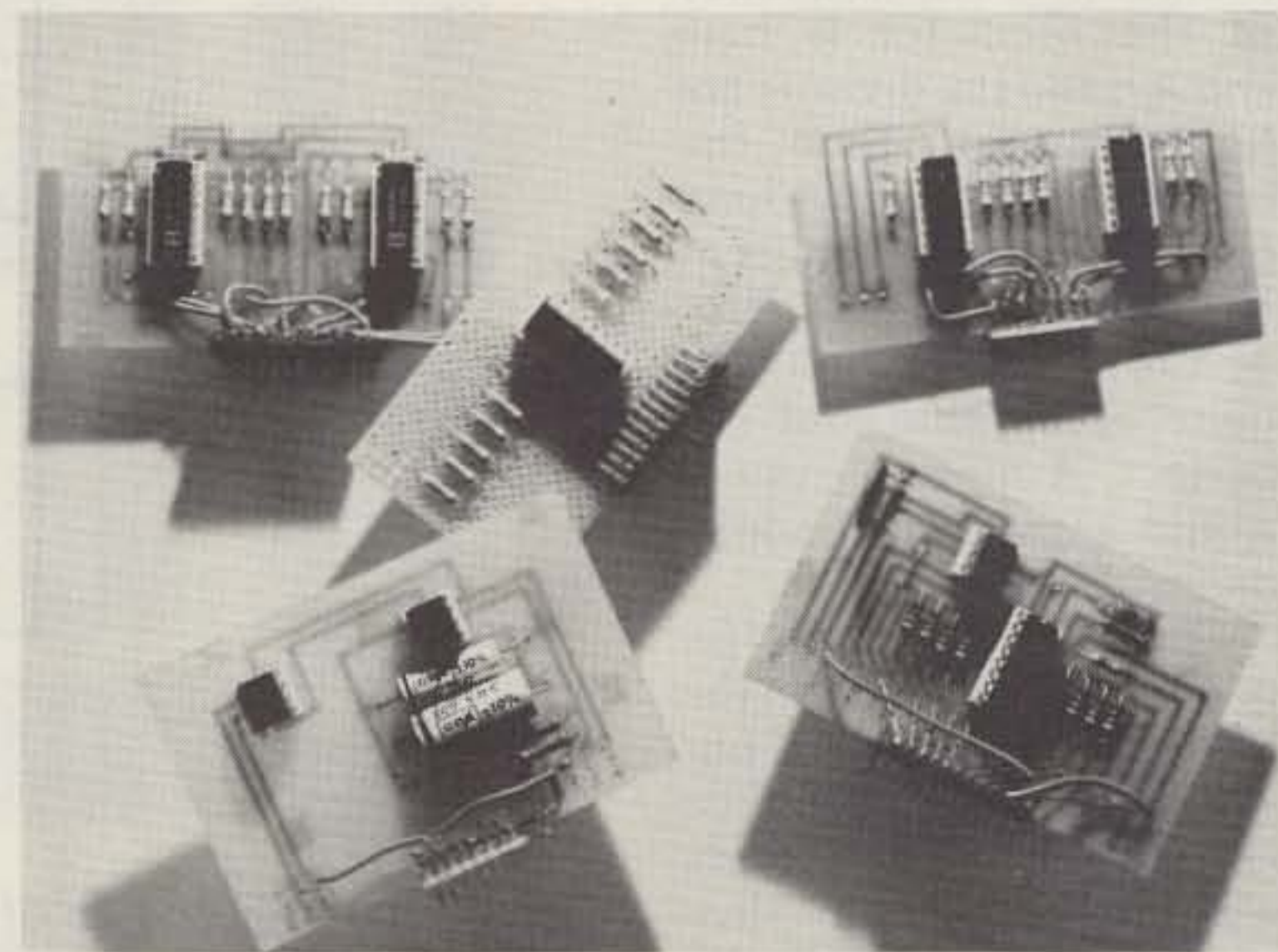

Fig. 22. Photo of modules.

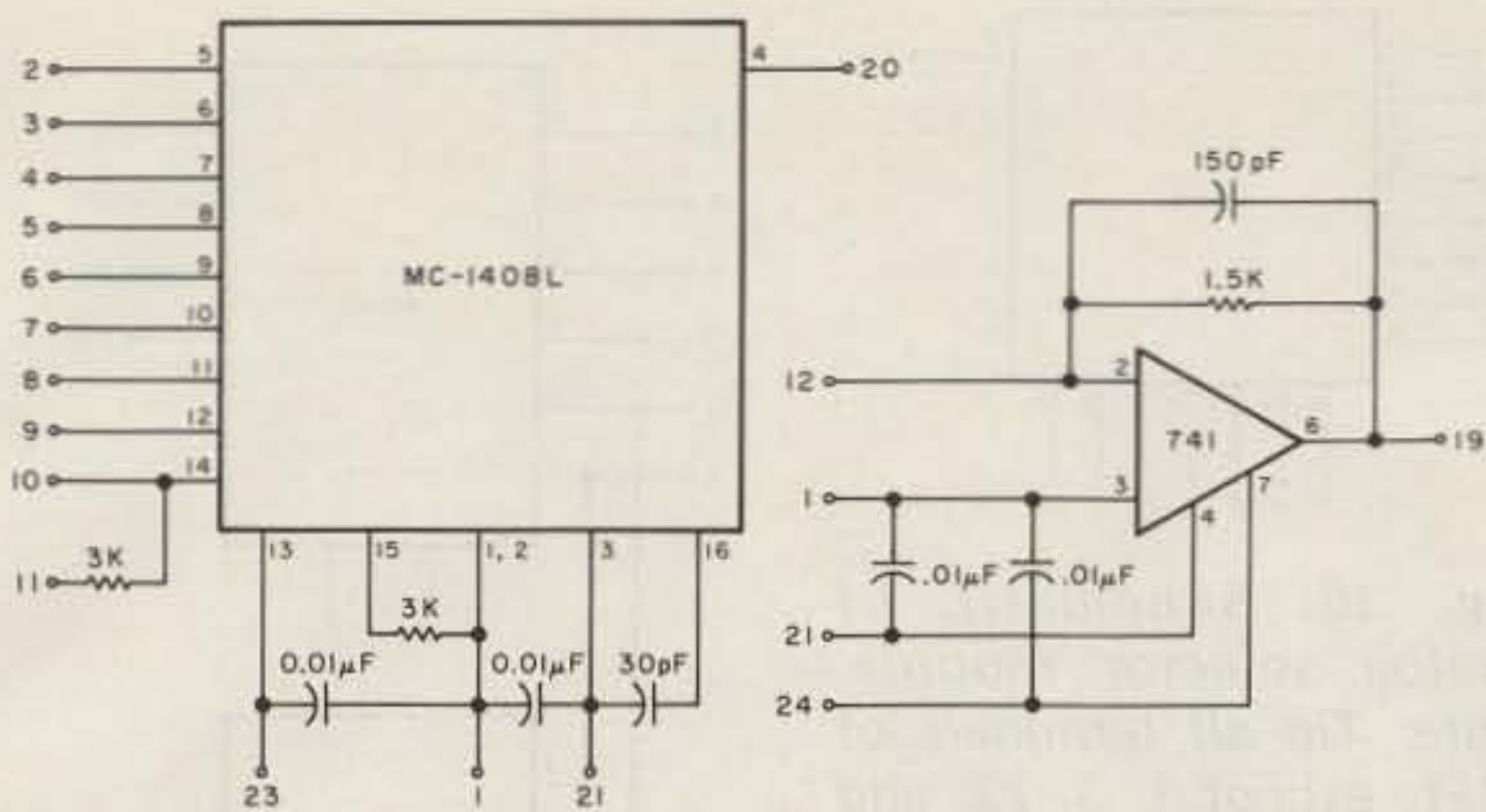

Fig. 23. Schematic of D/A converter module. Note: Tie pins 5-12 of MC1408L to ground via eight 47k resistors.

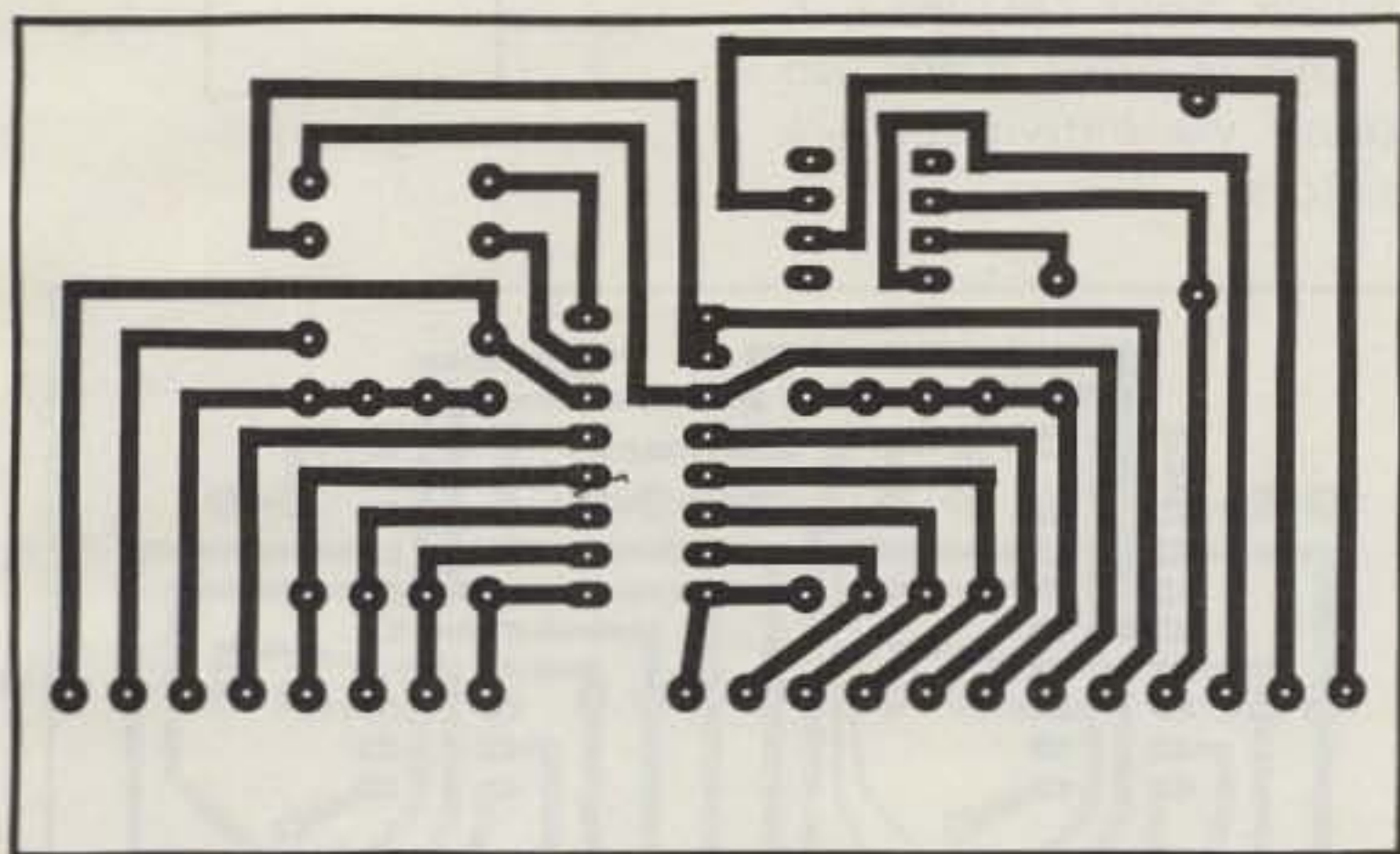

Fig. 24. Foil side of PC board, D/A converter.

details. Each instance will be noted, as encountered.

A schematic of the frequency generator is shown in Figs. 15(a) and 15(b). The oscillator is an MC4024, with a 7.772 MHz crystal as the frequency-determining element. A 100-pF variable capacitor may be substituted for the crystal in the interest of economy. Since CMOS ICs don't function reliably above about 3 MHz when 5-volt power is used, low-power-Schottky 74LS161 programmable dividers are used. Onboard CMOS ICs are used to drive the frequency-select inputs of the dividers in order to avoid running long leads from off the board to those inputs. In fact, the remaining digital ICs in the entire synthesizer are CMOS, because of their forgiving nature concerning long leads.

A 74C02 NOR gate feeds

back "load" pulses to the programmable dividers. Since the repetition rate of that series of pulses is the frequency of interest, the pulse train is applied to a 74C74 type D flip-flop which is configured as a binary divider. The 74C74 produces a square wave which is applied to a CD4024 seven-stage binary divider. This device simultaneously produces

| Cutoff Frequency, Hz* | R1, Ω | R2, Ω | R3, Ω | C1, μF | C2, μF |
|-----------------------|-------|-------|-------|--------|--------|
| 100 | 11254 | 5627 | 11254 | 0.4 | 0.1 |
| 200 | 5627 | 2813 | 5627 | 0.4 | 0.1 |
| 400 | 2813 | 1407 | 2813 | 0.4 | 0.1 |
| 600 | 3751 | 1876 | 3751 | 0.2 | 0.05 |
| 800 | 2813 | 1407 | 2813 | 0.2 | 0.05 |
| 1000 | 2251 | 1125 | 2251 | 0.2 | 0.05 |
| 1200 | 1876 | 938 | 1876 | 0.2 | 0.05 |
| 1500 | 7503 | 3751 | 7503 | 0.04 | 0.01 |
| 2000 | 5627 | 2813 | 5627 | 0.04 | 0.01 |
| 5000 | 2250 | 1125 | 2250 | 0.04 | 0.01 |

*Rolloff is 12 dB/octave. Response at "cutoff" frequency is down 3 dB. Low-frequency gain is unity.

Fig. 27. Component values for filters.

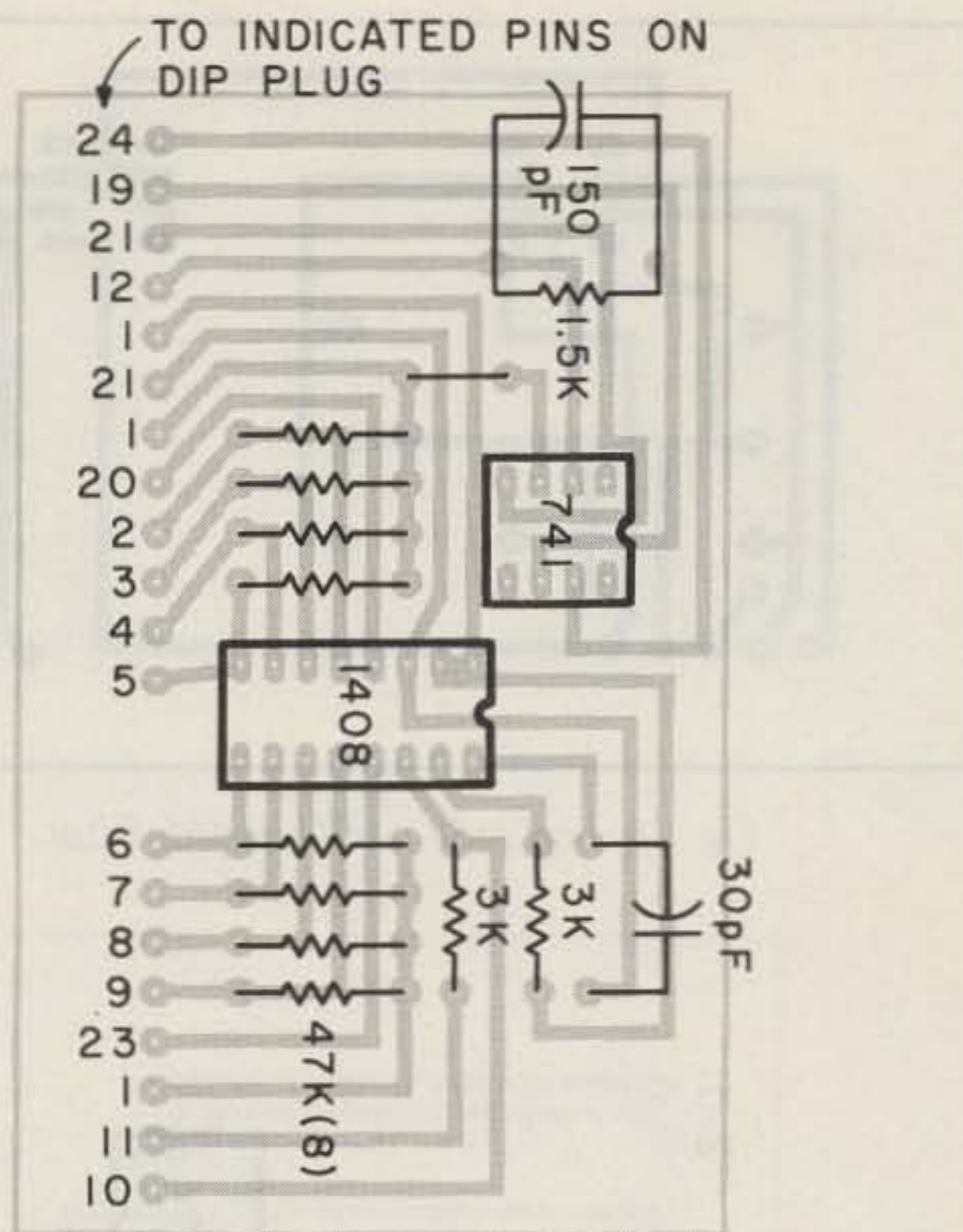

Fig. 25. Component side of PC board, D/A converter. Notes: (1). Foil pattern does not correspond exactly to the photograph. (2). Bypass +5, +12, and -12 V power leads to ground at IC sockets.

an output in each octave that the synthesizer covers. One of these outputs is passed on by the 74C151 selector. Which one depends on the 3-bit binary word that is applied to the address inputs of the 74C151. Since the 74C151 is a CMOS device, its address inputs need not be buffered. Finally, a second CD4024 is used to produce the set of four square waves which drives the waveform storage mem-

To interface the frequen-

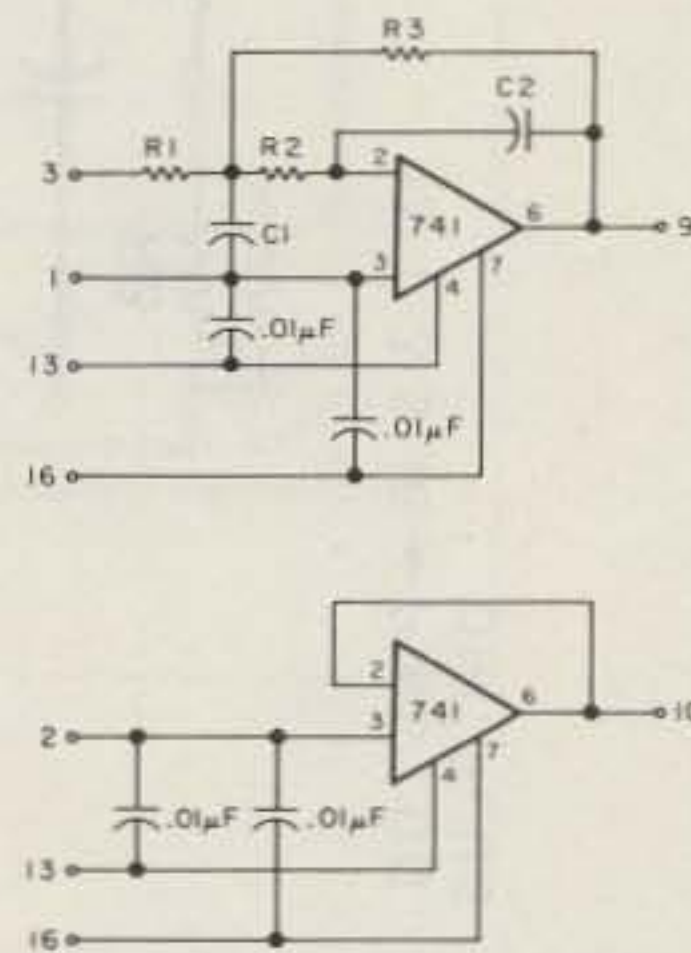

Fig. 26. Schematic of filter module.

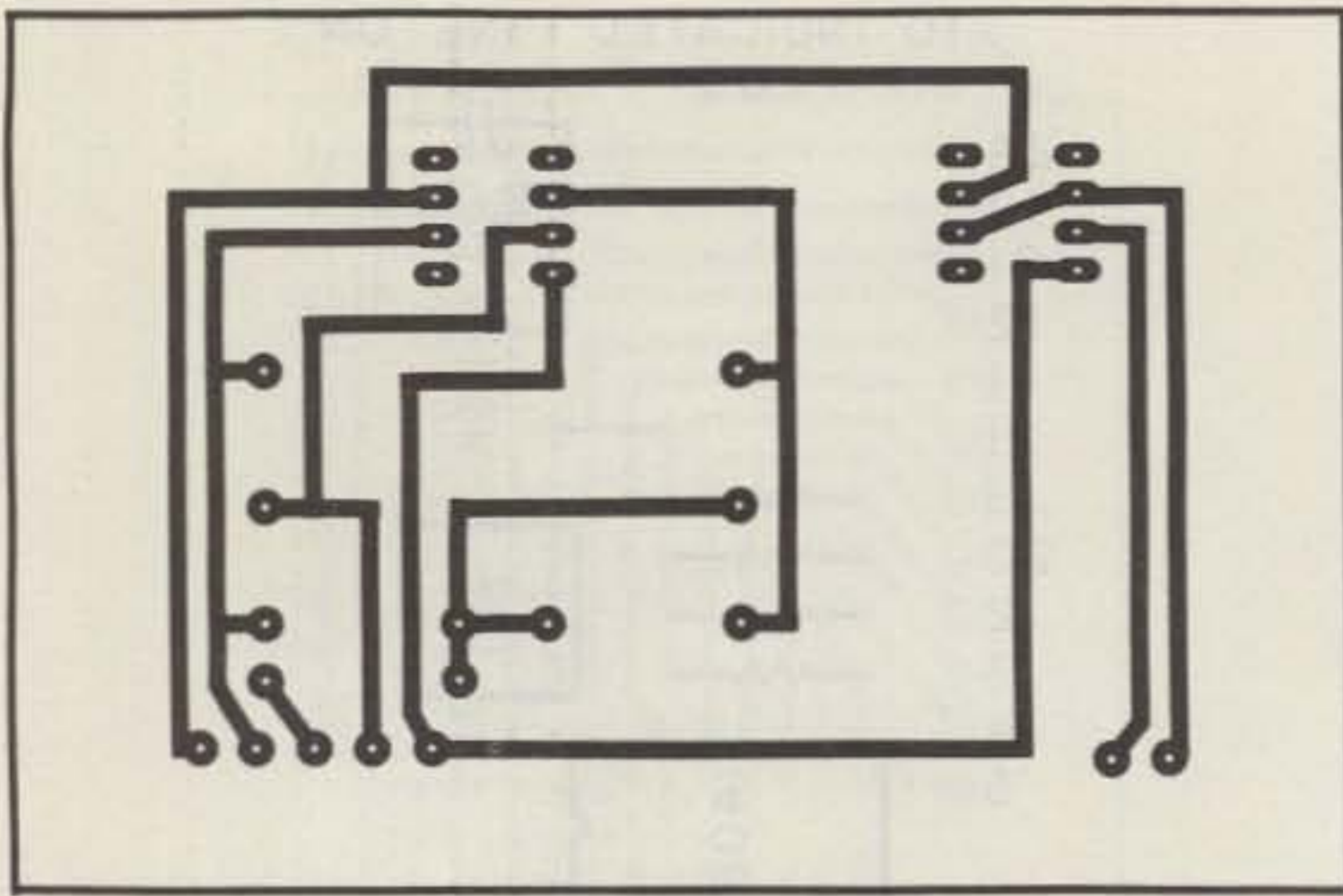

Fig. 28. Foil side of PC board, filter.

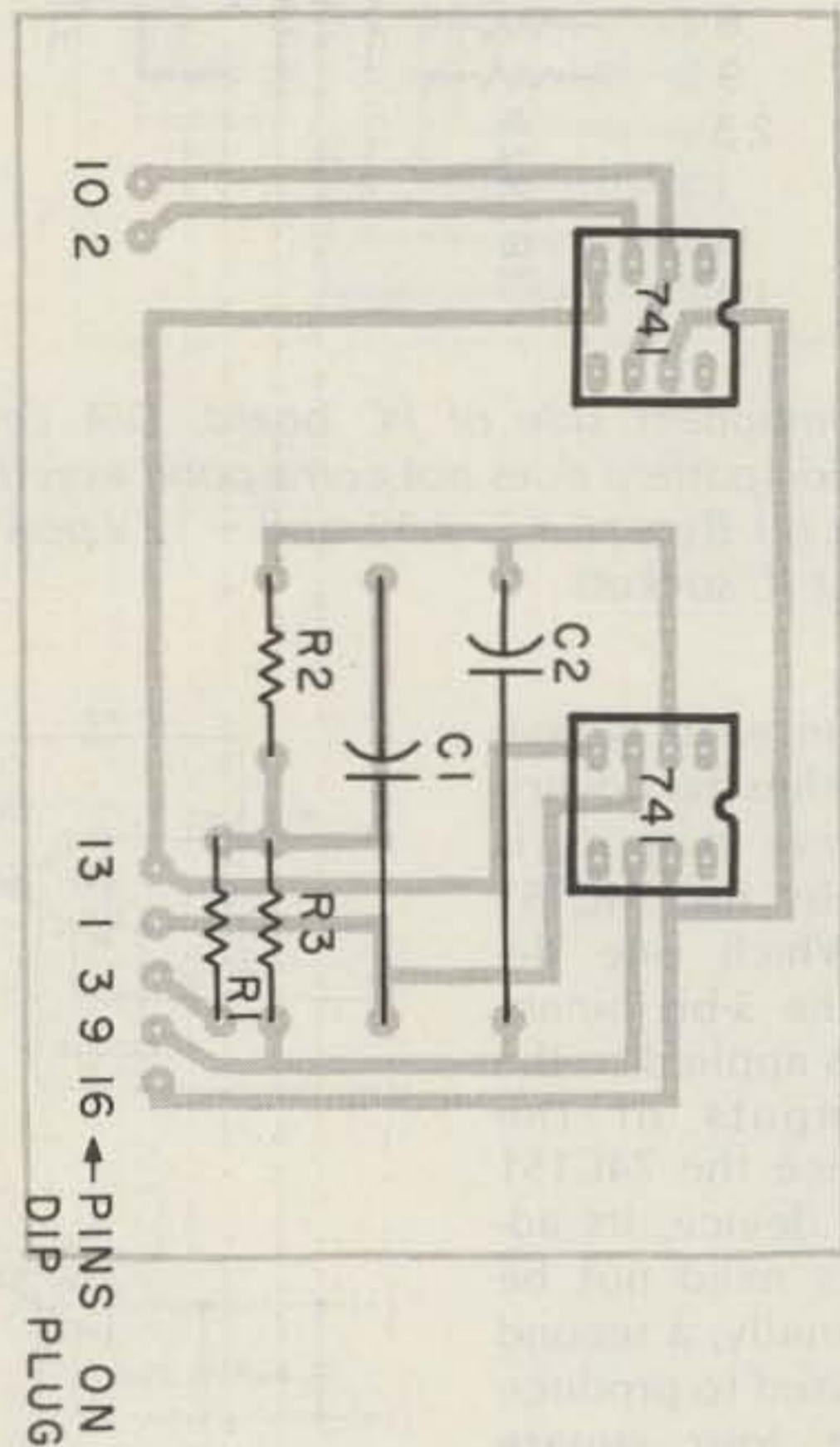

Fig. 29. Component side of PC board, filter. Notes: (1). Foil pattern does not correspond exactly to photograph. (2). Bypass +12 and -12 volt power leads to ground at IC sockets.

cy generator requires the additional circuitry shown in Fig. 16. A pair of CD4042 latches provides the 8-bit output port which drives the frequency-select circuit. A single CD4042 provides the 3-bit output port which drives the octave-select circuit. Strobe signals for the latches are produced by a CD4012 dual 4-input NAND gate. Address line A15 (inverted), address line A14, and the

ϕ_2 clock signal are each applied to both gates. In addition, address line A3 is applied to the gate which strobes the frequency-select latches, and address line A4 is applied to the gate which strobes the octave-select latch. This means that the address of the former is 4008 and the address of the latter is 4010.

The PC-board layout for the frequency generator is

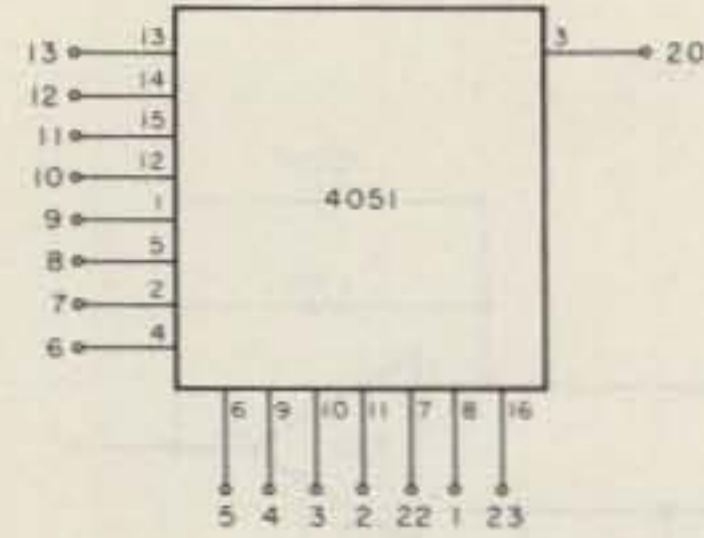

Fig. 30. Schematic of analog selector module. Note: Tie all terminals of 4051, except 1, 3, 22, and 23, to ground via individual 47k resistors.

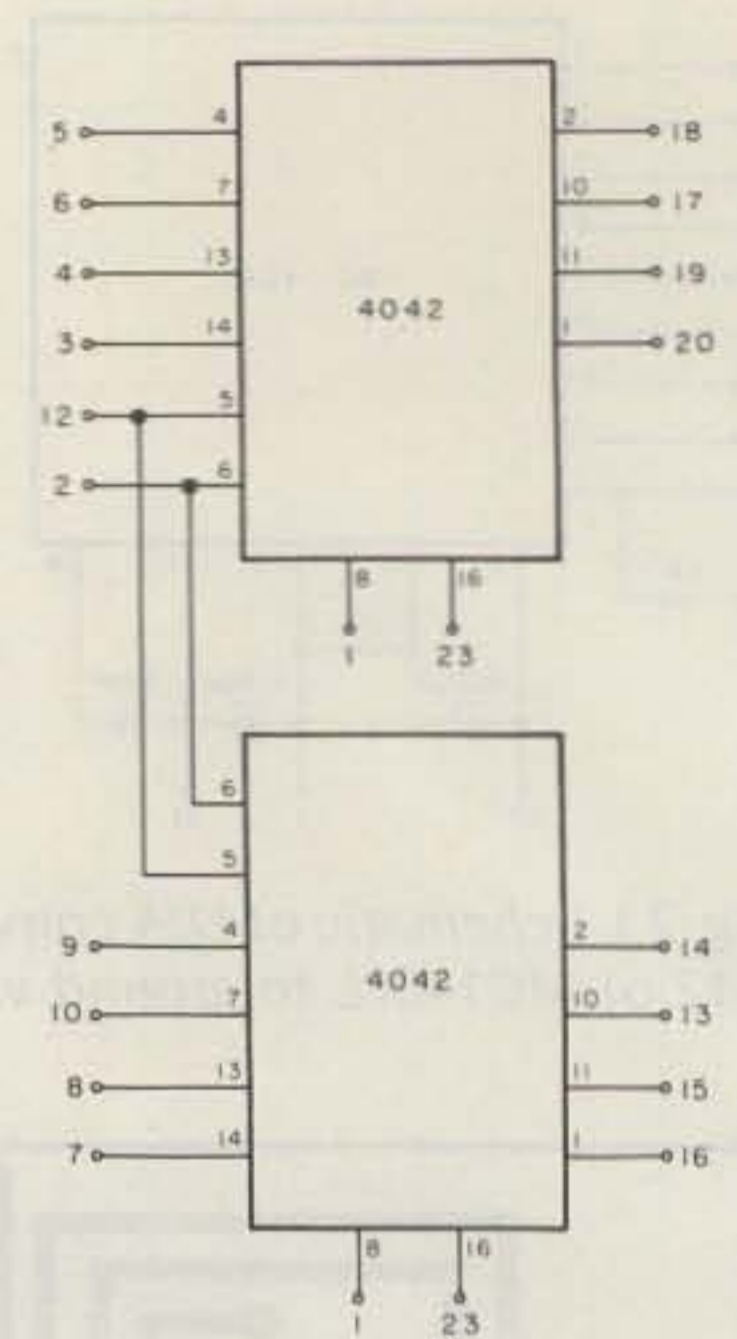

Fig. 31. Schematic of latch module. Note: Tie pins 4, 7, 13, and 14 of each 4042 to ground via individual 47k resistors.

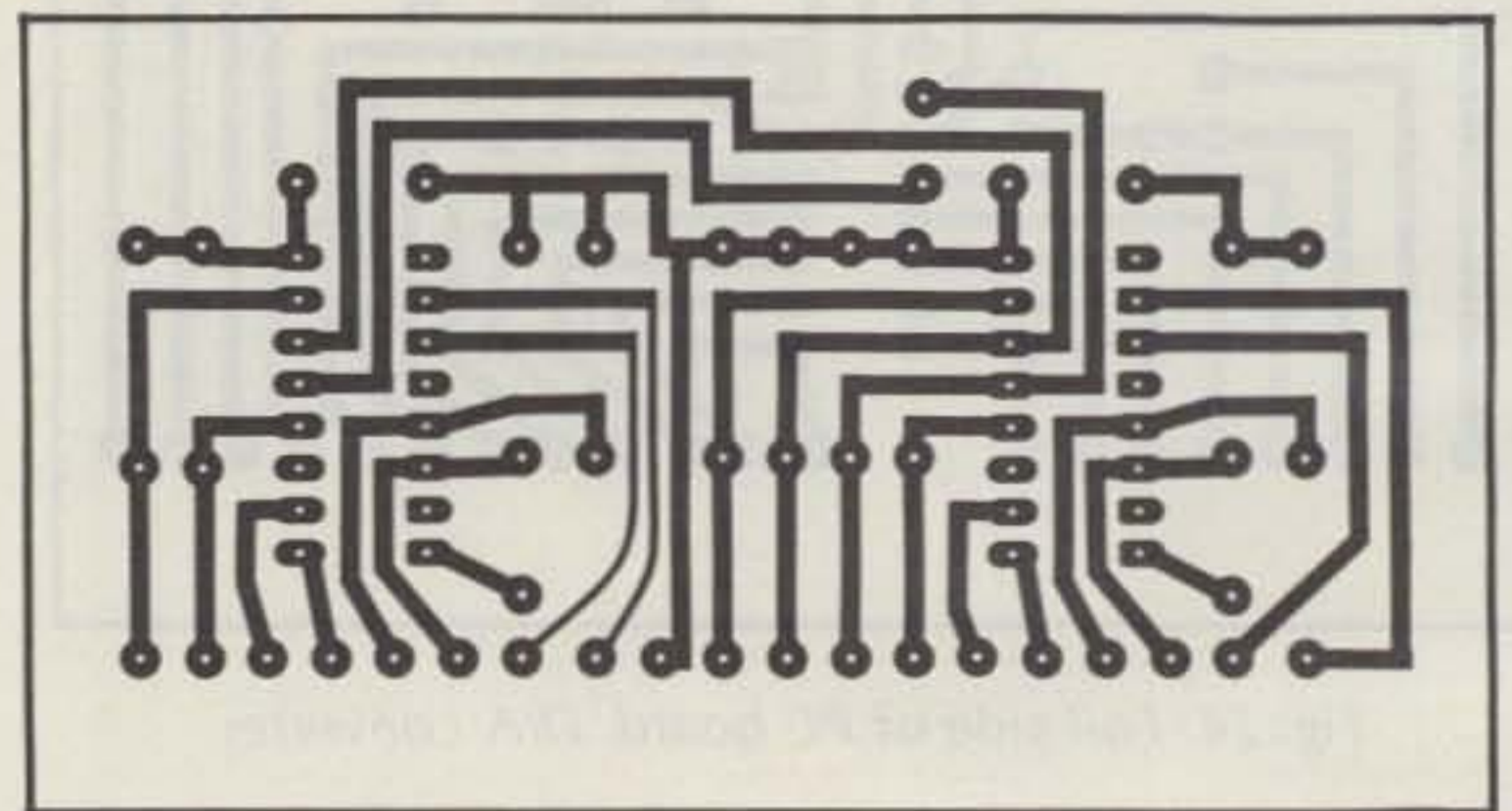

Fig. 32. Foil side of PC board, latch.

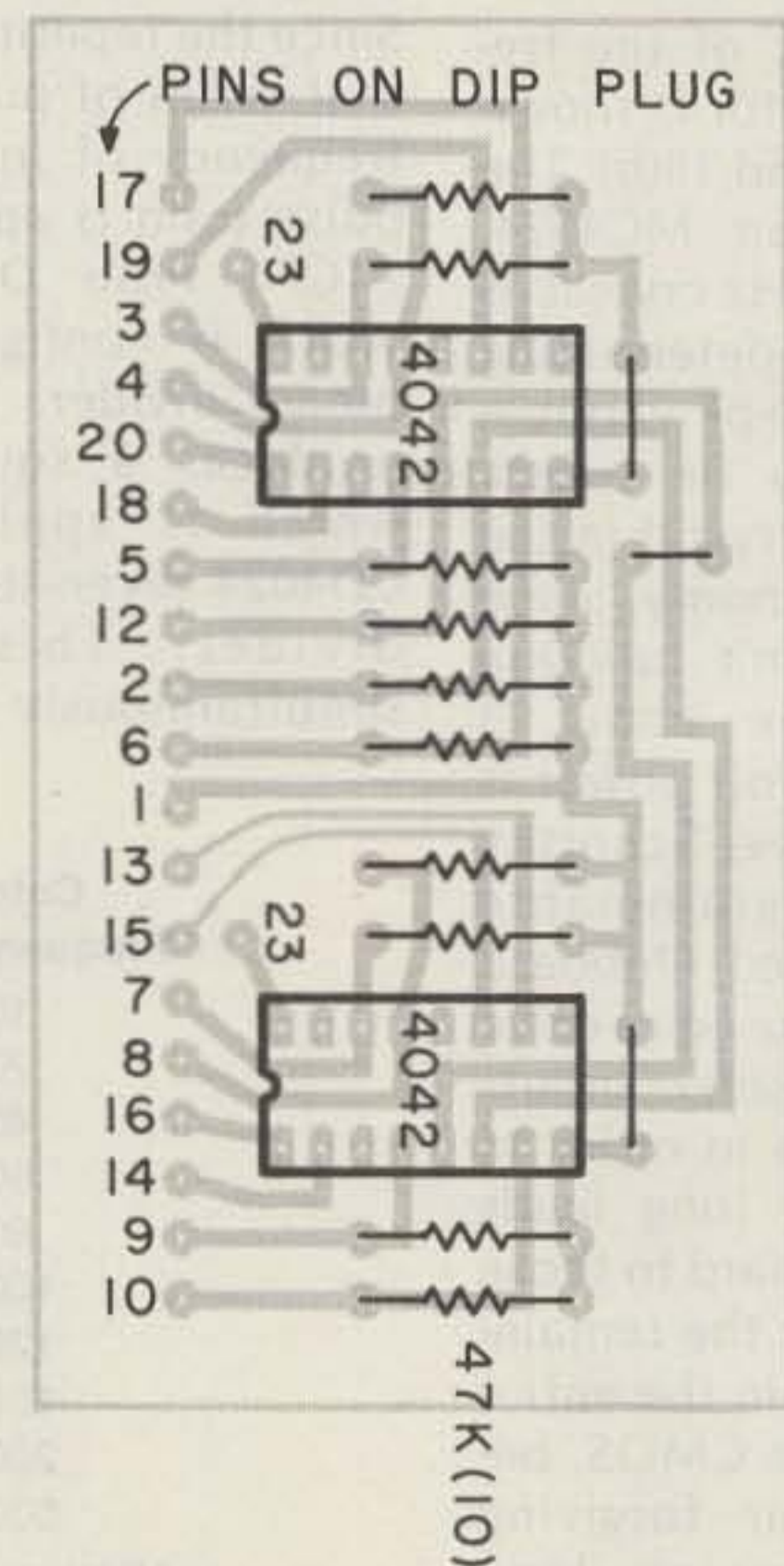

Fig. 33. Component side of PC board, latch. Note: Pin 1 of 4042s is at bottom of layout.

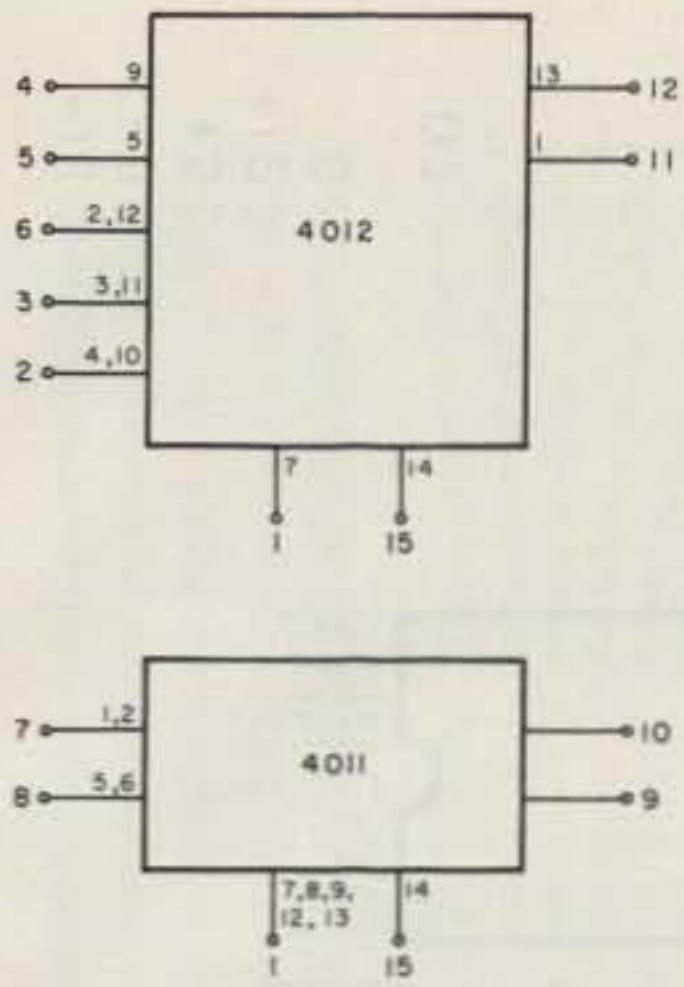

Fig. 34. Schematic of pulser module. Note: Tie inputs 2, 3, 4, 5, 9, 10, 11, and 12 of 4012 to +5 volts, and 1, 2, 5, and 6 of 4011 to ground via 47k resistors. It is okay to pair, as shown.

tor and the interface to the BMPS. Those who have this system should use the entire layout with CD4049 inverters as the buffers. (An inverter is needed in the address-decode logic, Fig. 16.) Since the \bar{Q} outputs of the 4042 latches are

shown in Figs. 17 and 18. It includes both the genera-

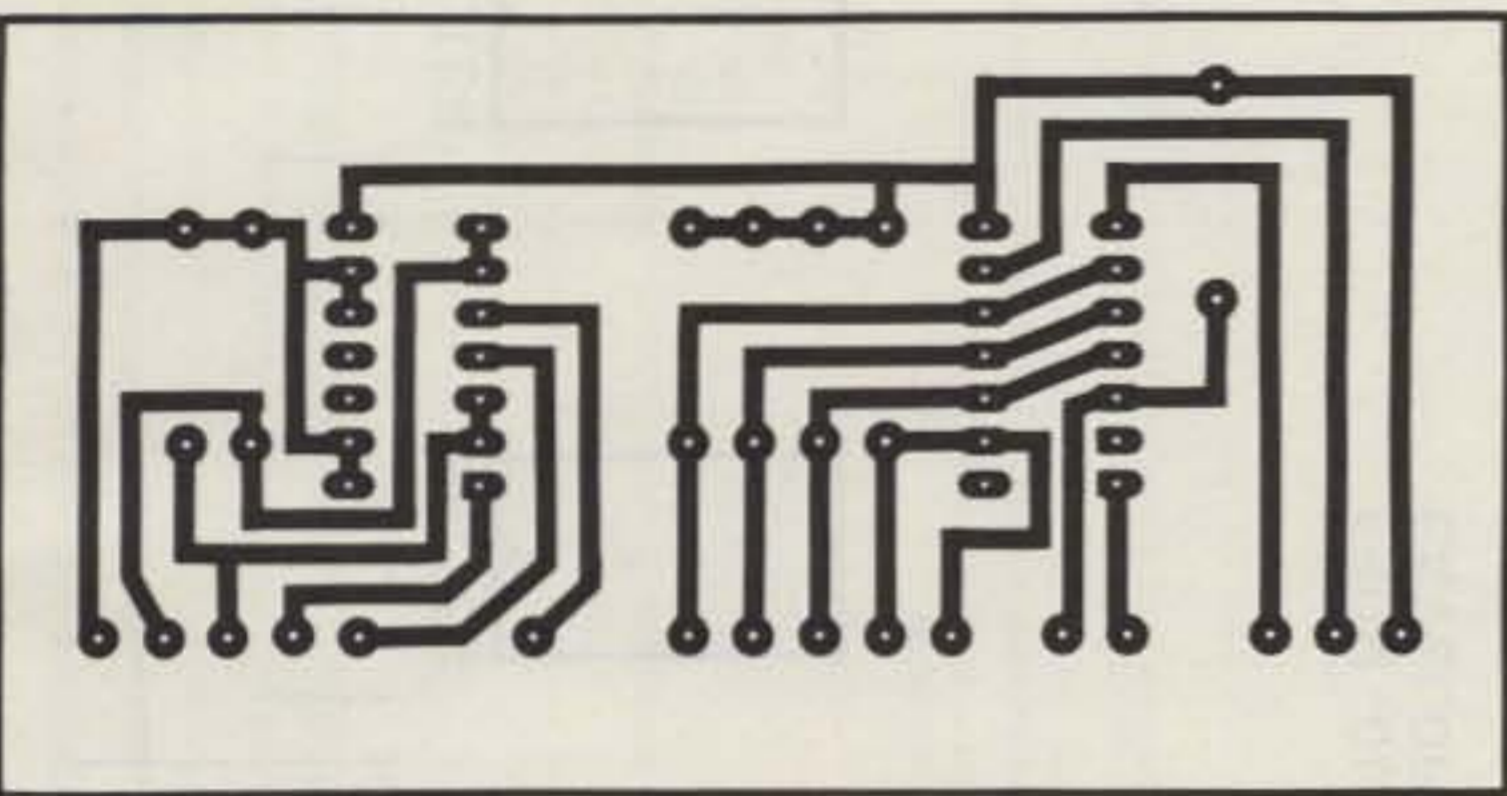

Fig. 35. Foil side of PC board, pulser.

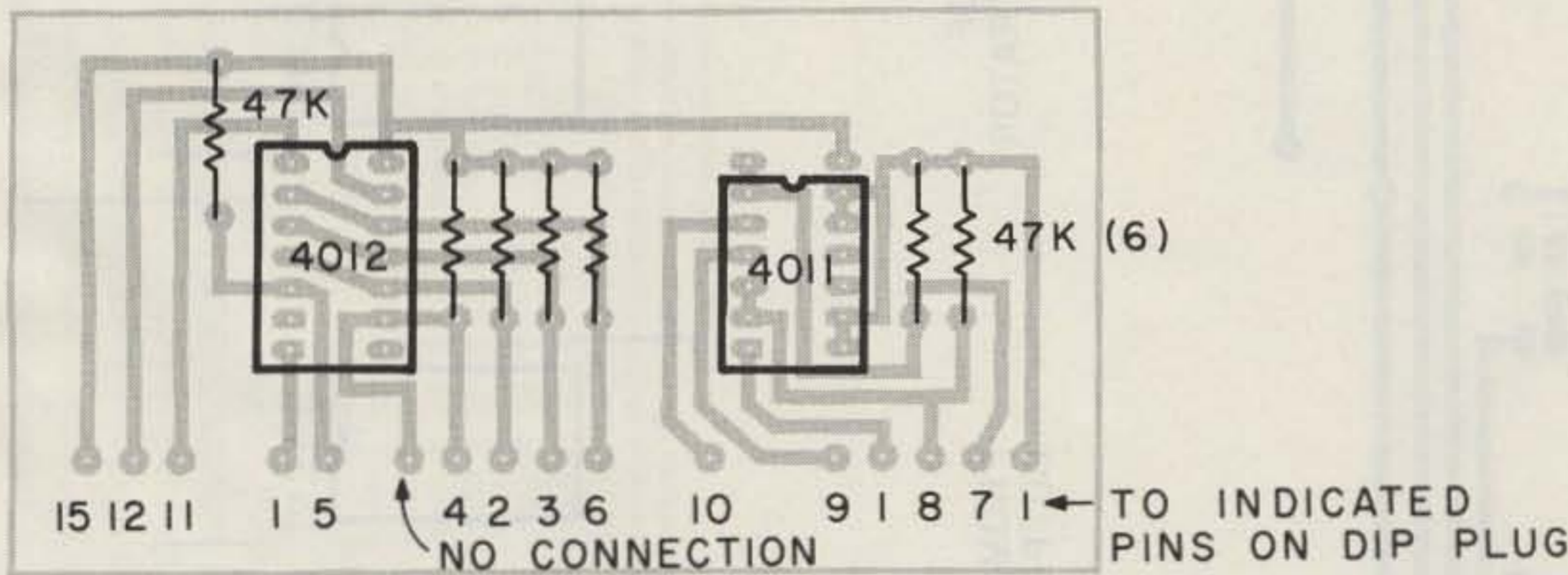

Fig. 36. Component side of PC board, pulser.

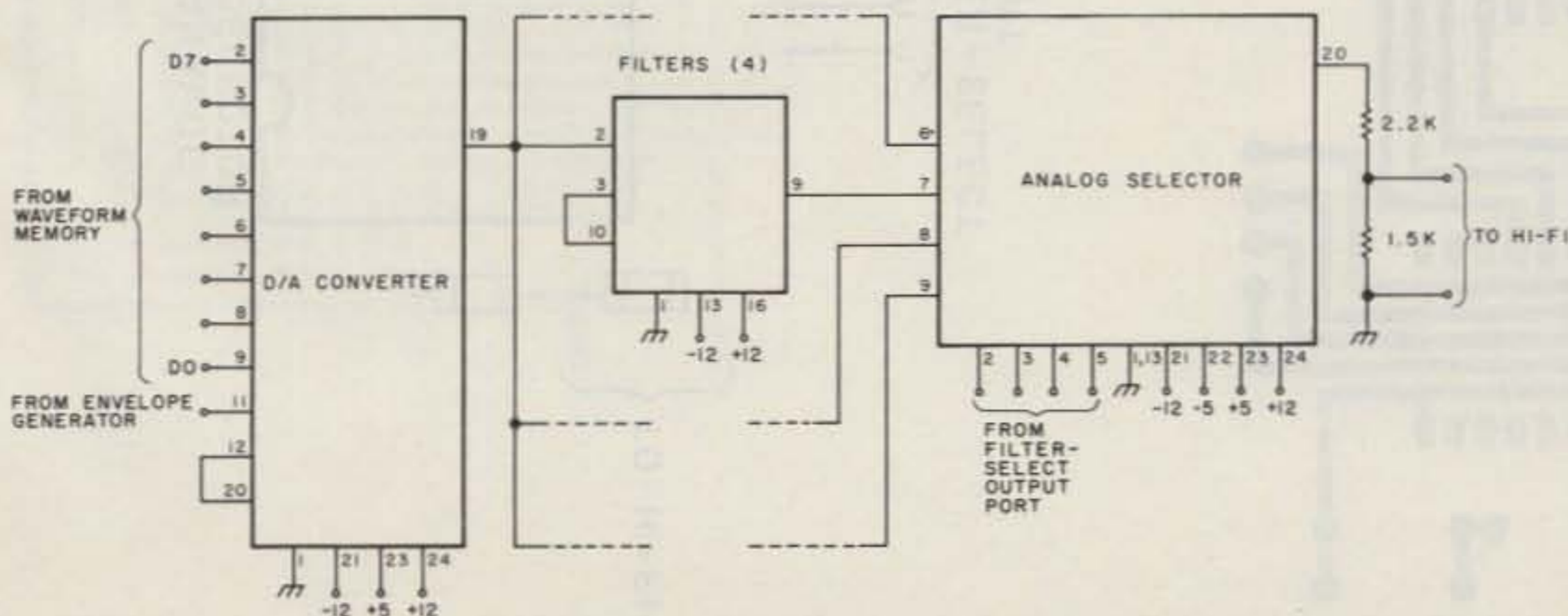

Fig. 37. Schematic of waveform generator.

VHF DF



We have a portable direction finder that REALLY works—on AM, FM, pulsed signals and random noise! Unique left-right DF allows you to take accurate bearings even on short bursts, with no 180° ambiguity. Its 3 dB antenna gain and .06 uV typical DF sensitivity allow this crystal-controlled unit to hear and positively track a weak signal at very long ranges—while built-in RF gain control with 120 dB range permits DF to within a few feet of the transmitter.

The DF is battery-powered, can be used with accessory antennas, and is 12/24V for use in vehicles or aircraft. This is a factory-built, guaranteed unit—not a kit. It has been successful in locating malicious interference, as well as hidden transmitters in "T-hunts," ELTs, and noise sources in RFI situations.

Prices start at under \$175. Write or call for information on our complete line of portable, airborne, vehicle, and fixed DF systems.

L-TRONICS

5546 Cathedral Oaks Rd.,
Amateur Dept.
Santa Barbara, CA 93111

W6GUX

WD6ESW

L10

used, the data is inverted twice, which means that whatever number the uP applies to the latch will be applied to the 74LS161 dividers.

Those who use the synthesizer with some other uP system should construct only the portion of the layout above the dotted line shown in Fig. 18, and should use CD4050s as the buffers, as shown in Fig. 15(a). Note the jumper connection (Fig. 18) which must be made in this case to protect the input of the unused section of one CD4050.

In either case, the crystal socket or capacitor is mounted on the foil side of the board and a bus strip is used to provide power to several of the ICs, as shown in Fig. 19.

In my system, I use a sixteen-word diode-implemented programmable memory as the waveform

storage memory. It was left over from previous experiments and provided a quick and easy way to get started. While details concerning such a memory are

contained in reference 2, a "from-scratch" implementation probably should be based on a conventional RAM, ROM, or shift register. The circuits shown in

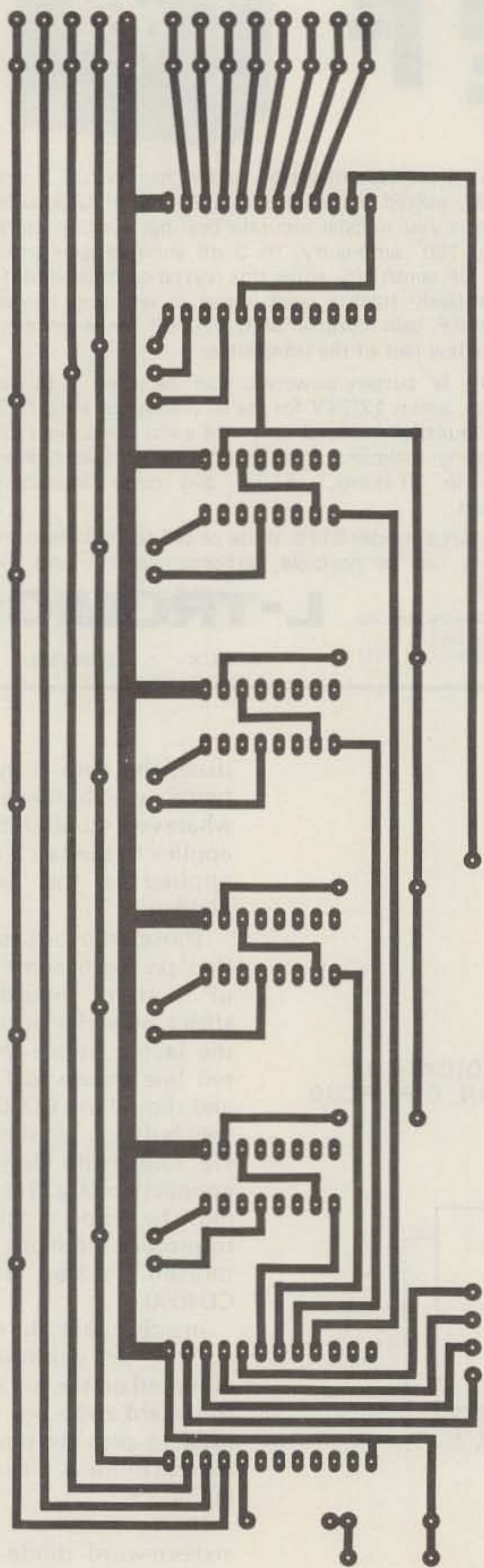

Fig. 38. Foil side of PC board, waveform generator.

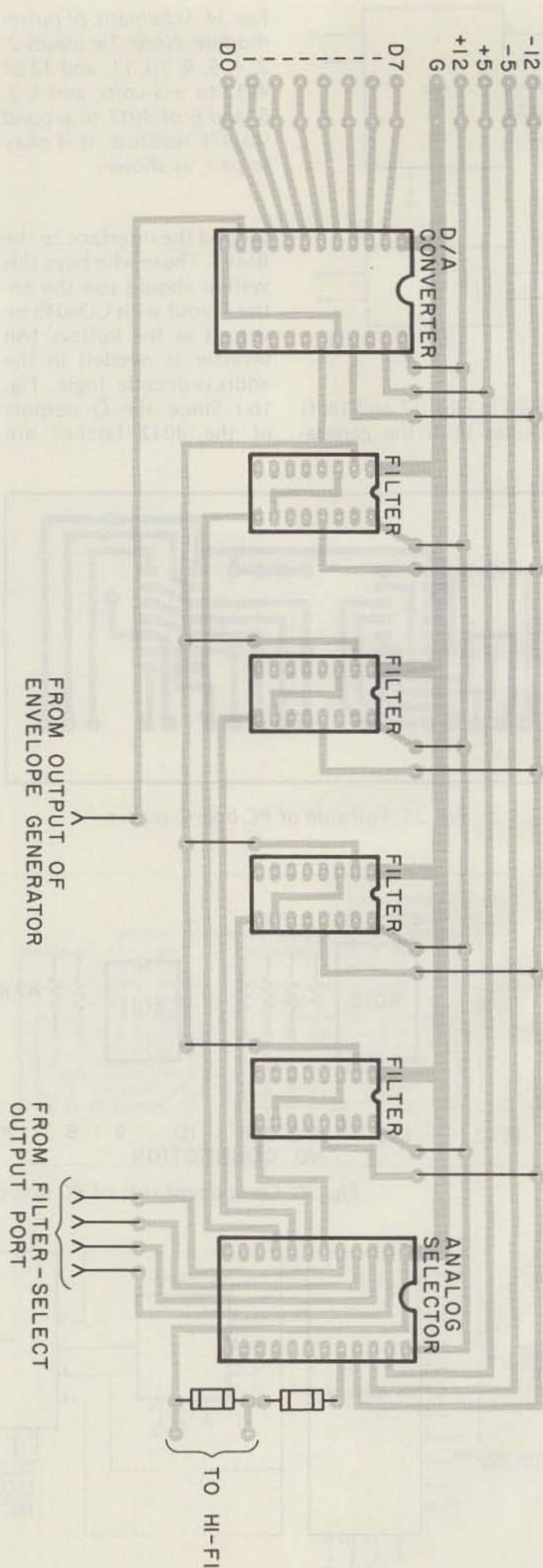

Fig. 39. Component side of PC board, waveform generator.

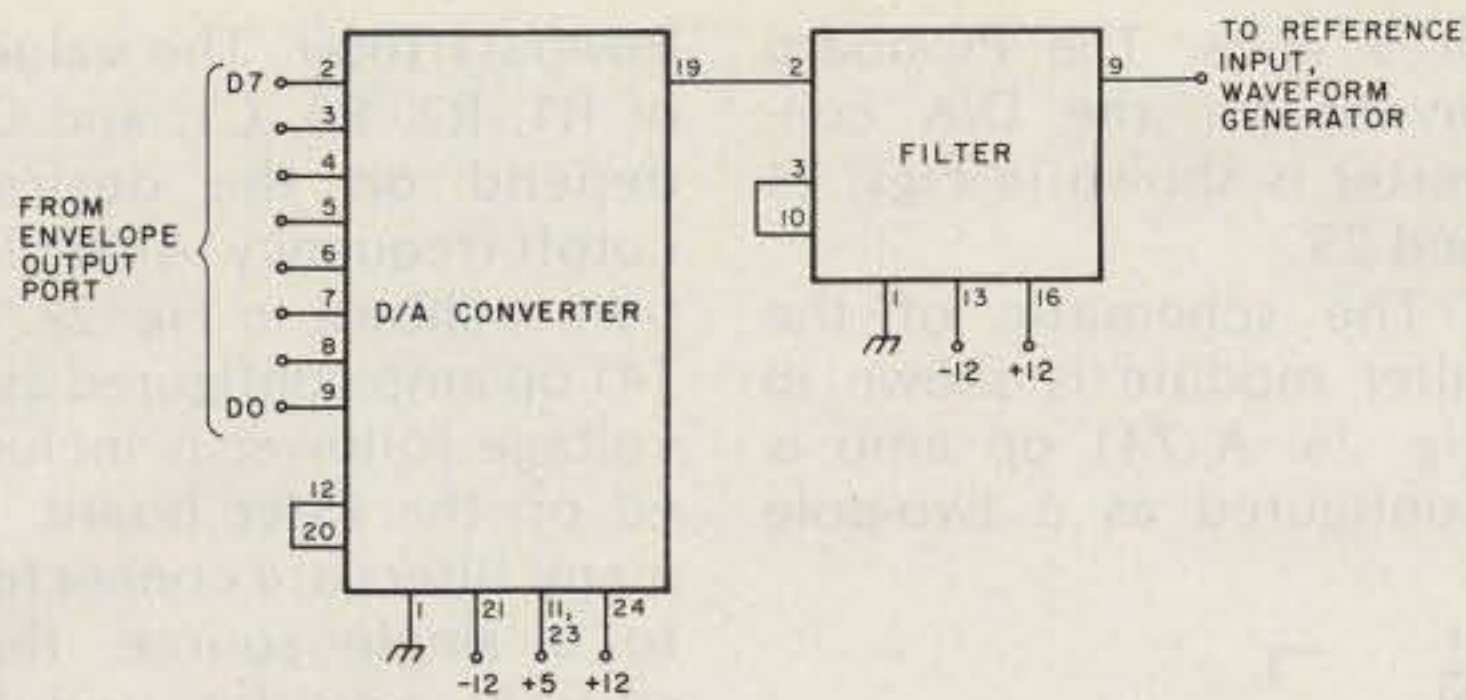

Fig. 40. Schematic of envelope generator.

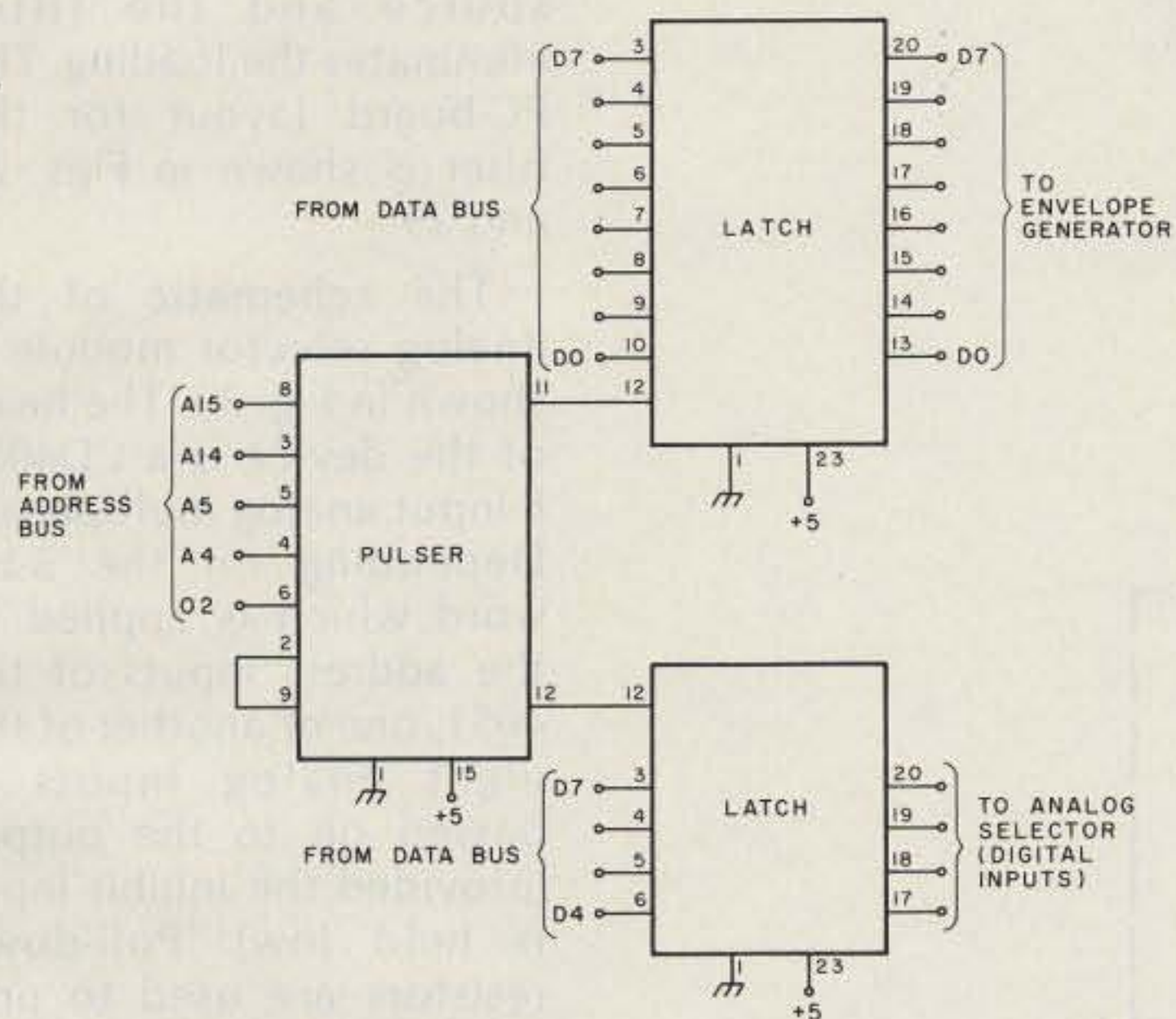

Fig. 41. Circuit to interface generators to BMPS.

Figs. 20 and 21 are based on successful breadboard experiments, but no PC boards were ever worked up.

The RAM version is programmed by applying a 4-bit address at point 1 in Fig. 20. This selects a block of 16 words within the memories. The number 0000_{16} is then applied at point 2. The 8-bit word to be written into that location is applied at point 3. Then, a low-going write pulse is applied at point 4. The steps are repeated (the number applied at 2 is incremented each time) until the 16-word block is programmed. The RAM version then is used by tying point 4 to +5 volts, and connecting the frequency generator at 2.

The remainder of the synthesizer is modular in construction. However,

this need not be the case for the person who plans no further experimentation in synthesizer design. The circuits of the individual modules can be grouped on a single PC board which can also contain the frequency generator.

The person who uses other than an unexpanded BMPS to drive the synthesizer will require the following modules: 2 D/A converters, 2-5 filters, and 1 analog selector. The person who does use an unexpanded BMPS will require the following additional modules: 2 latches and 1 pulser.

Each module is constructed in a small board which is epoxied to a DIP plug. In this way, fairly complex functions are available in plug-in form. As a result, the master board which holds several

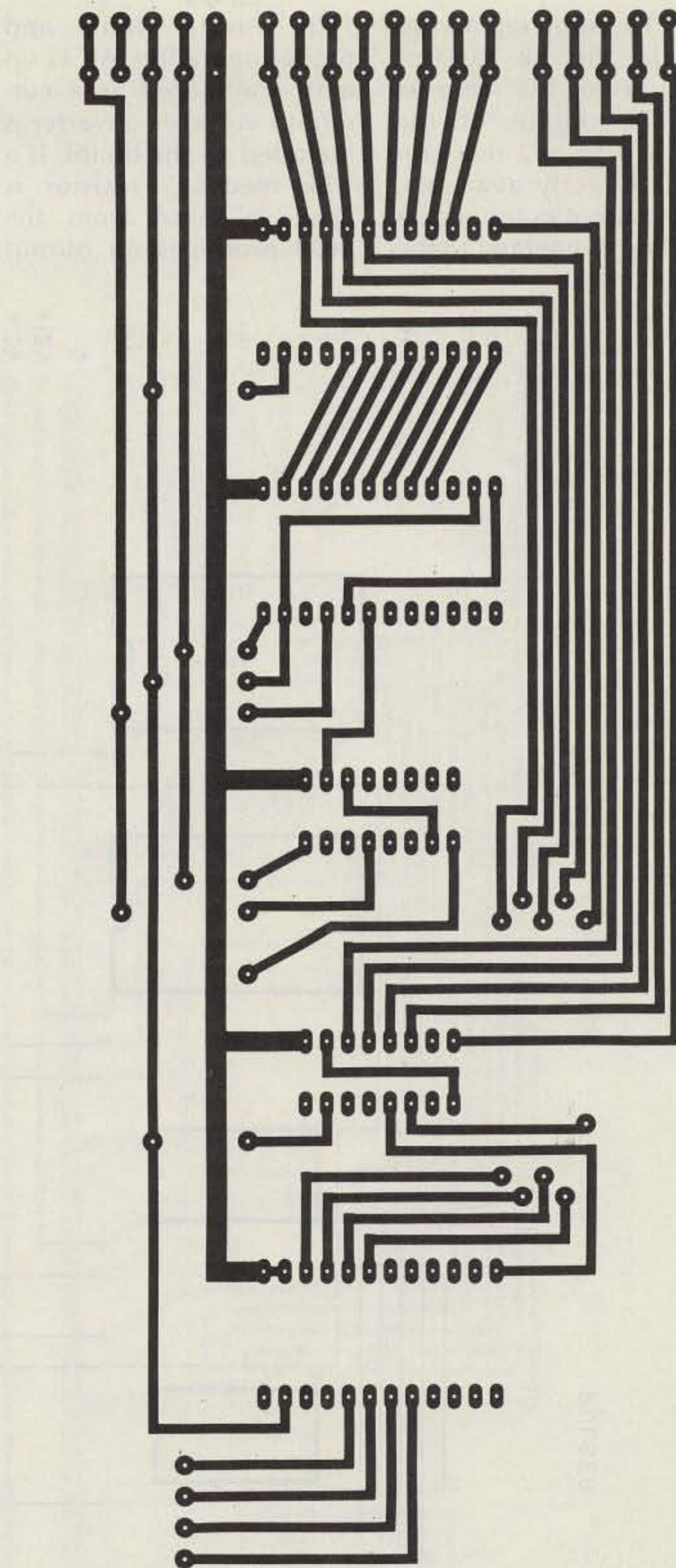

Fig. 42. Foil side of PC board, envelope generator.

modules is very simple to construct or modify. The modules themselves need no modification even if the system is radically altered. The five types of modules are shown in Fig. 22.

The schematic of the D/A converter module is shown in Fig. 23. The converter is an MC1408L 8-bit device. Each binary input (pins 5-12) should be pulled

down to ground via a 47k resistor (not shown in diagram). This doesn't affect normal operations, but it protects the inputs of the 1408 when the module is not plugged in to the master board. The positive reference input, pin 14, is accessible both directly and via a 3k resistor. In the former case, a reference current is applied directly

to pin 14. Applying a voltage via the 3k resistor accomplishes the same result. The output of the 1408, a 0 to -2 mA current, is directly available. Other passive components which are connected to the

1408 ensure stable and proper operation. A 741 op amp configured as a current-to-voltage converter is included on the board. If a 1.5k feedback resistor is used, -2 mA from the 1408 produces an output

of 3 volts. The PC-board layout for the D/A converter is shown in Figs. 24 and 25.

The schematic of the filter module is shown in Fig. 26. A 741 op amp is configured as a two-pole

low-pass filter. The values of R1, R2, R3, C1, and C2 depend on the desired cutoff frequency. A tabulation is shown in Fig. 27. A 741 op amp configured as a voltage follower is included on the filter board. If many filters are connected to a single source, that source may be unduly loaded. Inserting a voltage follower between the source and the filter eliminates the loading. The PC-board layout for the filter is shown in Figs. 28 and 29.

The schematic of the analog selector module is shown in Fig. 30. The heart of the device is a CD4051 8-input analog multiplexer. Depending on the 3-bit word which is applied to the address inputs of the 4051, one or another of the eight analog inputs is passed on to the output (provided the inhibit input is held low). Pull-down resistors are used to protect the inputs of the CD4051. No PC-board layout is provided. Because of the small number of components, perf-board and point-to-point wiring are good choices.

The person who uses other than a basic BMPS should ignore the following material on the latch and pulser modules, since they are not required in that case.

The schematic of the latch is shown in Fig. 31. A pair of CD4042 latches is used, and pull-down resistors are provided to protect the inputs of the CD4042. The clock inputs of both 4042s are tied together and made available, as are the polarity inputs of both latches. The PC-board layout for the latch module is shown in Figs. 32 and 33.

The schematic of the final module, the pulser, is shown in Fig. 34. This device decodes address and timing information to

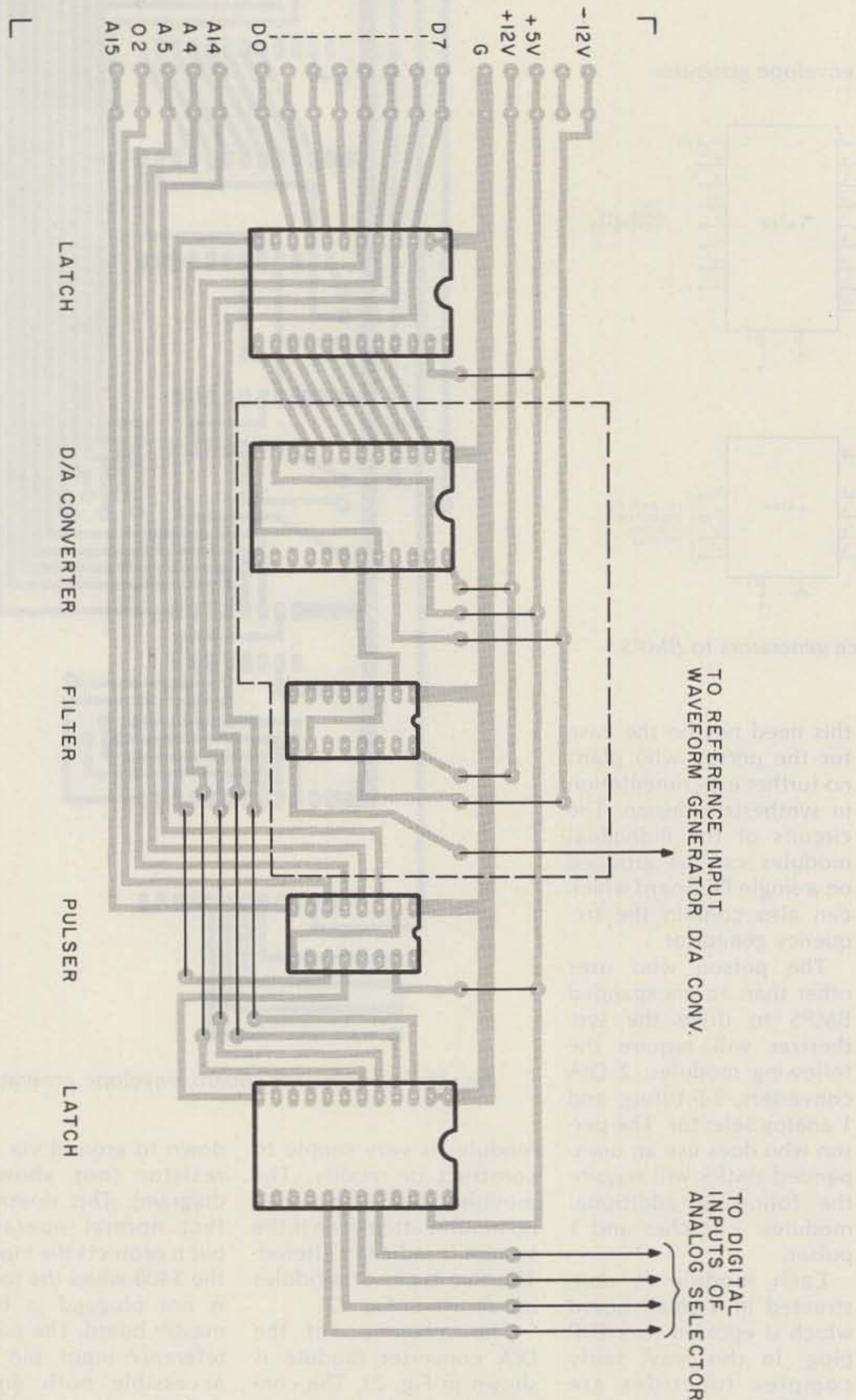

Fig. 43. Component side of PC board, envelope generator. Note: Dotted line encloses necessary functions, if BMPS is not used.

provide triggering pulses to latches. A pulser module and latch module together form an output port. Two sections of a CD4011 quad 2-input NAND gate are connected as inverters and are available in the uncommitted form. The inputs are protected by pull-down resistors. Pull-up resistors are provided for the inputs of the CD4012 dual 4-input NAND gate. Since the inputs of a NAND gate are active high, any unused inputs of the 4012 simply may be left unconnected (at the module level). PC-board layouts are shown in Figs. 35 and 36.

Interconnecting the various modules is straightforward. A schematic of the waveform generator is shown in Fig. 37.

The waveform generator (exclusive of the waveform storage memory) consists of a D/A converter, four filters, and an analog selector. The digital inputs of the D/A converter are driven directly by the waveform memory. The reference input of the D/A converter is driven by the envelope generator. The output of the D/A converter is applied to all the filters. The output of one filter is then passed on to a hi-fi system by the analog selector, depending on the four-bit word which is applied to the address and inhibit inputs of the selector. If the line to the hi-fi is more than about six feet long, add a voltage follower at the output of the resistive network.

The PC-board layout for the waveform generator is shown in Figs. 38 and 39. From left to right (component side), the filters are selected by applying 0100, 0101, 0110, or 0111 to the analog selector. Applying 0000 will ground the top of the resistive-divider network. This is handy for avoiding floating leads to hi-fi system inputs.

A schematic of the

envelope generator is shown in Fig. 40. It consists of a D/A converter and a

filter. These provide the reference voltage for the waveform generator. For

the person who doesn't use the basic BMPS, no additional functions within the

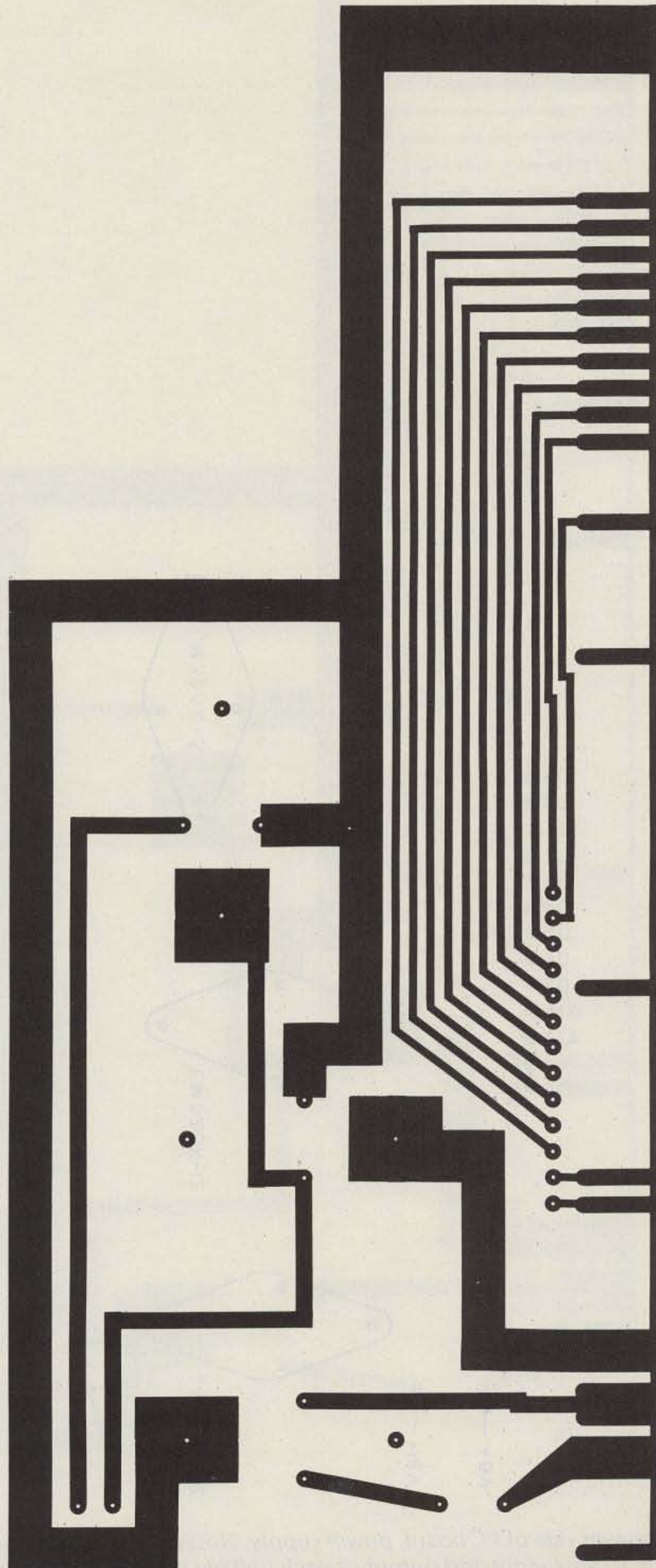

Fig. 44. Foil side of PC board, power supply.

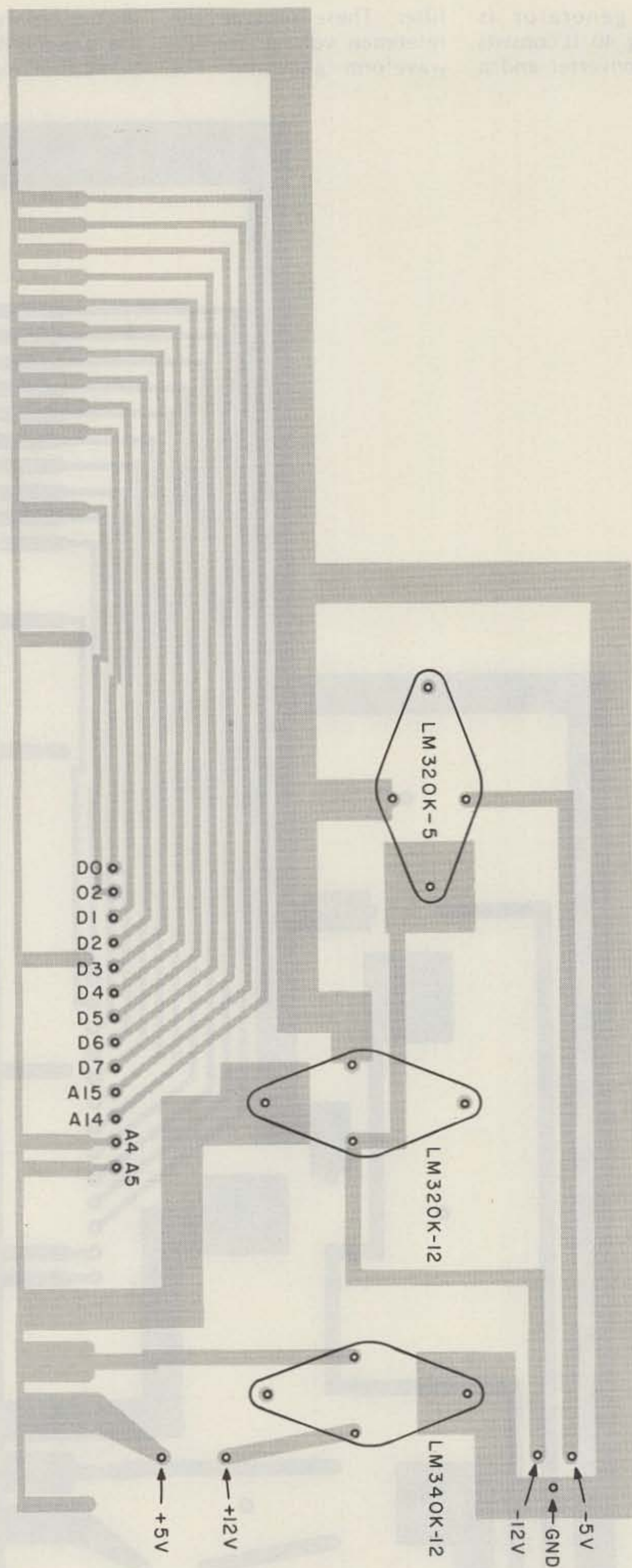

Fig. 45. Component side of PC board, power supply. Notes: (1). Use heat sink with voltage regulators. (2). Bypass input and output of each voltage regulator to ground via a 0.1 μ F disc ceramic capacitor and a 10 μ F tantalum capacitor.

envelope generator are required. For the person who does, the functions which are shown in Fig. 41 are required. These consist of two latches and a pulser. Together they form an 8-bit output port and a 4-bit output port. Since the 4-bit output port is used to drive the binary inputs of the analog selector, and thus selects the filter in the signal path, its address is assigned as 4010. This is the same address which is used to select the octave (frequency generator board). The reasoning involved is that if the octave is changed, a different filter may well be desirable.

The 8-bit output port is used to drive the D/A converter in the envelope generator. Its address is 4020.

The PC-board layout for the envelope generator is shown in Figs. 42 and 43. The dotted line encloses the D/A converter and filter.

Finally, several voltages are needed to power the modules. For the person who uses the BMPS, the PC-board layout shown in Figs. 44 and 45 will be useful. In addition to providing +12, +5, -5, and -12 volt power, as is required in any case, it also provides access to the system data bus, address bus, and \emptyset_2 line.

My version of the synthesizer, exclusive of the frequency generator and power-supply board, is shown in Fig. 46. At the left is the 16-word diode-implemented memory. To its right are the waveform generator and envelope generator, both without filters. I etched the latter two on a single PC board.

Software

The software which is used in the implementation is straightforward. A flowchart is shown in Fig. 47. The first step, "select frequency," involves ap-

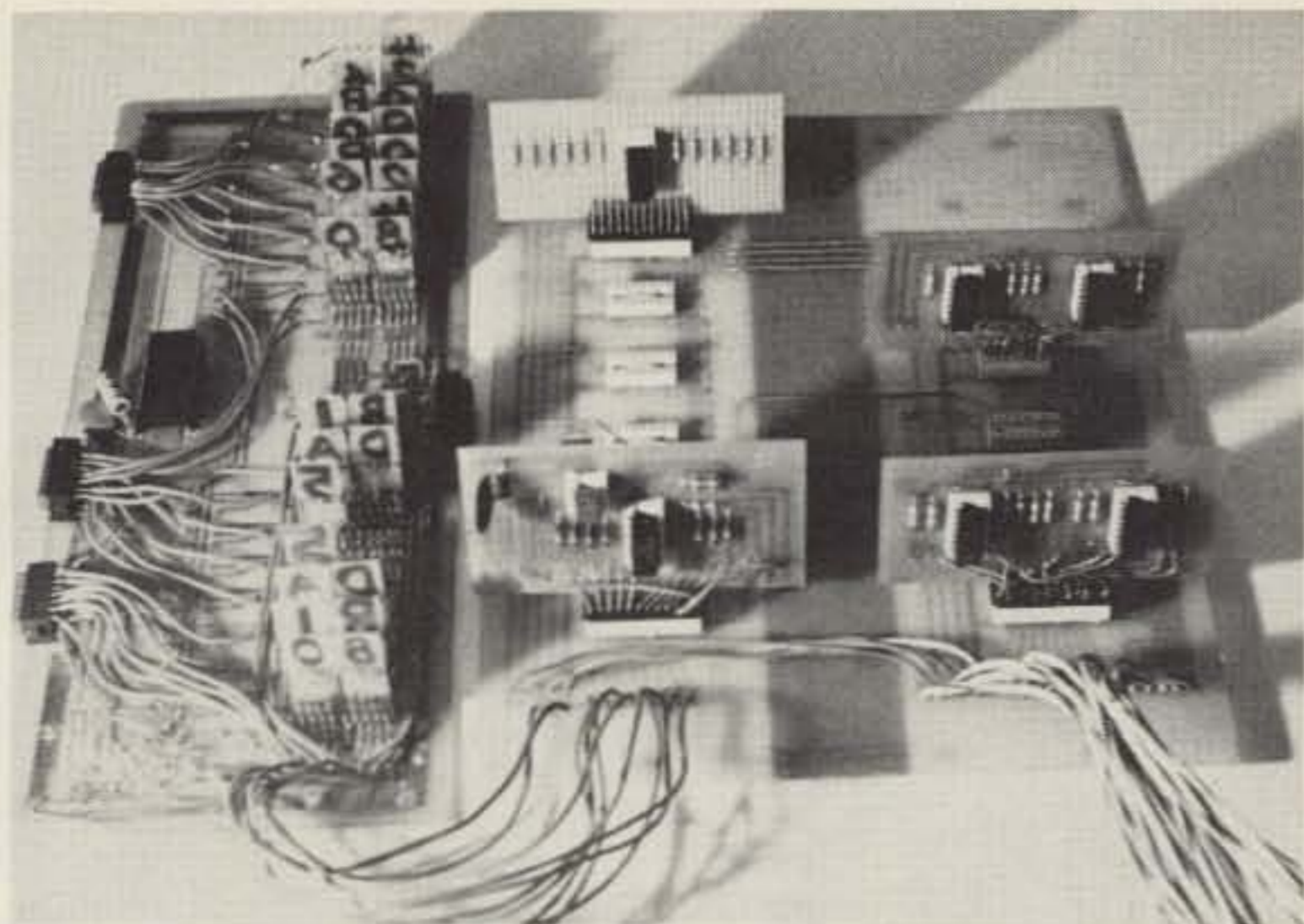

Fig. 46. Photo of author's version of synthesizer (excluding the frequency generator and power supply board). At the left is the 16-word diode-implemented memory. At the right are the waveform generator and envelope generator, with filters removed.

plying a number to the "N" inputs of the binary divider. The number simply is one of the twelve shown in Fig. 12 and corresponds to the frequency (exclusive of octave) of the desired note. This implies that we previously have stored in memory a series of numbers, one corresponding to the frequency of each note of the desired melody. The second step, "select octave and filter," is similar, except that the series of numbers corresponds to

the octaves of the notes of the desired melody and the filter to be used for each.

Once we select the frequency, octave, and filter for the note, we successively apply each point of the envelope to the envelope generator. The number of points in the envelope and the delay between applications determine the duration of the note.

After each note has been played, we check to see if all notes have been played. Once that happens, we apply 0000 to the analog selector. The details of what should happen next depend on the particular uP system. Something similar to a HALT should be executed.

A minimal 6502 program which will run properly on the BMPS is shown in Fig. 48. It assumes that fourteen notes are to be played and that a thirty-two-point envelope is to be used. The data sets which define the melody that the program plays were developed by the method shown in the next section.

Translating Sheet Music Into Data Sets

Constructing data sets is not difficult. What's in-

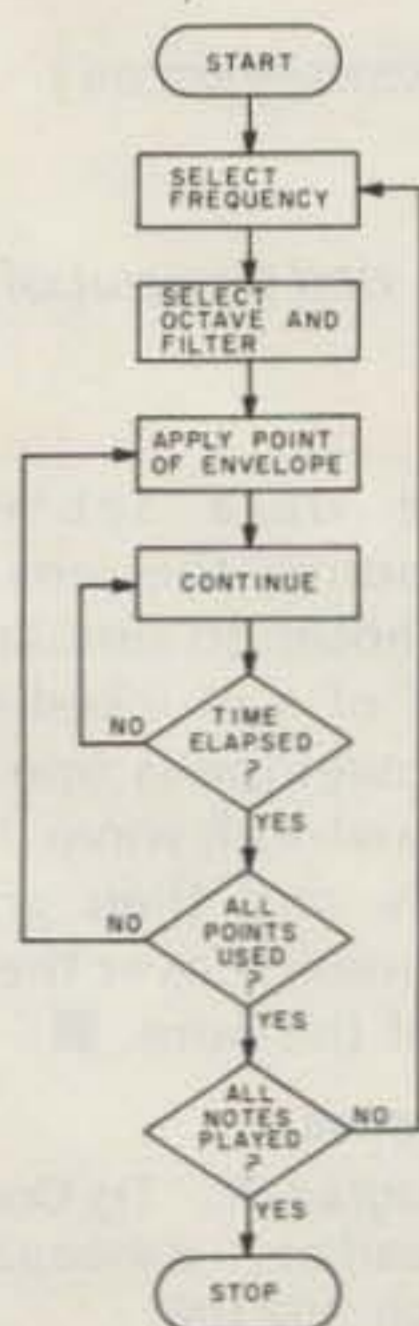

Fig. 47. Flowchart of software.

SF

S-F Amateur Radio Services

(213) 837-4870

4384 KEYSTONE AVE., CULVER CITY, CA. 90230

the W6TOG* ✓ S33 RECEIVER MODIFICATION KITS

INCREASE SELECTIVITY • IMPROVE SENSITIVITY
LOWER INTERNAL NOISE
IMPROVE NOISE BLANKER OPERATION
COMBAT BLOCKING FROM LOCAL SIGNALS

| | | | |
|-----------------------|---------|-----------------------|---------|
| TS-520 KIT | \$27.50 | FT-101 SERIES KIT ... | \$32.50 |
| TS-520S KIT | 32.50 | FR-101 SERIES KIT ... | 34.50 |
| TS-820 & 820S KIT ... | 34.50 | FT-301 SERIES KIT ... | 34.50 |
| R-599 A/D KIT | 27.50 | FT-901 SERIES KIT ... | 34.50 |

EXPLICIT INSTRUCTIONS MAKE MODIFICATION A CINCH

IT'S MAGIC... IT'S "MAGICOM" PROCESSOR MODIFICATION KIT

IMPROVES AUDIO PUNCH
IMPROVES PROCESSED SPEECH QUALITY
Converts TS-820 / 820S speech processor from RF compressor to RF clipper \$27.50
RF speech processor for TS-520 / 520S \$42.50
The "MAGICOM" RF processor module provides up to 6dB increase in output with smooth, clean, non-distorted audio and more penetration for those pile-ups.

ENDORSED BY W6TOG AND BIG GUN DXers WORLD WIDE

the W6TOG* INTERNAL ELECTRONIC KEYS

FOR ALL AMATEUR TRANSMITTERS OR
TRANSCIVERS USING GRID BLOCK KEYING

- No holes mounting with TS-820 Series
- Mounting options for TS-520, TS-520S, FT-101 Series, TR4 Series, T4X Series, T-599 Series and 32S Series.
- C-MOS DESIGN — Dot and dash memory — full iambic or manual operation.
- Simple installation \$49.50

THE S-F REJEKTOR FILTER

AN INTEGRATED CIRCUIT
ACTIVE BANDPASS FILTER
FOR PROCESSED RECEIVER AUDIO

- Separate active filter elements for CW and SSB audio output stage
- 8 ohm input and output impedance
- Headphone jack for convenience
- ON CW: from 500 hz to 100 hz, variable
- ON SSB: 2 KHz fixed bandwidth
- Rejects unwanted signal better than 60 dB
- Designed for today's transceivers or yesterday's older equipment \$49.50

* WELL KNOWN DXer WITH OVER 300 COUNTRIES CONFIRMED.

All prices postpaid - in Calif. add 6% sales tax - Mastercharge & Visa accepted
SATISFACTION GUARANTEED OR MONEY REFUNDED

| LOCATION | CONTENTS | INSTRUCTION | | |
|----------|----------|-----------------|----|----|
| 80 | A2 | LDX * OD | D | 30 |
| 1 | OD | | E | -- |
| 2 | A0 | LOOP2 LDY * 20 | F | -- |
| 3 | 20 | | CO | 56 |
| 4 | BD | LDA FREQ,X | 1 | 56 |
| 5 | B0 | | 2 | 56 |
| 6 | FF | | 3 | 56 |
| 7 | 8D | STA FQ | 4 | 56 |
| 8 | 08 | | 5 | 56 |
| 9 | 40 | | 6 | 56 |
| A | BD | LDA OCTFIL,X | 7 | 56 |
| B | CO | | 8 | 56 |
| C | FF | | 9 | 56 |
| D | 8D | STA OCFL | A | 56 |
| E | 10 | | B | 56 |
| F | 40 | | C | 56 |
| 90 | B9 | LOOP1 LDA ENV,Y | D | 56 |
| 1 | DO | | E | -- |
| 2 | FF | | F | -- |
| 3 | 8D | STA EN | DO | FF |
| 4 | 20 | | 1 | F7 |
| 5 | 40 | | 2 | EF |
| 6 | 8D | STA OPORT | 3 | E7 |
| 7 | 00 | | 4 | DF |
| 8 | 82 | | 5 | D7 |
| 9 | AD | WAIT LDA IPORT | 6 | CF |
| A | 00 | | 7 | C7 |
| B | 90 | | 8 | BF |
| C | 30 | BMI WAIT | 9 | B7 |
| D | FB | | A | AF |
| E | 88 | DEY | B | A7 |
| F | DO | BNE LOOP1 | C | 9F |
| AO | EF | | D | 97 |
| 1 | CA | DEX | E | 8F |
| 2 | DO | BNE LOOP2 | F | 87 |
| 3 | DE | | EO | 7F |
| 4 | 4C | FIN JMP FIN | 1 | 77 |
| 5 | A4 | | 2 | 6F |
| 6 | FF | | 3 | 67 |
| . | | | 4 | 5F |
| . | | | 5 | 57 |
| . | | | 6 | 4F |
| . | | | 7 | 47 |
| . | | | 8 | 3F |
| BO | 17 | FREQ | 9 | 37 |
| 1 | 47 | | A | 2F |
| 2 | 64 | | B | 27 |
| 3 | 64 | | C | 1F |
| 4 | 75 | | D | 17 |
| 5 | 51 | | E | 0F |
| 6 | 47 | | F | 07 |
| 7 | 17 | | . | |
| 8 | 30 | | . | |
| 9 | 47 | | . | |
| A | 47 | | FF | 80 |
| B | 30 | | D | FF |
| C | 17 | | | |

Fig. 48. Minimal program for 6502-based BMPS. Strobe pulse from OPORT (output port at 8200) is tied to input of timer on I/O board. Output of timer is tied to bit 7 of IPORT (input port at 9000).

volved is shown in Fig. 49. In this case, the first fourteen notes of "Oh, Susanna" are translated.

The process involves writing down the letter designations of each note. Based on Fig. 12, we then

list the divisors which correspond to the letter designations of the notes. These numbers form the data set which is labeled FREQ in Fig. 48.

Selecting the octaves and the filters is a rather more arbitrary process. For the program, I selected octave 5 and filter 6. Octave 5 covers from about 500 to 1000 Hz. In this case, each of the fourteen entries in the data set OCTFIL is 5616.

The data set which represents the envelope was chosen to simulate the sound of a plucked string. The envelope is one tooth of a sawtooth wave. It rises rapidly and then goes to zero linearly over the duration of the note. ■

References

1. Winograd, K., "Try Computer Composition," *Kilobaud*, July, 1977, pp. 102-108.
2. Creason, S., *How to Build a Microcomputer... and Really Understand It*, 73, Inc., in press.

I CAME FROM AL - A - BAM - A WITH MY BAN - JO ON MY KNEE

| | | | | | | | | | | | | | | |
|----------------|----|----|----|----|----|----|----|----|----|----|----|----|----|----|
| NOTE | C | E | G | G | A | G | E | C | D | E | E | D | C | D |
| HEX EQUIVALENT | 17 | 47 | 64 | 64 | 75 | 51 | 47 | 17 | 30 | 47 | 47 | 30 | 17 | 30 |

Fig. 49. Construction of data set for the first fourteen notes of "Oh, Susanna."

SAVE

COMPUTER INTERFACES & PERIPHERALS

SAVE

For free catalog including parts lists and schematics, send a self-addressed stamped envelope.

APPLE II SERIAL I/O INTERFACE *



Part no. 2
Baud rate is continuously adjustable from 0 to 30,000 • Plugs into any peripheral connector • Low current drain. RS-232 input and output • On board switch selectable 5 to 8 data bits, 1 or 2 stop bits, and parity or no parity either odd or even • Jumper selectable address • SOFTWARE • Input and Output routine from monitor or BASIC to teletype or other serial printer. • Program for using an Apple II for a video or an intelligent terminal. Also can output in correspondence code to interface with some selectrics. Board only — \$15.00; with parts — \$42.00; assembled and tested — \$62.00.

MODEM *



Part no. 109
• Type 103 • Full or half duplex • Works up to 300 baud • Originate or Answer • No coils, only low cost components • TTL input and output-serial • Connect 8 ohm speaker and crystal mic. directly to board • Uses XR FSK demodulator • Requires +5 volts • Board \$7.60; with parts \$27.50

DC POWER SUPPLY *



Part no. 6085
• Board supplies a regulated +5 volts at 3 amps., +12, -12, and -5 volts at 1 amp. • Power required is 8 volts AC at 3 amps., and 24 volts AC C.T. at 1.5 amps. • Board only \$12.50; with parts excluding transformers \$42.50

TAPE INTERFACE *

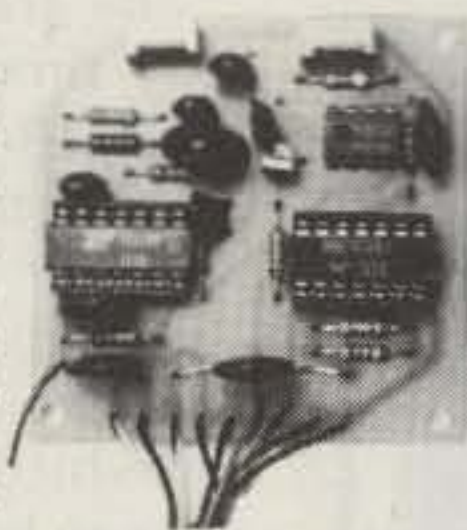

Part no. 111
• Play and record Kansas City Standard tapes • Converts a low cost tape recorder to a digital recorder • Works up to 1200 baud • Digital in and out are TTL-serial • Output of board connects to mic. in of recorder • Earphone of recorder connects to input on board • No coils • Requires +5 volts, low power drain • Board \$7.60; with parts \$27.50

T.V. TYPEWRITER

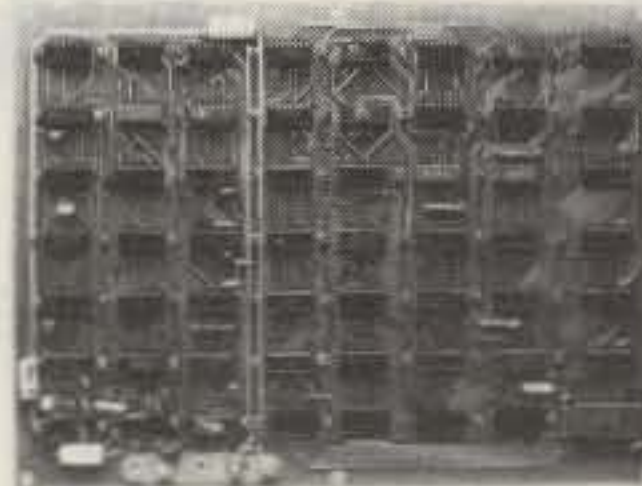

Part no. 106
• Stand alone TVT • 32 char/line, 16 lines, modifications for 64 char/line included • Parallel ASCII (TTL) input • Video output • 1K on board memory • Output for computer controlled cursor • Auto scroll • Non-destructive cursor • Cursor inputs: up, down, left, right, home, EOL, EOS • Scroll up, down • Requires +5 volts at 1.5 amps, and -12 volts at 30 mA • All 7400, TTL chips • Char. gen. 2513 • Upper case only • Board only \$39.00; with parts \$145.00

TIDMA *

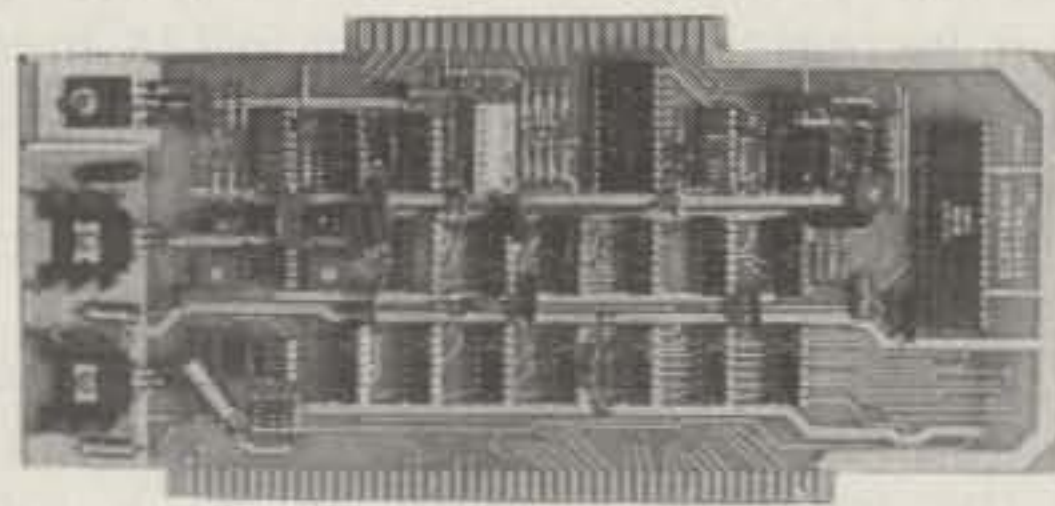

Part no. 112
• Tape Interface Direct Memory Access • Record and play programs without bootstrap loader (no prom) has FSK encoder/decoder for direct connections to low cost recorder at 1200 baud rate, and direct connections for inputs and outputs to a digital recorder at any baud rate. • S-100 bus compatible • Board only \$35.00; with parts \$110.00

UART & BAUD RATE GENERATOR *

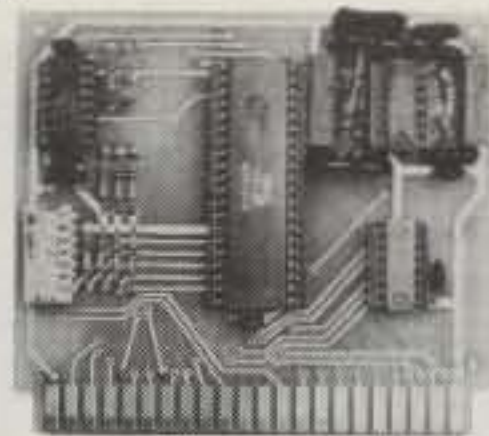

Part no. 101
• Converts serial to parallel and parallel to serial • Low cost on board baud rate generator • Baud rates: 110, 150, 300, 600, 1200, and 2400 • Low power drain +5 volts and -12 volts required • TTL compatible • All characters contain a start bit, 5 to 8 data bits, 1 or 2 stop bits, and either odd or even parity. • All connections go to a 44 pin gold plated edge connector • Board only \$12.00; with parts \$35.00 with connector add \$3.00

8K STATIC RAM

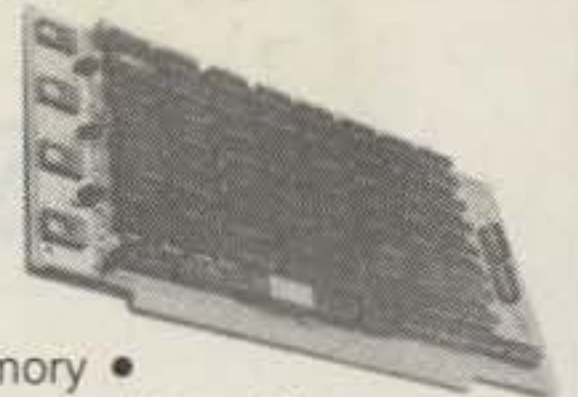

Part no. 300
• 8K Altair bus memory • Uses 2102 Static memory chips • Memory protect • Gold contacts • Wait states • On board regulator • S-100 bus compatible • Vector input option • TRI state buffered • Board only \$22.50; with parts \$160.00

RF MODULATOR *



Part no. 107
• Converts video to AM modulated RF, Channels 2 or 3. So powerful almost no tuning is required. On board regulated power supply makes this extremely stable. Rated very highly in Doctor Dobbs' Journal. Recommended by Apple. • Power required is 12 volts AC C.T., or +5 volts DC • Board \$7.60; with parts \$13.50

RS 232/TTY *

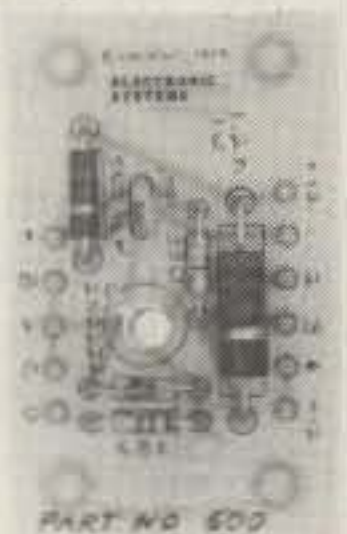

Part no. 600
• Converts RS-232 to 20mA current loop, and 20mA current loop to RS-232 • Two separate circuits • Requires +12 and -12 volts • Board only \$4.50, with parts \$7.00

RS 232/TTL *



Part no. 232
• Converts TTL to RS-232, and converts RS-232 to TTL • Two separate circuits • Requires -12 and +12 volts • All connections go to a 10 pin gold plated edge connector • Board only \$4.50; with parts \$7.00 with connector add \$2.00

ELECTRONIC SYSTEMS Dept. 73, P.O. Box 21638, San Jose, CA. USA 95151

To Order: Mention part number and description. For parts kits add "A" to part number. In USA, shipping paid for orders accompanied by check, money order, or Master Charge, BankAmericard, or VISA number, expiration date and signature. Shipping charges added to C.O.D. orders. California residents add 6.5% for tax. Outside USA add 10% for air mail postage, no C.O.D.'s. Checks and money orders must be payable in US dollars. Parts kits include sockets for all ICs, components, and circuit board. Documentation is included with all products. All items are in stock, and will be shipped the day order is received via first class mail. Prices are in US dollars. No open accounts. To eliminate tariff in Canada boxes are marked "Computer Parts." Dealer inquiries invited. 24 Hour Order Line: (408) 226-4064

* Circuits designed by John Bell



SSTV Meets SWTPC: Part 1

—micro-enhanced pictures

An obvious step after completing my first two SSTV projects^{1,2} was to use the microprocessor to enhance SSTV pictures received over the air. This project was more complex than I originally had anticipated, and it took three months of hard work. The effort was broken down into two major areas, hardware and software. I will try to separate them as much as possible.

It is my opinion that most computer hobbyists are not willing to invest more money in their systems than is absolutely necessary. For this reason,

many of the hardware functions were accomplished with software. This cuts down on hardware costs, but it increased the complexity of the software. I started first by specifying the entire system. Next I designed and constructed the hardware, and last I wrote and debugged the software. I found that most of my development problems were in the hardware and were due to poor soldering.

Concepts and Specifications

Following is a brief sum-

mary of the specifications which were placed on the project:

1. The computer program will run in 12K memory on an SWTPC 6800 computer system.
2. The system will include the design of a special analog-to-digital and digital-to-analog board with an SSTV modulator (plug compatible with the SWTPC 6800 computer).
3. A special circuit adapter attaches to an SSTV monitor which allows the SWTPC 6800 to receive an SSTV picture and place the picture in memory.
4. The enhancement com-

puter program allows an operator to select the following options by a monitor program:

a) *Test*—This routine is used to calibrate and check the operation of the A/D and D/A card.

b) *Receive*—This option places the SSTV picture in the SWTPC memory, formatted with 128 pixels on 128 lines with 16 gray levels.

c) *Contrast*—This option transmits the SSTV picture in computer memory with 2 to F (15) times improvement in contrast. The picture can be transmitted up to F times.

d) *Binary*—This option transmits the picture in computer memory with two gray levels (black or white). The picture can be transmitted up to F times.

e) *Negative*—This option inverts the picture in computer memory to produce a negative picture which can be transmitted up to 15 times.

f) *Zoom*—This option allows the operator to zoom in on 5 loca-

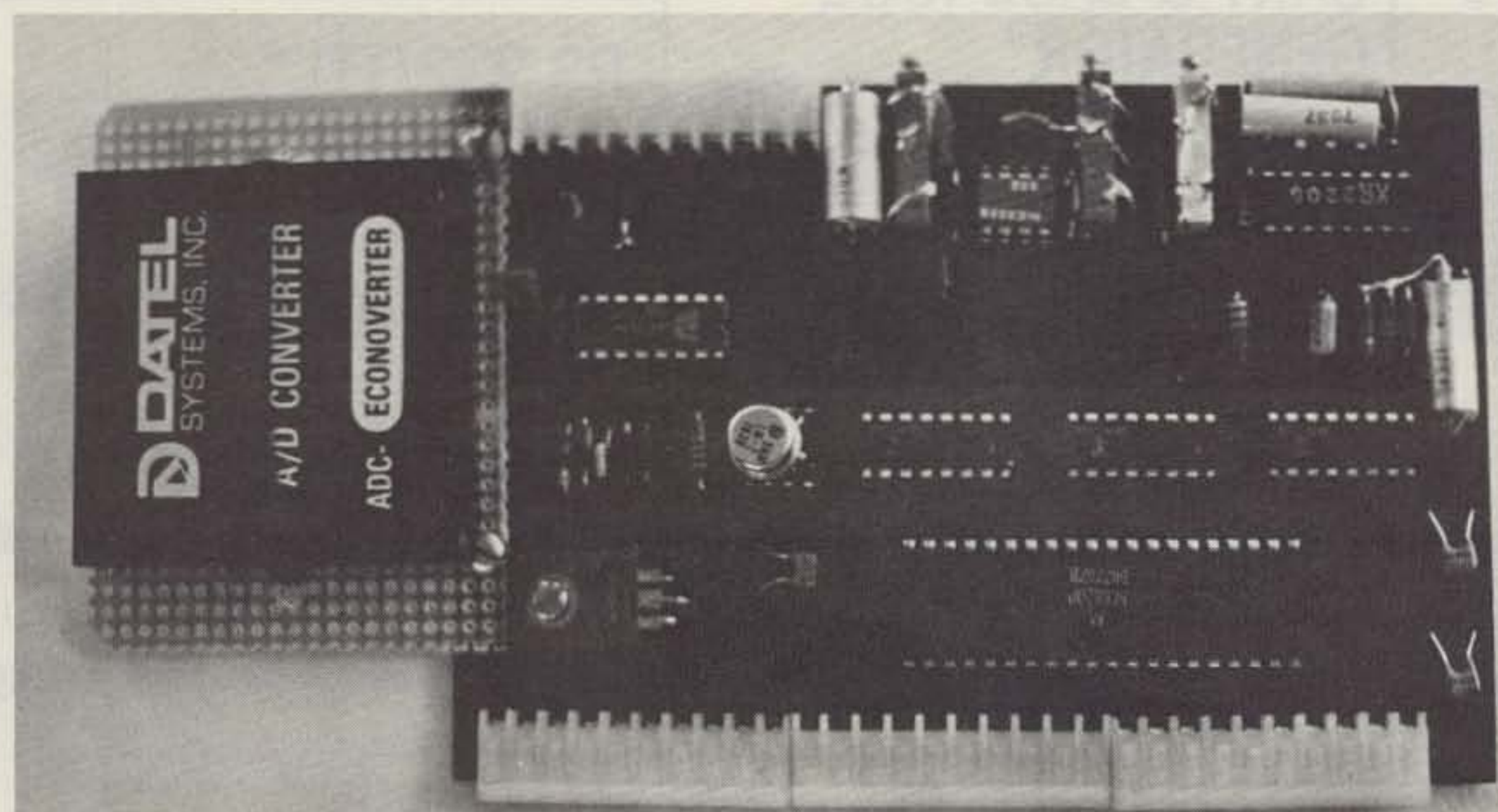

Photo A. Analog card layout — component side.

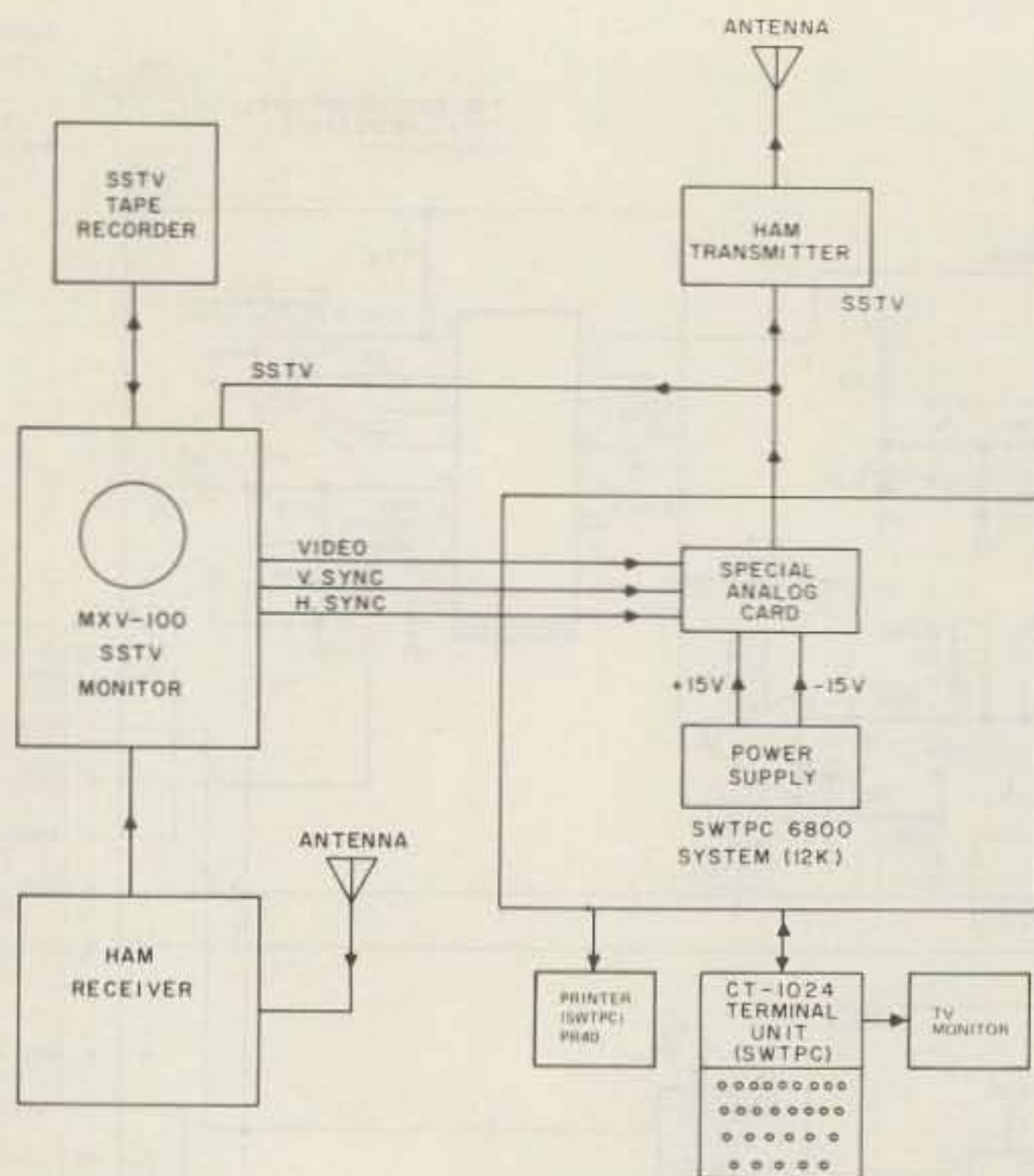

Fig. 3. SSTV enhancement program computer interface.

A picture density of 128 pixels by 128 lines was chosen for minimum computer memory size and a fixed SWTPC clocking speed. Since I decided to perform many of the enhancement techniques on a real-time basis without modifying memory, I had to allow a large amount of time between the transmission of pixels. With a density of 128 pixels per line, approximately 500 microseconds of computer instructions can be pro-

cessed between the transmission of pixels. I am sure some of you are now asking, "What is a pixel?" Well, a pixel is a picture element. I defined a picture element as having 16 gray levels. This means that a pixel could be contained in four binary bits, which, in computer language, is a nibble. Since a computer byte of data contains two nibbles, an entire TV picture could be contained in 8K of memory ($128 \times 128 / 2$ equals 8192).

I additionally specified that the computer control programming must be contained in 4K of memory. I was quite surprised to find that the object code used less than 3K of memory. This allows for further expansion of the program to include other features. The analog circuits did not demand fast response times. Since the pixel duration is 520 microseconds, the analog conversion rates should be no greater than about 50 microseconds. This allows about 470 microseconds worth of computer overhead between pixels. When coupled with 16 gray levels or 4 bits, binary resolution makes the total cost of the analog circuitry reasonable. With this background, I think it will now be appropriate to discuss the hardware.

The Hardware

The special hardware consists of two components: the SSTV monitor adapter and the analog card. I will discuss the analog card first, since it is the most complex.

The analog board consists of five discrete modules which were placed on a single board plug compatible with the

SWTPC MP-68 mother board. Each of the modules is used as follows, and the whole schematic is shown in Fig. 1.

1. *Peripheral interface adapter*—This integrated circuit (MC6820) is used to interface the computer bus with the outside world. The module contains two 8-bit bidirectional data buses.

2. *Interface buffers (74367)*—These 3 ICs are used to buffer the PIA chip. The A side of the PIA is used for output and the B side for input. This configuration is an exact copy of the SWTPC MP-L parallel interface card. The PIA and buffers could be replaced with an SWTPC card, if you are not inclined toward hardware construction and your soldering is as bad as mine.

3. *SSTV modulator*—The SSTV modulator (XR-2206c) is a monolithic FSK function generator chip. This chip was found to perform very well in this application with a minimum number of components. The output frequency was very stable once adjusted by a frequency counter and left alone.

The sync frequency was selected by program control, when a TTL ground is applied to pin 9. The sync frequency is determined by the capacitor between pins 5 and 6 and the register on pin 7. Since most components vary slightly from their actual values, the frequency should be selected by trial and error. On my circuit, two resistors were first placed in series to total 15k (14k + 1k). The 1k resistor was exchanged until a frequency of 1200 Hz was measured on a frequency counter. A 400-Ohm resistor was finally selected. The video signal is applied to pin 8 of the IC. The voltage swing was found to be 3.2 volts (black 1500 Hz) and 1.95 volts (white 2300 Hz). These voltages were adjusted by

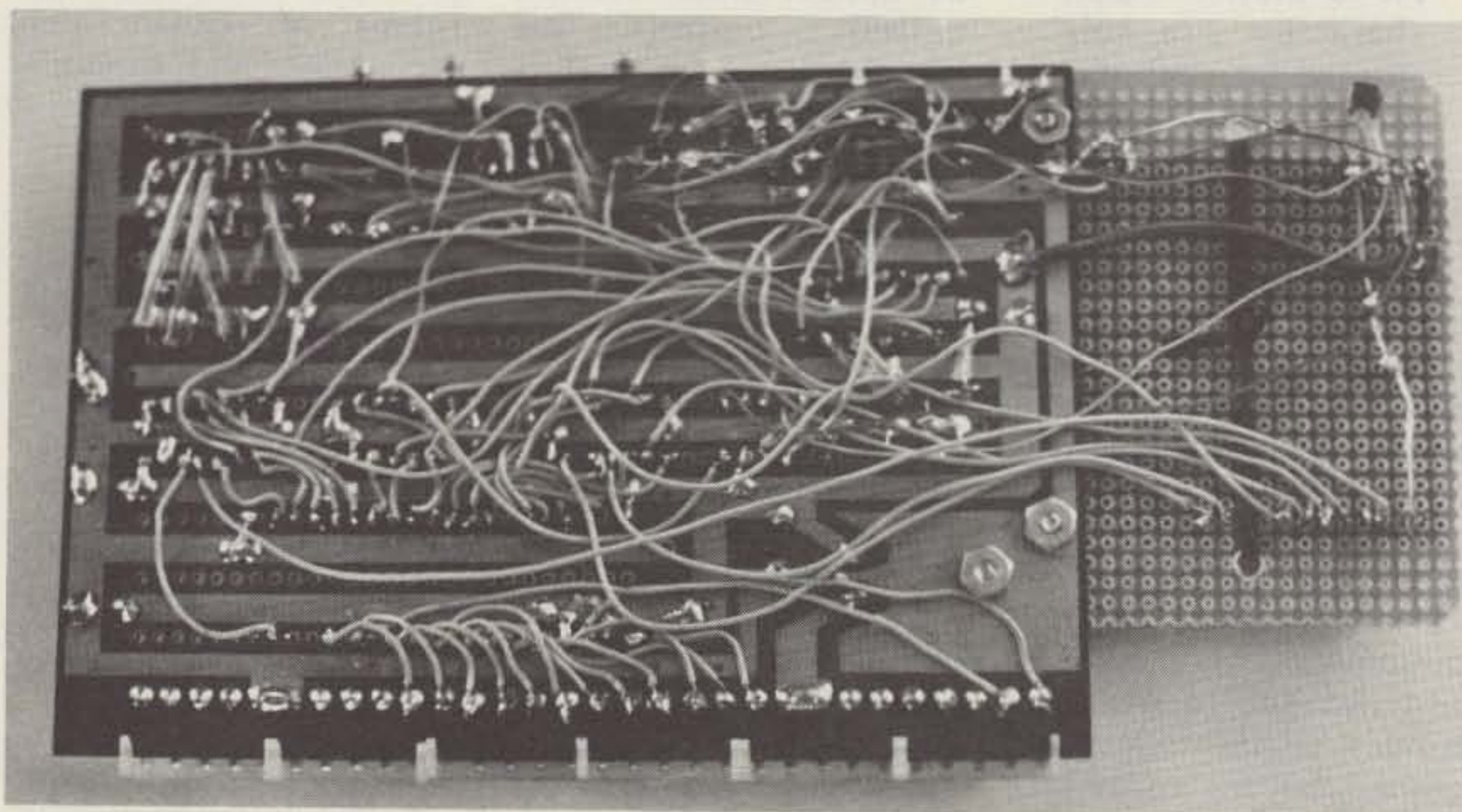

Photo B. Analog card wiring.

| K/B Input | SSTV frequency | Adjustment |
|-----------|----------------|--------------|
| 00 | 1200 Hz | 15k resistor |
| F1 | 2300 Hz | offset/gain |
| 01 | 1500 Hz | offset/gain |

Table 1.

varying the gain and offset of the operational amplifier stage. This process will be discussed further in the calibration section.

4. *Digital-to-analog converter (DAC-IC8BC)*—The digital-to-analog converter selected (DAC) is an 8-bit low-cost Datal unit.⁴ Other modules could be selected (e.g., MC-1408P8) which are identical. The Datal unit was selected because I had to place an order with the firm for the ADC, and the DAC was included for convenience purposes.

The DAC, as configured in my application, has an output voltage swing of 0.5 to 1.3 with an input of 01 and F1 hexadecimal programmed on the input lines. A white frequency was assigned F and black 0 by the software. The voltage scaling to the SSTV modulator was accomplished by the 5556 operational amplifier. Fig. 2 is a computer plot of the decimal input (1 to 16) versus frequency. As you can see, the DAC/SSTV modulator output was extremely linear through the total range.

5. *Analog-to-digital converter (ADC-Econo)*—The analog-to-digital converter (ADC) consists of two assemblies: sample and hold (S/H) and the ADC. These units were chosen because of their cost and performance. The number of units available for this application is enormous. However, many ADCs have specifications far in excess of this application, but their costs are high. This unit was quite large in size, but its performance is excellent and the cost is attractive.

All 6 bits of the ADC were connected to the PIA,

but only 4 are used. The bit selection was accomplished by the software, which will be discussed later. The S/H is a low-cost monolithic chip. It is compatible with the ADC and requires few external components. The S/H was required since the conversion speed of the ADC is a maximum of 50 microseconds. If the analog signal was not held constant during the ADC conversion, a false value might be measured.

The sample pulses and durations were applied to the unit by the software.

The analog board was hardwire soldered on a

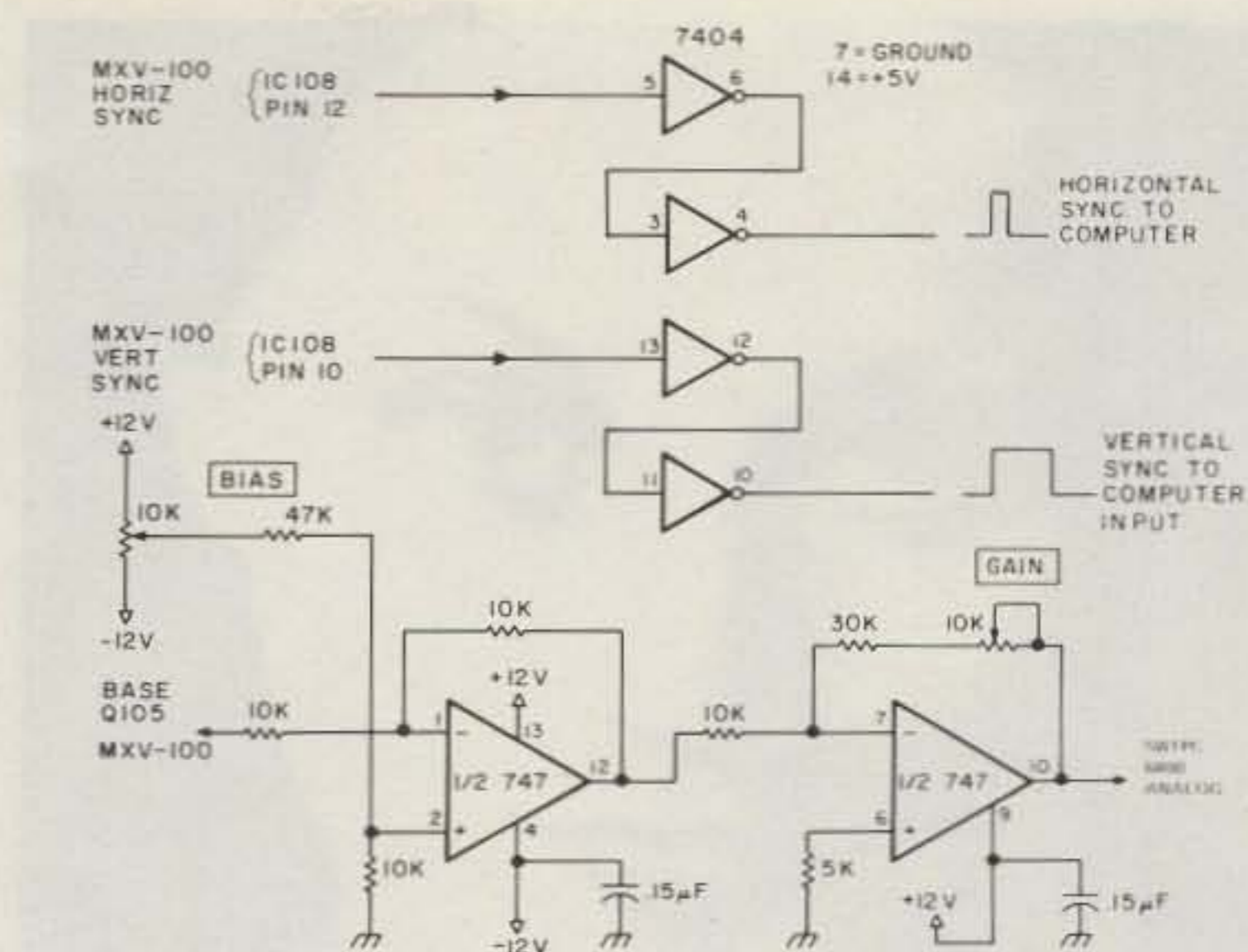

Fig. 4. SSTV monitor/computer interface schematic.

prototype board obtained from Personal Computing Company.⁵ This board is plug compatible with the SWTPC system and was obtained by mail order. The board was not large enough to contain the ADC, so a piece of vector-

board was added. Photos A and B show how the board was constructed. The SWTPC interface connectors were obtained from a local Byte Shop. The Datal modules can be obtained by sending a check directly to the firm. The minimum

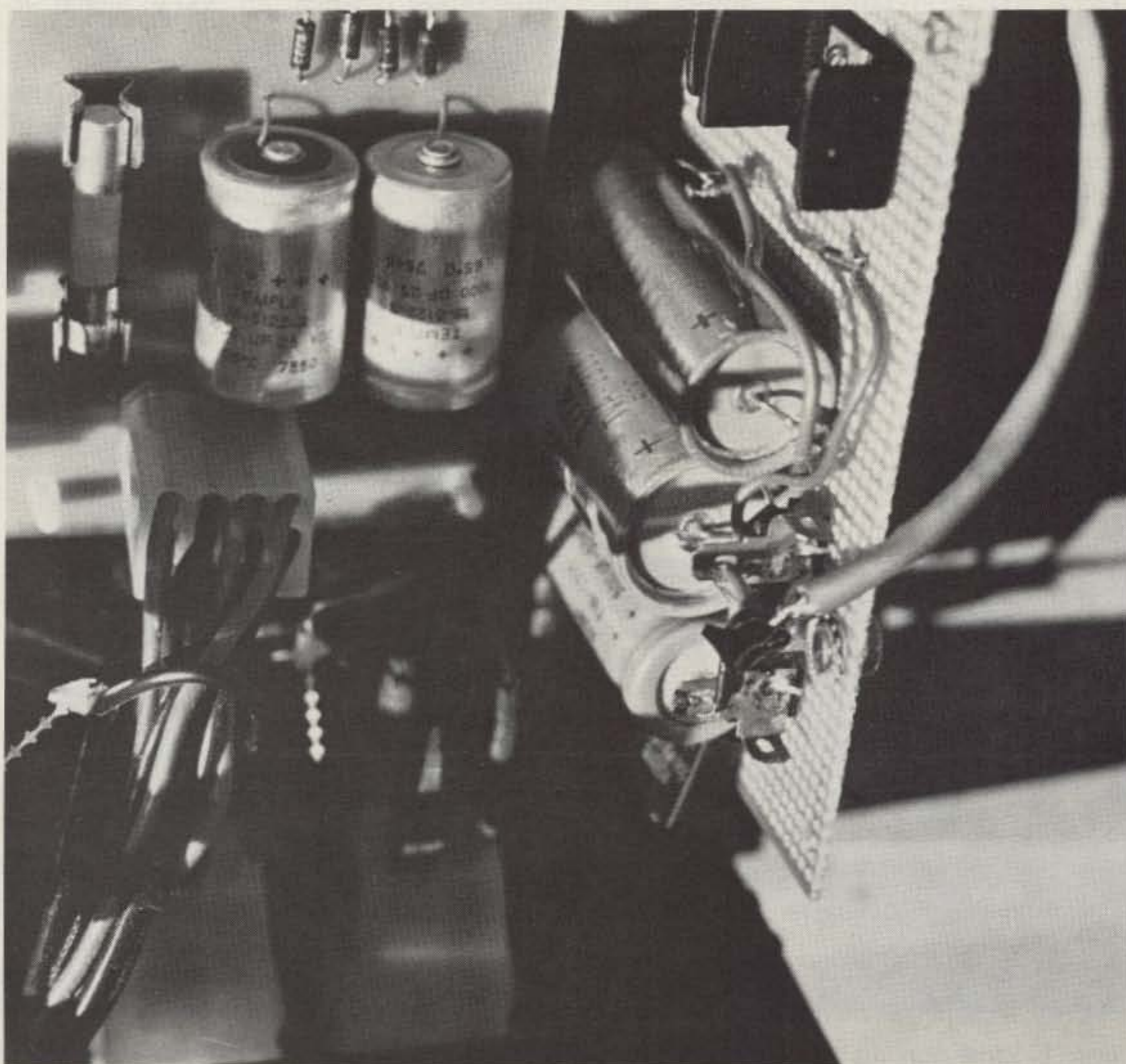

Photo C. Analog card power supply mounting in SWTPC 6800.



Photo D. Portrait on SSTV monitor directly from camera and scan converter.

order Datel will accept is \$35.00. Following is the cost of each item: DAC (DAC-IC8BC)—\$8.95; ADC (ADC-Econoverter)—\$39.95; S/H (SHM-LM-2)—\$7.95; interface board—\$9.95. The total cost was \$66.80. The remaining parts are common and are available from a number of mail-order sources which are listed in many publications.

A plus and minus 15-volt

supply was constructed on a piece of vectorboard and placed vertically in the SWTPC MP-68 along with a transformer. Photo C shows this configuration. The power supply used 1-Amp voltage regulators (7815 and 7915), and its schematic was obtained from vendor application notes. Wires were connected directly to the analog board. The SSTV receiver interfaced with

the computer analog card is shown in Fig. 3.

As you can see, the performance of the entire system is largely dependent upon the SSTV receiver. The MXV-100 monitor⁶ was used because its analog front end is excellent in noise rejection and frequency response. Other units may be used, but their performance may not be the same as shown in the photos.

I will discuss the SSTV monitor interface as generally as possible, since many SSTV monitors are currently available and it would be impossible to discuss each unit. Three signals must be provided to the computer analog card:

1. *Vertical sync*—This level must be TTL compatible and swing positive when an SSTV signal is received.

2. *Horizontal sync*—The level of this signal should be the same as the vertical. The duration of the sync is quite critical, but, if it is not correct or is missing, the computer software will

handle it.

3. *Analog signal*—The analog signal applied to the computer must be 0 to 4.84 volts positive, where 0 volts is black and 4.84 volts is white.

The signal was obtained from the base of the SSTV CRT cathode drive transistor. At this point in all monitors, the SSTV signal is demodulated and is a varying dc level which is used to change the SSTV CRT intensity. The only problem which remains is to adjust the voltage to the correct level for the ADC.

A dual 741 operational amplifier (747) was selected, since its frequency response is well within the range of SSTV. Stage 1 of the amplifier adjusts the offset and stage 2 the gain. The MXV-100 varies between 3 and 4 volts on the base of the cathode drive transistor.

The receiver interface was constructed on a vectorboard, placed in the SSTV monitor, and connected to the computer by a shielded cable.



Photo E. Same portrait transmitted from computer without enhancement. The picture has some 60 Hz noise which is messing things up slightly.



Photo F. Same portrait transmitted from the computer with a zoom enhancement on the center of the screen. This picture also contains the same 60 Hz noise.

NEW!

"INDUSTRIAL"

WIRE-WRAPPING TOOL

MODEL BW928

\$49⁹⁵

BATTERIES NOT INCLUDED
BIT & SLEEVE NOT INCLUDED

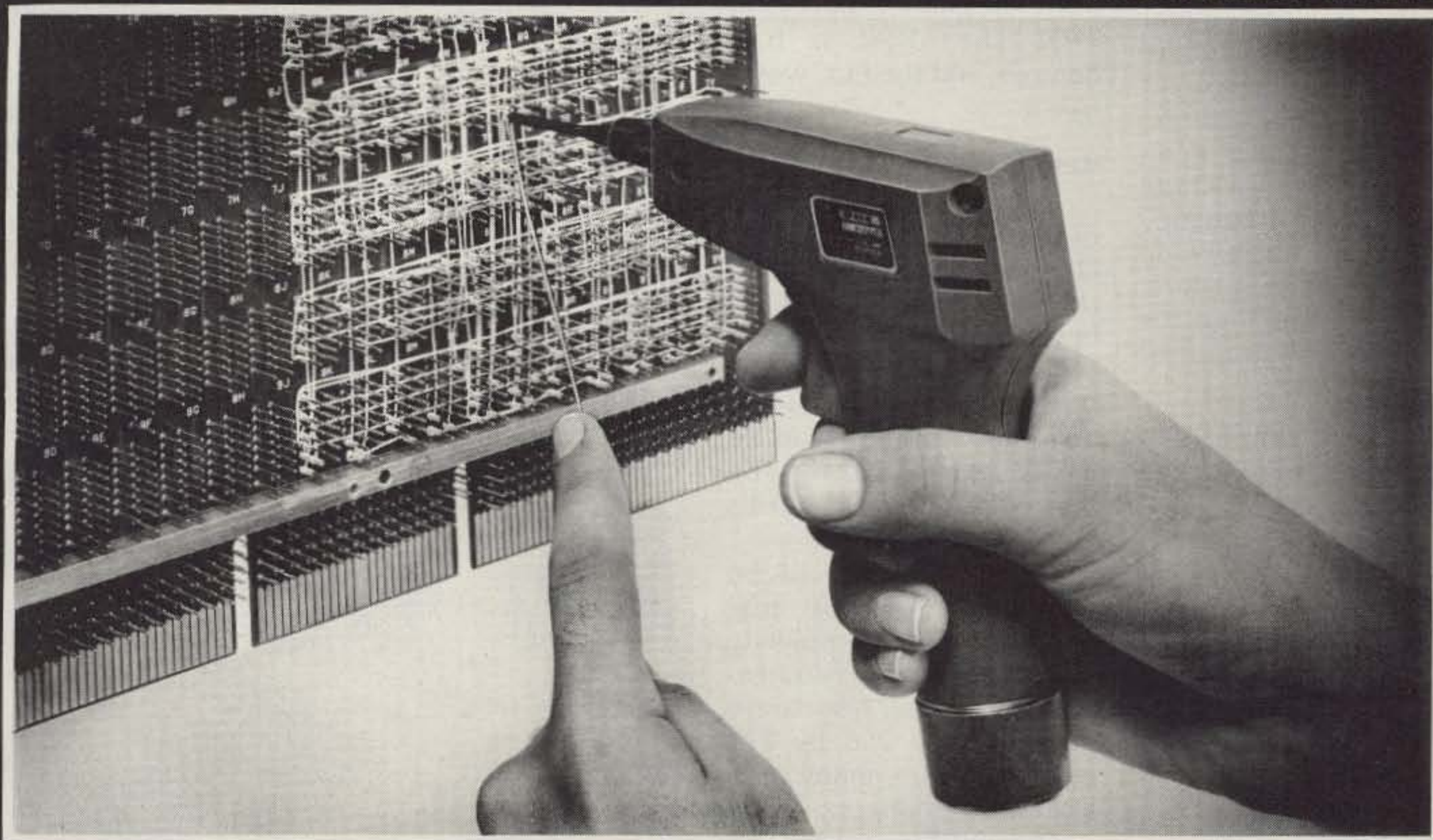

- BATTERY OPERATED
(2) Standard "C" Ni Cad Batteries (not included)
- INTERCHANGEABLE BITS & SLEEVES
(not included)
- REVERSIBLE ROTATION
For unwrapping, reverse batteries
- BACKFORCE OPTIONAL
Model BW928-BF \$52.95
- POSITIVE INDEXING
- LEIGHT WEIGHT
*LEXAN™ Housing

*LEXAN™ GENERAL ELECTRIC



OK MACHINE & TOOL CORPORATION ✓05

3455 Conner St., Bronx, N.Y. 10475 • (212) 994-6600 • TELEX 125091

```

00110 OPT 0,NOG
00120 0002 ORG $0000
00130 0006 CE E1D1 START LDX ##E1D1

00140 0003 96 10 LDA R #10
00150 0005 00 00 JSR X
00160 0007 96 16 LDA R #16
00170 0009 00 00 JSR X
00180 000B 0D E0A9 JSR $E0A9
00190 000E 48 ASL R

00200 000F 48 ASL R

00210 0010 48 ASL R

00220 0011 48 ASL R

00230 0012 16 TAB

00240 0013 0D E0A9 JSR $E0A9
00250 0016 1B ABA

00260 0017 CE 0010 LDX ##0010

00270 001A A7 00 STA R X
00280 001C 20 E2 BRA START
00290 A048 ORG $A048
00300 A048 0000 FDB START
00310 END

```

Fig. 5. Digital-to-analog converter calibration program source listing.

Calibration

After completion of the hardware, the first major task was to calibrate the entire setup for the correct frequencies. This was accomplished by two computer programs, a tape recorder, and a frequency counter. I will not provide a step-by-step procedure, since the concepts are the most important point of this section.

After the analog card is functional, load into the computer the DAC computer test program which is shown in Fig. 5.

When the program is executed, the TV will go blank, and the cursor will be in the home up position. When you enter 2 keyboard hexadecimal numbers, they will be placed in the DAC and cause the SSTV modulator frequency to change. The frequency can then be adjusted by the two pots on the analog card and resistor selection. Table 1 is a listing of keyboard input values versus SSTV frequency and adjustments.

When calibrated, I made a tape recording of all frequencies by entering all 16 gray levels into the com-

puter keyboard. Since I then had an audio tape, calibration could easily be made at some future date without a frequency counter.

The next step was to play the tape recording into the SSTV monitor and measure the analog voltage. The gain and offset were adjusted for the correct dc values. The second calibration program will be discussed in the software section (part 2) of this article. An interesting side application for this program/hardware might be to connect an amplifier and speaker to the SSTV modulator. When calibrated properly by adjusting gain and bias, you could play music with the computer. However, do not try this trick on the SSTV frequency of 14230 kHz. The QRM is bad enough, and the FCC won't like it.

Results

The overall results were quite satisfactory. Photos D and E and the PR-40 printouts (Figs. 6 and 7) best demonstrate my results. The computer pictures have been somewhat degraded, but this can be easily explained by the limited number of pixels and gray levels used.

Better video could be obtained with 256 pixels/line, but the complexity and computer requirements increase. A software expansion to 256 by 128 would require many programming changes.

The entire package explores some interesting concepts, and I am sure others will expand on my work as microprocessors are more widely used. The potential applications are just starting.

Part 2 of this article will discuss the software and object code. Flowcharts will be provided for those wishing to duplicate my work on another microprocessor. ■



Fig. 6. SSTV picture printed by the SWTPC 6800. The picture was copied over the air on 15 meters under poor conditions and placed initially over the air on 15 meters under poor conditions and placed initially on audio tape. The best of all of the pictures received was read into the SWTPC computer. This picture was then contrast enhanced by 2 times and printed on the PR-40 printer.

References

- "SSTV Meets the SWTPC 6800," *73 Magazine*, June, 1977, C. W. Abrams K6AEP.
- "Title Your Pix with a Micro," *73 Magazine*, October, 1977, C. W. Abrams K6AEP.
- Computer Eye Handbook*, copywrited 1975, Spatial Data Systems, Inc., P.O. Box 249, 508 S. Fairview Ave., Goleta CA 93017.

- Datel Systems, Inc., 1020 Turnpike St., Canton MA 02021.
- Personal Computing Co., 3321 Towerwood, Dallas TX 75234.
- "The W6MXV Hi-Performance Magnetic Deflection SSTV Monitor," *SSTV Handbook*, 73, Inc., Mike Tallent W6MXV, 6941 Lenwood Way, San Jose CA 95120.



Fig. 7. SSTV picture printed by the SWTPC computer. This is a composite of 5 successive pictures which were copied by the program's NOISE routine. The picture was then contrast enhanced by 2 times and printed.

Clegg is Transceiver Headquarters!

Who was it that said "There's nothing new under the sun?" He was wrong! There now is a generation of truly new concepts in Ham Transceivers. Any one of the rigs shown here has features and performance that never before were available. Regardless of what transceiver you currently own, we contend that replacement with any one of these three will increase your station performance. Each of the three has unique features. The only question is "which best suits your personal operating requirements?" Let us help you decide!



DRAKE TR-7



YAESU FT-901



ICOM IC-701

Drake's "7 SYSTEM" incorporates more innovative technical advances than any product we have seen in many years. Receiver dynamic range exceeds that of all others. If your QTH is in KW alley you'll experience a substantial relief from overload. If you've worried about changes in our bands after the WARC assemblage—the TR-7 can dispell your fears because it accommodates any future possible band relocations and new allocations. The frequency stability of Drake's "full-synthesis" and the large brilliant digital display add to the delight of any TR-7 owner. Space here is inadequate to define the numerous design and operational features of this superb transceiver. Call us for descriptive literature; better yet, drop by and try one in our demonstration room.

You'll discover—as we have—that Drake has created a real winner. One that the others will be hard pressed to equal for years to come. And if you prefer to operate with "separates" the forthcoming R7 Receiver gives you the performance of "twins" plus the convenience of a full performance transceiver for traveling or in the mobile.

YAESU'S FT901 system. If you're looking for a transceiver that not only outperforms others on any band from 160 through 10 meters but also has a single matching accessory to conveniently and efficiently cover 6, 2 and 3/4 meter bands, the 901 is it! Even if the VHF and UHF transverter doesn't interest you now, it surely will as OSCAR satellites become the way of life in the next few years. Of all the transceivers we've tested (both on the air and in the lab) none offers the superb control of receiver selectivity offered by YAESU's Variable Selectivity and Notch Filter. And if you work CW, the Tuneable Audio filter will delight you. Nor have we found another Speech Processor system that sounds as good while doing so much for signal punch as that on the 901. Add to this such features as a built in keyer plus both FM and AM detectors. Watch for a gigantic increase in membership in the Fox Tango Club when the gang discovers this great new transceiver.

Watch for YAESU's new matching SCOPE with "panoramic" display and the new synthesized external VFO accessories.

ICOM's IC-701 has to rank very high on our list of best available transceivers. Most of its great features aren't immediately apparent when you first take it out of the box. In fact, after you operate it for a week you'll still be finding new things to like about this all solid state, sophisticated unit. The operating flexibility provided by the dual VFO feature appeals to everyone here at Clegg. It's the first unit that makes no compromise as a fixed station and yet so conveniently mounts in virtually any compact mobile. If you hop from band to band—or chase DX around any single band you'll love its frequency agility and large bright frequency display.

Also available is the matching IC-211 with all mode coverage of 2 meters.

Whatever your needs in Transceivers, Amplifiers, Antennas, Keyers, Station Accessories, etc., call Clegg Toll Free 1-(800)-233-0250; in Pennsylvania call collect—717-299-7221 or write today for our latest catalog!

Clegg

Communications Corp. ✓ c3
1911 Old Homestead Lane
Greenfield Industrial Park East
Lancaster, PA 17601

Call Toll Free 1-800-633-3410

Long's suggests

KENWOOD



**KENWOOD TS-520S
SSB transceiver**

160 thru 10 meter coverage • Optional DG-5 frequency display • New speech processor with audio compression amplifier • Built-in AC power supply (DC-DC converter, optional) • RF attenuator • Provision for separate receive antenna & phone-patch.

799.00 list. Call for quote.

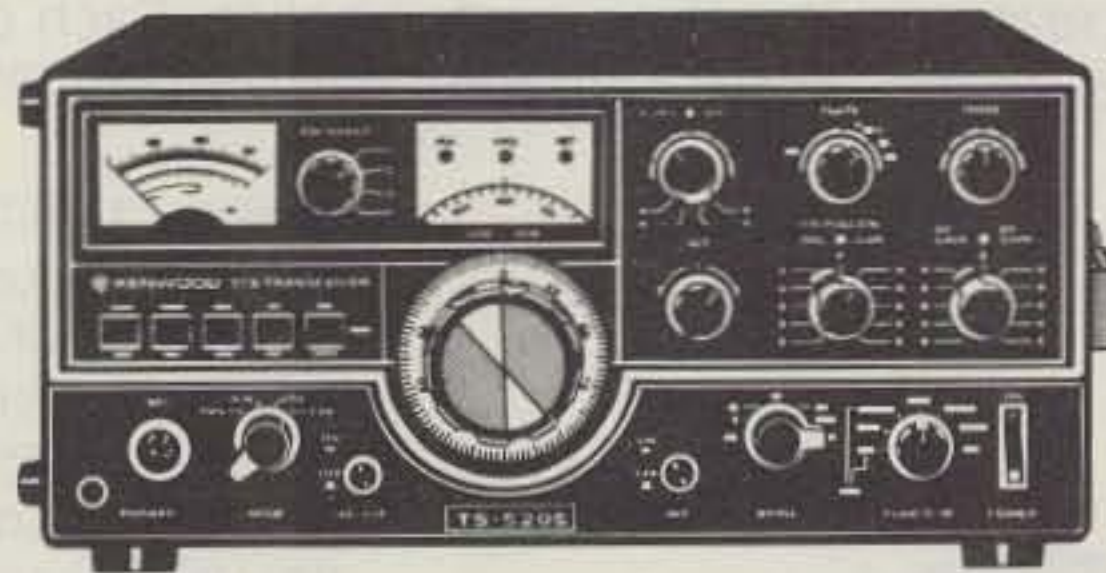

KENWOOD VFO-520S

To complete your TS-520S. Frequency range 1.8 to 30 MHz. Stability within 1 KHz per hr. after 1 min. warm up.

149.00 list. Call for quote.

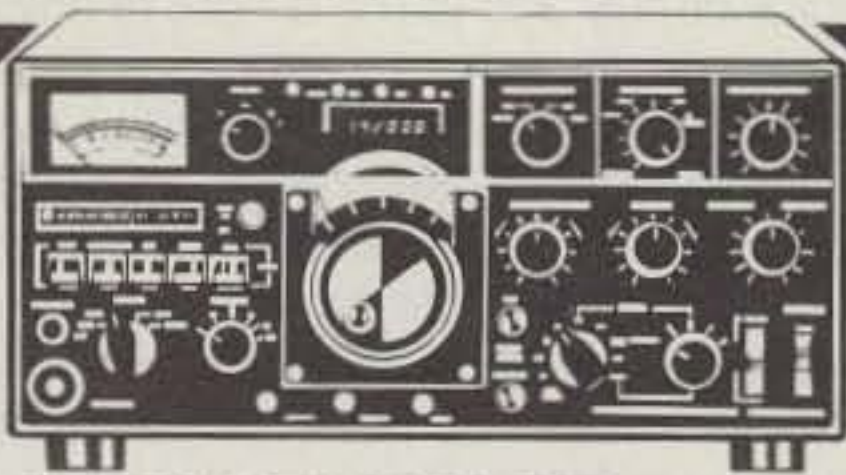

**NEW KENWOOD
R-820 triple-conversion
receiver**

The R-820 covers 160 thru 10 meters plus several shortwave broadcast bands. • 8.33 MHz, 455 kHz, & 50 kHz IFs • Digital readout • Notch filter • IF • Variable bandwidth tuning • Noise blanker • Stepped RF attenuator • 25 kHz calibrator • RIT • AM, CW, USB, LSB, RTTY.

1099.00 list. Call for quote.



**KENWOOD TR-7400A
2m FM transceiver**

Features: • CTCSS provisions, encode and decode • 25 watt output RF • Solid-state final stage • LED readout • PLL gives 800 discrete channels • Repeater offset circuit • PLL unlock protection circuit • MOS FET.

449.00 list. Call for quote.



**KENWOOD
TS-820S transceiver**

The TS-820S features a factory installed digital frequency readout. • 160 thru 10 meter coverage • Integral IF shift • RF speech processor • VOX • Noise blanker • PLL • Built-in 25 KHz calibrator • CW side tone & semi-break-in • IF OUT, RTTY, & XVTR • Phone patch IN and OUT terminals.

1249.00 list. Call for quote.



**KENWOOD MC-50
desk microphone**

The MC-50 dynamic mike is designed expressly for amateur radio operation. • Complete with PTT & LOCK switches • Easy conversion from HI to LOW impedance • Unidirectional • Mike plug on coil cord for instant hook-up to any Kenwood rig.

45.00 list. Call for quote.



**KENWOOD
MC-35S
dynamic mic**

The MC-35S is a 50 K ohms impedance, dynamic hand held mic. A 2-position switch lets you operate in a quiet mobile or fixed station or select noise cancelling for use in high ambient noise environments. MC-30S: same as MC-35S but 500 ohms, low impedance for TR-7400/7500.

29.00 Call for yours today.



**KENWOOD R-300
all band receiver**

Its all band/all mode reception is covered by 6 bands, 170 KHz - 30 MHz in AM, SSB, or CW. RF & mixer stages use dual-gate MOS FET transistors. 3-way power, AC/DC/batteries.

279.00 list. Call for quote.

Remember, you can Call Toll Free: 1-800-633-3410 in the U.S.A. or call 1-800-292-8668 in Alabama for our low price quote. Store hours: 9:00 AM til 5:30 PM, Monday thru Friday.



Long's Electronics



MAIL ORDERS: P.O. BOX 11347 BIRMINGHAM, AL 35202 • STREET ADDRESS: 2808 7TH AVENUE SOUTH BIRMINGHAM, ALABAMA 35233

Long's suggests YAESU

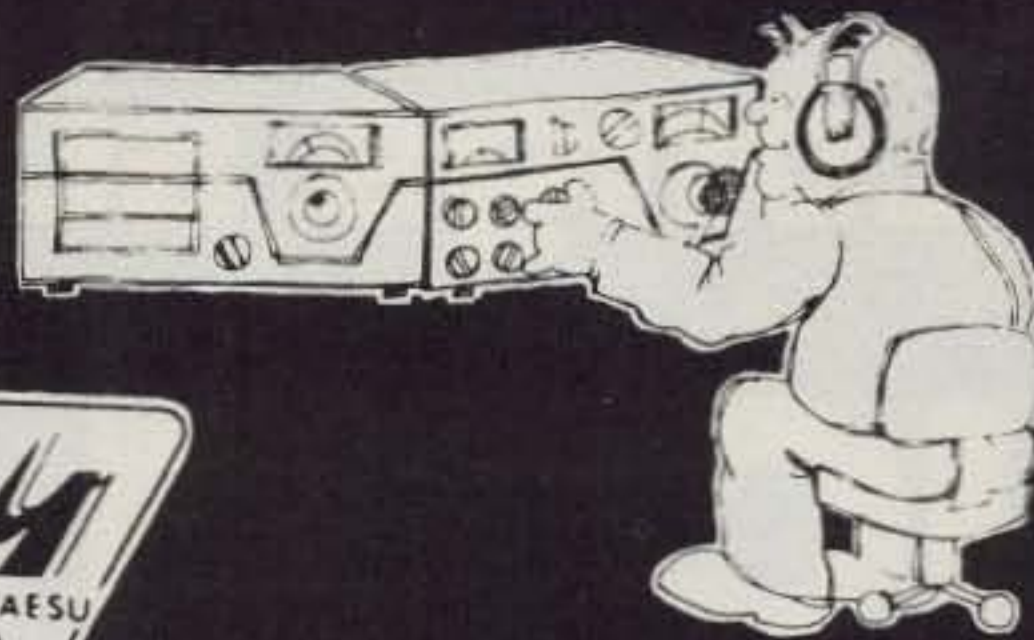

Call Toll Free 1-800-633-3410



YAESU FT-901 DM HF transceiver

Check these: • Reject tuning • Variable IF band width tuning • Audio peak frequency tuning • Digital LED frequency display w/memory for TX & RX, no external VFO required for split frequency operation • Built-in Curtis keyer • Rugged GE 6146B final tubes • 160 thru 10 meter coverage & much more!

1459.00 list. Call for quote.



YAESU SP-101PB speaker/phone patch

The SP-101PB features: • A shaped response speaker from 300 to 3000 Hz • Built-in hybrid phone path with individual gain controls • VU meter. Full VOX operation • Receiver input impedance: 4 or 600 ohm • Output impedance: 600 ohm or high impedance.

67.00 Call for yours today.

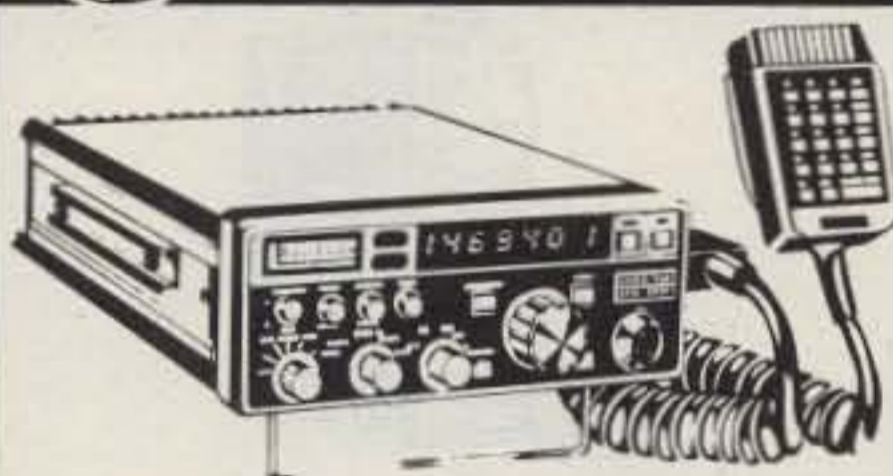

YAESU CPU-2500RK 2m FM transceiver

Full 4 MHz coverage in 5 KHz steps 144-148 MHz • 4 memory channels may be programmed • Built-in scanner • keyboard mic allows for remote control of memories & dial frequencies • Also serves as an auto patch encoder • Power output 3 watts/25 watts.

585.00 list. Call for quote.



YAESU FT-225RD All mode 2m transceiver

The FT-225RD features: • Full 4 MHz coverage of the 2 meter band, SSB, CW, AM & FM • PLL circuitry • Digital plus analog frequency readout • AC & DC power supply • Variable RF output: 1-25 watts • Memory optional.

895.00 list. Call for quote.

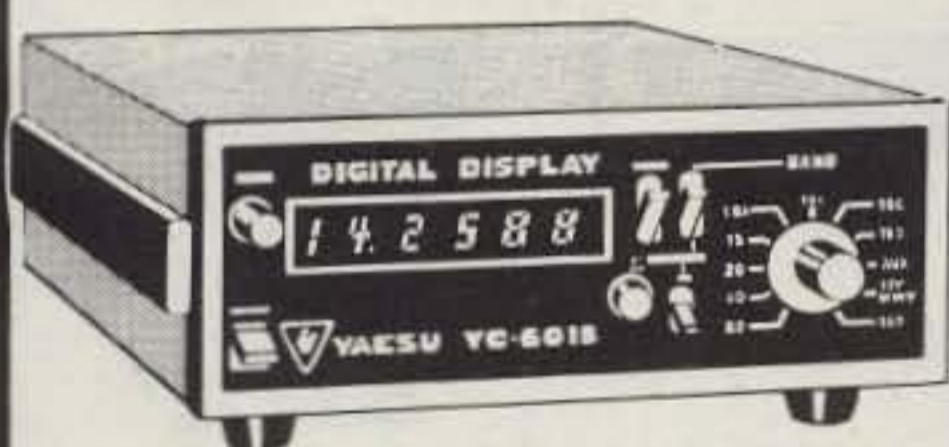

YAESU YC-601B Digital Display Unit

Features: • LED digital display • Combination display & Frequency Counter • Built-in power supply • Clock Oscillator: 1.31072 MHz • Gate time 0.1 sec. Power source 117/220 VAC 50/60 HZ. All bands are switch selected with 100 Hz accuracy.

235.95 list. Call for quote.



YAESU FT-227R "MEMORIZER"

• One knob channel selection using optical sensing to select 800 channels • Memory circuit allows instant return to any frequency selected between 144-148 MHz • LED readout • Fully synthesized frequency control • Automatic final protection, PLL "unlock" protection circuit and busy channel indicator • Selectable 10 watt HI/1 watt LOW output.

349.00 list. Call for quote.

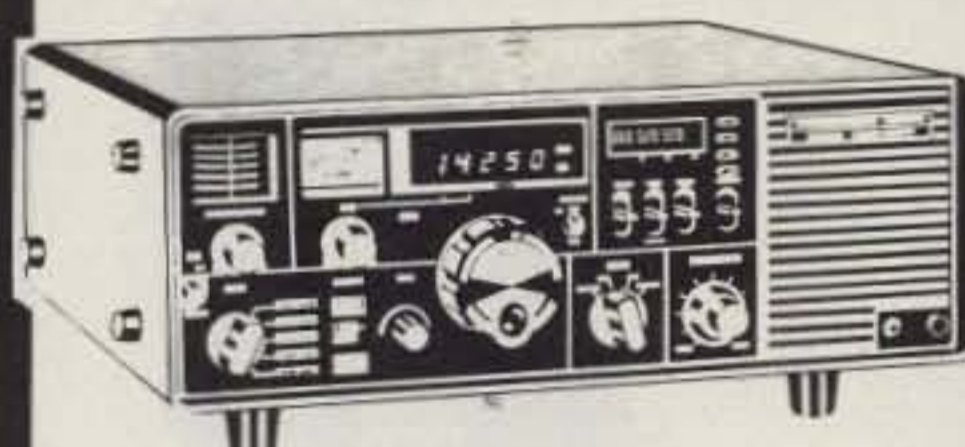

YAESU FRG-7000 general coverage receiver

Triple-conversion superhet receiver • All solid-state • Digital frequency display • 24 hr. digital clock for local and GMT time • Receives 0.25 MHz-29.9 MHz • Built-in AC power supply • Plug in circuit boards.

655.00 list. Call for quote.

Remember, you can Call Toll Free: 1-800-633-3410 in the U.S.A. or call 1-800-292-8668 in Alabama for our low price quote. Store hours: 9:00 AM til 5:30 PM, Monday thru Friday.

VISA

Long's Electronics

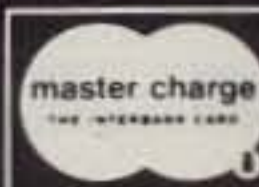

MAIL ORDERS: P.O. BOX 11347 BIRMINGHAM, AL 35202 • STREET ADDRESS: 2808 7TH AVENUE SOUTH BIRMINGHAM, ALABAMA 35233

Call Toll Free 1-800-633-3410

Long's suggests ICOM

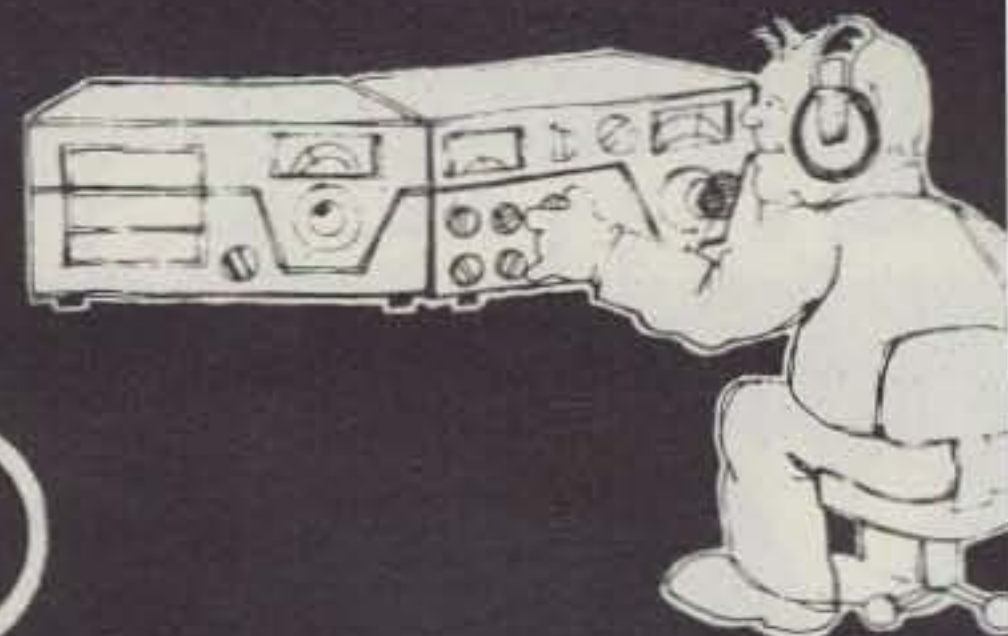

ICOM IC-701 HF transceiver

The NEW IC-701 features: • Solid-state • RF speech processor • 100 W continuous on all bands, all modes • USB, LSB, CW, CW-N, RTTY operation • Double balanced Schottky Diode Mixer used in both RX/TX • Dual built-in digital VFO • Price includes mic & power supply.

1600.00 Nationally advertised value.

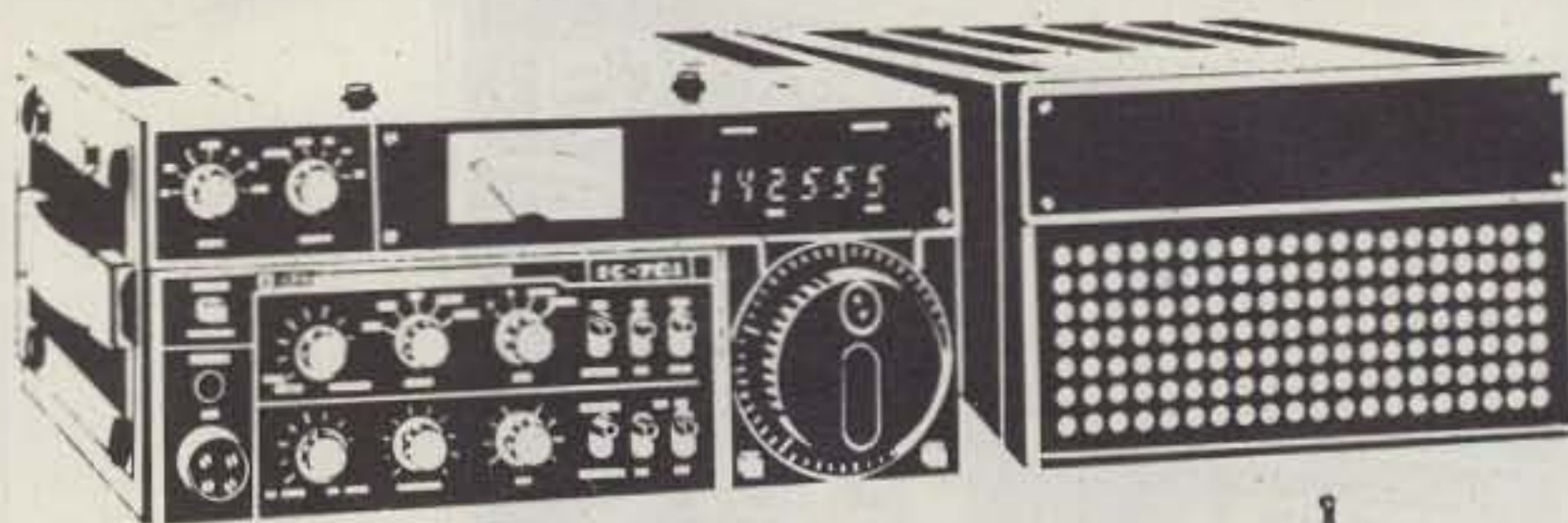

ICOM IC-280 remotable 2m FM mobile

Frequency 143.90-148.11 MHz • Power: 10 watts Hi, 1 watt adj. Low • Power requirements: 13.8 VDC at 2.5 amps • Main PLL control head may be detached and remotely mounted • With microprocessor, stores 3 frequencies • Easy to read LED's.

475.00 Nationally advertised value.



ICOM IC-202S 2m SSB portable

The IC-202 features: • Frequency coverage: 144-146 MHz • Modulation: A3J and A1 • RF output power: A3J 3 watts (PEP), A1 3 watts • Sensitivity: 0.5 microvolts at (S+N)/N 10 dB or better • Includes a true IF noise blanker • Requires "C" batteries or external 12 volt source.

356.25 Nationally advertised value.

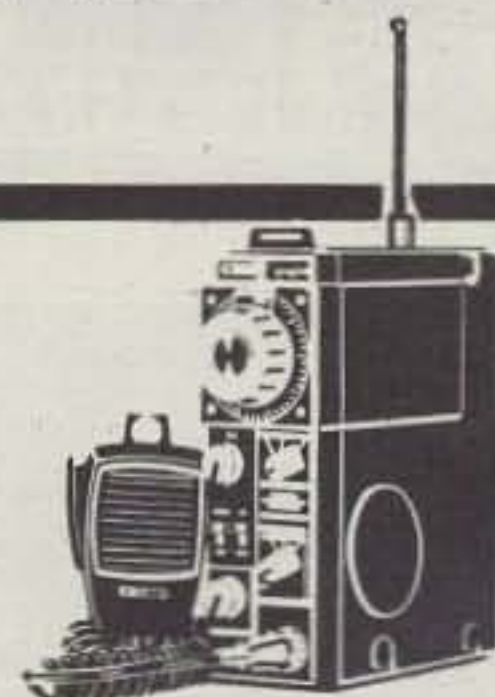

ICOM IC-402 432 MHz SSB & CW portable

Frequency range 430-435.2 MHz in any 200 KHz bands • Power output 3 watts PEP SSB • CW, USB, LSB • Receiver sensitivity 0.5 UV at 10 dB SINAD. Provisions for external antenna & power sources • BC-20 nicad battery pak & charger optional 49.95. Pending FCC Type approval.

468.75 Nationally advertised value.



ICOM IC-215 2m FM transceiver

Features: • 15 channel capacity • MOS FET RF amplifier & 5 tuned circuits in the front end for optimum sensitivity and selectivity • S-meter on front panel • Dual power level, 3 watts HI for long distance, 0.5 watt LOW for local • Uses C batteries or rechargeable cells.

225.00 Nationally advertised value.

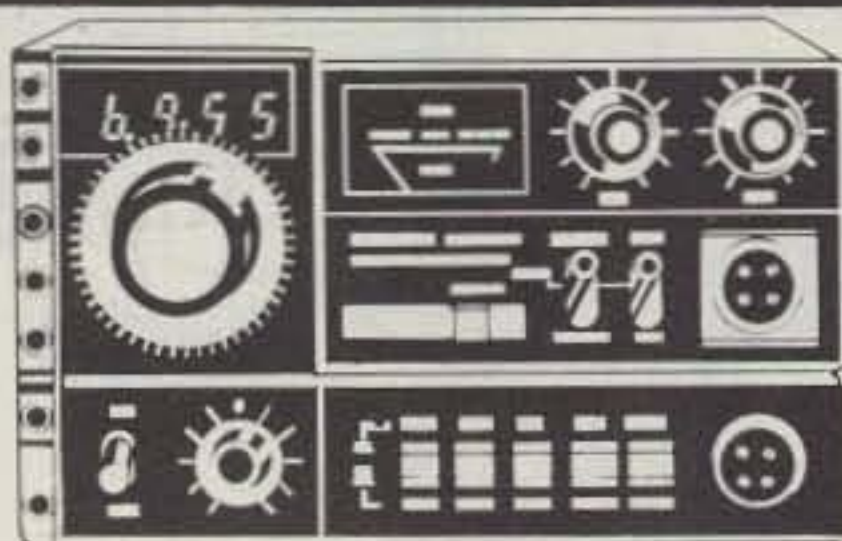

ICOM IC-245/SSB all mode 2m transceiver

Includes single sideband adaptor allowing both FM & SSB/CW • Frequency 144-148 MHz • TX output: F3, 10W; A3J, 10W (PEP); A1, 10W • 4-digit LED • RIT function • Step size: 5 KHz for FM, 100 Hz or 5KHz for SSB.

687.50 Nationally advertised value.



ICOM IC-211 2m transceiver

• 144 to 148 MHz coverage • Modes: SSB, CW, FM • LSI synthesizer PLL • 4-digit LED readout • Pulse-type noise blanker • VOX w/adjustable gain • SWR bridge • CW monitor • Automatic power control • AC/DC power supplies • Antenna impedance: 50 ohms unbalanced • TX output: 10W PEP.

850.00 Nationally advertised value.

Remember, you can Call Toll Free: **1-800-633-3410** in the U.S.A. or call **1-800-292-8668** in Alabama for our low price quote. Store hours: 9:00 AM til 5:30 PM, Monday thru Friday.



Long's Electronics



MAIL ORDERS: P.O. BOX 11347 BIRMINGHAM, AL 35202 • STREET ADDRESS: 2808 7TH AVENUE SOUTH BIRMINGHAM, ALABAMA 35233

Long's suggests

TEN-TEC



Call Toll Free 1-800-633-3410



TEN-TEC 262M AC power supply

Solid state with built-in metering • 117 VAC, 50-60 Hz • Output 13 VDC plus or minus 0.5v • VOX sensitivity less than 1 mV.

145.00 list. Call for quote.

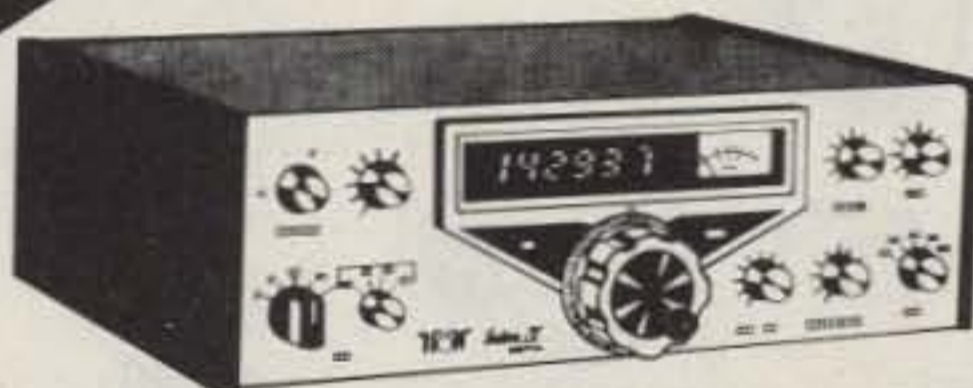

TEN-TEC 544 digital HF transceiver

The 544 features: • 3.5 to 30 MHz coverage • Solid-state • Instant band change • 8-pole crystal IF filter • LED digital readout • 200W input on all bands • WWV at 10 & 15 MHz • Full CW break-in • "S" meter and SWR bridge • 100% duty cycle, full power for RTTY & SSTV.

869.00 list. Call for quote.



TEN-TEC Century 21 CW transceiver

Features: • Full break-in • 70 watts input • Solid-state • Built-in speaker • Receives CW or SSB • Instant band change • Offset receiver tuning • Overload protection • Sidetone with adjustable level • Regulated power supply • 80 thru 10 meters with crystals supplied.

299.00 list. Call for quote.

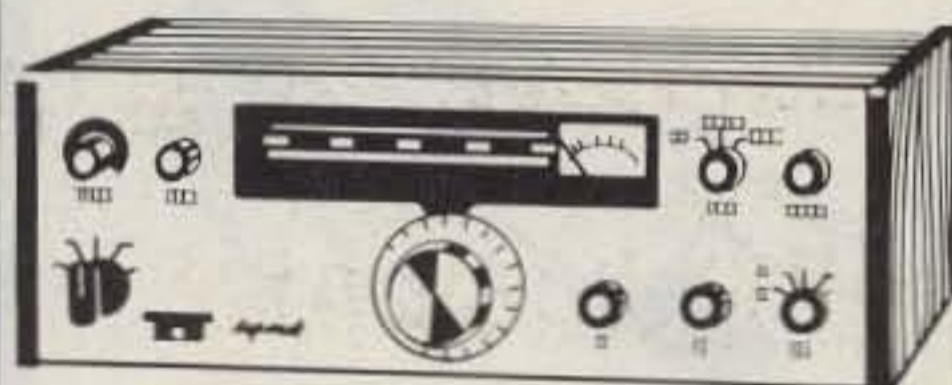

TEN-TEC 509 Argonaut transceiver

Enjoy the fun of QRP • 80-10 meters • 2.5 KHz bandwidth • Auto sideband selection, reversible • Permeability tuned circuits. Direct frequency readout.

369.00 list. Call for quote.

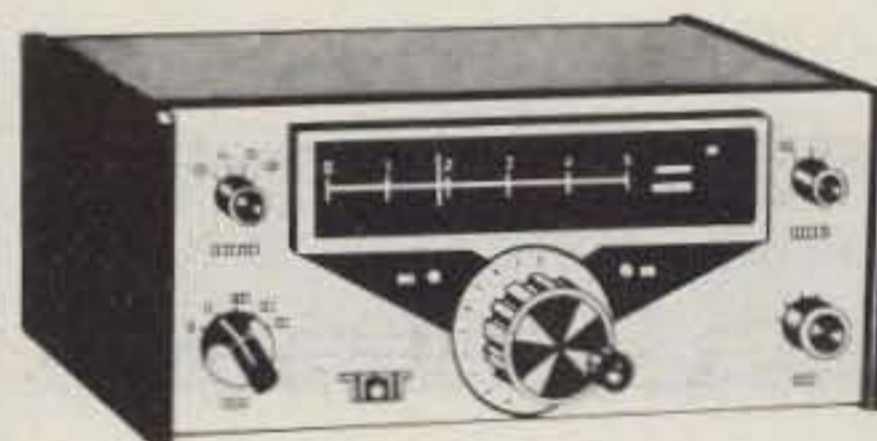

TEN-TEC 242 remote VFO

Features mode selection switch, with LED indicators allows 6 different TX & RX modes. Instant break-in • Two-position crystal oscillator may be selected as the remote generator or fixed frequency.

179.00 list. Call for quote.



TEN-TEC KR-50 electronic keyer

Completely automatic • Speed range 6-50 WPM • Weighting ratio 50%-150% of classic dit length • Memories: Dit & dah w/individual defeat switches. Sidetone: 500 Hz.

110.00 list. Call for quote.



TEN-TEC KR20A electronic keyer

Speed range 6-50 WPM • Self-completing dits and dahs. Dit length increased approx. 10% @ 20 WPM • Sidetone: sawtooth waveform • 15 volt-amp contacts, 400 v max.

69.50 Call for yours today.



TEN-TEC KR-5A electric keyer

For portable, mobile or fixed stations • Reed relay 15 V-amp contacts, 400 V max. • 6 to 50 WPM • Self-completing dits & dahs • Dit length increased approx. 10% @ 20 WPM.

39.50 Call for yours today.

Remember, you can Call Toll Free: **1-800-633-3410** in the U.S.A. or call **1-800-292-8668** in Alabama for our low price quote. Store hours: 9:00 AM til 5:30 PM, Monday thru Friday.

VISA

Long's Electronics



MAIL ORDERS: P.O. BOX 11347 BIRMINGHAM, AL 35202 • STREET ADDRESS: 2808 7TH AVENUE SOUTH BIRMINGHAM, ALABAMA 35233

Call Toll Free 1-800-633-3410

Longs suggests ACCESSORIES



BIRD MODEL 43 ThruLine® watt meter

50-ohms nominal impedance. VSWR with UHF connectors 1.05 max • Expanded scales of 25, 50 & 100 permits direct reading from 100 Mw to 10,000 watts.

125.00 Call for yours today.



BIRD Model 43 plug-in elements

Frequency bands in MHz

| Power Range | 2-30 | 25-60 | 100-250 | 200-500 | 400-1000 |
|-------------|-------|-------|---------|---------|----------|
| 5W | | 5A | 5C | 5D | 5E |
| 10W | | 10A | 10C | 10D | 10E |
| 25W | | 25A | 25C | 25D | 25E |
| 50W | 50H | 50A | 50C | 50D | 50E |
| 100W | 100F | 100A | 100C | 100D | 100E |
| 250W | 250H | 250A | 250C | 250D | 250E |
| 500W | 500H | 500A | 500C | 500D | 500E |
| 1000W | 1000H | 1000A | 1000C | 1000D | 1000E |
| 2500W | 2500H | | | | |
| 5000W | 5000H | | | | |

38.00

44.00

For A, C, D, E elements (25-1000 MHz)

For H elements (2-MHz)

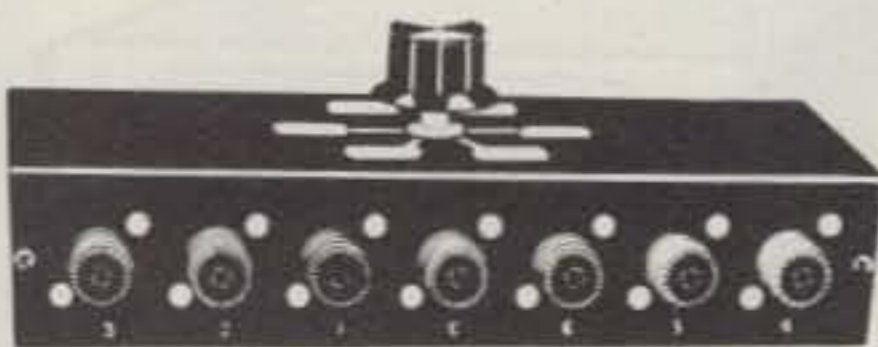

B & W 595 coax switch

The B & W 6-position coax switch features: Outputs 6, power rating: 2 KW PEP, VSWR less than 1.2:1 up to 150 MHz. Grounds all unused antennas. Perfect addition to any ham shack.

19.75 Call for yours today.

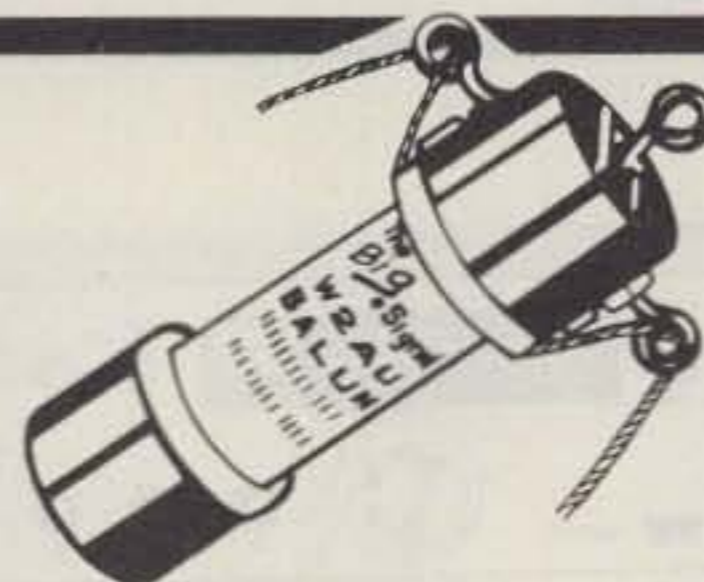

The Big Signal W2AU BALUN

- Handles full 2 KW PEP and more
- Helps TVI problems by reducing coax line radiation
- Stainless steel hardware
- Improves F/B ratio
- Replaces center insulator
- Built-in lightning arrester
- 1:1 matches 50 or 75 ohm unbalanced to 50 or 75 ohm balanced load.

14.95 Call for yours today.

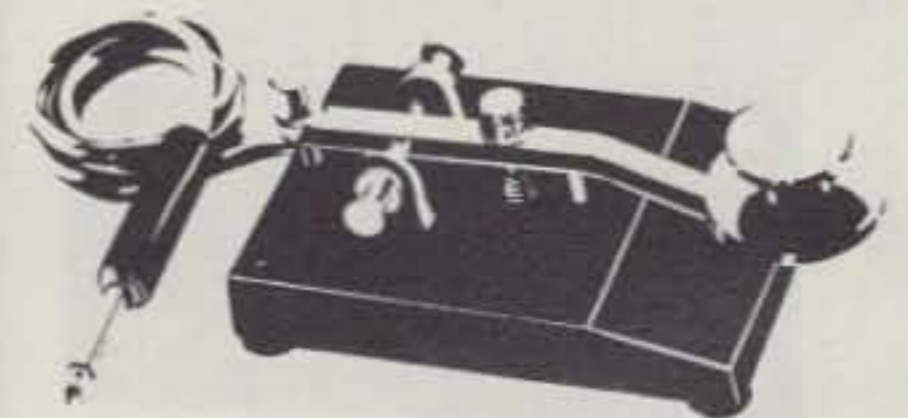

NYE VIKING "Master Key" 114-330-001

The first major improvement in telegraph key design in 50 years! Contact assembly is isolated from base, greatly reducing shock hazard. Heavy die-cast body. Gold plated silver contacts. Complete with Navy knob and two conductor cords with 1/4" key plug.

19.50 Call for yours today.

LARSEN LM-MM-150K 2m 5/8 mag mount antenna

The 5/8 wave length 2 meter antenna consists of a 49" stainless steel rod, quadruple plated, and coil for use between 144-174 MHz

- A full 3dB gain over a 1/2 wave length antenna. Magnet guaranteed permanent in ordinary use
- Full capacitance coupling
- Complete with 12' of RG-58 A/U coax & coax connector.

38.45 Call for yours today.

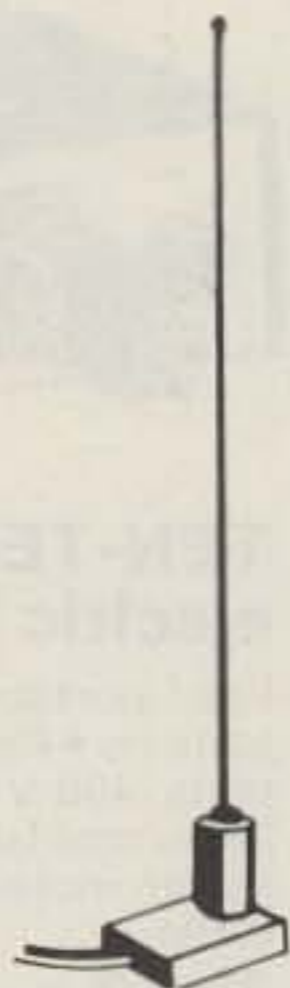

SHURE 444 desk microphone

Economical station mic. Has PTT switch, adjustable head height, solid, high impact plastic construction. Frequency response: 300 to 3000 Hz. Omnidirectional polar pattern. Controlled magnetic mic element designed for SSB. High impedance: 50K ohms.

35.00 Call for yours today.



LUMITIME CC-24 24 hr. digital clock

The CC-24 is the perfect addition to any ham shack. Large 2 in. digital display makes telling time easy at a glance. The 24 hr. alarm with 8-10 min. snooze button can also be used as a station ID buzzer. 110 volts A/C operation.

29.95 Call for yours today.

Remember, you can Call Toll Free: 1-800-633-3410 in the U.S.A. or call 1-800-292-8668 in Alabama for our low price quote. Store hours: 9:00 AM til 5:30 PM, Monday thru Friday.



Long's Electronics



Long's suggests SWAN

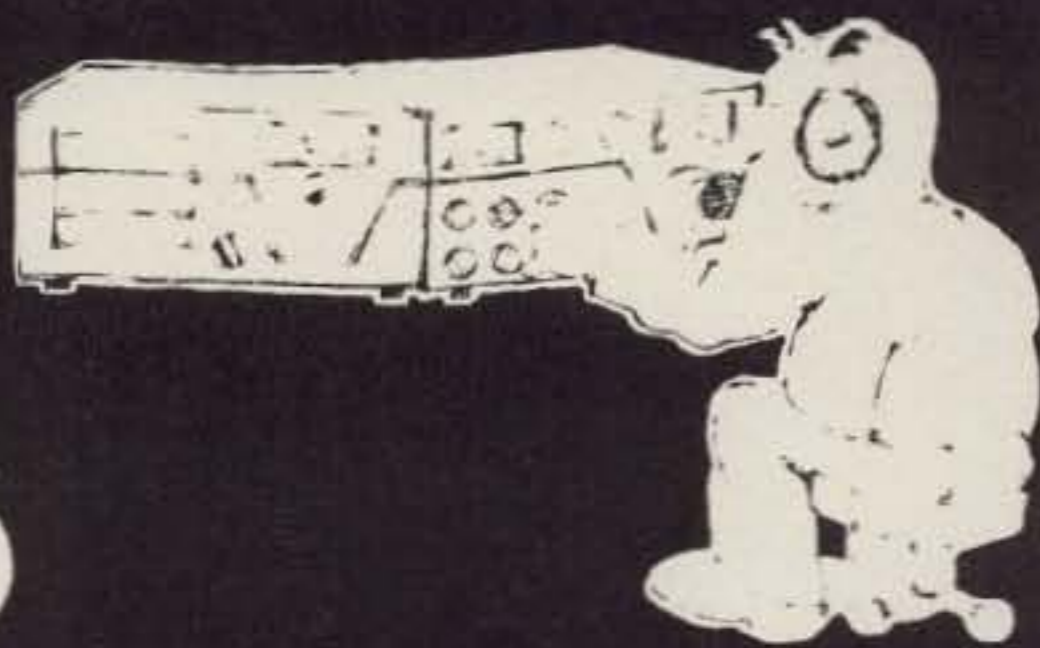

Call Toll Free 1-800-633-3410

SWAN TB4HA 4 element tri-band beam

All four elements active on all three bands. The heavy duty TB4HA features: • Gain 9dB • Front to back 24-26 DB • Boom length 24' • Longest element 28 ft. 10 in. • Wind surface area 6 sq. ft. • 10-15-20 meters.

279.95 list. Call for quote.



SWAN TB3HA 3 element tri-band beam

The heavy duty TB3HA features: Gain 8DB • Front to back 20-22 dB • Boom length 16' • Longest element 28'2" • Wind surface area 4 sq. ft. • 10-15-20 meters.

219.95 list. Call for quote.



SWAN SWR-1A power meter and SWR bridge

Frequency range: 3.5 to 150 MHz • Compact and lightweight for portable or mobile use • Capable of handling 1,000 watts RF and measures 1:1 to infinity VSWR.

29.95 list. Call for quote.



SWAN HFM-200 SWR and power meter

Frequency 1.8-30 MHz • Two power ranges: 0-20 and 0-200 watts • VSWR 1:1-3:1 • For mobile installation a coupler may be located separate from main indicator • Meter is lighted for night use.

49.95 Call for yours today.



SWAN WMM200 SWR and power meter

Designed for mobile operation and illuminated for night operation • Directional coupler measuring method • Impedance 50 ohms • Power range: 0-20 watts and 200 watts in the second range • VSWR 1:1-3:1 • Freq 50 to 150 MHz.

49.95 Call for yours today.



SWAN WM-2000 In-line wattmeter

Frequency range: 3.5 to 30MHz • 3 scales: 0-200, 1000, and 2000 watts • VSWR scale permits reading from 1:1 to 3:1 • Uses two SO-239 connectors.

69.95 Call for yours today.

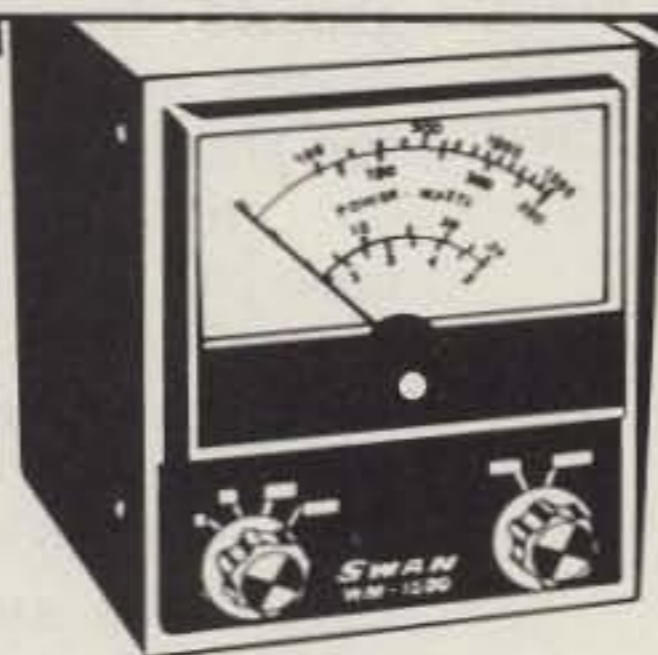

SWAN WM-1500 In-line wattmeter

Frequency range: 2-30 MHz • Accuracy is better than plus or minus 10% full scale • Four scales: 0-5, 50, 500, & 1500 watts • Uses two SO-239 connectors • Reads forward or reverse power.

74.95 Call for yours today.

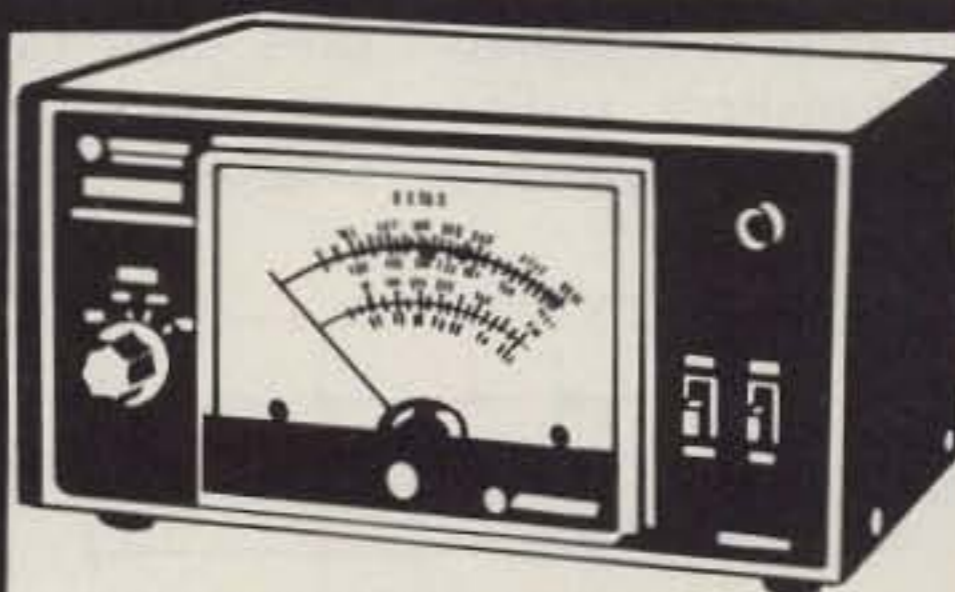

SWAN WM-3000 precision PEAK/RMS wattmeter

Read forward or reflected power with maximum accuracy from 3.5 to 30 MHz • RMS readings available with the flick of a switch • Four scales from 9 to 2000 watts. Requires 117V AC power source.

87.95 Call for yours today.

Remember, you can Call Toll Free: **1-800-633-3410** in the U.S.A. or call **1-800-292-8668** in Alabama for our low price quote. Store hours: 9:00 AM til 5:30 PM, Monday thru Friday.

VISA

Long's Electronics



Squelchifying Cheap Receivers

—junk-box project

George Hovorka WA1PDY
John Hovorka, Jr.
674 Brush Hill Road
Milton MA 02186

The market is flooded with transistor radios that cover the police

bands. They make excellent two meter monitors, except that they lack a squelch. Here is a simple squelch circuit especially designed for these receivers. This circuit uses junk transistor radio parts and can be installed in about half an hour.

How It Works

This is a carrier-activated squelch. When a carrier is present, a negative voltage is developed with respect to ground by one of the diodes in the ratio detector. This turns transistor Q1 on, and thus brings the base of Q2 to near ground potential. Previously, Q2 had been biased on by the 10k resistor connected from its base to V_{CC} . This caused the audio appearing at the top of the volume control to flow through C1 and Q2 to ground. But now with Q2 off, the audio flows to the next stage. At the end of the transmission, when the carrier ends, Q1 turns off, causing the current to flow through R2 again. This will turn Q2 back on and will ground out the audio.

Construction

In my prototype, I used point-to-point wiring with the volume control as my

base. The audio portion of these receivers is almost always positive ground. This requires PNP transistors to be used for Q1 and Q2. I used push-pull output transistors from a junk transistor radio for these. The remainder of the parts also came from the same junk radio. My receiver had a built-in ac power supply, so I removed the wiring from the battery ac switch, wired the radio permanently on ac, and used the switch for S1.

To find the control voltage for Q1, first locate the radio detector. It consists of two i-f transformers side by side with two germanium diodes close by. With the radio turned on and tuned to an FM station, put your VOM on the low voltage dc scale and connect the positive lead to ground. The case of the i-f transformer will do nicely for this. Now touch the negative probe to an ex-

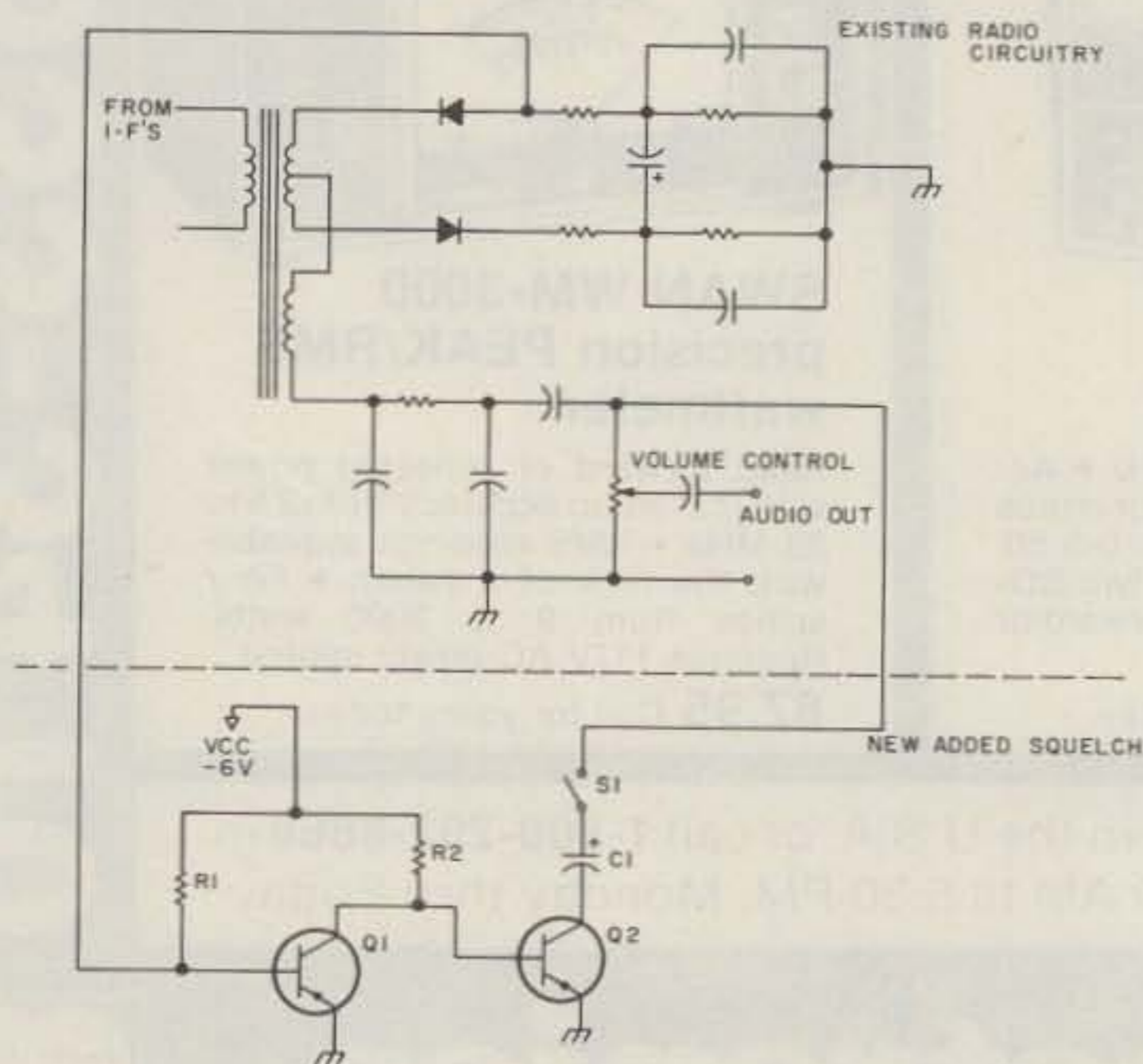

Fig. 1.

posed lead of either diode. One of these should give you a negative reading. That is your control voltage.

The value of resistor R1 is determined experimentally. First connect a one megohm potentiometer in place of it. Now turn the receiver on, and with no carrier present, adjust the potentiometer so that the squelch just opens. Now remove the potentiometer, measure its value, and substitute a fixed resistor of a slightly lower value for R1. Alternatively, a one megohm potentiometer with an attached switch could be used for R1 and S1. If your receiver has a

built-in ac power supply, replacing one of the filter capacitors in the power supply with a 5000 uF or

larger 15 volt electrolytic capacitor will greatly reduce power supply hum from the speaker.

I am certain you will find this squelch a valuable addition to your monitor receiver. ■

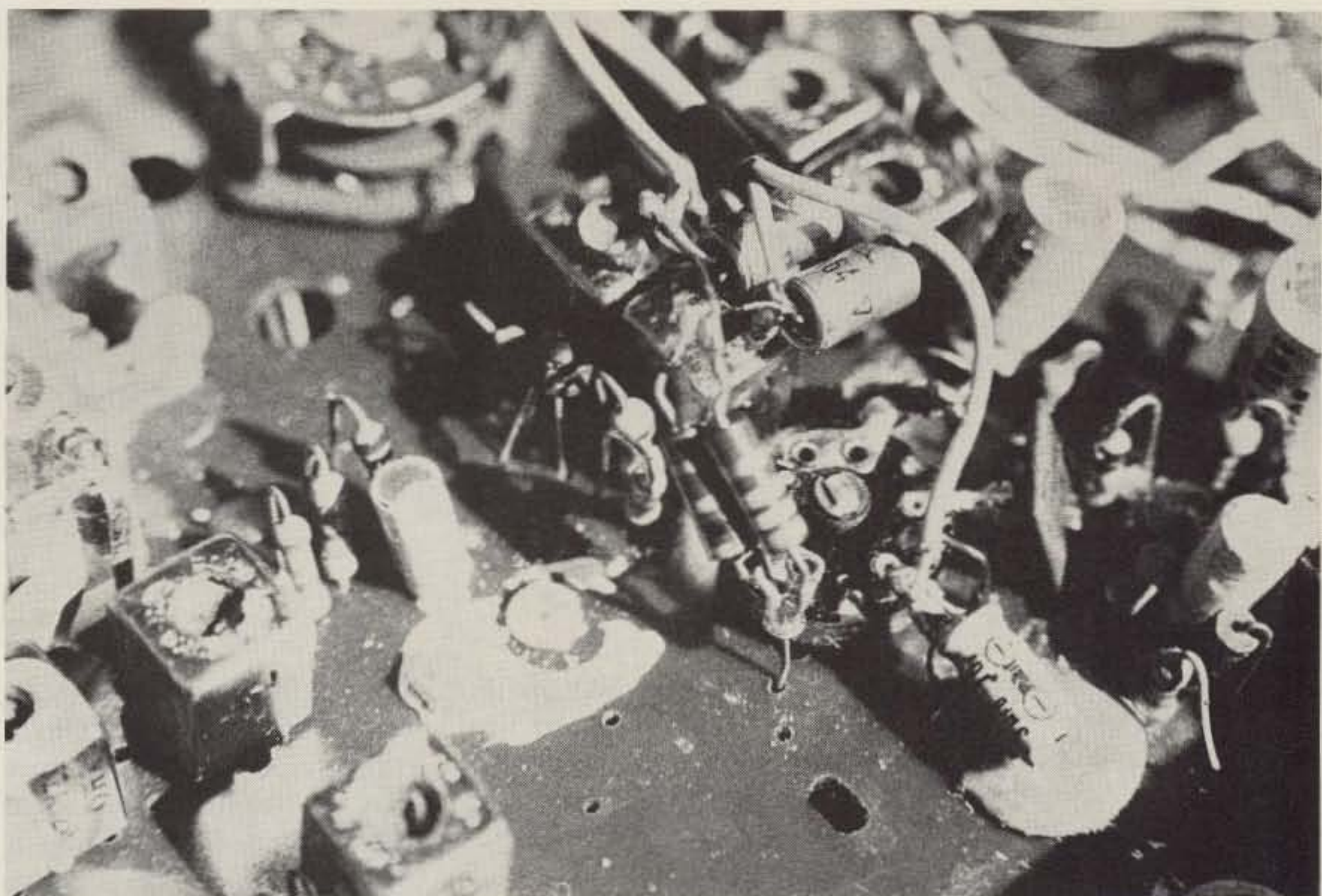

C1 is in the foreground, Q1 and Q2 are in the center, and resistors R1 and R2 are connected directly to the switch on the volume control.

Parts List

- Q1, Q2—2SD364 or equivalent PNP germanium transistors
- R1—390k ½ W resistor
- R2—10k ½ W resistor
- C1—3 μF, 10 WV dc electrolytic capacitor
- S1—SPST slide switch

\$69.95

Plus \$2.00 S/H
NY Res add tax

BRAND NEW



MESSAGE MEMORY KEYSER

Features:

- Advanced CMOS message memory
- Two (50 char. each) message storage
- Repeat function
- Records at any speed — plays back at any speed
- Longer message capacity
Example: send CQ CQ CQ DX de WB2YJM
WB2YJM K—then play second message on contact—de WB2YJM QSL NY NY 579 579 Paul Paul K
- Use for daily QSO's or contests

PLUS:

- State-of-the-art-CMOS keyer
- Self completing dots and dashes
- Both dot and dash memory
- Iambic keying with any squeeze paddle
- 5 - 50 wpm
- Speed, volume, tone, tune and weight controls
- Sidetone and speaker
- Low current drain CMOS battery operation—portable
- Deluxe quarter-inch jacks for keying and output
- Keys grid block and solid state rigs
- WIRED AND TESTED FULLY GUARANTEED—LESS BATTERY
- AT YOUR DEALER OR SEND CHECK OR MONEY ORDER

TRAC T18

Electronics, Inc.
1106 Rand Bldg.
Buffalo NY 14203

MFJ INTRODUCES A NEW 24 HOUR DIGITAL CLOCK

with HUGE 1-5/8 inch digits that you can keep set to GMT. Alarm and snooze functions let you use it as an ID Timer. Assembled, too!



\$29⁹⁵

BRAND NEW

MFJ Enterprises brings you a new 24 hour digital alarm clock with HUGE 1-5/8 inch orange 7 segment digits that you can see clear across the room.

This one is strictly for your ham shack, one that you can leave set to GMT. No more mental calculations to get GMT.

Use the alarm to remind you of a SKED or with the snooze function as an ID timer to buzz you in 8 minute intervals.

A constantly changing kaleidoscopic pattern indicates continuous operation.

Beige. 2-1/4 x 4-1/8 x 8-3/4 inches. UL listed. Requires 120VAC, 60Hz.

Order from MFJ and try it — no obligation. If not delighted, return it within 30 days for a re-

fund (less shipping). One year limited warranty by MFJ Enterprises.

To order, simply call us toll free 800-647-1800 and charge it on your VISA or Master Charge or mail us a check or money order for \$29.95 plus \$2.00 for shipping and handling.

Don't wait any longer to enjoy the convenience of a "Hams Only" clock. Order today.

MFJ ENTERPRISES, INC.

P. O. BOX 494 M52
MISSISSIPPI STATE, MS 39762
CALL TOLL FREE 800-647-1800
For technical information, order/repair status, in Miss., outside continental USA, call 601-323-5869.

Try FM On 29.6 MHz

—no, it's not a CB channel

It can happen at the most unexpected times. "QRZed the W6; this is VE3GVD." My handie-talkie was turned up full blast as I sat in my college journalism class taking an exam. Redfaced, I reluctantly shut off the HT... A scene distant in the future of amateur radio? A handie-talkie in Nevada able to chat with a chap in eastern Canada? It's happening today.

The secret is 29.6 MHz FM. Lying in the upper reaches of the 10 meter band, 29.6 is a hotbed of FM simplex activity. There are even repeaters in operation on the 10 meter FM band. But 29.6 is the 52 simplex of the 10 meter band, only *more* exciting.

The 10 meter FM band (29.5-29.7 MHz) enjoys the characteristics of both HF and VHF. When the MUF gets high enough for 10 meter sideband to come

alive, 10 meter FM up the road usually pops to life. Also, 10 FM is great for covering local ground effectively while waiting for the skip to roll in.

In Las Vegas, we don't have our 10 meter repeater on the air yet, but we are very active on 29.6 FM simplex. "We" refers to a group of southern Nevada amateurs known collectively as the Nevada Amateur Radio Club (NARC). Through the use of our touchtone™ pads on our UHF handie-talkies, mobiles, etc., we have access to autopatch, fully synthesized 2 meter FM, and, of course, 29.6 FM. On 2 meters, through linking of repeaters, we can chat with Los Angeles (about 240 miles air) and, on the other end, Salt Lake City (around 375 miles air). But it's agreed, we have the most fun on 29.6 FM.

29.6 is a new addition to our remote base system.

Originally, we had 52.525, the 6 meter simplex frequency, installed in our box on the mountain. Due to lack of excitement, a decision was made to yank 6 and take our chances with 10 FM. When we chatted with our first contacts cross-country on 29.6, we knew our decision to convert to 10 FM was a mighty fine one.

The mastermind of the NARC Radio System, Wayne K7WS, besides utilizing the remote base radio, has his own 29.6 base station, mobile unit, and 29.6 HT-200, all weaned out of 30 MHz commercial service. Using a combination of these radios, Wayne can carry on solid QSOs while the rest of us hear sometimes only bits and pieces of the 29.6 DX signal. Multipath distortion causes the signal to fade out of our remote base receiver (20 miles from the city). When the signal fades out on the receiver on the hill, it "fades in" usually on Wayne's 29.6 receiver at his house or mobile or hand-held due to multipath.

Such a technique as described above is called "diversity reception." This

enables one to enjoy an almost fadeless signal on 29.6. In turn, if need be, Wayne can use "diversity transmission." Wayne's 29.6 base station transmitter is tuned so close to the remote 29.6 transmitter frequency that, instead of a heterodyne, the guy on the other end in Maryland, Michigan, Oregon, or wherever may only notice a slight echo effect. Of course, solid QSOs can be made without such techniques as diversity transmission and reception.

Unfortunately, familiarity with 10 FM is limited. On occasions, I will try to get a station I work on 10 sideband around 28.6 to take a listen for me on 29.6 and report back to me on 28.6. (Through the simple process of slope detection, FM signals are audible on AM/SSB receivers. And you don't even have to know what slope detection is, either.) Responses to requests to listen on 29.6 go like this: "I don't think I can hear the satellite here." "FM on 10 meters?" "You want me to listen for you in the CB band?!" 29.6 MHz and surrounding frequencies are not in the CB band, but unless we start using them, they will be. ■

| Location | Call | Input | Output |
|-----------------|--------|--------|--------|
| Marysville WA | WR7ADB | 29.59 | 29.69 |
| Port Neches TX | WR5AOK | 29.64 | 29.60 |
| W. Patterson NJ | WR2ANW | 29.54 | 29.64 |
| Boston MA | WR1AGM | 29.685 | 29.52 |
| Baltimore MD | WR3AID | 29.58 | 29.68 |
| Palatine IL | WR9ALA | 29.515 | 29.615 |
| Wilmington DE | WR3AGR | 29.52 | 29.62 |

Table 1. 10 meter FM repeater chart.

Midland's 13-510 Is One Great 2-Meter Mobile. Our 13-510A Is Even Better!



- NEW!** The 13-510A P.L.L. synthesizer delivers 1,200 frequencies between 143.00 and 149.00 MHz . . . the full 2-meter band, plus MARS.
- NEW!** The 13-510A will operate with up to a 6 MHz split between TX and RX frequencies.
- NEW!** The 13-510A microphone connector is pre-wired for your Touch-Tone® encoding microphone.
- NEW!** The 13-510A has a 7-pin accessory connector for your Touch-Tone® dial, tone-burst generator or discriminator meter. *Touch-Tone is a registered trademark of AT&T.
- NEW!** The 13-510A is compatible with available popular CTCSS continuous tone-coded squelch system accessories.
- NEW!** The 13-510A has 3 transmitter outputs: 1, 10 and 25 watts.

Midland's 13-510, with its commercial-type modular construction, earned its reputation as one tough 2-meter FM mobile. Now Midland has made the 13-510A an even more versatile performer!

The 13-510A P.L.L. synthesizer splits the 6 MHz spread between 143.00 and 149.00 into 600 discrete frequencies, and a 5 KHz up-shift delivers 600 more for a total of 1,200 . . . shown directly on the digital display. In addition, there's access to 4 available offsets for repeater operation on ± 600 Hz with crystals supplied or up to 6 MHz spread with your crystals installed. Inside the 13-510A, there's a highly sensitive (0.3 μ V), highly selective (-70 dB at ± 15 KHz) dual conversion receiver with

dual gate MOSFET RF and mixer stages, crystal filter in the 1st IF, ceramic filter in the 2nd IF, and helical resonators in the RF amplifier.

The transmitter is conservatively rated for 25 watts output, switchable to 1 or 10 watts for repeaters, and uses direct FM modulation to deliver natural sounding audio.

Other features making Midland's 13-510A the one to look at include automatic protection circuit for the output transistor, internal DC filtering and polarity protection, a deep-finned heat sink for the power transistors, and electronic switching that needs no mechanical maintenance. Mobile mounting bracket, base stand and push-to-talk microphone are included.

CHECK OUR SPECS:

RECEIVER. Type: dual conversion superheterodyne. 1st IF frequency: 16.9 MHz. 2nd IF frequency: 455 KHz. Sensitivity: Less than 0.5 μ V for 20 dB quieting (0.3 μ V for 12 dB SINAD). Spurious response: -60 dB. Squelch threshold: Less than 0.3 μ V. Modulation Acceptance: ± 7.5 KHz. Selectivity: -70 dB at ± 15 KHz. Audio output power: 1.5 watts at 8 ohms.

TRANSMITTER. Outputs: 1, 10, 25 watts. Frequency deviation: Adjustable 3 - 16 KHz (normal 5 KHz). Audio Input: 600 ohms. Modulation system: Direct FM. Spurious Radiation: Less than -60 dB below carrier.

GENERAL. Power: 13.8 volts DC, negative ground. Current drain: Transmit, 2 - 7 amps.; receive, 0.8 amps. average. Antenna impedance: 50 ohms. Unit size: 2-5/8" x 6-13/16" x 9-5/8". Unit weight: 6.6 lbs.

Want to know more? See your
Amateur Radio Dealer for Midland Quality

- P.L.L. "220" MOBILE
- CRYSTAL "220" MOBILE
- ANTENNAS & ACCESSORIES

. . . or write for free full-color brochures. ^{M41}

MIDLAND[®]
INTERNATIONAL

P.O. Box 1903, Kansas City, Missouri 64141

Build the Brute

—unique heavy-duty power supply

With the extensive literature on regulated power supplies, it seemed doubtful that there was much left to write about them. However, this power supply does have some unique features which have been derived from many hours of experimentation.

The power supply disconnects itself from an over-current load or short circuit, protecting its components without blowing any fuses.

It also disconnects if, for any reason, it should attempt to provide over-voltage output, protecting expensive equipment

which it may be powering. Again, no fuses blow; it just disconnects.

All the power transistors can be bolted directly to their heat sinks, which are bolted directly to the chassis, providing maximum thermal conductivity and best use of available cooling area.

Equivalent source impedance is less than 5 milliohms, equivalent to a zero impedance source connected by about a foot of 16-gauge wire. No integrated circuits are used.

The power transformer was rebuilt from a large tube-type color TV set and had a core area of about 3

square inches. The primary was retained, all other windings being removed. Counting the turns of a previous 6.3-volt winding showed the voltage per turn to be 0.62, indicating that the desired 19.4 volts required 31 turns on each side of center-tap. There was just room to snugly use #12 in the available window. A pair of 100-Ampere, 100-volt piv diodes were used. An experimental dummy load showed the secondary holding up to about 18.5 volts and the trough of the ripple at 17 volts with the 43,000 μ F filter capacitor.

About 26 volts dc was present at no load, comfortably below the 30-volt rating of the capacitor. A surplus computer power supply heat sink with three NPN T0-3 transistors having about 120 square inches of cooling fins was used for the pass transistor output stage. Mounted on the sink were the three 0.18-Ohm emitter-balancing resistors which assure an extremely good current sharing between the three NPN transistors. However, this accounts for a whole volt of drop at 20 Amperes. Probably, 0.1-Ohm, 5-Watt resistors would be just fine and would conserve about half a volt of drop. It was

determined by experiment that 10 milliamperes into the base of the Darlington-connected driver power transistor would maintain a 20-Ampere load, indicating a beta product of about 2000, which is somewhat higher at more moderate loads.

Having committed myself to connecting the power transistor collectors to the negative output, I could find no circuit in my available literature to complete the design. I decided to build up a differential amplifier of PNP signal transistors so that the collector current of one of them would provide base current to the Darlington input stage. If the two bases are at the same voltage, the collector currents should be equal.

Initially, a 6.2-volt zener was connected between the base and collector of T1, and the base of T2 was connected to a potentiometer across the output of the supply. The current of T2 increased when the output was loaded, so it was connected to the Darlington. The potentiometer adjusted the output nicely, but, when the amplifier stage was connected, the regulation was not outstanding—the output dropped nearly half a volt under full load. So a sec-

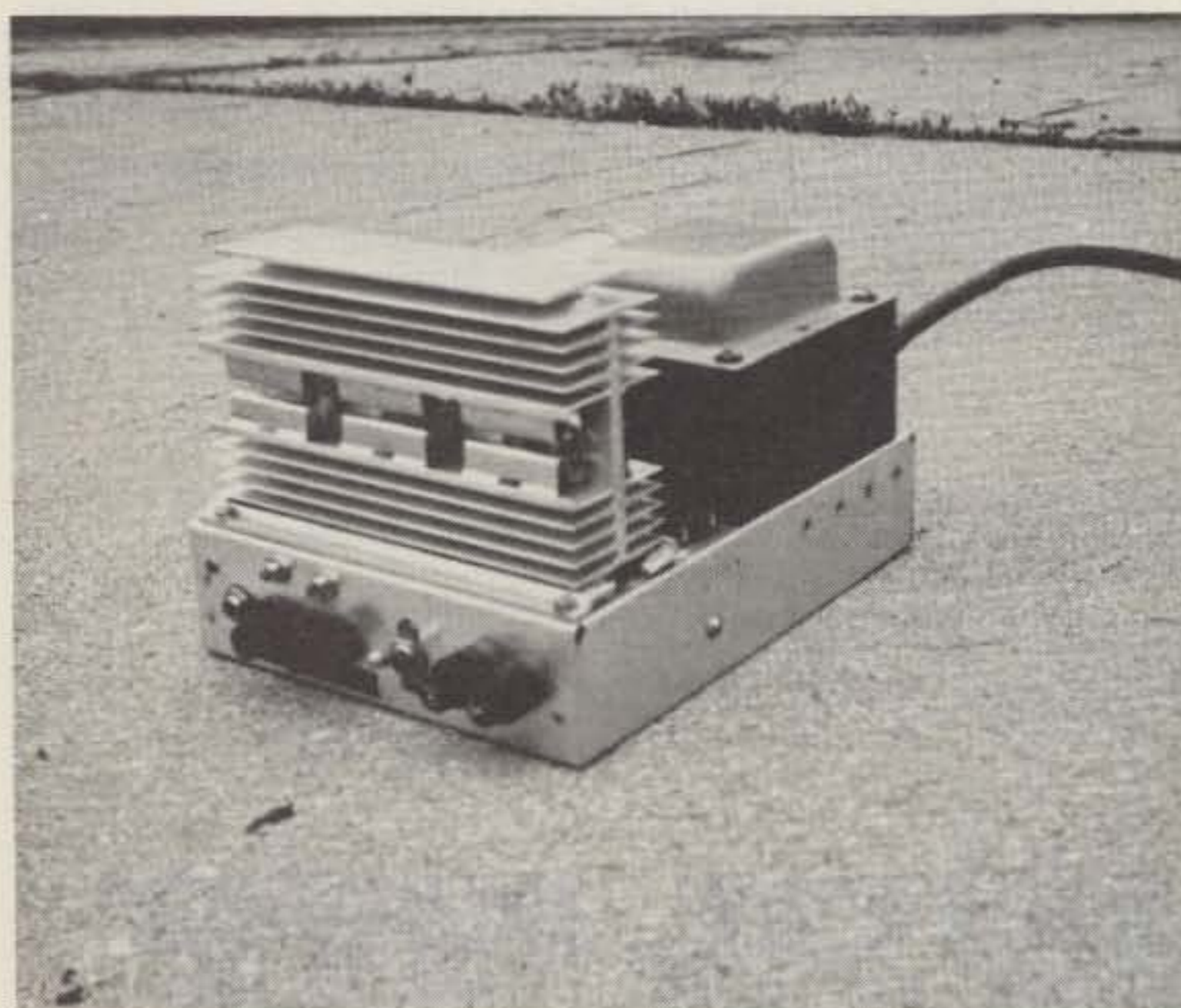

Front view.

Clegg is FM Headquarters!

No one else offers the wide selection of VHF FM Transceivers that you'll find at Clegg.



Clegg FM-DX
40+ Watts—
Synthesized
Made in USA
"THE BEST"

Clegg FM-28
25 Watts—
Synthesized
"Second only to
the FM-DX"

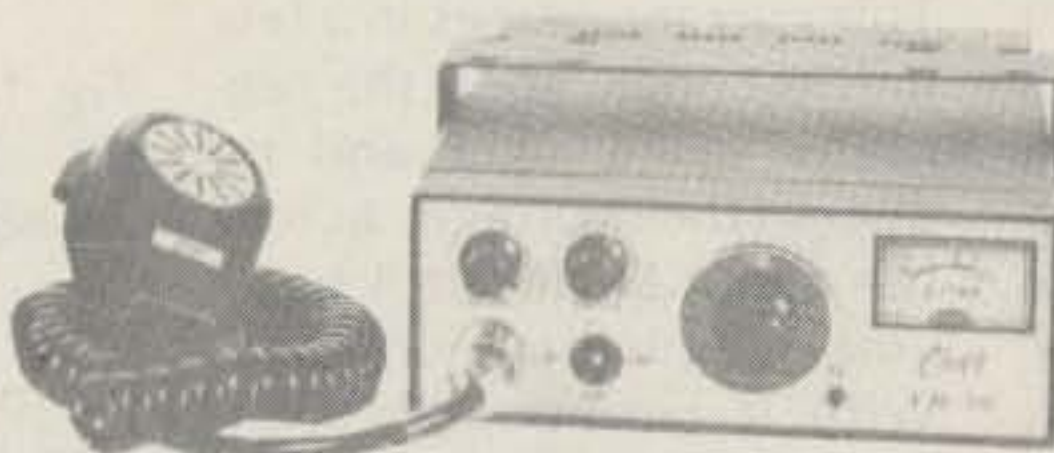
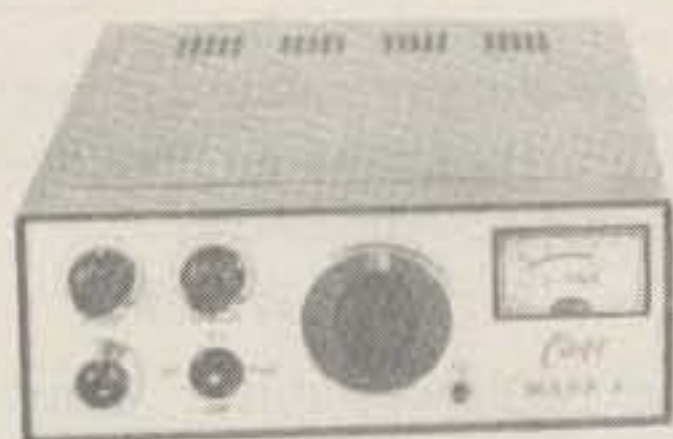

Clegg MARK 3 and FM-76
12 Channel coverage.
Select 144 or 220 MHz
"For the budget minded"

But if you have another brand in mind we can supply any of the other fine FM or Multi-Mode Transceivers and Hand Helds manufactured by YAESU, ICOM, WILSON, DRAKE—and at very competitive prices. And we service them all!



Yaesu CPU-2500R



Yaesu FT-625RD & FT-225RD



WILSON Mark II



ICOM IC-211

Whatever your needs in FM or Multimode Transceivers, Hand Helds, Antennas, etc., call your friends at Clegg Today! TOLL FREE! 1-(800)-233-0250 (In Pa. Call 717-299-7221)

And—let us fill your antenna requirements:

- Towers, Masts & Hardware
- Rotators & Cables
- Coax & Connectors
- HF, VHF, UHF Beams & Mobile Antennas
- Multi-Band Dipoles
- Traps & Baluns

Clegg

✓ C3

Communications Corp.
1911 Old Homestead Lane
Greenfield Industrial Park East
Lancaster, PA 17601

You're just a few digits away from name brand radio equipment - AT DISCOUNT PRICES!

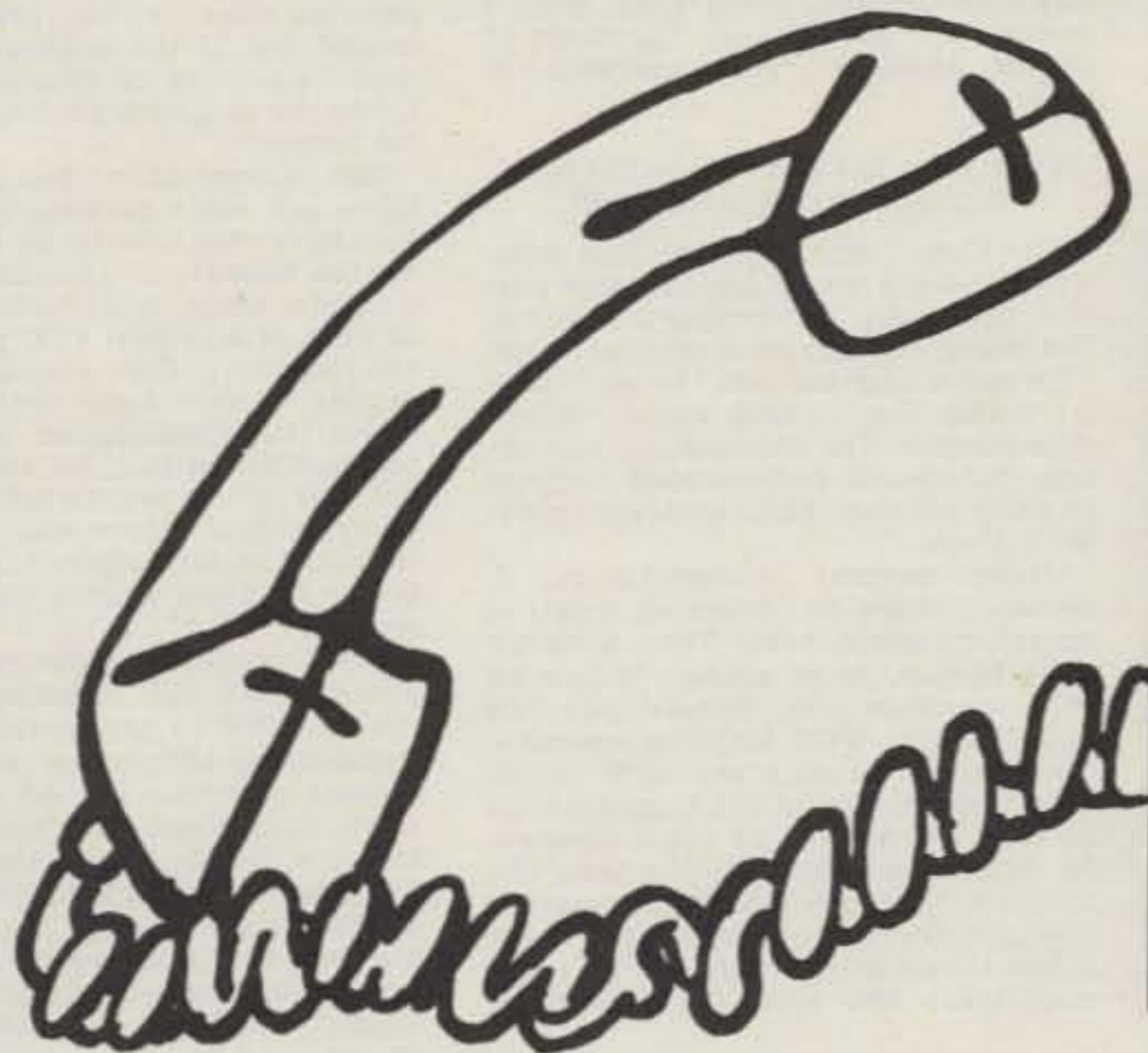

CALL TOLL FREE

1-800-228-4097
Communications Center

443 N 48th Street ✓ C58
Lincoln, Nebraska 68504
In Nebraska Call (402)466-8402

1-800-634-6227
**Communications Center
West**

1072 N. Rancho Drive
Las Vegas, Nevada 89106
In Nevada Call (702)647-3114

YAESU
KENWOOD
DRAKE
ICOM
STANDARD
EDGECOM
KDK

DENTRON
HY-GAIN
MOSLEY
CUSHCRAFT
WILSON
HUSTLER
LARSEN

TAYLOR
SWAN
TEMPO
TEN-TEC
MIDLAND
CDE
AUTEK

E.T.O. ALPHA
VHF ENGINEERING
BERK-TEK CABLE
CONSOLIDATED TOWER
SAY
SHURE
TELEX

plus many more

1-800-228-4097

CALL TOLL FREE FOR

1-800-634-6227

ANTENNAS

HY-GAIN
TH6 DXX
TH3MK III
18 AVT/WB

MOSLEY
CLASSIC 33
CLASSIC 36
TA-33

CUSHCRAFT
ATB-34
ARX-2
A-147-20T

HUSTLER
4BTV
66-144A
RM-75s

WILSON
SYSTEM 1
SYSTEM 2

Specials on CDE Rotors

Ham III — \$125.00
Tailtwister — \$225.00

■ ■ ■ ■ ■ LOOK! ■ ■ ■ ■ ■

HOURS: Monday - Friday 8 a.m. - Midnight
Saturday 8 a.m. - 8 p.m.
Sunday Noon - 8 p.m.

SAME DAY SHIPPING ON MOST ITEMS

**We carry all major lines of antennas
at DISCOUNT PRICES
call for quotes: 1-800-228-4097**



AMATEUR RADIO SERVICE

Administration of Telegraphy Examinations to Handicapped Applicants for Operator Licenses; Inquiry

AGENCY: Federal Communications Commission.

ACTION: Notice of inquiry.

SUMMARY: The FCC is beginning an inquiry into its rules and procedures concerning the administration of telegraphy examinations to handicapped applicants for operator licenses in the amateur radio service. The FCC is taking this action in response to several requests from handicapped applicants for waivers of the telegraphy requirements.

DATES: Comments are due by November 30, 1978 and reply comments are due by December 29, 1978.

ADDRESSES: Federal Communications Commission, Washington, D.C. 20554.

FOR FURTHER INFORMATION CONTACT:

Mr. Gregory M. Jones, Safety and Special Radio Services Bureau, 202-634-6619.

SUPPLEMENTARY INFORMATION:

Adopted; August 8, 1978.

Released: August 24, 1978.

By the Commission: Commissioner Washburn absent.

In the matter of the administration of telegraphy examinations to handicapped applicants for operator licenses in the amateur radio service, Gen. Docket No. 78-250.

Under authority contained in Sections 4(i), 303 and 403 of the Communications Act of 1934, as amended, the Federal Communications Commission is opening an inquiry into the administration of telegraphy examinations to handicapped applicants for operator licenses in the amateur radio service. The purposes of this notice of inquiry are: (1) To inform the public about the FCC's current procedures for examining handicapped applicants for amateur operator licenses, and (2) to request guidance and advice from the public about what action, if any, the FCC should take to improve the administration of telegraphy examinations to handicapped applicants for amateur operator licenses. In this notice, the Commission outlines its present policies and rules concerning the examination of handicapped applicants for amateur operator licenses, lists several options for changes in those policies and rules, and asks interested persons to comment on the direction the Commission should take in this area.

POLICY

It is the policy of the Federal Communications Commission that no otherwise qualified handicapped person should be denied an amateur radio operator license solely because of his or her handicap. It also is the policy of this Commission not to discriminate in any way against handicapped applicants for amateur operator licenses. The Commission has done, and will continue to do, everything within reason to assist the handicapped obtain amateur radio operator licenses.

WHAT DOES THE COMMISSION DO NOW TO ASSIST THE HANDICAPPED?

The Commission is aware that amateur radio is a useful and valuable pursuit for many handicapped persons. For many handicapped persons, amateur radio may provide the only contact with the "outside world." Whenever possible, the Commission encourages interested handicapped persons to study for and obtain amateur operator licenses.

Under normal circumstances, a person wishing to obtain an amateur operator license, other than a novice class license, must appear before an FCC examiner to demonstrate his qualifications. FCC amateur examinations are given on a regularly scheduled basis at each of the Commission's 28 field offices and at approximately 70 other locations throughout the country. An applicant for an amateur operator license appearing at a designated Commission examination point undertakes the telegraphy examina-

tion in a room with other (often many other) applicants. The Commission examiner plays a tape recording of a telegraphy text transmitted at an audio frequency of approximately 750 Hertz. At the conclusion of the transmission of the telegraphy text, the applicant is given a multiple choice written examination concerning the text just transmitted. If the applicant answers 80 percent of the questions correctly, he or she is given another examination covering amateur rules, principles, and procedures. If the applicant scores at least 74 percent on that examination, he or she is issued an amateur operator license.

The Commission recognizes that there are some persons who may be able to receive telegraphy but who are unable, because of a handicap, to demonstrate their qualifications in the context of a typical FCC examination environment. For example, certain persons cannot leave their homes to travel to Commission examination points. Others may be able to travel but may not be able to use their hands to write. Still others may not be able to hear the telegraphy text transmitted or read the written questions presented.

The Commission believes that it has a duty to assist handicapped applicants unable to demonstrate their telegraphy qualifications according to normal procedure to do so in other ways. To this end, the Commission has taken a number of actions to help handicapped applicants. Section 97.27 of the rules, for example, states that if an applicant is shown by physicians' certification to be the victim of a protracted disability preventing travel, he or she may be examined at home by an examiner selected by the Commission. Moreover, the Commission's Field Operations Bureau has instructed Commission field personnel to make special arrangements for the examination of the handicapped. Among the procedures routinely followed in administering examinations to the handicapped are the following:

If an applicant is unable to write, he or she may dictate his or her responses orally for transcription, or he or she may use a typewriter.

An applicant may "repeat back" his or her telegraphy copy if he or she cannot write.

A blind applicant may use a Braille printer on the telegraphy examination and dictate his or her copy.

Written questions may be read to blind or paralyzed applicants.

Severely handicapped applicants may be examined at their bedsides either by Commission personnel or by other qualified persons selected by the Commission.

Blind applicants may be given examinations prepared by the Commission in Braille.

Continued on page 206

FREQUENCY STANDARD

PROVIDES STRONG, PRECISE MARKERS EVERY 1 MHz, 500, 250, 100, 50, 25, 10, 5, 2.5, 1 KHz, 500, 250, 100, 50, 25 Hz WELL INTO THE VHF RANGE.

- ★ USE AS MARKER GENERATOR FOR HAM RECEIVERS
- ★ OSCILLOSCOPE TIME BASE CALIBRATOR
- ★ C-MOS IC CONSTRUCTION
- ★ POWER REQUIREMENTS
6.5 V to 15 V at 15 ma.
(9 V Radio Battery excellent)
- ★ ZERO TO WWV



COMPLETELY ASSEMBLED IN CABINET

See July 78 73 page 146 for more information.

\$39.95

Please Add Postage

WIRED PC BOARD

\$24.95

Board Size 3 1/4" x 2 1/2"

EDGE CONNECTOR INCLUDED

RAINBOW INDUSTRIES

P. O. BOX 2366 INDIANAPOLIS, IND. 46206

NEW!

\$36.50

plus \$1.50 s/h
NY res. add tax



FEATURES: CMOS ELECTRONIC KEYS

- State-of-the-art CMOS circuitry
- Self completing dots and dashes
- Dot and dash memory
- Iambic keying with any squeeze paddle
- 5-50 WPM
- Speed, volume, tone controls, side tone and speaker
- Low current drain CMOS-battery operation
- Deluxe quarter-inch jacks for keying and output
- Handsome eggshell white base—woodgrain top
- Compact and portable—1-7/8 x 4-1/4 x 6-1/4
- Grid block keying
- Wired and tested—fully guaranteed—less battery

BRAND NEW!

\$25.95

plus \$2.00 s/h
NY res. add tax



FEATURES:

- Twin paddle squeeze key
- Extra heavy base—non skid feet
- Adjustable contact spacing
- Touch tension—comfort keying
- Smooth friction free paddle movement
- Handsome crinkle finish base and rich red paddles
- Five way binding posts
- Use with TRAC CMOS keyer or any keyer

TRAC-KEY

TRAC

ELECTRONICS, INC
1106 RAND BLDG.
BUFFALO NY 14203

✓ T18

Choosy People LOVE Standard!



Standard Communications offers you a choice of 2 meter handheld radios in either the pocket sized C-118 or the professional sized 146A.

Why Buy The C-118?

- Compact — can be slipped in pocket or purse
- 6 channels but affords 18 channels transmit with unique offset switch which produces transmit offset of ± 600 kHz
- Requires only one crystal for each channel
- BNC antenna connector
- Rubber flex antenna at no additional charge
- LED status lights indicate channel busy and RF output
- 1+ Watts output

Why Buy The 146A?

- More room means larger battery capacity
- Larger case affords greater audio fidelity
- Room for tone options
- Provisions for remote speaker mic
- Full size telescoping antenna is standard feature
- 5 channels
- Meter for RF and signal strength
- 2+ Watts output

Both the C-118 and 146A...

- ... Are ready to operate on 146.94 simplex and 34/94 repeat
- ... Have excellent sensitivity and selectivity characteristics

 **Standard
Communications**

member:



Attn: Advertising Manager
Standard Communications Corp.
P.O. Box 92151
Los Angeles, CA 90009

✓ S18

Gentlemen:

Please send me additional information on

- C-118 2 meter 1 Watt FM Handheld Radio
 146-A 2 Watt VHF Handheld Radio

Name _____

Address _____

City _____ State _____ Zip _____

C

Nov - 1978

✓ Reader Service—see page 323.

The Multifunction Scan Can

— another IC-22S goodie

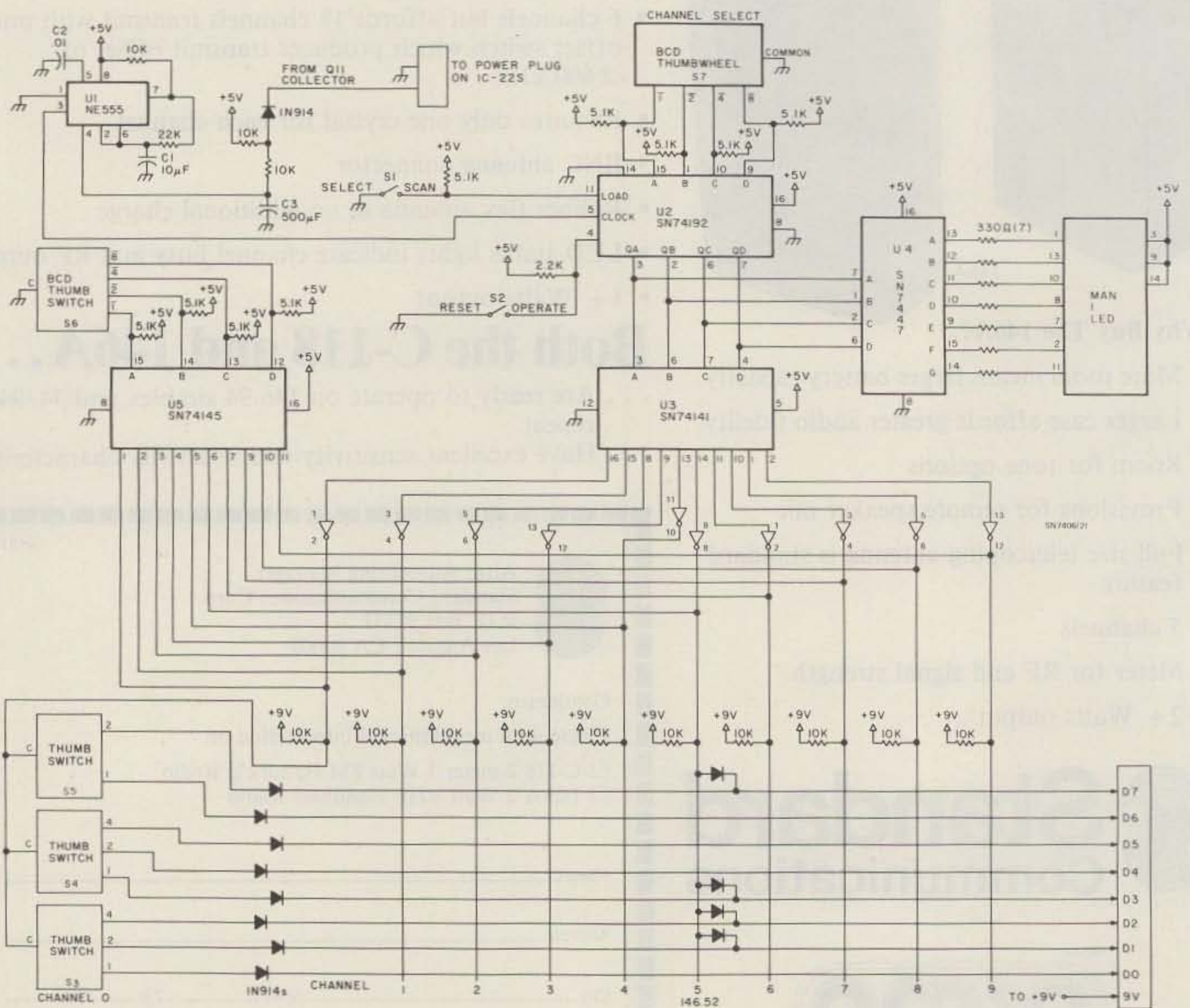

Fig. 1. The schematic diagram for the multifunction scanner. Channel 5 of the diode matrix is programmed for 146.52 for illustration.

S. E. Holzman W1IBI
 J. D. Adamson W1HZH
 RFD 3, Honey Brook Lane
 Amherst NH 03031

The "multifunction scan can" is a simple device that will increase the operational flexibility and pleasure of owning an IC-22S. The circuit described in this article will convert the IC-22S into a versatile ten-channel scanner that provides:

- Nine preprogrammed channels plus 1 tunable channel that can select any valid frequency
- Blanking for any one of 9 channels
- Fixed selection of any channel
- Seven-segment LED numerical indication of channel
- Thumbwheel selection of variable channel, blanked channel, and fixed channel selection

The scanner automatically stops on a channel the instant that the squelch breaks, and resumes scanning approximately 2 seconds after the carrier disappears, if another signal does not again break the squelch. The LED readout indicates which channel, 0 through 9, is being monitored. Should a fixed channel be desired, that mode is easily selectable. Operation in channel 0 allows the transceiver frequency to be selected by a set of thumbwheel switches. Any valid IC-22S frequency can be dialed up, making this a very valuable feature. For simplicity, a lookup table, Table 1, is used for frequency identification when selecting channels with the octal thumbwheel set. If, while scanning, it is desired to skip some channel, the blanking thumbwheel is set to that channel

number and the channel is totally ignored.

Circuit Description

The scanner is illustrated schematically in Fig. 1. It interfaces to the IC-22S through the transceiver's 9-pin accessory socket (J5) and the 4-pin power plug. The simple transceiver modifications will be described in detail later.

The scanner consists of seven ICs, five thumbwheel switches, and a seven-segment LED readout. For those who desire a kit approach, a drilled PC board is available from the authors.*

The heart of the system is an SN74192 (U2) programmable decade counter that is driven by a 555 (U1) clock gated by the IC-22S squelch signal. The clock circuitry is set up to allow the 74192 to count (scan) at a rate of approximately one second per channel. When a signal is present, the squelch line from the IC-22S drops low, inhibiting the clock signal to the counter (U2). The scanner thus dwells on that frequency. When the squelch line goes high, the enable line of the clock (U1) is slowly charged up to 5 V through R3 + R4 and C3, thus allowing the 74192 to resume counting. The time delay, resulting from C3 charging through R3 and R4, prevents the scanner from taking off between transmissions, but allows the scan to continue if the channel becomes

*A drilled, plated board with documentation is available from the authors ready for assembly for only \$10.50 including postage.

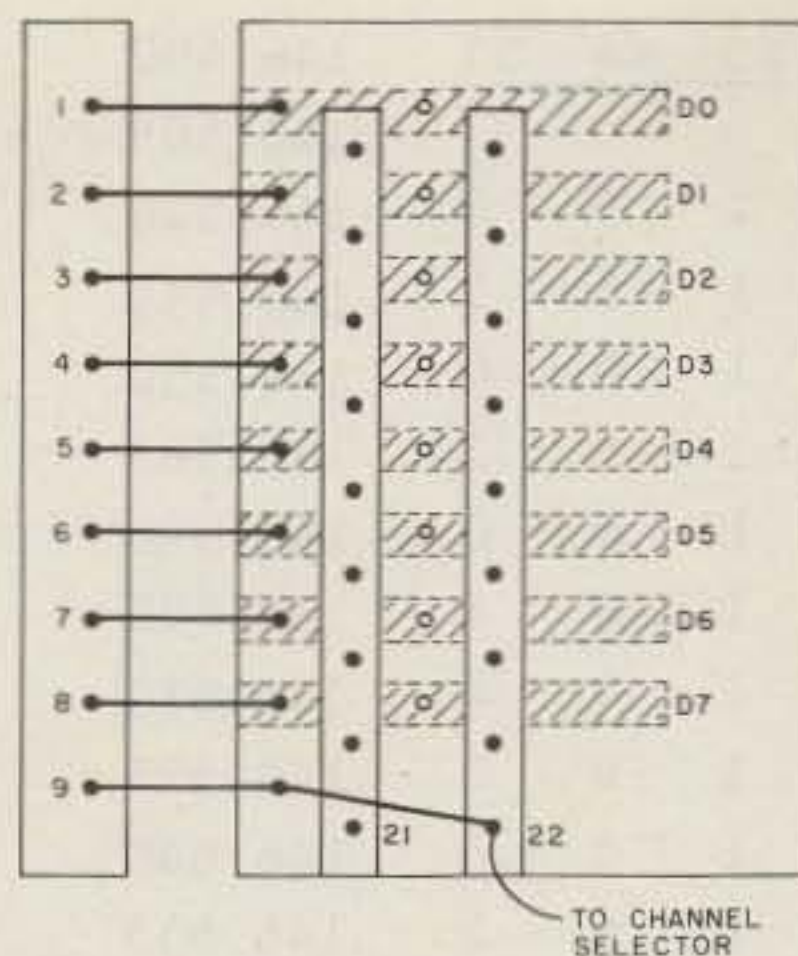

Fig. 2. The required wiring modification for the remote programming of the IC-22S through the accessory socket J5.

quiet. The reset switch will override this function and force the scanner to continue in the middle of a transmission if desired.

The fixed "channel select" function is derived by forcing the 74192 (U2) into its load mode by grounding pin 11 and addressing the desired channel, 0 through 9, with the "Channel Select" thumbwheel. In this mode, the counter's output is simply the channel addressed, for it cannot scan.

The output from the 74192 counter drives a 74141 (U3) BCD-to-decimal decoder that addresses the channel matrix and an SN7447 (U4) that drives the LED channel indicator. The output of the SN74141 is ORed with the SN74145 (U5) output, which allows the blanking of any channel, 1 through 9, as selected by the "Blank Channel" thumbwheel.

The channel matrix makes use of diodes for the programming of channels 1

through 9 just the same as the IC-22S does normally. The diode code is given in the IC-22S manual, pages 22 through 24. Channel 0, however, connects a set of thumbwheel switches to the address lines, allowing any valid frequency code to be dialed up at the flick of the switch. This feature alone is extremely useful. The actual frequency is obtained by using the conversion chart given in Table 1. The chart approach was used here because of its simplicity and savings in circuitry over a direct readout system.

IC-22S Modification

Some simple modifications must be made to the IC-22S to interface the scanner and transceiver together. The modifications are not difficult; however, care should be exercised to prevent damage to the unit and to ensure good workmanship.

The first step is to open up the IC-22S and locate

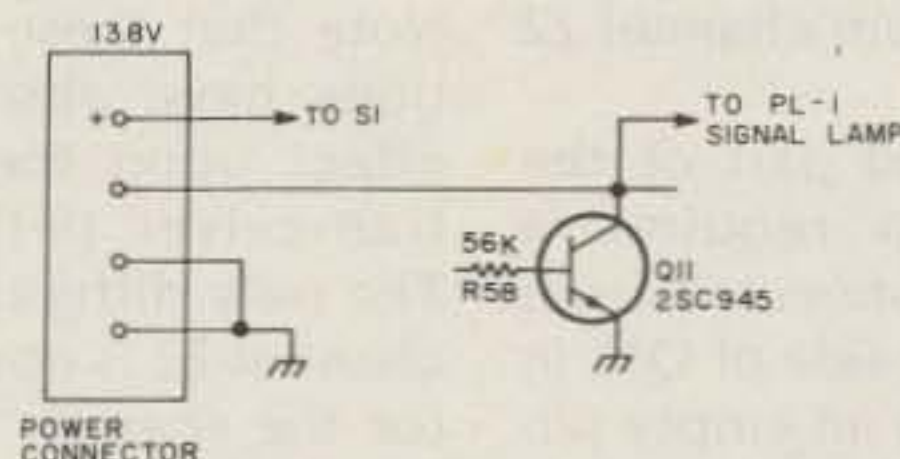

Fig. 3. The squelch line connection, illustrated schematically, between Q11 and the vacant pins on the power input plug.

| FREQUENCY | S5 | S4 | S3 | 146.490 | 2 | 1 | 4 | 147.000 | 2 | 5 | 6 | 147.510 | 3 | 2 | 0 |
|-----------|----|----|----|---------|---|---|---|---------|---|---|---|---------|---|---|---|
| | | | | 146.505 | 2 | 1 | 5 | 147.015 | 2 | 5 | 7 | 147.525 | 3 | 2 | 1 |
| 146.010 | 1 | 5 | 4 | 146.520 | 2 | 1 | 6 | 147.030 | 2 | 6 | 0 | 147.540 | 3 | 2 | 2 |
| 146.025 | 1 | 5 | 5 | 146.535 | 2 | 1 | 7 | 147.045 | 2 | 6 | 1 | 147.555 | 3 | 2 | 3 |
| 146.040 | 1 | 5 | 6 | 146.550 | 2 | 2 | 0 | 147.060 | 2 | 6 | 2 | 147.570 | 3 | 2 | 4 |
| 146.055 | 1 | 5 | 7 | 146.565 | 2 | 2 | 1 | 147.075 | 2 | 6 | 3 | 147.585 | 3 | 2 | 5 |
| 146.070 | 1 | 6 | 0 | 146.580 | 2 | 2 | 2 | 147.090 | 2 | 6 | 4 | 147.600 | 3 | 2 | 6 |
| 146.085 | 1 | 6 | 1 | 146.595 | 2 | 2 | 3 | 147.105 | 2 | 6 | 5 | 147.615 | 3 | 2 | 7 |
| 146.100 | 1 | 6 | 2 | 146.610 | 2 | 2 | 4 | 147.120 | 2 | 6 | 6 | 147.630 | 3 | 3 | 0 |
| 146.115 | 1 | 6 | 3 | 146.625 | 2 | 2 | 5 | 147.135 | 2 | 6 | 7 | 147.645 | 3 | 3 | 1 |
| 146.130 | 1 | 6 | 4 | 146.640 | 2 | 2 | 6 | 147.150 | 2 | 7 | 0 | 147.660 | 3 | 3 | 2 |
| 146.145 | 1 | 6 | 5 | 146.655 | 2 | 2 | 7 | 147.165 | 2 | 7 | 1 | 147.675 | 3 | 3 | 3 |
| 146.160 | 1 | 6 | 6 | 146.670 | 2 | 3 | 0 | 147.180 | 2 | 7 | 2 | 147.690 | 3 | 3 | 4 |
| 147.175 | 1 | 6 | 7 | 146.685 | 2 | 3 | 1 | 147.195 | 2 | 7 | 3 | 147.705 | 3 | 3 | 5 |
| 146.190 | 1 | 7 | 0 | 146.700 | 2 | 3 | 2 | 147.210 | 2 | 7 | 4 | 147.720 | 3 | 3 | 6 |
| 146.205 | 1 | 7 | 1 | 146.715 | 2 | 3 | 3 | 147.225 | 2 | 7 | 5 | 147.735 | 3 | 3 | 7 |
| 146.220 | 1 | 7 | 2 | 146.730 | 2 | 3 | 4 | 147.240 | 2 | 7 | 6 | 147.750 | 3 | 4 | 0 |
| 146.235 | 1 | 7 | 3 | 146.745 | 2 | 3 | 5 | 147.255 | 2 | 7 | 7 | 147.765 | 3 | 4 | 1 |
| 146.250 | 1 | 7 | 4 | 146.760 | 2 | 3 | 6 | 147.270 | 3 | 0 | 0 | 147.780 | 3 | 4 | 2 |
| 146.265 | 1 | 7 | 5 | 146.775 | 2 | 3 | 7 | 147.285 | 3 | 0 | 1 | 147.795 | 3 | 4 | 3 |
| 146.280 | 1 | 7 | 6 | 146.790 | 2 | 4 | 0 | 147.300 | 3 | 0 | 2 | 147.810 | 3 | 4 | 4 |
| 146.295 | 1 | 7 | 7 | 146.805 | 2 | 4 | 1 | 147.315 | 3 | 0 | 3 | 147.825 | 3 | 4 | 5 |
| 146.310 | 2 | 0 | 0 | 146.820 | 2 | 4 | 2 | 147.330 | 3 | 0 | 4 | 147.840 | 3 | 4 | 6 |
| 146.325 | 2 | 0 | 1 | 146.835 | 2 | 4 | 3 | 147.345 | 3 | 0 | 5 | 147.855 | 3 | 4 | 7 |
| 146.340 | 2 | 0 | 2 | 146.850 | 2 | 4 | 4 | 147.360 | 3 | 0 | 6 | 147.870 | 3 | 5 | 0 |
| 146.355 | 2 | 0 | 3 | 146.865 | 2 | 4 | 5 | 147.375 | 3 | 0 | 7 | 147.885 | 3 | 5 | 1 |
| 146.370 | 2 | 0 | 4 | 146.880 | 2 | 4 | 6 | 147.390 | 3 | 1 | 0 | 147.900 | 3 | 5 | 2 |
| 146.385 | 2 | 0 | 5 | 146.895 | 2 | 4 | 7 | 147.405 | 3 | 1 | 1 | 147.915 | 3 | 5 | 3 |
| 146.400 | 2 | 0 | 6 | 146.910 | 2 | 5 | 0 | 147.420 | 3 | 1 | 2 | 147.930 | 3 | 5 | 4 |
| 146.415 | 2 | 0 | 7 | 146.925 | 2 | 5 | 1 | 147.435 | 3 | 1 | 3 | 147.945 | 3 | 5 | 5 |
| 146.430 | 2 | 1 | 0 | 146.940 | 2 | 5 | 2 | 147.450 | 3 | 1 | 4 | 147.960 | 3 | 5 | 6 |
| 146.445 | 2 | 1 | 1 | 146.955 | 2 | 5 | 3 | 147.465 | 3 | 1 | 5 | 147.975 | 3 | 5 | 7 |
| 146.460 | 2 | 1 | 2 | 146.970 | 2 | 5 | 4 | 147.480 | 3 | 1 | 6 | 147.990 | 3 | 6 | 0 |
| 146.475 | 2 | 1 | 3 | 146.985 | 2 | 5 | 5 | 147.495 | 3 | 1 | 7 | | | | |

Table 1. Frequency conversion.

the nine-pin accessory plug, J5. Remove the wire attached to pin 1, tape it over, and store it out of the way. As shown in Fig. 2, connect wires from channel 22 of the diode matrix to the 9-pin plug, starting with D0 to pin 1 and ending with D7 on pin 8 and the 9-volt line from channel 22 to pin 9.

The second part of the modification requires a wire to be connected from the collector side of Q11 in the IC-22S to an empty pin on the power plug as shown in Fig. 3. This is the squelch line that drops low when the squelch is

broken. The remaining empty terminal on the power plug should be tied to ground and used to carry ground to the scanner.

After very carefully checking for accuracy and for workmanship, the IC-22S can be reassembled. Note that these modifications have absolutely no effect upon the barefoot transceiver performance. The only difference is that channel 22 is now reserved for the scanner when it is plugged in.

The only remaining task is the fabrication of the wiring harness to tie the

two units together. Use the pin 9 accessory plug and the power plug provided.

Operation

Using the scanner is straightforward. In the scan mode, the scanner will switch through the programmed channels, stopping whenever activity is present and starting up again when activity terminates. If you want to start scanning when the scan is locked on a station, push the "Reset" switch; should you wish to bypass a busy channel, dial it up with the "Blank" switch. To monitor a programmed

channel, switch the mode switch to "Select" and address the desired channel with the "Channel Select" switch. The LED display will confirm the channel. By selecting channel 0 and using the conversion table in Table 1, any valid IC-22S frequency can be dialed up, thus eliminating the need to program any of the other 21 transceiver channels.

The multifunction scan can will add utility to the IC-22S transceiver for a very minimal cost and will provide performance that is impossible to match elsewhere. ■



Pictured with optional HD-1984 Micoder II™

The HEATHKIT HW-2036A

...just that much better!

We'll give it to you straight! The HW-2036 was a great 2-meter transceiver — but our new HW-2036A is just that much better.

It boasts the same impressive specifications, but now gives you a full 4 MHz of coverage over any portion of its 143.5 to 148.5 MHz operating range.

But most startling of all is the price tag. At \$269.95* in easy-to-build kit form, the HW-2036A is the lowest priced, synthesized 2-meter transceiver you'll find anywhere!

At Heath we're holding down the soaring cost of Amateur Radio. Look over our entire line of quality kit products. Then join the thousands of Radio Amateurs who've taken the sensible alternative — and built Heath!

Heath Amateur Radio Gear...
...the quality that measures up!

Send for your FREE Heathkit Catalog today!

Or you may obtain a catalog by bringing this coupon to one of the 50 Heathkit Electronic Centers coast-to-coast (units of Schlumberger Products Corp.) where Heathkit products are displayed, sold and serviced. Retail prices on some products may be slightly higher. See the white pages of your telephone directory.
 Heath Company, Dept. 011-470,
 Benton Harbor MI 49022



| | | |
|---|--|--|
| HEATH Schlumberger | Heath Company Dept. 011-470 Benton Harbor MI 49022 | <input checked="" type="checkbox"/> H5 |
| Please send me my FREE Catalog. I am not on your mailing list. | | |
| Name _____ | | |
| Address _____ | | |
| City _____ | | State _____ |
| * Price is mail order, F.O.B. Benton Harbor, MI. Prices and specifications subject to change without notice. | | Zip _____ |
| | | AM-366A |

SWR Power Meters



COMBINATION SWR/FIELD STRENGTH METER
Measures SWR up to 3:1, or higher. Meter has sensitive movement and easy-reading two-color scale. 5% accuracy. 52 ohms impedance. SO-239 female coaxial connectors. 6" high x 2" wide x 2 3/4" deep. Model SWR-A **\$14.95**

MINI SWR METER

Small size makes this the perfect mobile or portable meter. Sensitive meter with easy-to-read two-color scale. Metal case 1-5/8" x 2-1/8" x 2-1/8". Model SWR-B **\$12.95**

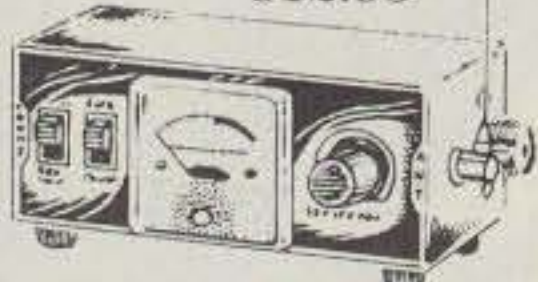

POWER/SWR/F.S. METER
Measures SWR and power on 0-10 and 0-100 watt ranges. Good up to 225 MHz for SWR function, up to 148 MHz for power functions. Accuracy: 5% on SWR, 10% on power functions. 2" x 4 3/4" x 2 1/4". Model SWR-C **\$26.95**



DUAL METER SWR BRIDGE
Shows output power and reflected power simultaneously. Can be used as reference power meter, too. Wide scale, easy-to-read meter faces. Dual meters make antenna tuner adjustments a snap. Good through 175 MHz. May be left in-line up to 2,000 watts. Model SWR-D **\$29.95**

POWER SUPPLY

Laboratory grade 12V 10 amps continuous, 15 amps intermittent. Output regulation: .02%. Ripple: less than .5 mv. Overtemperature, overcurrent, and overvoltage protected. 16 lbs. 0-71°C. Special purchase at fraction of regular price. Additional information on request. Model PS-1 **\$94.00**

SST T-1 RANDOM WIRE ANTENNA TUNER

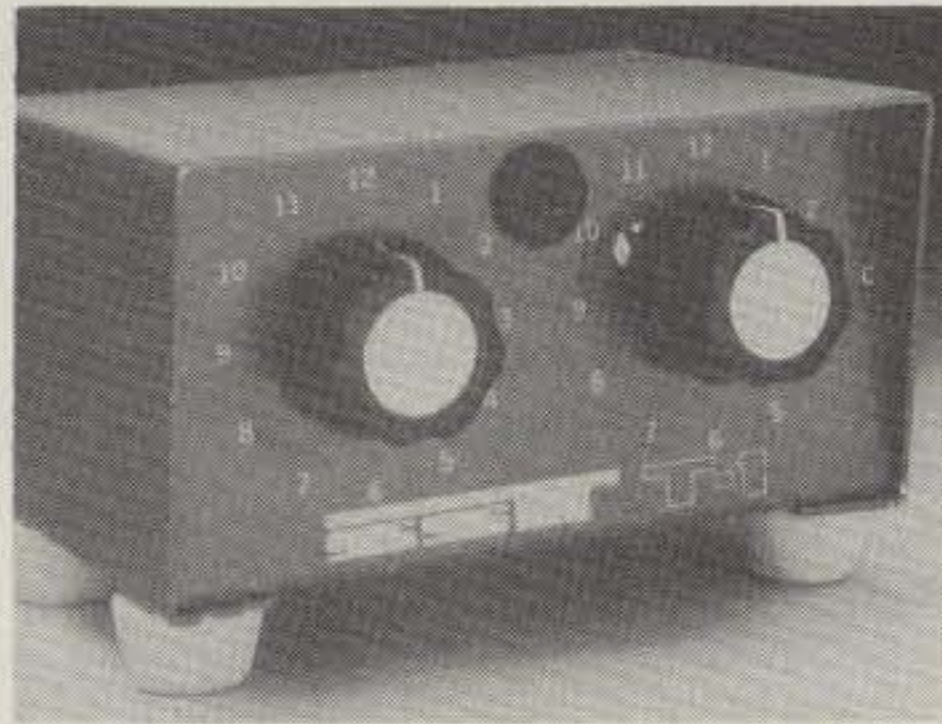

**ONLY
\$29.95**

All band operation (160-10 meters) with any random length of wire. 200 watt output power capability—will work with virtually any transceiver. Ideal for portable or home operation. Great for apartments and hotel rooms—simply run a wire inside, out a window, or anyplace available. Efficient toroid inductor for small size: 4-1/4" x 2-3/8" x 3", and negligible loss. Built-in neon tune-up indicator. SO-239 connector. Attractive bronze finished enclosure.

The Original Random Wire Antenna Tuner... in use by amateurs for 7 years.

SST T-3 MOBILE IMPEDANCE TRANSFORMER

**ONLY
\$19.95**

Matches 52 ohm coax to the lower impedance of a mobile whip or vertical. 12-position switch with taps spread between 3 and 50 ohms. Broadband from 1-30 MHz. Will work with virtually any transceiver—300 watt output power capability. SO-239 connectors. Toroid inductor for small size: 2-3/4" x 2" x 2-1/4". Attractive bronze finish.

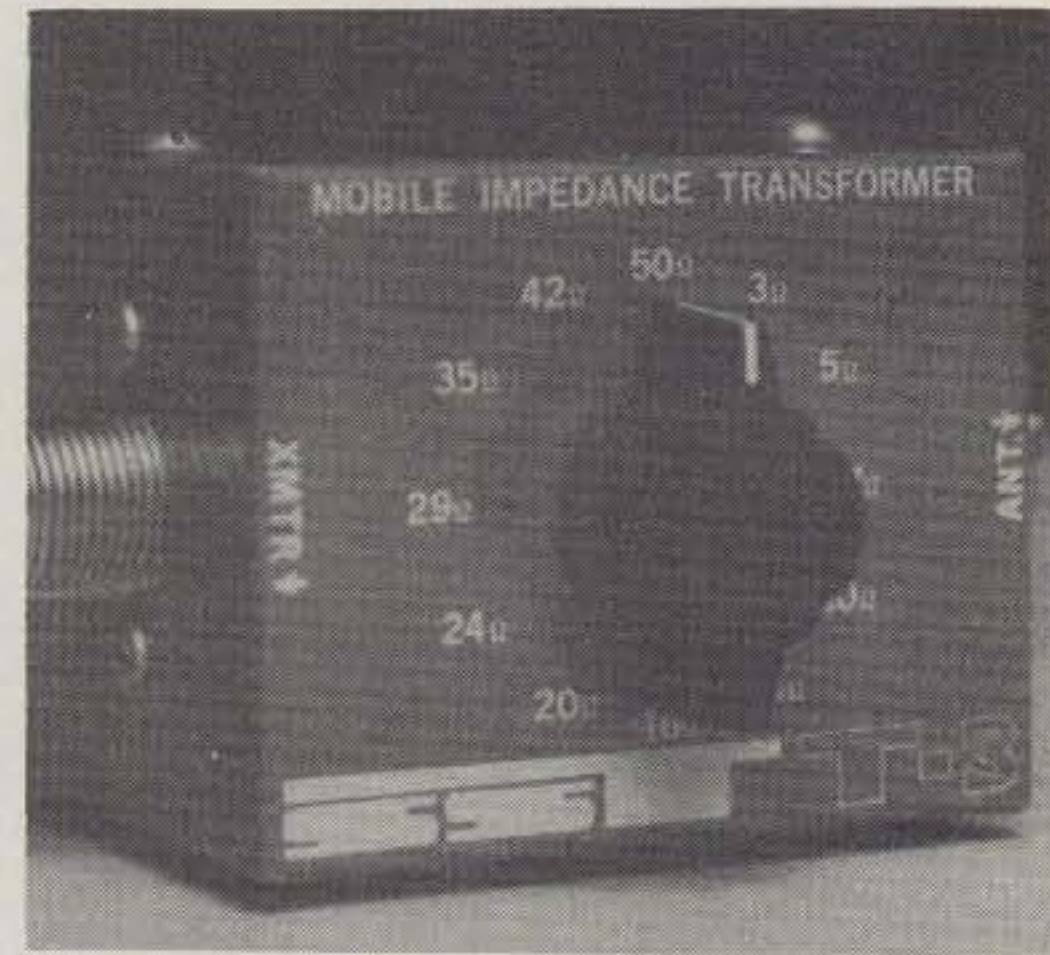

SST A-1 VHF AMPLIFIER KIT ONLY

\$29.95 849.95 wired and tested.

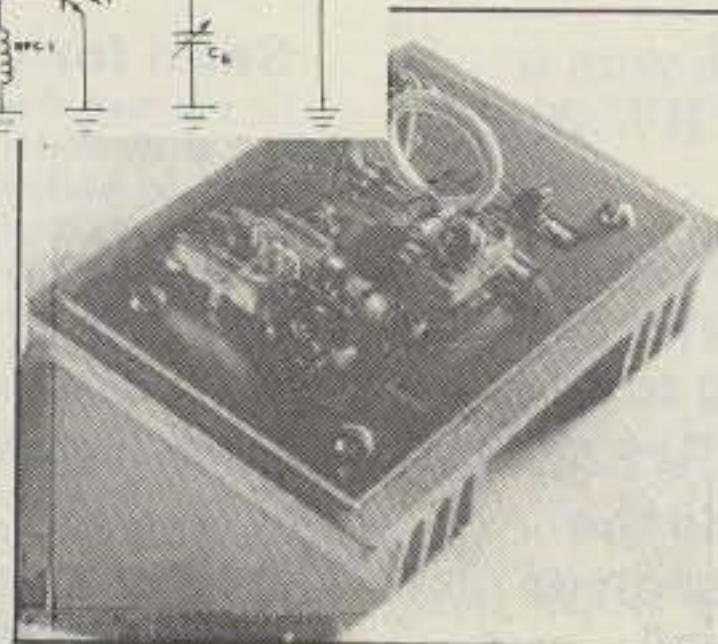
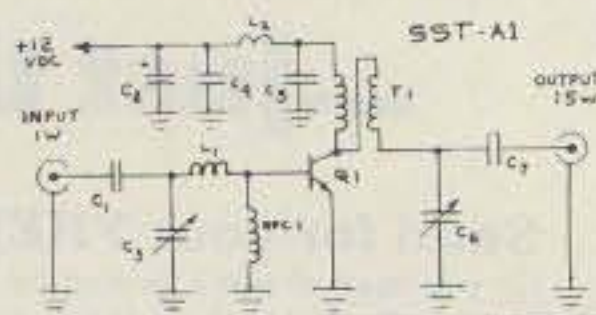

1 watt input gives you 15 watts output across the entire 2 meter band without re-tuning. This easy-to-build kit (approx. 1/2 hr. assembly) includes everything you need for a complete amplifier. All top quality components. Compatible with all 1-3 watt 2-meter transceivers. Short and open protected—not damaged by high SWR.

Kit includes:

- Etched and drilled G-10 epoxy solder plated board.
- Heat sink and mounting hardware. All components—including pre-wound coils. Less case.
- Top quality TRW RF power transistor.
- Complete assembly instructions with details on a carrier operated T/R switch. (COR switch parts \$10 ppd.).

SST

ELECTRONICS
P.O. BOX 1 LAWDALE, CALIF.
90260 (213) 376-5887

✓S10

SST T-2 ULTRA TUNER

The SST T-2 Ultra Tuner has become the standard tuner the world over. The original SST concept of offering compact antenna tuners with maximum versatility began seven years ago with the production of the first SST tuner. No one has matched the SST line for years of dependable operation, quality, and value. The top-of-the-line SST T-2 Ultra Tuner is the standard—at any price.

**ONLY
\$39.95**

THE STANDARD TUNER

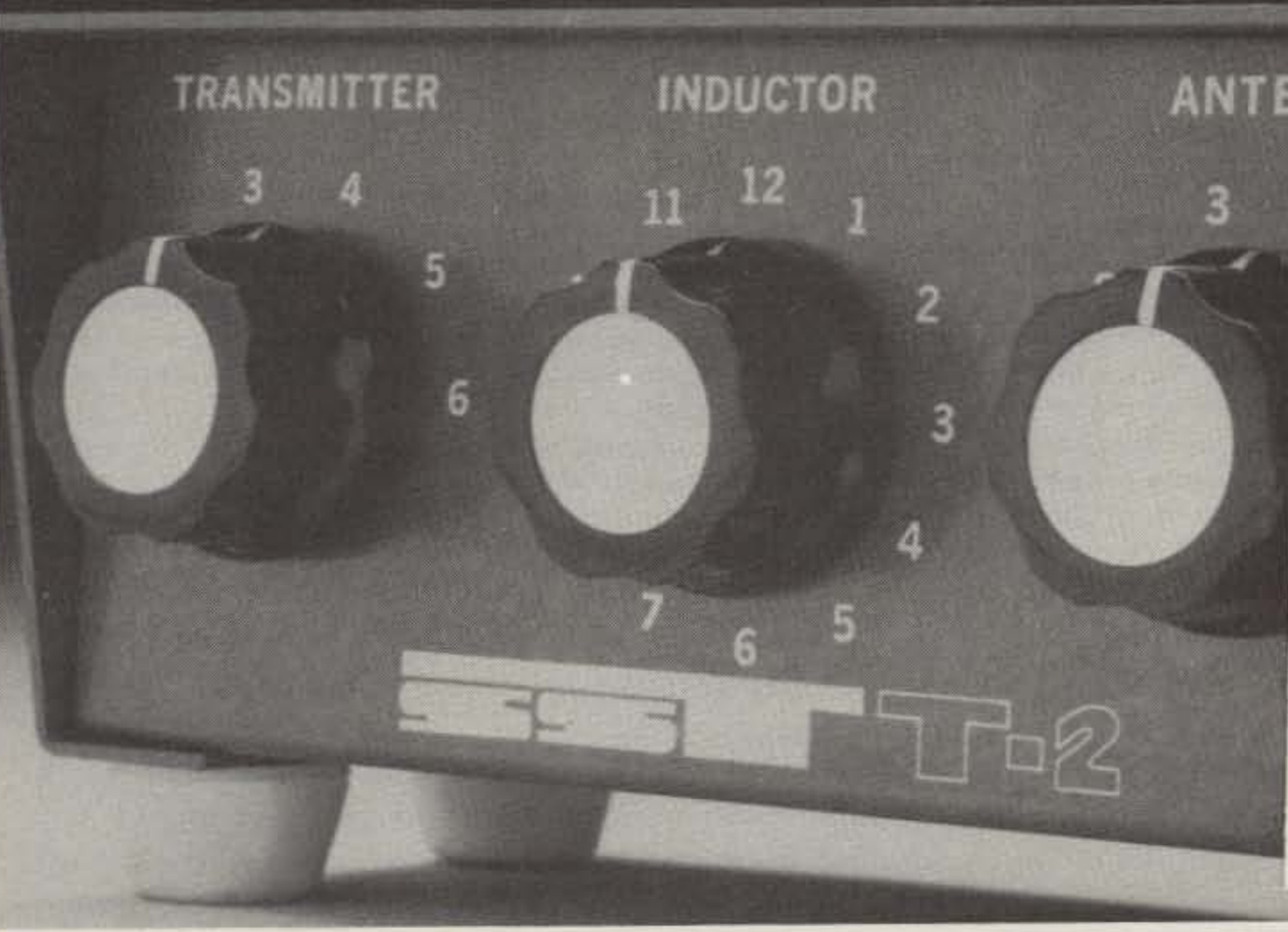

CHECK THESE FEATURES:

- Tunes out SWR on any coax fed antenna as well as random wires. Works great on all bands (80-10 meters) with any transceiver running up to 200 watts power output.
- Increases usable bandwidth of any antenna. Tunes out SWR on mobile whips from inside your car.
- Uses efficient toroid inductor and specially made capacitors for small size: 5¼" x 2¼" x 2½". Rugged, yet compact. Negligible line loss. Attractive bronze finished enclosure. SO-239 coax connectors are used for transmitter input and coax fed antennas. Convenient binding posts are provided for random wire and ground connections.

TO ORDER:

not available from your dealer, order direct by mail or phone. Please add \$2 for shipping and handling (\$5 for Airmail worldwide). Calif. residents, please add sales tax. COD, Master Charge, and VISA orders accepted.

GUARANTEE:

All SST products are guaranteed for 1 year. In addition, they may be returned within 10 days for a full refund (less shipping) if you are not satisfied for any reason.

CALL (213) 376-5887 OR 379-9572 TO ORDER C.O.D., VISA OR MASTER CHARGE

OR SEND TO: SST ELECTRONICS, P.O. BOX 1, LAWNSDALE, CALIF. 90260

NAME _____
 STREET _____
 CITY _____ STATE ____ ZIP _____
 MODELS DESIRED: TOTAL ENCLOSED \$ _____

OR CHARGE TO: VISA M.C. C.O.D.
 CARD # _____ EXP. DATE _____

WE ACCEPT



Be A Weather Genius

— eavesdrop on GOES

Author's note: As this article goes to press, some new developments bear mentioning:

1. The amateur price schedule is current but the commercial schedule is not. Contact Microcomm (SASE, please) for current prices and specifications. Paul is also working on implementing the converter with a smaller number of boards, so you should get on the mailing list.
2. The mounting arrangement in Fig. 2 is no accident. The modules should not be mounted directly to the metal panel, as undesirable coupling and detuning will occur. In the case of the prototype system, the modules are mounted to a G-10 glass baseplate (PC stock with no copper), using standoffs. This plate is then mounted on the panel using a second set of standoffs. Another simple but effective approach is to mount the converters from below using a 3" chassis. Cutouts on the chassis will permit clearance for the connectors and feedthrough caps, while allowing the ground plane board surface to mate with the chassis using the corner mounting holes and machine screws and nuts.
3. The European version of GOES (METEOSAT) is now up over the Greenwich Meridian and functioning well in providing WEFAX to western Europe. The Japanese have successfully implemented their satellite over the western Pacific, and an unused U.S. GOES spacecraft is being moved over the Indian Ocean until the U.S.S.R. makes progress with its program. For detailed information on any of these developments, contact: Coordinator for Direct Readout Services, S122, NOAA/NESS, U.S. Department of Commerce, Washington DC 20233.

Ralph E. Taggart WB8DQT
602 S. Jefferson
Mason MI 48854

In an earlier review article in 73,² I outlined some of the problems facing amateurs wishing to use the new GOES (geostationary operational environmental satellite) system. The GOES satellite program is an outgrowth of experiments with the ATS (applications technology satellite) spacecraft. The ATS satellites are located in geostationary orbits and have been used to generate moder-

ately high resolution pictures of the Earth disc and for hemisphere-wide relay of these pictures and other meteorological data as part of the WEFAX (weather facsimile) program.

The ATS satellites transmit on a frequency of 135.6 MHz, which makes it relatively easy to set up receiving equipment. Since the satellites are in geostationary orbits (located over the equator at an altitude of approximately 22,300 miles), the spacecraft need not be tracked — the antenna is simply aligned permanently on the satellite of interest.

This, coupled with the fact that the ATS satellites transmit on a regular schedule, made the WEFAX program quite popular with satellite buffs, despite some problems with the system. The 135.6 MHz frequency is also used for air traffic control, resulting in severe aircraft interference in some locations, and Faraday rotation is severe at this frequency, resulting in pronounced polarization shifts as the signal travels from the satellite to the ground station. When word was relayed from the Satellite Service that the experimental ATS satellites would not be replaced when they eventually failed, the news was not greeted with enthusiasm.

The WEFAX program would be continued, however — even expanded greatly — in conjunction with the new GOES satellite program. The reason for the concern was that the new GOES transmissions would be made at a frequency of 1691 MHz — hardly a frequency conducive to throwing together a quick receiving system. An NOAA technical memoran-

dum¹ attempted to provide some guidance for setting up a suitable downconverter, and, although it was a budget system by government standards, it involved the use of a 10-foot parabolic antenna and approximately \$3500 worth of hardware — far more than most stations have invested in an entire ground station. Equally discouraging was that this system did not have a large performance margin, indicating little latitude for substitution of system elements or cost paring.

In my review article, I suggested that the talents of radio amateurs involved in microwave work might well be applied to the design of a cost-effective S-band downconverter for GOES use. Although there were times when the picture looked pretty dim, that initial optimism has proven to be justified, and there are now several routes to GOES reception that the average satellite enthusiast can afford.

Before I discuss those options, I should briefly discuss the rf and video characteristics involved with

| | |
|------------------------------|-----------------------|
| Operating frequency | 1691.0 MHz |
| Modulation | FM |
| Deviation | ± 9 kHz |
| Ground signal level | -134 dBm |
| Video mode | APT |
| Video subcarrier | 2400 Hz |
| Video modulation | AM |
| Black level | minimum (4%) |
| White level | maximum (90%) |
| Line rate | 4 Hz (240 lines/min.) |
| Frame rate | 200 seconds |
| Number of lines | 800 |
| Video bandwidth | 1600 Hz |
| Aspect ratio | 1:1 |
| Direction of horizontal scan | left to right |
| Direction of vertical scan | top to bottom |

Table 1. Rf and video format data for GOES WEFAX operations.

GOES WEFAX transmissions. These are summarized in Table 1. The actual video transmissions are in the APT video mode, so any display system (CRT or FAX) that is compatible with the mode may be used to display the pictures. In the review article, I summarized some of these, while other options are considered in the *Weather Satellite Handbook*,³ available from 73, Inc. The APT pictures are transmitted on FM with a nominal deviation of ± 9 kHz. This is precisely the same signal format that was used for ATS and ESSA satellite transmissions so that any of the basic satellite receivers may be used with success as an i-f system. Options in this department are covered in a number of my previous publications.^{2,3,4}

In fact, then, what is required to get into the GOES satellite business is a suitable antenna and S-band down-converter working into the regular satellite receiver. Suitable i-f frequencies would involve one of the channels presently used for VHF satellite operations — 135.6 MHz (ATS), 137.5 MHz (primary NOAA), or 137.62 MHz (old ESSA frequency and backup NOAA). Let's look at some converter options and then determine the antenna requirements.

One possible approach is the home construction of the complete converter system. John Yurek K3PGP, who is very active in EME at 432, 1296, and 2304 MHz, has developed a number of interesting approaches to S-band converter design, including a complete receiver system that is far easier to align than most two meter systems. I have tried many of John's ideas, and they work like a charm. John will be preparing some articles on his system shortly, so I won't steal any of his thunder. If you are interested in home construction of the S-band front end, then contact John or await his articles — you can't go wrong.

Most satellite buffs feel

that they lack the experience or instrumentation to attempt a microwave construction project. What is needed for these individuals is a proven cost-effective commercial package that will put them on 1691 MHz without breaking the bank. The answer to this requirement has come about through the efforts of another amateur, Paul Shuch WA6UAM. Paul is a microstripline designer engineer who has published an extensive series of microstripline designs in *Ham Radio* magazine. Paul started his own company (Microcomm, 14908 Sandy Lane, San Jose CA 95124) to provide inexpensive microstripline modules for 432, 1296, and 2304 MHz operations. Recently, Paul has gotten into the GOES business, marketing a complete line of modules that make it possible to assemble a quality down-converter at reasonable cost. Fig. 1 shows a block diagram of the Microcomm down-converter, while the converter itself is illustrated in Fig. 2.

Basically, the system employs two rf stages, each rated at 12 dB gain with an NF of 3 dB. Bandpass filters are employed between the two amplifiers and between the second rf amp and mixer to provide overload protection from microwave operations such as radar and to improve the noise figure of the system. The mixer is a single balanced type with a conversion loss of 7.5 dB and 25 dB of image rejection with a 135-138 MHz i-f. The local oscillator chain features a precision 518 MHz signal

source, a diode tripler to 1555 MHz, an active amplifier, and a 1555 MHz bandpass filter to clean up the LO injection to the mixer. The extensive use of bandpass filtering in the system is one of the reasons for the exceptional performance of the system.

Table 2 summarizes the prices for the various modules that make up the system. Note that there are two price schedules — amateur and commercial. The amateur schedule is for bona fide radio amateurs (you must state your call when ordering) and is maintained by Paul as a

service to the amateur community. Industrial, educational, or other individual customers must use the commercial schedule. All the modules are constructed on double-sided G-10 board with the ground plane retained on one side and the microstripline elements etched on the other. Tuning and matching is accomplished at the factory using precision glass trimmers on the microstripline elements. Gold-plated SMA connectors are used for all input and output connections with the exception of the i-f output connector, which is a BNC. The modules on the

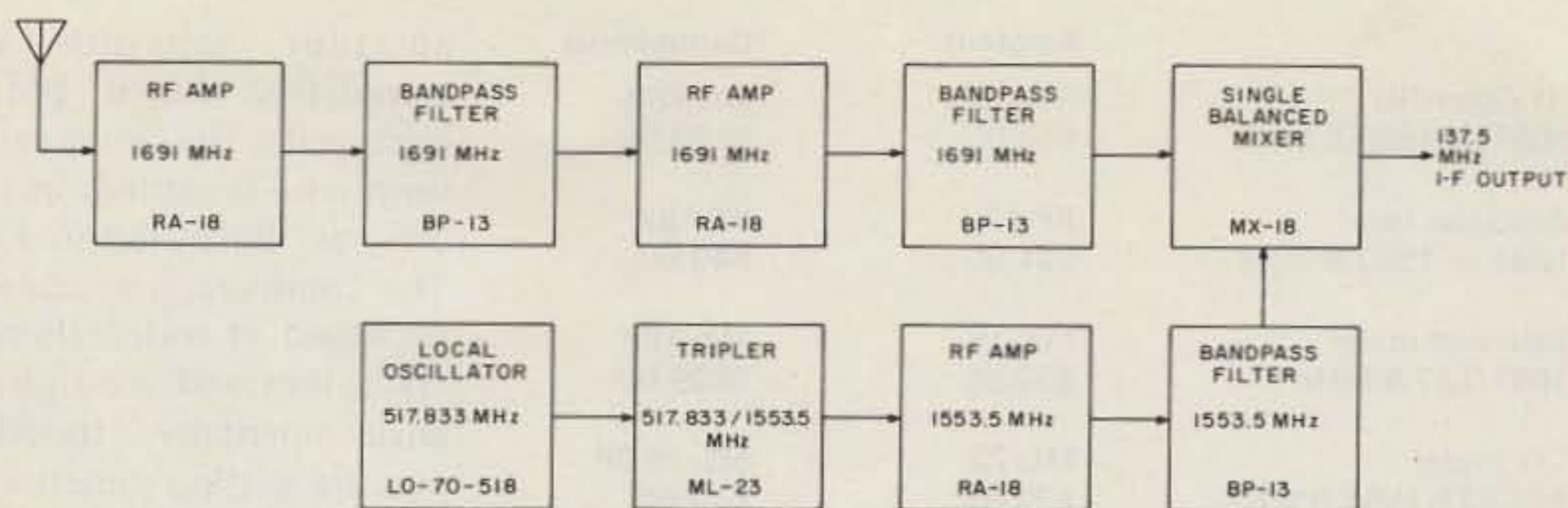

Fig. 1. System configuration for the Microcomm WEFAX downconverter.

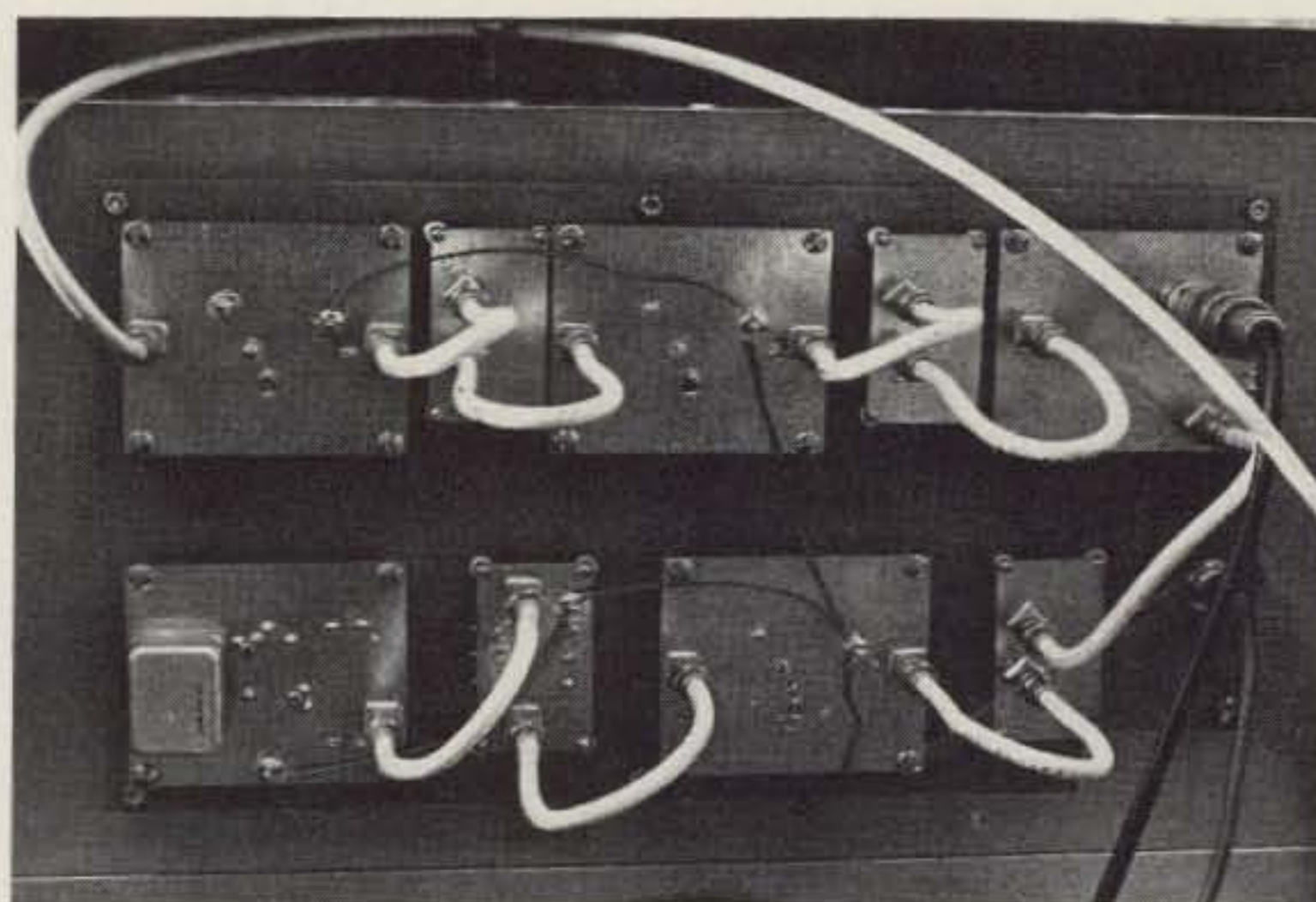

Fig. 2. The author's S-band GOES downconverter assembled from Microcomm circuit modules. The top row of modules (from left to right) includes the first rf amp (1691 MHz), a bandpass filter (1691 MHz), the second rf amp (1691 MHz), and the single balanced mixer for the 1691 to 137 MHz frequency conversion. The bottom row (again, from left to right) has the precision 518 MHz frequency source, a diode tripler, an active 1555 MHz amplifier, and a bandpass filter at 1555 MHz. RG-142/U is used to interconnect all modules with RG-58 foam coax at the i-f output. All of the active modules operate on 12 V dc and can be powered from the receiver power supply. The modules shown here are the amateur grade versions that are mounted on standoffs. The commercial grade modules are individually packaged in sealed aluminum enclosures.

| | Amateur | Commercial |
|--|----------------------|------------------------|
| Rf Amplifier 1691 or 1553.5 MHz | RA-18 \$64.95 | RA-18P \$129.00 |
| Bandpass filter 1691 or 1553.5 MHz | BP-13 \$21.95 | BP-18P \$40.00 |
| Balanced mixer 1691/137.5 MHz | MX-18 \$32.95 | MX-18P \$129.00 |
| LO tripler 517.833/1553.5 MHz | ML-23 \$22.95 | ML-18-3P \$40.00 |
| LO module 517.833 MHz | LO-70-518 \$75.95 | LO-70-518P \$250.00 |
| 20 cm RG-142/U jumpers with SMA plugs on both ends | \$10.00 | \$9.00 |
| RG-142/U | \$1.30/ft. | |
| SMA plugs | \$3.64 | |

Table 2. S-band downconverter modules available from Microcomm, 14908 Sandy Lane, San Jose CA 95124. See text for the operational differences between the amateur and commercial price schedules. Most modules, with the exception of the LO-70-518, are available from stock to 3 weeks. The LO-70-518 requires a precision crystal oscillator assembly, and an ordering lead time of 3-4 months is necessary, so order early, at least for the LO assembly. The frequencies noted above (in regard to the LO chain) assume an i-f frequency of 137.5 MHz. Converters can be supplied for any i-f in the VHF region, so specify the precise i-f desired when ordering. Modules in either price category are fully tuned at the factory, and, given the test equipment available to most of us, further tinkering with tuning is neither required nor desirable.

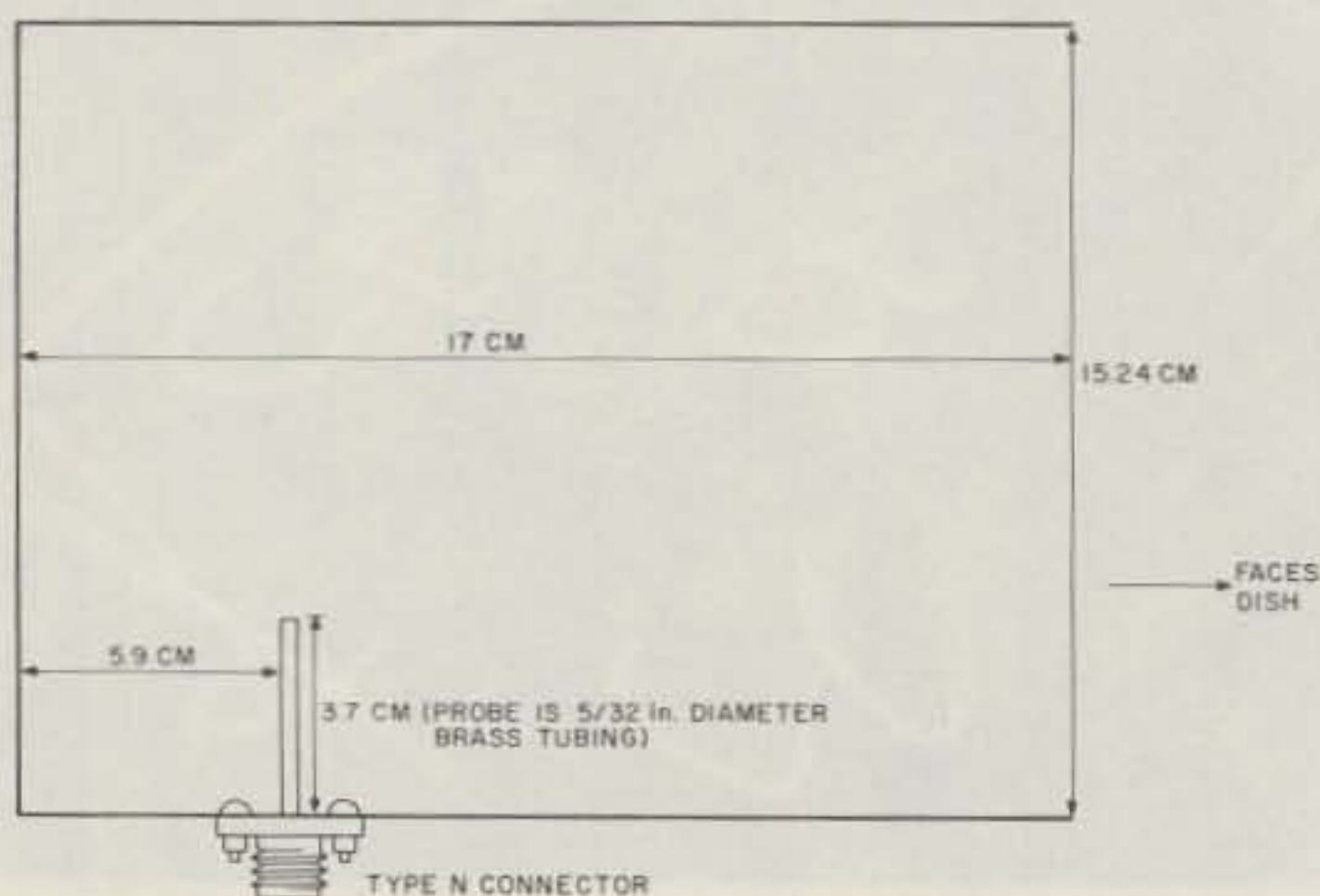

Fig. 3. Diagram of a feed horn assembly, fabricated from a 3 lb. coffee can and suitable for use with a wide variety of parabolic dish antennas. This horn, with its various fixed dimensions, was adapted by the author from data supplied by K3PGP. Very slight changes in the length of the probe and its distance from the back of the horn could probably improve its performance, but this "averaged" version works quite nicely. Obstructions inside the horn, exclusive of the brass probe, should be kept to a minimum, so the heads of the mounting screws for the type-N connector should be inside the can with the nuts and screw extensions on the outside. The plastic cap of the can can be retained for weatherproofing, if desired. The focal point of the dish should fall about 2" inside the open mouth of the horn, and any obstruction of the open end of the horn should be avoided.

amateur schedule come completely tuned but unpackaged. The modules can simply be mounted on stand-offs, as illustrated in Fig. 2. The commercial modules are packaged in sealed aluminum enclosures and are rigorously environmentally tested, so you are getting something for the additional cash. The rf amps will function over a temperature range of -30 to +54° C., making mast mounting of the preamps practical in any climate. Both the amateur and commercial modules interconnect with RG-142/U coax (double-shielded with teflon dielectric) jumpers equipped with SMA plugs. Microcomm can supply the cable and plugs or a complete set of assembled jumper cables. Using the amateur schedule, a complete downconverter, including jumper cables, can be assembled for less than \$400. Most of the modules are available from stock to 3 weeks, but the LO module requires considerable lead time because of the delay in obtaining the high-accuracy crystal that is employed. If you want to go the Microcomm route, you should order the LO module 3-4 months in advance to assure that it will be ready when you need it. Your precise i-f frequency should be specified when ordering to facilitate factory tuning of the various modules in the LO chain. 137.5 MHz is the standard i-f frequency and will speed the processing of the LO module slightly, so keep this in mind.

Antennas

The choice of an antenna system depends on a number of factors, so let us digress for an analysis of the rf link involved in the GOES system. The first thing you want to determine is the noise threshold of the receiving system. The thermal noise level of the system can be calculated from the formula:

$$TNL = -174 \text{ dBm} + 10 \log BW + 10 \log NF,$$

where: BW = i-f bandwidth (30 kHz), and NF = 2.2 (3.4 dB system noise figure for the Microcomm unit).

$$\begin{aligned} TNL &= -174 + 10 \log(3 \times 10^4) \\ &\quad + 10 \log(2.2) \\ &= -174 + 10(4.602) \\ &\quad + 10(0.3424) \\ &= -174 + 46.02 + 3.42 \\ &= -124.6 \text{ dBm}. \end{aligned}$$

If you have an internal noise level of -124.6 dBm when the Microcomm unit is used ahead of a low-noise receiver for the i-f, the incoming signal must have a level greater than -124.6 dBm if you are to have a positive signal-to-noise ratio (SNR). What you need to know now is the signal level that can be expected from the satellite. The EIRP of the GOES transmitter is +54.4 dBm, so you need to compute the path loss to determine the ground signal level. The path loss (L) can be determined from the formula:

$$\begin{aligned} L &= [10 \log(4\pi)^2 \times 100] / 9 + 20 \log DF, \\ \text{where: } D &= \text{range (35,788 km), and} \\ F &= 1691 \text{ MHz.} \\ L &= 10 \log(1.753 \times 10^3) \\ &\quad + 20 \log(35,788 \times 1691) \\ &= 10(3.243) + 20(7.78) \\ &= 32.43 + 155.6 \\ &= 188 \text{ dB.} \end{aligned}$$

The ground signal level can be found by subtracting the path loss from the satellite EIRP:

$$\text{Ground signal level} = +54.4 - 188 = -133.4 \text{ dBm}$$

Thus, ignoring cable losses and with no antenna gain, the satellite signal is 9 dB below the system noise threshold (-124.6 - 133.6). This 9 dB plus the addition of 12-14 dB required for noise-free pictures must be made up with antenna gain.

A parabolic antenna is the easiest way to come up with the required gain, but, before you consider the details of such an antenna, you need to have some way to feed parabolas in general. The tin-can feed horn antenna

diagrammed in Fig. 3 was derived from data supplied by K3PGP and does an excellent job. This feed horn has gain of approximately 9 dBi, and, if the figures for the rf link are accurate, it should just be possible to hear the satellite on the feed horn (SNR = 0). In fact, the satellite is audible on just the horn, substantiating the link calculations and the performance claims of the Microcomm system.

Gain for a parabolic antenna is a function of the area of the reflector. Since the area function involves the square of the radius, doubling the radius or diameter of the dish raises gain by a factor of 4 (6 dB). Fig. 4 indicates the gain (dBi) of several common dish sizes at 1691 MHz. Since this system is 9 dB down without the antenna, the system SNR can be calculated by subtracting 9 dB from the antenna gain, so the SNR values for the various antennas are also plotted. You require an SNR of +12 dB for noise-free pictures with most display systems, so the gain margin of the system (gain above this value) has been calculated by subtracting 12 dB from the system SNR.

The smallest usable antenna with the Microcomm system is a 2-foot parabola made from an aluminum saucer sled (don't bother with surfacing the newer plastic versions). Although the pictures are not noise-free with the Microcomm system, they will display reasonably well if filtering is employed in the video system. Surplus 4-, 6-, or 10-foot antennas are ideal, although they can be quite heavy. Suitable antennas can also be made up from 5- or 7-foot UHF TV parabolas resurfaced with window screen to improve the effectiveness of the dish surface.

Proper placement of the feed horn is with the focal point of the dish 1-2 inches inside the mouth of the horn. If you are using a UHF TV dish, you can use the position of the original feed as a rough

| Dish diameter | Source | Gain | SNR | Margin |
|---------------|------------------------|----------|----------|---------|
| 2 ft. | aluminum "saucer sled" | 18 dBi | +9 dB | -3 dB |
| 4 ft. | surplus | 24 dBi | +15 dB | +3 dB |
| 5 ft. | UHF TV dish | 26 dBi | +17 dB | +5 dB |
| 6 ft. | surplus | 27.5 dBi | +18.5 dB | +6.5 dB |
| 7 ft. | UHF TV dish | 29 dBi | +20 dB | +8 dB |
| 10 ft. | surplus | 32 dBi | +23 dB | +11 dB |
| 12 ft. | K2RIW stressed | 34 dBi | +25 dB | +13 dB |

Fig. 4. Antenna gain (dBi), system SNR, and system gain margin for various sized dish antennas at 1691 MHz when used with the Microcomm converter.

guide, moving the feed slightly to optimize gain. The same approach can be taken with a surplus dish that still has the original feed. If the feed is missing, you can compute the focal length as shown in Fig. 5. Use a length of board as a straightedge, laying it across the face of the dish so that the board crosses the dish center. Measure the distance (D) from the center of the edge of the board in contact with the dish to the center of the parabola. Also measure the diameter of the dish, and take 1/2 of this value as the dish radius (R). The focal length of the dish can now be calculated from the formula:

$$R^2 = 4AD,$$

where A = the unknown focal length, D = the measured distance to the dish center, and R = the dish radius (1/2 the diameter).

This formula will work for any units of measure, as long as the same units are used for all dimensions. In my case, my dish had R = 24" and D = 7.5". Substituting in the formula, I get:

$$\begin{aligned} (24)^2 &= 4(A)(7.5) \\ 576 &= 30(A) \\ A &= 576/30 \\ A &= 19" \end{aligned}$$

Since the focal point should fall about 2" inside the horn, I set the feed up so the open end of the horn was 17" from the dish face. Movement of less than 0.25" was sufficient to optimize gain.

Polarization will vary depending upon the azimuth of the satellite as seen from your location. Initial mounting should permit rotation of the feed to optimize polarization, after which it can be locked in place.

Directions for aiming antennas for geostationary satellites are covered in the *Weather Satellite Handbook*.³ In order to use these techniques, you must know the location of the satellite you wish to copy. GOES E (GOES 1) is located over the equator at 75° W. longitude, while GOES W (SMS-2) is located over the equator at 135° W. longitude.

The I-f Receiver

Virtually any receiver suitable for polar orbiting satellite work should do for the i-f. I am using a receiver built up from a VHF Engineering kit and described in a previous article in 73.⁴ I cannot emphasize too greatly the requirement for a low-noise front end at the VHF i-f frequency. Under no circumstances should you settle for anything higher than a 3 dB NF, and you should try for 1.5-2 dB if you can get it. Most VHF satellite receivers have an i-f bandwidth of 30 kHz. Satellite deviation requires only 18 kHz bandwidth, but the added bandwidth is usually used to accommodate the Doppler shift encountered with the polar orbiting spacecraft. You

have no Doppler to contend with in the case of the GOES spacecraft, but you do have thermal drift in the local oscillator chain of the S-band downconverter. The 30 kHz bandwidth provides the latitude required under most thermal regimes. You can gain an additional 3 dB in system margin by going to a standard 15 kHz i-f. Based on my own experience with the roll-off characteristics of the common filters, you can accommodate the satellite deviation. The major drawback with this approach is that an afc loop would be almost mandatory to center the incoming signal in the narrow passband of the receiver. If you care to modify your receiver for afc, you might want to consider this approach.

If the receiver has provisions for a COR function, you can use the COR circuit to key up the recorder for unattended operation. This will, however, result in some wasted tape, as the satellite is only transmitting video for a maximum of 460 seconds out of the 600 seconds (10 minutes) in each scheduled transmission slot. Although

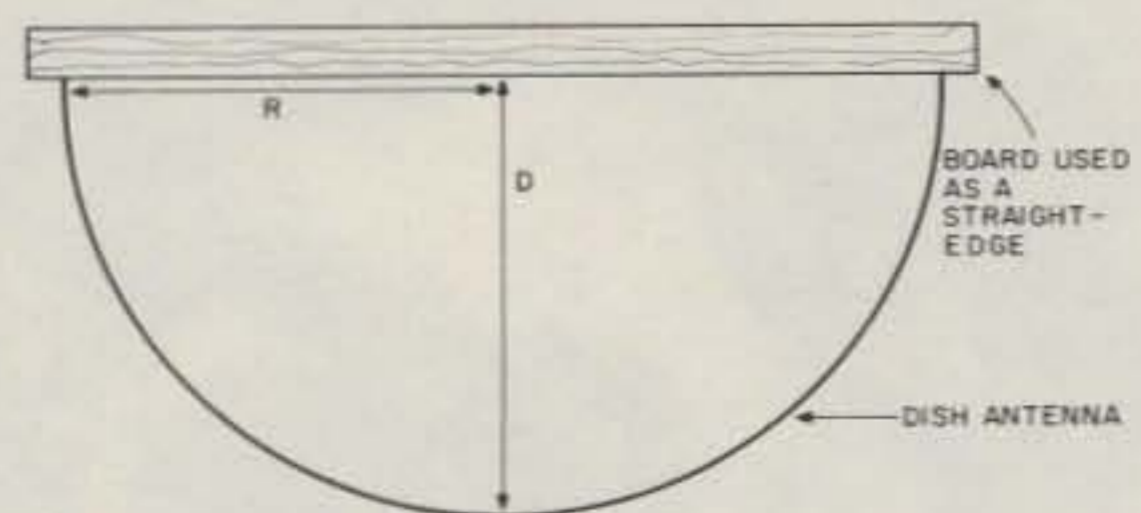

Fig. 5. Diagram of the technique for approximating the focal length of a surplus dish antenna. The two values you must measure are the radius (R) and the distance (D) from a straightedge across the face of the dish to the dish center. The text describes the formula for computing the unknown focal length from these values. The depth of the dish has been greatly exaggerated for the sake of clarity.

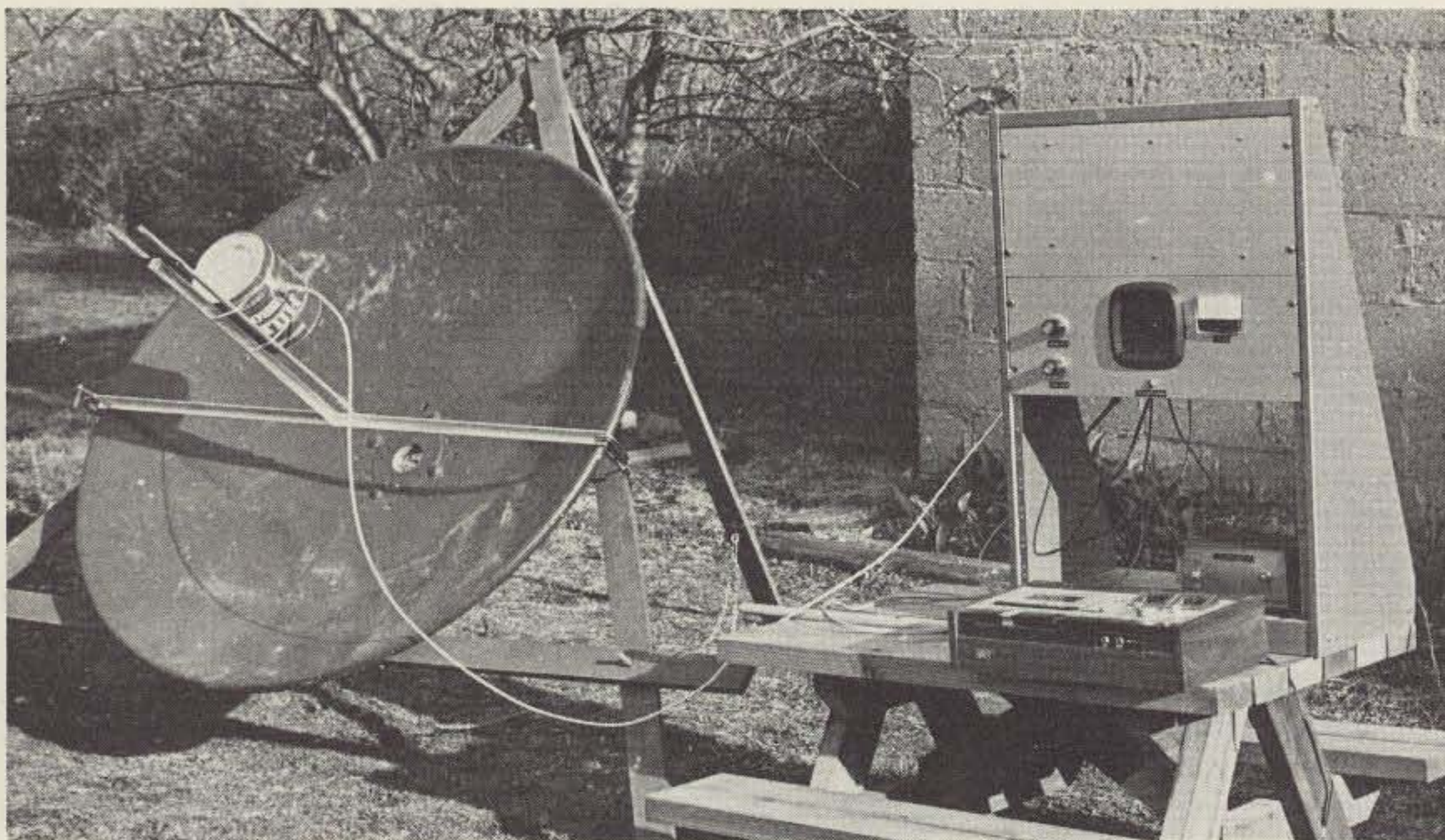

Fig. 6. The test configuration used to evaluate the Microcomm converter. The dish antenna is a 4-foot surplus parabola mounted in an adjustable A-frame assembly. While this mounting is not suited for rapid changes from one satellite to another, it works quite well for monitoring a single satellite — in this case, GOES E. The coffee-can feed horn is clearly visible. I have since painted the outside of the horn (a rash step undertaken before I realized what a status symbol I had with my three-pound coffee can). 10 feet of RG-142/U (line loss of 2.1 dB) connects the feed horn with the converter. The converter modules are mounted behind the upper rack panel, while the lower panel contains the i-f receiver described in a previous article.⁴ The cassette tape deck and 12 V power supply are also shown. Despite the line losses and partial obstruction of the end of the feed horn by the aluminum mounting rails, the system delivers full-quieting signals from both GOES E and GOES W.

this seems like a minor matter, it becomes important if you realize that each of the two operational GOES satellites has 36 ten-minute trans-

missions each day — a total of 84 “dead carrier, no video” minutes a day! This can be overcome by using an NE-567 tone decoder chip set up for

2400 Hz detection. You can drive the chip with an SSTV limiter hooked up to the audio line or use the 567 to key up a 555 with a slight delay so the relay doesn't drop out with subcarrier amplitude variations. In this way, you will only record actual frame transmissions, thus saving those 84 minutes of dead tape.

System Evaluation

The Microcomm converter was evaluated with the test setup shown in Fig. 6. The system employs 10 feet of RG-142/U between the horn and the first rf amplifier in the rack. The loss in this length of line is 2.1 dB with the probability of another dB loss due to the use of a BNC connector at the antenna end and then a BNC-to-type-N adapter to mate the line with the feed horn. The receiver noise level runs 1.5 microamps on the S-meter with no converter, rising to 3 microamps with the converter powered up. The receiver

limits at 10 microamps and GOES signal levels have ranged between 11 and 15 microamps. Thus, considering that you have at least 2.5 to 3 dB of line loss prior to the first rf stage, it seems likely that you have at least the 3 dB system margin predicted by our link calculations. In addition to the line losses, there is an additional drop in signal strength due to the jury-rigged mounting system for the horn, obscuring a portion of the periphery of the horn with the aluminum mounting rails for the feed. The system will deliver noise-free copy despite these losses, as shown by the samples of GOES WEFAX imagery in Figs. 7-10.

Permanent Installation

Obviously, the system illustrated is not the operational installation. There are three reasons for this: (1) My wife wants that thing (my antenna) off the back lawn; (2) she also wants our daughter's picnic table back where it belongs; and (3) I cannot be hauling the rack in and out all year long. There are four main routes to a suitable permanent installation:

(1) Install the dish near the operating position, and run a short length of low-loss cable back to the installation.

(2) Site the antenna at any convenient location, mount two additional preamps (weatherproofed) on the horn, and run a low-loss line back to the converter.

(3) Mount the entire converter and i-f preamp in a weatherproof and temperature-controlled enclosure, and run the i-f signal back on low-loss line.

(4) Use a weatherproof and temperature-controlled enclosure at the antenna site, and use it to hold the entire receiving system.

The first option is probably not practical for most installations, and the second gets quite expensive if you tally up the costs for suitable transmission line and

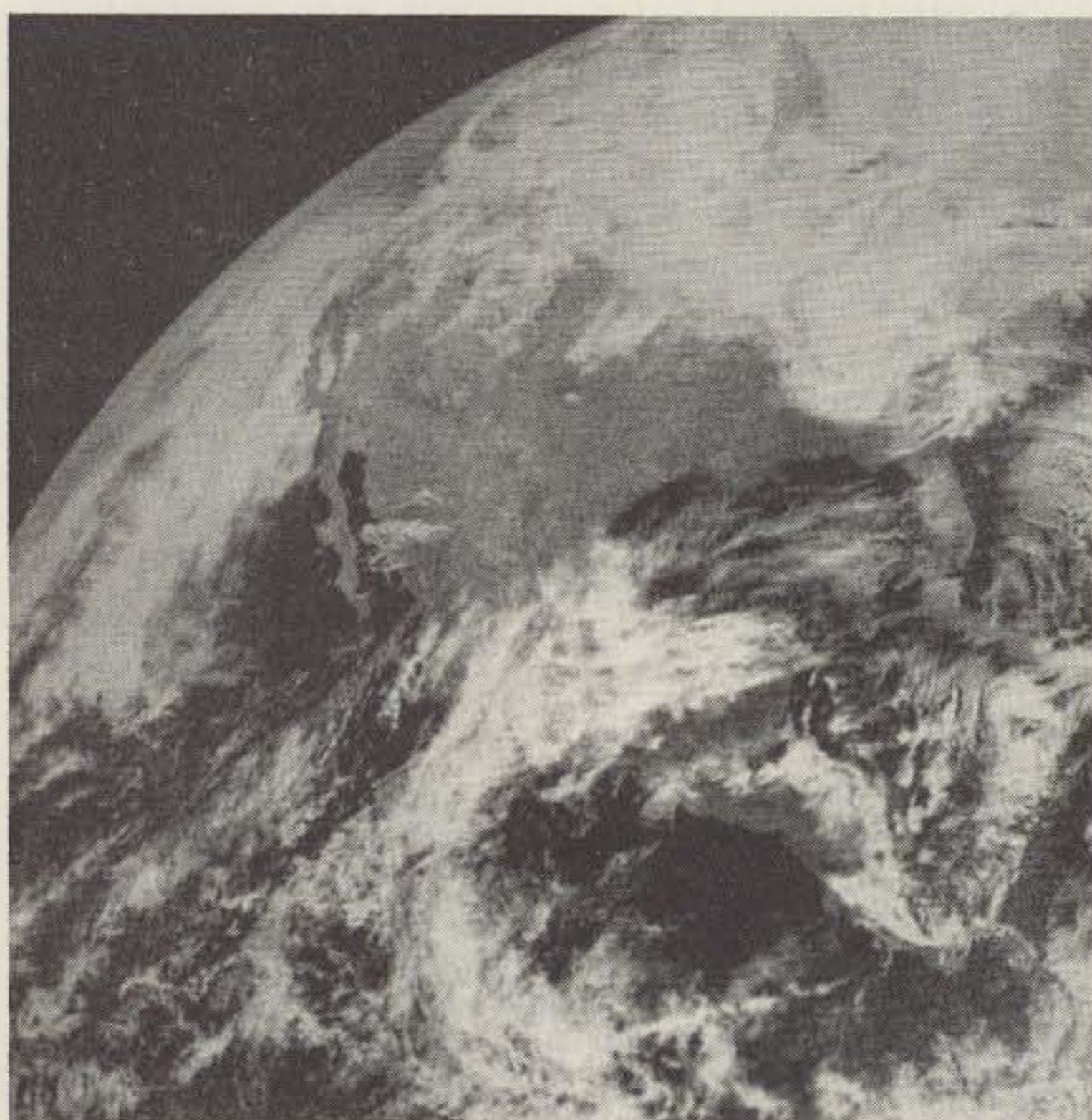

Fig. 7. A NW visible light quadrant transmitted by GOES E showing most of North America and Central America.

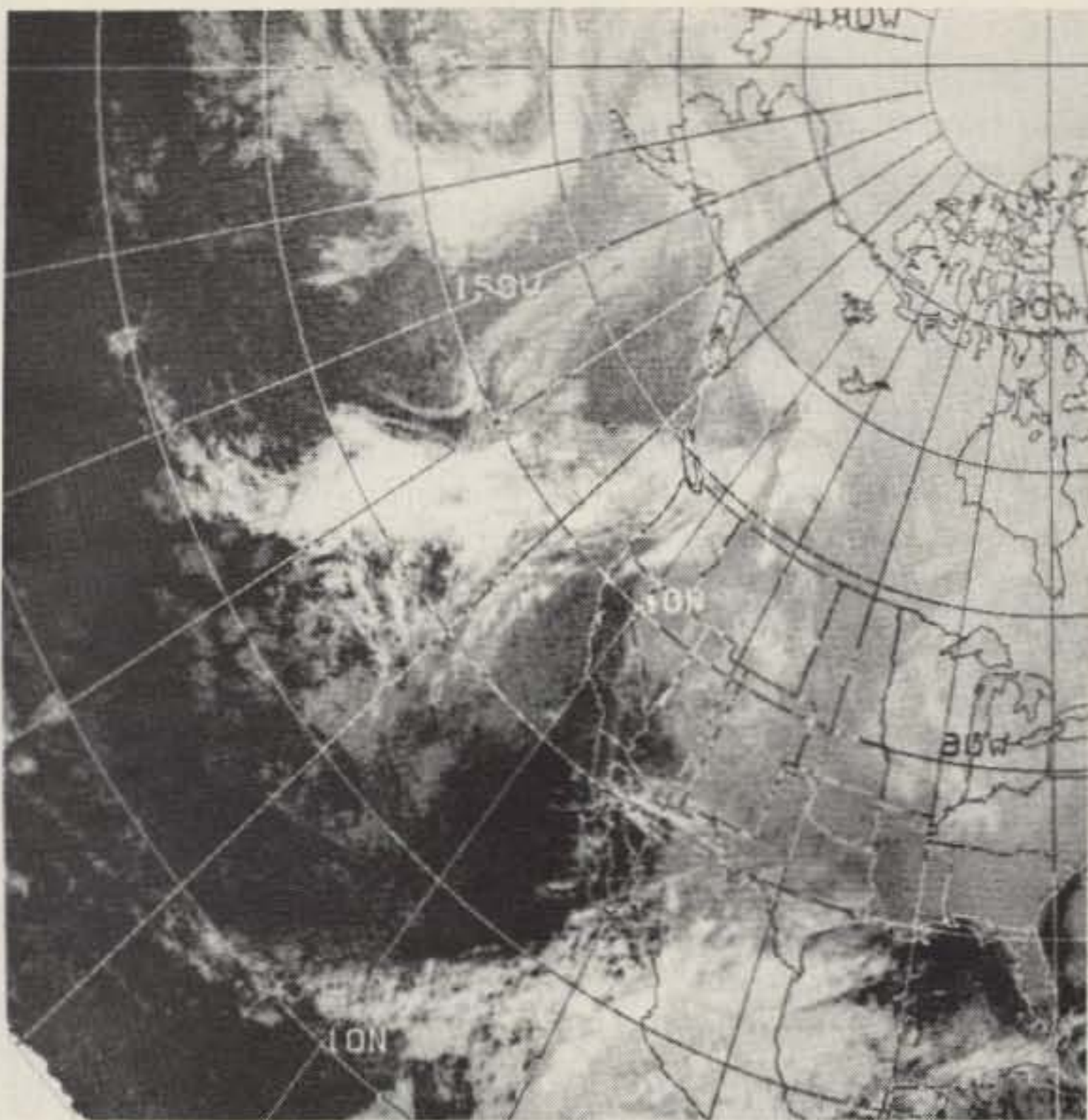

Fig. 9. One sector of a northern hemisphere polar mosaic prepared from NOAA 5 polar orbiting data and relayed through GOES E. This is night IR data and clearly shows the low ground temperatures over much of the U.S. during February when this picture was obtained.

the added expense of one or two additional preamps to overcome the line losses. Three is a lot of bother, but, if you can pull it off, it is actually easier to go for #4, which is what I have done. Although the weatherproof enclosure route sounds complicated, it is easy to do. I simply placed the entire S-band converter and i-f receiver electronics in a Coleman ice chest. You can bring cables out the side of the box with plastic pipe fittings that are quite easy to seal up once the cables are installed. The box can be sealed easily and provides plenty of insulation. The box itself is shaded by the dish, and a short length of RG-8 foam cable connects the converter to the feed. A multiconductor cable carries unregulated dc (@18 V) out to the box, where it is regulated to 12 V by an IC chip, thus overcoming line voltage drop problems. Receiver audio is returned using two other conductors. The audio return is 500 Ohms balanced, achieved by using an 8-Ohm to 500-Ohm audio trans-

former in the box. The audio is converted back to 8 Ohms for the speaker in the control console. Speaker volume is controlled with an 8-Ohm pad. In relatively mild climates, this is all that should be required. Michigan, however, is far from mild in the climate department, so a thermostatically-controlled heater system was also installed in the box to handle low winter temperatures. The heater coil (25 W) from an aquarium heater was used, controlled by the thermostat for an egg incubator. The thermostat is set to hold the box temperature at 60° F., and experiments with the home freezer indicate that the small heater will have no difficulty handling the load at any conceivable low temperature likely to be encountered. Initially, everything was simply dumped into the box for feasibility testing, but, once the concept checked out, a frame was made out of 1/2" aluminum angle stock which holds everything together as a unit, should it ever be necessary to

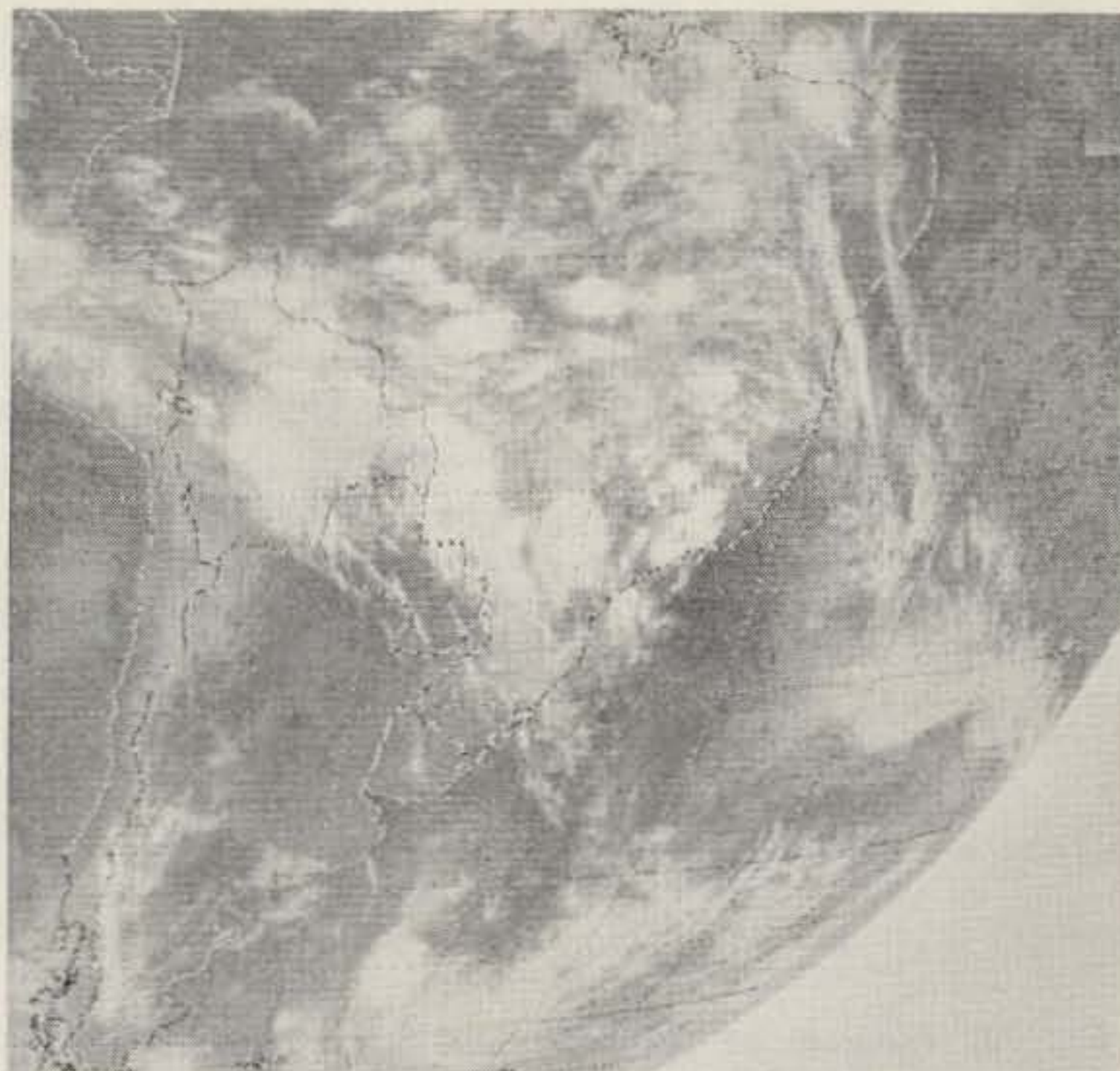

Fig. 8. A SE IR quadrant from GOES E showing most of South America. In the IR format, cold objects (space, high clouds) appear white with warmer objects appearing darker. The Andean uplands show noticeably whiter (cooler) than the lowlands. Low cloud cover over the Atlantic off the coast of Brazil is quite close to sea temperature and thus does not show strongly.

perform service work on the assembly.

GOES Imagery

The four principal types

of imagery transmitted as part of the GOES WEFAX program are illustrated in Figs. 7-10. The material of greatest potential interest is

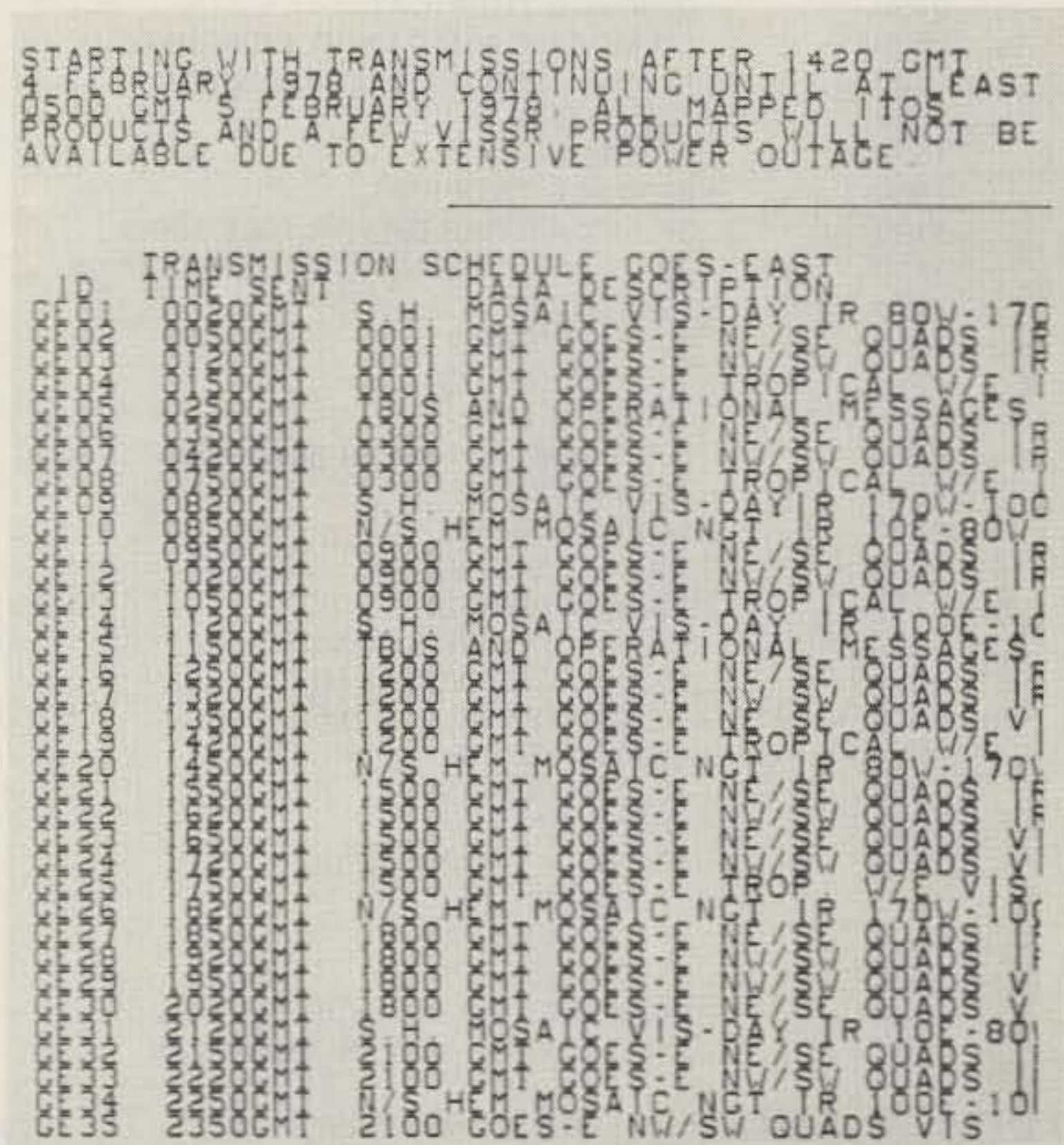

Fig. 10. An example of an operational message transmitted through GOES E. In this case, we have the actual GOES E transmission schedule.

the visible light (Fig. 7) and IR (Fig. 8) imagery derived from the very high resolution infrared spin scan radiometer (VISSR) imaging system aboard the satellite. The GOES VISSR system produces very high resolution images of the full-Earth disc in both visible and IR radiation every 20 minutes. Direct reception of the VISSR images is impractical at the present time, due to

the very wide bandwidths employed for transmission and the digital signal processing required to handle the pictures. The VISSR data are processed by the CDA ground stations, however, and sectorized images derived from VISSR data are then relayed through the satellite as part of the WEFAX program. The full-Earth disc is broken up into 4 quadrants for WEFAX transmission, as

illustrated in Fig. 11. Additionally, two frames are also transmitted covering just the tropical portions of the disc. The examples shown in Figs. 7 and 8 are from GOES E and show portions of the Earth disc as seen by that satellite. Formatting is identical for GOES W, except that the pictures cover the view of the Earth as seen from that satellite's vantage point over the eastern Pacific.

Since geostationary satellite orbits must be located over the equator, the GOES satellites do not obtain a good perspective on the polar regions. To overcome this problem, gridded polar mosaics are assembled from NOAA polar orbiting satellite data and relayed through GOES as part of the WEFAX program. An example of one of the sectors from such a mosaic is shown in Fig. 9. Although the polar mosaics lack the beauty of the Earth disc imagery, they are extremely useful for forecasting because of the influence of the north and south polar regions on the world's weather systems.

Finally, various kinds of printed data, including the GOES operating schedules, operational announcements concerning tests and system status, and prediction data in support of polar orbiting operations, are also relayed as WEFAX imagery. Fig. 10 shows a typical transmission of this type. This is a far better way of keeping track of the GOES schedules than waiting for announcements from Washington. The latter have a tendency to arrive as much as several weeks after a schedule change! Although the schedules are changed on occasion, the GOES E schedule at the time of writing is included in Fig. 12 to give you some idea of the variety of data that is available.

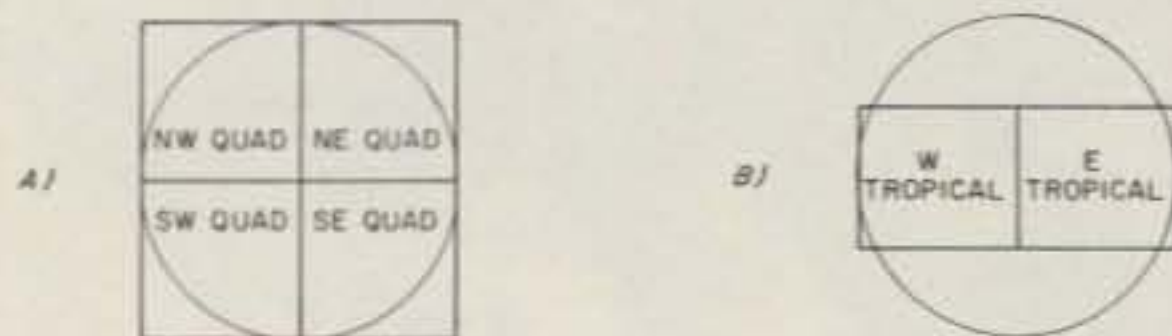

Fig. 11. Diagram of the sectoring procedure for WEFAX transmission of data derived from GOES VISSR operations. (a) shows the procedure for handling the full-Earth disc image involving the transmission of four quadrants. In addition, in order to provide full uninterrupted coverage of tropical latitudes, an eastern and western tropical segment is transmitted as shown in (b).

| Time (GMT) | Data Description |
|------------|--------------------------------|
| 0050 | SH MOSAIC VIS-DAY IR 80W-170W |
| 0120 | 0001 NE/SE IR |
| 0150 | 0001 NW/SW IR |
| 0220 | 0001 W/E TROPICAL |
| 0250 | TBUS AND OPERATIONAL MESSAGES |
| 0350 | 0300 NE/SE IR |
| 0420 | 0300 NW/SW IR |
| 0750 | 0300 W/E TROPICAL |
| 0820 | SH MOSAIC VIS-DAY IR 170W-100E |
| 0850 | N/SH MOSAIC NGT IR 10E-80W |
| 0950 | 0900 NE/SE IR |
| 1020 | 0900 NW/SW IR |
| 1050 | 0900 W/E TROPICAL |
| 1120 | SH MOSAIC VIS-DAY IR 100E-100W |
| 1150 | TBUS AND OPERATIONAL MESSAGES |
| 1250 | 1200 NE/SE IR |
| 1320 | 1200 NW/SW IR |
| 1350 | 1200 NE/SE VIS |
| 1420 | 1200 W/E IR |
| 1450 | N/SH MOSAIC NGT IR 80W-170W |
| 1550 | 1500 NE/SE IR |
| 1620 | 1500 NW/SW IR |
| 1650 | 1500 NE/SE VIS |
| 1720 | 1500 NW/SW VIS |
| 1750 | 1500 W/E TROPICAL VIS |
| 1820 | 1500 W/E TROPICAL IR |
| 1850 | 1800 NE/SE IR |
| 1920 | 1800 NW/SW IR |
| 1950 | 1800 NE/SE VIS |
| 2020 | 1800 NW/SW VIS |
| 2120 | 1800 W/E TROPICAL VIS |
| 2150 | 2100 NE/SE IR |
| 2220 | 2100 NW/SW IR |
| 2250 | 2100 NE/SE VIS |
| 2320 | SH MOSAIC VIS/DAY IR 10E-80W |
| 2350 | N/SH MOSAIC NGT IR 100E-100W |

Fig. 12. A sample transmission schedule for GOES E. The data description column includes the time or acquisition of the VISSR full-Earth disc, the WEFAX quadrant (see Fig. 11 for an explanation of this), and whether the data represents visible (VIS) or infrared (IR) imagery.

Since geostationary satellite orbits must be located over the equator, the GOES satellites do not obtain a good perspective on the polar regions. To overcome this problem, gridded polar mosaics are assembled from NOAA polar orbiting satellite data and relayed through GOES as part of the WEFAX program. An example of one of the sectors from such a mosaic is shown in Fig. 9. Although the polar mosaics lack the beauty of the Earth disc imagery, they are extremely useful for forecasting because of the influence of the north and south polar regions on the world's weather systems.

Finally, various kinds of printed data, including the GOES operating schedules, operational announcements concerning tests and system status, and prediction data in support of polar orbiting operations, are also relayed as WEFAX imagery. Fig. 10 shows a typical transmission of this type. This is a far better way of keeping track of the GOES schedules than waiting for announcements from Washington. The latter have a tendency to arrive as much as several weeks after a schedule change! Although the schedules are changed on occasion, the GOES E schedule at the time of writing is included in Fig. 12 to give you some idea of the variety of data that is available.

Summary

The Microcomm system does provide a cost-effective way to get into the action on

References

1. Nagle J., 1974, "A method of converting the SMS/GOES WEFAX frequency (1691 MHz) to the existing APT/WEFAX frequency (137 MHz)," NOAA Technical Memorandum NESS 54.
2. Taggart, R. E., WB8DQT, "Amateur Weather Satellite Reception," 73, May, 1976, p. 52.
3. Taggart, R. E., WB8DQT, *The Weather Satellite Handbook*, 73 Publications, Peterborough NH, 1976.
4. Taggart, R. E., WB8DQT, "Predict the Weather!," 73, May, 1977, p. 48.

CALL A.R.S.O.N. NOW!

615 868-4956

for the Best DEALS

Amateur Radio Supply of Nashville, Inc.

615 South Gallatin Road, Madison, Tennessee 37115 ✓A40

best prices · best service · best trades



CDE Rotor Specials

Shipping included to Cont. U.S.A.
 Ham III rotor \$124.00
 Ham III rotor plus 100 ft. rotor cable \$139.00
 Ham III rotor plus 100 ft. each - rotor cable and best RG-8U foam coax \$162.00
 T2X Tailtwister \$229.00
 Send cashiers check or M.O.

SPECIAL DEMO SALE

The following are NEW Close-outs, New displays, Demos, etc. Most are factory-sealed, all carry New warranties. Limited quantity. First come, first served.

ICOM

IC-245 2M FM \$399.00
 IC-245/SSB 2M all mode 575.00
 IC-211 2M all mode 725.00
 IC-701 Dig HF XCVR 1400.00

KENWOOD

TS 820S Xcvr 975.00
 TS 520S Xcvr 565.00
 SM 220 Scope 289.00
 TR 7400A 2M FM 379.00
 TS 700SP 2M all mode 625.00

TEN-TEC

544 Dig Xcvr 715.00
 540 Xcvr 579.00
 570 CW Xcvr 259.00
 574 Dig Xcvr 339.00

WILSON

Mark II 2M hand held 199.00
 Mark IV 2M hand held 229.00

YAESU

FT 901DM 1175.00
 FT 901DE 999.00
 FT 901D 999.00
 FT 101F 669.00
 FT 101EE 615.00
 FT 101EX 569.00
 FT-7 HF Mobile 449.00



YAESU FT 901 DM
 Call for yours today.

The Memorizer



Yaesu FT 227R
 Fully Syn 2M FM



TS-820S KENWOOD
 Deluxe 1.8 - 30 MHz Transceiver



Kenwood
 7400A 25 watts
 Fully syn. 2M FM
 Call for Super Quote

Call us for:
 Drake TR7 & Ten-Tec OMNI
 The best antenna deals.
SUBDEALERS WELCOME
 We're burning to make "hot" deals

STORE HOURS
 Mon. - Fri. 9 AM - 5 PM
 Sun. 1 PM - 6 PM

MASTER CHARGE
 & VISA ACCEPTED



TRY OUR SERVICE DEPT.

Send your rig complete with PS and Manuals via U.P.S. to us and will put it into top shape FAST.

SPECIAL USED SALE

30-Day guarantee. Limited quantities. First come first served.

DRAKE

R4C RCVR \$379.00
 T4XC Trans 379.00
 TR4CW/Rit XCVR 549.00
 R4-A RCVR 299.00
 T4-X Trans 299.00
 TR-3 XCVR 325.00
 MS-4 Spkr 19.00
 AC-4 AC Supply 85.00
 DC-4 DC Supply 85.00

ICOM

IC 22A FM 2M Xcvr 125.00
 IC 21A & DV-21 2M 349.00
 IC 22S 2M FM 209.00

KENWOOD

T-599A Trans 269.00
 R-599A Rcvr 269.00
 T-599D Trans 399.00
 R-599D Rcvr 399.00
 TV502 2M Transverter 169.00
 TV506 6M Transverter 169.00
 TS 700A 2M all mode 399.00
 TS 502S 160-10M Xcvr 539.00

HEATHKIT

SB-230 Linear amp 299.00
 HW 101 & PS & Spkr, Mic 369.00
 SB-300 189.00

YAESU

FR AX400 Rcvr 249.00
 FL AX400 Trans 249.00
 FR 101SD dig Rcvr 449.00
 FL 101 Trans 419.00
 Yaesu FT 101EE 160-10M 519.00

from page 190

Finally, the Commission often makes arrangements for the examination of the handicapped on an ad hoc basis. A deaf applicant, for example, might be administered a telegraphy examination using a flashing light, or might be permitted to place his or her fingers upon a pulsating oscillator to "feel" the text being sent. In each of the instances outlined above, however, the handicapped applicant is held to the same standard of competence as the non-handicapped applicant; the passing requirements are identical.

REGULATORY BACKGROUND

The United States is signatory to the Radio Regulations of the International Telecommunication Union (ITU). As such, the Commission is obliged to observe and implement those regulations. Article 41, section 3(1) of the ITU Radio Regulations states that:

Any person operating the apparatus of an amateur station shall have proved that he is able to send correctly by hand and to receive correctly by ear, texts in Morse code signals. Administrations concerned may, however, waive this requirement in the case of stations making use exclusively of frequencies above 144 MHz.

Section 97.23 of the Commission's rules implements article 41, section 3(1) of the ITU Radio Regulations. Section 97.23 requires that an applicant for an amateur operator license successfully complete a telegraphy examination in accordance with the following schedule:

Operator Class and Speed Required

Novice—5 words per minute (wpm).
Technician—5 wpm.

General—13 wpm.
Advanced—13 wpm.
Amateur Extra—20 wpm.

THE PROBLEM

Although most persons can learn to receive telegraphy well enough to obtain amateur licenses, some persons simply cannot. Some persons can learn to receive telegraphy, but only at very slow speeds. Other persons can receive telegraphy but for one reason or another cannot commit what they hear to paper. The reasons for an inability to learn the international Morse code either at all or at the necessary speed stem from several sources. Applicants with severe physical disabilities, such as quadriplegia, may be able to understand the code but may not be able to meet the Commission's speed requirements. Other applicants allege specific learning disabilities which prevent acquisition of telegraphy skills.

The Commission receives several requests each month for special consideration on the telegraphy examination from persons unable to meet the Commission's telegraphy requirements. Such requests are occasionally submitted by those who probably could, if they were sufficiently diligent, learn telegraphy. Often, however, individuals requesting special consideration are severely handicapped and allege that because of their handicaps they are incapable of successfully completing the Commission's telegraphy examinations. Handicapped applicants unable to pass the Commission's telegraphy examinations frequently assert that the Commission should not refuse to issue them amateur operator licenses because handicaps over which they have no control prevent the acquisition of telegraphy skills.

Since the Commission is precluded by article 41, section 3(1) of the ITU radio regulations from waiving or eliminating the telegraphy requirement in its entirety (at least insofar as stations operating below 144 MHz are concerned), the questions to be addressed by both the Commission and those responding to this notice of inquiry are these:

What is the proper Commission approach to the administration of amateur radio telegraphy examinations to the handicapped?

How should the Commission respond to requests for relaxation of the telegraphy speed requirement submitted by handicapped applicants?

Should the handicapped be held to less rigorous standards than the nonhandicapped? If so, should the handicapped receive the same operating privileges as the nonhandicapped?

Is the Commission doing enough now to assist the handicapped demonstrate their telegraphy qualifications?

DECISION FACTORS

To assist the public to channel its thinking about the administration of amateur telegraphy examinations to the handicapped, the Commission has developed a preliminary set of decision factors. The list of decision factors that follows is not exhaustive. Rather, it merely represents some of the major criteria the Commission believes the public should explicitly consider in evaluating the options (decision alternatives) for Commission action. If the Commission has overlooked any significant decision factor, the Commission urges the public to develop others. The Commission believes the objective evaluation of various decision alternatives in terms of a set of decision factors will result in sounder, more rational decisionmaking. We believe, further, that such decisionmaking will materially assist us in our continuing efforts to serve the public effectively.

1. ADMINISTRATIVE/RESOURCE IMPACT

This decision factor comprehends all

costs to the Commission that would result from adoption of any of the decision alternatives. Although the public cannot be expected to comment knowledgeably or precisely about how much it would cost the Commission to pursue a particular course of action, the Commission asks those recommending one alternative over another to consider the potential administrative and budgetary impacts of the recommended alternative on the Commission. Cost will play a very important role in whatever action, if any, the Commission eventually takes toward the administration of amateur telegraphy examinations to the handicapped. In submitting comments, the public should be aware that the Commission will be able to adopt an expensive decision alternative only if the information developed concerning the other decision factors is strongly supportive.

2. IMPACT ON THE AMATEUR RADIO SERVICE

This decision factor concerns the objective impact of adoption of each of the decision alternatives on the amateur service and its licensees. For example, would adoption of a particular decision alternative result in a large increase in the population of the amateur service, a small increase or no increase at all? What would the effect be on spectrum use? Would the amateur frequency bands become perceptibly more crowded? Would the overall quality of the service, expressed in terms of operator qualifications and competence, decline or increase appreciably?

3. IMPACT ON THE HANDICAPPED

Using this decision factor, the public should assess the impact of the adoption of each of the decision alternatives on the handicapped. For example, would adoption of a particular decision alternative result in fairer treatment for the handicapped? Would the



Swan 100MX

ALLIANCE ROTOR SPECIAL

HD 73 \$99.95



ICOM IC211

ATLAS • DRAKE • ICOM • SWAN • TEMPO • HY-GAIN • DENTRON • WILSON • STANDARD • KLM • CUSHCRAFT • B&W • PIPO • LARSEN • BENCHER • NYE • WESTCOM • ALLIANCE • MFJ • TELEX • NEW-TRONICS • FINCO • ROHN • W2AU • HAM-KEY • AND MANY MORE •

(((DISCOUNT PRICES ON ALL ABOVE ITEMS)))

Before you buy your next HAM RADIO—STOP—and take time to call us. We offer the lowest prices in the U.S.A. Charge it, VISA OR MASTERCHARGE, or we will ship C.O.D.

RON
(716) 235-7716

Mon-Fri 10 to 3
and 6 to 9

JIM
(716) 235-7540

Amateur Radio of Rochester, Inc. ✓A51

1185 Scottsville Rd. Rochester, New York 14624

ZZZ ELECTRONICS, INC.



We Sell & Service These Lines Call Now For HAM Prices

ICOM
KLM
Dentron
SWAN
KDK2015R
Tentec
Wilson
Telex
Hustler
Mosley
Cushcraft

Ameco
SAY Power Supplies
B&W Switches
Shure
Integrated Electronics
LARSEN
ADI Auto Dialers
PanaVise
Amphenol
Aluma Towers
And Many More

Special Prices On These Items Now

ICOM 211
KDK 2015R
Ten Tec 570
Ten Tec 574
Dentrol All Band Doublet
SWAN TB4HA
SWAN TB3HA
Dentron MT2000A
Dentron MT3000A

ICOM IC215
KLM 144-148-16
KLM 144-148-14
KLM 144-148-50
RG8X COAX
Dentron Big Dummy
Dentron Jr. Monitor
YAESU 7T101EE
ICOM 245SSB
SAY Elect. Power Supplies
KLM 2-25B
10' & 15' Roof Top Tripods

We accept MC & Visa & Interbank Cards —will ship UPS C.O.D.
422 ARMOUR CIRCLE N.E.
ATLANTA GA 30324
(404) 876-0631

Come by or call William/WA4SVY



number of handicapped applicants obtaining amateur licenses be greater, fewer, or the same? Would the Commission be meeting the needs of the handicapped more effectively?

4. PRACTICAL PROBLEMS

This decision factor includes miscellaneous information that might have an impact on the Commission's decisionmaking process. For example, three of the four decision alternatives discussed below require the Commission to define "handicapped." What sort of definition of "handicapped" should the Commission adopt, for purposes of amateur operator examinations, given the Commission's lack of medical expertise? Those submitting comments should outline any other factors relevant to a proper disposition of the matter at hand.

DECISION ALTERNATIVES

The Commission has identified several alternate approaches to the problem of the administration of telegraphy examinations to handicapped applicants for amateur radio operator licenses. The paragraphs that follow briefly discuss each of the major alternatives. Where necessary for complete understanding of the alternative, the Commission has included pertinent background information.

ALTERNATIVE 1: MAINTAIN THE STATUS QUO

As we outlined in the preceding paragraphs, the Commission currently makes many special arrangements to assist the handicapped demonstrate their telegraphy qualifications. We do not relax the telegraphy requirement, however. Thus, a handicapped applicant for a general class license, for example, must be able to demonstrate an ability to receive telegraphy at 13 wpm.

ALTERNATIVE 2: AMEND THE RULES TO REDUCE THE TELEGRAPHY SPEED REQUIREMENT FOR HANDICAPPED APPLICANTS.

The Commission's past experience has demonstrated that giving handicapped applicants for amateur operator licenses special consideration in the rules makes it possible for many handicapped persons who might not otherwise be able to pursue amateur radio as a hobby to do so. Occasionally, however, nonhandicapped persons have attempted to take advantage of the rules for the handicapped. We solicit comments on how we could draft new rules avoiding the problems we have encountered in the past.

ALTERNATIVE 3: AMEND THE RULES TO CREATE A NEW CLASS OF AMATEUR OPERATOR LICENSE WITHOUT A TELEGRAPHY REQUIREMENT AND RESTRICT ELIGIBILITY TO HANDICAPPED APPLICANTS.

The ITU radio regulations permit the Commission to create such a license class, as long as any stations licensed are restricted to operation above 144 MHz. (There is an open rulemaking proceeding, docket 20282, in which the Commission proposed a "codeless" license class, the Communicator class, having neither telegraphy requirements nor operating privileges below 144 MHz. The Communicator class would not have been restricted to the handicapped, however.)

ALTERNATIVE 4: WAIVE THE RULES TO PERMIT HANDICAPPED APPLICANTS TO DEMONSTRATE THEIR TELEGRAPHY QUALIFICATIONS AT SLOWER SPEEDS THAN NONHANDICAPPED APPLICANTS.

As we indicated above, the Commission does not grant waivers of the telegraphy speed requirement.¹ If the Commission were to begin waiving the telegraphy speed requirement for the

Continued on page 284

¹The Chief, Safety and Special Radio Services Bureau is, of course, delegated authority to waive the regulation by section 0.331 of the rules.

More Economical RTTY



The ST-5000 from HAL

The HAL ST-5000 sets the pace for an economical demodulator/keyer for radio-teletype (RTTY). All the features you need for reception and transmission of HF and VHF RTTY are here.

The demodulator features a hard-limiting front end, active filter discriminator, and active detector circuitry for wide dynamic range. Autostart and motor control circuitry make for easy VHF and HF autostart operation.

Convenient front panel switches are provided for 850 and 170 Hz shift, normal or reverse sense, autostart on/off, print - line or local, and power on/off. 425 Hz press transmissions may also be copied with the ST-5000. High voltage 60 ma. loop output as well as low level RS-232 compatible output are provided by the demodulator.

The audio keyer section of the ST-5000 generates stable, phase-coherent audio tones. Transmission is a simple matter of applying these tones to your HF SSB or VHF FM transmitter.

The ST-5000 is housed in an attractive blue and beige cabinet and is backed by the HAL Communications one year warranty.

For complete specs on the HAL ST-5000, write or call HAL today.

\$275.00



HAL Communications Corp., Box 365, 807 E. Green St.
Urbana, Illinois 61801 • Telephone (217) 367-7373

Little Giant Trans Systems Tuner Kit.. \$122.50 Wired & Tested..... \$144.50

Designed and engineered after "Apollo"—"Little Giant" 2500X-2, for an "engineered performance" Trans Systems Tuner and Adaptations of the Lew McCoy Transmatch, with power handling at the KW plus level!



Kit includes:

- 1 200 pfd wide-spaced variable with Isolantite insulation rated 3,000 volts
- 1 200 pfd dual section parallel condenser isolantited
- 2 finger-grip pointer knobs 2" diam, white indented
- 1 pvc insulated shaft couplings 1/4 to 1/4
- 3 SO-239 coax chassis connectors. Tunes 52 ohm or 52-300-600* or random wires
- 1 heavy inductance for

- 10-15-20-40-80 meters
- 6 pvc stand-offs, 4 for condensers and 2 for inductance
- 1 HD switch for band catching 10 thru 80 meter coverage
- 1 pkg 12-gauge tinned round wire. Cabinet included—Apollo "Shadow Boxes" M Kit includes schematic. Recommend parts layout. INFO NOTE *377 OHM and **600 OHM "Open wire spaced ladder line" air dielectric. *53 x wire diam. **84 x wire diam. Info only—not supplied.

apollo products ✓ A68 **Box 245, Vaughnsville, Ohio 45893**
419-646-3495

Subsidiary "Little Giant Antenna Labs"

Happiness is a DMM Kit

— Sabtronics makes a gem

John M. Blalock W7AAY
3054 West Evans Drive
Phoenix AZ 85023

I'm sure I wasn't the only one to wonder if Sabtronics'* full-page ads, in color no less, could be for real. However, being in need of a good digital multimeter and liking the specs as well as the price, I placed my order. This article will share with the reader what I received.

*Sabtronics International, Inc.,
PO Box 64683, Dallas TX 75206.

The Model 2000 is a compact integrated circuit digital multimeter. It has five ac or dc voltage ranges, 100 millivolts to 1000 volts, with 100% overrange capability (the 10-volt range, for example, allows measurement and display of up to 19.99 volts). Current ranges, rare on a DMM, are 10 microamps to 1 Amp (1.999 max.). Resistance ranges are from 100 Ohms to 10 megohms. It has 10-megohm input impedance on the voltage ranges and overload protection on all ranges.

All of these features are housed in an attractive blue high-impact plastic case which is only 8" wide x 6½" deep x 3" high and weighs just 2¼ pounds including four "C" batteries (not supplied). Accessories available from Sabtronics include test leads, an external dc power kit that requires 8½ to 15 V dc, an ac adapter, an ac true rms kit, and nicad batteries for use with the ac or dc external power adapters.

Like most inexpensive VOMs, VTVMs, and DMMs on ac, the Model 2000 is average sensing but displays rms values which are correctly calibrated only for sine wave signals. The \$26.95 true rms kit makes this DMM true rms sensing up to 100 kHz. In my applications, I don't need this upgrade and no evaluation of it is included herein. The Model 2000 only draws 120 mA from its power source. Four alkaline C batteries will power it for about 25 hours, typically. I haven't tried the nicads and ac adapter yet, either. Twenty-five hours is a lot

of measuring.

Other than the batteries, input jacks, and displays, all parts are mounted on one single-sided PC board. The FND359 displays are on a small 1" x 3½" board which is mounted behind the front panel. The display board connects through ribbon cable to the main 6½" x 4¼" board. This board contains the 9-push-button selector switch, seven integrated circuits, 58 resistors, 20 capacitors, 12 diodes, 4 transistors, and several other miscellaneous parts. The board comes solder-plated with a solder mask on the circuit side and component marking on the component side. All parts are of good commercial quality. Included on the board is a calibrated voltage reference IC and four premeasured resistors to be used for self-calibration. Sockets are provided for these parts so that the heat of soldering will not change their value. Sockets are not provided for the other ICs but are recommended.



Sabtronics' assembly and operation manual has obviously been influenced by Benton Harbor. While not in the same league with the Benton Harbor product, it doesn't fall far behind. The step-by-step instructions could only be improved by better pictorials. The excellent component marking on the PC board made up for the only fair pictorials. Total construction time including calibration took me less than six hours.

The solder mask was a big help in preventing solder bridges which would otherwise be hard to prevent on the tightly-packed board. My kit worked as soon as power was applied, attesting to the quality of the parts and ease of construction. The manual does contain enough theory of operation to help locate any problems that may occur.

The self-calibration

capability of the Model 2000 is one of the most impressive features of the kit, in my opinion. There are eight variable resistors that must be set to calibrate all of the different ranges. This can be done without additional test equipment, using only the pre-calibrated parts and the instructions provided by Sabtronics.

After calibrating the DMM per the self-calibration instructions, I compared its readings with those of a recently calibrated Fluke 8100A DMM. The mean dc voltage difference was 0.07%, Ohms was 0.32%, and ac volts was 2.9%. No comparison was made on the current ranges since the expensive Fluke has no current ranges like my "cheap" Sabtronics 2000 does.

Sabtronics also provides complete calibration in-

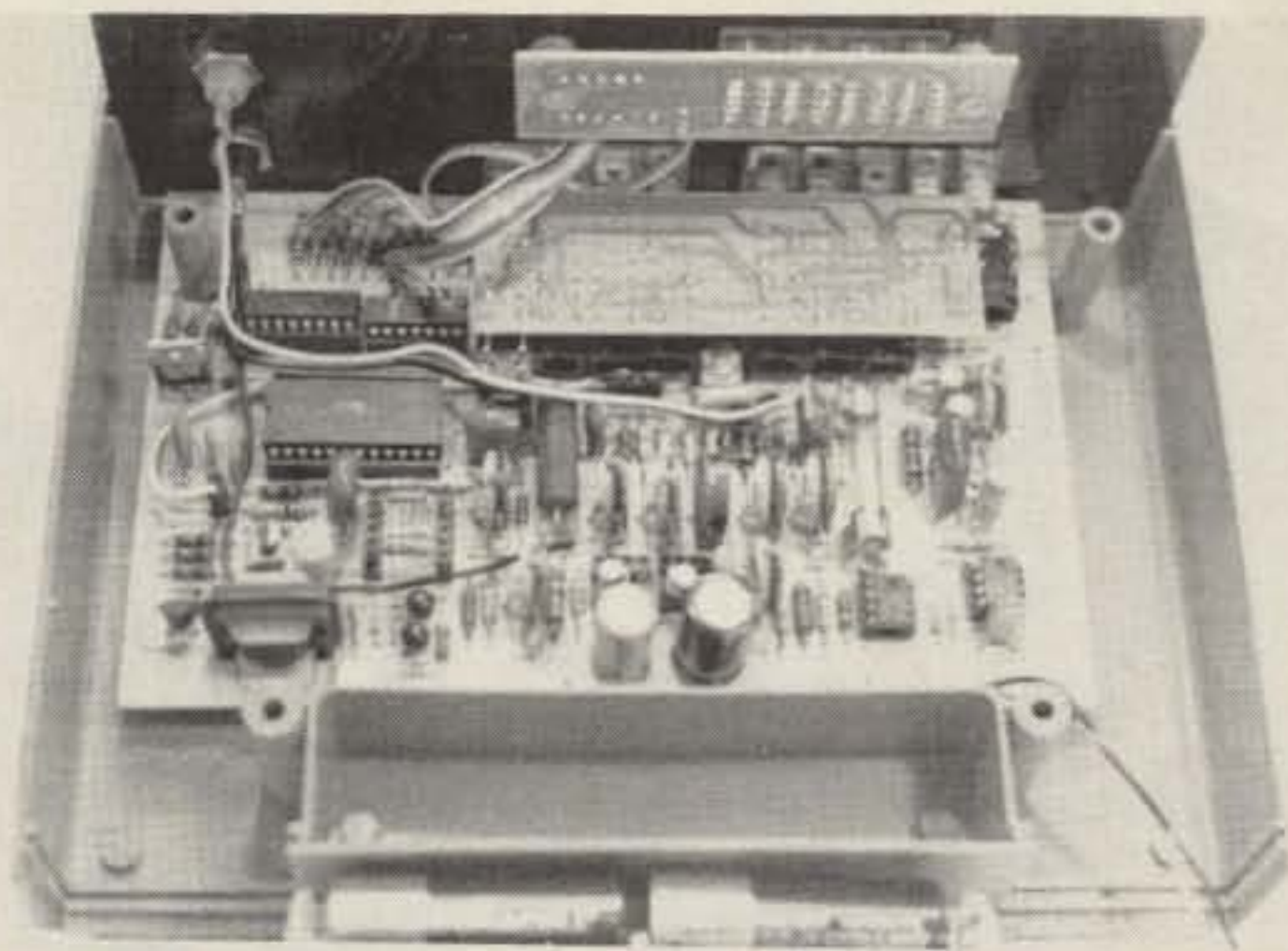

Inside the Model 2000.

structions for use with external equipment such as might be found in a calibration laboratory. They only guarantee their published accuracy if this calibration procedure is used. Following this procedure using the Fluke 8100A only reduced the difference in ac voltage readings. The dc volts and Ohms mean differences increased slightly.

No wonder I think their self-calibration procedure is one of the best features!

The DMM went together easily due to the quality parts, boards, and instructions. It worked right off with no problems. I now have a very nice professional-quality digital multimeter which I obtained for only slightly more than \$60. ■

ASTRAL ELECTRONICS CORP. ✓ A63
321 PENN. AVE., P. O. BOX 707, LINDEN, NEW JERSEY 07036 • (201) 486-3365
TUBES • SEMICONDUCTORS • IC'S • LED'S
IF YOU DON'T SEE IT, SEND A BASE AND WE WILL QUOTE

| PRIME QUALITY | | TUBES • SEMICONDUCTORS • IC'S • LED'S | |
|----------------|----------------|---------------------------------------|----------------------------------|
| FAIRCHILD | 2N5589 | 4.52 | 4.400C |
| VNF Prescaler | 2N5590 | 5.26 | 4.1000A |
| Chips | 2N5591 | 10.23 | 4CX250B |
| 95H900C | 2N5591 | 1.70 | 6CW4 |
| 95H910C | 2N6080 | 5.35 | 7F7 |
| 11C01FC | 2N6081 | 8.40 | 7N7 |
| 11C05DC | 2N6082 | 10.90 | PL172A |
| 11C06DC | 2N6083 | 10.90 | 572B |
| 11C24DC | 2N6084 | 12.25 | 807 |
| 11C44DC | 2N6084 | 5.70 | 811A |
| 11C58DC | 2N6095 | 8.50 | 812 |
| 11C70DC | 2N6096 | 10.35 | 866A |
| 11C83DC | 2N6097 | 13.85 | 1625 |
| 11C90DC | Tubes | Price | 5894 |
| 11C91DC | 3.400Z | 57.90 | 6146B |
| RF Transistors | 3.500Z | 57.90 | 6360 |
| 2N287E | 3.1000Z | 159.90 | 6882B |
| 2N327E | 3CX1000A7 | 299.00 | 7084 |
| 2N355J | 3CX1500A7 | 350.00 | 7586 |
| 2N386G | 4.125A | 41.50 | 7587 |
| 2N392E | 4.250A | 52.00 | 7788 |
| 2N447 | 4.400A | 54.90 | 7984 |
| 85.95 | 8072 | 42.00 | BRIDGE |
| 189.75 | 8122 | 54.90 | Rectifier |
| 27.50 | 8236 | 21.50 | 10AMP 50V |
| 4.75 | 8283 | 299.00 | 10AMP100V |
| 18.50 | 8295 | 325.00 | 10AMP200V |
| 18.50 | 856DAS | 52.00 | 10AMP400V |
| 325.00 | 8643 | 87.50 | 10AMP600V |
| 27.50 | 8877 | 350.00 | 25AMP 50V |
| 4.50 | 8908 | 5.20 | 25AMP100V |
| 10.75 | 8950 | 4.75 | 25AMP200V |
| 17.90 | SOCKET | 25AMP400V | 2.95 |
| 3.90 | Systems | 25AMP600V | 4.25 |
| 6.90 | SK506 | 5.00 | HYBRIDS |
| 34.50 | SK700 | 105.00 | AH0014CD |
| 6.10 | SK800B | 108.00 | DH0006CH |
| 4.70 | HEAT Sinks | Price | LH0002CN |
| 5.20 | HR-5 | 4.70 | LH0021CK |
| 64.90 | HR-7 | 4.70 | LH0032CG |
| 7.50 | HR-8 | 4.70 | LH0033CG |
| 9.50 | HR-10 | 4.70 | LH0041CJ |
| 13.95 | CAR CLOCK | Price | LH0042CD |
| 6.95 | MA1003 | 16.55 | LH0042CH |
| 6.50 | 8080A | 6.50 | VERBATIM DISKETTES |
| 16.50 | 8090 | 16.50 | Price for: 1.9 10 5000 |
| 24.95 | 8100 | 24.95 | MD5201 1 Sector 4.40 4.20 280 |
| 3.90 | 8102A | 3.90 | MD5210 10 Sector 4.40 4.20 280 |
| 7.25 | 8102B | 7.25 | MD5216 16 Sector 4.40 4.20 1702A |
| 7.00 | 2708 | 2.05 | MINI FLOPPY DISKETTE |
| 13.00 | 2114 | 3.65 | DRIVE Price 1 3 2114 |
| 1.70 | 4116/4160 | 1.95 | SHUGART |
| 115.00 | SN7489N | 2.25 | SA400 |
| 4.80 | TR580* M 16K | 2.50 | Miscellaneous |
| 4.80 | Expansion Kit | 2.95 | Teletype Paper |
| 4.80 | CLOCK CHIPS | 4.25 | P4005 Intel 1/0 |
| 3.45 | MM5309 | 5.00 | Control Chip |
| 3.00 | MM5311 | 10.25 | MINI OSCILLOSCOPES |
| 3.50 | MM5312 | 7.70 | NLS MS-15 |
| 3.90 | MM5313 | 6.70 | MS 215 Dual Trace |
| 3.90 | MM5314 | 6.70 | MICRO PROCESSORS |
| 2.50 | MM5316 | 24.50 | KIM 1 |
| 3.90 | MM5375 | 20.40 | Power Supply |
| 120.00 | RF DIRECTIONAL | 11.50 | KIM 1 & Power Supply |
| | WATTMETERS | 6.50 | VIM 1 |
| | Price | 5.30 | VIM 1 & Power Supply |

FREE CATALOG WITH ORDER — WE PAY POSTAGE
SEND STAMP FOR FREE CATALOG
N.J. RES. ADD 5% SALES TAX - MINIMUM \$10.00
VISA & MASTER CHARGE ACCEPTED

HIGH PERFORMANCE PRE-AMP FOR OSCAR

Model 201-29 \$2995

Low Noise • High Gain Pre-Amp For 29 MHz.

- 35 to 40 dB power gain at 29 MHz with a noise figure of only 2.0 dB and a bandwidth of 1 MHz.
- Makes reception of OSCAR possible even with low cost receivers or old receivers with poor sensitivity at 29 MHz.
- Two RF stages using dual-gate MOSFETS
- Manual gain control and provision for AGC
- Requires 12 volts DC at 10 mA.

See our other products in the full page ad of the Jan. '78 issue or write for catalog sheet. For immediate shipment call (212) 468-2720 or mail your order with payment plus \$1.00 for air mail to:

VANGUARD LABS • 196-23 Jamaica Ave. • Hollis NY 11423 ✓ V1

CHRISTMAS SPECIALS

WILSON WV-1 VERTICAL ANTENNA 10 THRU 40 METERS 62.95

WILSON TELESCOPING TOWER MT-61 540.00

WILSON ROTATING BASE RAISING FIXTURE FOR MT-61 329.00

WILSON CRANK-UP TOWER GUYED 64 FT. SST-64 324.00

WILSON CONCRETE BASE ROTATING FIXTURE FOR SST-64 145.00

WILSON GUY KIT FOR SST-64 TOWER 104.00

All items FOB Reynoldsburg, Ohio
These prices limited to items in stock and subject to prior sale.
Master Charge and VISA accepted

universal amateur radio inc
1280 AIDA DRIVE
COLUMBUS, OHIO
(Reynoldsburg, 43068)

(614)-866-HAMS

Vintage Receiver Mods

— new life
for hamfest bargains

Neil Johnson W2OLU
74 Pine Tree Lane
Tappan NY 10983

There are many serviceable older receivers around the ham scene. These are often available at prices much lower than new equipment of comparable quality. However, the typical ham often shies away from such offerings. Aside from i-f alignment (and possibly new electrolytics), the greatest problem seems to be tube replacements. If you take a look at a fairly recent parts catalog, some of the prices may startle you.

There are several different ways to cope with

such a situation, especially in the less critical stages. Example: I keep an old SX25 receiver around—it has general coverage—and my first conversion was to replace the rectifier tube with two silicon diodes. Fig. 1 shows the circuit for this changeover. You can buy a kit from Meshna¹ for one dollar or make up your own. The kit contains an octal tube base—very convenient, no wiring change required. I've been using this setup for several years with no complaints. With respect to the audio section, the 6F6 output tubes can be replaced with others of like ilk, e.g., 6V6 or 6K6, or you might leave out one of the push-pull pair of tubes, with little or no effect on CW or SSB signals. I was lucky to have a few spares around, but when they go, I plan to disconnect the idle 5-volt winding from the rectifier socket and feed it into a

cheap bridge rectifier and filter circuit. This ought to furnish more than enough power for a solid state audio module.

Tubes of the 6H6 or 6SQ7 type can be replaced, diode for diode, by the ubiquitous 914 or similar type solid state devices. But if you still insist upon hanging in with vacuum tubes, try types 6AL5 or 6AV6, both miniature types (7-prong sockets) electrically equivalent and much easier to come by than octal types. Type 6J5 in the bfo stage can be replaced by a 6C4 miniature, or, for the ultimate in economy, try the 1626 from the Command rigs. They work okay at 6.3 volts, but they take a little longer to heat up and should last forever.

In the more critical i-f and rf sections, I substituted 717A tubes for the 6SK7s. Essentially a 6AK5

with octal base, they cost only 25¢ at G & G,² so I purchased ten, just to be on the safe side. I took a look at the 6K8 converter tube and decided to leave it as is, mainly because of the rat's nest I found under the socket.

If the foregoing has not convinced you of the possibility of certain easy modifications, and you still want to re-tube all the way, there are several sources for economy-minded purchasers. In addition to the aforementioned G & G, you might do well to try Fair Radio.³ In the most recent catalog, they had well over 400 different types of tubes available, all at fairly low prices. ■

References

1. Meshna, Box 62, East Lynn MA 01904
2. G & G Radio Supply Co., 45 Warren Street, New York NY 10007
3. Fair Radio Sales, 1016 East Eureka Street, Lima OH 45802

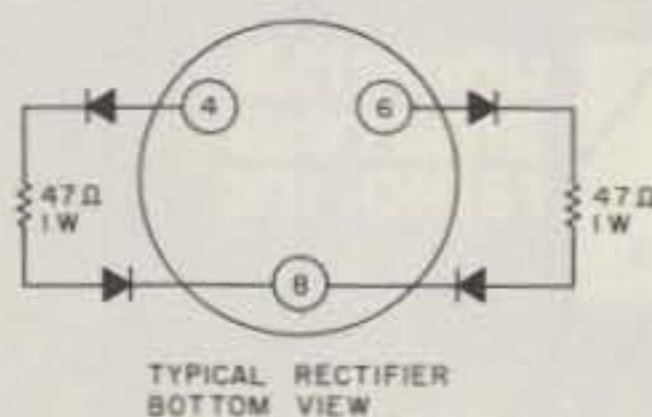

Fig. 1.

DSI Instruments Inc.

Performance You Can Count On



MODEL 3550W
\$149.95
INCLUDES TCXO \pm 1 PPM



MODEL 3600A
\$199.95
INCLUDES OVEN TIMEBASE \pm .5 PPM

MODEL 3240HH
\$119.95
BATT. OPERATED



The 3600A, 3550W and 3240HH Frequency Counters represent a significant new advancement, utilizing the latest LSI Design... which reflects DSI's ongoing dedication to excellence in instrumentation, for the professional service technician and amateur radio operator. Before you buy a DSI instrument you know that the specification is. We publish complete and meaningful specifications which state accuracy over temperature and sensitivity at frequencies you need. And we guarantee those specifications in writing. **JOIN THE RANKS OF THOUSANDS OF SATISFIED CUSTOMERS. PLACE YOUR ORDER TODAY AND BE THE ONE ON FREQUENCY.**

DSI — GUARANTEED SPECIFICATIONS — MADE IN U.S.A.

| Model | Frequency Range | Accuracy Over Temperature | @150MHZ | @250MHZ | @500MHZ | Number Of Readouts | Size Of Readouts | Power Requirements | Size |
|--------|-----------------|----------------------------|---------|---------|---------|--------------------|------------------|--------------------------|---------------------|
| 3600A | 50HZ-600MHZ | OVEN .5PPM 50° to 100°F | 10MV | 10MV | 50MV | 8 | .5 inch | 115VAC or 8.2-14.5VDC | 2 7/8"H x 8"W x 5"D |
| 3550W | 50HZ-550MHZ | TCXO 1PPM 65° to 85°F | 25MV | 25MV | 75MV | 8 | .5 inch | 115VAC or 8.2-14.5VDC | 2 7/8"H x 8"W x 5"D |
| 3240HH | 2MHZ-250MHZ | 3PPM 65° to 85°F | 100MV | 100MV | NA | 7 | .4 inch | 4AA Batt. | 5"H x 3"W x 2"D |

**ALL UNITS ARE FACTORY ASSEMBLED,
TESTED AND CARRY A FULL 1 YEAR WARRANTY.**

See Your Dealer
OR

Call Toll Free (800) 854-2049 DSI Instruments, Inc.

California Residents, Call Collect (714) 565-8402

VISA • MC • AMERICAN EXPRESS • CHECK • MONEY ORDER • COD

7914 Ronson Road, No. G, San Diego, CA 92111

• NO EXTRA COSTS •

FREE Shipping anywhere in U.S.A. & Canada. All other countries, Add \$10.00.

Strongest warranty in the counter field.

ONE YEAR Parts and Labor

Satisfaction Guaranteed.

Deep, Dark Secrets of the TR-7500

— exposing hidden talents

Kenwood's TR-7500 is the kid brother of the more generalized TR-7400A synthesized 2 meter rig. The 44 pre-programmed frequencies of the 7500 cover most of the common repeater splits and simplex frequencies. The 15 kHz up-shift gives access to the "in-between" channels which are coming into use in some areas. So the 7500 is a fairly friendly rig as long as you are in

agreement with the Kenwood engineers on how a "normal" person will want to use it. And even if you get an occasional urge to do something "perverted," like using a repeater pair not sanctioned by the ARRL, the 7500 gives you six programmable channels to indulge your whims.

So we have here a rig which includes enough goodies to justify some interest, especially among

these of us who don't have enough coordination to twiddle all the knobs on a full-blown synthesizer while mobiling in rush-hour traffic. I decided the TR-7500 was well suited to my normal operation and that those occasional desires for extras were only brought on by an overdose of glossy full-color ads in 73.

After getting over the initial "high" of using a new rig, I began looking into the schematics to see how the rig worked. I was interested to see if I could bring out the digital synthesizer inputs to allow the use of thumbwheel switches to enter a frequency. This is indeed possible, but the inputs are 8 bits of straight binary (15 kHz per step) which don't lend themselves to direct frequency readout on BCD thumbwheel switches. However, in the process, I stumbled across an unbelievably simple modification which gives nearly the same

general frequency coverage, plus the ability to go "upside down" with just the flick of a switch!

The TR-7500 generates its "center" frequency and plus or minus 600 kHz offsets by diode switching one of three crystals into an oscillator. The final frequency is obtained by adding the synthesizer output to this base frequency. The three signals (X1, X2, X3) which control the selection of the proper crystal are inductively decoupled and filtered to make them true digital signals. These three inputs to the synthesizer board, along with two digital outputs which specify the transmit/receive mode of the transceiver (TS, RS), are described in Table 1. Also, Fig. 1 shows the use of these signals and the "TX Offset" switch in the unmodified TR-7500. This "normal" configuration provides simplex or a plus or minus 600 kHz offset for any of the "center" frequencies available.

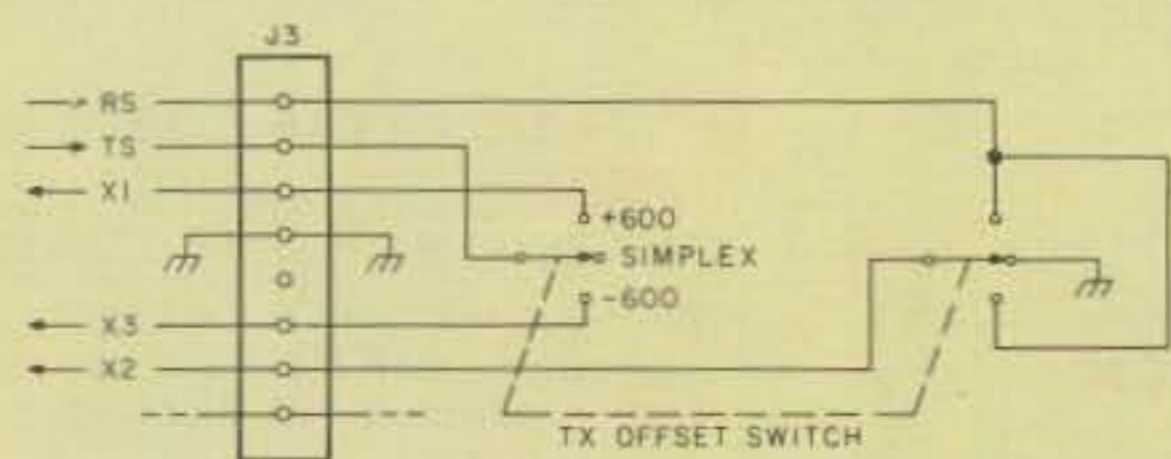
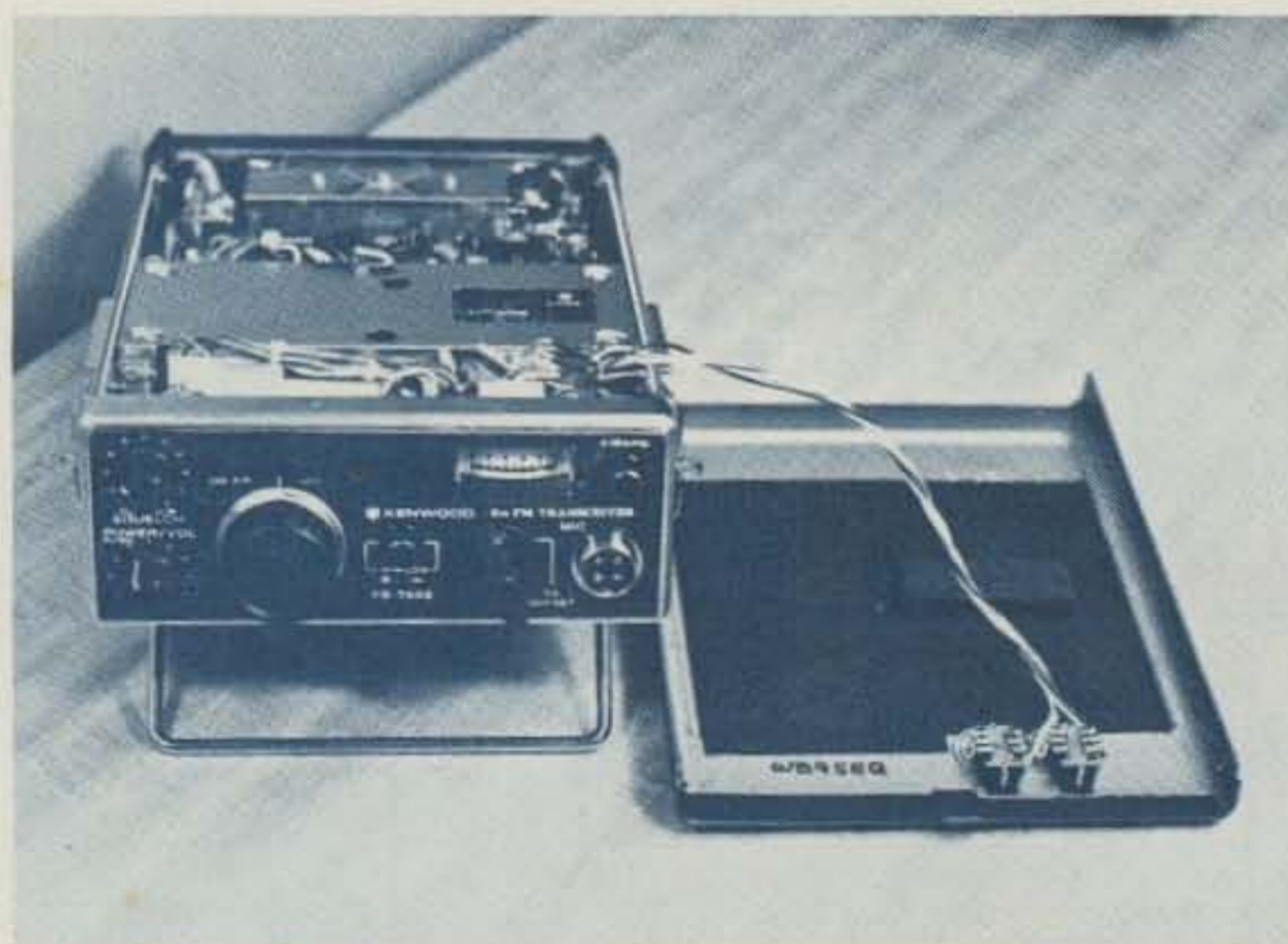

Fig. 1. Offset select circuit of unmodified TR-7500.

| Signal | Function When True* |
|--------|-------------------------------------|
| X1 | Select crystal for +600 kHz offset |
| X2 | Select crystal for center frequency |
| X3 | Select crystal for -600 kHz offset |
| RS | Transceiver is in RECEIVE mode |
| TS | Transceiver is in TRANSMIT mode |

*(True = zero volts, false = +9 volts or floating)

Table 1. Digital signals controlling frequency offset.

Hustler: The First Family of mobile amateur two meter antennas!

None can come close to us on the road. The Hustler family has a strong tradition of quality. Our performance gives you everything you want including maximum range, improved gain and better SWR at resonance.

Ours' is a lasting tradition, too. Hustler antennas are made of only the finest stainless steel and chrome plated components. So you get longer service life.

Quality. Performance. Dependability. Durability. It's all in the Hustler family...the First Family of two meter mobile amateur antennas.*



BBLT-144A



CGT-144



HT-144



SPS-144

*Most models available in 1-1/4 meters.

Clearly the choice of those who know quality.

new·tronics corporation

15800 Commerce Park Dr. • Brookpark, Ohio 44142

The schematic in Fig. 2 shows the modification in a dashed box. It consists of inserting two DPDT switches in the RS and TS signal lines. Actually, a 2-pole, 3-position switch would be more suitable, but I was unable to find one small enough to fit in the available space inside the case. I found that a pair of miniature slide switches (Radio Shack 275-327) with the lugs bent out to the sides fit nicely in a space just above the main frequency selector switch. A piece of card stock or mylar may be necessary to prevent contact between the components. The RS and TS signals are available at connector J3 on the top side behind the meter. The two signal wires are cut and the four ends spliced to an eight-inch pigtail coming from the switches mounted on the top cover. The pigtail also contains a ground wire

which runs from switch S1A to the frame of the rig. After finding the right size modification took less than two hours to install.

When S1 and S2 are in the off (normal) position, or the "TX Offset" switch is set for simplex, everything functions just as Kenwood intended. Switching S1 on forces the rig into simplex at the selected offset frequency. On a repeater, this is equivalent to receiving direct while still transmitting through the machine. With S1 off and S2 on, the transmit and receive frequencies are

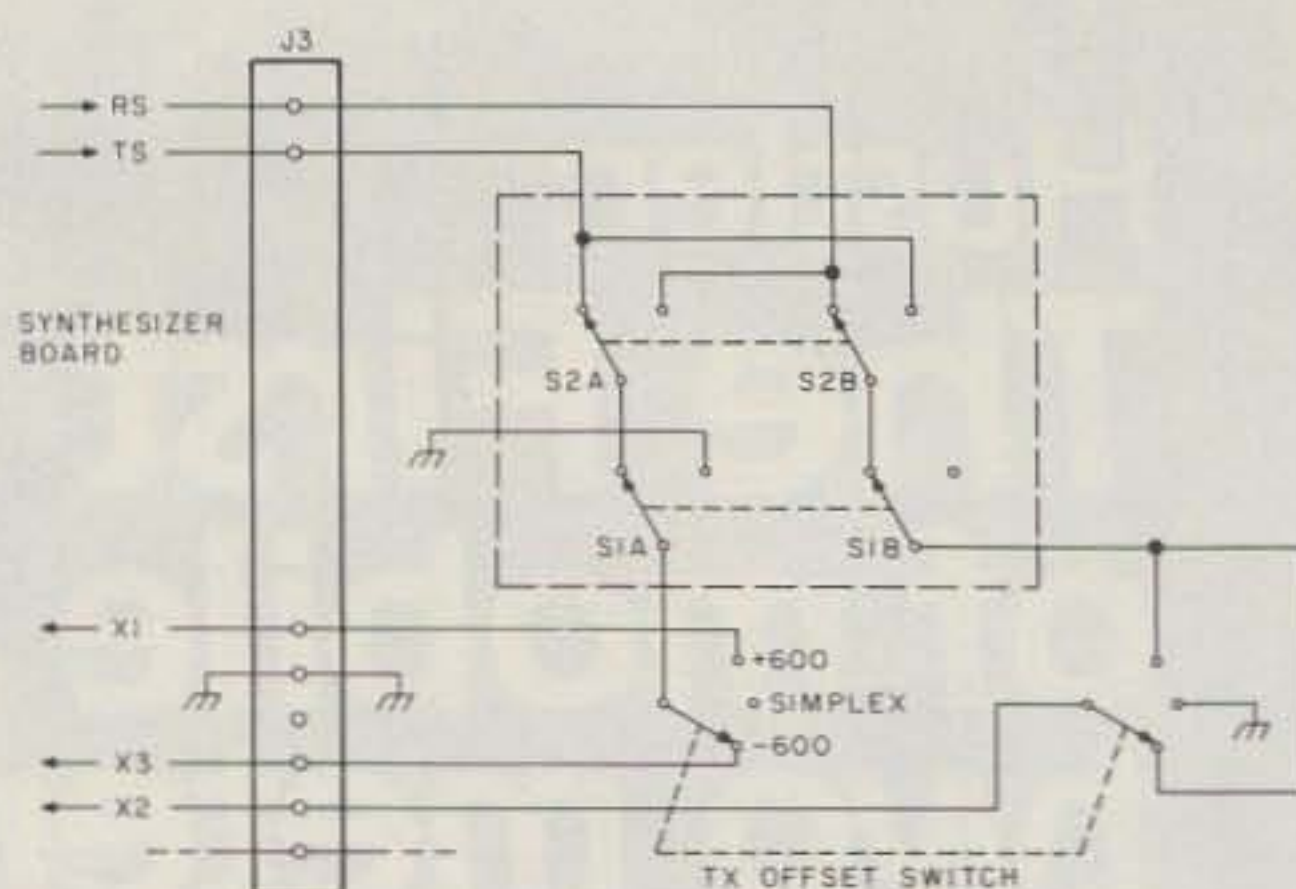

Fig. 2. Offset select circuit with modification in dashed box.

swapped to go completely upside down. The effects of various switch combinations are shown in Table 2.

The simplicity of this capability might well be envied by owners of many generalized synthesizers. ■

| S1 | S2 | Recv. Freq. | Xmit Freq. | Operating Mode |
|-----|-----|-------------|------------|-------------------------|
| Off | Off | Center | Offset | Normal |
| On | Off | Offset | Offset | Simplex at offset freq. |
| On | On | Offset | Offset | Same as above |
| Off | On | Offset | Center | Upside down |

Where: "Center" is the displayed frequency

"Offset" is the displayed frequency plus or minus the offset selected by the "TX Offset" switch

Table 2. Effect of switch settings on operating mode.

The **ONLY** thing you need to know about

Quartz Crystals

is: **1-405-224-6780**

• Best delivery plus Emergency Service with Guaranteed Delivery

• Highest Quality with gold MIL-C-3098 Process

• Ask for Sentry Technology Manual

And, order Toll Free 1-800-654-8850

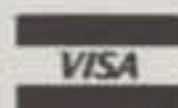

SENTRY

✓S3 Crystal Park
Chickasha, Oklahoma
73018

ALL BAND TRAP ANTENNAS!



PRETUNED - COMPLETELY ASSEMBLED - ONLY ONE NEAT SMALL ANTENNA FOR UP TO 6 BANDS! EXCELLENT FOR CONGESTED HOUSING AREAS - APARTMENTS LIGHT - STRONG - ALMOST INVISIBLE!

FOR ALL MAKES & MODELS OF AMATEUR TRANSCEIVERS - TRANSMITTERS - GUARANTEED FOR 2000 WATTS SSB 1000 WATTS CW. FOR NOVICE AND ALL CLASS AMATEURS!

COMPLETE AS SHOWN with 90 ft. RG58U-52 ohm feedline, and PL259 connector, insulators, 30 ft. 300 lb. test dacron end supports, center connector with built in lightning arrester and static discharge - molded, sealed, weatherproof, resonant traps 1"X6" - you just switch to band desired for excellent worldwide operation - transmitting and receiving! WT. LESS THAN 5 LBS.

160-80-40-20-15-10 bands 2 trap --- 138 ft with 90 ft. RG58U - connector - Model 777BU . . . \$54.95
80-40-20-15-10 bands 2 trap --- 102 ft. with 90 ft. RG58U - connector - Model 998BU . . . \$49.95
40-20-15-10 bands 4 trap --- 54 ft. with 90 ft. RG58U coax - connector - Model 1001BU . . . \$48.95
20-15-10 bands 2 trap --- 26 ft. with 90 ft. RG58U coax - connector - Model 1007BU . . . \$47.95

SEND FULL PRICE FOR POST PAID INSURED DEL. IN USA. (Canada is \$5.00 extra for postage - clerical - customs - etc.) or order using VISA Bank Americard - MASTER CHARGE - AMER. EXPRESS. Give number and ex. date. Ph 1-308-236-5333 9AM - 6PM week days. We ship in 2-3 days. PRICES MAY INCREASE SO - ORDER NOW AND SAVE! All antennas guaranteed for 1 year. Money back trial! Made in USA. FREE INFO AVAILABLE ONLY FROM.

WESTERN ELECTRONICS ✓W18 Dept. A7-11

Kearney, Nebraska, 68847

...at last - your shack organized!

\$12995 S-F RADIO DESK Deluxe - Ready to Assemble

Designed with angled rear shelf for your viewing comfort and ease of operation.

FINISHES: Walnut or Teak Stain.
Also available in Unfinished Birch, \$114.95.

Additional Information on Request.

Checks, Money Orders, BankAmericard and Master Charge Accepted.

25% Down Required with C.O.D. Orders.

F.O.B. Culver City. (In Calif. Add 6% Sales Tax.)



WA6BRR
WB6OYO

Floor Space:
37" Wide
30" Deep

Radio equipment not included

A beautiful piece of furniture — your XYL will love it!

S-F AMATEUR RADIO SERVICES

4384 KEYSTONE AVENUE ✓S7

CULVER CITY, CALIF. 90230

FT-901DM

- BOARDS INSIDE CABINET**
- 1 CARR OSC unit
 - 2 VOX unit
 - 3 AF unit
 - 4 IF unit
 - 5 Filter unit
 - 6 Noise Blanking/RF Processor
 - 7 Rectifier unit
 - 8 Rectifier unit
 - 9 Power XFMR
 - 10 Final Amplifier unit
 - 11 VCO unit
 - 12 TUNE control
 - 13 PLL unit
 - 14 RF unit
 - 15 Counter Display unit
 - 16 FM unit

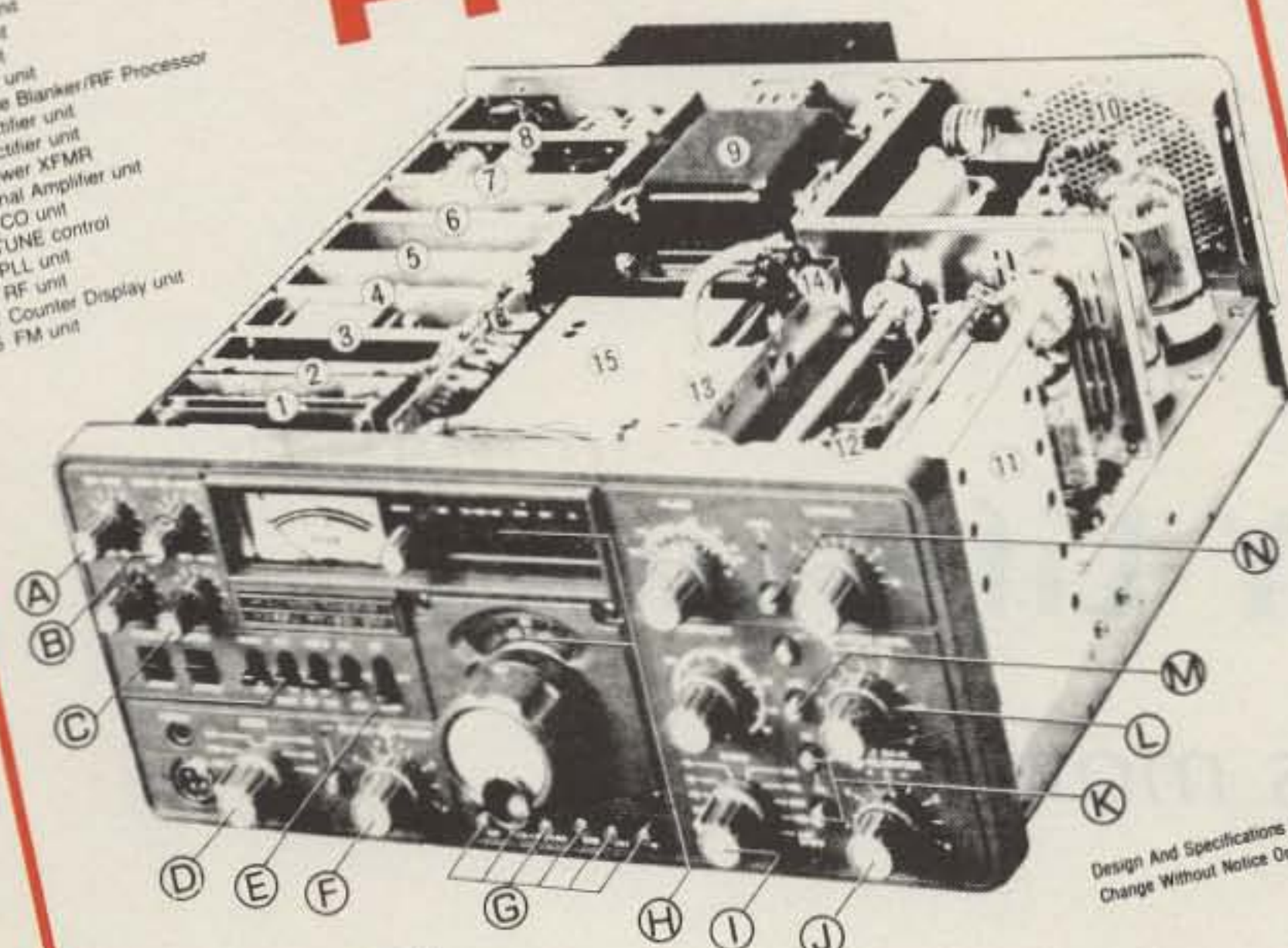

Design And Specifications Subject To Change Without Notice Or Obligation

FRONT PANEL CONTROLS

- A Vox gain
- B Carrier level/keyer speed
- C Audio Peak Frequency system
- D MODE switch (SSB, CW, FSK, AM, FM)
- E Crystal calibrator/Noise blanker
- F Rejection tuning/variable IF passband tuning
- G Frequency memory system
- H Digital plus analog frequency readout
- I Band switch (160-10 meters - WWW/JJY receive)
- J Clarifier control
- K RX/TX Clarifier selector
- L RF Processor level
- M RF attenuator
- N TUNE control (Places transmitter in "TUNE" condition for ten seconds, then returns to "receive" condition to protect final tubes from excessive key-down time)

THE SYMBOL OF TECHNICAL EXCELLENCE
YAESU
The smart radio

YAESU ELECTRONICS CORP., 15954 Downey Ave., Paramount, CA 90723 (213) 633-4007
 YAESU ELECTRONICS CORP., Eastern Service Ctr., 613 Redna Ter., Cincinnati, OH 45215

JUST IN CASE YOU MISSED THIS YAESU AD

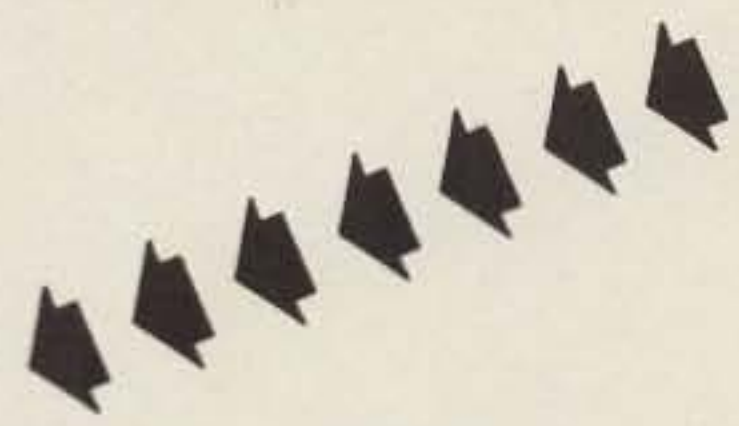

NOW . . . COMPARE THE FT-901DM SPECS WITH THE LEADING CONTENDER BRAND "X"

| | BRAND "X" | FT-901DM |
|-----------------------------|--------------------|------------------------------------|
| Digital Display | Option | Built-in |
| RF Speech Processor | Yes | Yes |
| Negative Feed Back On Final | Yes | Yes |
| 3rd Order Dist. Products | -35dB | -31dB |
| Harmonic Spurs | -40dB | -40dB |
| Input Power SSB | 200W (PEP) | 180W (DC) |
| Input Power-CW | 160W (DC) | 80W (DC) |
| RX Sensitivity | .25uV for 10dB S/N | .25uV for S/N 10dB |
| IF Shift | Yes | Yes |
| Rejection Tuning | No | Yes |
| MDS | ? | -137dB |
| Cross Mod Rejection | ? | Better than 80dB immunity at 20KHz |

| | BRAND "X" | FT-901DM |
|-----------------------------|------------|---------------------------|
| Dynamic Range | ? | 90dB |
| Desensitization | ? | Better than 90dB immunity |
| Variable IF Width | No | 2.4KHz to 300Hz |
| Keyer | No | Built-in |
| Audio Peaking Filter | No | Built-in |
| All Mode | No (No FM) | Yes |
| Memory | No | Yes |
| Provision for New Frequency | Yes | Yes |
| Modular Construction | No | Yes |
| Clarifier | Yes | Yes |
| DC Capability | Option | Yes Built-in |
| Automatic Mic Gain | No | Yes |
| Audio Frequency Peaking | No | Yes |

And—compare feature for feature with BRANDS "Y" and "Z" as well ... and you'll learn why you get more for your money with YAESU!

Design And Specifications Subject To Change Without Notice Or Obligation



YAESU
The smart radio

YAESU ELECTRONICS CORP., 15954 Downey Ave., Paramount, CA 90723 (213) 633-4007
 EASTERN SERVICE CTR., 9812 Princeton-Glendale Rd., Cincinnati, OH 45246



of 20 mA and 60 mA can be used. Diode 2 (D2) protects against accidental reversal of line polarity, and C2 provides immunity from noise on the line. Defeat switch "S" permits normal use of the teletypewriter terminal. The schematic of the power supply incorporates the transformer within the teletypewriter. This entire circuit can be built on a 3" x 3½" printed circuit board and installed.

Total parts cost is about \$20, and the unit pays for itself in just a few months. With the device installed, the power switch is left in the "on" position. The system software should be changed to send nonprinting characters to the operating teletypewriter 1 second before actual information output so that the motor can come up to operating speed. In a half-duplex system, hitting the

break key starts up the teletypewriter locally. For this feature to work in a full-duplex system, the software must echo the

break to the machine. Turn-off time delay can be changed as desired to avoid needless turn-on/turn-off cycles. ■

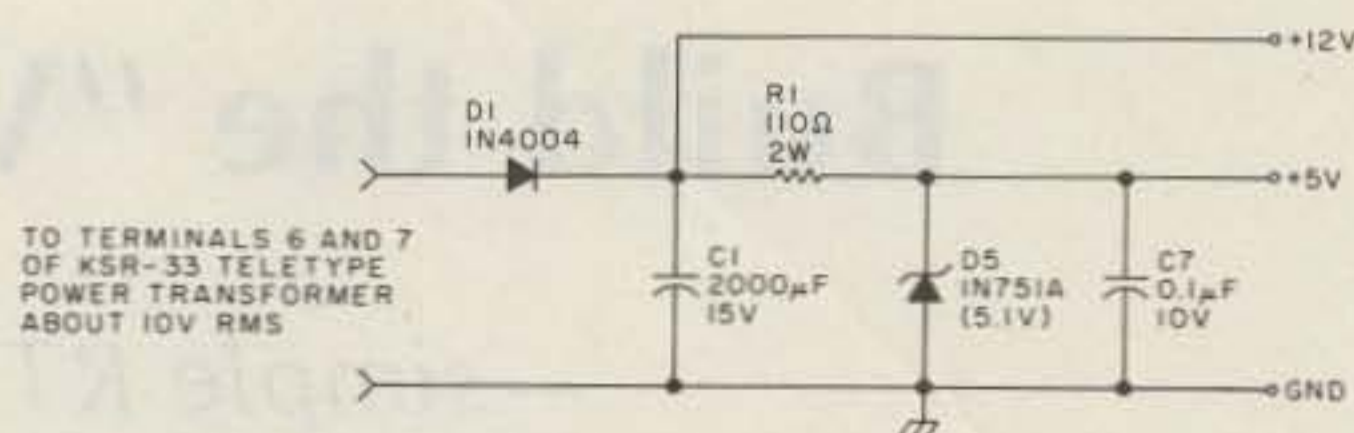

Fig. 2.

DX

from page 46

Committee that would require cards submitted for single-mode DXCC to show that the applicant both transmitted and received in the required mode. The result is that it is possible to earn a CW DXCC without making any CW-to-CW contacts. Just work them on SSB and get a quick report on your CW. This award is now recognized as the ARRL Half A—DXCC.

With the assistance of the YL SSB net at 14332, the FCC recently shut down the operation of W6GSM/mm aboard the sailing vessel *Summer Breeze*. It seems that Mr. Timothy J. Wenger had read about the use of amateur radio in a yachting magazine and found communications on the amateur frequencies to be more reliable. When confronted by the FCC, Mr. Wenger stated that he was never advised when he bought the equipment that a license was required for transmission. In view of Mr. Wenger's cooperative attitude, no recommendation toward criminal prosecution was made.

The August 8th issue of *TIME* magazine carried a very informative article about lobbying in Washington and what it takes to get legislation moving or government regulations affected. Write your ARRL Director about the need for League representation in Washington. The ban on ten meter amplifiers could have been stopped with effective lobbying.

Speaking of the ten meter amplifier ban, it seems that the responsible manufacturers of amateur radio amplifiers were the only ones who halted ten meter amplifier production. The manufacturers of illegal CB linears simply changed

from amplifiers to crystal-controlled, broadband amateur transmitters requiring four Watts drive. CBers simply use their CB transceivers as drivers instead of crystals. The result? Law-abiding amateurs lose their ten meter amplifiers while CBers continue to run illegal high-power amplifiers. The ARRL recently passed a resolution to notify the FCC of this practice.

12FGP made some 1400 QSOs during his recent 6O1FG stay. License documents have been forwarded to the DXCC desk for approval.

The YI1BDG staff ordered a copy of the Bill Orr W6SAI *Antenna Handbook* in an attempt to beef up the signal.

IRCs can generally be purchased at a considerable savings from some of the more active QSL managers like W3HMK or WA3HUP. Drop them a line with an SASE and inquire.

The long, drawn-out (read expensive) antenna tower case of N6QQ is still in the courts. The outcome of this case could very well set a legal precedent that will affect us all. Donations to help fight this suit are badly needed and can be forwarded via the Southern California DX Club, 28403 Covecrest Drive, Rancho Verdes CA 90274.

The FT-560 forwarded to YI1BDG by the Northern California DX Club has apparently been refused.

All Clipperton cards should be out by the time you read this. If yours is among the missing, try again to HB9MX. All other routes are closed.

The great days of DXing are upon us once again. Two years ago the smoothed sunspot number bottomed out at 12.2. The smoothed sunspot number is now pushing 120 and the flux is running around 140. Remem-

ber when the pessimists were predicting that cycle 21 would never break 100?

In the October column, we mentioned that amateur radio license renewals were averaging better than 17,000 a month. Late word out of Gettysburg puts the figure at closer to 29,000 per month. If you ever wanted to make a few bucks in the amateur radio market, now is the time. Write Wayne for 73's advertising rates.

Geoff Watts, 62 Belmore Road, Norwich NR7 OPU, England, is publishing a Radio Amateur Prefix and Country/Zone List that is almost indispensable for the serious DXer. Geoff will part with a copy for only \$1.00 American or 5 IRCs. If you live in the United Kingdom or understand the British monetary system, then it's only 40p.

If you hear a strange prefix and you are not sure of its origin, just look it up on the ITU callsign chart on the back of your ARRL logbook. If you don't use an ARRL logbook, then try the *Handbook*.

Congratulations to the new officers of the San Diego DX Club: President Glenn Rattman K6NA; Vice President Rick Craig N6ND; Secretary/Treasurer Al Gordon N6ZI.

The recent HZ1BS/8Z4 was royally operated by Prince Abdullah and Sheik Ahmed.

Seems that some of the 3.8 MHz contacts for the Clipperton operation never got transferred from the original logs. If you received a "not in log" note on your QSL, you might try resubmitting it.

If you have not yet joined the Northern California DX Foundation, you should consider doing so. Many of the recent major DXpeditions have been at least partly funded by this organization. These include the K5YY African swing, Desecheo, Clipperton, 4U1UN, and many others. The Northern California DX Foundation is totally non-

profit and you can receive more information by writing to Box 717, Oakland CA 94604.

ARRL growth continues, but not at the fantastic rate of last year. July membership was 167,000 with predictions of 180,000 by 1980.

According to HL9WI, some 700 Koreans recently passed the new amateur examinations.

JL prefixes are beginning to show from Japan. They are getting close to their ITU allocation which ends at JSZ.

A group of Arizona Gotrocks are negotiating to purchase Ambergris Cay in the Turks and Caicos Islands and set up their own government. They plan to issue passports, register corporations, and issue their own stamps and currency. This should convince the doubters that there will always be new ones to work. The offered price, by the way, is 50 million dollars. Expensive even for beachfront.

The Canadian Amateur Radio Federation News Service recently issued a notice to the effect that in addition to the CF for VE and CY for VO prefixes, DOC Canada had authorized the use of CF8 for VY1 in the Yukon Territory. These special prefixes may be used by Armed Forces Personnel either active, reserve, or retired to commemorate 75 years of Canadian Armed Forces communications.

Also on the Canadian front, the Canadian Interdepartmental Committee on WARC '79 has released a supplement to the second draft Canadian position proposals, issued last April. Good news is that the proposal to change the ITU Article 41, which would have permitted "no-code" amateur licenses, has been deleted. Bad news is that the proposal to remove 420-430 MHz and 3.8-4.0 MHz from the amateur service still stands. Amateur comments on an international pro-

Continued on page 224

Build the "Version Three"

— simple RTTY TU does it all

This article describes a RTTY TU designed specifically to drive electronic printers and video displays, including such devices as Baudot/ASCII converters. The TU features the following:

- Extremely good performance on weak and noisy signals.
- No external or internal power supply needed—all power is derived from the receiver audio and the local loop.
- Low-voltage local loop (as little as 8 volts and no more than 12). No high voltage to fry delicate TTL components or the owner thereof.
- High immunity to drift and mistuning.

In the design of TUs to drive mechanical teleprinters, there are numerous constrictions

which do not apply to a TU which is to be used with a Baudot/ASCII converter and TV typewriter. The mechanical printer must be driven with high voltage for good waveform. A solid state device requires no such high voltage. Mechanical printers cannot tolerate much telegraph distortion; solid state devices usually can tolerate quite a bit. Mechanical printers require good, clean square waves for proper operation. Solid state displays generally contain all kinds of internal devices which clean up any waveform problems.

The design philosophy behind TUs which drive mechanical printers is generally to create a big electronic toggle switch. The theory of such designs is that strong, clean pulses will flip the switch, while noise and QSB will not.

That theory is fine, but a price must be paid for such a design, and that price is poor performance on weak signals (because weak signals won't flip the switch). I have owned more than a dozen such TUs over the years, both home brew and military surplus, and none would make good copy on signals which drove the S-meter on my surplus Collins tank receiver to less than about the 20-dB mark. The TU to be described here will make good copy on signals which fall well below the 20-dB mark. In fact, when used with Jeff Roloff's Baudot/ASCII converter and TV typewriter ("ASCII/Baudot Converter for Your TVT," Jeff Roloff, 73, November, 1976), the TU will make legible copy on signals which won't even budge the meter.

Theory of Operation

Referring to the circuit diagram (Fig. 1), we see that two 88-mH toroids have been made into transformers by winding 50 turns of wire onto them, to serve as primaries (hint: don't try to count 50 turns; just wind 100 inches on each toroid). The 470-Ohm resistor in the input is just a precaution to prevent damage to the tuned circuits and diodes in case somebody accidentally turns up the receiver

volume to full blast; you may or may not need it with your receiver.

The .033 and .068 μF tuning capacitors must be paper or mylar, and preferably should be rated at 200 volts or better. Also, the coupling capacitor (.1 μF) should be paper or mylar. With the values of tuning capacitors shown, the higher tone (mark) will be 2975 Hz, and the lower tone (space) will be 2125 Hz, providing for a shift of 850 cycles. For 425 cycle shift, add .015 μF to the .033 μF capacitor. For 170 cycle shift, add an additional capacitance of about .007 μF . Actually, because the TU is capacity coupled, tuning is very un-critical, and you will find that you can copy 170 cycle shift easily with the tuned circuits set for 425 cycle shift just by straddling the signal. For very best weak signal performance, however, the circuits should be tuned exactly.

The tuned circuits drive diodes connected in a conventional double-tuned discriminator configuration. The discriminator drives a pair of Siliconix high-power MOS field-effect transistors. In the first two versions of this TU, I used only one FET in the output. This gives very good performance on

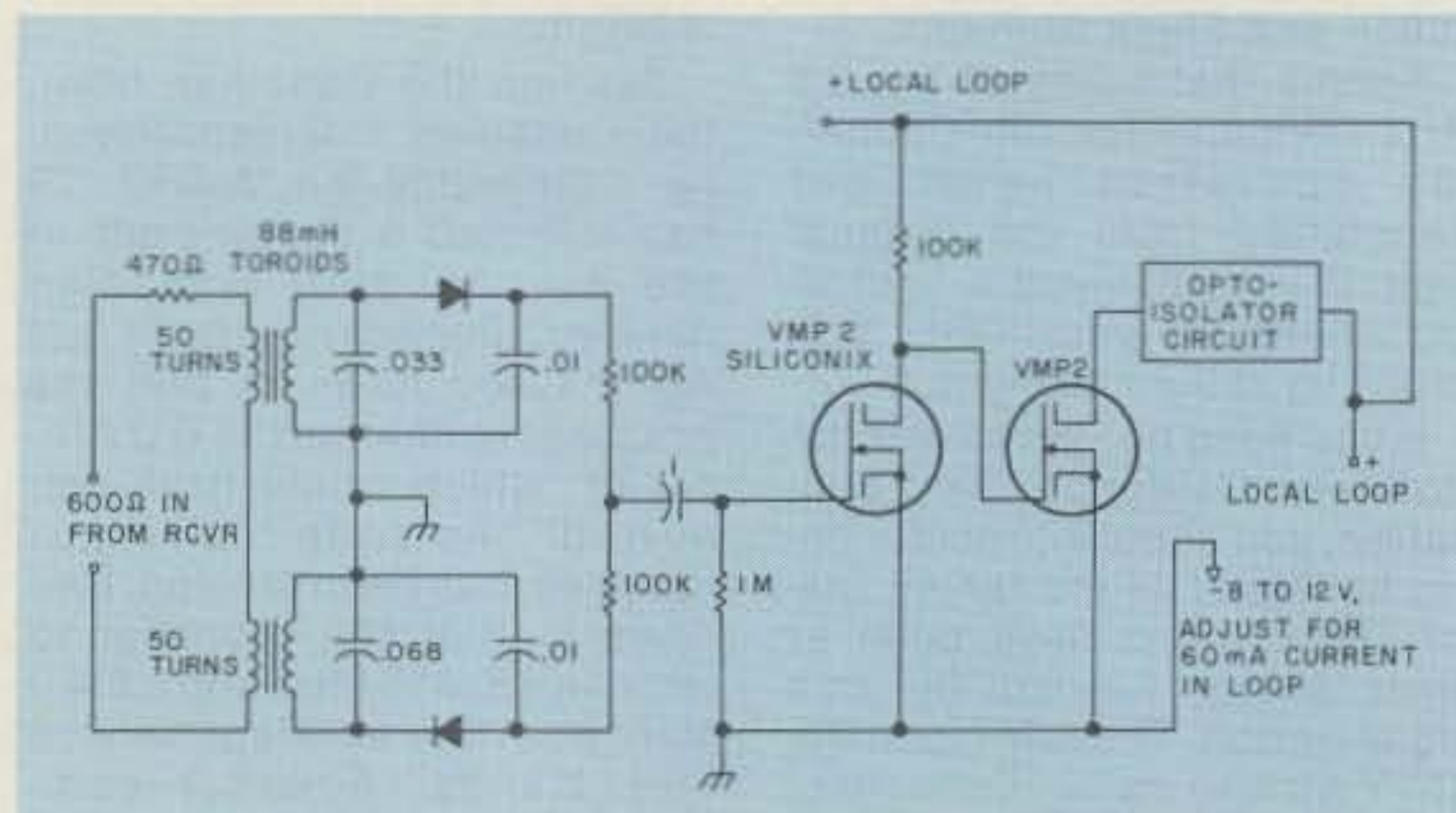

Fig. 1. RTTY TU for TV typewriters and Baudot/ASCII converters.



YAESU
The radio.



Is Our Number 1 Line At

C83

Cohoon Amateur Supply



TO SERVE YOU BETTER
3 LOCATIONS

SOUTH

307 McLeans Hopkinsville, KY 42240

502-886-4534

NORTH

Box 4073 Austintown, Ohio 44515

216-538-3424

WEST COAST

728 Juniper Lompoc VAFB, CA. 93437

805-734-4693



Also Stocking:

TEN-TEC
TEMPO
WILSON
INFO-TECH

KANTRONICS
ATLAS
DENTRON
CUSHCRAFT



Write For Used Equipment
Sheets and Catalog



taped RTTY, but is not satisfactory for reception of keyboard sending because the FET is normally off, so that during long pauses in keyboard transmissions the loop current will drop to zero, simulating a space, and the video display will print an error. By using two FETs, the circuit is normally on, and the pulses arriving from the 0.1 μ F coupling capacitor drive the local loop off.

My local loop consists of a variable bench supply, zero to 12 volts, adjusted for 60 mA loop current. You may wish to use a fixed supply, with an adjustment pot in series therewith. For a 12-volt supply, a 200-Ohm, 1-Watt carbon control should make an adequate pot. The optoisolator circuit is part of the Roloff Baudot/ASCII display which I'm using. Most other solid state displays are similar arrangements.

Construction and Availability of Parts

I constructed my unit on a piece of Radio Shack perfboard, the kind that plugs into a 22-pin edge connector. The toroids are bolted to the board with rubber faucet washers and nylon nuts and bolts (available from Radio Shack—the nylon nuts and bolts, I mean, not the faucet washers). Wiring is ordinary "rat's nest."

88-mH toroids can be purchased at SASCO Electronics, King Street, Alexandria, Virginia. They are not a regular mail-order house, but if you call them on the phone, you can probably get them to ship you a couple. The power FETs are available from Tri-Tek, Inc., 6522 North 43 Ave., Glendale, Arizona 85301. They are \$6.95 each, plus 40 cents extra for the specs (which you will need in order to figure out the lead configurations). This

company makes very prompt shipment, so that if you send in your order on Monday, you'll probably have the FETs by the following weekend. Specify that you want the type "VMP-2" FET. The tuning capacitors may present a problem. Try local TV jobbers. If that fails, you'll just have to scrounge around in the surplus stores.

Operation

Tuning of the TU may be monitored with a scope or you may insert an LED in the local loop to monitor the on and off pulses. On strong signals, the TU will make perfect copy, regardless of the setting of the receiver audio controls. However, when you are digging down in the noise for weak signals, which is the main function of this unit, careful setting of the receiver audio will pay off. If the receiver has a noise

limiter, you will usually find that you get better results with it turned off. On a weak and fading signal, set the receiver AVC to on and adjust the volume to the point where the display just begins to print. Then advance the control just a hair.

In connecting this unit to certain types of solid state equipment, such as a Frederick Electronics code converter, you may find that the equipment "locks up" and fails to print. This effect is caused by audio leaking through the circuits of the "Version III" and getting into the circuitry of the equipment which is being driven. The cure for this is to connect a 35 μ F capacitor directly across the printer output terminals of the "Version III." Don't use this capacitor if you do not need it; it will slightly degrade the weak signal performance. ■

LINEARIZED AMPS by LUNAR



INTRODUCING OUR NEW AMP MODEL 2M10-250P

- 3 watts in, 125 watts output.
- 10 watts in, 250 watts output.
- Linearized amp for SSB use.
- While many may not need this particular amp, Lunar has the capabilities to make it available. With Lunar, it's quality and performance first, then power.

LUNAR'S RECEIVING PRE-AMPS

These ultra performance receiving preamplifiers are suitable to the most demanding needs where low noise figure is important!

See a dealer or write Lunar for dealer list.

BI-LINEAR VHF MODELS

- Covers entire Amateur Band w/o Tuning
- Built-in Receive Preamplifier
- Automatic T-R Switching
- Exceeds FCC R&O 20777 Requirements of -60 dB
- Variable T-R Delay for SSB/CW use
- Preamp & Power Amp Independently Controllable
- Preamp nom 10 dB gain, 2 dB Overall NF
- Functionally Designed Package includes mounting lip

| MODEL | FREQUENCY (MHz) | POWER IN | POWER OUT | CURRENT | H | X | W | X | L | WT | PRICE |
|-------------|-----------------|----------|-----------|---------|----|------|--------|-------|----------|----|-------|
| 2M10-80P | 144-148 | 10W | 80W | 12A | 70 | 14.9 | 20.3cm | 1.0kg | \$189.95 | | |
| VHF 10-80P | 148-174(5 MHz) | 10W | 80W | 12A | 70 | 14.9 | 20.3cm | 1.0kg | \$229.95 | | |
| 1.3M10-70P | 220-225 | 10W | 70W | 11A | 70 | 14.9 | 20.3cm | 1.0kg | \$199.95 | | |
| 2M30-160P | 144-148 | 25W | 160W | 25A | 70 | 14.9 | 32.5cm | 1.6kg | \$249.95 | | |
| VHF 30-160P | 128-148(5 MHz) | 30W | 160W | 25A | 70 | 14.9 | 32.5cm | 1.6kg | \$289.95 | | |
| 1.3M30-140P | 220-225 | 25W | 140W | 23A | 70 | 14.9 | 32.5cm | 1.6kg | \$269.95 | | |
| 2M25-150P | 144-178 | 25W | 150W | 25A | 70 | 14.9 | 32.5cm | 1.6kg | \$249.95 | | |
| 2M10-250P | 144-148 | 10W | 250W | 40A | 70 | 14.9 | 42.0cm | 2.2kg | \$399.95 | | |

Models available for the 148-174 MHz bands, 5 MHz segments. Other models 50 thru 432 MHz bands plus higher power units out in near future.

Louis Anciaux
WB 6NMT



PRICES ON ALL LUNAR AMPS AND PRE-AMPS WILL BE INCREASED NOV. 15TH. ORDER NOW!

AMPLIFY CHRISTMAS

Vhf engineering
BLUE LINE AMPLIFIERS

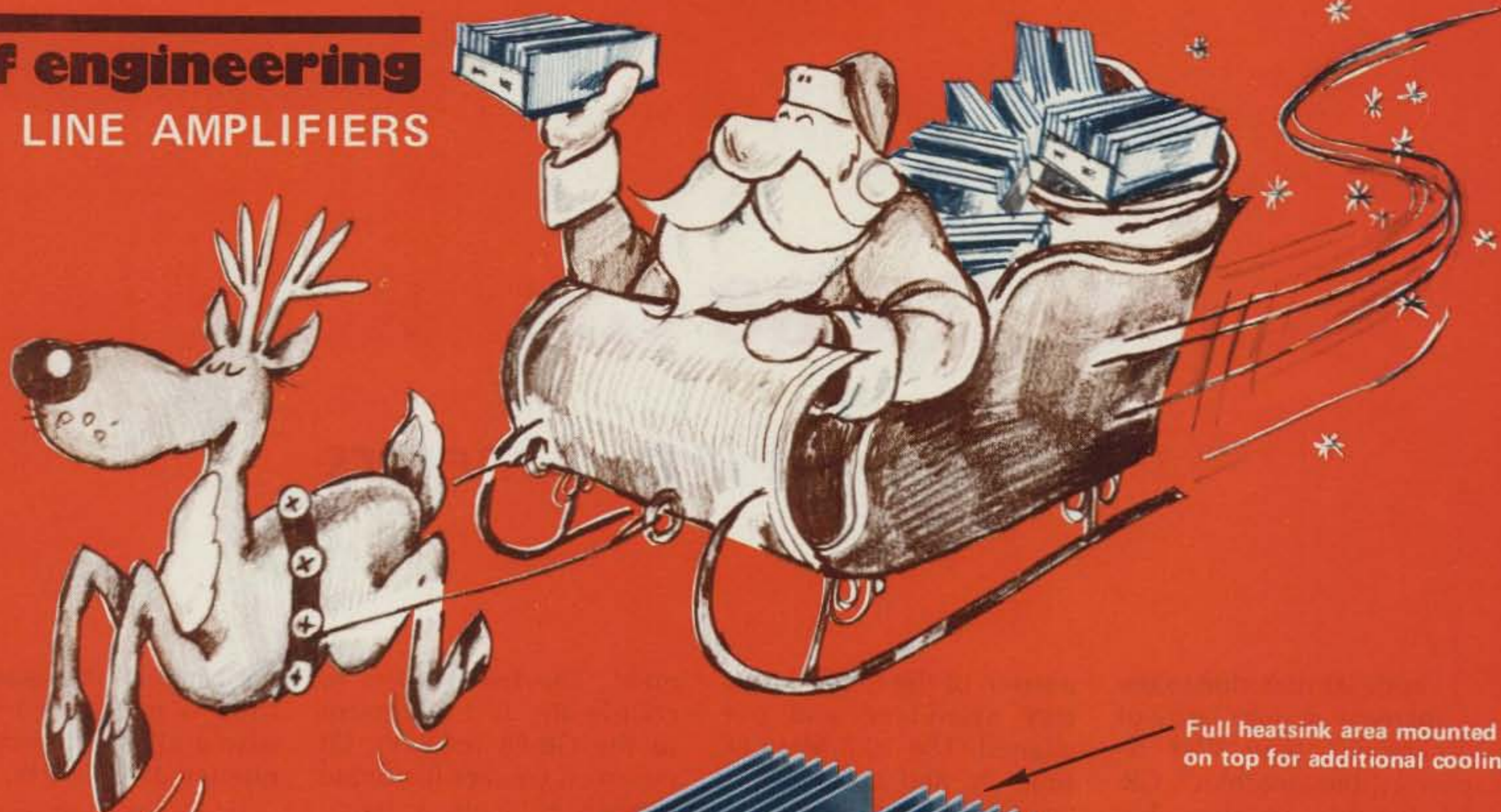

Attractive, blue anodized finish.

Full heatsink area mounted on top for additional cooling.

Rugged, one piece aluminum extrusion.

Designed for ease of mounting.

High quality power switch and mode switch on front panel.

| MODEL | BAND | EMISSION | POWER INPUT | POWER OUTPUT | WIRED AND TESTED PRICE |
|------------|---------|--------------|-------------|--------------|------------------------|
| BLC 10/70 | 144 MHz | CW-FM-SSB/AM | 10W | 70W | \$149.95 |
| BLC 2/70 | 144 MHz | CW-FM-SSB/AM | 2W | 70W | 169.95 |
| BLC 10/150 | 144 MHz | CW-FM-SSB/AM | 10W | 150W | 259.95 |
| BLC 30/150 | 144 MHz | CW-FM-SSB/AM | 30W | 150W | 239.95 |
| BLD 2/60 | 220 MHz | CW-FM-SSB/AM | 2W | 60W | 164.95 |
| BLD 10/60 | 220 MHz | CW-FM-SSB/AM | 10W | 60W | 159.95 |
| BLD 10/120 | 220 MHz | CW-FM-SSB/AM | 10W | 120W | 259.95 |
| BLE 10/40 | 420 MHz | CW-FM-SSB/AM | 10W | 40W | 159.95 |
| BLE 2/40 | 420 MHz | CW-FM-SSB/AM | 2W | 40W | 179.95 |
| BLE 30/80 | 420 MHz | CW-FM-SSB/AM | 30W | 80W | 259.95 |
| BLE 10/80 | 420 MHz | CW-FM-SSB/AM | 10W | 80W | 289.95 |

FEATURES

- High efficiency means low current drain.
- Broad band design (no tuning).
- Direct 12 volt DC operation.
- Indicator lamps for On/Off and FM/SSB.
- Relay switching (allows you to put amplifier in or out of circuit at the flip of a switch).
- Insertion loss of less than 1 dB.
- 90 day limited warranty on parts and labor.

F.O.B. Binghamton. Prices and specifications are subject to change. Export prices are slightly higher.



✓ V5

Vhf engineering



DIVISION OF BROWNIAN ELECTRONICS CORP.

320 WATER STREET / BINGHAMTON, N.Y. 13901 / Phone 607-723-9574

Heath's GR-88 Gets Religion!

— convert it to 2 meters

It appears that, due to the increase in popularity of "scanning" type VHF receivers, the Heathkit® GR-88 tunable receiver has become available at modest sale prices. The GR-88 is a completely solid state receiver that tunes from about 152 to 174 MHz and has provisions for one crystal-controlled channel. With the self-contained battery pack, it is completely portable. Full squelch circuitry is also a fine feature of this receiver. It doesn't have a 30-pole crystal filter for the ultimate in selectivity, but the 10.7 MHz i-f is quite good for a general-purpose monitor receiver.

The front end or tuner

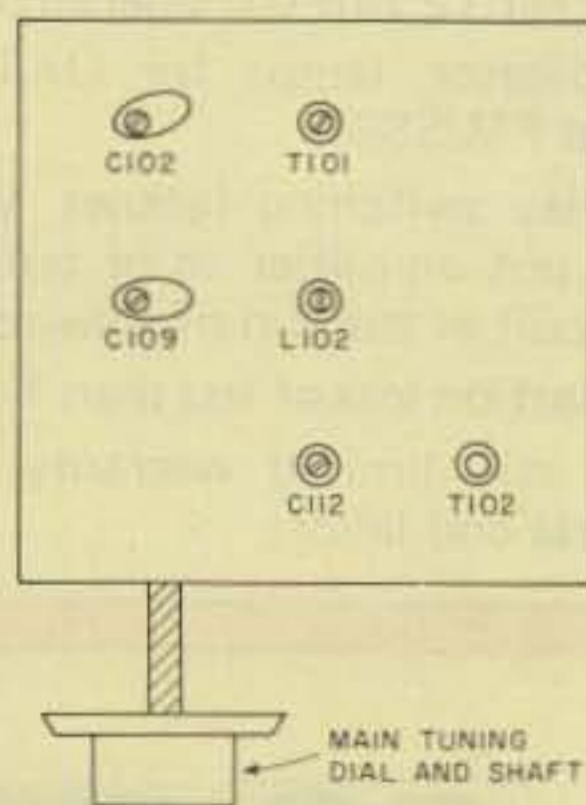

Fig. 1. GR-88 tuner, top view.

portion of the GR-88 is factory assembled and pre-aligned. The 10.7 MHz i-f, squelch, and audio board must be constructed as a typical Heathkit. The 10.7 MHz i-f transformers have also been factory aligned for ease in the final tune-up procedures.

Although the GR-88 has a factory prealigned front end, it can be quite easily retuned to cover 142-160 MHz with no additional components. This 142-160 MHz frequency span allows reception of MARS channels below and above two meters and most of the public service frequencies above two meters.

The GR-88 can be re-aligned for two meters with a minimal amount of test gear. All that is necessary is a simple grid-dip meter or signal generator that covers two meters and below. The plastic alignment tools provided by Heath in the original kit are adequate for tune-up. Do not use metal tune-up tools as their resultant capacity can make alignment pretty tough.

Fig. 1 illustrates the positions of the coils and capacitors that will have to be adjusted during align-

ment. The first step is to couple the test generator to the GR-88 receiver. Of course, if you are fortunate enough to have a signal generator, it can be coupled directly to the antenna input. If you are using a grid-dip meter, a small piece of hookup wire inserted in the GR-88 antenna jack will couple the signal into the receiver.

The main tuning dial of the receiver should be set at 152 MHz or its lowest frequency setting. The dial should remain in this position during the entire tune-up procedure. With power on and the squelch off, adjust your signal source until this frequency (about 152 MHz) is detected by the receiver.

C112 is the metal screw (older models) or ceramic capacitor (newer models) that trims the frequency of the oscillator stage. C112 should be tuned in small increments and the received signal followed down the band with your signal source. You will eventually reach a point where this trimmer (C112) will no longer cause a decrease in frequency. With the screw-type trimmer, it probably will be all the way in. Leave

the trimmer at this setting. L102 is now tuned clockwise until you detect a frequency of 142 MHz.

We must mention at this point that T102 (10.7 MHz mixer coil) should not be adjusted at any time during the realignment.

The rf amplifier and mixer stages are next in the alignment procedure. With the same signal source at 142 MHz, adjust both C102 and C109 fully clockwise to increase their capacity. T101 and L101 are now adjusted clockwise for a maximum increase in signal strength.

If you are using a grid dipper as the signal source, back it as far away from the receiver as possible and retune T101 and L101 for maximum signal. C102 and C109 can also be adjusted for maximum.

When you can no longer detect an increase in signal from the test source, attach your two meter antenna and tune around a bit. At this point, some two meter activity should be detected. Select a weak station and once again adjust T101, L101, C102, and C109 for maximum. This completes the front end

Happy Days ARE HERE AGAIN!

When it comes to . . .
**FAST DELIVERY,
 HONEST DEALING &
 PROMPT DEPENDABLE**
"S-E-R-V-I-C-E"
 We don't just advertise it —
WE GIVE IT!

DENTRON MLA-2500

160 thru 10 Meter Amplifier



REG. \$899⁵⁰

While they last . . . Only \$799^{50*}

CDE HAM-III

New/Improved
 Heavy Duty

**ROTORS
 NOW**

**ONLY
 \$129.95**

with Control
 (LESS CABLE)



**SPECIAL
 TRI-BAND
 BEAM OFFER**

MAIL AND
 TELEPHONE
 ORDERS
 "WELCOMED"
 . . . They're our
 business!!



SAVE 10% PLUS

10% "CASH" SAVINGS NOW IN EFFECT on these popular TRI-BAND BEAMS! AND . . . with "PACKAGE" PURCHASE of selected TRI-BANDERS . . . you can BUY A NEW CDE

HAM-III ROTOR for LESS THAN ONE HUNDRED DOLLARS! LIMITED — ORDER NOW & SAVE! CALL or WRITE TODAY . . .

*TERMS: "CASH" means CHECK, MONEY ORDER or C.O.D.

| MAKE/MODEL | | REGULAR PRICE | SPECIAL "CASH" PRICES* | |
|------------------|----------------|---------------|------------------------|--------------|
| | | | BEAM ONLY | BEAM & ROTOR |
| CUSHCRAFT ATB-34 | 4-Element 2-KW | \$259.95 | \$209.95 | \$319.95 |
| HY-GAIN TH3-JR. | 3-Element/300W | \$144.50 | \$129.95 | \$242.50 |
| HY-GAIN TH3-MK3 | 3-Element/1KW | \$219.95 | \$179.95 | \$289.95 |
| HY-GAIN TH6-DXX | 6-Element/2KW | \$296.95 | \$246.95 | \$349.95 |
| MOSLEY TA-33-JR | 3-Element/1KW | \$151.85 | \$136.50 | \$247.50 |
| MOSLEY TA-33 | 3-Element/2KW | \$206.50 | \$185.00 | \$294.50 |
| MOSLEY TA-36 | 6-Element/2KW | \$335.25 | \$299.95 | \$399.95 |
| MOSLEY CL-33 | 3-Element/2KW | \$232.50 | \$209.00 | \$317.25 |
| MOSLEY CL-36 | 6-Element/2KW | \$310.65 | \$279.50 | \$384.50 |
| WILSON SYSTEM I | 4-Element/2KW | \$274.95 | \$224.95 | \$329.95 |
| WILSON SYSTEM II | 3-Element/2KW | \$219.95 | \$179.95 | \$289.95 |

FREIGHT: ALL SHIPPING CHARGES "COLLECT" — F.O.B. WATERTOWN!



Write today for our latest
 Bulletin/Used Equipment list.

Burghardt
 INC.
AMATEUR CENTER

"America's Most Reliable Amateur Radio Dealer"

PHONE NO. (605)-886-7314

P.O. BOX 73 WATERTOWN, SOUTH DAKOTA 57201

alignment. If you so desire, the 10.7 MHz i-fs may also be tweaked up a bit. With a weak two meter station, carefully adjust T1, T2, T3, and T4 for optimum signal and clarity of FM reception.

Although we have not tried crystal-controlled operation on two meters with the GR-88, it should be entirely possible. For a frequency of 146.000 MHz, the crystal frequency

would be determined as follows: 146.000 (desired receive frequency) - 10.700 (i-f frequency) = 135.300 (oscillator output frequency). 135.300 (oscillator output frequency) ÷ 3 = 45.100 (crystal frequency).

Therefore the crystal frequency would be 45.100 MHz.

When ordering a crystal for a specific frequency, it should be of the following

type:

Holder: HC-18/U

Load capacitance: 32 pF

Mode: Parallel resonance on the third mechanical mode of oscillation

Frequency tolerance: .0025% at 25 degrees C.

Maximum drive level: 1.2 mW

Effective resistance: 25 Ohms

C44 will have to be retuned for a resonance of L3 at 135.300 MHz for

reception at 146.000 MHz. It is possible that a small amount of capacitance may have to be added to C44 (in parallel with). Use a high-quality silver mica for this application should it be necessary.

Upon completion of this conversion, the GR-88 serves well as a general-purpose receiver for both two meters and the additional frequencies up to 162 MHz. ■

DX

from page 217

posal to reserve 10 kHz in each amateur band for worldwide communications during natural disasters have been invited. Last-chance comments closed on August 31, after which the CIC will prepare the Canadian position for WARC '79.

QSL INFORMATION

A2CED to K4EBY
A51PN to H.N. Pradhan, Amateur Radio Station, Post Office, Thimpu, Bhutan
D68AF to K5YY
FG7TD to W5RU
FR7BV to Michael Di Orio, LEP, Route Des Makes, 97450 Saint Louis, Reunion Island
GU5CIA/GU4EON/GU3YIZ to

K5YY to PO Box 5299, Little Rock AR 72215
KA1IW to K8DYZ
KM6BI to W5RU
Box 100, Guernsey, Channel Islands, UK
H44CD to W4BAA
HF0POL to SP2BBD
HZ1BS/8Z4 to PO Box 31, Gratz, Austria
Northern California DX Foundation—see text
PJ8USA to W1CDC
S8ABC to Box 900, Secunda, 2302 Republic of South Africa
ST0RK—see text
SV0WY to S/Sgt Mike Woolver-

ton, PO Box 3078, 7122 Broadcasting Sqdn, APO NY 09223
SV0WTT to Box 722, APO NY 09223
SV1JG—see text
TA1ZB to Metin Kutlu, Box 188, Istanbul, Turkey
VE1MTA—see text
VR3AH to WB4PRU
4AAFR to Box 642, Saltillo, Mexico
4U1UN—see text
Many thanks to the *West Coast DX Bulletin* and the *Long Island DX Assn. Bulletin* for much of the preceding information.

OSCAR Orbits

The listed data tells you the time and place that OSCAR 7 and OSCAR 8 cross the equator in an ascending orbit for the first time each day. To calculate successive OSCAR 7 orbits, make a list of the first orbit number and the next twelve orbits for that day. List the time of the first orbit. Each successive orbit is 115 minutes later (two hours less five minutes). The chart gives the longitude of the day's first ascending (northbound) equatorial crossing. Add 29° for each succeeding orbit. When OSCAR is ascending on the other side of the world from you, it will descend over you. To find the equatorial descending longitude, subtract 166° from the ascending longitude. To find the time OSCAR 7 passes the North Pole, add 29 minutes to the time it passes the equator. You should be able to hear OSCAR 7 when it is within 45 degrees of you. The easiest way to determine if OSCAR is above the horizon (and thus within range) at your location is to take a globe and draw a circle with a radius of 2450 miles (4000 kilometers) from your QTH. If OSCAR passes above that circle, you should be able to hear it. If it passes right overhead, you should hear it for about 24 minutes total. OSCAR 7 will pass an imaginary line drawn from San Francisco to Norfolk about 12 minutes after passing the equator. Add about a minute for each 200 miles that you live north of this line. If OSCAR passes 15° east or west of you, add another minute; at 30°, three minutes; at 45°, ten minutes. Mode A: 145.85-.95 MHz uplink, 29.4-29.5 MHz downlink, beacon at 29.502 MHz. Mode B: 432.125-.175 MHz uplink, 145.975-.925 MHz downlink, beacon at 145.972 MHz.

OSCAR 8 calculations are similar to those for OSCAR 7, with some important exceptions. Instead of making 13 orbits each day, OSCAR 8 makes 14 orbits during each 24-hour period. The orbital period of OSCAR 8 is therefore somewhat shorter: 103 minutes.

To calculate successive OSCAR 8 orbits, make a list of the first orbit number (from the OSCAR 8 chart) and the next thirteen orbits for that day. List the time of the first orbit. Each successive orbit is then 103 minutes later. Due to incorrect tracking information obtained during the early days of OSCAR 8, the equator crossing times contained in most published charts are in error. To correct this error, multiply the orbit number by 0.00205 minutes and add

the result to the equator crossing time as printed in the chart. For example, the published time for orbit number 3352, the first equatorial crossing on November 1, 1978, is 0018:50 UTC. Thus, for orbit number 3352, the corrected equatorial crossing time would be:

$$\begin{aligned} \text{Corrected time} &= 0018:50 + (3352 \times 0.00205 \text{ minutes}) \\ &= 0018:50 + (6.8716 \text{ minutes}) \\ &= 0025:42.3 \end{aligned}$$

The longitude figures contained in the OSCAR 8 chart are virtually unaffected by this tracking error. The chart gives the longitude of the day's first ascending equatorial crossing. Add 26° for each succeeding orbit. To find the time OSCAR 8 passes the North Pole, add 26 minutes to the time it crosses the equator. OSCAR 8 will cross the imaginary San Francisco-to-Norfolk line about 11 minutes after crossing the equator. Mode A: 145.85-.95 MHz uplink, 29.4-29.50 MHz downlink, beacon at 29.40 MHz. Mode J: 145.90-146.00 MHz uplink, 435.20-435.10 MHz downlink, beacon at 435.090 MHz.

| Oscar 7 Orbital Information | | | | Oscar 8 Orbital Information | | | |
|-----------------------------|------------|------------|------------------------------|-----------------------------|------------|------------|------------------------------|
| Orbit | Date (Nov) | Time (GMT) | Longitude of Eq. Crossing *W | Orbit | Date (Nov) | Time (GMT) | Longitude of Eq. Crossing *W |
| 18120 Bbn | 1 | 0144:47 | 86.1 | 3352X | 1 | 0018:50 | 46.0 |
| 18132 Abn | 2 | 0044:08 | 71.0 | 3366 Abn | 2 | 0024:02 | 47.4 |
| 18145 Bbn | 3 | 0138:25 | 84.6 | 3380 Abn | 3 | 0029:13 | 48.7 |
| 18157 Bbn | 4 | 0037:45 | 69.4 | 3394 Jbn | 4 | 0034:25 | 50.0 |
| 18170 Abn | 5 | 0132:03 | 83.0 | 3408 Jbn | 5 | 0039:36 | 51.3 |
| 18182 Bbn | 6 | 0031:23 | 67.9 | 3422 Abn | 6 | 0044:48 | 52.6 |
| 18195 Bbn | 7 | 0125:41 | 81.4 | 3436 Abn | 7 | 0049:59 | 53.9 |
| 18207 Abn | 8 | 0025:01 | 66.3 | 3450X | 8 | 0055:11 | 55.2 |
| 18220 Bbn | 9 | 0119:18 | 79.9 | 3464 Abn | 9 | 0100:22 | 56.5 |
| 18232 Bbn | 10 | 0018:39 | 64.7 | 3478 Abn | 10 | 0105:33 | 57.8 |
| 18245 Abn | 11 | 0112:56 | 78.3 | 3492 Jbn | 11 | 0110:45 | 59.2 |
| 18257 Bbn | 12 | 0012:17 | 63.2 | 3506 Jbn | 12 | 0115:56 | 60.5 |
| 18270 Bbn | 13 | 0106:34 | 76.8 | 3520 Abn | 13 | 0121:08 | 61.8 |
| 18282 Abn | 14 | 0005:55 | 61.6 | 3534 Abn | 14 | 0126:19 | 63.1 |
| 18295 Bbn | 15 | 0100:12 | 75.2 | 3548X | 15 | 0131:30 | 64.4 |
| 18308 Bbn | 16 | 0154:29 | 88.8 | 3562 Abn | 16 | 0136:42 | 65.7 |
| 18320 Abn | 17 | 0053:50 | 73.6 | 3576 Abn | 17 | 0141:53 | 67.0 |
| 18333 Bbn | 18 | 0148:07 | 87.2 | 3589 Jbn | 18 | 0003:51 | 42.5 |
| 18345 Bbn | 19 | 0047:28 | 72.1 | 3603 Jbn | 19 | 0009:02 | 43.8 |
| 18358 Abn | 20 | 0141:45 | 85.7 | 3617 Abn | 20 | 0014:13 | 45.1 |
| 18370 Bbn | 21 | 0041:06 | 70.5 | 3631 Abn | 21 | 0019:25 | 46.5 |
| 18383 Bbn | 22 | 0135:23 | 84.1 | 3645X | 22 | 0024:36 | 47.8 |
| 18395 Abn | 23 | 0034:43 | 69.0 | 3659 Abn | 23 | 0029:47 | 49.1 |
| 18408 Bbn | 24 | 0129:01 | 82.6 | 3673 Abn | 24 | 0034:58 | 50.4 |
| 18420 Bbn | 25 | 0028:21 | 67.4 | 3687 Jbn | 25 | 0040:10 | 51.7 |
| 18433 Abn | 26 | 0122:39 | 81.0 | 3701 Jbn | 26 | 0045:21 | 53.0 |
| 18445 Bbn | 27 | 0021:59 | 65.8 | 3715 Abn | 27 | 0050:32 | 54.3 |
| 18458 Bbn | 28 | 0116:17 | 79.4 | 3729 Abn | 28 | 0055:43 | 55.6 |
| 18470 Abn | 29 | 0015:37 | 64.3 | 3743X | 29 | 0100:55 | 56.9 |
| 18484 Bbn | 30 | 0109:54 | 77.9 | 3757 Abn | 30 | 0106:06 | 58.2 |

SCR 1000 - Standard of Comparison

In Repeaters - Now Available with Autopatch

- And Many Other Options!

Autopatch features:

- Normal patch, or secure reverse patch accessed by a control op.
- 3 digit anti-falsing access — single digit disconnect
- 3 digit on-off control of repeater transmitter
- 4 sec. time limit on access
- Built-in adjustable time-out function — patch shuts down in 30-90 sec. if no carrier is received
- Wide range audio AGC on input and output.
- User can mute phone line audio simply by keying his mic button — prevents embarrassing language from being repeated
- Patch access and repeater control — either over the air or over the land line



2Mtr. & 220 MHz!



Rear chassis view of repeater with "RX & TX Assy."

Now Spec Comm has taken the hassle out of putting an autopatch repeater on the air! The SCR1000/SCAP is a fully self-contained 30 watt repeater with built-in autopatch and land line control. You simply plug in the phone line, hook up the duplexer, and you're on the air! The usual months of problems are eliminated! The SCR1000/SCAP has been meticulously engineered to provide the smoothest performing patch together with a positive land line control of the repeater. The system is fully assembled, set-up and checked-out in our lab.

- **The SCR1000**—simply the finest repeater available on the market . . . and often compared to less featured "commercial" units selling for 3 times the price! This is a 30 Wt. unit, with a very sensitive & selective receiver. Included is a built-in AC Supply, *NEW Expanded Memory CW IDer*, full metering and lighted status indicators/control push-buttons, crystals, local mic, etc. Also provided are jacks for emergency power, remote control, autopatch, etc.
- **A full complement of options are available:** Duplexers, Cable, 'PL', TouchTone™ Control, HI/LO Power, Autopatch, 60-70 Wt. transmitter, 2-4 chan. ID, Cabinets, etc. Please inquire.
- **The Spec Comm Repeater System** . . . a sound, long-term investment . . . available only by direct factory order. Get your order in A.S.A.P.!

SCR 1000 Specifications

RF Output 30 Watts typ.
 Infinite VSWR proof
 Sensitivity 0.3uV/20dB Qt.
 Selectivity . . . -6dB @ ± 6.5 kHz;
 - 75dB @ ± 15 kHz;
 - 100dB @ ± 30 kHz.
 Includes 8 Pole Xtal Filtr. (Sharper 10 Pole Filtr. Available)

- State of the Art CMOS** control logic & timers—No Relays!
- Built-in CW IDer**—Low current draw, 250 bit PROM Memory! Adjustable speed, pitch, time, etc.
- Exclusive Spec Comm **MOS-FET/Hot Carrier Diode** rcvr. front end—reduces 'dense' & IM problems!
- Built-in AC Supply** w/instant btry. switchover for emergency pwr.
- Supplied with ±.0005%** precision xtals, local mic., & FL-6 Preselector.
- Jacks Provided** for Remote Control, Auto-Patch, DC out, AF in/out, COR Switch, etc.
- True FM**—For Rpt. Audio so good, it "sounds like direct"!

180 DAY WARRANTY

SPEC-COMM REPEATER BOARDS, SUB-ASSEMBLIES & ACCESSORIES

2M & 220 MHz!

- **FL-6 Preselector.** Rcvr. Front-End Filter/Preamp. Exc. rejection of strong "out of band" sigs. - 60dB @ ± 6 MHz \$85.00
- **SCR100 Receiver Board.** w/xtal \$125.00 (9 Pole IF Filter + \$15.00) (10 Pole IF Filter + \$25.00)
- **SCR100 Receiver Assembly.** SCR100 mounted in shielded housing. \$195.00
- **SCT110 Xmtr./Exciter Bd.** 7 or 10 Wt. bd. \$135.00 w/xtal. BA-10 30 Wt. Amp. bd. & Ht. Sink. \$51.95
- **SCT110 Transmitter Assembly.** SCT110 mounted in shielded housing. . . . \$199.95 (30 Wt. Amp. + \$68.00)
- **CTC100 COR/Timer/Control Bd.** \$35.00
- **ID250 CW ID/AF Mixer Bd.** Programmed \$65.00
- **SCAP Autopatch Bd.** \$225.00
- **RPCM "Reverse Patch" & control bd.** \$79.95
- **TTC100 Touch Tone Control bd.** 3 digit ON, 3 digit OFF. \$85.00
- **TRA-1 Timer Reset Annunciator Bd.** \$20.95
- **WP641 Duplexer.** . . . \$495.00

FEATURES

- Full Metering** of critical levels.
- Front Panel Controls** for timers & AF levels.
- Lighted push-buttons** for control/test functions & status indicators

| | |
|---------------------------------------|-----------|
| SCR 1000 | \$1150.00 |
| SCR 1000 WITHOUT PRESELECTOR. | \$1065.00 |
| SCR 1000 SCAP | \$1700.00 |
| SCR 1000 SCAP WP641 DUPLEXER. | \$2195.00 |

Commercial prices somewhat higher.

See our October 73 Ad for more details! (Add \$3.75 ship/handling. PA residents add 6% tax.)

Send for Data Sheets!



SPECTRUM COMMUNICATIONS

1055 W. Germantown Pk., Norristown PA 19401 (215) 631-1710

Four Terminals Are Better Than Three

— using the new voltage regulators

Stirling M. Olberg W1SNN
19 Loretta Road
Waltham MA 02154

Editorial comments in amateur publications to the effect that the integrated circuit manufacturers are putting together ICs faster than applications for them become known is certainly true of voltage regulators.

There have been numerous articles regarding the construction of bench power supplies which in-

corporate discrete components and transistors to accomplish an excellent job of regulating voltages at levels which can be adjusted via front panel controls. Additional circuitry which incorporates safety circuits such as over-voltage, overcurrent, and shutdown control to these discrete component circuits requires considerably more work to construct, but for certainly desirable features.

Three-terminal regulators such as the LM309K

and all of the additional configurations which provide moderate current levels and fixed voltages can also have additional discrete components externally added to increase current availability and the above mentioned safety features. These have brought the construction of such a unit up to an evening's work to complete.

Available now are four-terminal variable voltage chips which provide all of these features and now

make the construction of small regulated supplies a very simple job. These regulators come in either positive or negative configurations, allowing the construction of dual supplies such as one might require for use with TTL logic (this incorporates MOS logic that will require a higher voltage, like -12 volts).

Typical of these units are the Fairchild μ A78G positive and μ A79G negative chips. They are manufactured in three configurations known to me. One is TO-3 packages. A second is power tab packages both delivering continuous load currents of 1 Ampere with suitable heat sinks and with voltage ranges from 2.2 volts to 30 volts, depending on the voltage polarity. The negative range goes down to -2.2 volts, while the positive regulator starts at +5 volts. A maximum input voltage of 40 volts dc can be used from a raw source. Thirdly, power mini-DIP packages are available at .5 Ampere continuous, with similar

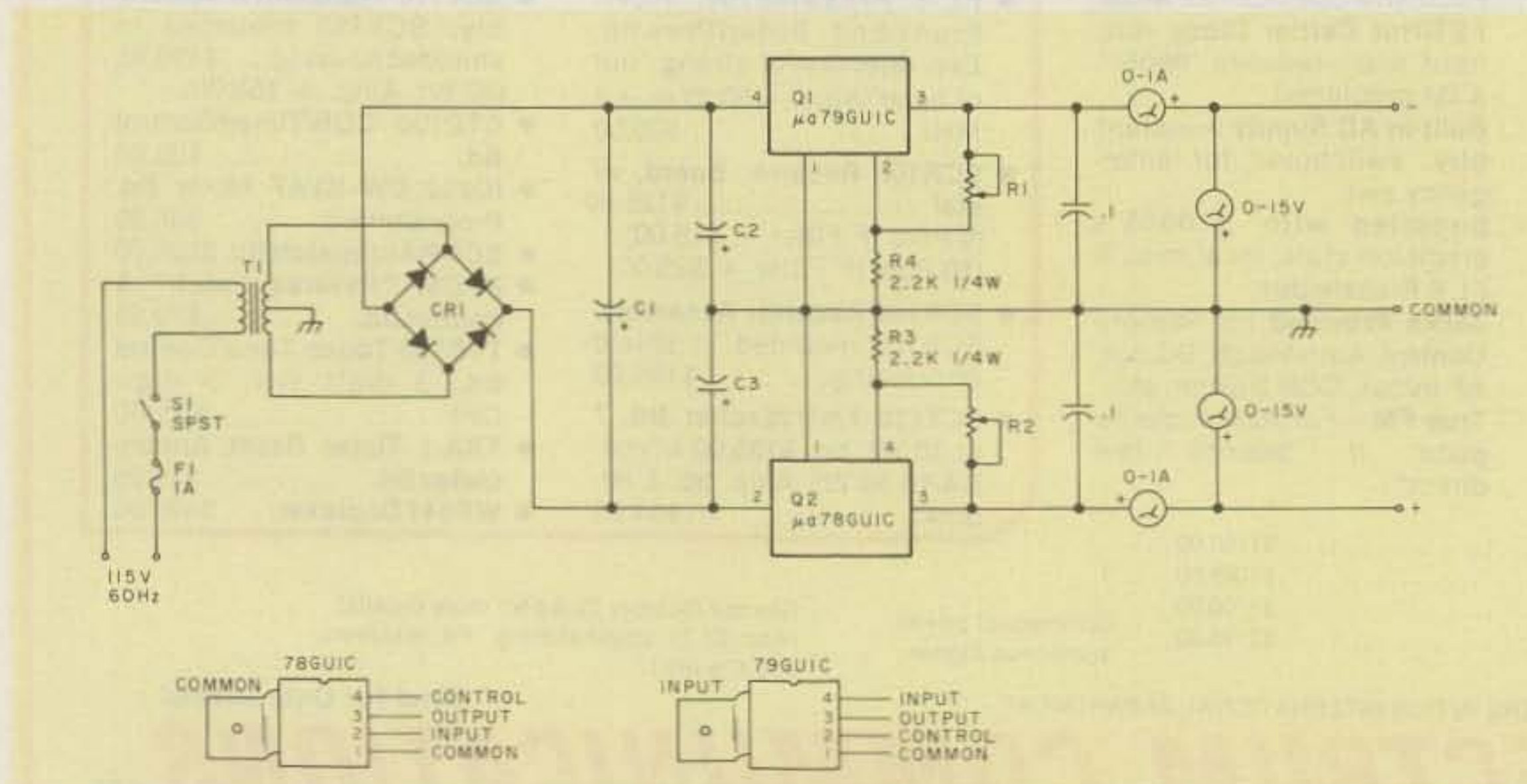

Fig. 1. Variable voltage 1 Amp regulated supply.

specifications.

All units feature internal thermal overload protection and internal short circuit protection, which are shutdown features. Additional external circuitry such as a current transistor can be added to any of these units to increase the current output availability up to 10 Amps. Not too far away are packages that will eliminate this requirement.

A circuit of a supply is shown in Fig. 1 along with a parts list of the hard-to-get parts. The supply will deliver 2.2 to -14 volts. The level is set by R1, a trimpot. This can be a larger pot with a knob if desired. The positive supply is adjustable from +5 to +14 volts by adjusting R2 to the desired voltage output as indicated on the voltmeter. Current is, of course, indicated on the ammeter. The two meters are "frosting on the cake" and can

be left out if the constructor desires to decrease the cost of the unit. The heat sink area of the power tab is not large enough to carry the full output current; therefore, the tab must be fastened to the chassis or a large piece of aluminum to dissipate the heat generated. The positive regulator may have the tab connected directly to the chassis since it is at the common or ground point. This is not the case with the negative regulator—it must be insulated with a mica washer or other suitable insulation. Thermal joint compound, a silicone grease, greatly improves the thermal conductivity of these two connections and should be used. It can be obtained from the same source listed for the other components.

Attention should be given to the layout of the chips regardless of their

configuration. They are not furnished with compatible pinouts for positive or negative regulators and you will come to some grief if attention is not given to this matter.

If higher voltages are required than those available in this supply, T1 must be changed to provide the difference. Remember that the current availability of the transformer must be at least twice the current required since a bridge rectifier is used. CR1 and C1 will not have to be changed since the specifications for these components exceed the requirements for the highest

voltage that can be applied to the regulators.

Many manufacturers are making these units available in configurations similar to those described. Most of them require quantity buys and so the home constructor is hard put to obtain them. The units chosen here were obtained through the local Radio Shack store, which assisted by acting as the purchasing organization. Most Radio Shacks will accommodate your requirements in the same manner. The components listed can, of course, be duplicated from your junk box or wherever you acquire your parts. ■

Parts List

| | |
|--------|--------------------------------------|
| T1 | 25.2 volt, 2 A, Allied #705R0123 |
| CR1 | Full wave bridge, Allied #J5BB8 |
| Q1 | Fairchild uA79GU1C power tab |
| Q2 | Fairchild uA78GU1C power tab |
| C1 | 2500 uF 50 volt, Allied #852-5239 |
| C2, | DP solid dip tantalum, 33 uF, 35 V, |
| C3 | Allied #623-0610 |
| R1, R2 | 50k trimpot, 1/4 W, Allied #854-6153 |

New Products

from page 22

The Slimline meter is ultra-compact . . . only 4½" W x 3½" H x .72" thick. It will mount flat on the front of a panel and operates on 120 V ac line power.

The bright 3½-digit display features special high-efficiency red-orange LEDs, which are exceptionally easy to read. This instrument is ideal for applications where many different current transformers are used (or may already be installed). It can be used to upgrade a switchboard without changing the current transformers, or in new installations, avoiding the expense and installation difficulties of standard DVMs.

The instrument is very stable (includes auto-zero and temperature stability of .01% full scale/degree Celsius) and is covered by an impressive 5-year warranty. For further information, contact *Nationwide Electronic Systems, 1536 Brandy Parkway, Streamwood IL 60103; (312)-289-8820.*

MICROTRONICS M-65

The M-65 is a complete Morse code and RTTY system for the PET microcomputer. It is made up of two parts: the hardware and the software. The hardware consists of one PC board which is connected to your rig and to your PET user port. No modifications are required to either your radio equipment or to the PET—everything plugs into existing jacks. No external power supply is required. Both input and output circuits are optically isolated from the PET, thereby minimizing rf and spurious voltages. The board also has a built-in sidetone oscillator which connects to your speaker or headphones, making it ideal for teaching Morse code to large groups or to an individual. The built-in sidetone also allows "processed audio" reception of CW, which eliminates background noise and most QRM. The demodulator uses phase locked loop circuitry, which compensates for slight frequency drift and also adds an additional stage of audio frequency selectivity.

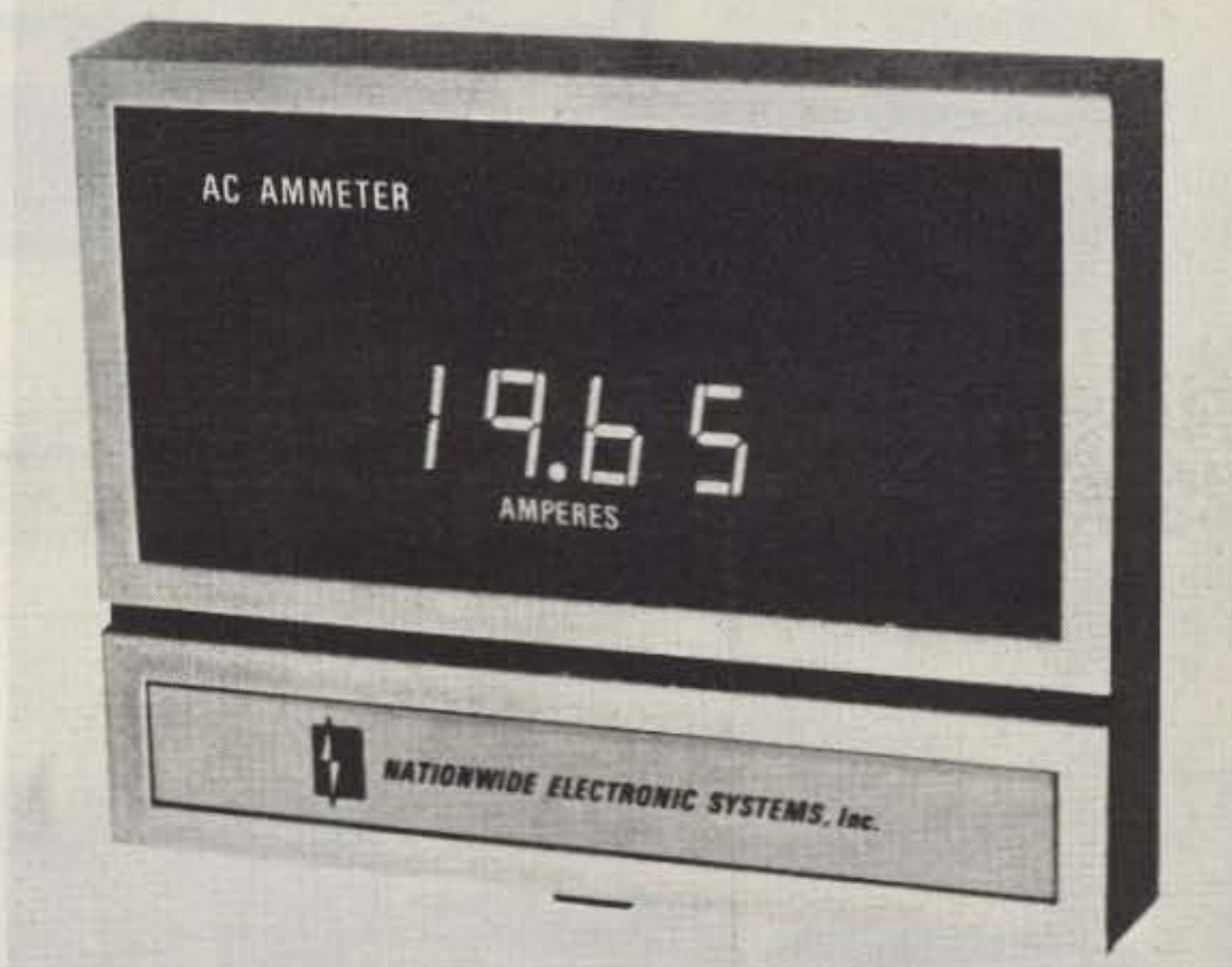

Nationwide's new Slimline ac ammeter.

The software consists of two computer programs—MORSE and RTTY—supplied on one audio cassette. Both programs are written in BASIC with machine language subprograms. Each requires 8K bytes of RAM. Program MORSE allows continuous speed adjustment from one to 100 wpm in any of three modes of operation: receive, send, and code practice. In the receive mode, a

CW signal will be automatically decoded and the resulting text will appear on the video monitor. Changes in the sending station's speed are automatically corrected for by means of an exponential smoothing technique. In the send mode, the system acts as a keyboard keyer—anything typed is encoded and directly

Continued on page 239

WE HAVE WHAT YOU NEED AT...



YD-844
Dynamic Mike

YAESU

ADVANCED COMMUNICATION EQUIPMENT

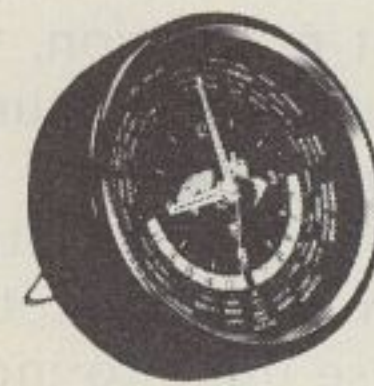

QTR-24
World Clock

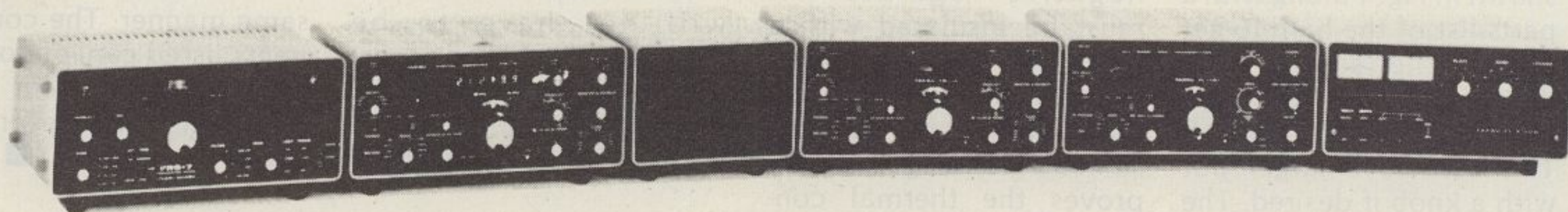

Left to right — FRG-7, Solid State Synthesized Communications Receiver • FR-101 Digital, Solid State Receiver • SP-101B, Speaker • FR-101, Digital Solid State Receiver • FL-101, 100 W Transmitter • FL-2100B, 1200 W PEP Input Linear Amplifier

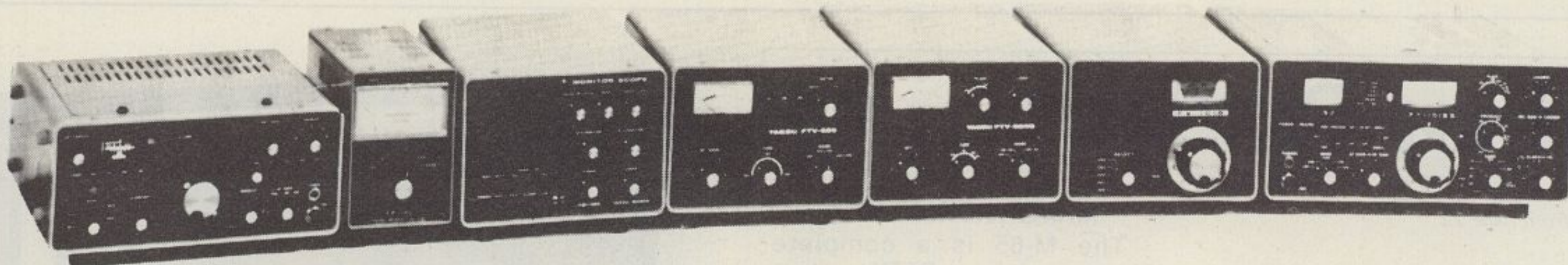

Left to right — FT-620B, 6 Meter Transceiver • YP-150, Dummy Load Wattmeter • YO-101, Monitor Scope • FTV-250, 2 Meter Transverter • FTV-650, 6 Meter Transverter • FV-101B, External VFO • FT-101F 160-10M Transceiver

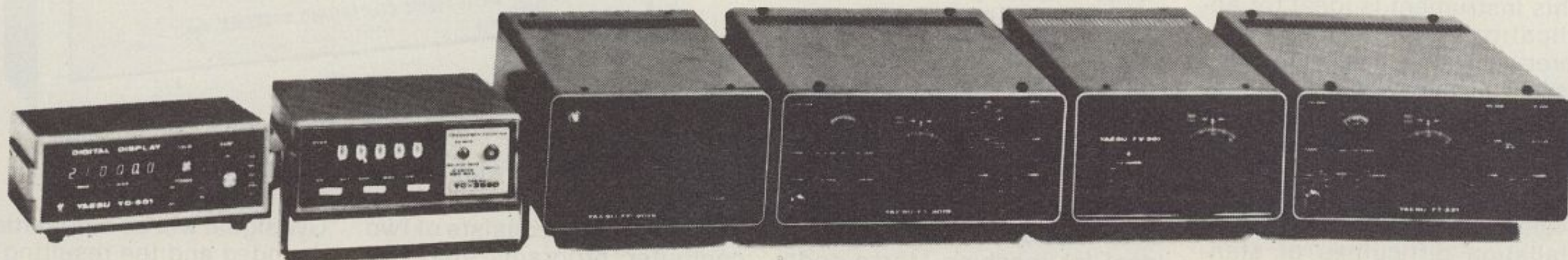

Left to right — YC-601, Digital Frequency Display • YC-355D, Frequency Counter • FP-301, AC Power Supply • FT-301S Digital, All Solid State Transceiver • FV-301, External VFO • FT-225RD, 144-148 All Solid State All Mode Transceiver

HAMTRONICS-WHERE THE HAM IS KING



USED GEAR • TRADE UP • FREE UPS SHIPPING ON PREPAID ORDERS

\$2,000,000 HAM INVENTORY

THE LOWEST POSSIBLE PRICES



THE PACESETTER IN AMATEUR RADIO



TS-700SP \$759.00

2M ALL MODE BASE/MOBILE TRANSCEIVER. SSB (upper and lower), FM, AM and CW. AC and DC. 4 MHz band coverage (144 to 148 MHz). Dial in receiver frequency and TS-700A automatically switches xmitter freq. 600 KHz for repeater operation. Xmit, Rcv capability on 44 Ch. with 11 xtals.



TR-7400A \$449.00

2M MOBILE TRANSCEIVER. Synthesized PLL. Selectable output, 25 watts or 10 watts. 6 Digit LED freq. display. 144-148 MHz, 800 CH. in 5 KHz steps. 600 KHz repeater offset. Continuous tone-coded squelch (CTSC). Tone Burst.



TS-820S \$1249.00

SSB TRANSCEIVER. PLL RF Monitor Noise Blanker. Digital hold locks counter & display at any frequency, but allows VFO to tune normally. True RF compressor adjustable speech processor. IF shift control. RF attenuator. VOX, GAIN, ANTIVOX and VOX delay controls. RF negative feedback. Optional digital readout. DRS Dial. High stability FET VFO.



TS-520S \$799.00

SSB TRANSCEIVER. Proven in the shacks of thousands of discriminating hams, field day sites, DX and contest stations and mobile installations. Superb engineering and styling.

SP-520 \$33.00

Optional external speaker for better readability.

TV-502S \$299.00

TRANSVERTER. Puts you on 2M the easy way. 144-145.7 MHz or optional 145-146 MHz.



R-820 — INTRODUCING — \$1049.00

THE ULTIMATE IN RECEIVER DESIGN... THE KENWOOD R-820. With more features than ever before available in a ham-band receiver. This triple conversion (8.33 MHz, 455 kHz, and 50 kHz IFs) receiver, covering all Amateur bands from 160 through 10 meters, as well as several shortwave broadcast bands, features digital as well as analog frequency readouts, notch filter, IF shift, variable bandwidth tuning, sharp IF filters, noise blanker, stepped RF attenuator, 25 kHz calibrator, and many other features, providing more operating conveniences than any other ham-band receiver. The R-820 may be used in conjunction with the Kenwood TS-820 series transceiver, providing full transceive frequency control.



MC-50 \$45.00

Dynamic microphone designed expressly for amateur radio operation. Complete with PTT and LOCK switches, and a microphone plug. (600 or 50k ohm)



S-599D-\$25.00 R-599D-\$499.00 T-599D-\$499.00

SSB TRANSMITTER. 3.5 to 29.7 MHz. Stable VFO. 1 KHz dial readout. 8 pole Xtal filter. AM Xmission available. Built-in AC pwr supply. Split frequency control available.



VFO-820 \$175.00

Designed exclusively for use with TS-820. RIT circuit and control switch. Fully compatible with optional digital display.

VFO-520 (Not Shown) \$149.00

Solid State Remote VFO. RIT circuit with LED indicator.

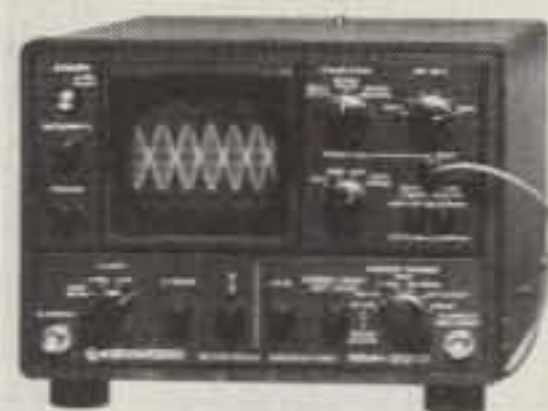

SM-220 \$329.00

KENWOOD'S SM-220 STATION MONITOR. The SM-220's unexcelled versatility allows you to monitor your transmissions, monitor incoming signals, and monitor the amount and strength of band activity* and performs as a general-purpose 10 MHz oscilloscope, as well.

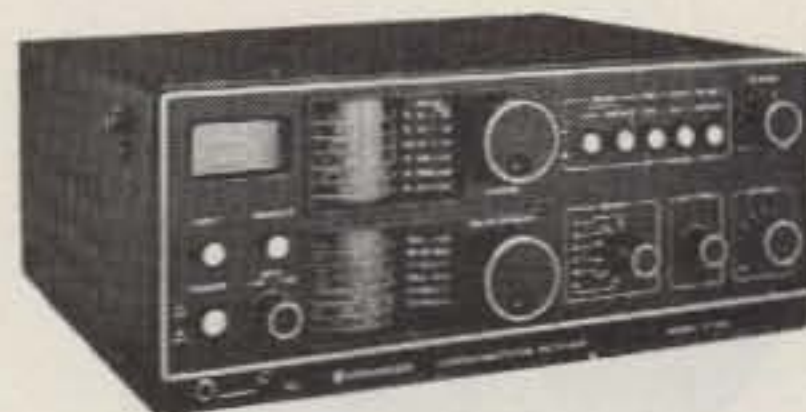

R-300 \$279.00

ALL BAND COMMUNICATIONS RECEIVER. AC, batteries or external DC. 170 KHz to 30 MHz in 6 bands. Foreign broadcasts or ham radio in AM, SSB and CW. Dual gate MOS/FET transistors & double conversion. Band spread dial. 500 KHz marker.

THE BIG 'H' FOR ALL YOUR HAM NEEDS!

CALL JIM TITUS FOR FREE QUOTES ON TOLL FREE NO. 800-523-8998

HAMTRONICS

DIVISION OF TREVOSSE ELECTRONICS
4033 Brownsville Rd • Trevose, Pa. 19047
(215) 257-1400 / (215) 257-5200

WE HAVE WHAT YOU NEED AT...



DRAKE®

KNOWN FOR QUALITY THROUGHOUT THE WORLD



RECEIVERS

| | | |
|-------|---|-----------|
| DSR-2 | VLF-HF Digital Synthesized SSB, AM, CW, ISB, RTTY | \$3200.00 |
| R-4C | C-Line, HF, 160-10M | \$699.00 |
| 4NB | Noise Blanker for R-4C | \$74.00 |

TRANSMITTER

| | | |
|-------|---------------------|----------|
| T-4XC | C-Line, HF, 160-10M | \$699.00 |
|-------|---------------------|----------|

TRANSCEIVERS

| | | |
|-------|---------------------------------------|-----------|
| TR-7 | Transceiver | \$1100.00 |
| DR-7 | Digital Readout | \$195.00 |
| RV-7 | Remote VFO for TR7 | \$195.00 |
| FA-7 | Fan for TR-7 | \$25.00 |
| MS-7 | Speaker for TR-7 | \$33.00 |
| 7077 | Dynamic Desk Mike for TR7 | \$45.00 |
| 34PNB | Plug-in Noise Blanker for TR-4 Series | \$100.00 |

LINEAR AMPLIFIER

| | | |
|------|-----------------------------------|----------|
| L-4B | Linear and w/power supply & tubes | \$995.00 |
|------|-----------------------------------|----------|

MATCHING NETWORKS

| | | |
|------------|--|----------|
| MN-4C | Antenna Matching Network. 200W | \$165.00 |
| MN-2000 | Antenna Matching Network. 1000W | \$250.00 |
| W-4 | RF Wattmeter, 1.8 to 54 MHz | \$79.00 |
| WV-4 | RF Wattmeter, 20 to 200 MHz | \$89.00 |
| 7073 | Hand-Held Microphone | \$19.00 |
| 7075 | Desk Top Microphone | \$45.00 |
| 1525EM | Push-button Encoding Microphone | \$49.95 |
| HS-1 | Head Phones | \$10.00 |
| AA-10 | 10W, 2M Amplifier | \$49.95 |
| TV-300-HP | 300 ohm High Pass TV Set Filter | \$10.60 |
| TV-75-HP | 75 ohm High Pass TV Set Filter | \$13.25 |
| TV-42-LP | Transmitter Low Pass Filter. 100W | \$14.60 |
| TV-3300-LP | Transmitter Low Pass Filter. 1000W | \$26.60 |
| TV-5200-LP | Transmitter Low Pass Filter. 1000W. 100W, 6M | \$26.60 |

HAMTRONICS - WHERE THE HAM IS KING



USED GEAR • TRADE UP • FREE UPS SHIPPING ON PREPAID ORDERS

\$2,000,000 HAM INVENTORY

THE LOWEST POSSIBLE PRICES

COLLINS AMATEUR EQUIPMENT

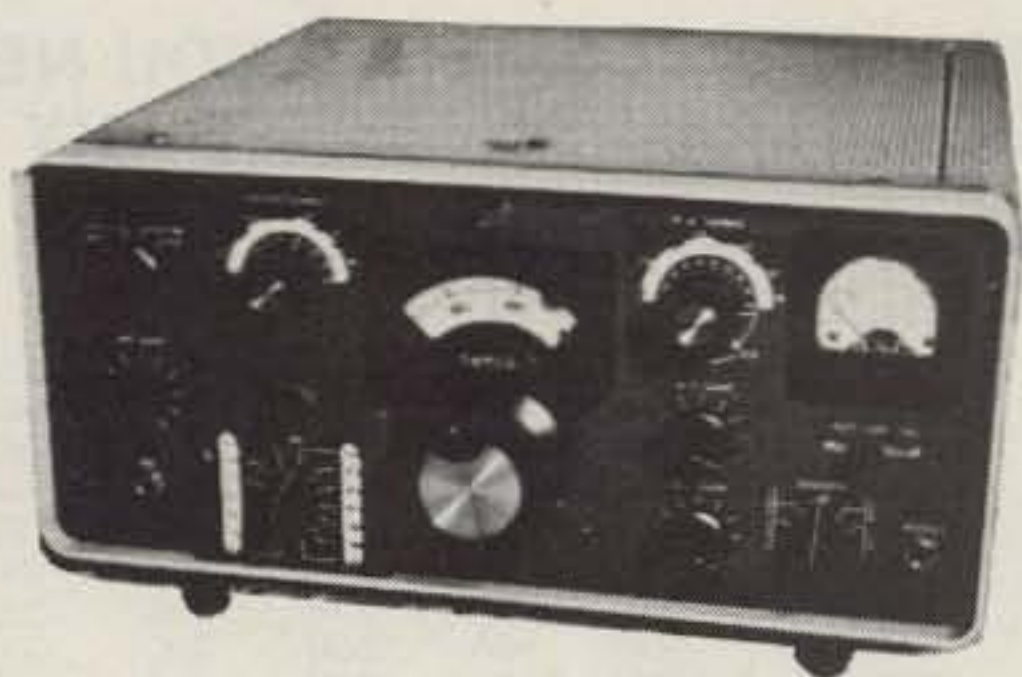

KWM-2A TRANSCEIVER \$3533.00
 Unmatched for mobile and fixed station applications. 175W on SSB, 160W on CW. Switch select up to 14 optional Xtals. Can be used for RTTY. Filter type SSB generation. Automatic load control. Inverse RF feedback. Reimability-tuned variable oscillator.

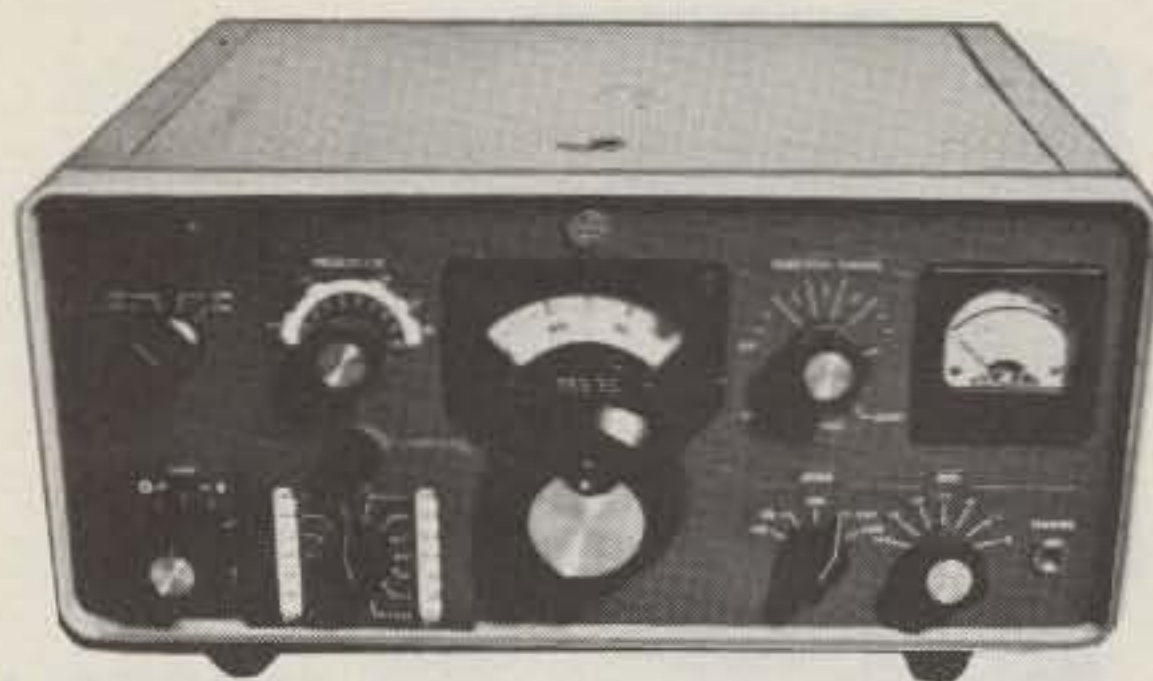

75S-3C RECEIVER \$3000.00
 Sharp selectivity. SSB, CW and RTTY. Single control rejection tuning. Variable BFO. Optional mechanical filters for CW, RTTY and AM. 2.1 KHz mechanical filter. Zener regulated oscillators. 3-position AGC.



32S-3A TRANSMITTER \$3250.00

Covers all ham bands between 3.4 MHz and 30 MHz. Nominal output of 100 W. 175 W, SSB and 160 W CW. Dual conversion. Automatic load control. RF inverse feedback. CW spotting control. Collins mechanical filter.



312B-3 SPEAKER
 \$95.00



312B-4 SPEAKER CONSOLE
 \$648.00



312B-5 VFO CONSOLE
 \$1616.00



516F-2 AC POWER SUPPLY
 \$440.00



302C-3 DIRECTIONAL WATT METER
 \$493.00



DL-1 DUMMY LOAD
 \$270.00

THE BIG 'H' FOR ALL YOUR HAM NEEDS!

CALL JIM TITUS FOR FREE QUOTES ON TOLL FREE NO. 800-523-8998

HAMTRONICS

DIVISION OF TREVOSSE ELECTRONICS
 4033 Brownsville Rd • Trevose, Pa. 19047
 (215) 257-1400 / (215) 757-5300

WE HAVE WHAT YOU NEED AT...

BIRD THRULINE® WATTMETER

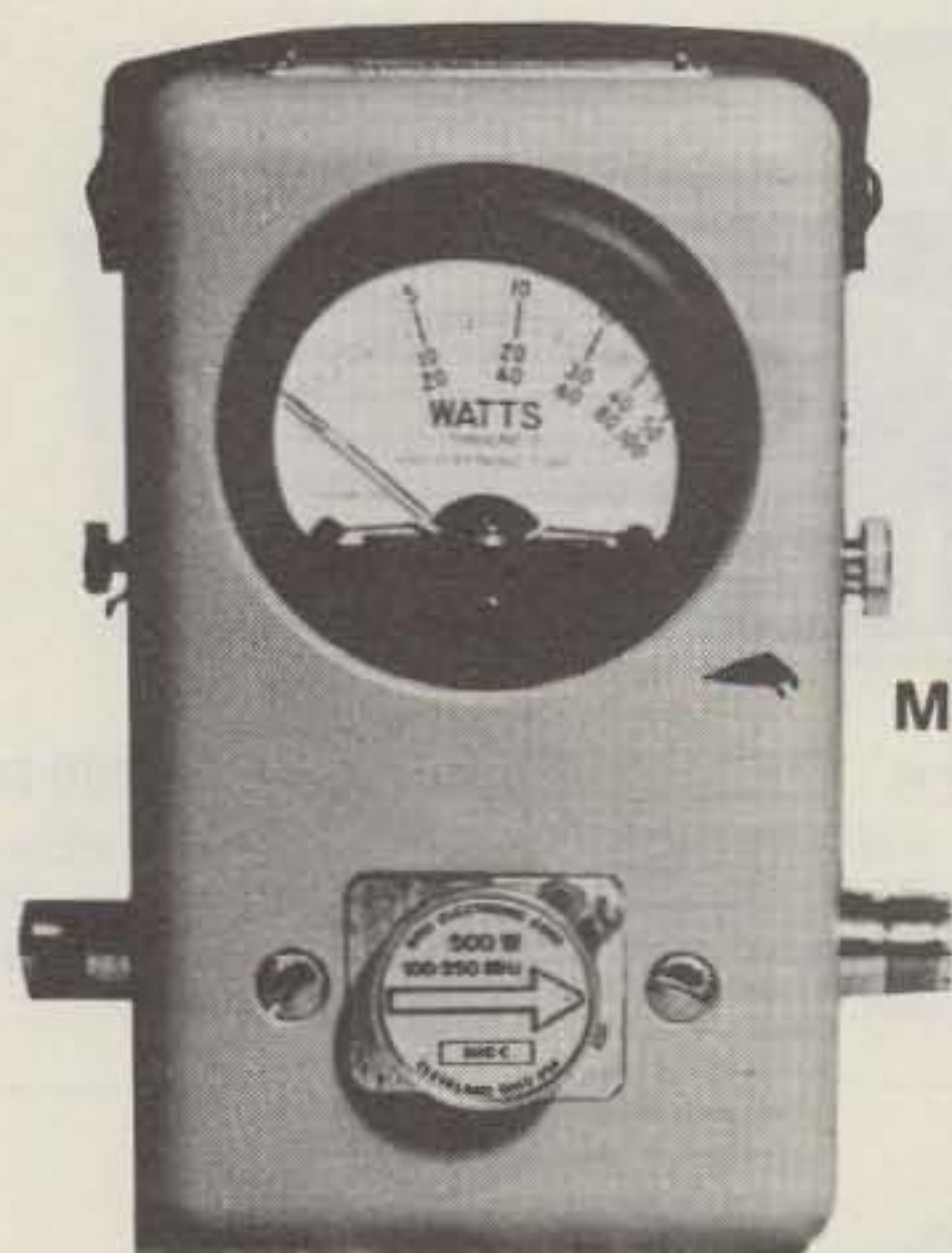

MODEL 43

- BUY ONLY THE ELEMENTS YOU NEED AND ADD EXTRA RANGES AT ANY TIME
- READ RF WATTS DIRECTLY

**Table 1
STANDARD
ELEMENTS**

| Power Range | Frequency Bands (MHz) | | | | | |
|-------------|-----------------------|-------|--------|---------|---------|----------|
| | 2-30 | 25-60 | 50-125 | 100-250 | 200-500 | 400-1000 |
| 5 watts | — | 5A | 5B | 5C | 5D | 5E |
| 10 watts | — | 10A | 10B | 10C | 10D | 10E |
| 25 watts | — | 25A | 25B | 25C | 25D | 25E |
| 50 watts | 50H | 50A | 50B | 50C | 50D | 50E |
| 100 watts | 100H | 100A | 100B | 100C | 100D | 100E |
| 250 watts | 250H | 250A | 250B | 250C | 250D | 250E |
| 500 watts | 500H | 500A | 500B | 500C | 500D | 500E |
| 1000 watts | 1000H | 1000A | 1000B | 1000C | 1000D | 1000E |
| 2500 watts | 2500H | | | | | |
| 5000 watts | 5000H | | | | | |

**Table 2
LOW-
POWER
ELEMENTS**

| 1 watt | Cat. No. | 2.5 watts | Cat. No. |
|-------------|----------|-------------|----------|
| 60-80 MHz | 060-1 | 60-80 MHz | 060-2 |
| 80-95 MHz | 080-1 | 80-95 MHz | 080-2 |
| 95-125 MHz | 095-1 | 95-150 MHz | 095-2 |
| 110-160 MHz | 110-1 | 150-250 MHz | 150-2 |
| 150-250 MHz | 150-1 | 200-300 MHz | 200-2 |
| 200-300 MHz | 200-1 | 250-450 MHz | 250-2 |
| 275-450 MHz | 275-1 | 400-850 MHz | 400-2 |
| 425-850 MHz | 425-1 | 800-950 MHz | 800-2 |
| 800-950 MHz | 800-1 | | |

WE HAVE A COMPLETE STOCK OF ALL BIRD WATTMETERS AND SLUGS

ATLAS



| | | |
|--------|---|---------|
| 210X | Transceiver. 10-80M. 200W | 765.00 |
| 215X | Transceiver. 15-160M. 200W | 765.00 |
| DMK | Deluxe Mtg. Kit for 210X & 215X | 55.00 |
| 220CS | AC Console for 210X & 215X | 155.00 |
| 350-XL | Transceiver. SSB. Solid State. 10-160M. 350W. | 1195.00 |

| | | |
|--------|--|--------|
| DD6-XL | Digital Dial Readout for 350-XL | 229.00 |
| 305 | Plug-In Auxiliary VFO. For 350-XL | 155.00 |
| 311 | Plug-In Auxiliary Crystal Oscillator for 350-XL | 135.00 |
| 350-PS | AC Pwr Supply w/Spkr & Phone Jack for 350-XL | 229.00 |
| DMK-XL | Mobile Mounting Bracket for 350-XL. Easy Plug-In | 65.00 |



USED GEAR • TRADE UP • FREE UPS SHIPPING ON PREPAID ORDERS

\$2,000,000 HAM INVENTORY

HAMTRONICS-WHERE THE HAM IS KING

THE LOWEST POSSIBLE PRICES

NYE VIKING



No. 114-310-003 \$9.65



No. 114-310-004GP \$50.00



No. 114-404-002 \$20.75

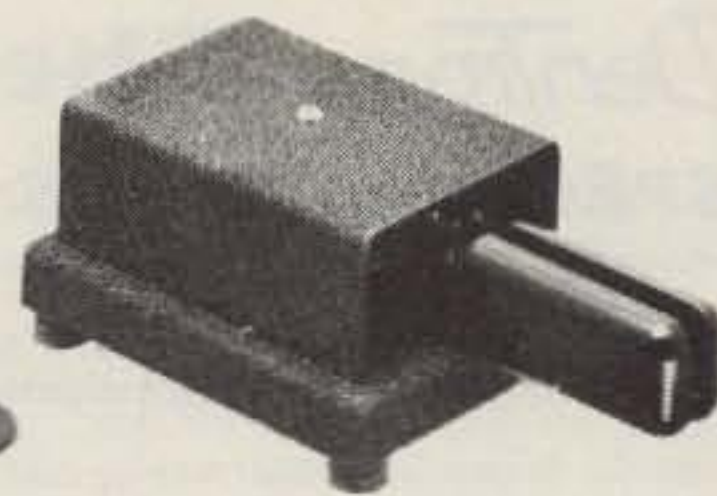

No. SSK-1 \$23.95



No. 250-46-1 \$36.50



No. 250-46-3 \$46.50



No. 250-20-1 \$19.95



No. MB2-1 \$315

NPC

2.5 AMP



12CB4 29.95

4 AMP



103R 39.95

6 AMP



104R 49.95

12 AMP

108 RM
\$104.95



25 AMP

109R 159.95



VIBROPLEX



"PRESENTATION"
72.50

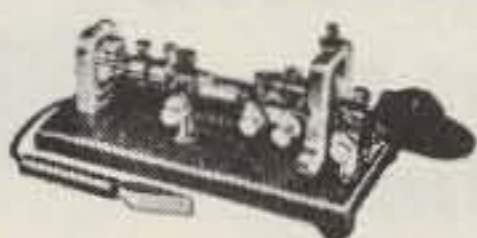

"ORIGINAL"
49.95



"LIGHTNING BUG"
49.95



"CHAMPION"
46.50



VIBRO-KEYER
46.50

THE BIG 'H' FOR ALL YOUR HAM NEEDS!

CALL JIM TITUS FOR FREE QUOTES ON TOLL FREE NO. 800-523-8998

HAMTRONICS

DIVISION OF TREVOSE ELECTRONICS
4033 Brownsville Rd • Trevose, Pa. 19047
(610) 257-1100 / (610) 257-5200

WE HAVE WHAT YOU NEED AT...

DenTron The MT-3000A

SPECIFICATIONS:

- Power handling capability in excess of 3 KW PEP
- Front Panel Antenna Switch with 5 Antenna Inputs plus Tuner bypass position
- Built-in 50 Ohm—250 Watt dummy load
- Dual Wattmeters
- Compact: 5 1/4" x 14" x 14", 18 pounds
- Continuous Tuning 160-10 meters
- 3 Core Heavy-Duty Balun



349.50

The evolution of the MLA



When the MLA-2500 was first introduced it was a new concept in high performance amplifiers. Low and sleek yet powerful enough for the military. Some wondered... needlessly.

A promise kept.

The MLA-2500 promised 2000 watts PEP input on SSB. A heavy duty power supply. Two Eimac 8875's. And as thousands of Amateurs across the world have proven, the MLA-2500 delivers!

Now DenTron is pleased to bring you The new MLA-2500B. Inherently the same as the original MLA-2500, the B model includes all of the above specifications plus a few refinements. New high-low power switching for consistent efficiency at both the 1KW and 2KW power levels, and 160-15 meters.

Tested and proven.

What better test for an amplifier than the Clipperton DXpedition? Even after 32,000 QSO's, and an accidental dunk in the ocean, the same 3 MLA-2500's are still amplifying other rare DXpeditions around the world—listen for them.

Convinced? Isn't it time you owned the amplifier that powered Clipperton and thousands upon thousands of radio stations throughout the world?

MLA-2500B \$899.50

DenTron Super Tuner



160-10 Meters
Balanced Line,
Coax, Random
or Long Wire

Maximum Power Transfer, Xmitter to Antenna.

1 KW Model \$129.50

3 KW Model \$229.50

If they copy the quality, they can't meet the price.

The original DenTron Super Tuner. The original Super Tuner. The original MT-3000A. And now DenTron brings you the original MT-2000A, an economical, full-power tuner designed to handle virtually any type of antenna.

The sleek styling and low profile of the MT-2000A is beautiful, but be assured that is only a part of the excitement you'll derive from the MT-2000A. The MT-2000A is designed and engineered using heavy-duty all-metal cabinetry, and high quality American components throughout.

When you consider the MT-2000A's unique features: 5 1/4" H x 14" D x 14" W, front panel coax bypass switching, front panel lightning protection antenna grounding switch, 3KW PEP, and the ability to match coax, random wire and balanced feedline, we're sure you'll decide to buy an American original and stay with DenTron.



DenTron

MT-2000A \$199.50

DenTron

JR. MONITOR™ Antenna Tuner



Continuous tuning from 1.8-30 MHz. 300 watt power capability. Forward reading relative output power meter—simply tune JR. MONITOR™ controls for maximum RF output on the meter. Built-in balun. Mobile mounting bracket. Ceramic rotary 12-position switch. Capacitor spacing 1000 volts. Tapped toroid inductor. Antenna inputs: coax unbalanced SO 239, random wire, balanced feed line 75-660 ohm. Weight: 2 1/2 pounds.

\$79.50

Big Dummy w/coolant



\$29.50

All Band Doublet

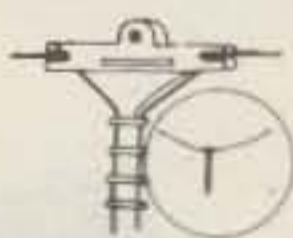

This All Band Doublet or inverted Type Antenna covers 160 thru 10 meters. Has total length of 130 feet (14 ga. stranded copper) although it may be made shorter if necessary. This tuned Doublet is center fed through 100 feet of 450 ohm PVC covered balanced transmission line. The assembly is complete. Add rope to the ends and pull up into position. Tune with the DenTron Super Tuner and you're on 10 through 160 meters with one antenna! Now just for the DenTron All Band Doublet.

\$24.50

DenTron W-2 PAD INLINE WATTMASTER

Read forward and reflected watts at the same time

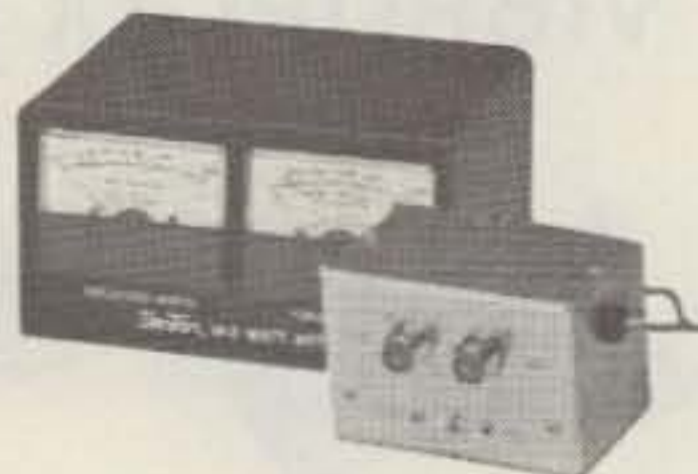

Tired of constant switching and guesswork?

Every serious ham knows he must read both forward and reverse wattage simultaneously for that perfect match. So upgrade with the DenTron W-2 Dual in line Wattmeter.

\$99.50



USED GEAR • TRADE UP • FREE UPS SHIPPING ON PREPAID ORDERS

\$2,000,000 HAM INVENTORY

HAMTRONICS - WHERE THE HAM IS KING

THE LOWEST POSSIBLE PRICES

TEN-TEC INC.

TRITON IV EQUIPMENT



TRANSCEIVERS

MODEL 540-200W, SSB/CW
3.5 - 30 MHz **\$699.00**

MODEL 544- DIGITAL, 200W
SSB/CW, 3.5 - 30 MHz **\$869.00**

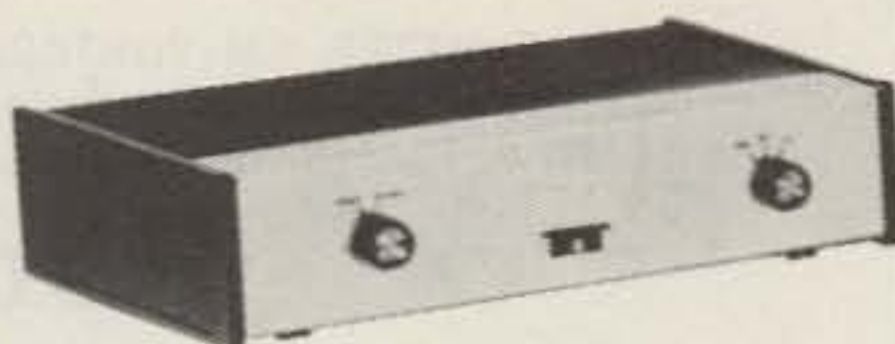

MODEL 240 **\$110.00**
ONE - SIXTY CONVERTER



MODEL 242 **\$179.00**
REMOTE VFO

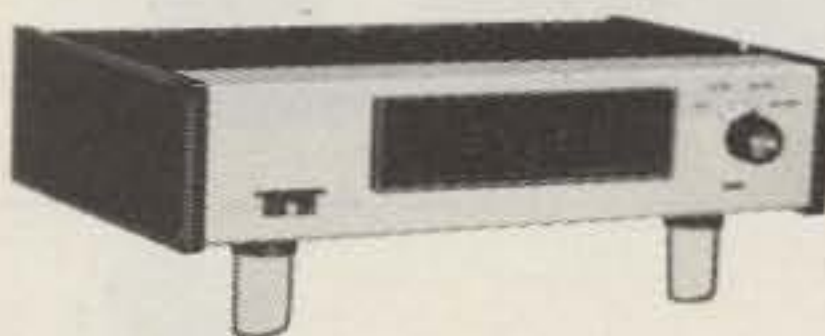

MODEL 244 **\$197.00**
DIGITAL READ OUT/COUNTER



MODEL 262-M **\$145.00**
DELUXE POWER SUPPLY

ARGONAUT



MODEL 509 **\$369.00**
SW, SSB/CW, 3.5-30 MHz

LINEAR AMPLIFIER

MODEL 405 **\$159.00**
100W, 3.5 - 30 MHz

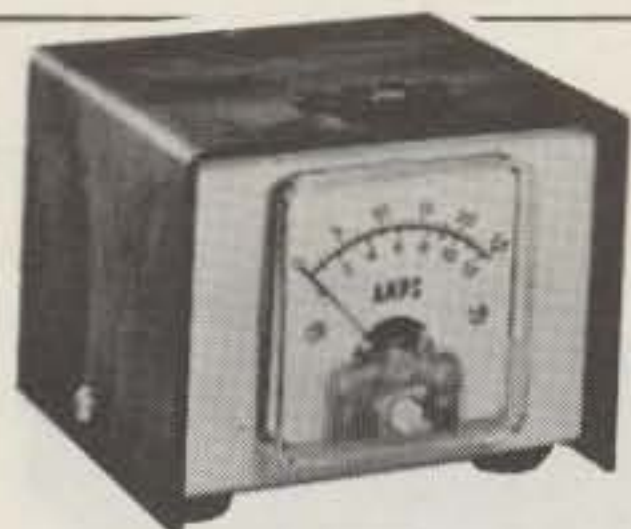

AMMETER
207 **\$14.00**



XTAL CALIBRATOR
206-A **\$29.00**

KEYERS



ELECTRONIC KR-50
\$110.00

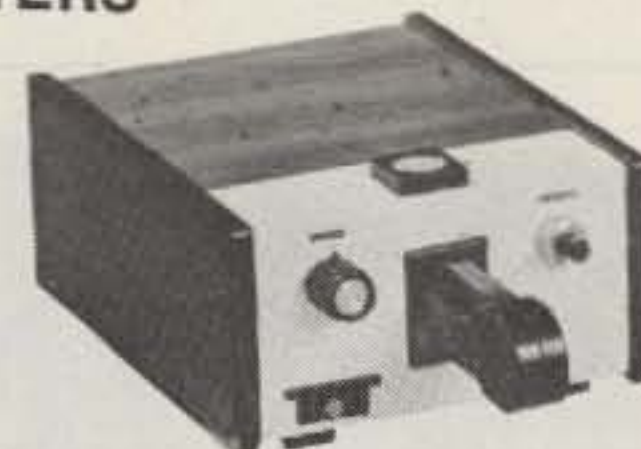

ELECTRONIC KR20-A **\$69.50**



ELECTRONIC KR-5A
\$39.50



KR-2A **\$17.00**



KR1-A **\$35.00**

CALL JIM TITUS FOR FREE QUOTES ON TOLL FREE NO. 800-523-8998

HAMTRONICS

DIVISION OF TREVISE ELECTRONICS
4033 Brownsville Rd • Trevose, Pa. 19047

THE BIG 'H' FOR ALL YOUR HAM NEEDS!

WE HAVE WHAT YOU NEED AT...



VHF/UHF AMATEUR & MARINE EQUIPMENT



VHF/UHF AMATEUR & MARINE EQUIPMENT

IC-245. SSB 146 MHz FM 10W x CVR. LSI synthesizer with 4 digit LED readout. Xmit & Rev frequencies independently programmable. 60 dB spurious attenuation.

\$545.00

IC245SSB.....**\$689.95**

IC-215. 2 METER FM PORTABLE. Three narrow filters for superb performance. 3W or 400 mW. 15 CH. capacity. MOS FET RF Amp & 5 tuned cks. S-meter front panel.

\$239.00



\$265.00

IC-502. 6 METER SSB & CW PORTABLE XCVR. Includes antenna & battery pack. 3W PEP & stable VFO for fun & FB QSO's. Covers first 800 KHz of 6M band, where most activity is.



IC-211

IC-211. 4 MEG, MULTI-MODE 2M XCVR. 144-145 MHz on SSB & CW, plus 146-147 MHz on FM. Work AMAT OSCAR six or seven. LSI synthesizer with 7 digit LED. MOS FET RF Amp, 5 helical cavities, FET mixer & 3 I.F. filters.

\$850.00

\$1650.00



IC701 W/POWER SUPPLY & MIKE • Dual Independent UFO's Built-in • 100 Watts Output • All HF Bands, 160-10M • Fully Synthesized Tuning • Continuously Variable Bandwidth • Double Balanced Schottky Diode 1st Mixer • RF Speech Processor • VOX; Fastbreak in CW; RIT; AGC; Noise Blanker; Full Metering •

IC280.....**\$480.00**



IC-21A. 146 MHz FM 10W XCVR. MOS FET RF Amp & 5 helical resonator filter, plus 3 I.F. filters. IDC modulation control. Variable output pwr: 500 MW to 10W Front panel discriminator meter. SWR bridge. 117 VAC and 13.6 VDC pwr supplies.

\$399.00

DV-21. DIGITAL VFO. Use with IC-21A to complete 2M band.

\$299.00

IC-202. 2 METER SSB PORTABLE XCVR. Puts sideband in your hand! Internal C batteries or external 12 VDC. 3W PEP. True I.F. noise blanker. 144.0, 144.2 on two other 200 KHz bands,selectable. Hamtronics stocks 145.2 and 145.8-146.0 MHz for calling frequency & satellite band.

\$275.00



IC-30A. 450 MHz FM LOW XCVR. 1W or 10W. Low noise MOS-FET RF Amp & 5 section helical filter. 22 CH. capacity. S-meter & relative power output meter. IDC modulation control.

\$440.00

CALL JIM TITUS FOR FREE QUOTES ON TOLL FREE NO. 800-523-8998

\$2,000,000 HAM INVENTORY

HAMTRONICS-WHERE THE HAM IS KING

THE LOWEST POSSIBLE PRICES



— TRANSCEIVERS —



Single-Sideband Transceiver
350B \$649.95



350D \$749.95

Full 300 Watts PEP input on single-sideband • Selectable 80 or 100 Hz CW audio filter • Built-in AC power supply • Built-in 25 kHz crystal calibrator for model 350A • Meets or exceeds all FCC specifications for purity of emissions.

Model 350D has the same specifications and characteristics as the Model 350A except the unit comes with a built-in digital frequency display with readout to 100 Hz as standard equipment.

HF 700S \$699.95
HF 700S/SS16B \$799.95

— POWER SUPPLIES —



Precision power supplies provide all input required by Swan transceivers. DC converters adapt the AC power supplies for mobile or portable use to a standard 12 V automobile battery

- Power supplies are ideal for temporary operation, such as vacations, short trips, remote installations and emergencies
- Swan power supplies are designed for long reliable service.

PSU-3 Universal Power Supply • 115/230 VAC • Built in Speaker \$175.95
117 x AC Economical AC Power Supply w/out cabinet or speaker \$129.95

— ACCESSORIES —



510X 10 Channel Crystal Controlled Oscillator \$69.95
VX-2 Plug-in VOX \$49.95
FP-4 Phone Patch \$69.95
SS16-B 16 Poll Filter Kit \$99.95

— METERS —



WM6200 In-line Precision Wattmeter for 2M. 2 Scales to 200 W. Reads SWR \$87.95
FS-2 SWR & Field Strength Meter \$19.95
SWR-3 Pocket SWR Meter \$14.95
SWR-1A Relative Power Meter & SWR Bridge \$29.95
FS1 Pocket Field Strength Meter \$13.95
WM1500 In-line Wattmeter. 4 Scales to 1500W. 2 to 50 MHz \$74.95
WM2000A Peak Reading SWR Wattmeter... \$89.95

NEW! 100 MX Mobile Transceiver



The 100 MX Mobile Transceiver is completely solid state and incorporates state-of-the-art design and styling.

The receiver sensitivity is better than 0.35 uv at 50 ohms for 10 db signal plus noise-to-noise ratio for all bands. Audio output is four watts into four ohm load. Audio bandpass response is 300 to 3000 Hertz. Provisions for an external speaker or headphones are on the rear panel and a gimbal-type mobile mount is included as standard equipment.

THE BIG 'H' FOR ALL YOUR HAM NEEDS!

CALL JIM TITUS FOR FREE QUOTES ON TOLL FREE NO. 800-523-8998

HAMTRONICS

DIVISION OF TREVOSSE ELECTRONICS
4033 Brownsville Rd • Trevose, Pa. 19047
(215) 257-1100 (215) 757-5200

CB to 10

— part XV: a Realistic HT

Photo by James Clegg



Walkie-talkie using external antenna connection to wattmeter and dummy load. Unit showed an output of over 1.5 Watts at 29.000 MHz.

The CB frequencies were recently expanded from 23 to 40 channels to handle the increased number of citizens using the band. Since many firms became "well off" from the sale of the 23-channel units, the thought was that the "gold mine" was going to strike a new vein and that the new 40-channel units would be the hottest thing going. So, everyone began dumping the 23-channel units at very attractive prices. Many hams were quick to grab the opportunity of getting some first class communications gear at a good price, and the CBers bought them up also at a fast rate.

Now enters a problem: So many transceivers of 23-channel capacity had been sold that when the 40-channel units came out, there just was not the anticipated demand for them, so now even 40-channel units can be found at low prices. Those who did buy the new 40-channel radios quickly found out that the high-powered "skip-land" boys had been up there for years, so the additional 17 channels were just about useless for the purpose for which the Citizens Band Service was established.

The word is apparently out that many manufacturers now believe that the market is saturated, and many bargains are appearing in CB gear. This is how I came to be the possessor of a couple of walkie-talkie units to convert to 10 meters. The radio is a 3-channel, 2-Watt input, 1-Watt output walkie-talkie, the Realistic TRC-180. My unit showed an output of slightly more than 1.5 Watts on a wattmeter into a dummy load, using fresh batteries. The unit normally sells for \$40.95; I purchased these at \$24.95 each, almost a 50% savings.

Specifications show that the unit has excellent sensitivity (.5 mV for 10 dB S+N/N) and spurious emission down -50 dB or better. The receiver draws 25

to 150 mA, depending on squelched or received signal condition, and the transmitter uses 250 to 500 mA. The walkie-talkie comes with CB channel 14 already installed, plus a set of AA batteries. Checkout showed that the unit was working perfectly. Some plus features include an earphone jack, an external antenna jack (to use a mobile or base station antenna), a power jack that allows you to connect to a 12 V dc source (such as a car battery), a charger jack for recharging nickel cadmium batteries without removing them, and a battery test button with LED indicator to show the condition of the batteries. There is no guesswork on the LED: If it lights, the batteries are okay; if they're not alright, there's simply no light!

The walkie-talkie was easily converted to 10 meters with just a substitution of crystals and the retuning of the transmitter and receiver

stages. After looking at a number of schematics on the general run of units of this nature, the majority have the basic 455 kHz i-f, so conversion of most should be fairly simple. I designated the channel "A" position to be 29.000 MHz, which calls for that frequency for the transmitter, of course, and a 28.545 MHz crystal for the receiver. I still have two additional channels to add, when the need arises. The built-in antenna measures 39½ inches long extended and has an internal loading coil. Rather than messing with the coil, I just reduced the length of the whip by almost 3 inches (using a field strength meter to find the point of maximum output of rf) to make it resonant at 29 MHz. To ensure that I returned each time to the proper length, I simply marked the top section by scratching on the metal rod.

Now, if we are going to be able to utilize these bargain

low-powered transceivers on 10 meters for a whole bunch of fun, frequency placement will to a great extent determine the usefulness. There are a number of band plans around, with each one extolling its own virtues. Yes, I have one, too! It's quite simple, and, best of all, it is using a section of the band that is not heavily used at the present. Looking at one plan, the proposal calls for (what I call the AM band) channel 1 to start only 10 kHz inside (what I call the SBB band) at 28.560 MHz, and, from there, the spacing is in steps according to the original CB channels. Shades of 75 meters, AM versus SSB, back in the old days! I can just imagine how these low-powered radios will play when the band opens up a little and that funny "Donald Duck" stuff starts coming in. It'll be just like the HF bands back in the 1960s — one big hassle, then the demise of AM.

Why not avoid the prob-

lem to begin with and put these converted CB radios up a ways in the band? This way everyone has lots of room to do "their own thing," and if the sideband boys want to QSY to talk to the AM QRP fellows, well fine! So, let's simplify things and be "good guys" in the process.

CW — 28 to 28.5 MHz
SSB — 28.5 to 29 MHz
AM — 29 to 29.290 MHz

I realize that CW is not restricted, but very seldom do you hear it above 28.5 MHz, simply because of good operators plus there is 500 kHz to move around in. The SB boys have a lot of room also, and, as a matter of course, do not normally go above 29 MHz. With a band the size of 10 meters, there's room for all, and QRP operation with these converted radios will be most enjoyable. If we want to make it hard on ourselves, well then hardly anyone (besides Quack, Quack) will be able to talk! See you on channel 1, 29.000 MHz! ■

New Products

from page 227

keys the transmitter.

Program RTTY has two modes: send and receive. In the receive mode, the mark and space tones will be decoded and the resulting text displayed on the video monitor. Either

wide or narrow shift at 60 wpm will work equally well. Both HF and VHF reception are accommodated. In the send mode, all Baudot characters and punctuation may be sent from the keyboard. In addition, up to ten programmable message memories (2550 characters total)

allow "brag tapes," pictures, etc., direct from the keyboard. A special feature allows sending the time automatically at the press of a single key! Automatic FIGS (shift), LTRS (unshift), line feed, and unshift-on-space are included. Reverse screen image separates sending from receiving text. One key allows switching between send and receive. *Microtronics, 5943 Pioneer Road, Hughson CA 95326; (209)-634-8888.*

ALLBAND MINIATURE DIPOLE

Antennas by Smithe has come up with a truly portable allband miniature dipole complete with its own carrying case and mast/hardware to mount on a camera tripod or 3/8" x 24 stud. High performance is obtained with the HF Bantam Dipole on 80-10 meters at its normal 13 foot length, or the same antenna may be shortened to 7 feet for 75-10 meter coverage. Polarization is quickly interchangeable from horizontal to vertical. No ground system is necessary. The HF Bantam Dipole is ideal for camping, traveling, mountaintopping, apartment living, or if you're stuck with building code restrictions. Construction is of high quality 6061-T6 aluminum and stainless steel hardware.

Dealer inquiries are invited. U.S. patent pending. Send an SASE for spec sheet and other Smithe antenna products to *Comm Center, Inc., Laurel Plaza—Rte. 198, Laurel MD 20810; (301)-792-0600.*

NEW-TRONICS INTRODUCES 5- AND 11-ELEMENT HUSTLER 2 METER YAGI ANTENNAS

Two models of the new Star Tracker™ series of Hustler 2 meter yagi antennas have been announced by New-Tronics Corporation. These 5- and 11-element rotatable beam antennas are completely tunable from 144-148 MHz, with a unique adjustable matching system for 1.5:1 or better swr. At resonance, swr is typically 1.1:1. This system provides for optimum energy transfer without sacrificing gain or pattern control.

High forward gains and large front-to-back ratios put Hustler 2 meter yagis in an ultra-high performance category. Half-power (3 dB) beamwidths are exceptionally narrow. In addition, each model can be easily mounted for vertical or horizontal polarization for station-to-station VHF DX work.

The Star Tracker model ST-5

Continued on page 242

Smithe's new HF Bantam Dipole.

The Circuit Board Aquarium

—no fish story

John A. Burton WB9QZE
2282 McKinley Ave.
Columbus IN 47201

I have always wanted a better way to etch my printed circuit boards than by hand agitating a tray. A couple of years ago, my wife was putting away her aquarium equipment when an idea hit me. At the com-

pany where I work, we have an etching tank that is agitated by air, and my wife's aquarium tank was also agitated by air. What I needed now was a tank that would require the minimum amount of etching solution and a way of dispersing the air. Another consideration was how large to make the tank, or how large a printed circuit

board would I ever need to etch. I finally decided on a tank size which could be filled with one pint of etching solution. This came out to be 7 x 10-5/16 inches. These are inside dimensions and can be changed to suit each individual's needs. In order to disperse the air, a divider is placed at the bottom of the tank with a series of holes drilled in it. This has worked out very well in dispersing the air. The cost of the material is about \$15 if

you have to buy it all new. This breaks down to \$7 for the air pump, \$5 for the Plexiglas™, and \$2 for the tubing and aquarium cement. All these parts, with exception of the Plexiglas™, can be found at most stores that have a tropical fish section, or, if you are lucky, at some garage sales.

Construction

Construction is not very difficult (refer to Fig. 1). The first thing is to deter-



Completed etching tank in action showing removal of finished PC board.

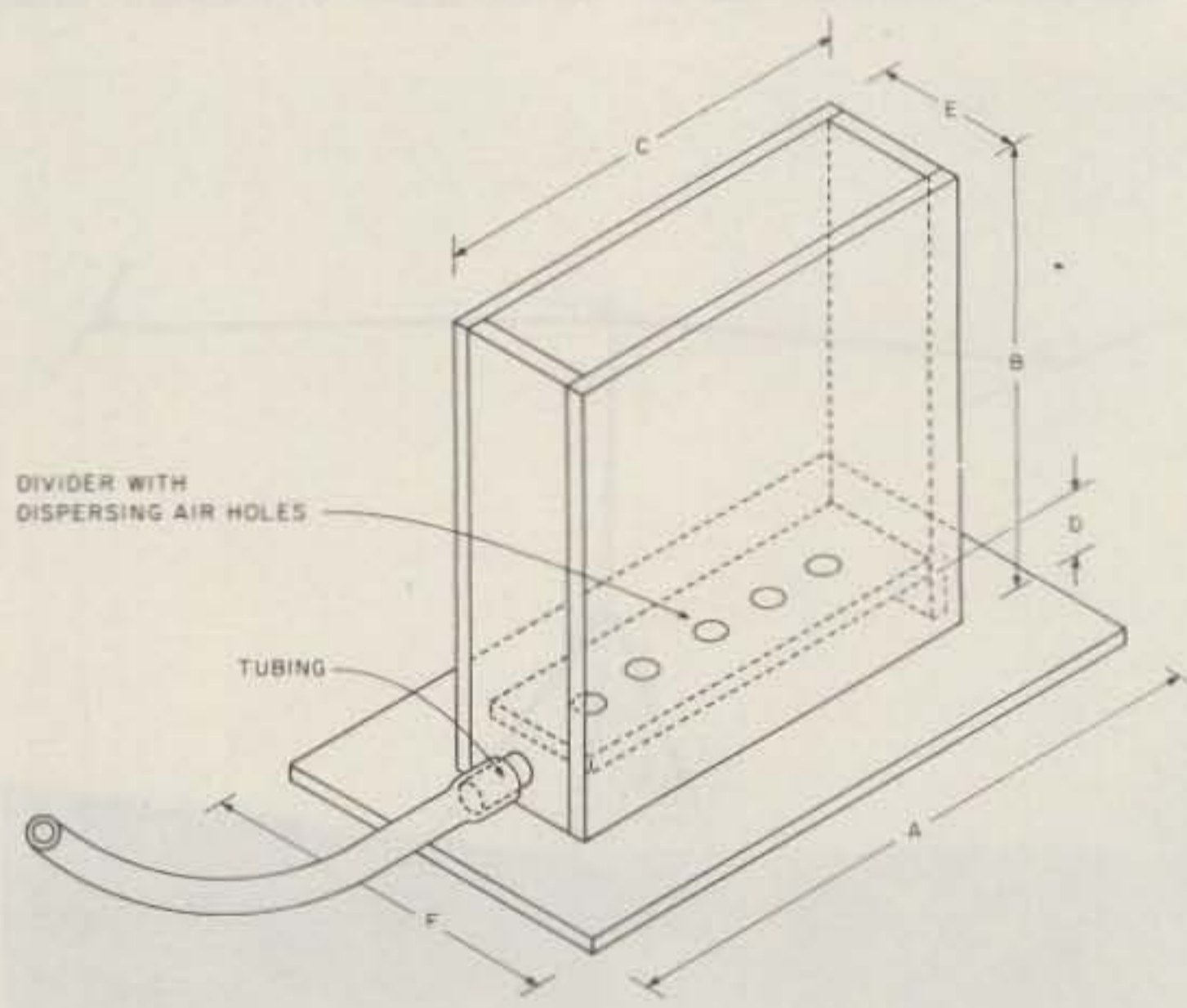
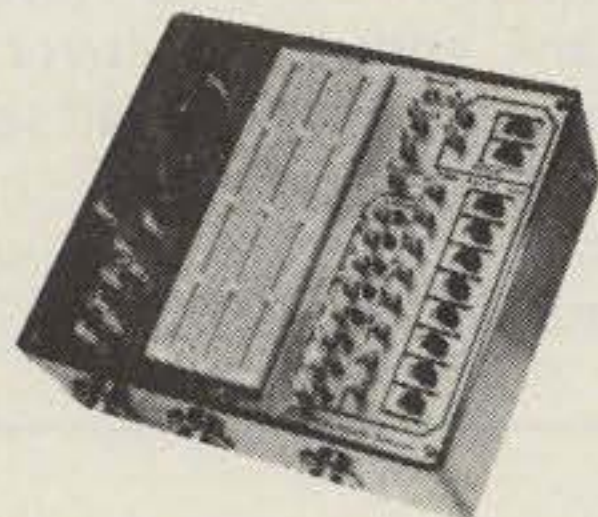

Fig. 1. Etching tank construction details.

YOUR BEST BUYS IN KITS & FREQUENCY COUNTERS

6 GOOD REASONS FOR BUYING A HAL-TRONIX FREQUENCY COUNTER

(1) 100% COMPLETE KIT, (2) EASY ASSEMBLY, (3) COMPLETELY ENCLOSED IN METAL CABINET, (4) IC SOCKETS USED THROUGHOUT FOR EASY TTL REPLACEMENT (5) EASY ON YOUR POCKET BOOK, AND (6) NO EXPENSIVE CHIPS TO REPLACE (EXAMPLE—IF YOU LOSE A DECODER, LATCH OR DRIVE IN A HAL-TRONIX COUNTER, THE AVERAGE COST OF REPLACEMENT OF THE LOW-COST TTLS IS LESS THAN \$1.00 EXCLUDING THE PRE-SCALE CHIP. IN SOME OF THE NEWER COUNTERS NOW BEING MARKETED BY MY COMPETITION, THEY ARE USING THE EXOTIC SINGLE CHIP AND WOULD COST YOU CLOSE TO \$30.00 TO REPLACE). THIS IS SOMETHING YOU SHOULD CONSIDER.



ANALOG-DIGILAB KIT \$139.50

DESIGNED BY HAL-TRONIX AND MIKE GOLDEN OF R.E.T.S. ELECTRONICS SCHOOL OF DETROIT. FOR RUGGED CLASSROOM USE.

FOR THE RADIO AMATEUR, STUDENT, EXPERIMENTER OR DESIGNER SPECIFICATIONS: OUTPUT VOLTAGES: +5V, +12V, -12V; USABLE CURRENT: 750mA; % Regulation at 500mA: 0.2%; Short-circuit limited at 1.0 amp; Thermal overload protected. Power requirements: 117VAC, 60HZ, 40 Watts. Function Generator: Frequency range: 1HZ to 100HZ in 5 bands. Amplitude adjustable from 0 to 10 VPP. DC offset adjustable from 0 to ± 10V. Waveforms: Sine, square, triangular and TTL Clock. TTL Clock 0 to +5V level, 200 ns rise and fall time. Frequency determined by Function Generator. Output impedance 1.2K ohm.

Most of all, it's easy to construct and service. PC boards are predrilled, plated thru and solder flowed. Over 1000 units sold to schools.



FROM HAL-TRONIX FIRST TIME OFFER

SIX-DIGIT ALARM CLOCK KIT for home, camper, RV, or field-day use. Operates on 12-volt AC or DC, and has its own 60-Hz time base on the board. Complete with all electronic components and two-piece, pre-drilled PC boards. Board size 4" x 3". Complete with speaker and switches. If operated on DC, there is nothing more to buy.*

PRICED AT \$16.95
Twelve-volt AC line cord for those who wish to operate the clock from 110-volt AC. \$2.50

*Fits clock case advertised below.

TOUCH TONE DECODER KIT

HIGHLY STABLE DECODER KIT. COMES WITH 2 SIDED, PLATED THRU AND SOLDER FLOWED G-10 PC BOARD, 7-567's, 2-7402, AND ALL ELECTRONIC COMPONENTS. BOARD MEASURES 3 1/2 x 5 1/2 INCHES. HAS 12 LINES OUT. ONLY \$39.95

6-DIGIT CLOCK • 12/24 HOUR

COMPLETE KIT CONSISTING OF 2 PC G10 PRE-DRILLED PC BOARDS, 1 CLOCK CHIP, 6 FND 359 READOUTS, 13 TRANSISTORS, 3 CAPS, 9 RESISTORS, 5 DIODES, 3 PUSH-BUTTON SWITCHES, POWER TRANSFORMER AND INSTRUCTIONS.

DON'T BE FOOLED BY PARTIAL KITS WHERE YOU HAVE TO BUY EVERYTHING EXTRA.

PRICED AT \$12.95

CLOCK CASE Available and will fit any one of the above clocks. Regular Price ... \$6.50 But Only \$4.50 when bought with clock

60-HZ TIME BASE CRYSTAL TIME BASE KIT. WILL ENABLE MOST ALL DIGITAL CLOCKS TO OPERATE FROM 12 VDC. LOW PROFILE UNIT, EASY 3-WIRE HOOKUP. ACC 2PPM, ADJUSTABLE. COST ONLY \$5.95 EACH OR 2 FOR \$10.00—OR ONLY \$4.50 WITH CLOCK PURCHASE.

10-MHz CRYSTALS HI-QUALITY CRYSTALS, DESIGNED FOR FREQUENCY CONTROL AND ELECTRONIC TIME PIECES; AGING FACTOR 5PPM. MEETS OR EXCEEDS MIL-C-3098 SPECS. MADE ESPECIALLY FOR HAL-TRONIX BY SENTRY. PRICE \$4.95 OR 2 FOR \$9.00

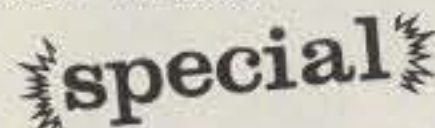

INTERSIL EVALUATION KIT

BUILD YOUR OWN D.V.M. or D.M.M. LOW COST DIGITAL PANEL METER DESIGN—KIT INCLUDES COMPLETE ASSEMBLY INSTRUCTIONS ALONG WITH A PREDRILLED P.C. BOARD, 4 LED READOUTS AND THE INTERSIL 7107 CHIP. ALONG WITH ALL REQUIRED ELECTRONIC PARTS TO COMPLETE KIT. ALL YOU NEED IS THE SUPPLY VOLTAGE. FEATURES FULL SCALE READING OF 200 MV OR 2.00V, HAS A CLOCK ON BOARD, WITH AUTO ZERO AND OVER RANGE FEATURES. \$19.95

ACCUKEYER (KIT) THIS ACCUKEYER IS A REVISED VERSION OF THE VERY POPULAR WB4VVF ACCUKEYER ORIGINALLY DESCRIBED BY JAMES GARRETT, IN QST MAGAZINE AND THE 1975 RADIO AMATEURS HANDBOOK. \$16.95

ACCUKEYER—MEMORY OPTION KIT THIS ACCUKEYER MEMORY KIT PROVIDES A SIMPLE, LOW COST METHOD OF ADDING MEMORY CAPABILITY TO THE WB4VVF ACCUKEYER. WHILE DESIGNED FOR DIRECT ATTACHMENT TO THE ABOVE ACCUKEYER, IT CAN ALSO BE ATTACHED TO ANY STANDARD ACCUKEYER BOARD WITH LITTLE DIFFICULTY. \$16.95

SHIPPING INFORMATION

ORDERS OVER \$15.00 WILL BE SHIPPED POSTPAID EXCEPT ON ITEMS WHERE ADDITIONAL CHARGES ARE REQUESTED. ON ORDERS LESS THAN \$15.00 PLEASE INCLUDE ADDITIONAL \$1.00 FOR HANDLING AND MAILING CHARGES. SEND SASE FOR FREE FLYER.

BY POPULAR DEMAND



— we are continuing to offer with any purchase of \$99 or more from ad or flyer, a Fairchild **Clock Module FCS-8100A** (suggested retail price of \$20).



look at these Summer Specials

COMPLETE KITS: CONSISTING OF EVERY ESSENTIAL PART NEEDED TO MAKE YOUR COUNTER COMPLETE. HAL-600A 7-DIGIT COUNTER WITH FREQUENCY RANGE OF ZERO TO 600 MHz. FEATURES TWO INPUTS: ONE FOR LOW FREQUENCY AND ONE FOR HIGH FREQUENCY; AUTOMATIC ZERO SUPPRESSION. TIME BASE IS 1.0 SEC OR .1 SEC GATE WITH OPTIONAL 10 SEC GATE AVAILABLE. ACCURACY ± .001%, UTILIZES 10-MHz CRYSTAL 5 PPM.

COMPLETE KIT..... ~~\$149~~..... \$129

HAL-300A 7-DIGIT COUNTER WITH FREQUENCY RANGE OF ZERO TO 300 MHz. FEATURES TWO INPUTS: ONE FOR LOW FREQUENCY AND ONE FOR HIGH FREQUENCY; AUTOMATIC ZERO SUPPRESSION. TIME BASE IS 1.0 SEC OR .1 SEC GATE WITH OPTIONAL 10 SEC GATE AVAILABLE. ACCURACY ± .001%, UTILIZES 10-MHz CRYSTAL 5 PPM.

COMPLETE KIT..... ~~\$124~~..... \$109

HAL-50A 8-DIGIT COUNTER WITH FREQUENCY RANGE OF ZERO TO 50 MHz OR BETTER. AUTOMATIC DECIMAL POINT, ZERO SUPPRESSION UPON DEMAND. FEATURES TWO INPUTS: ONE FOR LOW FREQUENCY INPUT, AND ONE ON PANEL FOR USE WITH ANY INTERNALLY MOUNTED HAL-TRONIX PRE-SCALER FOR WHICH PROVISIONS HAVE ALREADY BEEN MADE. 1.0 SEC AND .1 SEC TIME GATES. ACCURACY ± .001%. UTILIZES 10-MHz CRYSTAL 5 PPM.

COMPLETE KIT..... ~~\$124~~..... \$109

ATTENTION RADIO CLUBS For club or group projects, request FREE information about our DISCOUNTS on any of the HAL-TRONIX kits. Discounts range from 10-25%, depending upon the quantity needed.

We are experienced in supplying kits in volume quantities to schools, laboratories, clubs, and common-interest groups. Nobody beats HAL-TRONIX quality and price. Just try us and see for yourself.



FROM HAL-TRONIX

DELUXE 12-BUTTON TOUCHTONE ENCODER KIT utilizing the new ICM 7206 chip. Provides both VISUAL AND AUDIO indications! Comes with its own two-tone anodized aluminum cabinet. Measures only 2 3/4 x 3 3/4". Complete with Touch-Tone pad, board, crystal, chip and all necessary components to finish the kit.

PRICED AT..... \$29.95

For those who wish to mount the encoder in a hand-held unit, the PC board measures only 9/16" x 1 3/4". This partial kit with PC board, crystal, chip and components.

PRICED AT..... \$14.95

PRE-SCALER KITS

HAL 300 PRE..... \$19.95
(Pre-drilled G10 board and all components)

HAL 300 A/PRE..... \$24.95
(Same as above with preamp)

HAL 600 PRE..... \$34.95
(Pre-drilled G10 board and all components)

HAL 600 A/PRE..... \$39.95
(Same as above but with preamp)

SPECIAL OFFER—While they last

FND-70 Common cathode readouts direct replacement for the FND-359 same pin-out.

10 units (.40¢) — 10/ 4.00
100 units (.35¢) — 100/ 35.00
500 units (.30¢) — 500/150.00
1000 units (.25¢) — 1000/250.00



"HAL" HAROLD C. NOWLAND
W8ZXH

HAL-TRONIX H24

P. O. BOX 1101
SOUTHGATE, MICH. 48195
PHONE (313) 285-1782

mine the size of tank you want to build and buy your Plexiglas™. Most glass companies handle it, and a local firm priced it at \$2.50 per square foot. This included cutting it to size. Before assembling the tank, drill all the required holes. There is one hole for the tubing and the small holes for the divider. The holes that I put in the divider were .055 inch in diameter and about one

inch apart. Prefit all the parts together to get an idea of how they go. Start by gluing the two small sides to one of the large sides. Now glue in the divider and the other side. After this has set up, glue on the bottom and the air tube. I also glued the air tube to the side of the tank so that it would not be flexing at the joint. This finishes the construction of the tank. Fill it with water

and check for leaks. My tank had several leaks because I had used Plexiglas™ glue and it did not seal the rough edges that I had. I then went over all the joints with aquarium cement and that took care of all the leaks. Unless you can get a square edge on your Plexiglas™, I would recommend using only aquarium cement.

Operation is easy. Just remember to always have

the pump on before putting in the etching solution and to pour out the solution before turning the pump off. This will keep the etching solution out of the pump. The air flow can be adjusted for different levels of solution and agitation. I only fill my tank enough to cover my board. I have etched several small boards and, in all cases, it has taken about 15 minutes. ■

New Products

from page 239

is a compact 54" 2 meter beam with 5 optimally-spaced elements. Forward gain is greater than 10 dB, and the front-to-back ratio is greater than 22 dB over the 4 MHz bandwidth. End mounting gives the ST-5 broad frequency response and eliminates mast decoupling. Half-power beamwidth is nominally 50°.

The model ST-11 Star Tracker is a 144" center-mounted 11-element beam. Optimum element spacing provides a forward gain of greater than 13 dB. Front-to-back ratio is greater than 27 dB over the 4 MHz bandwidth. Half-power beamwidth is nominally 36°.

The lightweight, high-strength design of the new Hustler yagis makes installation easy and provides long life.

Star Tracker™
5-element yagi
Model ST-5

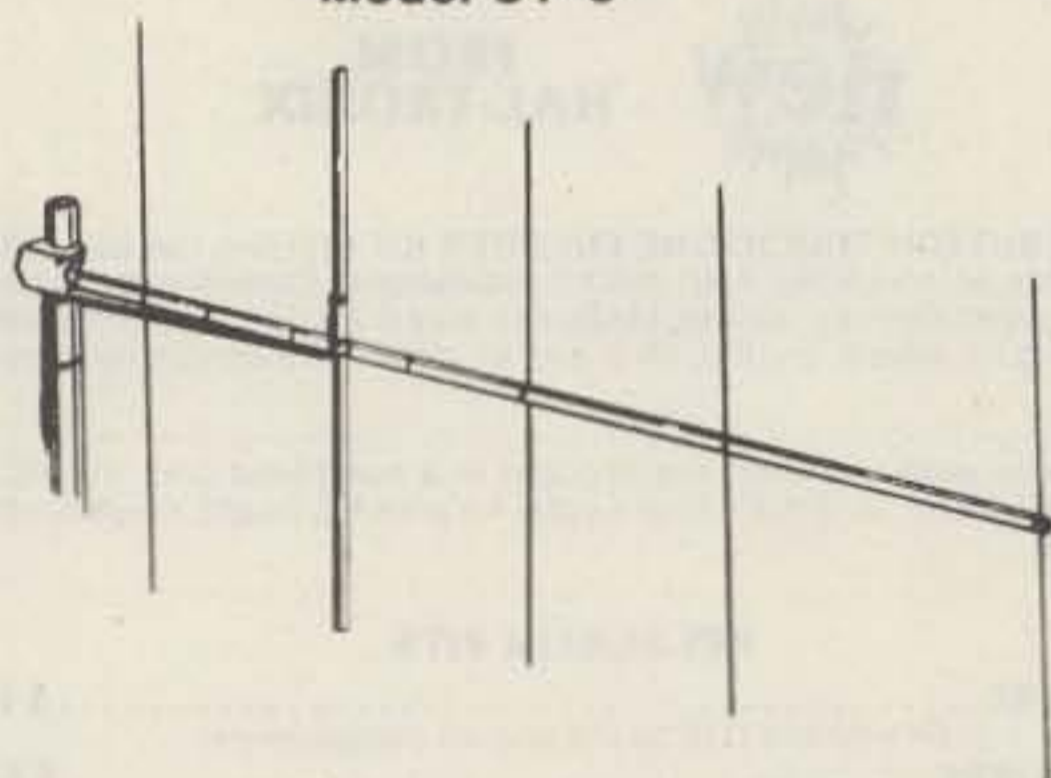

Star Tracker™
11-element yagi
Model ST-11

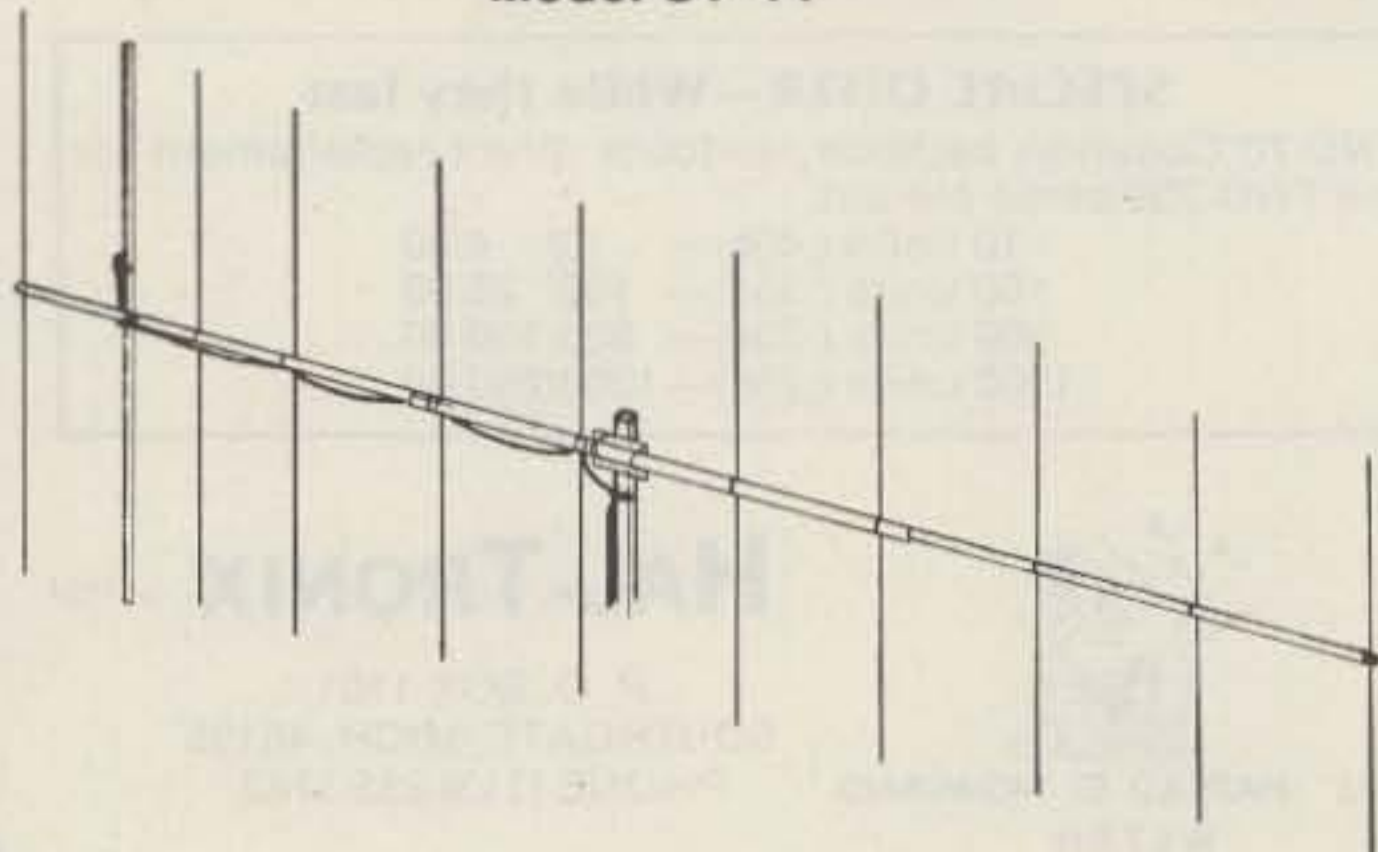

Hustler's new 2 meter yagis.

The boom and driven element of each model is 3/4" o.d., top-quality, heat-treated, seamless aluminum tubing. Reflector and director elements are 3/16" o.d., high-strength, solid aluminum rod.

Hustler furnishes all stainless steel hardware, and the corrosion-resistant steel clamps used throughout are fully adjustable, including the special boom-to-mast clamp. This unique method of clamping keeps all elements in place regardless of weather condi-

tions.

For further information on these or any Hustler products, write: Sales Department, New-Tronics Corporation, 15800 Commerce Park Drive, Brookpark OH 44142.

IC INSERTION TOOL

OK's new model MOS-40 DIP inserter handles all MOS, CMOS, and regular 36- and 40-pin ICs, as well as bent pins. A twist of the handle com-

Continued on page 275

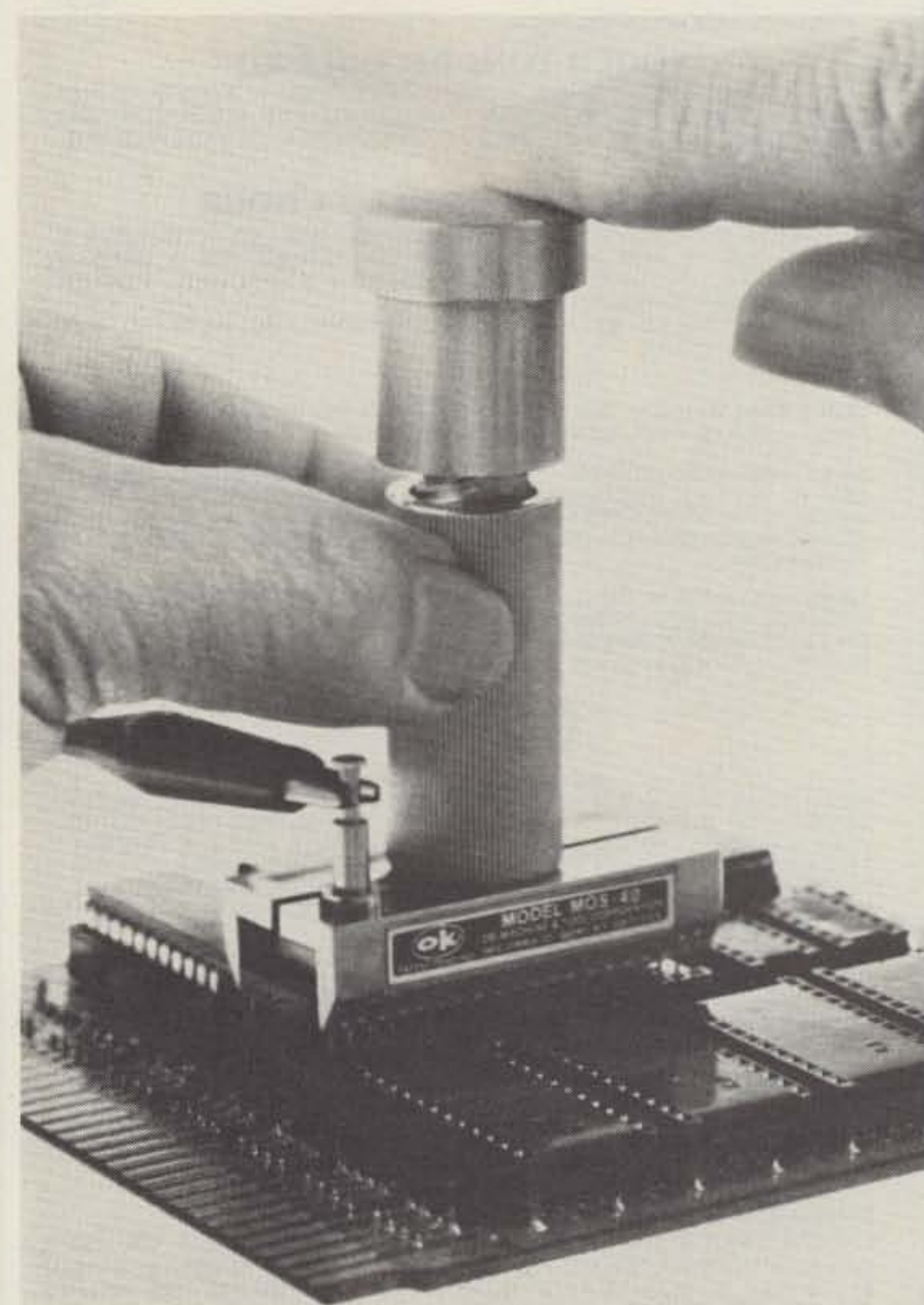

OK's MOS-40 IC insertion tool.

FIRST QUALITY CARBON RESISTOR KITS 1/4W

Each kit contains all the EIA designated 10% values from 2.2 ohms to 8.2 megohms. Your cost: Only \$.02 per resistor.



KIT A
1,000 Pcs. **19⁹⁵** ppd.
Includes FREE 9-drawer box (\$5.00 value)



KIT B
500 Pcs. **9⁹⁵** ppd.
Includes FREE compartmentalized box (\$2.00 value)



KIT C
250 Pcs. **4⁹⁵** ppd.
in Poly Bag

MANY OTHER KITS
Aluminum Electrolytic, Tantalum and Ceramic Capacitor Kits. Semiconductor Kits, too. Lamps also.

We have over 2,000 quality Receiving Tubes. Many hard-to-get types. All at 75% off list.

ORIGINAL JAPANESE SEMICONDUCTORS
Full range available to fill just about any requirement.

CALL (516) 752-0060

Send for complete catalog



TO ORDER:
Send check or Money Order—
N.Y. residents add appropriate tax.

STEVEN PRODUCTS

P.O. BOX 698, MELVILLE, N.Y. 11746

MFJ INTRODUCES NEW SUPER CW/SSB FILTERS

This new MFJ-721 Super Selector CW/SSB Filter gives you 80 Hz BW, steep SSB skirts, noise limiting, 2 watts for speaker plus more.



BRAND NEW \$59⁹⁵

This New MFJ-721 Super Selector CW/SSB Filter gives you a combination of performance and features available only from MFJ:

- Razor sharp 80 Hz non-ringing CW filter
- Steep skirt SSB filter
- Selectable peak and trough noise limiting
- Plugs in phone jack
- Two watts for speaker
- Simulated stereo reception
- Inputs for 2 rigs
- Speaker and phone jacks
- Auxiliary 2 watt amplifier, 20 dB gain.

The CW filter gives you 80 Hz bandwidth and extremely steep skirts with no ringing for razor sharp selectivity. Lets you hear just one CW signal on the crowded Novice bands.

Bandwidth is selectable: bypass, 80, 110, 150, 180 Hz. Response is 60 dB down one octave from center freq. for 80 Hz BW. Center freq. is 750 Hz. Up to 15 dB noise reduction.

8 pole active IC filter. Low Q cascaded stages eliminates ringing. Hand matched components.

The SSB filter dramatically improves readability by optimizing audio bandwidth to reduce

sideband splatter, remove low and high pitched QRM, hiss, static crashes, background noise, and hum.

Makes listening for long periods pleasurable and less fatiguing. Ideal for contest and DX.

IC active filter includes 375 Hz highpass cut-off plus selectable lowpass cutoffs at 2.5, 2.0, 1.5 KHz (36 dB per octave rolloff).

Switchable automatic noise limiter for impulse noise; trough clipper removes background noise.

For Simulated Stereo, the raw signal goes to one ear and the filtered signal to the other. The signal appears in both ears and the QRM in only one. The ears and brain reject QRM yet off-frequency calls can be heard. Requires stereo phones.

Switch selects one of two rigs. OFF position connects speaker to rig. Speaker disables when phones are used. Requires 9 to 18 VDC, 300 ma. max. 5x2x6 inches. Optional AC adapter is \$7.95. Order yours now.

This New MFJ-720 Deluxe Super CW Filter gives you 80 Hz BW, no ringing, 2 watts out.

Same 8 pole Super CW Filter as in MFJ-721. 80 Hz BW, extremely steep skirts with no ringing for razor sharp selectivity. Selectable BW: 80, 110, 180 Hz. Center freq. 750 Hz. Automatic noise limiter. Plugs in phone jack to drive speaker to 2 watts. 2x4x6 in. Requires 9-18 VDC, 300 ma. max. Optional AC adapter, \$7.95.

BRAND NEW

\$44⁹⁵



These MFJ active filters are the most copied in Industry.

CWF-2BX MFJ SUPER CW FILTER

SBF-2BX MFJ SSB FILTER



\$29⁹⁵ each



But performance is not copied. Only MFJ hand selects components so the center frequency of each CW stage is within one Hz of each other.

CWF-2BX and the SBF-2BX are the same CW and SSB filter as in the MFJ-721 but less speaker amplifier and noise

limiter. Plugs in rig to drive phones or connect between audio stage for full speaker operation. Uses 9 V battery. 2x3x4 inches.

For Orders, Call Toll Free

800-647-1800

ORDER TODAY BY MAIL OR CALL TOLL FREE 800-647-1800 AND CHARGE IT ON VISA OR MASTER CHARGE. Order any product from MFJ and try it. If not delighted, return it within 30 days for a prompt refund (less shipping). One year unconditional guarantee. Add \$2.00 shipping/handling. For order/repair status, in Mississippi and outside continental USA, call 601-323-5869.



MFJ ENTERPRISES, INC.

P. O. BOX 494 MISSISSIPPI STATE, MISSISSIPPI 39762 M52

Build A Decent Dummy

—no oil, no light bulbs, no hassle

A “dummy load” is an artificial antenna that does not radiate a signal and is used to tune up, test, or troubleshoot your station transmitter *without* going on the air and creating ill-mannered and illegal interference. Ideally, the dummy load looks to the transmitter like a perfect resonant antenna at all frequencies between dc and daylight. In a practical dummy load, this means that

it should be resistive (i.e., *no* reactance) at all frequencies that the transmitter will cover. Furthermore, it should have a resistance equal to the optimum impedance the transmitter is designed to feed, or the impedance of the antenna system normally used with the transmitter.

The dummy load should have sufficient power-handling capability to allow it to absorb the full transmitter

power for a couple of minutes at least. (Indefinitely would be nice, but it becomes very expensive at power levels over about 100 Watts.) This will allow you to become absorbed in what you are doing without having to worry about the condition of the dummy load.

Another requirement is that the load be shielded so that rf radiation is reduced. Even at milliwatt powers, unshielded rf sources can interfere with nearby receivers. If you doubt this, try tuning a grid- (or gate-) dip oscillator through the TV channel frequencies while watching the TV screen. Even at distances of several feet, “herringbone” patterns will appear. If a 50 mW source will do that, imagine what a 200-Watt transceiver will do!

Crude Dummy Loads

For low power rigs (i.e., up to about 200 Watts), many amateurs use an ordinary 50- to 250-Watt incandescent light bulb as a dummy load. A short piece of coaxial cable is fitted with an rf connector on one end and the other end is split to allow it to be fastened to a standard Edison-base lamp fixture.

When the transmitter is out of resonance, very little power is delivered to the load, so the bulb will show a dim orange light. When the plate tuning capacitor is adjusted to resonance, the light will increase and become white in color, making an impressive display of output power (even though somewhat meaningless).

The light bulb dummy load is not good practice for a couple of reasons. For one thing, the resistance of the bulb is not constant, but changes as the bulb heats up. The impedance seen by the transmitter, then, varies markedly from low to high power. It is rarely actually within the 50- to 75-Ohm range deemed optimum for most amateur transmitters, but will have some other value.

Secondly, the light bulb will radiate. I have heard a local station 7 to 8 miles away producing an S8 CW signal at my location while loading an HW-101 into a light bulb dummy load.

Attempts are sometimes made to reduce radiation from the light bulb, with varying results. A few amateurs have painted the light

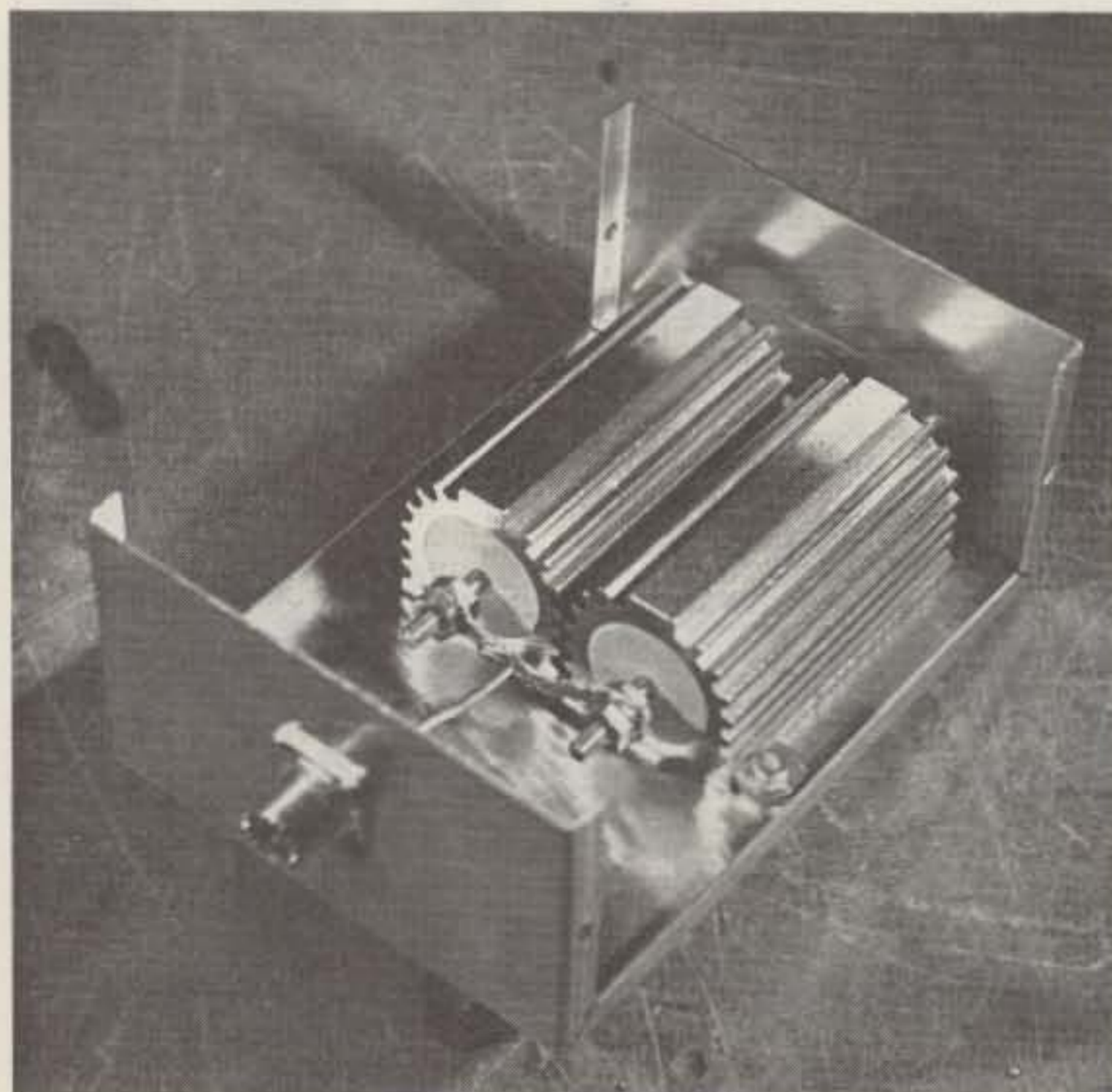

bulb's glass bulb down to the base with conductive copper paint, leaving only a small "peephole" to view lamp brilliance. This works very poorly. Other attempts, usually more successful, involve placing the lamp and socket assembly inside a metal box, but this still leaves the problem of the varying load.

Commercial Dummy Loads

Even a brief scan through the professional communications test equipment catalogues will reveal that professional dummy loads are very costly. Even military surplus loads bring a premium price from dealers and hamfest attendees alike. One friend of mine was extremely lucky to find a dc-to-VHF Bird 1000-Watt load in good condition at a hamfest. He was ecstatic to pay only \$125! To him, it was worth it because he does a lot of amateur research (some of which is very professional), but to the average amateur that one-eighth kilobuck is better spent elsewhere.

One company offers a low-cost amateur dummy load that gives very good performance up to about 30 MHz. I bought one and have found it very useful. The problem is that it is perpetually a mess. It seems that the actual 50-Ohm element is rated at only about 100 Watts. This is extended tenfold by mounting it in a paint can and filling the can with oil (user provided). Everything goes fine for about two months, after which the XYL comes in and wants to know about that ring of oil on the floor. The oil seeps up around the can lid and finds its way outside of the can. Most owners of this product, I suspect, tend to place them in a plastic container and relegate them to the garage or a little-used corner of the basement. I want a dummy load that is *dry*, so that I can mount it behind my operating desk and switch it in, using a coaxial switch, whenever

required.

A Home-Brew Alternative

Fig. 1(a) shows a 200-Watt dummy load that is suitable for most stations running an exciter or transceiver in the 200-Watt class. It will also work for those running power up to about 400-Watts input if the proper time-on (duty cycle) is observed.

The actual load is formed by paralleling two 100-Ohm, 100-Watt noninductive resistors (Dale NH-100). Other combinations will also work, as long as the power rating is sufficient and the parallel resistance of the circuit is either 50 or 75 Ohms (as desired). If you wanted to be ridiculous about it, for example, you *could* parallel 100 two-Watt resistors each of which has a value of 5k Ohms. Realistically, though, any combination of noninductive resistors with a total of 50 Ohms that requires not more than five or six actual resistors is sufficient. You will find that 50- and 75-Ohm noninductive power resistors are hard to find, so a combination is necessary.

I wanted two additional features in my dummy load: an oscilloscope output and a dc output that is proportional to the power. The resistor voltage divider shown as part of Fig. 1(a) was used to provide the dc level. Resistors R3 and R4 reduce the rf voltage across the load to a level that can be handled easily by the 1N60 rectifier. Capacitors C1 and C2 plus resistor R5 form a low-pass filter to remove any residual rf and leave just pure dc. The assembly was built into a small aluminum box outboard to the unit (Fig. 2). A second voltage divider exactly like R3/R4, but without the rectifier and filter, provided the oscilloscope output.

In a later version, the circuit of Fig. 1(b) was substituted for the voltage divider circuit used originally. This modification uses a pair of toroid current transformers such as are normally

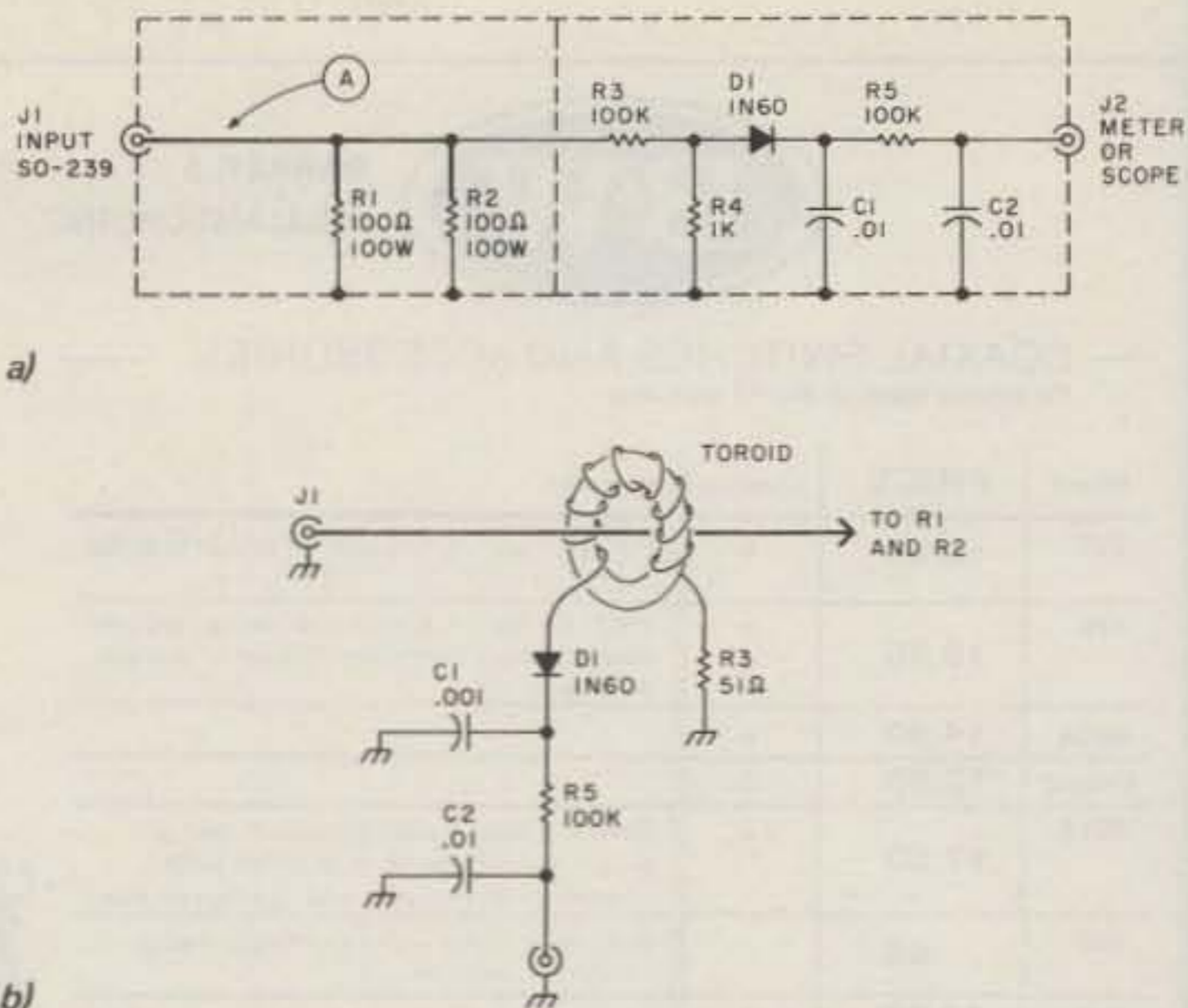

Fig. 1. (a) Circuit for dummy load. (b) Modification using a toroidal current transformer for the rf pick-off.

used in swr meter and rf power meter projects published in *73 Magazine* and the *ARRL Radio Amateur's Handbook*.

Almost any high-frequency toroid will work for this application. Wind approximately 40 turns of #28 magnet wire (enamel insulation) on the form. Terminate one end in a 50- or 75-Ohm carbon resistor, and connect the other end to the rectifier. The oscilloscope output is made in exactly the same manner, except that the rectifier-filter

network (D1, C1, C2, and R5) is deleted.

A metal snap-together box was used for the housing, and this is considered the *minimum*. Be wary of metal boxes and utility cabinets with poorly fitting edges or no overlapping edges. Some use a butt joint with little cutouts along each edge to make them fit, and those are useless (and not very strong). If a die-cast aluminum box with a tight seal is available, then use it. The tighter the seal, the lower the radiation. ■

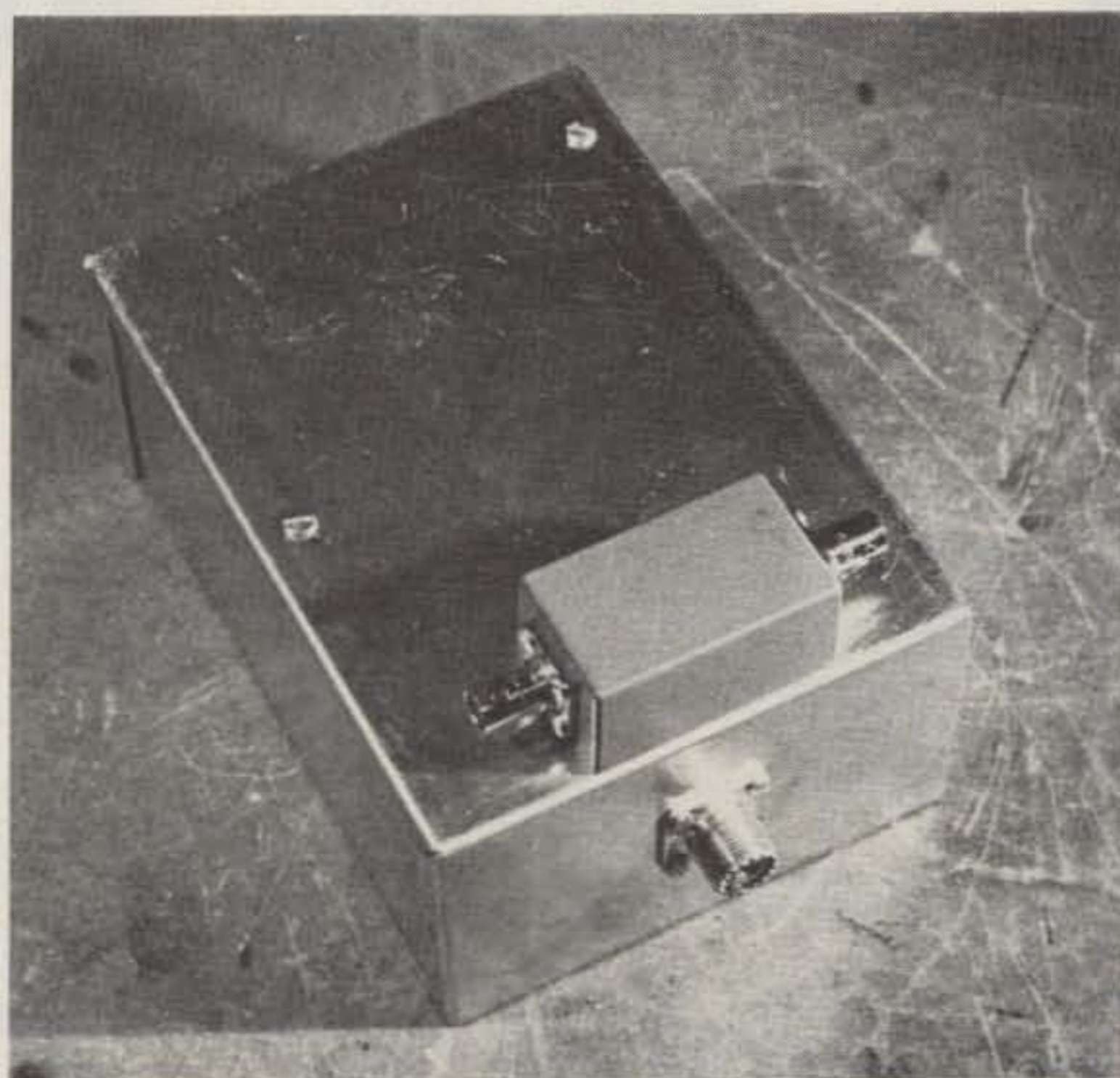

Fig. 2. External view shows the pick-off box mounted piggyback to the main assembly.



BARKER & WILLIAMSON, INC.

COAXIAL SWITCHES AND ACCESSORIES
for antenna selection and RF switching

| Model | PRICE | Outputs | Remarks |
|--------|-------|---------|---|
| 375 | 18.95 | 6 | PROTAX switch. Grounds all except selected output circuit. |
| 376 | 18.95 | 5 | PROTAX switch. Grounds all except selected output circuit. Sixth switch position grounds all outputs. |
| 550A | 14.00 | 5 | |
| 550A-2 | 12.50 | 2 | |
| 551A | 17.50 | 2 | Special 2-pole, 2-position switch used to switch any RF device in or out of series connection in a coaxial line. See figure (over). |
| 556 | .95 | - | Bracket only, for wall mounting of radial connector switches. |
| 590 | 17.95 | 5 | |
| 590G | 17.95 | 5 | Grounds all except selected output circuit. |
| 592 | 16.50 | 2 | |
| 595 | 18.50 | 6 | Grounds all except selected output circuit. |

COAXIAL SWITCHES AND ACCESSORIES for antenna selection and RF switching. These high-quality switches have set the standard for the industry for years. Ceramic switches with silver alloy contacts and silver-plated conductors give unmatched performance and reliability from audio frequencies to 150 MHz. B&W coaxial switches are de-

signed for use with 52- to 75-ohm non-reactive loads, and are power rated at 1000 watts AM, 2000 watts SSB. Connectors are UHF type. Insertion loss is negligible, and VSWR is less than 1.2:1 up to 150 MHz. Crosstalk (measured at 30 MHz) is 45 dB between adjacent outlets and -60 dB between alternate outlets.



| | | |
|--------------|--|--------|
| PA2501H Kit | 2 mtr power amp—kit 1w in—25w out with solid state switching, case, connectors | 64.95 |
| PA4010H Kit | 2 mtr power amp—10w in—40w out—relay switching | 64.95 |
| PA50/25 Kit | 6 mtr power amp, 1w in, 25w out, less case, connectors & switching | 54.95 |
| PA144/15 Kit | 2 mtr power amp—1w in—15w out—less case, connectors and switching | 44.95 |
| PA144/25 Kit | same as PA144/15 kit but 25w | 54.95 |
| PA220/15 Kit | similar to PA144/15 for 220 MHz | 44.95 |
| PA432/10 Kit | power amp—similar to PA144/15 except 10w and 432 MHz | 54.95 |
| PA140/10 W/T | 10w in—140w out—2 mtr amp | 219.95 |
| PA140/30 W/T | 30w in—140w out—2 mtr amp | 189.95 |

POWER AMPLIFIERS



Blue Line . . . RF power amp, wired & tested, emission—CW-FM-SSB/AM

| Model | BAND | Power Input | Power Output | |
|------------|---------|-------------|--------------|--------|
| BLC 10/70 | 144 MHz | 10W | 70W | 149.95 |
| BLC 2/70 | 144 MHz | 2W | 70W | 169.95 |
| BLC 10/150 | 144 MHz | 10W | 150W | 259.95 |
| BLC 30/150 | 144 MHz | 30W | 150W | 239.95 |
| BLD 2/60 | 220 MHz | 2W | 60W | 164.95 |
| BLD 10/60 | 220 MHz | 10W | 60W | 159.95 |
| BLD 10/120 | 220 MHz | 10W | 120W | 259.95 |
| BLE 10/40 | 420 MHz | 10W | 40W | 179.95 |
| BLE 2/40 | 420 MHz | 2W | 40W | 179.95 |
| BLE 30/80 | 420 MHz | 30W | 80W | 259.95 |
| BLE 10/80 | 420 MHz | 10W | 80W | 289.95 |

POWER SUPPLIES



| | | |
|------------|---|--------|
| PS15C Kit | 15 amp—12 volt regulated power supply w/case, w/fold-back current limiting and overvoltage protection | 94.95 |
| PS15C W/T | same as above—wired & tested | 124.95 |
| PS25M Kit | 25 amp—12 volt regulated power supply w/case, w/fold-back current limiting and ovp, with meter | 154.95 |
| PS 25M W/T | same as above—wired & tested | 179.95 |
| O.V.P. | adds over voltage protection to your power supplies, 15 VDC max. | 12.95 |
| PS3A Kit | 12 volt—power supply regulator card with fold-back current limiting | 10.95 |

PS3012 W/T new commercial duty 30 amp 12 VDC regulated power supply w/case, w/fold-back current limiting and overvoltage protection 249.95



The most convenient way to order! Just call our **Credit Card Order Department** 9AM-9PM at (617) 395-8280. Your order will be processed immediately—you'll be receiving it even more quickly than if you'd sent it by mail. Any way you look at it, our same-day service plus our special telephone credit card service equal the fastest way to shop by mail! **(Sorry—we can't accept collect calls.)** Helpful hint: To make your order as clear as possible, fill in all information on this order form, then read it when you call.



Name _____ Call _____
 Address _____
 City _____ State _____ Zip _____
 Order: _____

 Check enclosed Visa Master Charge American Express
 Credit card # _____
 Signature _____ Card expiration date _____



Radio Electronics ✓T3
 209 Mystic Avenue
 Medford MA 02155
 (617) 395-8280

**OPEN DAILY 9-9
 SATURDAY 9-6**

Prices FOB Medford MA. MA residents add 5% sales tax.
Minimum \$3.00 for shipping & handling on ALL ORDERS.

PRICES SUBJECT TO CHANGE WITHOUT NOTICE

PLEASE — No Cash Or C.O.D.s!



| MODEL | NET PRICE | | |
|-------|-----------|-------|----------|
| 12V4 | \$19.95 | 104R | \$49.95 |
| 102 | \$24.95 | 108RA | \$79.95 |
| 107 | \$28.95 | 108RM | \$99.95 |
| 103R | \$39.95 | 109R | \$149.95 |

MODEL 109R

NPC 25 Amp Regulated Power Supply, 4-Way Protected, Output Voltage and Current Meters.
Extra heavy-duty unit quietly converts 115 volts AC to 13.6 volts DC ± 200 millivolts, 10 amps continuous, 25 amps max. All solid state. Features dual current overload, overvoltage and thermal protection. Ideally suited for operating mobile Ham radio and linear amplifier in your home or office. Excellent bench power supply for testing and servicing of mobile communications equipment.

| | TYPICAL | MAXIMUM |
|------------------------|-------------|-------------|
| Output Voltage | 13.6 ± 2VDC | 13.6 ± 3VDC |
| Line/Load Regulation | 50 mV | 100 mV |
| Ripple/Noise | 5 mV RMS | 10 mV RMS |
| Transient Response | 30 µSec | |
| Current Continuous | 10 Amp | |
| Current Limit | 26 Amp | |
| Overvoltage Protection | 14.5 V | 15 V |
| Thermal Overload | 180°F | |

Case: 4" (H) x 9" (W) x 8" (D) Shipping Weight: 15 lbs.

MODEL 104R

NPC 6 Amp Power Supply Regulated, Solid State, Dual Overload Protection.

Converts 115 volts AC to 13.6 volts DC ± 200 millivolts. Handles 4 amps continuous and 6 amps max. Ideally suited for applications where

EXCELLENT DC SUPPLY IS IMPORTANT, SUCH AS CB TRANSMISSION, SMALL HAM RADIO TRANSMITTER, AND HIGH QUALITY EIGHT-TRACK CAR STEREO. CAN BE USED TO TRICKLE-CHARGE 12 VOLT CAR BATTERIES.

| | MAXIMUM | TYPICAL |
|----------------------|--------------|--------------|
| Output Voltage | 13.6 ± 2 VDC | 13.6 ± 3 VDC |
| Line/Load Regulation | 20 mV | 50 mV |
| Ripple/Noise | 2 mV RMS | 5 mV RMS |
| Transient Response | 30 µSec | |
| Current Continuous | 4 Amp | |
| Current Limit | 6 Amp | |
| Current Foldback | 2 Amp | |

Case: 3" (H) x 5" (W) x 8" (D) Shipping Weight: 6 lbs.

MODEL 108RM

NPC 12 Amp Regulated Power Supply, Solid State, 3 Way Protected, Current Meter.

This heavy duty unit quietly converts 115 volts AC to 13.6 volts DC ± 200 millivolts, 8 amps continuous, 12 amps max. All solid state. Features dual current overload and overvoltage protection. Ideally suited for operating mobile Ham radio 2 meter AM-FM-SSB transceivers in your home or office. Can also be used to trickle-charge 12 volt car batteries.

| | TYPICAL | MAXIMUM |
|------------------------|-------------|-------------|
| Output Voltage | 13.6 ± 2VDC | 13.6 ± 3VDC |
| Line/Load Regulation | 20 mV | 50 mV |
| Ripple/Noise | 2 mV RMS | 5 mV RMS |
| Transient Response | 20 µSec | |
| Current Continuous | 8 Amp | |
| Current Limit | 12 Amp | |
| Current Foldback | 2.5 Amp | |
| Overvoltage Protection | 14.5 V | 15 V |

Case: 4 1/4" (H) x 7 1/2" (W) x 5 1/2" (D) Shipping Weight: 9.5 lbs.

ALSO AVAILABLE AS MODEL 108RA WITHOUT METER AND OVERVOLTAGE PROTECTION.

MODEL 107

NPC 4 Amp Power Supply, 6 Amp Max. Solid State, Overload Protected

Functions silently in converting 115 volts AC to 12 volts DC, 4 amps continuous, 6 amps max. Enables anyone to enjoy CB radio, car 8-track cartridge, cassette player or car radio in a home or office.

| | |
|--------------------------------|-----------------|
| Continuous Current (Full Load) | 4 Amp |
| Output Voltage (No Load) | 16 V max |
| Output Voltage (Full Load) | 12 V min |
| Filtering Capacitor | 10,000 µF |
| Ripple (Full Load) | 5 V RMS |
| Short Circuit Protection | Thermal Breaker |

Case: 3" (H) x 4" (W) x 5" (D) Shipping Weight: 5 lbs.

MODEL 12V4

NPC 1.75 Amp Power Supply, 3 Amp Max.

Functions silently in converting 115 volts AC to 12 volts DC. Ideally suited for most applications including 8-track stereo, burglar alarm, car radio and cassette tape player within power rating.

| | |
|--------------------------------|-----------------|
| Continuous Current (Full Load) | 1.75 Amp |
| Output Voltage (No Load) | 16 V max |
| Output Voltage (Full Load) | 12 V min |
| Filtering Capacitor | 5,000 µF |
| Ripple (Full Load) | 4 V RMS |
| Short Circuit Protection | Thermal Breaker |

Case: 3" (H) x 4" (W) x 5" (D) Shipping Weight: 3 lbs.

MODEL 103R

NPC 4 Amp Regulated Power Supply, Solid State, Dual Overload Protection.

Converts 115 volts AC to 13.6 volts DC ± 200 millivolts. Handles 2.5 amps continuous and 4 amps max. Ideally suited for applications where no hum and DC stability are important such as CB transmission, small Ham radio transmitter, and high quality eight-track car stereos. Can also be used to trickle-charge 12 volt car batteries.

| | TYPICAL | MAXIMUM |
|----------------------|--------------|--------------|
| Output Voltage | 13.6 ± 2 VDC | 13.6 ± 3 VDC |
| Line/Load Regulation | 20 mV | 50 mV |
| Ripple/Noise | 2 mV RMS | 5 mV RMS |
| Transient Response | 20 µSec | |
| Current Continuous | 2.5 Amp | |
| Current Limit | 4 Amp | |
| Current Foldback | 1 Amp | |

Case: 3" (H) x 4" (W) x 5" (D) Shipping Weight: 4 lbs.

MODEL 102

NPC 2.5 Amp Power Supply, 4 Amp Max. Solid State, Overload Protected.

Functions silently in converting 115 volts AC to 12 volts DC. 2.5 amps continuous, 4 amps max. Enables anyone to enjoy CB radio, car 8-track cartridge, cassette tape player or car radio in a home or office.

| | |
|--------------------------------|-----------------|
| Continuous Current (Full Load) | 2.5 Amp |
| Output Voltage (No Load) | 16 V max |
| Output Voltage (Full Load) | 12 V min |
| Filtering Capacitor | 5,000 µF |
| Ripple (Full Load) | 6 V RMS |
| Short Circuit Protection | Thermal Breaker |

Case: 3" (H) x 4" (W) x 5" (D) Shipping Weight: 4 lbs.

AUTOPATCH — Ready to go!

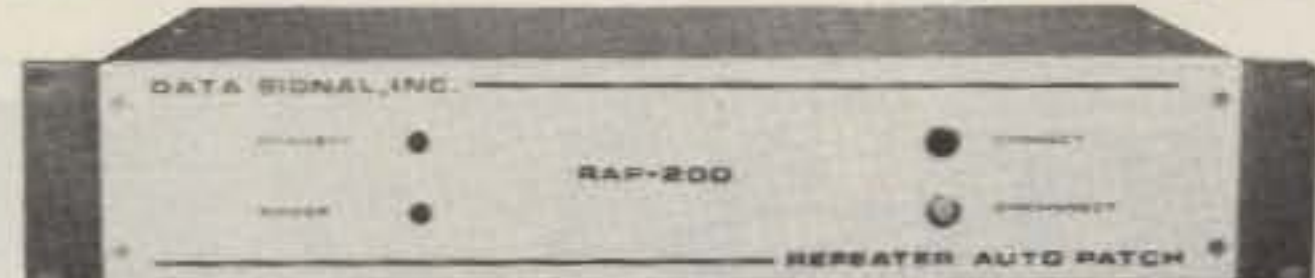

A Complete Autopatch facility that requires only a repeater and a telephone line. Features include single-digit access/disconnect, direct dialing from mobile or hand-held radios, adjustable amplifiers for transmitter and telephone audio, and tone-burst transponder for acknowledgement of patch disconnect.

**RAP-200 P. C. Card \$199.50
RAP-200R Rack Mount \$249.50**



Highest quality, American-made "brand" transistors are fully protected for VSWR, short and overload, reverse polarity. Highly effective heat sinking assures long life, reliable performance. Black anodized containers... exclusive KLM extrusions, have seven, full length fins on both sides!

KLM RF Power Amplifiers

- A simple, add-on-immediately RF amplifier.
- Merely coax-connect amplifier between antenna and transceiver.
- No tuning! Efficient strip-line broad band design.
- Automatic! Internal RF-sensor-controlled relay connects amplifier whenever transmitter is switched on.
- Manual, remote-position switching is optional.
- Models for 6, 2.1 1/4 meters, 70CM amateur bands plus MARS coverage
- Two types: **Class C** for FM/CW. **Linear** for SSB/AM/FM/CW.
- Negligible insertion loss on receive.
- American made by KLM.

New Model List Price

| | | | |
|-------------|----------|-------------|--------|
| PA 2-25B | \$ 69.95 | PA 4-70BC | 189.95 |
| PA 4-70BL | 189.95 | PA 15-60BC | 164.95 |
| PA 15-40BL | 109.95 | PA 45-120BC | 209.95 |
| PA 15-80BL | 179.95 | PA 4-40C | 169.95 |
| PA 15-160BL | 259.95 | PA 15-35CL | 154.95 |
| PA 45-140BL | 219.95 | PA 15-110CL | 279.95 |

slinky

SLINKY! \$43.95 Kit A LOT of antenna in a LITTLE space New Slinky® dipole* with helical loading radiates a good signal at 1/10 wavelength long!

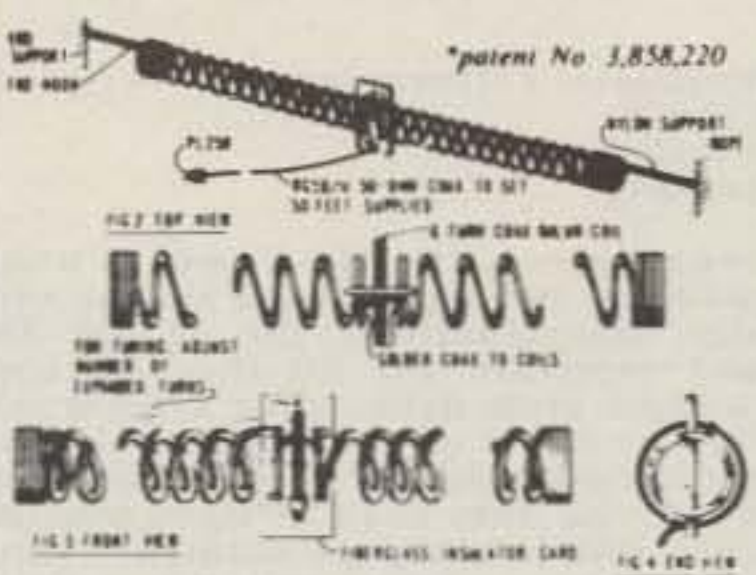

This electrically small 80/75, 40 & 20 meter antenna operates at any length from 24 to 70 ft. • no extra balun or transmatch needed • portable — erects & stores in minutes • small enough to fit in attic or apt. • full legal power • low SWR over complete 80/75, 40 & 20 meter bands • much lower atmospheric noise pick-up than a vertical & needs no radials • kit incl. a pr. of specially-made 4" dia. by 4" long coils, containing 335 ft. of radiating conductor, balun, 50 ft. RG58/U coax, PL259 connector, nylon rope & manual.

**SOLAREX
SOLAR CELLS &
SOLAR PANELS
in stock**



Send for Catalog!



NEW Jr. Monitor Antenna Tuner

- Continuous tuning 1.8–30 MHz
- Forward reading relative output power meter
- 300 watt power capability
- Built-in encapsulated balun
- Mobile mounting bracket

- Ceramic Rotary Switch 12-position
- Capacitor spacing 1000 volts
- Tapped toroid inductor
- Antenna inputs:
 - Coax unbalanced SO239
 - Random wire
 - Balanced feedline 75–660 Ohm
- 5 1/4" w. x 2 1/4" h. x 6" d.
- All metal black wrinkle finish cabinet
- Weight: 2 1/2 pounds
- Price: \$79.95

Dentron

REPEATERS

| | | |
|----------------------|--|--------|
| RPT50 Kit | repeater—6 meter | 499.95 |
| RPT50 | repeater—6 meter, wired & tested | 799.95 |
| RPT144 Kit | repeater—2 mtr—15w—complete (less crystals) | 499.95 |
| RPT220 Kit | repeater—220 MHz—15w—complete (less crystals) | 499.95 |
| RPT432 Kit | repeater—10 watt—432 MHz (less crystals) | 579.95 |
| RPT144 W/T | repeater—15 watt—2 mtr. | 799.95 |
| RPT220 W/T | repeater—15 watt—220 MHz. | 799.95 |
| RPT432 W/T | repeater—10 watt—432 MHz. | 849.95 |
| DPLA50 | 6 mtr close spaced duplexer | 575.95 |
| DPLA144 | 2 mtr, 600 KHz spaced duplexer, wired and tuned to frequency | 379.95 |



| | | |
|-------------------|---|--------|
| DPLA220 | 220 MHz duplexer, wired and tuned to frequency | 379.95 |
| DPLA432 | rack mount duplexer | 319.95 |
| DSC-U | double shielded duplexer cables with PL259 connectors (pr.) | 25.00 |
| DSC-N | same as above with type N connectors (pr.) | 25.00 |

Vhf engineering



ATB-34



4 ELEMENT BEAM 10-15-20 METERS

Cushcraft engineers have incorporated more than 30 years of design experience into the best 3 band HF beam available today. **ATB-34** has superb performance with three active elements on each band, the convenience of easy assembly and modest dimensions. Value through heavy duty all aluminum construction and a price complete with 1-1 balun.

| SPECIFICATIONS | |
|-------------------|----------------|
| FORWARD GAIN - | EXCELLENT |
| F/B RATIO - | 30 dB |
| VSWR - | 1.5:1 |
| POWER HANDLING - | 2000 WATTS PEP |
| BOOM LENGTH/DIA - | 18' x 2 1/8" |
| LONGEST ELEMENT - | 32.8' |
| TURNING RADIUS - | 18.9' |
| WIND SFC - | 5.4 Sq.Ft. |
| WEIGHT - | 42 Lbs. |
| WIND SURVIVAL - | 90 MPH |

\$259.59

UPS SHIPPABLE complete

ENJOY A NEW WORLD OF DX COMMUNICATIONS WITH ATB-34



ALL NEW 3-BAND, 2 ELEMENT HY-QUAD

■ Makes all other quads obsolete!
 ■ Complete - nothing else to buy
 ■ High strength, low wind load

The Hy-Quad from Hy-Gain makes all other quads obsolete! Here's why: First, it's the only quad that is complete. There is nothing more to shop for or buy. Secondly, it is uniquely designed so that it overcomes all of the previously undesirable features inherent in quads. The all aluminum structure stays up! The single feed line and diamond shape simplifies feed line routing. Hy-Gain's all new Hy-Quad will outdo all other quads because it's engineered to do just that. The Hy-Quad is new, it's superior, it's complete. It's the first quad to have everything: spreaders are broken up at strategic electrical points with Cycloc insulators / tri-band 2 element construction with individually resonated elements with no interaction / Hy-Quad requires only one feed line for all three bands / individually tuned gamma matches on each band with Hy-Gain exclusive vertex feed / full wave element loops require no tuning stubs, traps, loading coils or baluns / heavy duty mechanical construction of strong swaged aluminum tubing and die formed spreader-to-boom clamps / extra heavy duty universal boom-to-mast clamp that fits and mounts on any mast 1 1/4" to 2 1/2" in diameter / aluminum stranded wire. You can open and close the bands with this antenna. You'll experience the thrill of real DX.

Order No. 244 Price: \$219.95

SPECIFICATIONS

| | | | |
|-----------------------------|------------------|---------------------|---|
| Overall length of spreaders | 25.5" | Forward gain | 8.5 db |
| Turning radius | 13.6" | Input impedance | 52 ohms |
| Weight | 42 lbs. | VSWR | 1.2:1 or better at resonance on all bands |
| Boom diameter | 2" | Power | Maximum legal |
| Boom length | 8' | Front-to-back ratio | 25-35 db depending upon electrical height |
| Mast diameter | 1 1/4" to 2 1/2" | Polarization | Horizontal |
| Wind survival | 100 mph | | |
| Surface area | 6.4 sq. ft. | | |
| Wind load at 100 mph | 256.0 lbs. | | |

Hy-Gain REEL TAPE PORTABLE DIPOLE for 10 thru 80 Meters Model 18TD

The most portable high performance dipole ever...

The Model 18TD is unquestionably the most foolproof high performance portable doublet antenna system ever developed. It has proven invaluable in providing reliable communications in vital military and commercial-applications throughout the world. Two stainless steel tapes, calibrated in meters, extend from either side of the main housing up to a total distance of 132 feet for 3.5 mc operation. 25 ft. lengths of polypropylene rope attached to each tape permits installation to poles, trees, buildings... whatever is available for forming a doublet antenna system. Integrated in the high impact housing is a frequency to length conversion chart calibrated to meter measurements on the tapes... makes installation foolproof. Feeds with 52 ohm coax. Delivers outstanding performance as a portable or permanent installation. Measures 10x5 1/2x2 inches retracted. Wt., 4.1 lbs. Order No. 228 Price: \$94.95



HY-GAIN'S INCOMPARABLE HY-TOWER FOR 80 THRU 10 METERS



- Model 18HT**
- Outstanding Omni-Directional Performance
 - Automatic Band Switching
 - Installs on 4 sq. ft. of real estate
 - Completely Self-Supporting

By any standard of measurement, the Hy-Tower is unquestionably the finest multi-band vertical antenna system on the market today. Virtually indestructible, the Model 18HT features automatic band selection on 80 thru 10 meters through the use of a unique stub decoupling system which effectively isolates various sections of the antenna so that an electrical 1/4 wavelength (or odd multiple of a 1/4 wavelength) exists on all bands. Fed with 52 ohm coax, it takes maximum legal power... delivers outstanding performance on all bands. With the addition of a base loading coil, it also delivers outstanding performance on 160 meters. Structurally, the Model 18HT is built to last a lifetime. Rugged hot-dipped galvanized 24 ft. tower requires no guyed supports. Top mast, which extends to a height of 50 Ft., is 6061ST6 tapered aluminum. All hardware is iridite treated to MIL specs. If you're looking for the epitome in vertical antenna systems, you'll want Hy-Tower, Shpg. Wt., 96.7 lbs. Order No. 182, Price: \$279.95

NEW Special hinged base assembly on Model 18HT allows complete assembly of antenna at ground level... permits easy raising and lowering of the antenna.

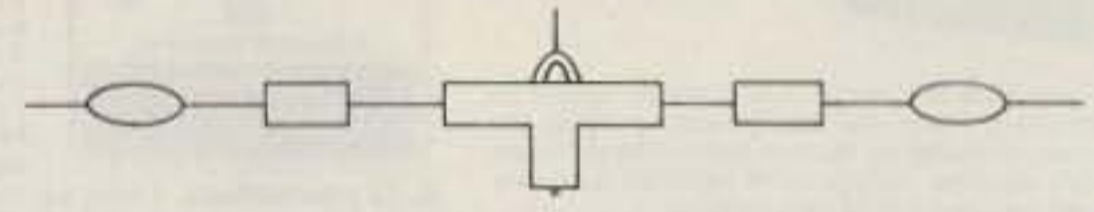
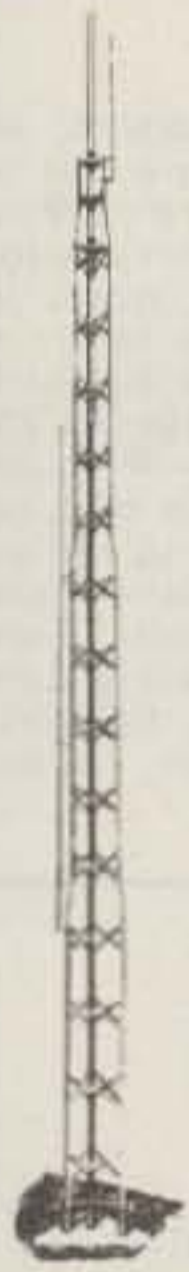

MULTI-BAND HY-Q TRAP DOUBLET'S Hy-Q Traps

- Install Horizontally or as Inverted V
- Super-Strength Aluminum Clad Wire
- Weatherproof Center and End Insulators

Installed horizontally or as an inverted V, Hy-Gain doublets with Hy-Q traps deliver true half wavelength performance on every design frequency. Matched traps, individually pretuned for each band feature large diameter coils that develop an exceptionally favorable L/C ratio and very high Q performance. Mechanically superior solid aluminum trap housings provide maximum protection and support to the loading coil. Fed with 52 ohm coax, Hy-Gain doublets employ super-strength aluminum clad single strand steel wire elements that defy deterioration from salt water and smoke... will not stretch... withstand hurricane-like winds. SWR less than 1.5:1 on all bands. Strong, lightweight, weatherproof center insulators are molded from high impact cycloc. Hardware is iridite treated to MIL specs. Heavily serrated 7-inch end insulators molded from high impact cycloc increase leakage path to approximately 12 inches.

MODEL 2BDQ for 40 and 80 meters. 100' 10 1/2" overall. Takes maximum legal power. Shpg. Wt., 7.5 lbs \$49.95 Order No. 380

MODEL 5BDQ for 10, 15, 20, 40 and 80 meters. 94' overall. Takes maximum power. Shpg. Wt., 12.2 lbs. \$79.95 Order No. 383



Meet the SuperTuner

1KW Model \$129.50

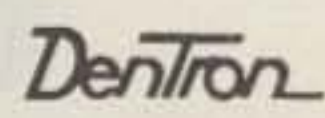

The DenTron Super Tuner tunes everything from 160-10 meters. Whether you have balanced line, coax cable, random or long wire, the Super Tuner will match the antenna impedance to your transmitter. All DenTron tuners give you maximum power transfer from your transmitter to your antenna, and isn't that where it really counts?

Mosley

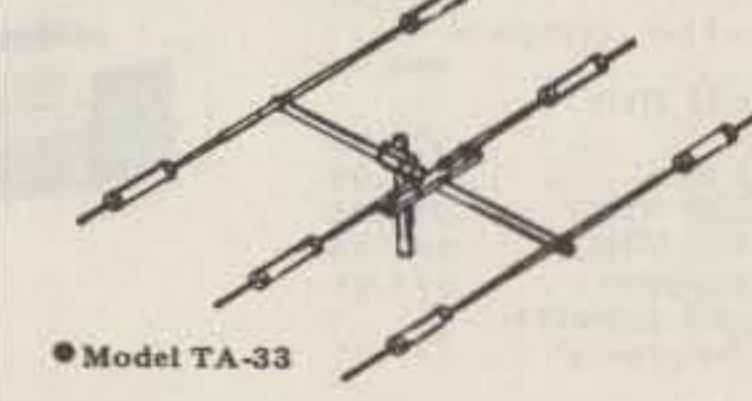

● Model TA-33

● Model TA-33, 3 elements, 10.1 dB forward gain (over isotropic source) - \$264.00

- Model TA-33 Jr., 3 elements, 10.1 dB forward gain (over isotropic source) - \$197.00
- Model MPK-3, 7500 Watts AM/CW and 2000 Watts P.E.P. SSB - \$52.25
- Model TA-36, 6 elements - \$392.75
- AK-60 mast plate adapter - \$14.50
- Model CL-33, 3 elements - \$304.75
- Model CL-36, 6 elements - \$392.75
- Model CL-203, 3 elements - \$290.00
- Model TA-40 KR - 40 meter conversion kit - \$119.50

TELEX

PROFESSIONAL HEADPHONES & HEADSETS

BOOM MIC HEADSETS

For the ultimate in communications convenience and efficiency select a boom mic headset. Longtime favorite of professional communicators, boom mic headsets allow more personal mobility while always keeping the mic properly positioned for fast, precise voice transmission. Boom microphones are completely adjustable to allow perfect positioning. And, boom mic headsets leave both hands free to perform other tasks. All models are supplied with "close talking" microphones to limit ambient noise pick up and provide superior intelligibility. Each model has a convenient, inline push-to-talk switch, which can be wired for either push-to-talk relay control or mic circuit interrupt for voice operated transmitters. The switch may be used as a momentary push-button or it can be locked in the down position. All models have tough, flexible, 8 foot cords which are stripped and tinned, uninterminated. Communication gray with black trim.

| MODEL | C 610 | SWL 610 | C 1210 | C 1320 | CM 610 | CM 1210 | CM 1320 | CM 1320S |
|---|-------------------|-------------------|-------------------|-------------------|-------------------|-------------------|-------------------|-------------------|
| Headphone Sensitivity Ref. 0002 Dynes/cm ² @ 1mW input, 1kHz | 103dB SPL ±5dB | 103dB SPL ±5dB | 103dB SPL ±3dB | 105dB SPL ±5dB | 103dB SPL ±5dB | 103dB SPL ±3dB | 105dB SPL ±5dB | 105dB SPL ±5dB |
| Headphone Impedance | 32 20 ohms | 2000 ohms | 32 20 ohms | 32 20 ohms | 32 20 ohms | 32 20 ohms | 32 20 ohms | 32 20 ohms |
| Microphone Frequency Response | | | | | 50 8000 Hz | 50 8000 Hz | 50 8000 Hz | 50 8000 Hz |
| Microphone Impedance | | | | | High | High | High | High |
| Microphone Sensitivity Below 1 volt/microbar at 1kHz | | | | | -51dB ±5dB | -51dB ±5dB | -51dB ±5dB | -51dB ±5dB |
| Price: | \$10.45 | \$12.25 | \$29.70 | \$41.80 | \$47.20 | \$62.75 | \$75.25 | \$59.95 |



Model C610
(SWL 610)



Model C 1320



Model CM 610



Model C 1210



Model CM 1210



Model CM 1320



Model CM 1320S

the indispensable BIRD 43

THRU LINE WATTMETER



| Power Range | Frequency Bands (MHz) | | | | |
|-------------|-----------------------|-------|---------|---------|----------|
| | 2-30 | 25-60 | 100-250 | 200-500 | 400-1000 |
| 5 watts | — | 5A | 5C | 5D | 5E |
| 10 watts | — | 10A | 10C | 10D | 10E |
| 25 watts | — | 25A | 25C | 25D | 25E |
| 50 watts | — | 50A | 50C | 50D | 50E |
| 100 watts | — | 100A | 100C | 100D | 100E |
| 250 watts | — | 250A | 250C | 250D | 250E |
| 500 watts | — | 500A | 500C | 500D | 500E |
| 1000 watts | — | 1000A | 1000C | 1000D | 1000E |
| 2500 watts | — | 2500H | — | — | — |
| 5000 watts | — | 5000H | — | — | — |

MODEL 43

| | |
|---|----------|
| Elements (Table 1) 2-30 MHz | \$125.00 |
| Elements (Table 1) 25-1000 MHz | 45.00 |
| Carrying case for Model 43 & 6 elements | 38.00 |
| Carrying case for 12 elements | 27.50 |
| | 17.00 |

READ RF WATTS DIRECTLY! (Specify Type N or SO239 connectors) 0.45 - 2300 MHz, 1-10,000 Watts ±5%, low insertion VSWR - 1.05. Unequaled economy and flexibility. Buy only the element(s) covering your present frequency and power needs, add extra ranges later if your requirements expand.



Model MB II \$285
(with Balun) \$315

MB II provides:

- * Constant SWR monitoring.
- * Precision tuning of final amp.
- * Harmonic suppression.
- * Receiver input impedance-matching.
- * Maximum power transfer to antenna.
- * Continuous frequency coverage 1.6 to 30 MHz.
- * Precision tuning of any wire 1/4 wavelength or longer, with SWR of 1:1.

MB II features:

- * Finest quality, made-in-USA components.
- * Large, precision, easy-to-read dials with 360 readout.
- * Optional 3000 watt Balun for twin lead antennas.



BOMAR

TWO METER CRYSTALS

Standard / Icom / Heathkit / Ken / Clegg / Regency / Wilson / VHF Eng. / Drake / Motorola HT 220 - and others! \$4.50.

LIFETIME GUARANTEE!
NOW ONLY \$8.00 A PAIR!



Why Waste Watts?
SWR - 1A \$29.95



SWR-1 guards against power loss! If you're not pumping out all the power you're paying for, our little SWR-1 combination power meter and SWR bridge will tell you so. You read forward and reflected power simultaneously, up to 1000 watts RF and 1:1 to infinity VSWR at 3.5 to 150 MHz.

Got it all tuned up? Keep it that way with SWR-1. You can leave it right in your antenna circuit.

HF VERTICALS 10 through 80 METERS

- EFFICIENT TOP RING
- FIBERGLASS TRAP FORMS
- ENAMELED WIRE COILS
- SOLID ALUMINUM CAPACITORS
- NO TUNING REQUIRED
- FULL COMPRESSION CLAMPS
- OMNIDIRECTIONAL COVERAGE
- REINFORCED BASE
- MAST OR GROUND MOUNTING
- PRE-MARKED SECTIONS
- EASY ASSEMBLY
- SUPERIOR QUALITY

- 3 BAND 20-15-10 METERS MODEL ATV-3 \$49.95
- 4 BAND 40-20-15-10 METERS MODEL ATV-4 \$89.95
- 5 BAND 80-40-20-15-10 METERS MODEL ATV-5 \$109.95



DELUXE RECEIVER PREAMPLIFIERS

Ideal for Receivers - Converters
High Gain - Low Noise

FEATURES:

- Small size
- Increases sensitivity of most receivers
- Gold-plated copper shielding
- Single or double stage models
- Diode protected, dual-gated FETs

SPECIFICATIONS:

Power: 6 VDC to 18 VDC (12 VDC recommended)

Size: a. Single stage: 1" x 1 1/4" x 1/2"

b. Double stage: 2" x 1 1/4" x 1/2"

MOSFET: FT 0601, 500 MHz, dual-gate diode protected MOSFET



When ordering be sure to specify:
1. frequency of operation
2. single or double band stage
3. kit or assembled version

| FREQ. (MHz) | USE | STAGES | DELUXE PREAMPLIFIER | | |
|-------------|--------------|--------|---------------------|-------|---------|
| | | | GAIN dB | NF dB | WIRED |
| 50 to 54 | 6 METER | SINGLE | 25 | 2 | \$15.50 |
| | | DOUBLE | 48 | 2 | \$28.50 |
| 108 to 144 | VHF AIRCRAFT | SINGLE | 20 | 2.5 | \$14.50 |
| | | DOUBLE | 40 | 2.5 | \$26.50 |
| 135 to 139 | SATELLITE | SINGLE | 20 | 2.5 | \$14.50 |
| | | DOUBLE | 40 | 2.5 | \$26.50 |
| 144 to 148 | 2 METER | SINGLE | 20 | 2.5 | \$14.50 |
| | | DOUBLE | 40 | 2.5 | \$26.50 |
| 146 to 174 | HIGH BAND | SINGLE | 20 | 2.5 | \$14.50 |
| | | DOUBLE | 40 | 2.5 | \$26.50 |
| 220 to 225 | 1 1/4 METER | SINGLE | 18 | 2.5 | \$14.50 |
| | | DOUBLE | 35 | 2.5 | \$26.50 |
| 225 to 300 | UHF AIRCRAFT | SINGLE | 15 | 2.5 | \$14.50 |
| | | DOUBLE | 30 | 2.5 | \$26.50 |

DATA SIGNAL, INC.

DRAKE TVI FILTERS

High Pass Filters for TV sets provide more than 40 dB attenuation at 52 MHz and lower. Protect the TV set from amateur transmitters 6-160 meters.



Drake TV-75-HP \$13.25
Model No. 1610. For 75 ohm TV coaxial cable; TV type connectors installed

LOW PASS FILTERS FOR TRANSMITTERS have four pi

sections for sharp cut off below channel 2, and to attenuate transmitter harmonics falling in any TV channel and fm band. 52 ohm. SO-239 connectors built in.

Drake TV-5200-LP Model No. 1609. 200 watts to 52 MHz. Ideal for six meters. For operation below six meters, use TV-3300-LP or TV-42-LP. \$26.60

Drake TV-3300-LP Model 1608 1000 watts max. below 30 MHz. Attenuation better than 80 dB above 41 MHz. Helps TV i-f interference, as well as TV front-end problems. \$26.60



Drake TV-42-LP Model No. 1605 is a four section filter designed with 43.2 MHz cut-off and extremely high attenuation in all TV channels for transmitters operating at 30 MHz and lower. Rated 100 watts input. \$14.60



Drake TV-300-HP \$10.60
Model No. 1603. For 300 ohm twin lead



Tufts Radio Electronics • (617) 395-8280

TC-4

TUFTS RADIO CATALOG TUFTS RADIO

Who Needs Transistors?

— you do!

Carl C. Drumeller WSJJ
5824 NW 58
Warr Acres OK 73122

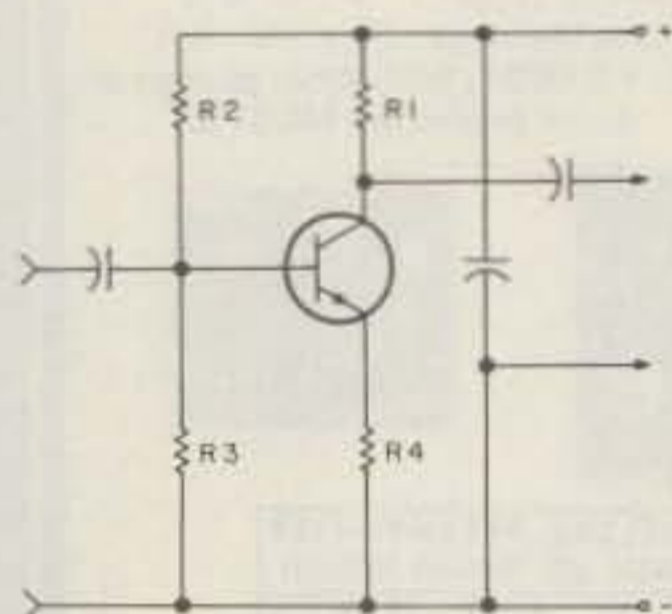

Fig. 1. Common-emitter bias configuration.

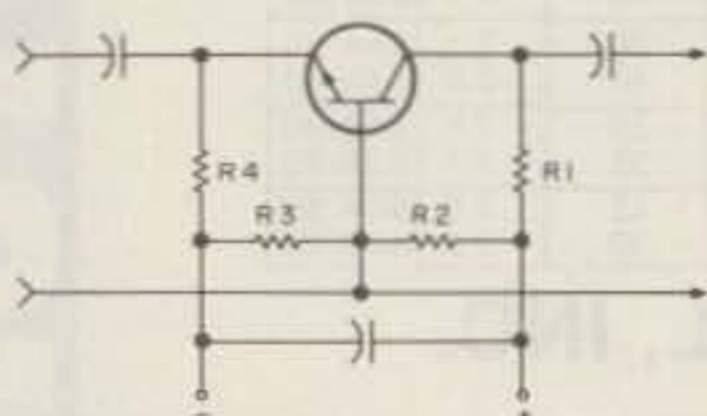

Fig. 2. Common-base configuration.

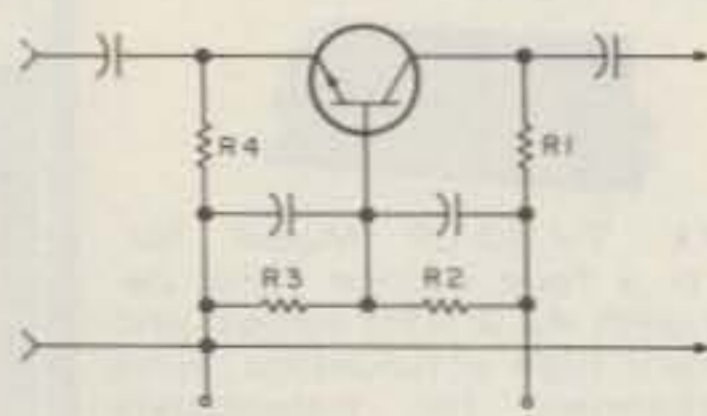

Fig. 3. Practical common-base circuit.

Although ICs are the "in" item for experimenters and homebrewers, the old bipolar transistor still has its place. Most experimenters have a junk box well populated with assorted transistors. If not, they can be bought cheaply, or mooched from friends who have an overstock. The purpose of this article is to encourage using transistors—not only using them, but using them to maximum advantage.

Most of the diagrams you see show transistors used in the grounded-emitter (or common-emitter) configuration. There are times, though, when it would be better to employ the common-base configuration. Then one must tackle the problem of providing proper bias for that mode.

Take a look at Fig. 1, which shows an excellent bias circuit for a transistor in the common-emitter configuration. Let's review it a bit. The four resistors have been given an arbitrary set of numbers, although there is a slight amount of logic involved. The collector resistor is vital to permit power to be taken off, so it's #1. Bias of the same polarity as the collector voltage must be supplied to the base before collector current will flow, so that resistor is #2. To provide bias stability, there's need of a voltage-divider effect between the collector supply and "ground," with a tap for the base, so the lower half of that divider gets a #3 ranking. A bit of emitter bias serves two purposes: It helps to prevent thermal runaway and it tends to "smooth out" the differences between individual transistors of the same type, thereby enhancing the inter-

changeability of transistors. You can live without it, though, so it gets the lowest ranking: #4. Resistor #2 is quite important. Contrary to general presumption, its value has a considerable bearing upon the circuit gain. It's suggested that you build up a test circuit like that of Fig. 1. Make it for audio frequencies, which means you should select input and output capacitors of values that'll pass af readily—somewhere between 100 nanofarads and 100 microfarads. If you're concerned only with circuit gain, put an audio signal generator on the input and an ac voltmeter across the output. With a very low voltage from the signal generator (overdriving will destroy the validity of the adjustment), adjust R2 for maximum output. Use a variable resistor initially for R2. After the adjustment is made, measure the resistance and substitute a

TOROID CORES

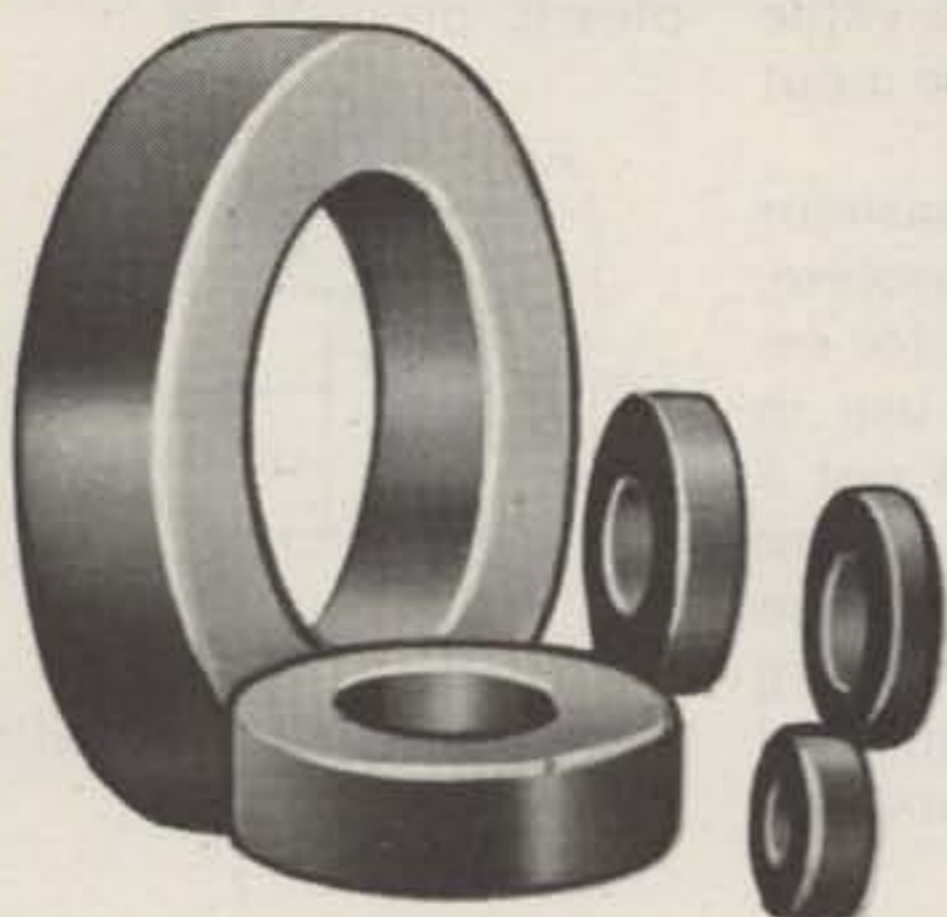

- ✓ All the popular sizes and mixes.
- ✓ Fast Service. Same day shipment via first class mail or air.
- ✓ No minimum order.

IRON POWDER TOROIDS:

| CORE SIZE | MIX 2 5-30 MHz u = 10 | MIX 6 10-90 MHz u = 8.5 | MIX 12 60-200 MHz u = 4 | SIZE OD (in.) | PRICE USA \$ |
|-----------|--------------------------------|----------------------------------|----------------------------------|---------------------|--------------------|
| T-200 | 120 | | | 2.00 | 3.25 |
| T-106 | 135 | | | 1.06 | 1.50 |
| T-80 | 55 | 45 | | .80 | .80 |
| T-68 | 57 | 47 | 21 | .68 | .65 |
| T-50 | 51 | 40 | 18 | .50 | .55 |
| T-25 | 34 | 27 | 12 | .25 | .40 |

RF FERRITE TOROIDS:

| CORE SIZE | MIX Q1 u = 125 .1-70 MHz | MIX Q2 u = 40 10-150 MHz | SIZE OD (in.) | PRICE USA \$ |
|-----------|-----------------------------------|-----------------------------------|---------------------|--------------------|
| F-240 | 1300 | 400 | 2.40 | 6.00 |
| F-125 | 900 | 300 | 1.25 | 3.00 |
| F-87 | 600 | 190 | .87 | 2.05 |
| F-50 | 500 | 190 | .50 | 1.25 |
| F-37 | 400 | 140 | .37 | 1.25 |
| F-23 | 190 | 60 | .23 | 1.10 |

Chart shows uH per 100 turns.

FERRITE BEADS:



\$2.00 DOZEN

WIDE BAND CHOKES



95¢ EACH

TO ORDER: Specify both core size and mix for toroids. Packing and shipping 50 cents per order USA and Canada. Californians add 6% sales tax.

Fast service. Free brochure and winding chart on request.

PALOMAR ENGINEERS
 BOX 455, ESCONDIDO, CA 92025
 Phone: (714) 747-3343

How You Can Convert Your Rohn 25G Tower to a FOLD-OVER

CHANGE, ADJUST OR JUST PLAIN WORK ON YOUR ANTENNA AND NEVER LEAVE THE GROUND.

If you have a Rohn 25G Tower, you can convert it to a Fold-over by simply using a conversion kit. Or, buy an inexpensive standard Rohn 25G tower now and convert to a Fold-over later.

Rohn Fold-overs allow you to work completely on the ground when installing or servicing antennas or rotors. This eliminates the fear of climbing and working at heights. Use the tower that reduces the need to climb. When you need to "get at" your antenna . . . just turn the handle and there it is. Rohn Fold-overs offer unbeatable utility.

Yes! You can convert to a Fold-over. Check with your distributor for a kit now and keep your feet on the ground.

AT ROHN YOU GET THE BEST

Do not attempt to raise antenna or antenna support near power lines— You can be KILLED!

Unarco-Rohn
 Division of Unarco Industries, Inc.
 P.O. Box 2000, Peoria, Illinois 61601

✓ U2

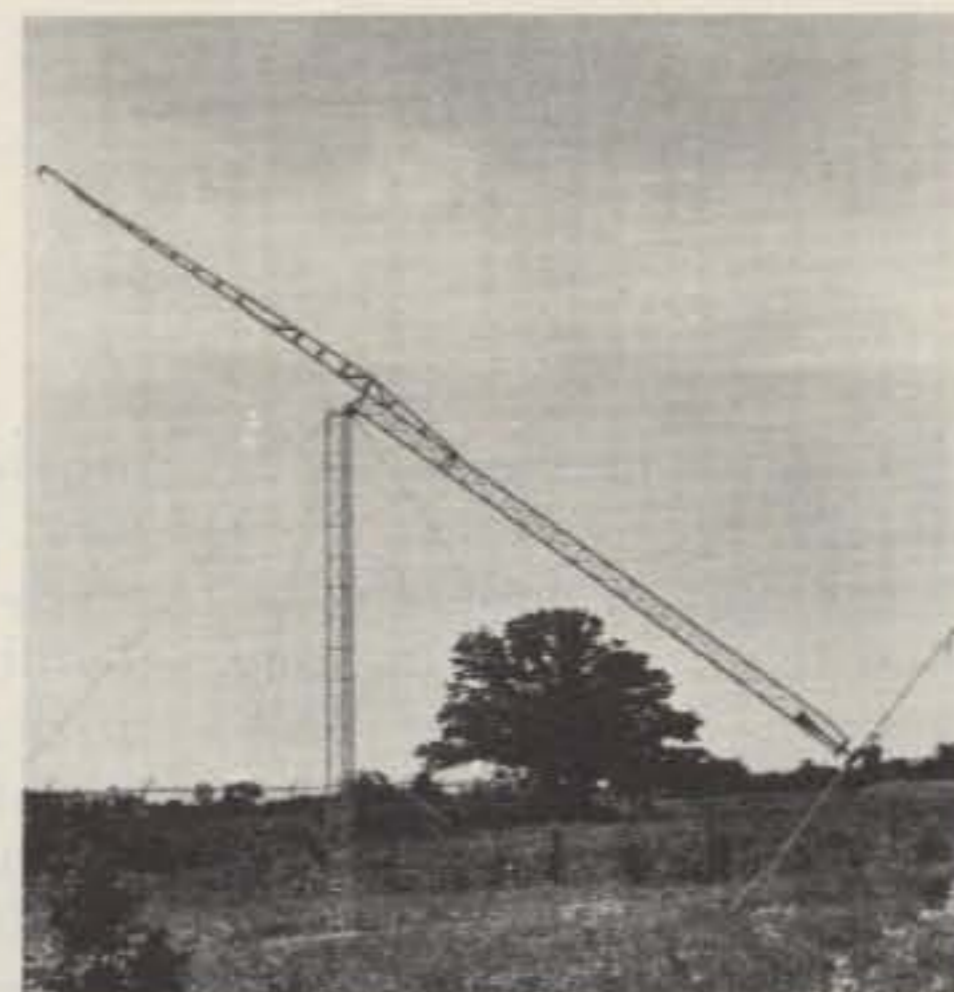
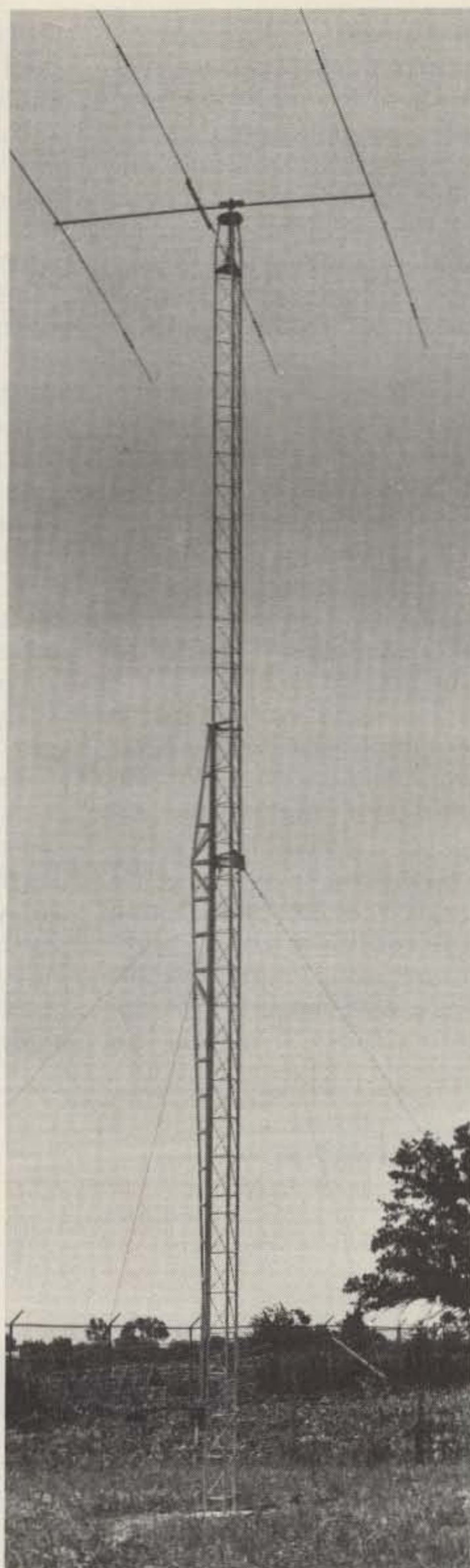

fixed resistor. If, however, you're primarily concerned with purity of waveform, use an oscilloscope as the output indicator and adjust R2 for simultaneous flattening of positive-going and negative-going peaks as the input signal level is advanced to the distortion point.

After you've found the optimum bias for a transistor used in the common-emitter configuration, the next step is juggling the circuit to retain that value of bias in a common-base circuit. Fig. 2 shows the first move, and Fig. 3 illustrates the desired circuit.

Now that you've got a common-base circuit, what can you do with it? For one thing, it makes an excellent active impedance-matching device. It'll match a low-impedance microphone to a high-impedance input circuit very well indeed. In rf applications, it needs no

neutralizing, making it ideal for a tuned pre-amplifier. Just replace R1 with a resonant circuit. You may have to place ferrite beads on the transistor's leads to avoid UHF parasitics. If you want a stage that will amplify without the 180° phase shift of the common-emitter configuration, the common-base circuit meets that requirement.

As an impedance transformer, try the circuit in Fig. 4. I've used it to match a 25-Ohm dynamic microphone to the high-impedance input of a Drake TR-4C transceiver.

If you need a little extra gain at the front end of a receiver, and most receivers lack gain on 21 MHz and especially on 28 MHz, use the circuit of Fig. 5. The unbypassed emitter resistor serves as a matching termination for the coaxial feedline to an antenna, and the source-

follower (common-source) FET stage transforms the high impedance of the resonant circuit to a value suitable to match the input of most receivers.

The individual transistor is far from being obsolete. It's especially good for experiments and for use in simple projects. It's not a "black box." You can see what's being used and can analyze what's taking place. In short, it's an ideal device for the amateur

who wants to keep building projects but lacks the time (or desire) to tackle complex IC projects. ■

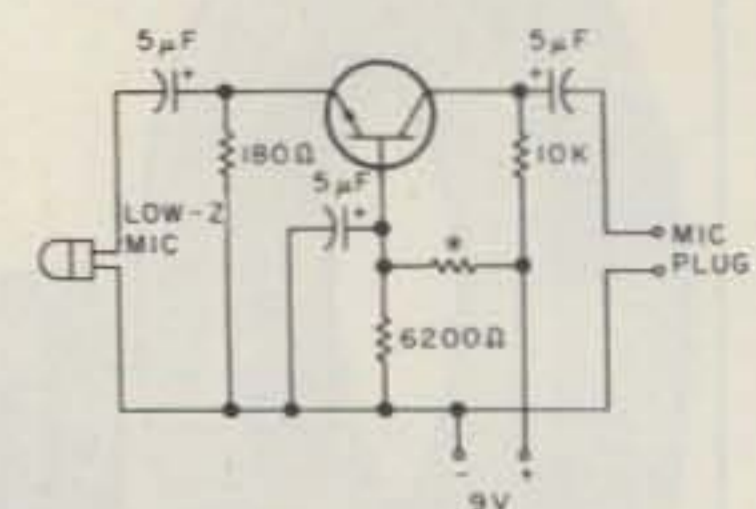

Fig. 4. Impedance-matching circuit.

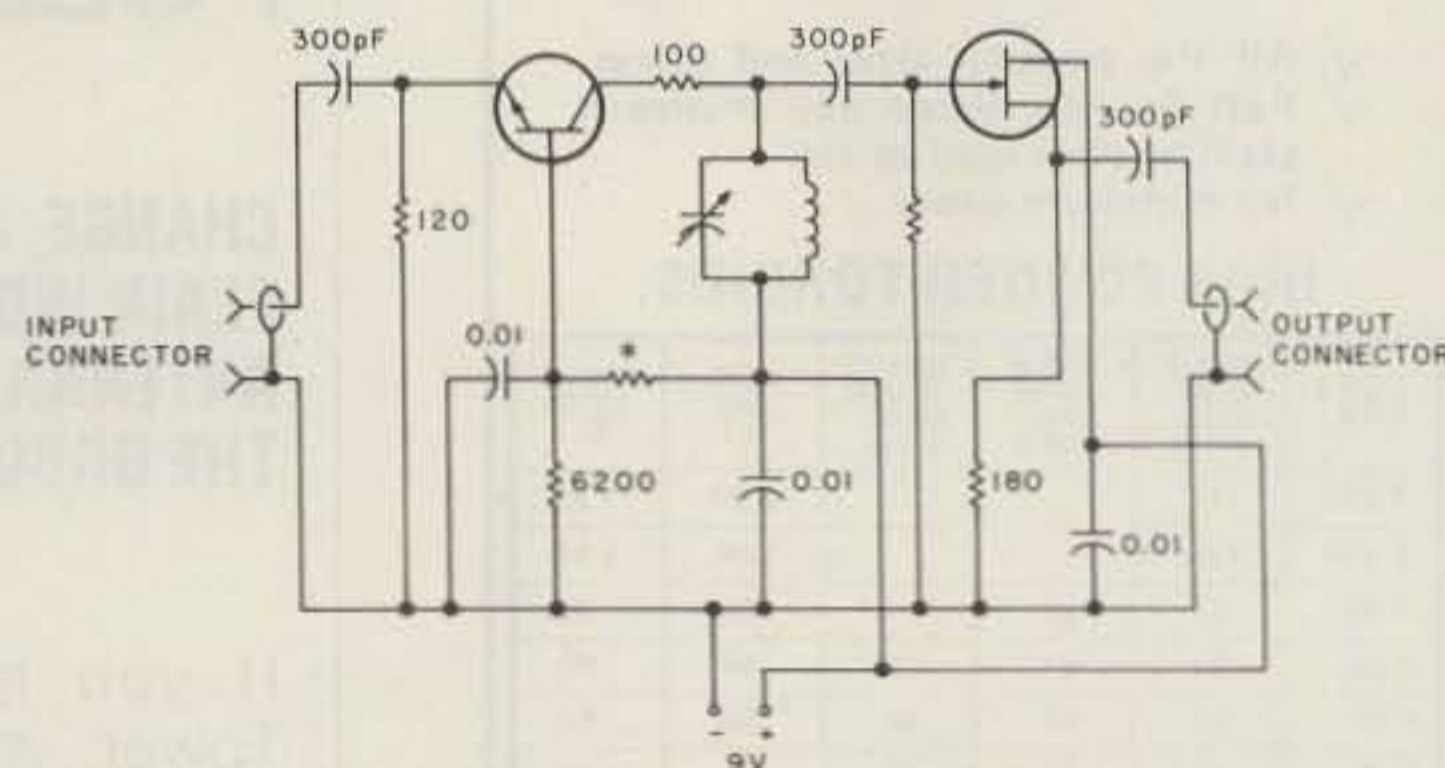

Fig. 5. Preamplifier circuit. Adjust resistor marked with an * for maximum gain.

Carl C. Drumeller W5JJ
5824 NW 58 Street
Warr Acres OK 73122

A Junk Box Load Simulator

— for battery testing

It's often inconvenient to test the voltage of a 9-volt battery under its normal load, and testing one with a low-current voltmeter gives a reading that is almost meaningless.

Here's a way to make up a handy little device for

providing a load to the battery. The next time you're ready to toss out a dead 9-volt battery, take a pair of diagonal cutting pliers, pry off the top, and detach it from the interior cells. You'll note that this top will mate with the connec-

tors on a new battery. So, just solder a ½-Watt resistor of somewhere between 500 and 1000 Ohms across the connectors of the old top. Now, when you're ready to test a battery, just clip it on the new battery and apply the volt-

meter. The load of the resistor will place a drain typical of the average device powered by a 9-volt battery, so you'll be reading the voltage under a typical operating condition. If it's under 8 volts, discard the battery. ■

The Small Computer Magazine

Kilobaud Magazine, aimed at the computer hobbyist and small businessman who wants to learn the fundamentals of computers, is an ongoing ENCYCLOPEDIA OF COMPUTING growing in size and information every month. The complete encyclopedia includes over 4000 pages on:

Programs to help you with your system. . .
News of new hardware and software. . .
Evaluations of new hardware you may be interested in getting. . .
Thought-provoking articles. . .
The key to having fun with your computer. . .
Hints on how to save money with microcomputers. . .
Hints on how to make it rich using your computer. . .
Information exchanges for hobbyists. . .
and more. . .

Kilobaud believes that hobby computing is the forerunner of small business computing, home computing, and widespread educational uses. To stay in touch with what's happening day to day in the world of computing, or if you are just getting into computers, or if you are just getting interested, Kilobaud is for you. It's written to be understandable for beginners and interesting for experts. As a special offer to new subscribers, fill out the coupon for your subscription, and if you like, get your encyclopedia started with some of our back issues. If you take full advantage of this offer, you'll save \$50!!

As a limited offer to new subscribers, Kilobaud will send you the following with a subscription to Kilobaud. . .

One-year subscription for \$18 (25% off the cover price)
Three-year subscription for \$45 (37½% off the cover price)
Up to 10 back issues (our choice) to get your encyclopedia started, at \$1.50 each (50% off, save up to \$15)
A Kilobaud Binder, as advertised, for \$5.50 (you save \$1)
That's a savings of up to \$40—for the most comprehensive encyclopedia of computing available.

Fill out the attached coupon today (be sure to tell us how many back issues you want).

You need not send money now; we'll bill you later if you like (the back issues and your binder will be sent after invoice has been paid).

Please Rush My Subscription To Kilobaud and Start My Encyclopedia of Computing. . .

One Year @ \$18
 Three Years @ \$45
_____ Back Issues (up to 10, our choice) @ \$1.50 ea.
Qty. _____
_____ Kilobaud Binder @ \$5.50

Total Enclosed Bill Me
 Master Charge Visa Card # _____ Exp. date _____

Signature _____

Name _____

Address _____

City _____ State _____ Zip Code _____



S11B

Blockbuster RTTY Article!

— Selcal and W-R-U on a budget

Richard R. Parry W9IF
38 W 255 Deerpath Rd.
Batavia IL 60510

How do you make a great mode like RTTY even better? Easy—join an autostart group. Any RTTY aficionado can join an autostart group. Autostart operation allows friends to keep in contact with each other, and, best of all, you don't have to be present to receive the message. The teleprinter is controlled by the station sending the message.

If an all-call system is used rather than a selective calling system like the one described in this article, chances are you will

come home to a teleprinter with an empty roll of paper. If you don't mind culling through the print-out looking for your note, and if you're one of the amateurs with plenty of teleprinter paper to spare, the simple all-call circuit will be just fine. However, most autostart members prefer a selective calling system (Selcal) to ensure only notes addressed to them are received.

Before the burgeoning of integrated circuits, the selective calling system used a mechanical stunt box. The stunt box is a subsystem of the Model 28 teleprinter which allows the user to program control functions into the

teleprinter by inserting code bars. Typically, an autostart enthusiast would program the stunt box so that the last three letters of his call would turn on the teleprinter, and four consecutive Ns (NNNN) would turn it off. While this system works well, few amateurs are fortunate enough to own a Model 28.

One other pleasant feature of an autostart station is the W-R-U system. Leaving a note for a friend can be a hit-or-miss affair unless you are sure his equipment is up and running. While some autostart members leave their equipment on 24 hours a day, it is still reassuring to receive some feedback informing

you that the equipment is functioning and that you are not just talking to the air (no pun intended). An answer-back system, also referred to as a Who-Are-You (W-R-U), allows one to, in essence, interrogate the condition of the equipment. To interrogate the station's status, one typically types the last three letters of the station's call followed by the characters Figures, Blank, and H. When the W-R-U circuit detects this sequence, the receiving station's transmitter is turned on briefly and a short message is sent. Some stations transmit a short message giving the station's call and location. Other stations may transmit, in addition to the above, the present time and date.

The W-R-U has an additional feature—it can be used to ascertain present propagation conditions. Imagine being able to turn on a transmitter thousands of miles away to confirm the present propagation characteristics. Thus, if there is no signal, or perhaps only a weak signal in answer to your W-R-U attempt, you may then decide not to attempt a full message.

Note that, unlike the Selcal system, a licensed amateur must be on the premises in order to legally have the W-R-U system operational.

Fig. 1 shows the block diagram of the Selcal and W-R-U system described in this article. The circuit was fabricated on two printed circuit boards: IF-1 and IF-2.

The IF-1 circuit has two functions. It changes the serial output data of the demodulator to parallel data and simultaneously regenerates it. Parallel data simply indicates that all five bits of the Baudot code are available simultaneously. This parallel

Photos by Anthony Donaldson

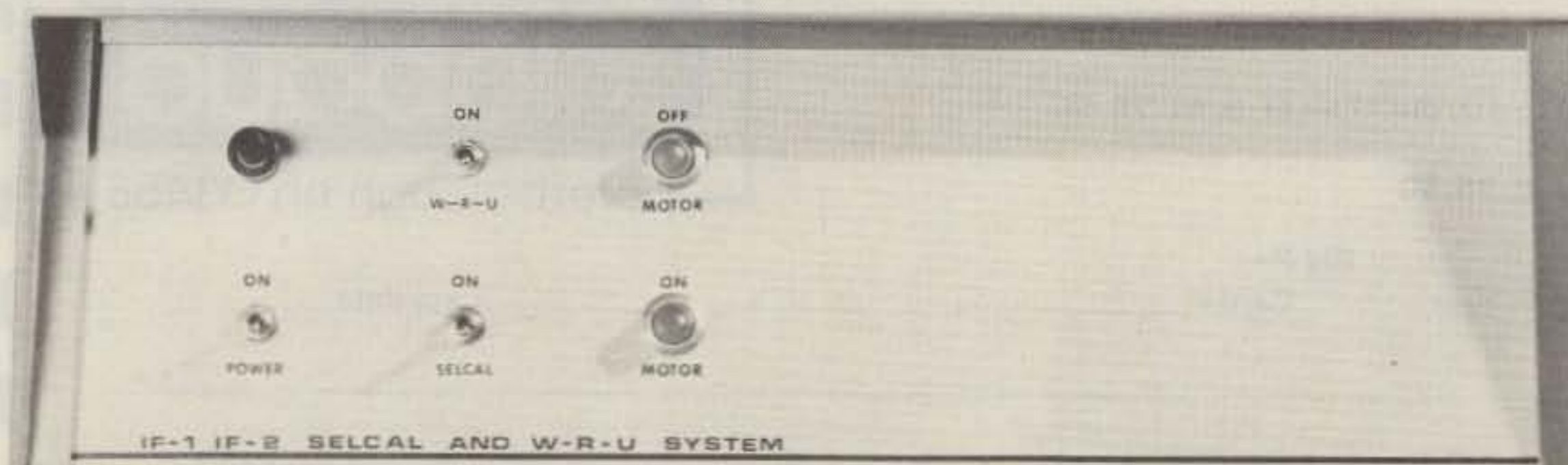

Photo 1. The IF-1 and IF-2 Selcal, W-R-U, and regenerative repeater.

data is then fed back into the UART chip, giving us serial data once again. However, it should be noted that this serial data has been regenerated and is free of distortion. For this reason, it is called a regenerative repeater. If you built only this portion of the project, you would already have improved your station.

The IF-2 circuit decodes the parallel data and determines what operation is called for (i.e., turn on the teleprinter, turn off the teleprinter, turn on the transmitter).

Building this particular Selcal and W-R-U system has several advantages. For example:

- The Selcal and W-R-U access code can be programmed in a matter of minutes.

- The Selcal and W-R-U access code may be programmed for any Baudot code character.

- The W-R-U circuit automatically shuts down after a predetermined time-out period. Therefore, the transmitter cannot be latched in the "on" state simply because a shut-down command was not received.

- Open collector outputs allow easy interfacing between the unit and the station.

- Many interfacing techniques are available. One method allows the W-R-U circuit to turn on the transmitter for "x" seconds (typically 10) before the W-R-U message is sent. This grace period allows time for tuning and actuating switches by the receiving station if necessary.

- For those with a UT-4 or some other serial to parallel circuit, the IF-1 board is not required.

- For those simply wishing a regenerative repeater, the IF-2 board is not required.

- For those wishing only

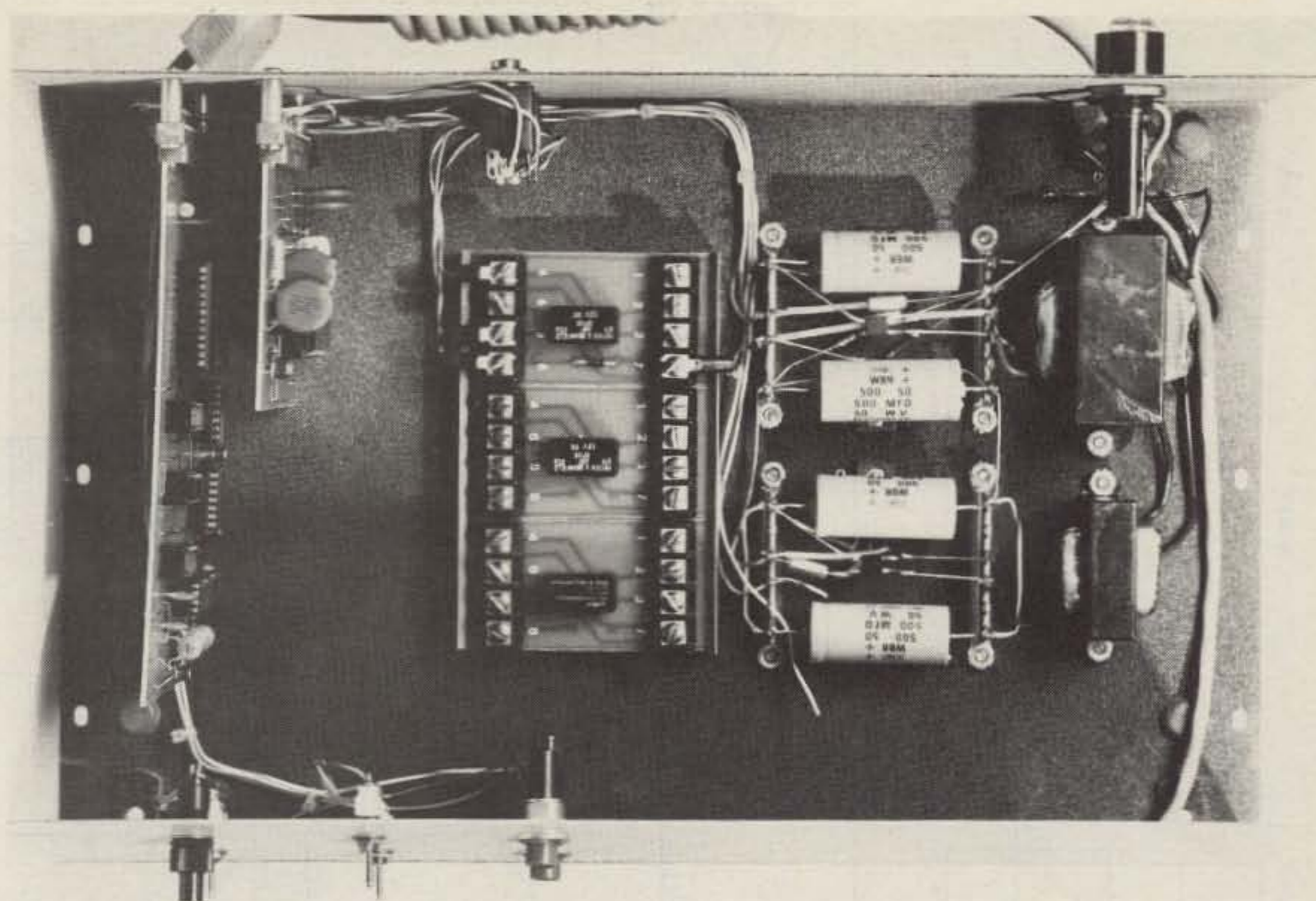

Photo 2. Top view of the unit. The IF-2 Selcal and W-R-U board is shown at the extreme left. The IF-1 regenerative repeater board is located to its immediate right. The relays to control the teleprinter, transmitter, and W-R-U message generator are shown slightly left of center. The power supply uses the remainder of the chassis.

a Selcal, only a portion of the IF-2 circuit need be used.

- Construction of the unit is facilitated by the use of professionally

fabricated and drilled printed circuit boards available from the author.

The Regenerative Repeater

The IF-1 circuit has two

functions: It changes the serial data to parallel, and it regenerates the signal at the same time. The regeneration process removes bias distortion from the

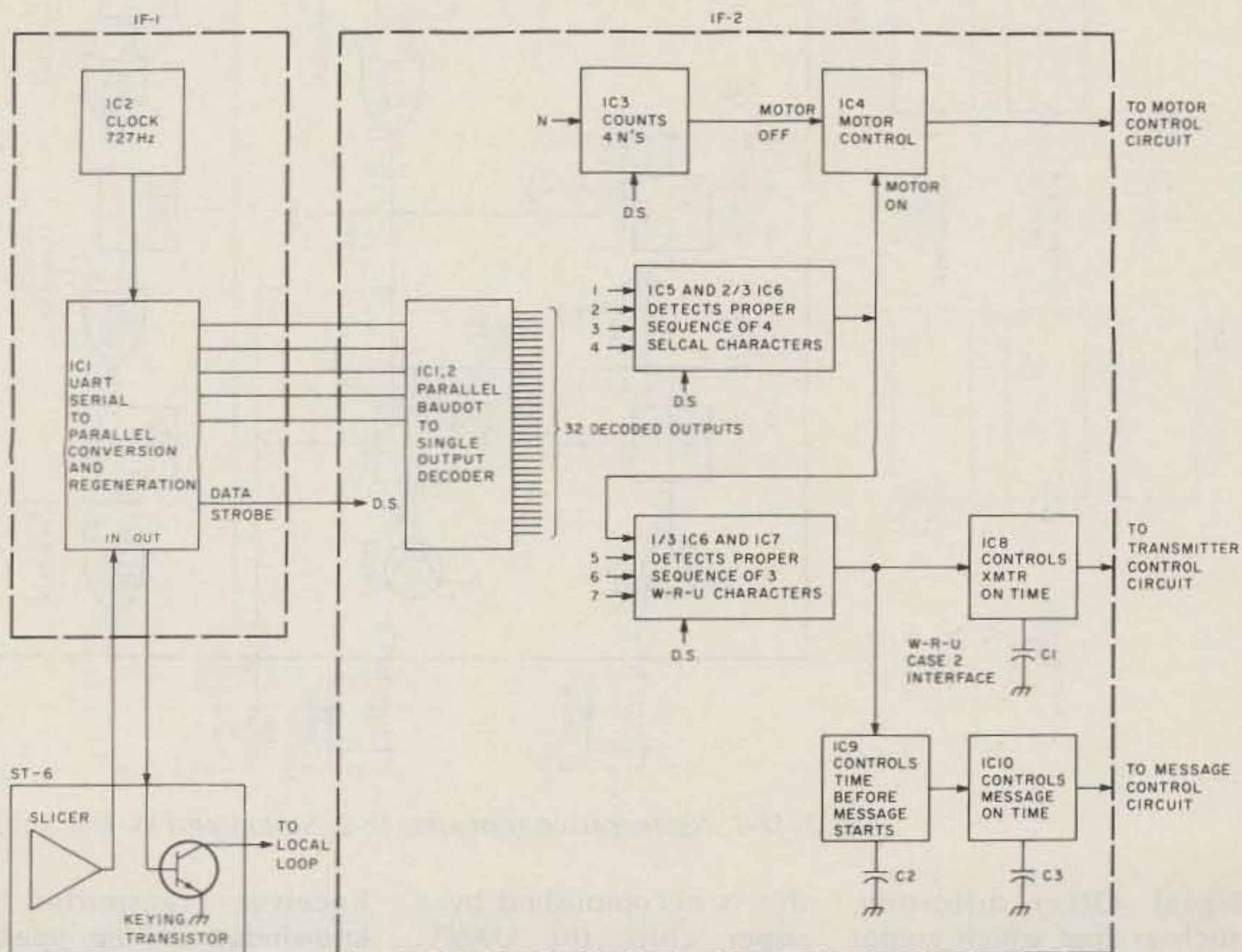

Fig. 1. Block diagram.

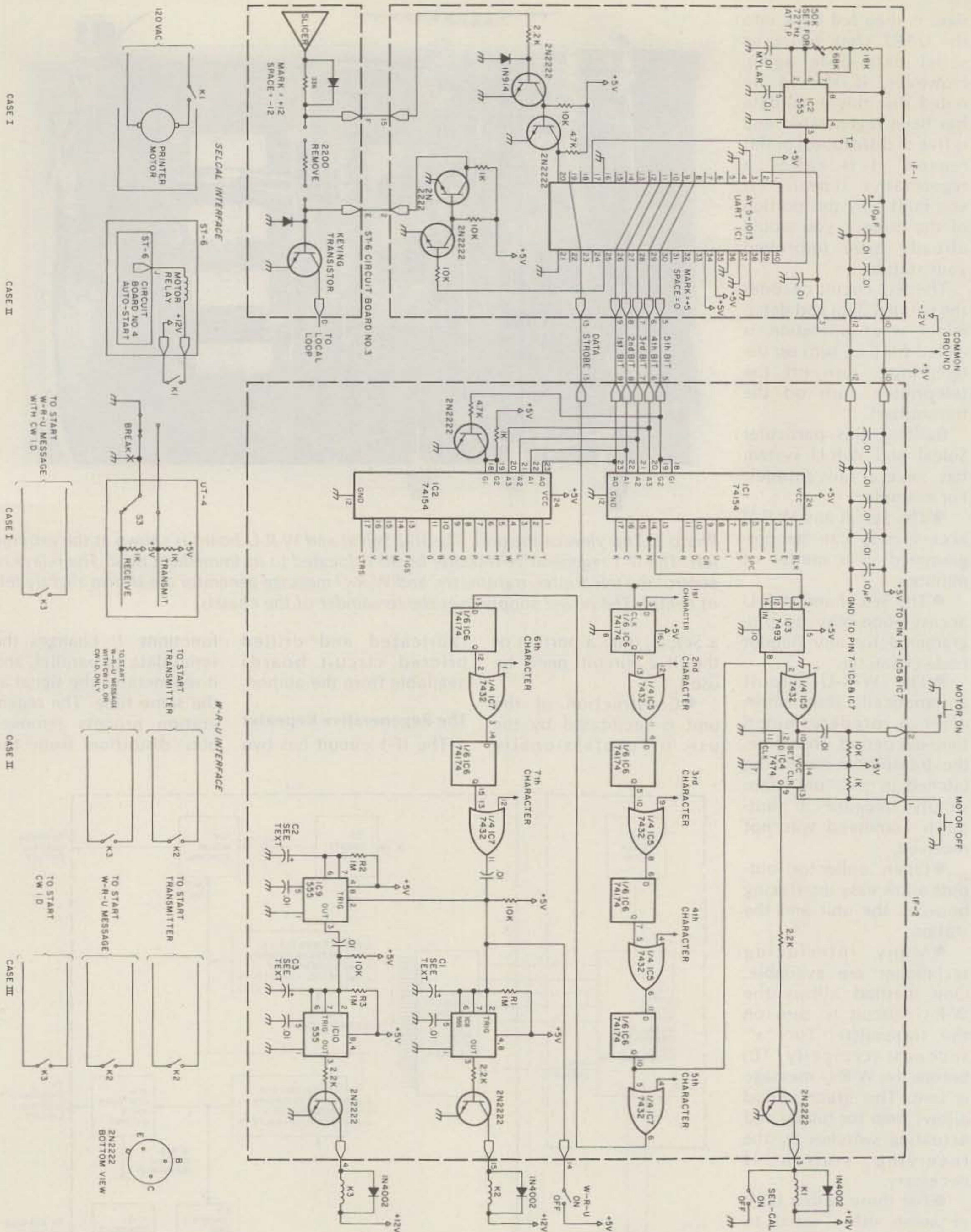

Fig. 2. IF-1, regenerative repeater, IF-2, Selcal and W-R-U schematic.

signal. Other distortion, such as that which comes from dirty keyboard contacts, is also removed. All

this is accomplished by a super chip, the UART. UART is the acronym for Universal Asynchronous

Receiver Transmitter. A knowledge of the operation of this sophisticated integrated circuit is not

necessary to build this project. However, for those interested in more information on the UART,

see the series of articles by Irv Hoff listed in the references. Note that the UART is a MOS device and as such is sensitive to any electrostatic or high-voltage charge. This is why the device is shipped in a conductive material. Because of possible damage, the UART must be handled properly. Rather than define "properly" here, I refer the reader to the article by John Magee listed in the references.

The output of the slicer stage of a demodulator such as the popular ST-6 is +12 volts in the mark state and -12 volts in the space state. This is just the opposite of the RS-232C standard for interfacing. The slicer output is connected to a conditioning circuit consisting of two transistors in order to convert it to TTL levels for the serial input of the UART, pin 20.

Fig. 3 shows a timing diagram of a character traveling through the UART. Note that the output of the slicer, plus and minus 12 volts, is converted to +5 and 0 volts at pin 20. Pins 12, 11, 10, 9, and 8 are the 1st, 2nd, 3rd, 4th, and 5th bits of the Baudot code, respectively. These output pins do not change state until clocked by a data strobe generated within the UART. This data strobe signal is available at pin 19 of the UART. It is used by both the IF-2 circuit and by the transmitter section of the UART to convert the parallel data at pins 26, 27, 28, 29, and 30 back to serial data at pin 25.

The TTL output level at pin 25 of the UART is not capable of directly driving the demodulator's keying transistor. Therefore, an additional conditioning circuit consisting of two switching transistors connected as inverters is used

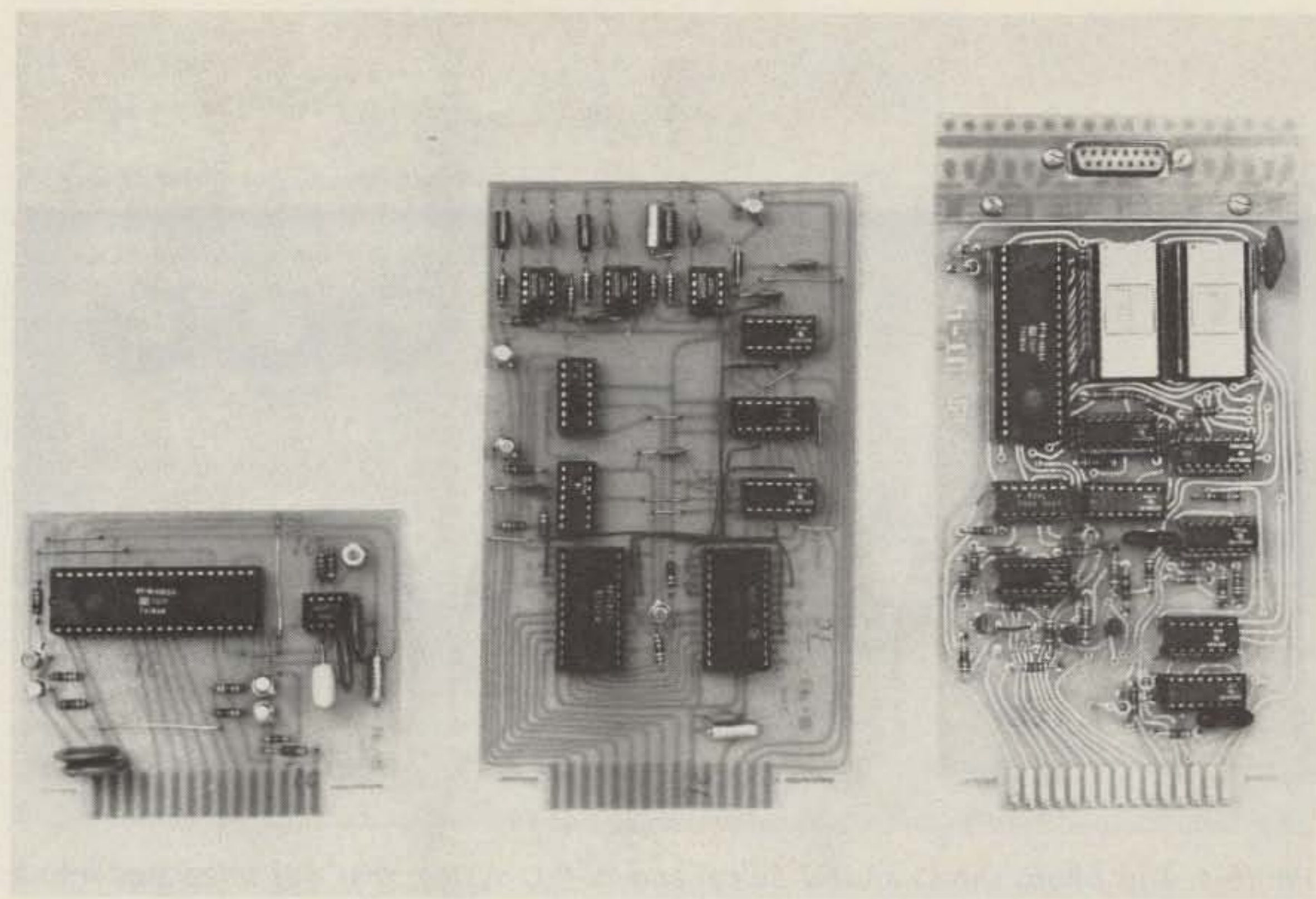

Photo 3. The small IF-1 regenerative repeater board is shown at the extreme left. In the center is the IF-2 board which contains the necessary circuitry for the Selcal and W-R-U. To the right of the IF-2 board is a UT-4 board that contains a UART. This board is not required for this project; however, it is shown here to indicate how those amateurs with a UT-4 using commercially fabricated boards may pick off the parallel data from the UART. Note that an extension was added to the board which contains a multi-pin connector. Wires from the output of the UART were run to the connector under the board. Using this method to obtain parallel data obviates the need for the IF-1 board.

to drive the keying transistor. IC2 is the clock for the UART and its output is available at the test point (marked T.P. on the PC board). It should be set at sixteen times the baud rate. For 60 wpm operation, this means a frequency of 727 Hz (16×45.45).

Decoding

The main purpose of the IF-1 circuit is to convert the serial data to parallel data so that all five bits of data are available simultaneously. Our next task is to decode these five bits of data so that each of the 32 possible Baudot characters has its own output port. To accomplish this end, two 4-line-to-16-line decoders are used. Each of these is capable of decoding a 4-bit binary number and addressing one of 16 outputs. Since the Baudot code is a five-bit code with 32 combinations, we use two of these chips to obtain the

necessary 32 output ports. Only one of these chips is on at a time. In addition, only one of the 32 outputs

is low at any given time. Table 1 shows the truth table for this Baudot decoding circuit. Pins 18

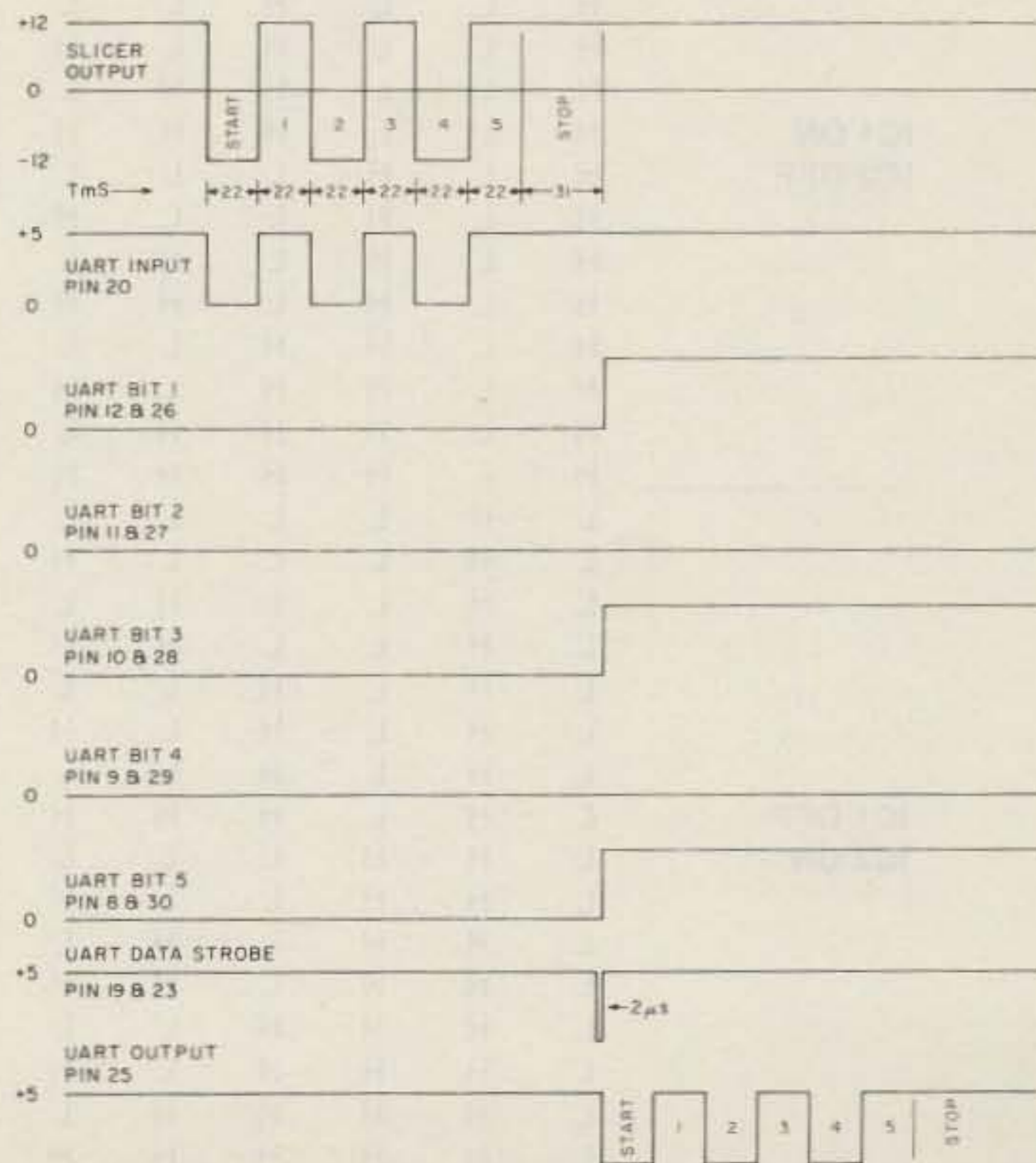

Fig. 3. UART timing chart.

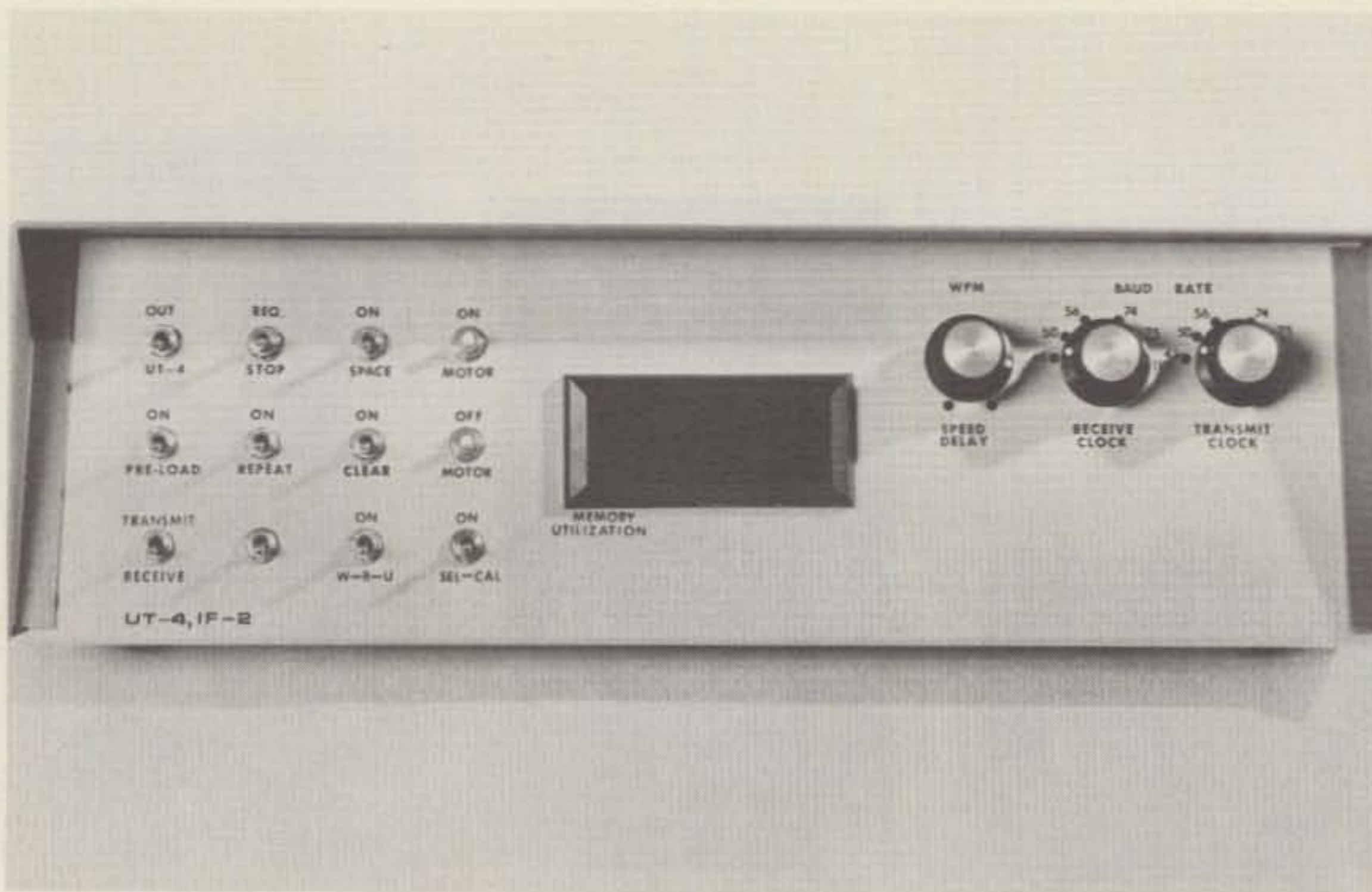

Photo 4. This photo shows an IF-2 Selcal and W-R-U system that was integrated into a UT-4. Only four switches are devoted to the Selcal and W-R-U circuitry.

and 19 of the 74154 are gates that must be low to enable the chip. Note in Fig. 2 that an inverting transistor circuit has been added to ensure that pins 18

and 19 of IC1 are always the complement of pins 18 and 19 of IC2. While IC1 is enabled, IC2 is disabled and vice versa. Only one of the 32 outputs of IC1 and IC2 are low; all remaining pins are high. The net effect of this circuit is to decode one of 32 outputs with 5 address lines. These 32 outputs are now available for programming any 4-character sequence for the Selcal and any 7-character sequence for the W-R-U.

Sequence Detection

Now that the Baudot code has been decoded and there is a unique output port for each character, we must detect the sequence of these characters. In addition, if an incorrect character or sequence is detected, the entire sequence must be started again. This task is accomplished by IC6 and IC5. IC6 is a 74174 hex D-type flip-flop. This chip contains 6 flip-flops that will pass along the data on the input (D) to the output (Q) only on the positive-going edge of the clock pulse. The clock pulse is supplied by the data strobe output of the UART.

Let's go through an example to illustrate the sequence detection process. The sequence circuit starts with all inputs and outputs high. Pin 3 of IC6 goes low on the first character. The UART data strobe then clocks the flip-flops and this low state is transferred to the output, pin 2. This output is then ORed with the second character. Let us assume the second character is not part of the correct access code. Therefore, pin 12 of IC5 will be high, pin 11 will be high, and hence the output of the second flip-flop, pin 5, will remain high. More importantly, the entire sequence must be started over again since there is now a high state on pin 3 of

| Binary Address Bit Number | 5 | 5 | A ₃ 4 | A ₂ 3 | A ₁ 2 | A ₀ 1 | Low Pin of IC1 | Low Pin of IC2 | Character |
|---------------------------|-------------------|-------|------------------|------------------|------------------|------------------|----------------|----------------|-----------|
| IC1 Pin Number | | 18,19 | 20 | 21 | 22 | 23 | | | |
| IC2 Pin Number | 18,19 | | 20 | 21 | 22 | 23 | | | |
| IC1 ON IC2 OFF | H | L | L | L | L | L | 1 | | Blk |
| | H | L | L | L | L | H | 2 | | E 3 |
| | H | L | L | L | H | L | 3 | | LF |
| | H | L | L | L | H | H | 4 | | A |
| | H | L | L | H | L | L | 5 | | SP |
| | H | L | L | H | L | H | 6 | | S |
| | H | L | L | H | H | L | 7 | | I 8 |
| | H | L | L | H | H | H | 8 | | U 7 |
| | H | L | H | L | L | L | 9 | | CR |
| | H | L | H | L | L | H | 10 | | D |
| | H | L | H | L | H | L | 11 | | R 4 |
| | H | L | H | L | H | H | 13 | | J |
| | H | L | H | H | L | L | 14 | | N |
| | H | L | H | H | L | H | 15 | | F |
| | H | L | H | H | H | L | 16 | | C |
| | H | L | H | H | H | H | 17 | | K |
| | IC1 OFF IC2 ON | L | H | L | L | L | L | | 1 |
| L | | H | L | L | L | H | | 2 | Z |
| L | | H | L | L | H | L | | 3 | L |
| L | | H | L | L | H | H | | 4 | W 2 |
| L | | H | L | H | L | L | | 5 | H |
| L | | H | L | H | L | H | | 6 | Y 6 |
| L | | H | L | H | H | L | | 7 | P 0 |
| L | | H | L | H | H | H | | 8 | Q 1 |
| L | | H | H | L | L | L | | 9 | O 9 |
| L | | H | H | L | L | H | | 10 | B |
| L | | H | H | L | H | L | | 11 | G |
| L | | H | H | L | H | H | | 13 | Fig |
| L | | H | H | H | L | L | | 14 | M |
| L | | H | H | H | L | H | | 15 | X |
| L | | H | H | H | H | L | | 16 | V |
| L | | H | H | H | H | H | | 17 | LTR |

Table 1. Baudot decoding chart.

IC6 and hence on its output. Now let us assume the second character coincides with the correct access code; pins 11, 12, and 13 of IC5 will all be low. This low is then passed on to the next OR gate. This process remains the same for the third and fourth characters. If the correct sequence is used, a low state finally appears at the fourth flip-flop, pin 10 of IC6. This low state is used to force the teleprinter motor on. If at any point an incorrect character is used, all outputs go high.

The W-R-U access code simply requires three additional characters to trip the W-R-U circuits. The detection of these characters occurs in a similar manner; however, an additional chip (IC7) is required.

NNNN Shutdown Detection

Now that we have turned on the teleprinter by using the correct access code, we must provide a means of turning it off. The customary code sequence to turn off the teleprinter is NNNN.

The heart of the NNNN shutdown circuit is a binary counter, IC3, a 7493. This chip simply counts the number of Ns. Pins 2 and 3 are enable pins that must be low for the chip to count. Since these pins are connected to the N output port of IC1, the chip is allowed to count only when an N is decoded. The input, pin 14, is connected to the UART data strobe. As seen from the timing chart, Fig. 3, a 2-microsecond pulse is generated by the UART for each and every character. However, the 7493 only counts Ns because it is disabled for all other characters.

IC4, a 7474, is a bistable latch that controls the teleprinter through relay K1. When the proper sequence has been detected

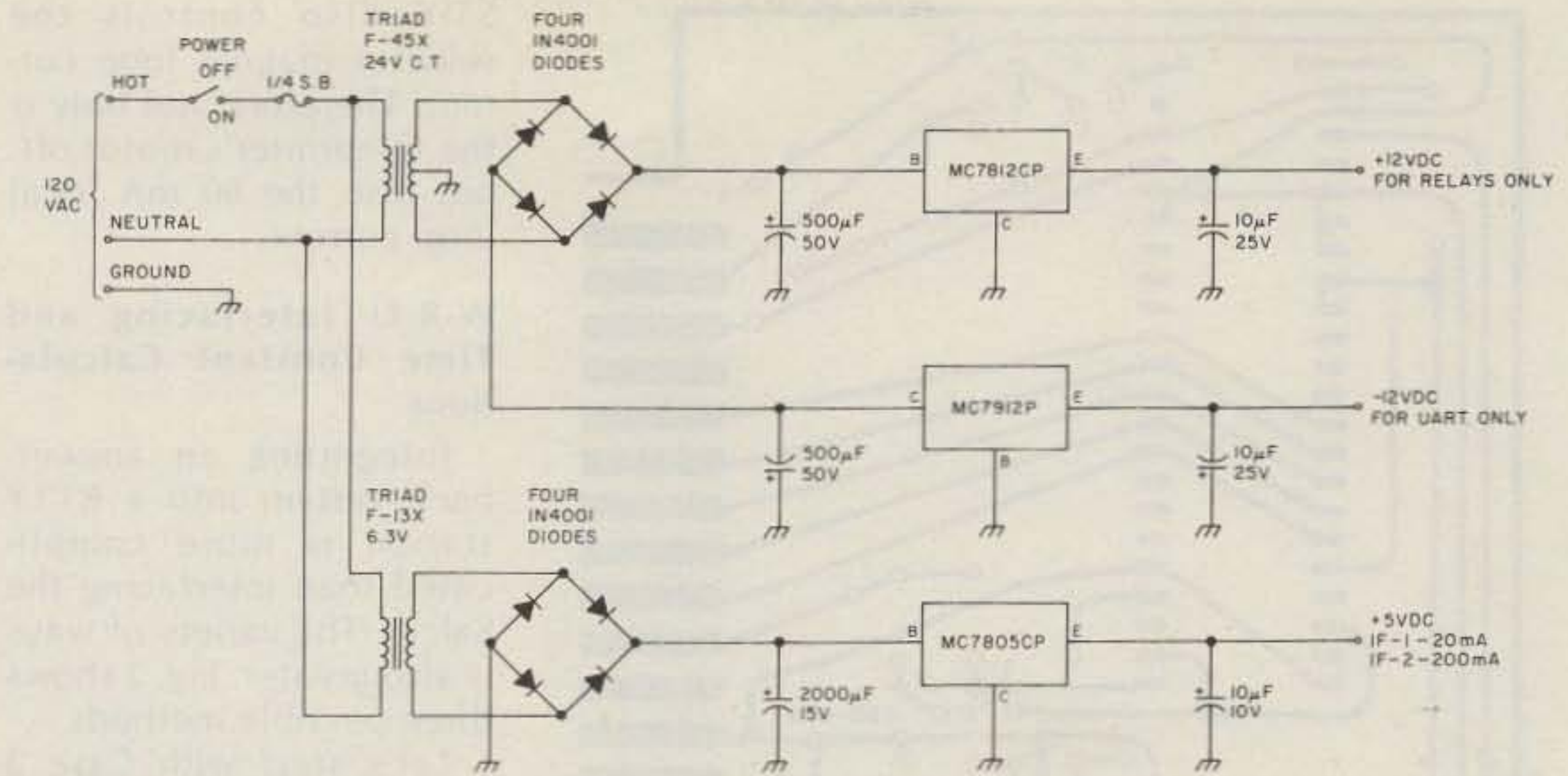

Fig. 4. Power supply.

by the Selcal sequence circuit, the output of IC4 is set, and when the NNNN shutdown code has been detected by IC3, the latch is, in essence, reset. Pins 10 and 13 of IC4 are used to externally force the motor on or off via the momentary switches.

Selcal Interfacing

The Selcal may be integrated into the RTTY sta-

tion in several ways. Fig. 2 shows two Selcal interfacing schemes. Case 1 shows the teleprinter motor controlled directly by the Selcal. This is the easiest method, and for those without a demodulator with autostart, the only method.

Case 2 is a superior interfacing technique for several reasons. By controlling the ST-6 demod-

ulator motor relay, we have, in essence, ANDed the autostart circuit in the demodulator with the Selcal circuit. This means not only must an authentic RTTY signal be present to trip the autostart circuit, but also the correct character sequence must be received. This means less of a chance of accidental turn-ons. More importantly, if the other station forgets to

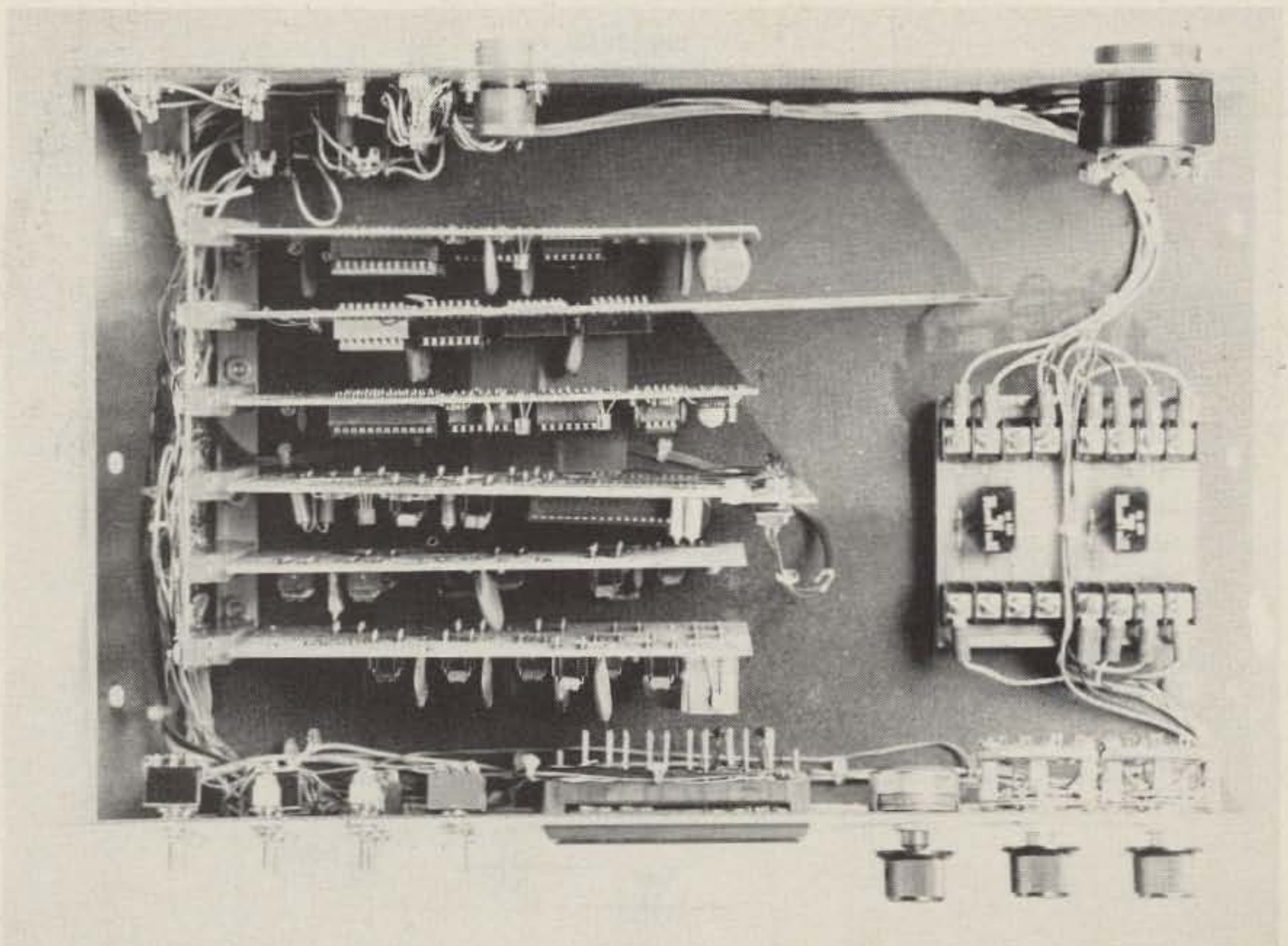

Photo 5. Top view of the UT-4 and IF-2 unit. Note the UART parallel data wires leaving the third board from the front. This is the board shown to the extreme right in Photo 3. These wires are terminated on the IF-2 board fourth from the front.

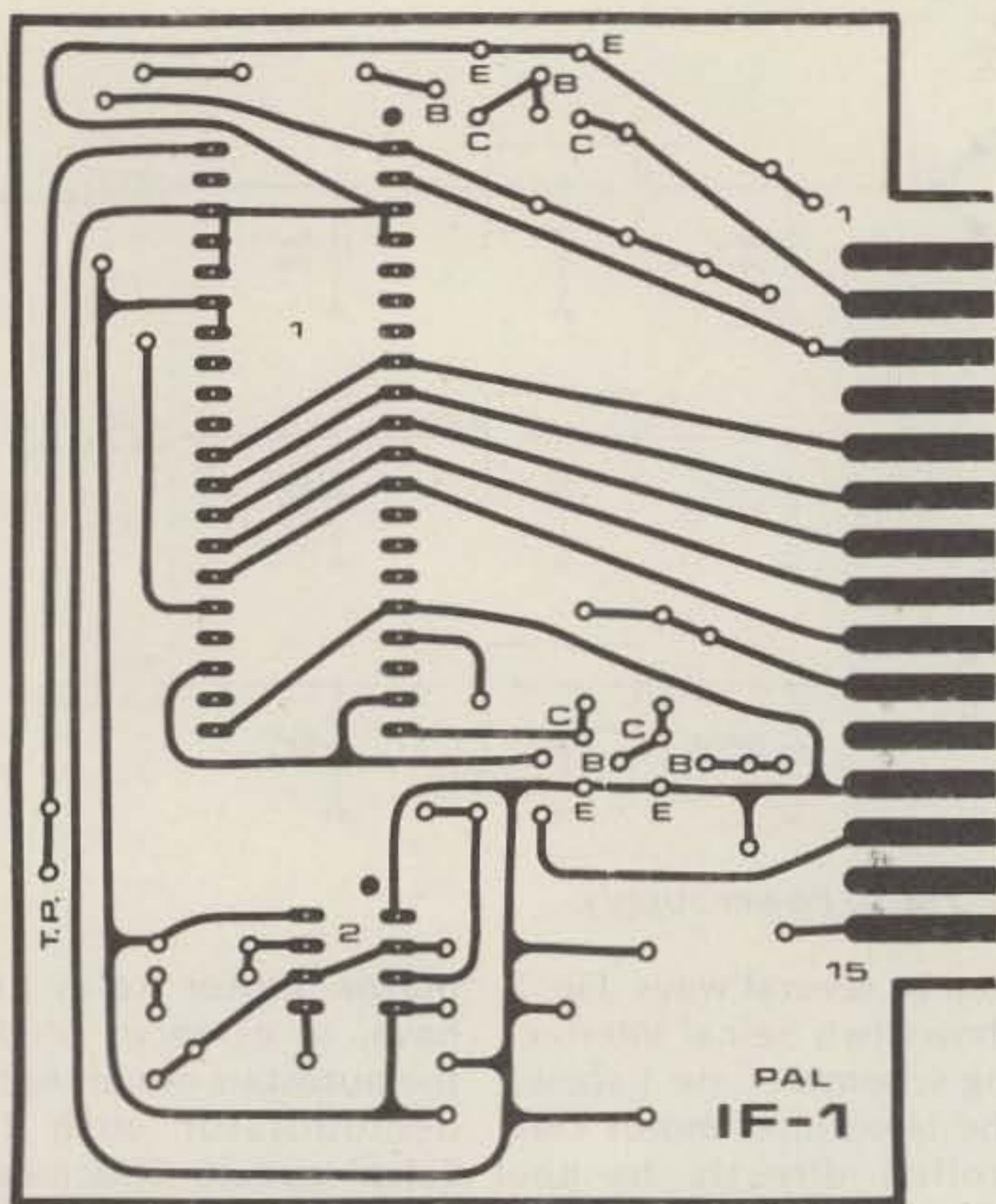

Fig. 5. IF-1 printed circuit board layout (full size).

send four Ns, the teleprinter will turn off when the RTTY signal ceases. Of course, you are now running simple autostart since the teleprinter will turn on

now with any RTTY signal, but the next station sending the four Ns will reset the circuit. Another advantage of Case 2 is the fact that the motor relay of the

ST-6 also controls the selector magnet loop current. Therefore, not only is the teleprinter's motor off, but also the 60 mA local loop current.

W-R-U Interfacing and Time Constant Calculations

Integrating an answer-back system into a RTTY station is more complicated than interfacing the Selcal. The variety of ways is also greater. Fig. 2 shows three possible methods.

Let's start with Case 3 first. In this interfacing scheme, it is assumed the station has a message-generating unit and a CW ID unit. Now let us assume that the W-R-U message lasts 20 seconds, and the CW ID requires 10 seconds. This means the transmitter must be on for a total of 30 seconds to allow both the W-R-U message and CW ID to be broadcast. The "on" time of the transmitter is determined by the RC time constant of IC8. The time constant is given by ap-

proximately $R \times C$. Since R is fixed at 1 meg for all timers (IC8, IC9, and IC10), the necessary capacitance for a 30-second time delay is 30 μ F. Therefore, this means that when the W-R-U access code is received, relay K2 will be energized for an interval of 30 seconds. K2 is a two-pole relay that simultaneously controls the transmitter and message-generating unit in this case. Since K2 is actuated for 30 seconds, the transmitter will be on for this 30-second period. Relay K2 also enables the message generator for 30 seconds. Since the message is 20 seconds long, the message generator used in this case must be able to inhibit itself after the 20-second message is complete. After 20 seconds has elapsed, the message is finished and we will want to start the CW ID. The time before the CW ID starts is determined by IC9. Here the capacitance necessary for C2 is approximately 20 μ F, giving a 20-second time delay. After IC9 has timed out, we want to start the CW ID. If you have an electronic CW ID unit, chances are a momentary closure of K3 will be satisfactory. Therefore, C3 may be 1 μ F to give a 1-second contact closure. If your CW ID unit requires a closure of K3 for the entire 10-second duration of the CW ID transmission, C3 should be 10 μ F.

Using the formula will only get you into the ballpark. The actual capacitance values for C1, C2, and C3 will have to be determined through trial and error.

The Case 2 interfacing method assumes that a unit that sends a message followed immediately and automatically by a CW ID is used. This is the method I use and it works as follows. Let's assume the message and CW ID transmission require a total of 30 seconds.

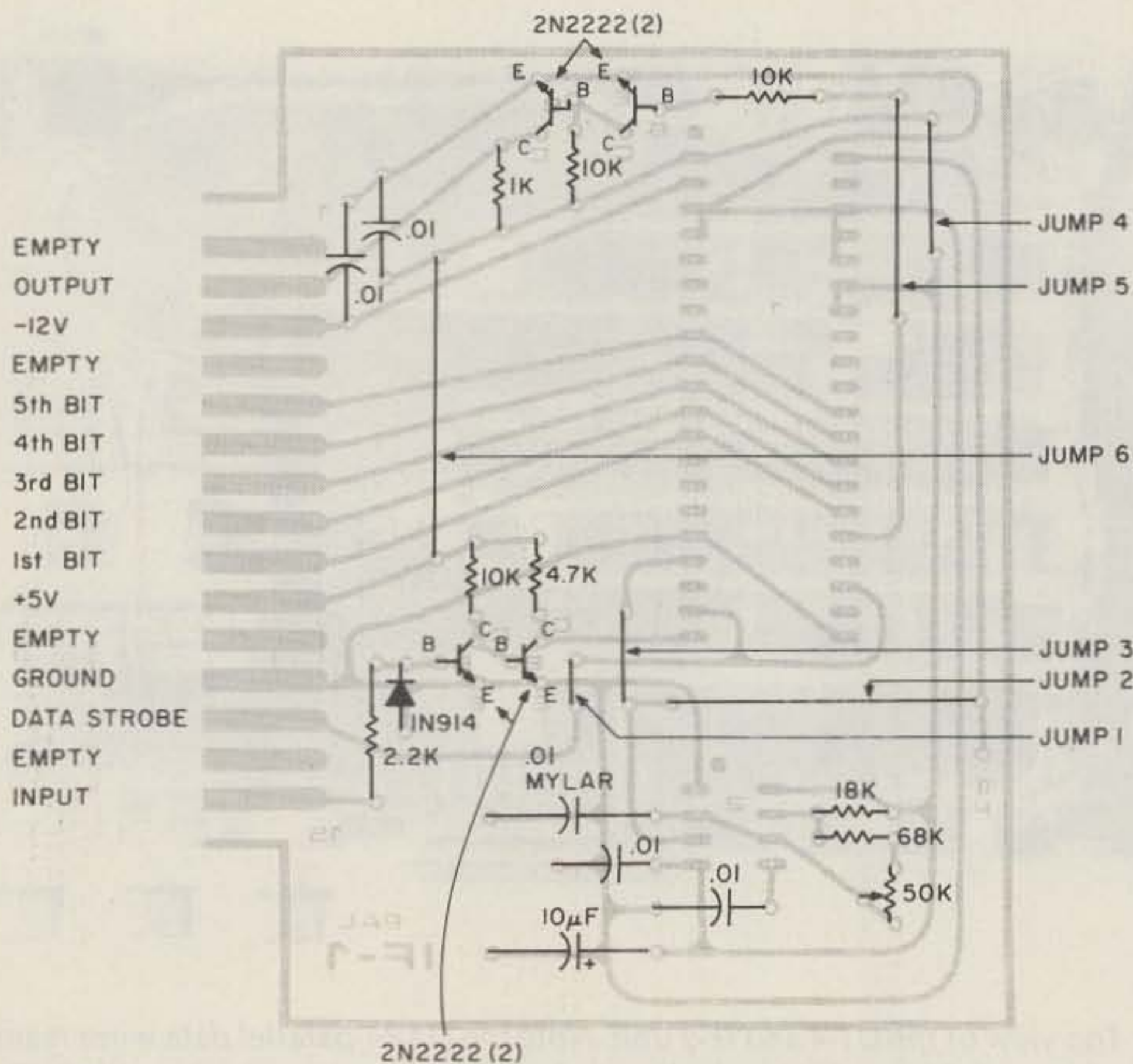

Fig. 6. IF-1 component placement.

Let us also assume that we do not want to start the message for 10 seconds. While this may seem strange, it is really a very nice feature. For with this method, the person receiving your message has a grace period of 10 seconds to turn switches and tune your signal in properly before the message and CW ID begins. This scheme requires the transmitter to be on for 40 seconds, the 10-second grace period plus the 30 seconds required for the message and CW ID. Therefore, C1 should be 40 uF. Since we want to pause for 10 seconds before starting the message and CW ID, we set C2 at 10 uF. Assuming the message and CW ID unit requires only a momentary contact closure to start the message and CW ID, C3 is set at 1 uF for a closure of relay K3 equal to 1 second. This interfacing method is also ideal for those amateurs with only a CW ID unit. For while it is nice to have a RTTY message followed by a CW ID, only the CW ID is legally neces-

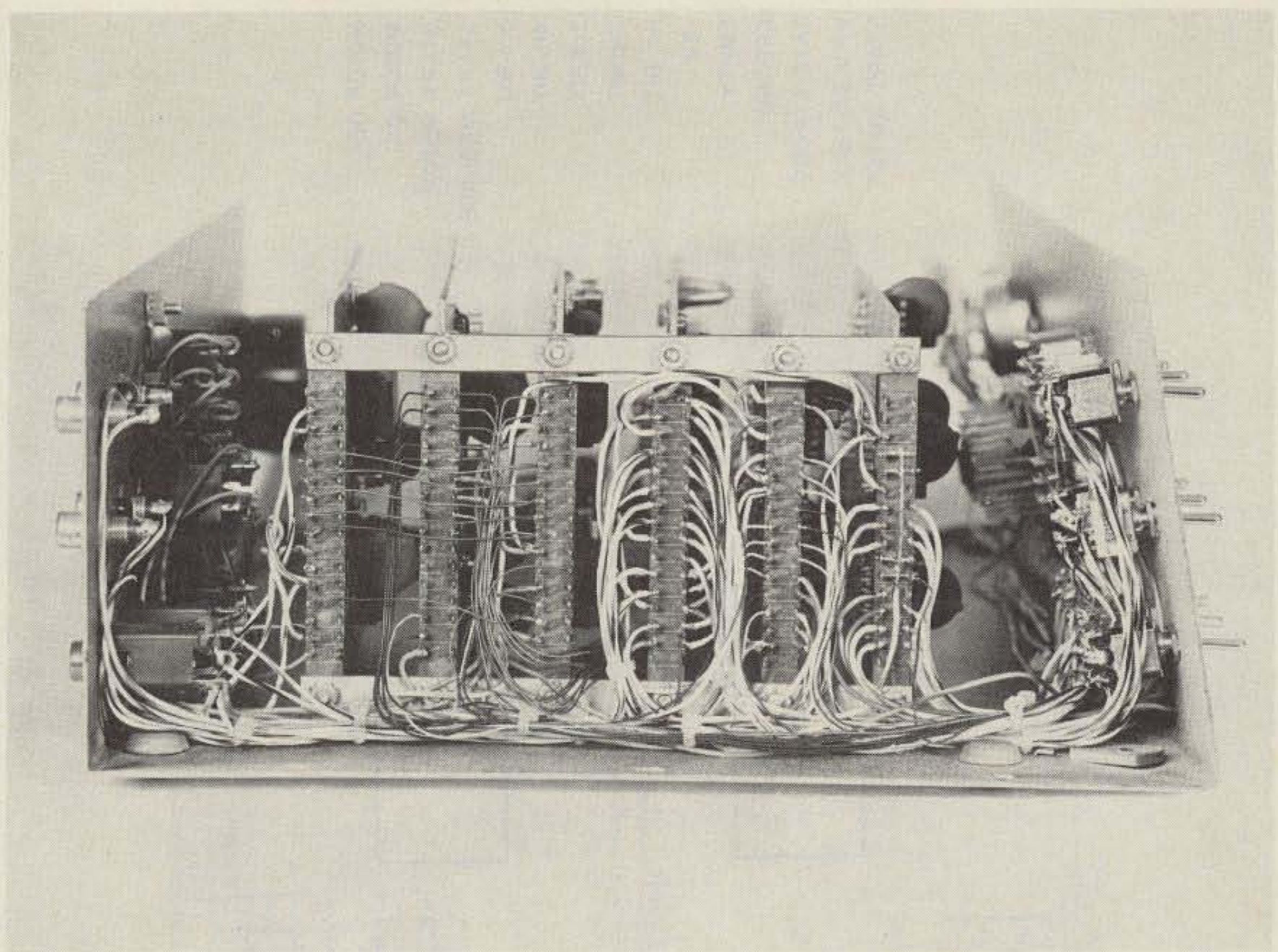

Photo 6. Side view of the IF-2 and UT-4 unit. Using this construction method to mount the edge card connectors is especially nice since it allows easy access to the connectors' pins.

sary. Therefore, relay K3 may be used to simply start the CW ID.

The last interfacing scheme, Case 1, is for those fortunate RTTY enthusiasts

with a UT-4. The actual time constants remain the same as in Cases 2 and 3, the only difference being in the circuit used to turn on the transmitter. Inter-

facing the W-R-U circuit with the UT-4 switch, S3, is shown in Case 1.

Power Supply

Fig. 4 shows a power sup-

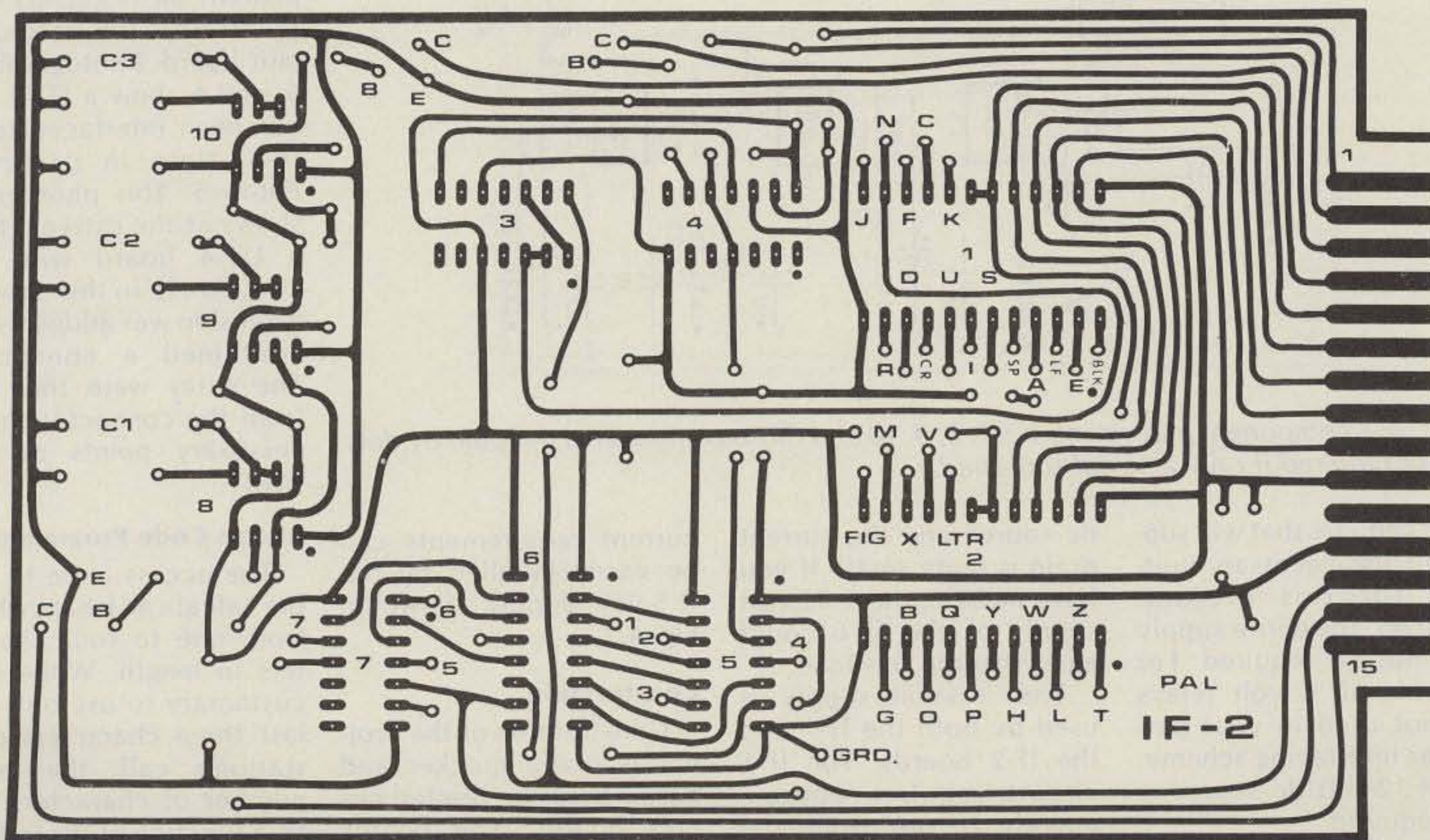

Fig. 7. IF-2 printed circuit board layout (full size).

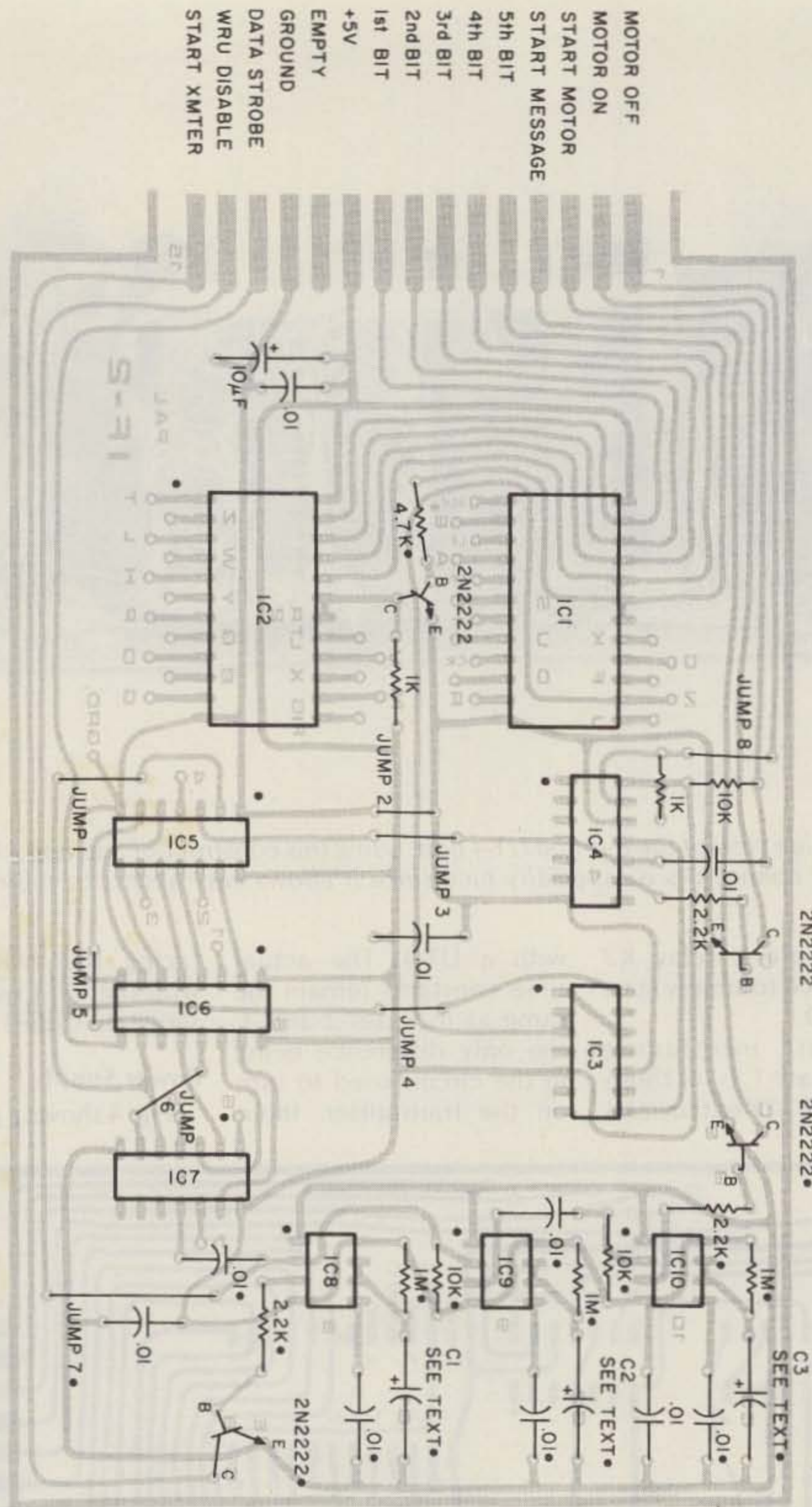

Fig. 8. IF-2 component placement. ICs 7, 8, 9, 10 and those components denoted by dots are not required if only a Selcal is desired.

ply schematic that will supply all the necessary voltages for this project. However, the entire supply may not be required. For example, if 12-volt relays are not used in your particular interfacing scheme, the +12-volt dc source is not required.

The UART is the only IC that requires the -12-volt

dc source and the current drain is quite small. If you have an ST-6, the -12-volt supply of the ST-6 could easily handle this load.

The +5-volt supply is used by both the IF-1 and the IF-2 boards. The IF-1 circuit requires approximately 20 mA while the IF-2 circuit requires approximately 200 mA. Both

current requirements can be easily handled by the +5-volt supply shown in Fig. 4.

Construction

Construction of the project is made quicker and easier by using printed circuit boards. The boards available from the author are professionally fabri-

cated and drilled.

The IF-1 board requires six jumpers. Also note that the 4 transistors on this board will require the leads to be bent to conform to the PC board layout. The IF-2 board requires eight jumpers plus seven programming jumpers. The dot next to each integrated circuit on the board signifies pin 1 of each chip. The IC number is also on the board to help designate the proper location of each chip. The numbers 1 through 7 located near ICs 5, 6, and 7 represent one end of the program jumper wires. The other end of each of these wires is connected to the desired characters of IC1 and IC2.

If the builder wishes only to fabricate a Selcal without the W-R-U circuit, many components may be deleted. Fig. 8 indicates by dots those components that are not required for the W-R-U.

If you have a UT-4 and have used printed circuit boards for the project, you may be wondering how to pick off the necessary data points from the printed circuit board. Photographs 4, 5, and 6 show a UT-4 that has been interfaced to an IF-2. Note in particular Photo 5. This photograph shows at the extreme right a UT-4 board with the UART on it. In this case, an extension was added which contained a connector. The wires were then run from the connector to the necessary points on the UART.

Access Code Programming

The access code to trip the Selcal can be anywhere from one to four characters in length. While it is customary to use only the last three characters of a station's call, the exact number of characters will be a function of the letters. Certainly a station with the call W6AND would not

want to use only the last three characters (AND) since the word AND occurs frequently in English text. In this example, the Letters character would be added as a fourth character before the letter A to prevent premature turn-ons. While any character may be added, the Letters character is a natural since it would normally go after the number 6 and precede the letter A when the call is normally typed. Therefore, in this case, our four-character access code would be: Letters, A, N, and D. These four characters are programmed on the IF-2 board by four jumper wires. The first character, Letters, is programmed by connecting a wire from pin 3 of IC6 to pin 17 of IC2. The IF-2 printed circuit board has the number 1 next to pin 3 of IC6, indicating this is the first character to be programmed. Next to pin 17 of IC2, the abbreviation LTR is shown, indicating this to be the termination point if a Letters character is desired. In a similar manner, the second character A would be programmed by connecting a wire between pin 12 of IC5 (2nd character) and pin 4 of IC1 (A character). This procedure would be followed for the remaining characters N and D.

Now suppose your call is WA2ILP. The letters I, L, and P are not likely to occur consecutively in a normal conversation. Therefore, three characters should be adequate as an access code for the Selcal. Since there is a need for only three of four possible characters, the first character, pin 3 of IC6, is grounded. The characters I, L, and P then become the second, third, and fourth characters of the access code, respectively. The IF-2 printed circuit board has a hole marked GRD for the purpose of grounding

the first character (pin 3 of IC6) should a three-character access code be desired.

For those with a two-letter call, you might find it necessary to use 4 characters for the access code. For example, in my call, W9IF, I use the following four-character access code: 9, Letters, I, and F. Referring to the Baudot code, you will see that the number 9 has the identical code as the letter O. Therefore, the first character (pin 3 of IC6) would be connected to the letter O (pin 9 of IC2). The remainder of the call would be programmed as previously discussed.

The access code to trip the answer-back system consists of a total of seven characters. The first four characters are the Selcal characters. Three additional characters, typically Figures, Blank, and H, make up the remainder of the access code. These three characters represent the 5th, 6th, and 7th characters of our access code. To program Figures as the 5th character, a wire is connected between pin 4 of IC7 and pin 13 of IC2. The 6th and 7th characters are programmed in a similar manner.

Other W-R-U access codes are Figures, Blank, and W, and, more recently, W, R, and U. The IF-2 printed circuit board gives the user complete flexibility in determining the answer-back access code.

In summary, a typical 4-character access code to turn on the teleprinter might be Letters, A, N, and D. The access code to trip the answer-back system for this station might then be the following seven characters: Letters, A, N, D, Figures, Blank, and H.

Conclusion

The Selcal and W-R-U answer-back system has been in operation for over

two years now without any problems. When I recently received my two-letter call, reprogramming the access code required only a few minutes. The Selcal has enabled me to keep in contact with friends, and the W-R-U has given them the confidence to send a note knowing it will be received.

For those not familiar with some of the more popular autostart frequencies, they are as follows: on 80 meters, 3637.500 and 3617.500 kHz; and on 20 meters, 14,082.500 and 14,075.000 kHz.

I would like to thank Cal Sondgeroth W9ZTK for some design ideas, and

Spence Clope W9LDH for fabricating a unit to confirm design validity. ■

References

- Fehlauer, W., "What's a WRU?", *RTTY Journal*, July-August, 1976, p. 4.
 Hoff, I. M., "The Mainline UT-4," *RTTY Journal*, February, March, April, May, 1974.
 Lichtenwalner, B. D., "The Computer QSO Machine," 73, January, 1976, p. 80.
 Magee, J., "ZAP!", *Kilobaud*, February, 1977, p. 18.
 Malanowicz, D., "Who Are You?", *RTTY Journal*, April, 1976, p. 3.
 Sanders, L. W., "RTTY Autocall—the Digital Way," 73, February, 1976, p. 76.
 Sondgeroth, C., "An RTTY Selcal with TTL Logic," 73, November, 1972, p. 20.

Printed Circuit Board Parts List

| IF-1 | |
|---|---|
| Quantity | Description |
| 1 | AY-5-1013 (UART, IC1) |
| 1 | LM555 (timer, IC2) |
| 1 | 1N914 diode |
| 4 | 2N2222 transistor |
| 1 | 1k 1/4 W resistor |
| 1 | 2.2k 1/4 W resistor |
| 1 | 4.7k 1/4 W resistor |
| 3 | 10k 1/4 W resistor |
| 1 | 18k 1/4 W resistor |
| 1 | 68k 1/4 W resistor |
| 1 | 50k potentiometer |
| 1 | .01 uF mylar capacitor (timing) |
| 4 | .01 uF ceramic capacitor |
| 1 | 10 uF tantalum capacitor |
| IF-2 Selcal Only | |
| 2 | 74154 (4-line-to-16-line decoder, IC1, IC2) |
| 1 | 7493 (binary counter, IC3) |
| 1 | 7474 (4-bit bistable latch, IC4) |
| 1 | 7432 (quad OR gate, IC5) |
| 1 | 74174 (hex D-type flip-flops, IC6) |
| 2 | 2N2222 transistor |
| 2 | 1k 1/4 W resistor |
| 1 | 2.2k 1/4 W resistor |
| 1 | 4.7k 1/4 W resistor |
| 1 | 10k 1/4 W resistor |
| 5 | .01 uF ceramic capacitor |
| 1 | 10 uF tantalum capacitor |
| IF-2 with W-R-U | |
| (The following additional components are required for the W-R-U option) | |
| 1 | 7432 (quad OR gate, IC7) |
| 2 | 2N2222 transistor |
| 2 | 2.2k 1/4 W resistor |
| 2 | 10k 1/4 W resistor |
| 3 | 1 meg 1/4 W resistor |
| 5 | .01 uF ceramic capacitor |
| 3 | C1, C2, C3 tantalum capacitor (see text) |

Professionally fabricated and drilled printed circuit boards are available from the author. IF-1: \$12. IF-2: \$15.

INSTANT SOFTWARE™

*IMP™ for **PET**

INSTANT SOFTWARE™
for your **PET**

INSTANT SOFTWARE™
for your **PET**

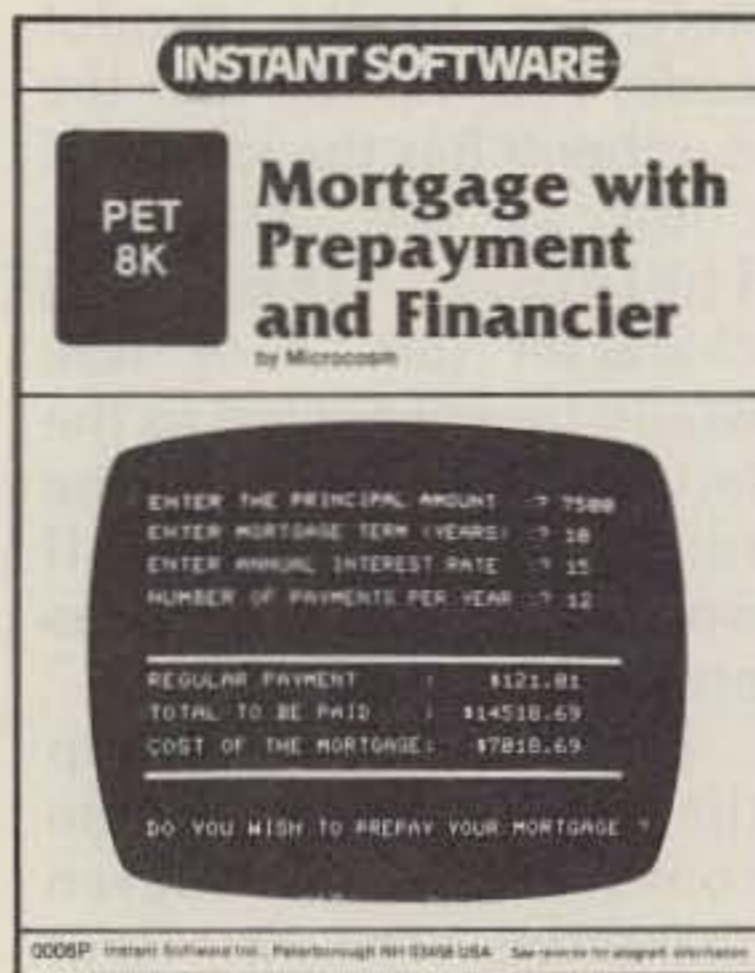
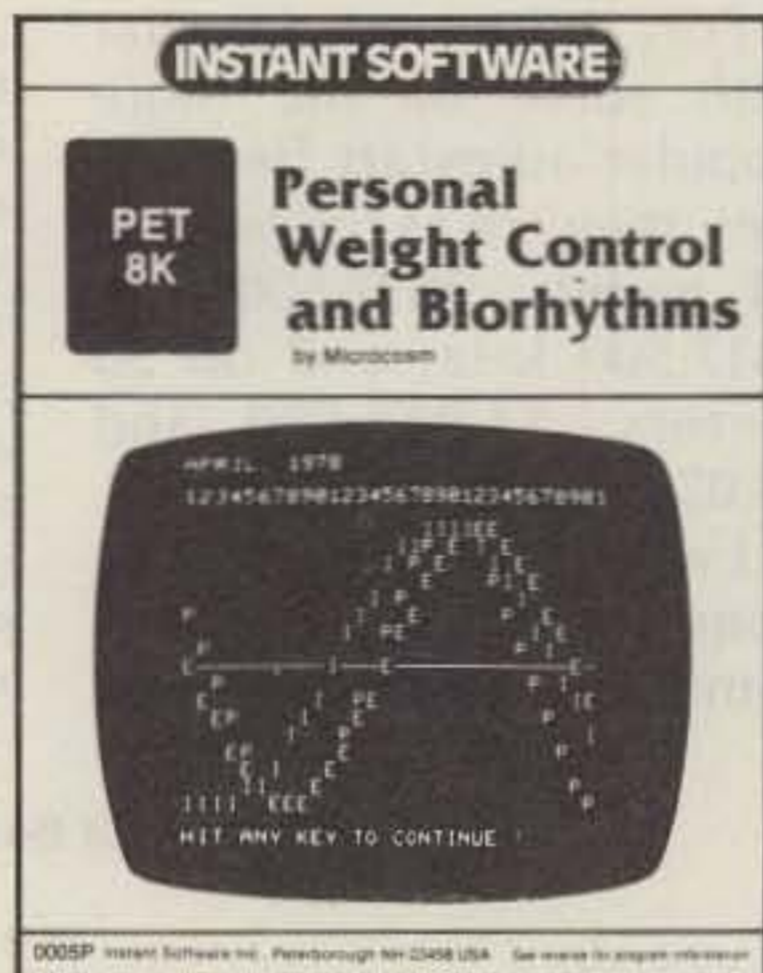

● **PERSONAL WEIGHT CONTROL/BIORHYTHMS**—by Microcosm (for the PET™) Here's a program that will let you chart any individual's biorhythm cycle, showing physical, emotional, and intellectual highs and lows. If your neighbors find out you've got it, they will never leave you in peace. **PERSONAL WEIGHT CONTROL** is a must for the diet-conscious. Once your ideal weight has been determined, the program will calculate the correct daily caloric intake necessary to reach your goal over a certain time period. \$7.95. Order no. 0005P.

\$7.95 ea.

● **MORTGAGE WITH PREPAYMENT OPTION/FINANCIER**—by Microcosm (for the PET™) Before you go to the bank, calculate your mortgage payment schedule and find out what you can afford. You will learn how much prepayments save, and can easily compare the true costs of variations in interest. **FINANCIER** is actually three programs in one and is guaranteed to make you a financial wizard. In part I you'll learn to tell which investments will pay off. Part II calculates annual depreciation schedules, providing rates, amounts, and salvage values, which is great when tax time rolls around. The final section figures costs of borrowing, payment terms, and remaining balances on loans of all sizes. \$7.95. Order no. 0006P.

● **CASINO I** by Charles M. Stuart. There are blackjack games galore, but not many of them are so dependable that you can use them to prepare to make your fortune at Vegas. This blackjack program is not only fun to play, it is also tutorial and allows you to play every combination which you could play at the MGM Grand Hotel in Las Vegas.

There are several systems which will beat the house at blackjack, but before you go investing your cash in a get rich quick attempt, try out your system on this program and see how it does in actual practice.

Roulette programs are more difficult to find, yet this is another very popular casino game—and one you'll want to get some experience with before you venture to go up against the professionals at Vegas. Remember that there are a lot of people who have worked out systems to beat the house at these games and they make a comfortable living going to Vegas every now and then to rebuild their fortunes.

This roulette program is tutorial and gives you the odds on each type of bet.

All you need is the expertise and a little luck to go along with it and you'll pay for your computer in no time. \$7.95. Order no. 0014P.

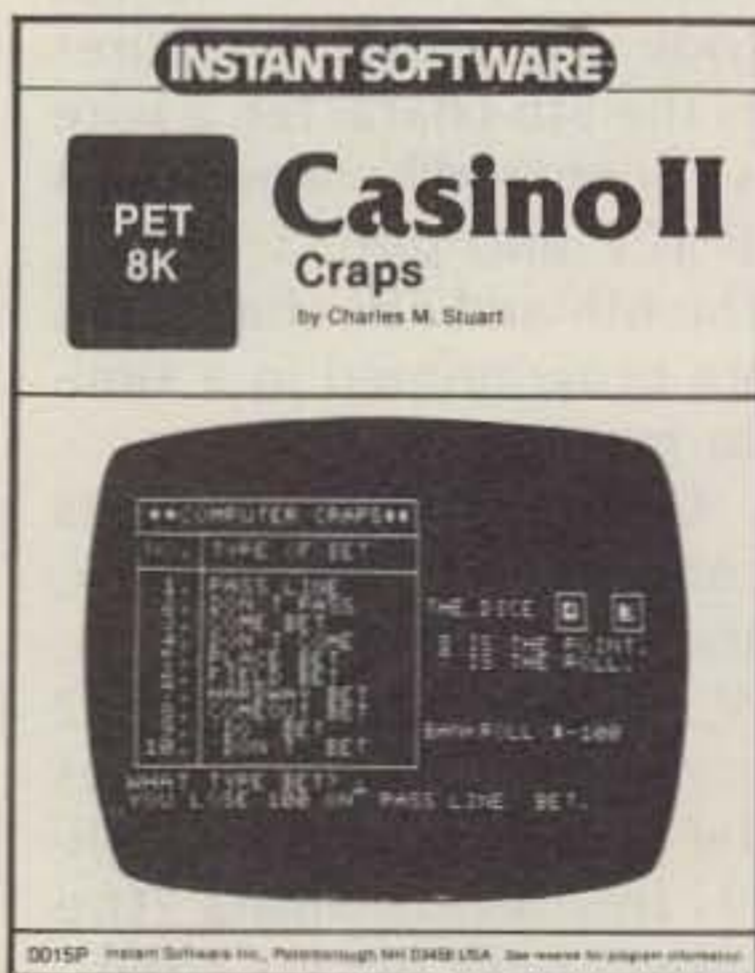

● **CASINO II** by Charles M. Stuart—Yes, there are a lot of craps programs around—so why should you buy this one? The difference is that this one is not just a crap game, it is also a tutorial program which will give you the odds on every type of bet so you can steer clear of the idiot bets that impoverish the unwary. You know that there are bets which give the house as little as 0.1% advantage? It takes precious little luck to overcome such a small edge—but you have to know where to find these bets before you can use them.

If you use this program to get experienced with craps you should be able to walk away from any craps table a winner. Once you know what bets to make and are able thereby to take the best advantage of lucky streaks, betting lightly to wait through the lean times, you have quite an edge.

This program uses the exact rules used at the MGM Grand Hotel in Las Vegas, so you'll be playing under actual gambling house conditions. You should be able not only to pay for the program, but also for your computer system the next time you go to Vegas or Atlantic City. \$7.95. Order no. 0015P.

Send me the following Instant Software:

| Quantity | Catalog | Program name | Unit Cost | Total cost |
|----------|---------|--------------|-----------|------------|
| | | | \$7.95 | |
| | | | 7.95 | |
| | | | 7.95 | |
| | | | 7.95 | |
| | | Shipping | | \$1.00 |
| | | Total order | | |

Check Money Order VISA AMEX

MasterCharge Expiration date _____

Card No. _____

Name _____

Address _____

City _____ State _____ Zip _____

Instant Software Inc. Peterborough, NH 03458
Dept. S11

INSTANT SOFTWARE™

*IMP™ for **TRS-80** ONLY \$7.95 ea.

Level I on one side, Level II on the other



● **SPACE TREK II**—by KB1 (for the TRS-80™) This Space Trek will challenge the most skillful and careful player. As commander of the Enterprise, you must defend the galaxy against enemy Klingon warships using your arsenal of phasers and photon torpedoes to best advantage. The Enterprise is also equipped with impulse power for moving within the quadrant, and warp power for jumping from quadrant to quadrant. \$7.95. Order no. 0002R.

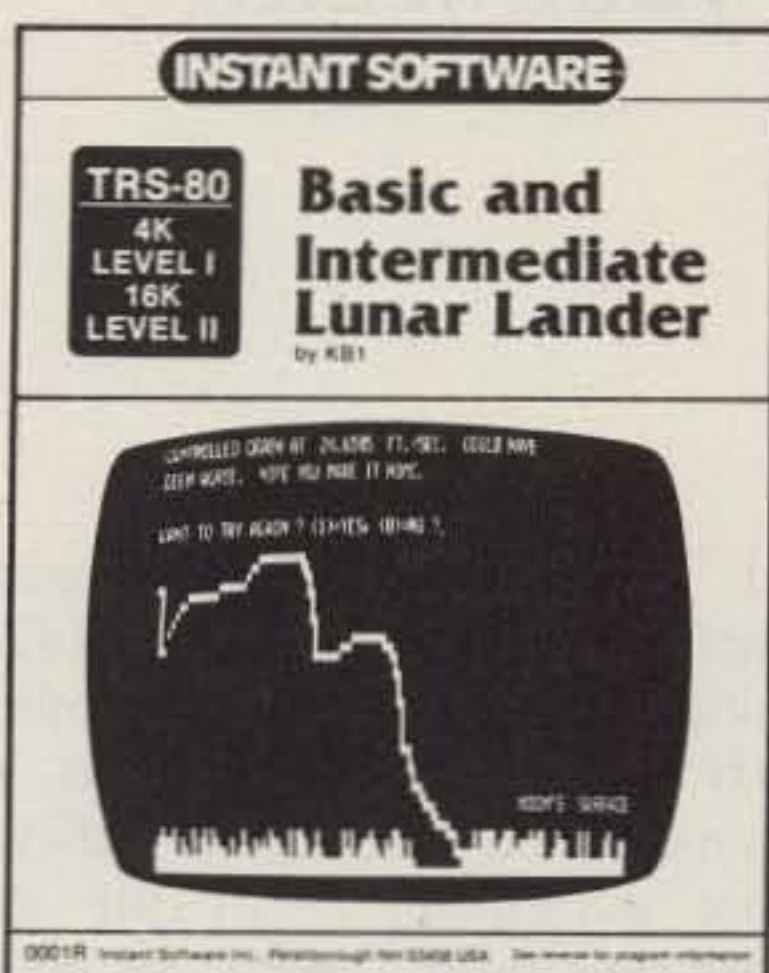

● **BASIC LUNAR LANDER/INTERMEDIATE LUNAR LANDER** by KB1 (for TRS-80™) Your automatic landing system has malfunctioned and you are forced to make a manual landing. Taking control at 15,000 feet, the pilot's success requires precise manipulation of the lunar lander's retro-rockets. After mastering the basic game, the able commander will be taxed by the difficult intermediate program. \$7.95. Order no. 0001R.



● **BEGINNER'S BACKGAMMON/KENO**—by Fred Schild and KB1 (for the TRS-80™) You will never be in need of a backgammon companion again! Schild's program is designed for the newcomer to the game, but the computer's steady play will challenge the careless expert. **KENO** is a popular Las Vegas gambling game. As in many games of chance, the odds are against you, but when you win you can win big. \$7.95. Order no. 0004R.



● **GOLF/CROSS-OUT**—by Wilford Niepraschk and David Dillehay. Playing golf on a computer? You bet and frustrating, too. You have your choice of seven clubs—three irons, three woods, a chip and a putter. The program has 18 different fairways, each diabolically designed. You have to pick the right club and angle for hitting the ball or else you end up in the woods or a trap. The green calls for putting skill. The program has excellent graphics and you'll have a ball... golf ball. **CROSS-OUT** is the old peg puzzle, but in computer form. You have to jump pegs, removing each one jumped. The idea is to end up with but one peg, and that one in the middle hole. The program will rate your skill at the end of each try. \$7.95. Order no. 0009R.



● **ELECTRONICS I** by Rick Morel. With this group of five programs you will be able to design coils for radio circuits, calculate the component values for tuned circuits, design preamplifiers using the LM-381 IC and timer circuits, either monostable or astable using the 555 timer IC. Coils can be designed with the use of tables or special calculators, but they are difficult to use. This package has a coil designing program which is simple to use and the computer does all the work. There is also a program for designing tuned circuits, audio or radio frequency—fixed or variable frequency. The LM-381 program draws the circuit diagram and gives you the component values for your needs. It will calculate any unknown values for you. The two 555 programs do the same, giving you the diagrams for either one-shot timers or astable timing systems (clocks). It will do all the calculations for you, providing times or component values. These programs are not only helpful around any workshop or lab, they also are wonderful for teaching the fundamentals of electronics to newcomers. \$7.95. Order no. 0008R.



● **HAM PACKAGE I** by Rick Morel and D. A. Lien. This group of eight programs (we like to give you plenty) will be of frequent help to any experimenter or ham operator. OHM'S LAW CALCULATIONS, SERIES CAPACITANCES, FREQUENCY VS REACTANCE, PARALLEL CAPACITANCES, SERIES RESISTANCES, DIPOLE DESIGN, PARALLEL RESISTANCES, YAGI DESIGN. These programs draw the circuits or antennas involved and let you fill in the pertinent data, giving you the dimensions, etc. This series of programs is not only an excellent way to learn the fundamentals of electronics and the handling of simple formulas, they will also be of constant use in any workshop or hamshack. \$7.95. Order no. 0007R.

Automatic Autopatch

— safeguard your health

The first thing that becomes apparent to an autopatch user is that dialing an 11-digit phone number while driving at 55 mph on a crowded freeway could be hazardous to your health. Add to that the three-to-six digit access code used by many machines and you start thinking that there has to be a better way. The answer, of course, is an automatic dialer, but the options are infinite and where do we begin?

The system described here was designed to be installed at the repeater site as an addition to the existing autopatch. This location gives several immediate advantages. First, there is space for a large-capacity memory. Second, you have an accurately adjusted tone encoder and are able to provide the signal-to-noise ratio required for high-speed, error-free dialing.

This dialer can store 100 phone numbers equally divided between 7 and 11 digits. The patch can be accessed and each number recalled using only a three-digit number sent from the mobile station. It has a temporary memory that will automatically redial the last number that was previously dialed in the conventional

manner. And it has a ring-back answer function that allows a single digit to access the patch on call-in. The system reverts back to the more secure multidigit access code when the caller hangs up.

The heart of the dialer is the memory. It uses two Intel 1702A erasable, programmable, read only memories (EPROMs) that have a total capacity of 4096 bits of information. The phone numbers are programmed in BCD form using 4 bits per digit. A seven-digit number requires 28 bits plus a 4-bit stop code. So, at 32 bits per number, it is possible to store 128 seven-digit numbers. There is no restriction on the number of digits per number. You could program 0 for operator or any 3-digit phone company service number. If all your numbers were 11 digits, including an area code, your maximum capacity would be 85.

When used on a phone system with modern central office equipment, a seven-digit number can be dialed in less than 0.8 seconds, and that sure beats an operator trying to look up an emergency number that may be out of her local area. Yes, this dialer will wait for a valid dial

tone before starting. A seven-segment LED readout displays the numbers as they are received as well as showing them as they are keyed out.

In the case of a small group of people on a private machine, each member could have his own piece of the memory for storing frequently-called numbers. For a large metropolitan open autopatch, public service numbers, such as police and fire department listings for each area covered, could be provided along with the time and weather reports, etc.

Before we get too involved with the circuit operation, perhaps we should define the inputs required to make the device work. They must be TTL compatible and preferably driven by a low-impedance buffer-type source. The first ten inputs are the individual digit lines from the TT decoder. They are normally high or at a "1" logic level. When a digit is received, that line goes low to a "0". The "main enable" line goes low whenever the control system has the repeater set for normal operation. The dialer is inhibited any time this line is high. The "conventional patch on" line goes low when the autopatch is accessed by the regular

code for manual dialing. This again inhibits the dialer, preventing it from coming on the line should the first three digits of the phone number also be a valid autodial number.

The next input is a negative-going strobe pulse. The pulse width is not critical and may be anywhere from 50 μ s to 1 ms. The strobe is generated each time a valid TT signal is received. It is usually delayed 30 to 50 ms to allow the decoders to settle and is then used to gate the digit lines on in various parts of the system. The "main off" signal is a pulse generated whenever the control system shuts the repeater down. The pulse width is not critical. It will immediately stop and reset the dialer. The "patch off" pulse is generated when the hang-up function is sent. It also stops and resets the dialer logic.

The "auxiliary reset" input is a pulse that is generated when any function command has been completed. It is used to reset counters, timers, and latches that may have been set as a result of an unrelated command. The "*" and "#" inputs are the same as the digit lines and go from high to low when activated.

Now let's see what happens when we send an autodial command to the system. Each telephone number stored in the memory has its own 3-digit address. The first digit selects the EPROM which has the number programmed. In this case, I have used the digit 3 to select EPROM #1 and the digit 4 to select EPROM #2. The next two digits of the command designate the address on that EPROM. There is a maximum of 64 address locations for each memory.

Assume that the number we want can be dialed with the command "435." The 4 appears as a high at gate U4-2C. FFs U4-4A and B are clear and, through U4-3C, present a high to the second

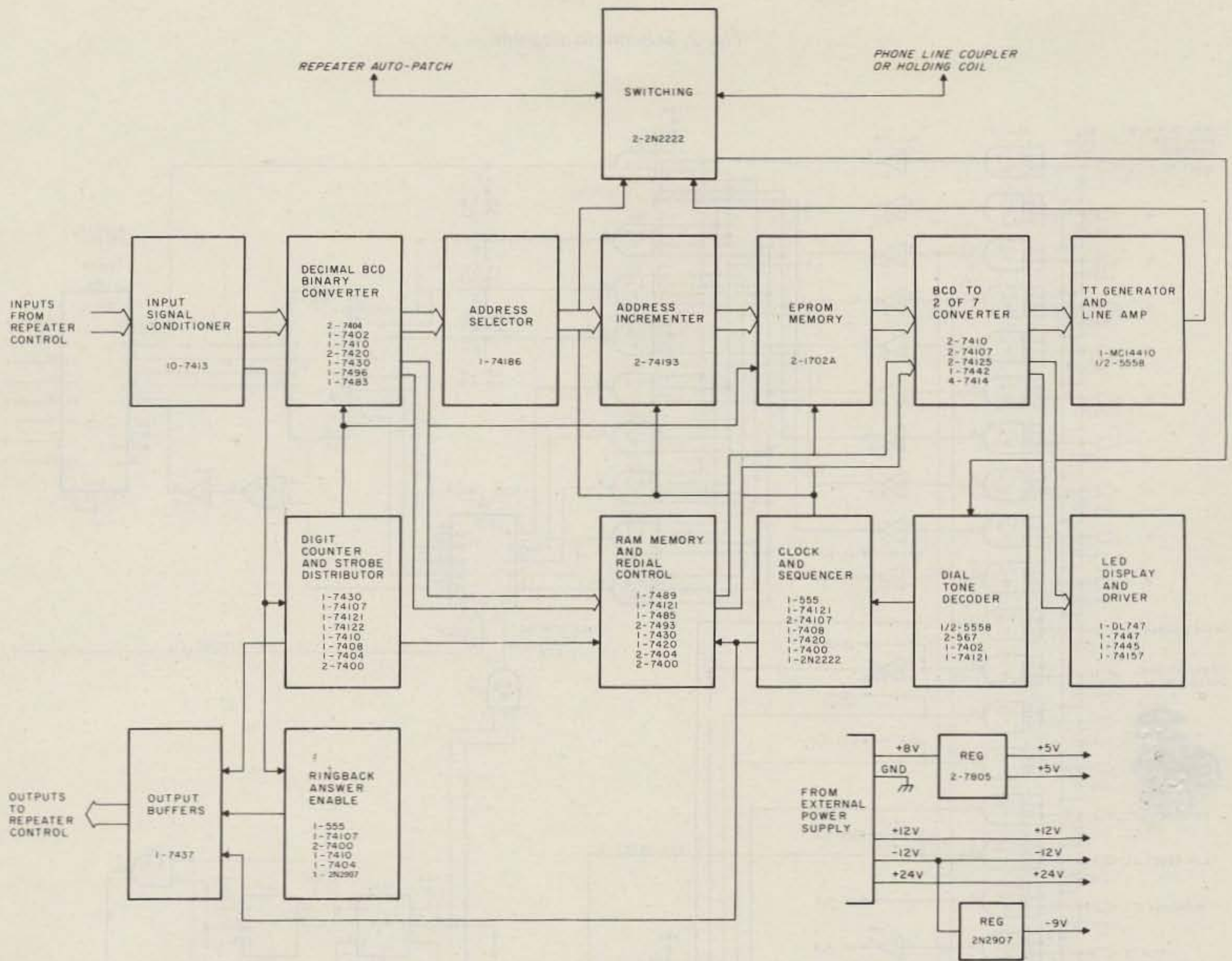

Fig. 1. Block diagram.

input of U4-2C. The strobe pulse accompanying the 4 is allowed to pass through gate U4-1 with all inputs high and is then passed through U4-2C, setting latch U4-5CD. It also increments the digit counter U4-4 one step and preclears the 7496 "tens latch" U2-8. The low from U4-5CD is used to enable EPROM #2, U3-5. The valid first digit (3 or 4) has enabled gate U4-9A, and, when the second digit is sent, it is stored in U2-8 by the second strobe pulse. The 3 is stored in the binary form of 30 and presented to the adder, U2-9. U4-9B is now enabled by the digit counter. When the third digit (5) is received, it is added to the 30 in U2-9 and sent to the address selector, U3-1, as a binary 35.

U3-1 is a 74186 pro-

grammable read only memory (PROM) that has been programmed with up to 64 out of a possible 256 address locations. This address is present at the inputs of U3-2 and U3-3 and is loaded by the third strobe pulse. The address location now stored is applied to the inputs of the EPROMs, U3-4 and U3-5, and designates the location of the first two digits in the phone number to be dialed.

The first toggle of the digit counter, U4-4, starts timer U4-7 (15 sec.). On arrival of the third valid digit, input B to SS U4-8 goes low and inhibits any output when U4-7 times out. However, if the counter is strobed by some nonvalid command or an incomplete dial command, the timer will trigger U4-8 in 15 seconds, generating a pulse

that resets the flip-flops. Any other completed function command will generate an auxiliary reset pulse which immediately clears U4-7 and causes U4-8 to reset the circuits.

The trailing edge of the third strobe pulse toggles FF U5-7A, energizing the coil of K1 through Q1. U5-7A also generates three other commands which are sent to the autopatch control. The first, through U5-1A, prevents the conventional access code from turning on the patch. The second, through U5-1B, temporarily prevents any audio from being sent into the line. The third commands the patch to access the phone line through U5-1C.

The contacts of K1 transfer, connecting the line to the dial-tone detector through T1

and the normally closed contacts of K2. When dial tone is present, C57 is allowed to charge, and, in about 50 ms, the Schmitt trigger input B fires SS U7-6. The leading edge of the output pulse latches U7-5BC, energizing the coil of K2. 50 ms later, after the contacts of K2 have settled, the trailing edge toggles U8-4A, allowing the clock sequence to begin dialing. The phone line is now connected to the tone generator line amplifier.

U8-1 is the master clock and normally runs continuously at 40 Hz. U8-2 produces a clock pulse about 200 μ s wide every 25 ms when it is enabled by a high from U8-4A. This clock pulse synchronizes the dialing operation as shown in the timing sequence chart, Fig. 4. Recall

Fig. 2. Schematic diagram.

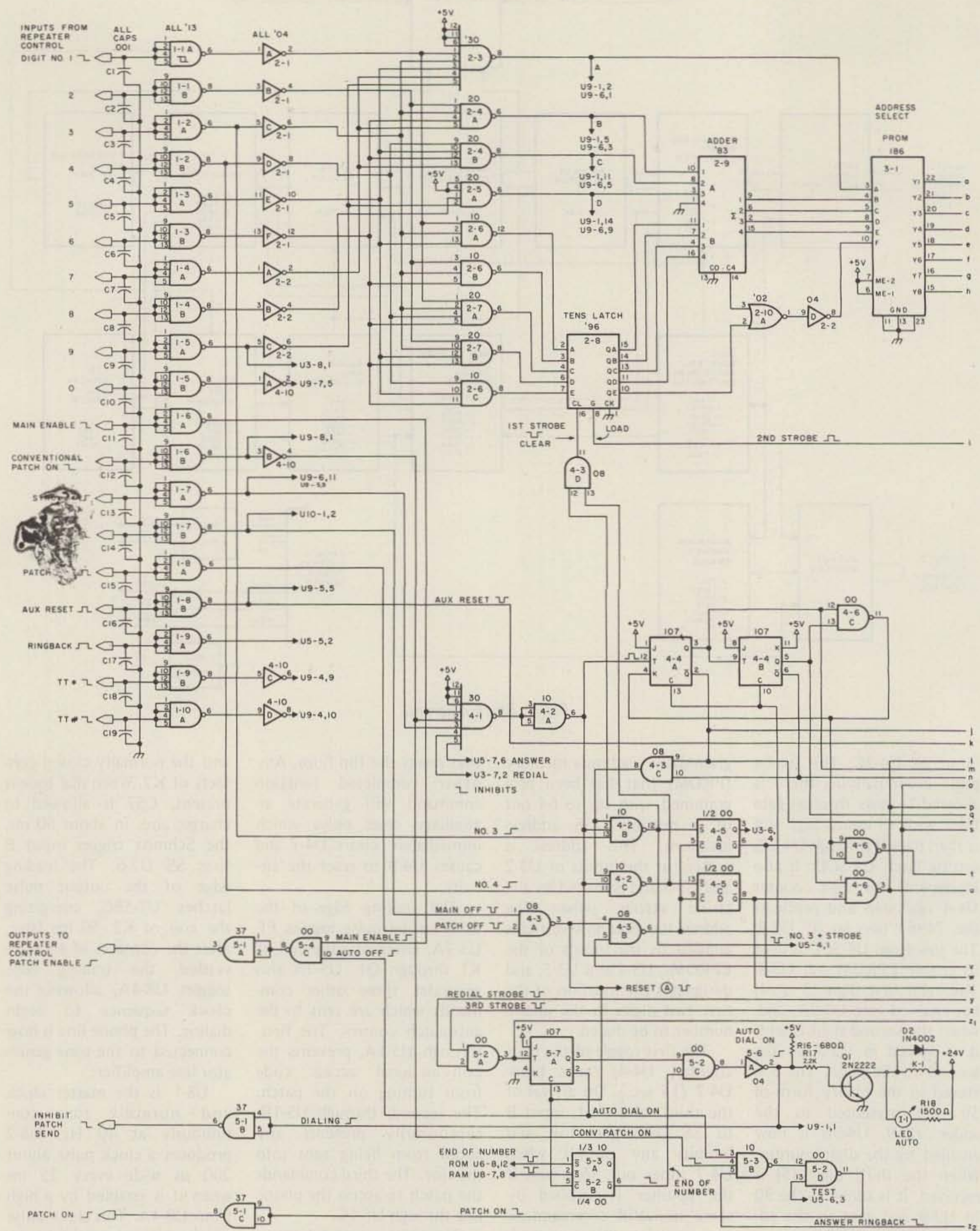

that we had selected an address on EPROM #2, U3-5, with the three-digit autodial number. This initial address supplied the first two digits of our phone number in the form of 8 bits of information or 2 x 4 BCD digits. When

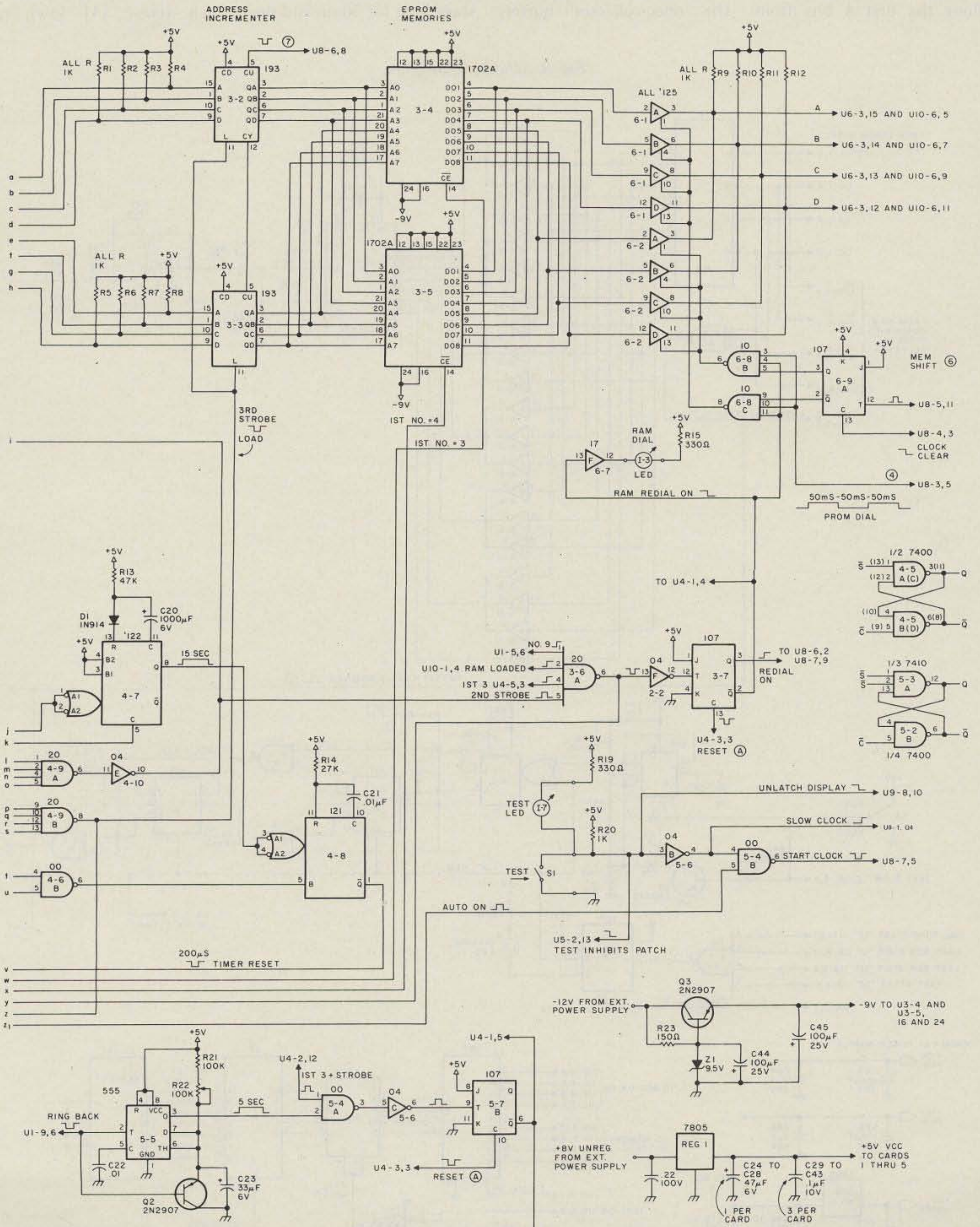

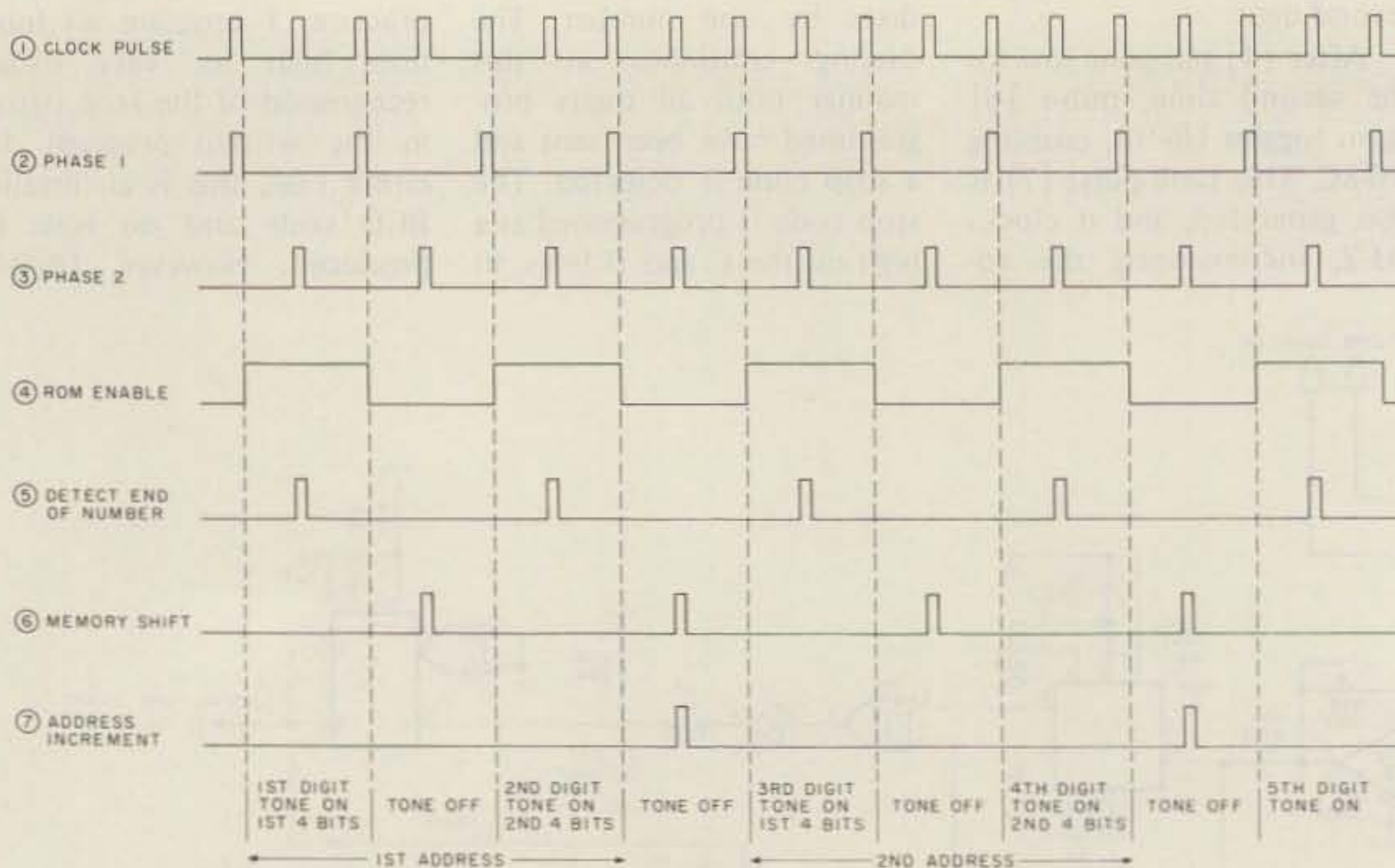

Fig. 4. Automatic dialer timing sequence chart.

sees the C and D lines high, and, when pulse [5] comes along, it is passed to toggle U8-4A. The low output from U8-4A now inhibits U8-2 and clears all the other flip-flops in the clock. The stop pulse from U6-8A is also sent to latch U5-3A, releasing K1. This transfers the phone line back to the autopatch. At the same time, the inhibit is removed from the patch-send circuit at U5-1B. R31 and R32, at K1, allow some side-tone to reach the patch during the dialing sequence.

At the end of the conversation, the hang-up command is sent and reset pulse [A] is generated at gate U4-3A. This pulse clears all flip-flops not already reset. It causes the patch to be disconnected through U5-1C and releases K2 at U7-5D. As noted before, the patch off (hang-up) or main off commands can be sent at any time during the sequence. Either one produces a reset [A] pulse which immediately clears the dialer and releases the phone line.

We will talk about writing the program for the memories later, and, while it may seem difficult at first glance, it is really very simple, albeit repetitious. The mechanics of electrically programming the

74186 PROM have been well documented¹ and can be easily done by yourself. Its program is permanent and does not have to be changed. The 1702A EPROMs can be erased and reprogrammed any time you wish. They contain the actual phone numbers and can be updated from time to time as your requirements change. However, these memories require sophisticated programming techniques and are best done on a special machine. Your local hobby computer store should be able to handle this for you or direct you to someone who can. Some mail-order firms advertise programming for these chips at a reasonable price.

The test switch, S1, allows verification of correct programming without actually calling all the numbers on the phone. The three-digit address code is sent through the control system as if you were going to place a call; however, S1, when in the test position, prevents the autopatch from accessing the phone line. U5-4B is enabled and starts the clock without waiting for dial tone. The clock is slowed to 1/10th speed by Q4, C59, and the display is switched to nonstore operation. As the number is dialed, it is read

out on the display with each digit illuminated in sequence slow enough to follow on a checklist. When the dialer is not running, U9-1 switches the display to read the digits as they are received from the mobile units. The display is blanked and individual LEDs indicate when a "*" or "#" is received.

U10-6 is a 7489 random access memory, or RAM for short. A RAM is sometimes referred to as a scratchpad, and that's what we use it for in the automatic redial circuit. As long as we have a control system, a clock/synchronizer, and a tone generator, it is only natural that we add a temporary memory for recalling those numbers that were originally dialed in the conventional manner. Such a feature could come in very handy if your local pizza parlor is not one of those numbers programmed and always seems to be busy whenever you call.

U10-6 will store up to 15 digits. It is enabled whenever the autopatch is accessed by the regular code for manual dialing. As the mobile is transmitting the tones to the phone company, they are also decoded in the local system and converted to BCD form at gates U2-3, 4, and 5A.

These lines ultimately reach the data inputs of U10-6, and the information on them is stored with each strobe pulse.

While the RAM is loaded with the leading edge of the strobe, the trailing edge of the same pulse clocks counters U10-4 and U10-5. This increments the address to both U10-6 and the 7485 4-bit comparator, U10-7. Each digit increments the counters one step until the dialing is completed and the numbers are stored. The first strobe of the sequence latches U10-1CD, indicating that some number has been stored in the RAM.

The next command will probably be the hang-up or patch-off function from the mobile. This generates a reset [A] pulse which is sent to U10-4, causing the counter to reset to 0, the first address location. The phone line is released by U5-7A, as previously described. Note that counter U10-5 still retains the number-of-digits-dialed information. This phone number can now be redialed by sending only two digits, a 3 and a 9. The 3, as a first digit, is identified by U4-2B and sets latch U4-5AB. The high from U4-5AB is sent to gate U3-6A along with the "RAM-is-loaded" high from U10-1CD. The 9 then arrives at U3-6A from U1-5A accompanied by the second strobe from U4-10E. The strobe is passed through U3-6A to toggle U3-7. It is also sent to U5-2A where it initiates the same sequence described earlier when the 3rd strobe toggles FF U5-7A and accesses the phone line.

The low from U3-7 inhibits any further strobe pulses at U4-1 as well as inhibiting the EPROM dial pulse [4] at U6-8B and C. An LED, I-3, indicates that the RAM is dialing. The high from U3-7 enables the clock gates, U8-6A and B. The open-collector data output lines of the RAM, U10-6, are connected "wired-or" with the outputs of the tri-state

| 74186 PROM | | | 1702A EPROMs | | |
|----------------------------------|--------------------------|---------------------------------|--|--|--|
| Address code (2-digit suffix) | Address inputs FEDCBA | Data outputs (y) 87654321 | Address input lines (both EPROMs) 76543210 | #1 Data out lines (300 code prefix) 87654321 | #2 Data out lines (400 code prefix) 87654321 |
| 00 | 000000 | 00000000 | 00000000 00000001 00000010 00000011 | Tel.# (853-1212) 01011000 00010011 00010010 11110010 | Tel.# (555-1234) 01010101 00010101 00110010 11110100 |
| 01 | 000001 | 00000100 | 00000100 00000101 00000110 00000111 | (244-8101) 01000010 10000100 00000001 11110001 | (547-8311) 01000101 10000111 00010011 11110001 |
| 02 | 000010 | 00001000 | 00001000 00001001 00001010 00001011 00001100 00001101 | (1-800-123-4567) 10000001 00000000 00100001 01000011 01100101 11110111 | (1-213-456-7890) 00100001 00110001 01010100 01110110 10011000 11110000 |
| 03 | 000011 | 00001110 | 00001110 00001111 | (411) 00010100 11110001 | (611) 00010110 11110001 |

Fig. 5(a). Sample program.

buffers, U6-1 and 2, and sent to the inputs of U6-3.

As soon as dial tone is detected, the clock starts, and pulse [4], through U8-6B, reads out the number stored in the first address location. It is encoded at U7-1 and transmitted down the phone line. When pulse [4] goes low, U10-6 is inhibited, and pulse [6] then clocks counter U10-4, through U8-6A, incrementing the address to the location of the second stored digit. Pulse [4] goes high again, sending out the second digit. This sequence continues until the number of digits dialed now equals the number of digits that were dialed originally. We remember that the original-number-of-digits information remained in counter U10-5, which feeds the A inputs of comparator U10-7. The number of digits dialed now, as counted by U10-4, are fed to the B inputs of U10-7. When A = B, a high is produced by U10-7 and sent to U8-7B. With all inputs enabled, the next clock pulse [1] is passed through U8-7B to U8-7A, stopping the clock. It is also sent to U5-3A, transferring the phone line to the autopatch.

The number can be redialed as often as desired. Any of the preprogrammed numbers can be called without disturbing the number in the RAM. The number will be erased whenever the main off function is commanded. The pulse from U1-7B clears U10-5 and sets latch U10-1CD. The same thing happens if the autopatch is again commanded on by the conventional access code, thus clearing the way for the new number to be stored. Each time the conventional patch is functioned on, the low at U10-3 produces a pulse, resetting U10-5 and U10-1CD.

Many systems use an "*" or "#" preceding any command that may be required while a phone call is in progress. This prevents an inadvertent command from being functioned during the dialing should the phone number coincidentally contain a valid function code. The latch U9-5AB implements this logic by inhibiting gate U9-8A whenever an "*" or "#" is received. The strobe is not allowed to enable the memory or counters during an "*" or "#" because U9-7

does not see them as a valid digit, thereby inhibiting U9-8A. When U9-5AB goes low, any subsequent digit will not be stored. Only after the command has been completed will an auxiliary reset pulse be generated in the repeater control clearing latch U9-5AB.

The ring-back answer circuit could be part of the repeater control system, and, if you are still answering your autopatch with a multidigit code, this is for you. How many times have several stations tried to answer the phone simultaneously, locking up the function de-

| Dial | EPROM #1 | Dial | EPROM #2 |
|------|---|------|---|
| 300 | Tel.# 853-1212 — 5 — — 8 — — 1 — — 3 — — 1 — — 2 — stop — 2 — | 400 | Tel.# 555-1234 — 5 — — 5 — — 1 — — 5 — — 3 — — 2 — stop — 4 — |
| 301 | 244-8101 — 4 — — 2 — — 8 — — 4 — — 0 — — 1 — stop — 1 — | 401 | 547-8311 — 4 — — 5 — — 8 — — 7 — — 1 — — 3 — stop — 1 — |
| 302 | 1-800-123-4567 — 8 — — 1 — — 0 — — 0 — — 2 — — 1 — — 4 — — 3 — — 6 — — 5 — stop — 7 — | 402 | 1-213-456-7890 — 2 — — 1 — — 3 — — 1 — — 5 — — 4 — — 7 — — 6 — — 9 — — 8 — stop — 0 — |
| 303 | 411 — 1 — — 4 — stop — 1 — | 403 | 611 — 1 — — 6 — stop — 1 — |

Fig. 5(b). Sample program sequence. Numbers with adjacent addresses should be the same length for maximum use of available space in the memory.

| Decimal | Binary | BCD | Hexadecimal |
|---------|--------|------|-------------|
| 0 | 0000 | 0000 | 0 |
| 1 | 0001 | 0001 | 1 |
| 2 | 0010 | 0010 | 2 |
| 3 | 0011 | 0011 | 3 |
| 4 | 0100 | 0100 | 4 |
| 5 | 0101 | 0101 | 5 |
| 6 | 0110 | 0110 | 6 |
| 7 | 0111 | 0111 | 7 |
| 8 | 1000 | 1000 | 8 |
| 9 | 1001 | 1001 | 9 |
| 10 | 1010 | | A |
| 11 | 1011 | | B |
| 12 | 1100 | | C |
| 13 | 1101 | | D |
| 14 | 1110 | | E |
| 15 | 1111 | | F |

Fig. 6(a). Code forms.

coder? This system allows the single digit 3 to answer the phone, but requires that the complete multidigit code be sent to access the line for manual dialing. We are not too concerned that some unauthorized person may access the system with an autodial code because only the numbers preprogrammed can be called.

When an incoming call is received, the ring signal is detected in the repeater control and sent as a TTL high to U1-9A. The signal lasts from 2 to 4 seconds with an interval between rings of about 4 seconds. The initial ring triggers timer U5-5, which produces a high output for 5 seconds. The second ring comes before U5-5 times out,

causing Q2 to discharge the timing capacitor C23. At the end of the ring, C23 again starts another timing cycle. The output of U5-5 stays high, enabling one input of U5-4A until 5 seconds after the last ring. The first strobe from the digit 3 received while the gate is enabled is passed through from U4-2B, toggling U5-7B. The low output from U5-7B causes U5-1C to access the patch and answer the phone. This low also inhibits U4-1, preventing any more strobes from coming through. When the patch off command is sent, reset [A] pulse clears U5-7B, hanging up the phone.

Construction is straightforward, and no special techniques are required. I divided

| Code suffix | EPROM address | EPROM 1 data | EPROM 2 data |
|-------------|---------------|--------------|--------------|
| 00 | 00 | 58 | 55 |
| | 01 | 13 | 15 |
| | 02 | 12 | 32 |
| | 03 | F2 | F4 |
| 01 | 04 | 42 | 45 |
| | 05 | 84 | 87 |
| | 06 | 01 | 13 |
| | 07 | F1 | F1 |
| 02 | 08 | 81 | 21 |
| | 09 | 00 | 31 |
| | 0A | 21 | 54 |
| | 0B | 43 | 76 |
| | 0C | 65 | 98 |
| | 0D | F7 | F0 |
| 03 | 0E | 14 | 16 |
| | 0F | F1 | F1 |

Fig. 6(b). Hexadecimal conversion of sample program. With a little practice, it is possible to program directly from the phone number to hexadecimal. However, steps in Fig. 5(a) give a better picture of what's happening to your program.

my circuit onto ten plug-in boards as indicated by the U1 to U10 prefixes. However, the logic elements don't care where they are located as long as they are connected properly. My unit was built as a separate rack-mounted cabinet. Many machines have very sophisticated and expandable control systems, and a dialer such as this might conveniently slip into some spare slots in an existing card rack. The input signal conditioners, 7413 Schmitt triggers U1 through U10, could be eliminated if the dialer were made an integral part of the control system using short interconnecting leads. Invert the logic someplace to compensate for the removal of the 7413s.

Troubleshooting and adjusting this system are made somewhat easier by several built-in test functions. The front panel test switch, S1, has been discussed and allows observation of rapid sequences by slowing the clock. S3, which is mounted on the clock circuit board, can stop the sequence at any point for more detailed inspection. S4, on the dial-tone detector, will simulate a dial-tone start while testing on the bench.

The dialing speed is set by R45 at the master clock. A clock frequency of 40 Hz at U8-1 generates a 50 ms tone burst with an interval of 50 ms. Most modern central offices will handle this speed. Some older phone systems may not operate this fast, so you would have to experiment with the speed. R36 and R37 set the frequency of the dial-tone decoders. Note that not all systems use 350 and 440 Hz tones. Check that out and set the decoders accordingly. R35 sets the dial-tone level at the decoder inputs. It should be between 100 and 200 mV. R28 sets the output level of the tone generator. Adjust it to produce a -1 dBm level as measured across the phone line.

So much for the hardware.

Now let's look at the software or programming. The first step is to assemble the list of phone numbers and determine how many bits will be required to store them. We know that there are 2048 bits available on each 1702A EPROM, and we know that each number is going to require 4 bits per digit plus a 4-bit stop code. When the number of bits required is equal to or slightly less than the number available, we can proceed.

The program for the EPROMs is written first. Indicate the logic levels, in the form of a 1 or 0, for each of the eight data output lines at each of the 256 address locations. Refer to Fig. 5(a). Note that, in the "EPROM address input lines" column, the address is in 8-bit binary form, with the least significant bit at the right. The next column to the right is the 8-bit data output of EPROM #1. The first two digits of the first phone number are programmed here in binary-coded decimal form. The first digit uses the four right-hand places with the least significant bit on the right. The third and fourth digits are programmed in the same manner in the next address location, and so on until all the digits have been programmed. The stop code is four 1s added after the last digit. In the next column to the right, we have the data output lines for EPROM #2. The address for each location is the same as that for EPROM #1. Fig. 5(b) shows the sequence of the digits in the program.

As I said before, there is no restriction on the number of digits that can be programmed as one phone number. Because there are two memories using the same address system, each number must begin at the same address location on each EPROM. In other words, if a number starts at the 44th address on EPROM #1, there must be a number in EPROM

#2 starting at the same address. Therefore, to make the maximum use of the available space, each adjacent number sharing the same beginning address should have the same number of digits. To simplify any future reprogramming, group all equal-length numbers together.

Now let's move left on Fig. 5(a) to the 74186 PROM. Note that we only have to program the outputs for the start address for each

number. Once that address has been loaded in the 74193 counters, U3-2 and U3-3, the address to the EPROMs is incremented by the clock. There will be a maximum of 64 addresses to program on this chip, depending on the length of the phone numbers. This program should never have to be changed.

There is just one more thing to do before you send the EPROMs out for programming. The firm doing the

programming will probably require that your information be in either octal or hexadecimal form. I would recommend using hexadecimal if you have an option, as an 8-bit binary number can be reduced to just two places. See Fig. 6(a).²

In conclusion, let me point out something that may have been obvious since you first looked at the diagrams. If you think you might require

additional memory, all you have to do is add some more 1702As in parallel with the existing chips, pin for pin, and provide the first digit gates to enable them. You could get as much as 5 times the capacity — but then think of all that programming! ■

References

1. William J. Hosking W7JSW, "K2OAW Synthesizer Promoted," 73, Nov./Dec., 1975, p. 138.
2. Rony Larson, *Bugbook I*, pages 5-9.

New Products

from page 242

presses the pins to proper .600-inch spacing and locks the IC into the tool. Then the tool is placed on the socket and the plunger depressed for instant and accurate insertion. The MOS-40 features heavy chrome plating throughout, for reliable static dissipation, and includes a terminal lug for the attachment of a ground strap. This IC insertion tool is available from your local electronics distributor or directly from *OK Machine and Tool Corporation*, 3455 Conner Street, Bronx NY 10475.

WIRE-WRAPPING WIRE

Fine industrial-quality AWG #30 wire-wrapping wire is now available on compact, convenient 50' rolls. Perfect for small production applications, prototype jobs, or amateur electronics projects, the wire is silver-plated OFHC copper with Kynar insulation. This insulation combines excellent electrical and mechanical characteristics with easy stripability, is available in 4 colors (red, white, blue, and yellow), and is packaged on 1-5/8"-diameter spools for easy handling and storage. This wire is available from your local electronics

store or directly from *OK Machine and Tool Corporation*, 3455 Conner Street, Bronx NY 10475.

THE UDM THRUSTOR

If you know the value of a thrust bearing in taking the weight off your rotator, and if you use a TV tower antenna support, then you'll love the UDM THRUSTOR™. It's built by an amateur for those who can't afford expensive towers and rotators but nonetheless desire a top-notch antenna installation.

Utilizing a high-quality, precision-ground, hardened-steel, ball-type thrust bearing, the UDM THRUSTOR will easily support the largest of arrays. Installation is simplicity itself. Merely slip the whole unit over the top of any standard TV tower top section. Install the mast pipe (up to 1 3/4" o.d.), lift the weight off your rotor, and tighten the four 5/16" cadmium-plated bolts. A bead of caulking between the collar and the mast pipe will seal out the weather. Constructed of 100% steel parts, it is truly made to last a lifetime. Now there is no excuse to make that rotor support the weight. *UDM Enterprises*, PO Box 2037, Sandusky OH 44870.

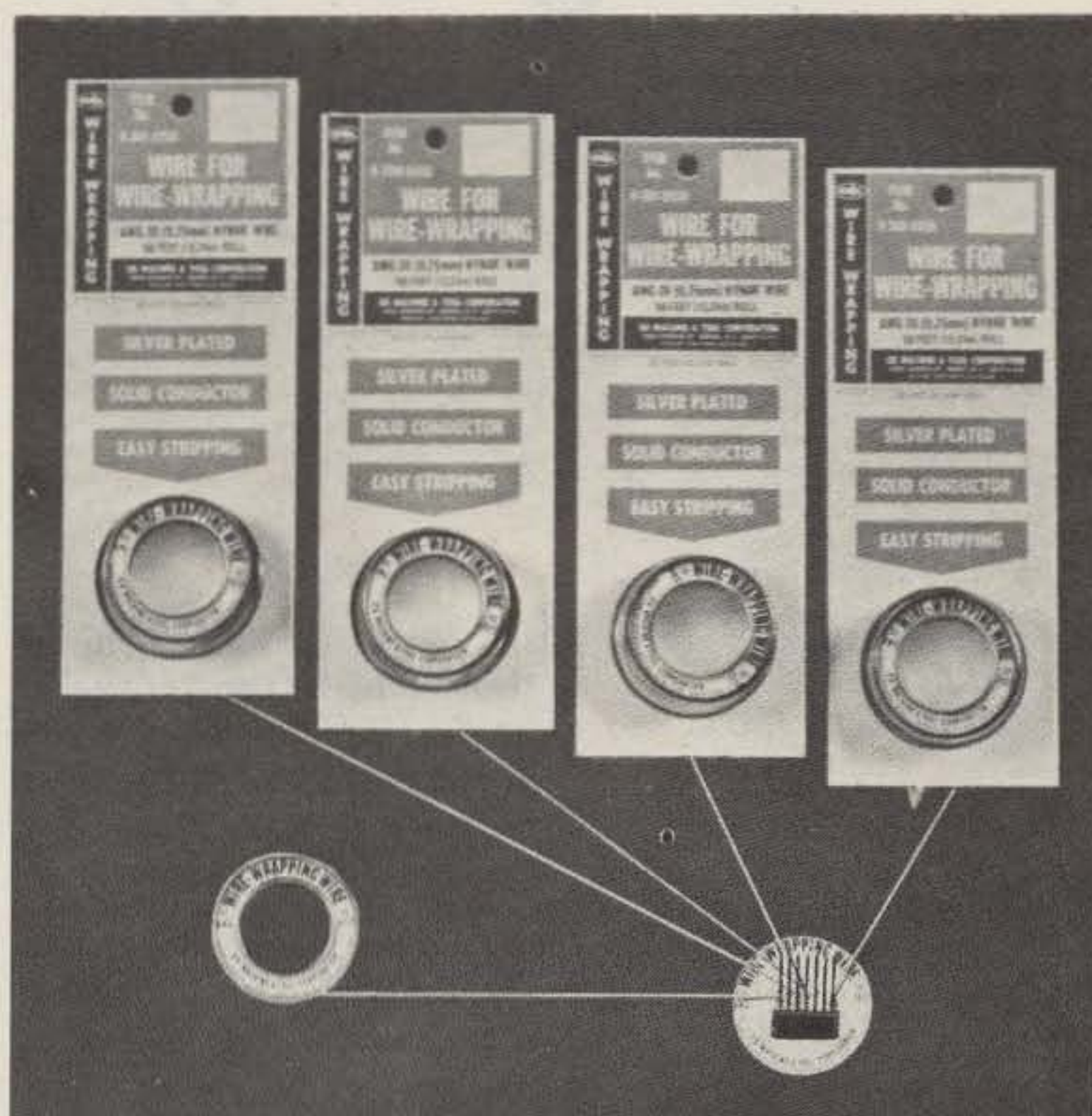

Wire-wrapping wire from OK Machine and Tool.

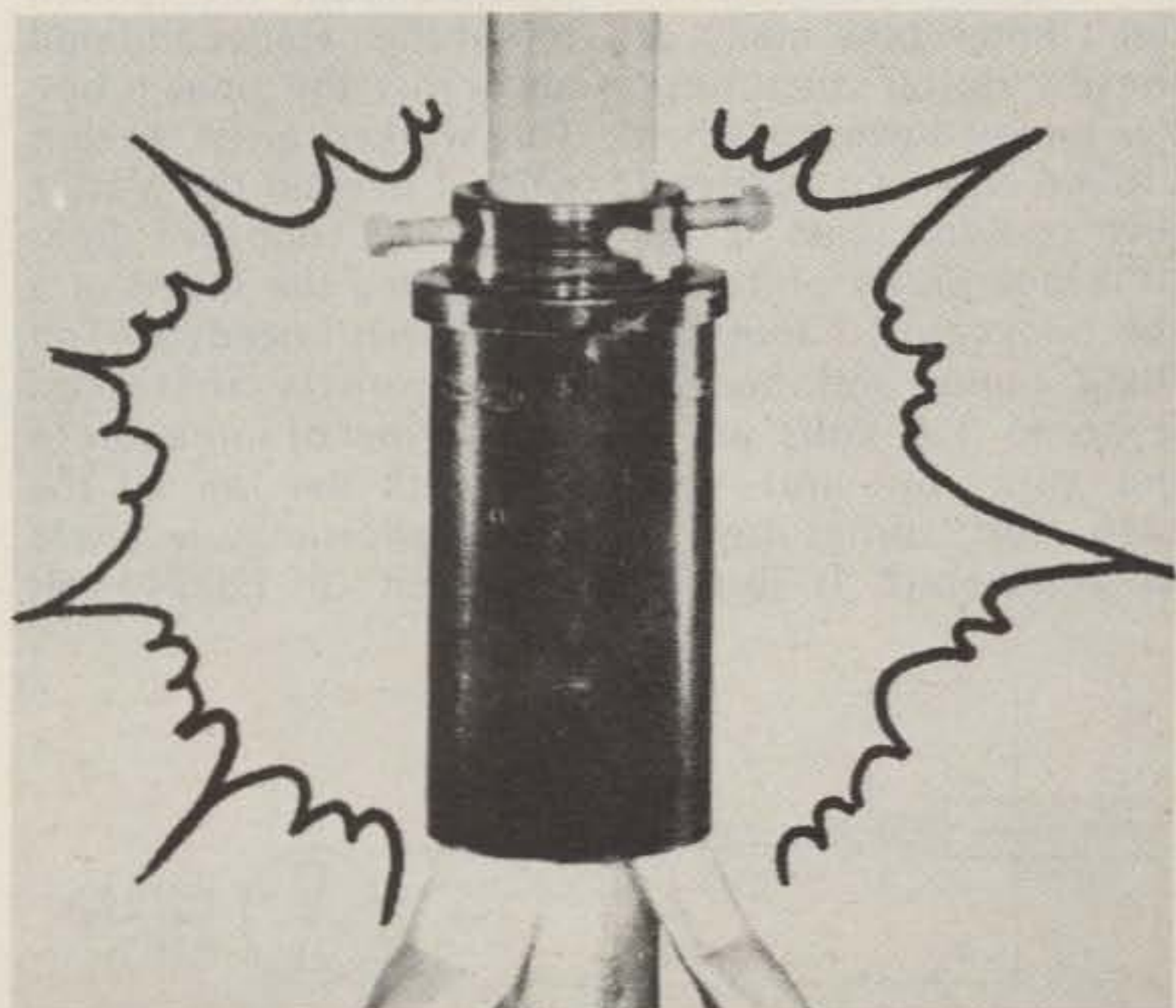

The UDM THRUSTOR.

Corrections

Please note a correction to my article "Low-Pass Filter Primer," which appeared in your October issue. On page 99, line 33, column 1, should more properly read: " $\zeta = 1/(2Q)$ gives the damp-".

Peter Stark K2OAW
Mt. Kisco NY

Yes, we know that the duotone on page 221 of our October issue is upside down. We will pass the buck along simply by saying that the mistake was not made by a member of the 73 staff.

John C. Burnett
Managing Editor

Sunspot Cycle Madness

WE'RE CELEBRATING - WITH SUPER DEALS FOR YOU!

THOMAS COMMUNICATIONS



YAESU
FT-7



YAESU
FT-901

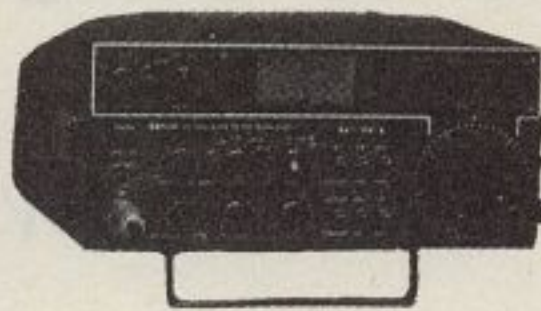

ICOM
IC-701

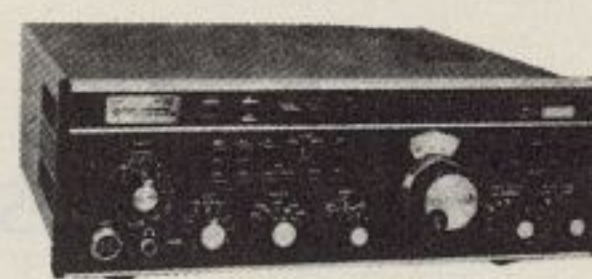

DRAKE
TR-7



KENWOOD
TS-820S



YAESU
FT-227R



TEN TEC
544



PANASONIC RECEIVER
RF 4800

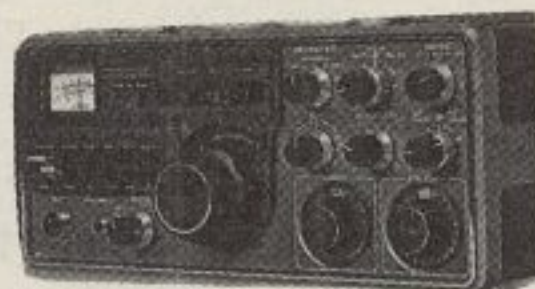

KENWOOD
TS-700SP

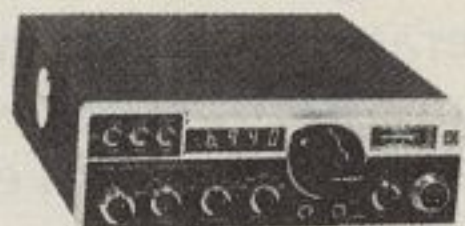

KDK
2015R



DENTRON
MLA-2500B



WILSON
MARK IV

"OVER 50 BRANDS IN STOCK"

- KENWOOD • YAESU • KDK • DENTRON • WILSON • MFJ • SWAN • DRAKE • LARSEN •
- TEMPO • KLM • BEARCAT • B & W • ARRL PUBLICATIONS • MOSLEY • REGENCY • ASTATIC •
- CUSHCRAFT • MICROLOG • HAM KEY • CDE • PIPO • ICOM • TEN TEC • PANASONIC •
- DAYBURN INSULATORS • BIRD • AMECO • HUSTLER • CALL BOOK • SAXTON • ALLIANCE •

★ COMPLETE RADIO SERVICE SHOP ★

— FAST EFFICIENT SERVICE — WE REPAIR ALL BRANDS —

— ALL WORK GUARANTEED — AMATEUR EXTRA / FIRST CLASS LICENSES —

— SEND US YOUR DEFECTIVE EQUIPMENT U.P.S. COLLECT —

— FREE SHIPPING BOTH WAYS IF WORK IS DONE —

— MOST REPAIRS DONE AND SHIPPED WITHIN 7 DAYS —

★ OUR FINE REPUTATION SPEAKS FOR ITSELF ★

"YOU SHIP IT — WE FIX IT"

- ★ NEW AND USED EQUIPMENT — "Get on our used equipment mailing list" —
- ★ TRADES WELCOME — "The best allowances anywhere" — "We buy good used SSB gear" —
- ★ FREE CATALOG — "Prices of all major manufacturers" —
- ★ SAME DAY U.P.S. SHIPPING — "Just a phone call away" —

Telephone Orders
203-667-0811
Call Today!

Call or write for
your super quote today!



THOMAS COMMUNICATIONS - "Near ARRL Headquarters"

95 KITTS LANE, NEWINGTON, CONNECTICUT 06111

OPEN MON.-FRI. 10-6 • THURS. 10-8 P.M. • SAT. 10-4

EASY DIRECTIONS: Rt. 15 South — 2 blocks past McDonald's (Berlin Turnpike)

Using Bargain Muffin Fans

— a keep-cool idea

Robert M. May II K4SE
PO Box 30
Jonesboro TN 37659

Have you ever spotted "bargain-priced" muffin fans at a hamfest, rushed over to snap one up, and put it down just as quickly because it was built to operate on 208-240 volts ac? I don't know how many of these "dollar beauties" I've turned down, but when I found one for a quarter, I just couldn't pass it up. (It'll look pretty on top of the bookcase?) I took the thing home and hooked it up to 120 volts ac. It did turn, but not very fast, and sometimes it wouldn't start. It just so

happens that I have one of those 0 to 140-volt Variacs, and I tried the fan at 140 volts. Not only did it start right up, but it ran at a very respectable speed!

I have one of those Heathkit® "compact kilowatt" amplifiers that gets as hot as a firecracker since it has no forced-air cooling. So, I thought I would mount the fan on top of the cabinet and pull air across the final tubes. This worked great, except when I needed the Variac out in the shop (it's great for varying the speed of a drill). What I needed was a permanently installed transformer of some sort to stay with the fan all the time. Unfortunately, I was fresh out of 120/240-volt

transformers or anything similar. However, I did have a 120/25-volt 500-mA transformer I had bought from McGee Electronics for 79¢. You might wonder how that would be of any help. Well, a Variac is a variable *autotransformer*. Why not hook up the 120/25-volt transformer as an autotransformer and get 120 plus 25, or 145 volts ac? This is done by hooking one side of the secondary winding to one side of the primary and then connecting the load to the other primary and secondary windings (See Fig. 1). Be sure the windings are connected in phase. This is determined by a 145-volt ac voltmeter measurement across wires A and B. If the windings are wired out of phase, the voltmeter will read 120 minus 25, or 95 volts. This autotransformer connection turned out to be the perfect solution for keeping the linear cool during those DX pileups!

Now, those of you with sharp eyes have seen that

the muffin fan specifications show its power rating to be 15 Watts at 208-240 volts (from Fig. 1). And, knowing that $P = E \times I$, you have determined that the little transformer is capable of delivering only 25×0.5 or $12\frac{1}{2}$ Watts in the normal mode. However, remember we are using the secondary winding to *add* voltage on top of the 120 volts ac already available from the line for a total of 145 volts. Since the secondary can deliver 500 mA (or 0.5A), we can pull that much current from the line to a load as well, without overtaxing the transformer. Therefore, the total amount of power that can be delivered by our circuit is 145 volts \times 0.5 Amps or 72.5 Watts.

A word of caution! *Do not* use an autotransformer for high-voltage plate circuits or any kind of circuit which must be isolated from the line. The resultant "hot" chassis could make your wife a widow in a hurry! ■

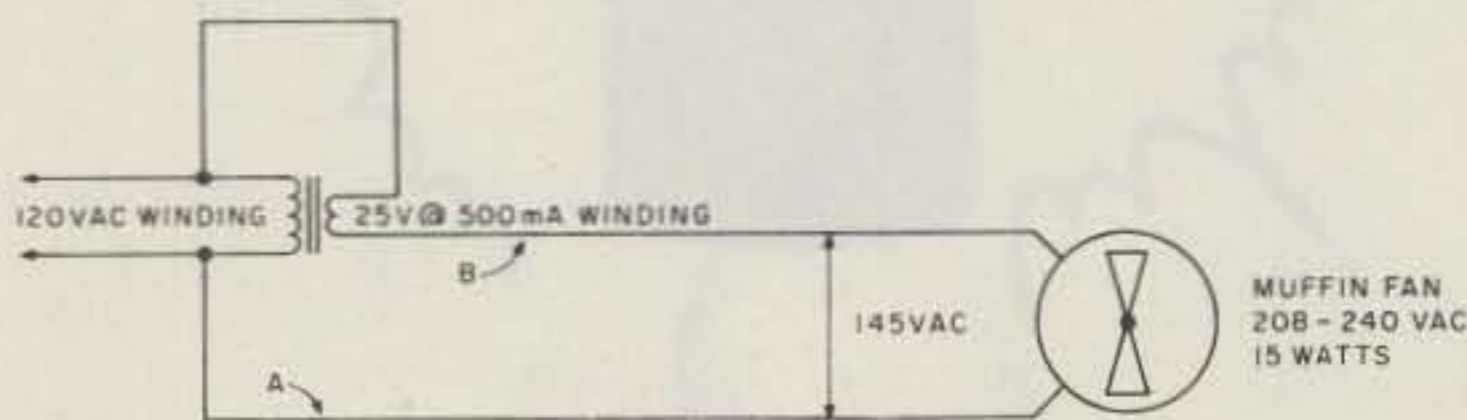

Fig. 1. Muffin fan wiring arrangement.

Loran-C as a Frequency Standard

— is 3 cycles a week good enough?

Do you operate near the band edge? Do you have trouble calling up that favorite two meter repeater? How accurate is your frequency counter? These questions illustrate one of the most pressing needs among amateurs today: accurate frequency-measuring techniques.

While working as an aircraft radio technician, I encountered a peculiar, though perhaps common, problem. The shop housed seven expensive and presumably accurate frequency counters, yet each counter differed from the others by at least one kilohertz over a span of seven kHz in the VHF aircraft band. This situation had to be resolved, so the options were considered:

1. Guess which instrument is most accurate and set the others to match. This approach easily

results in a pink ticket from Uncle Sam.

2. Send the offending instrument(s) to the manufacturer for calibration. This sounds good but it is expensive and time-consuming, and there is a hitch: The instrument will presumably be accurate when it leaves the calibration facility, but will its accuracy be maintained after bouncing across the country or freezing to thirty below in the cargo hold of an airliner?

3. The signals from WWV or CHU can be used for calibration. This method is fraught with difficulties. The signals are only available at certain times of the day. They are subject to atmospheric fading and distortion, and it is very difficult to compare an oscillator frequency to these signals with any degree of accuracy.

None of these techniques seemed acceptable, so a search was made through the technical literature, revealing that many stations operate in the VLF band with extreme frequency accuracy. After constructing receivers for several of the VLF stations and discovering the nature of their modulation, the loran-C signal from Carolina Beach NC was selected as a frequency standard. The loran-C station transmits pulse bursts with a carrier frequency of 100 kHz plus or minus three cycles per week. This precision is equivalent to measuring the distance around the world to the nearest tenth of an inch!

The loran-C stations at different locations transmit trains of nine pulses about one millisecond apart repeated about twenty times per second (Photo 1). The Carolina Beach station transmits three-hundred-kilowatt pulses with a ground wave coverage of about one thousand miles.

There are several ways to use the loran-C signals for frequency calibration. The simplest is the scope drift method. The frequency being measured must be related to 100 kHz; for example, a ten-MHz signal from a generator or the

timebase of a frequency counter can be divided down to 100 kHz with two 7490 chips. The 100-kHz signal derived in this manner is fed to a scope trigger input while the loran-C signal is fed to the vertical input. When the scope is synchronized to the counted oscillator, the cycles of the loran signal will be seen to "crawl" across the screen if there is any oscillator frequency error. The oscillator may then be adjusted to make the loran signal appear stationary on the screen. This method may be used to set a 100-kHz crystal calibrator, but care must be taken not to pull the calibrator frequency with the scope probe capacitance. It is important to verify that the loran-C signal is actually being received; this is done by reducing the scope sweep speed to 10 or 20 Hz and observing the loran pulse train (Photo 1). Even at the high (2-5 us/div.) sweep rate used with the drift technique, the loran-C signal will have a noticeable 20-Hz flicker while 60-Hz and other interference will appear as continuous or random oscillations.

The receiver described here only suggests one of the many possibilities. A

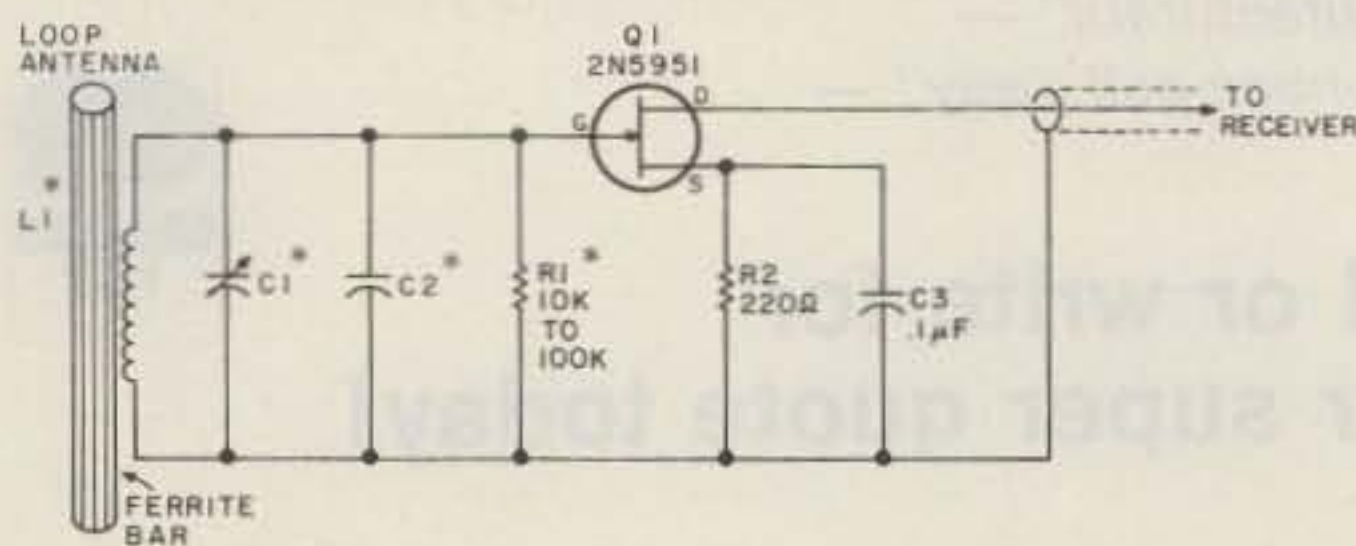

Fig. 1. The antenna assembly contains the rf amplifier, which receives its power on the same coax that carries signal to the receiver. C1 and C2 are selected to tune the loop to 100 kHz.

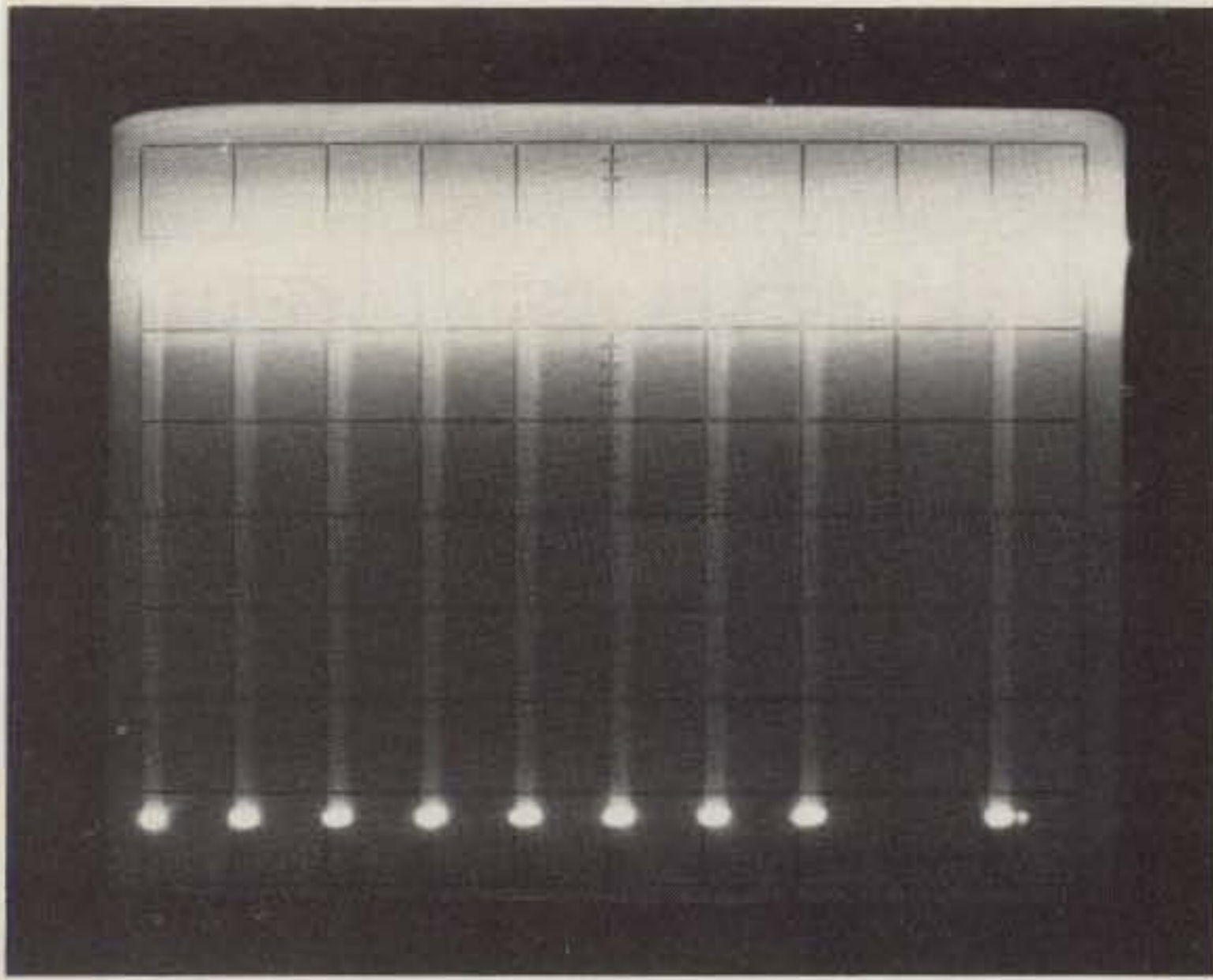

Photo 1. Scope trace of loran-C pulse train. Notice the gap at the ninth pulse position. 1 ms/division.

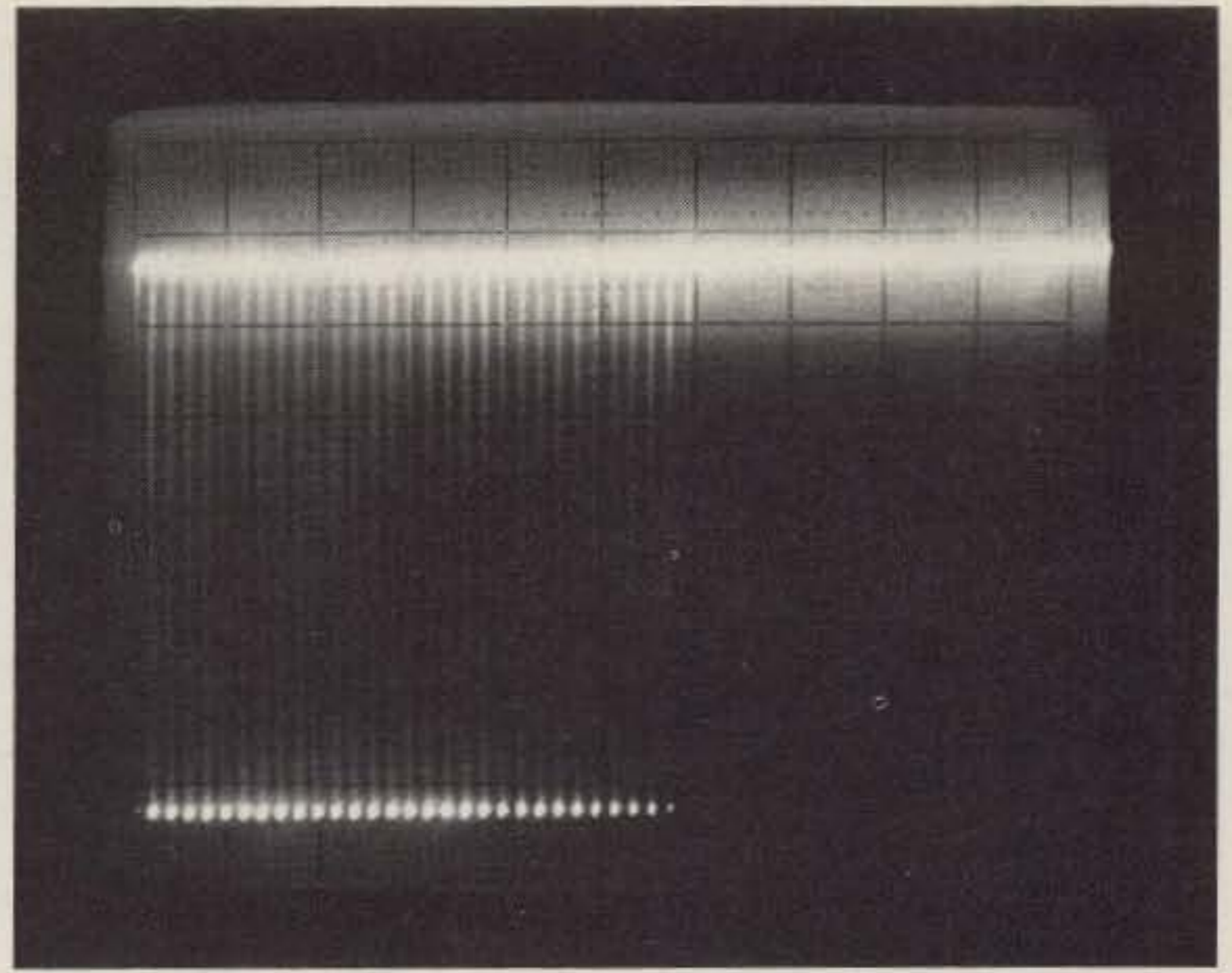

Photo 2. Scope trace of individual 100 kHz pulse burst (50 us/division).

TRF design is necessary to maintain the frequency and phase accuracy of the loran-C signal. The agc is essential if the threshold video amplifier is used. The

major pitfall of TRF receiver design is oscillation, hence the importance of verifying the received signal. With the receiver shown in Fig. 2, oppor-

tunities for oscillation are minimized by placing the rf amplifier (Fig 1) at the antenna. The antenna may be an open loop, ferrite bar, or longwire. Good

results have been obtained by winding about 150 turns of enamel wire on the back-to-back halves of a TV flyback transformer core. The antenna coil (L1) is

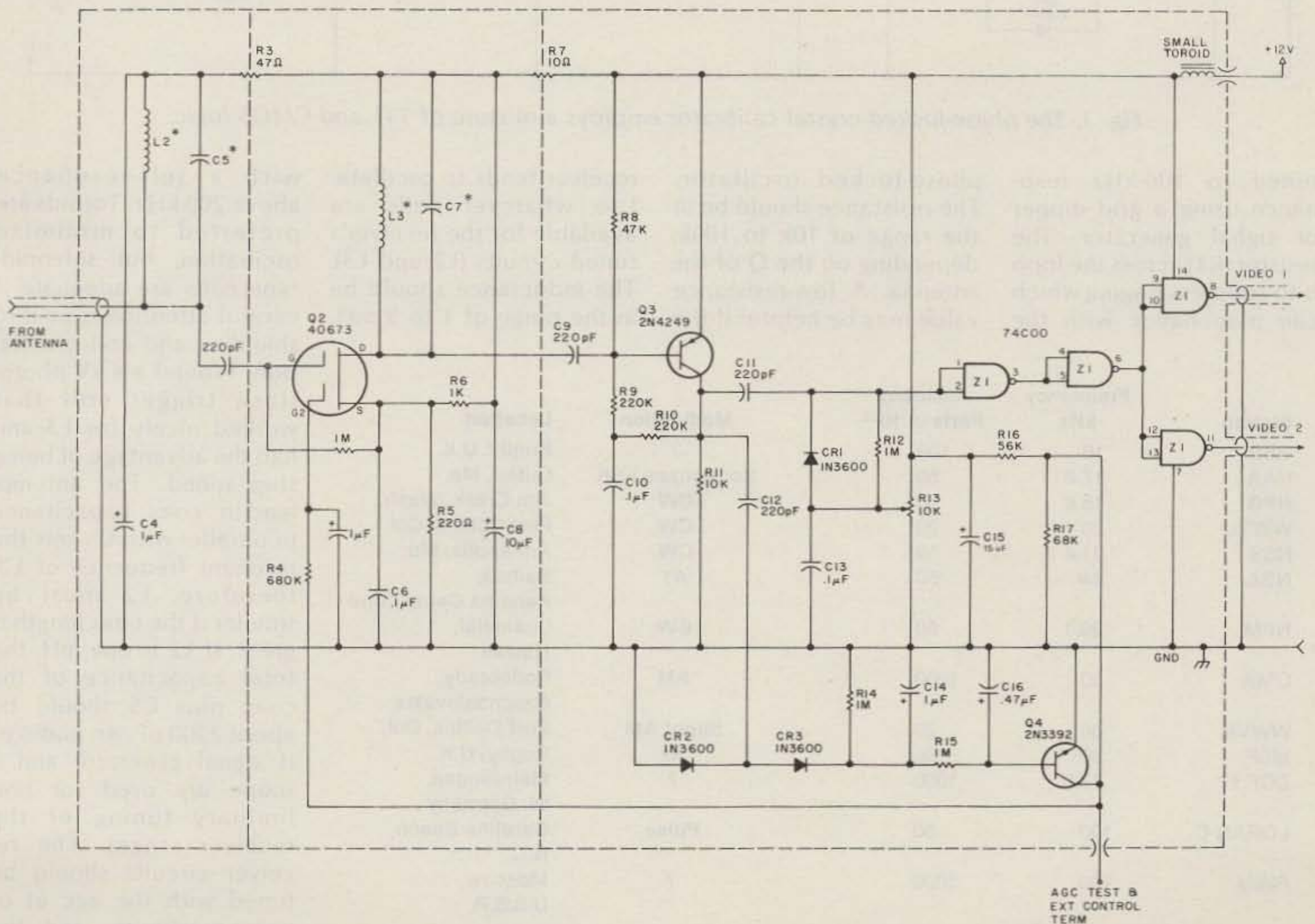

Fig. 2. Schematic of the VLF receiver. The dashed lines indicate an adequate shielding arrangement. C5 and C7 are selected to tune the receiver to 100 kHz.

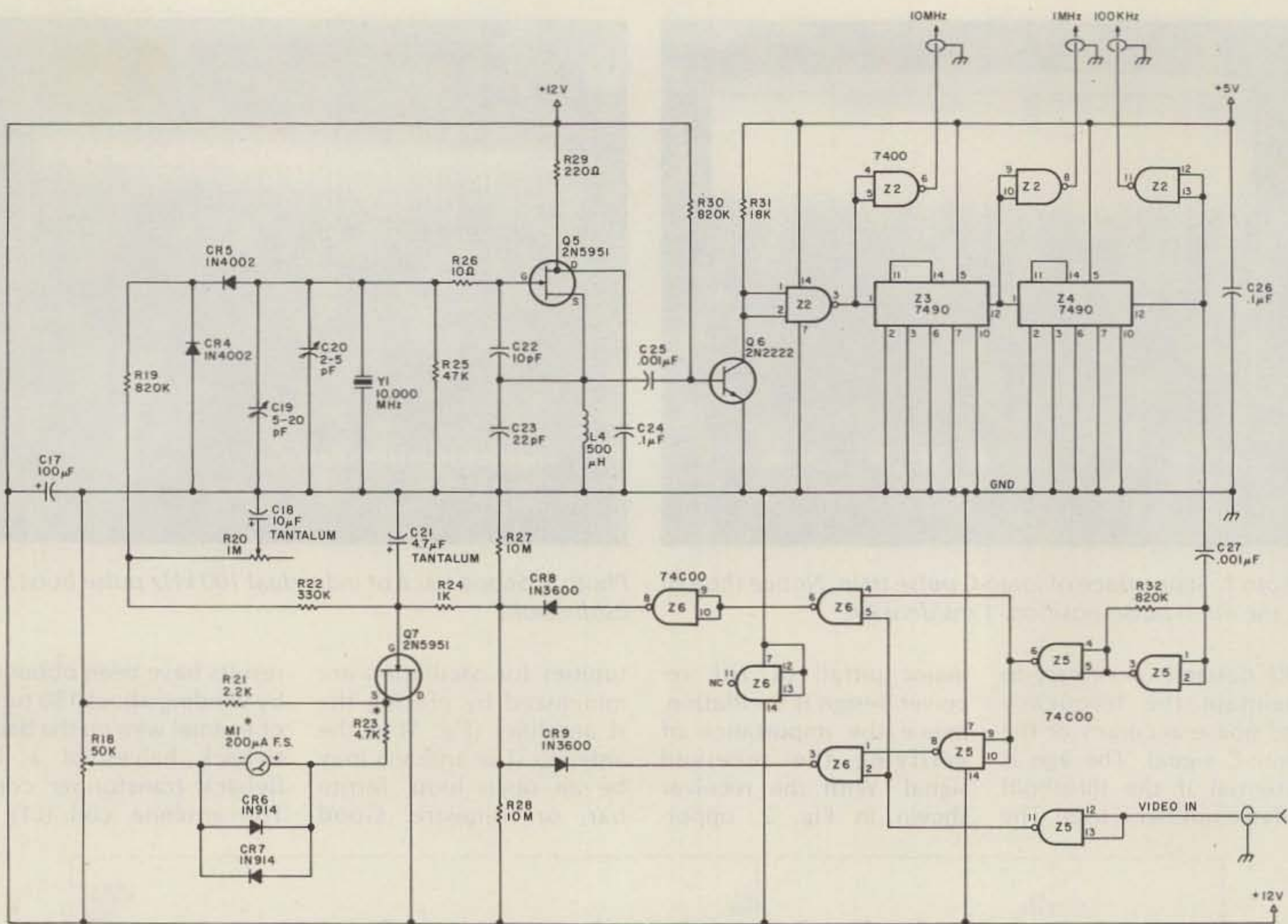

Fig. 3. The phase-locked crystal calibrator employs a mixture of TTL and CMOS logic.

tuned to 100-kHz resonance using a grid dipper or signal generator. The resistor (R1) across the loop is to suppress ringing which can play havoc with the

phase-locked oscillator. The resistance should be in the range of 10k to 100k, depending on the Q of the antenna. A low-resistance value may be helpful if the

receiver tends to oscillate. Use whatever coils are available for the receiver's tuned circuits (L2 and L3). The inductance should be in the range of 1 to 5 mH,

with a self-resonance above 200 kHz. Toroids are preferred to minimize oscillation, but solenoid-type coils are adequate if careful attention is paid to shielding and coil orientation. I found a 4 kV photo-flash trigger coil that worked nicely for L3 and had the advantage of being slug tuned. The antenna lead-in coax capacitance in parallel with C5 sets the resonant frequency of L2; therefore, L2 must be smaller if the coax length is great. If L2 is one mH, the total capacitance of the coax plus C5 should be about 2200 pF. An audio or rf signal generator and a scope are used for preliminary tuning of the receiver stages. The receiver circuits should be tuned with the agc at or near maximum, and the coils not being tuned should be swamped with a

| Station | Frequency kHz | Accuracy Parts in 10 ¹² | Modulation | Location |
|---------|---------------|------------------------------------|---------------|---------------------------|
| GBR | 16 | 100 | ? | Rugby, U.K. |
| NAA | 17.8 | 50 | Sometimes FSK | Cutler, Me. |
| NPG | 18.6 | 50 | CW | Jim Creek, Wash. |
| WWVL | 20 | 20 | CW | Fort Collins, Col. |
| NSS | 21.4 | 50 | CW | Annapolis, Md. |
| NBA | 24 | 50 | A1 | Balboa, Panama Canal Zone |
| NPM | 26.1 | 50 | CW | Lualualei, Hawaii |
| OMA | 50 | 1000 | AM | Podebrady, Czechoslovakia |
| WWVB | 60 | 20 | Slight AM | Fort Collins, Col. |
| MSF | 60 | 100 | Az | Rugby, U.K. |
| DCF 77 | 77.5 | 1000 | ? | Mainflingen, W. Germany |
| LORAN-C | 100 | 50 | Pulse | Carolina Beach, N.C. |
| RWM | 100 | 5000 | ? | Moscow, U.S.S.R. |

Table 1. From Reference Data For Radio Engineers, Howard W. Sams, Inc., 5th Edition, 1974.

low resistance. Two video outputs are provided by Z1; one drives the phase comparator while the other is used for viewing the received signal on the scope. These video lines must be shielded all the way to their destinations. The video threshold pot (R13) may be outside of the receiver shielding and is adjusted to produce a clean, negative-going loran-C signal containing little or none of the receiver ringing after each 100-kHz pulse burst. If all efforts at interstage shielding and orientation fail to eliminate CW receiver oscillation or agc "bumping" with the antenna well removed from the receiver circuitry, try adding degeneration resistance in series with C6 or the emitter of Q3 and adjusting the agc voltage manually to determine the point at which oscillation starts; then limit the agc range below this point by lowering R17. It should be noted that some frequency counters, digital meters, crystal calibrators, digital clocks, and pocket calculators radiate sufficient signals around 100 kHz to blank the receiver. This QRM may exhibit symptoms similar to receiver oscillation, so check them out before pulling out all your hair. If bursts of 100 kHz appear on the video synchronous with the 60-Hz power, check fluorescent lighting, arcing lines on utility poles, SCR dimmer and power controls, and electric motors. Long bursts of interference may be observed from lightning as much as 50 miles distant; these bursts are followed by receiver agc desensitization and may cause momentary small variations in the 10-MHz oscillator frequency. Other possible sources of random interference are thermostats and electric furnace igniters. Many of

these problems are solved by mounting the antenna (Fig. 1) on the roof.

The circuit shown in Fig. 3 provides a 10-MHz signal phase-locked to the loran-C carrier. It may be used to check the accuracy of a frequency counter or as a crystal calibrator providing 10-MHz, 1-MHz, and 100-kHz outputs with harmonics extending well into the VHF region. The crystal oscillator circuit of Q5 becomes a narrow range voltage-controlled oscillator through the varactor action of CR4 and CR5, which are ordinary silicon rectifier diodes. The tuning voltage applied at the junction of the diodes can slew the oscillator plus or minus 50 Hz from the center frequency which is adjustable with C19 and C20. The 10-MHz signal is buffered and counted down to 100 kHz for phase comparison. The phase comparator shown was chosen due to the low duty cycle and possible high noise content of the loran-C signals. A plus or minus 30-Hz lock range may be expected of the circuit. Meter M1 indicates variations in the tuning voltage applied to the voltage-controlled crystal oscillator. Resistor R18 is used to center the meter at the optimum tuning voltage (6 V, assuming equal comparator diode leakage and negligible loop filter capacitor leakage). Due to the high impedance of the phase comparator circuit, it is imperative that C18 and C21 be of the low-leakage tantalum type and that diodes CR4, CR5, CR8, and CR9 be selected for minimum reverse leakage current.

Preliminary adjustment of the vco is as follows:

1. With the unit enclosed in its housing, apply power and allow at least one-half hour for the temperature of the oscillator to stabilize.

2. Adjust the video

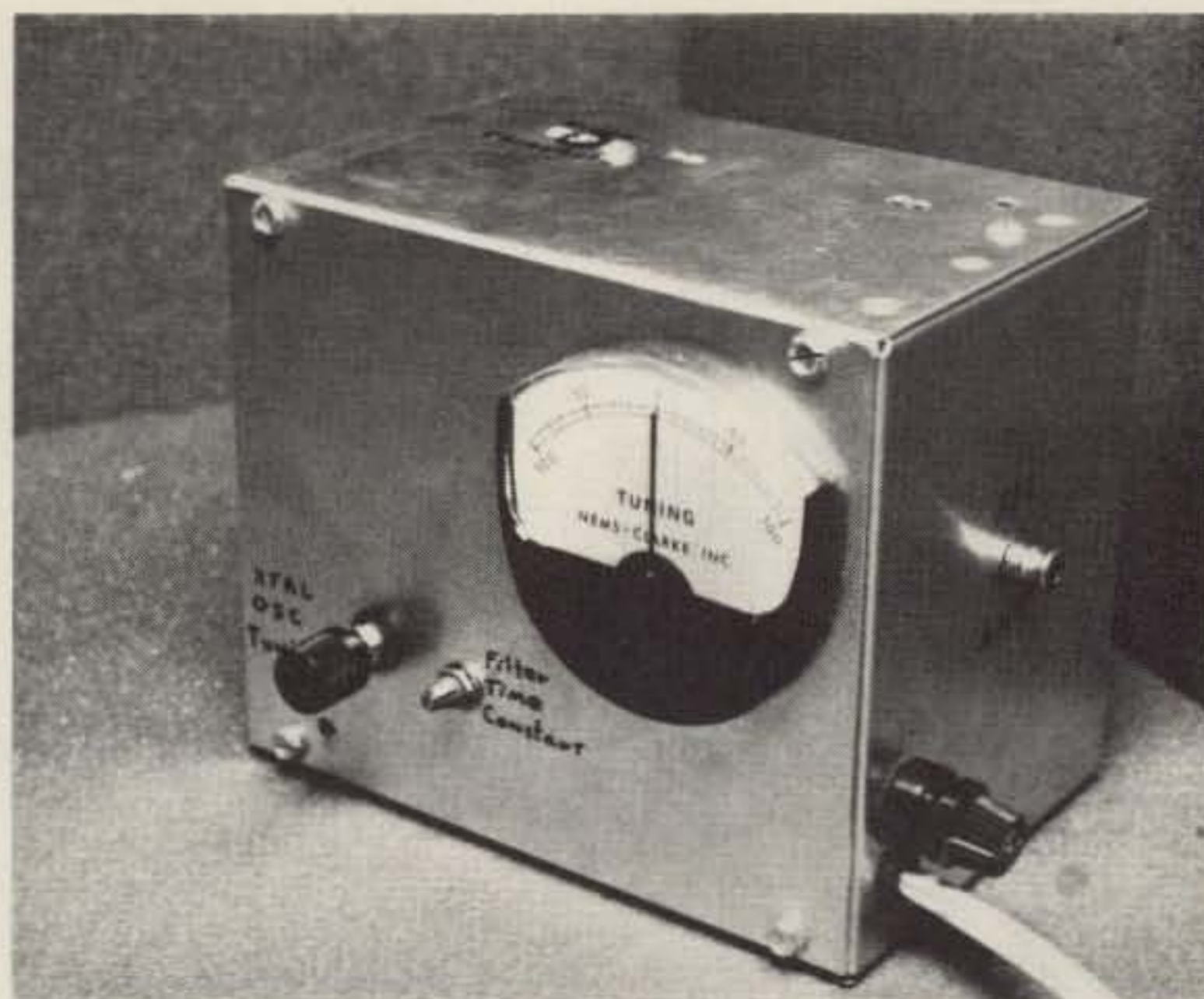

Photo 3. Complete calibrator is housed in 4" x 4" x 6" minibox.

threshold control (R13) to produce a near zero volt dc level containing no signal or noise on the video line. This should drive the source of Q7 to approximately six volts.

3. Set R20 to its maximum resistance position.

4. Adjust R18 to bring M1 to midscale.

5. Adjust C20 to the midpoint of its capacitance range.

6. While monitoring the buffered 10-MHz signal on the frequency counter, set the oscillator frequency to exactly 10.000000 MHz by adjusting C19.

7. Readjust the video threshold control (R13) to

produce a clean negative-going loran-C signal.

8. The unit should now be phase-locked to the loran-C carrier. Very slowly rotate C20 while watching the frequency counter and the tuning voltage meter. The meter indication will slowly change in one direction as the PLL maintains phase lock with the loran signal. Note the meter indication at which the PLL unlocks (the frequency counter and tuning voltage meter indication begin varying cyclically).

9. Repeat step 8, driving the meter indication in the opposite direction. Note the meter indication.

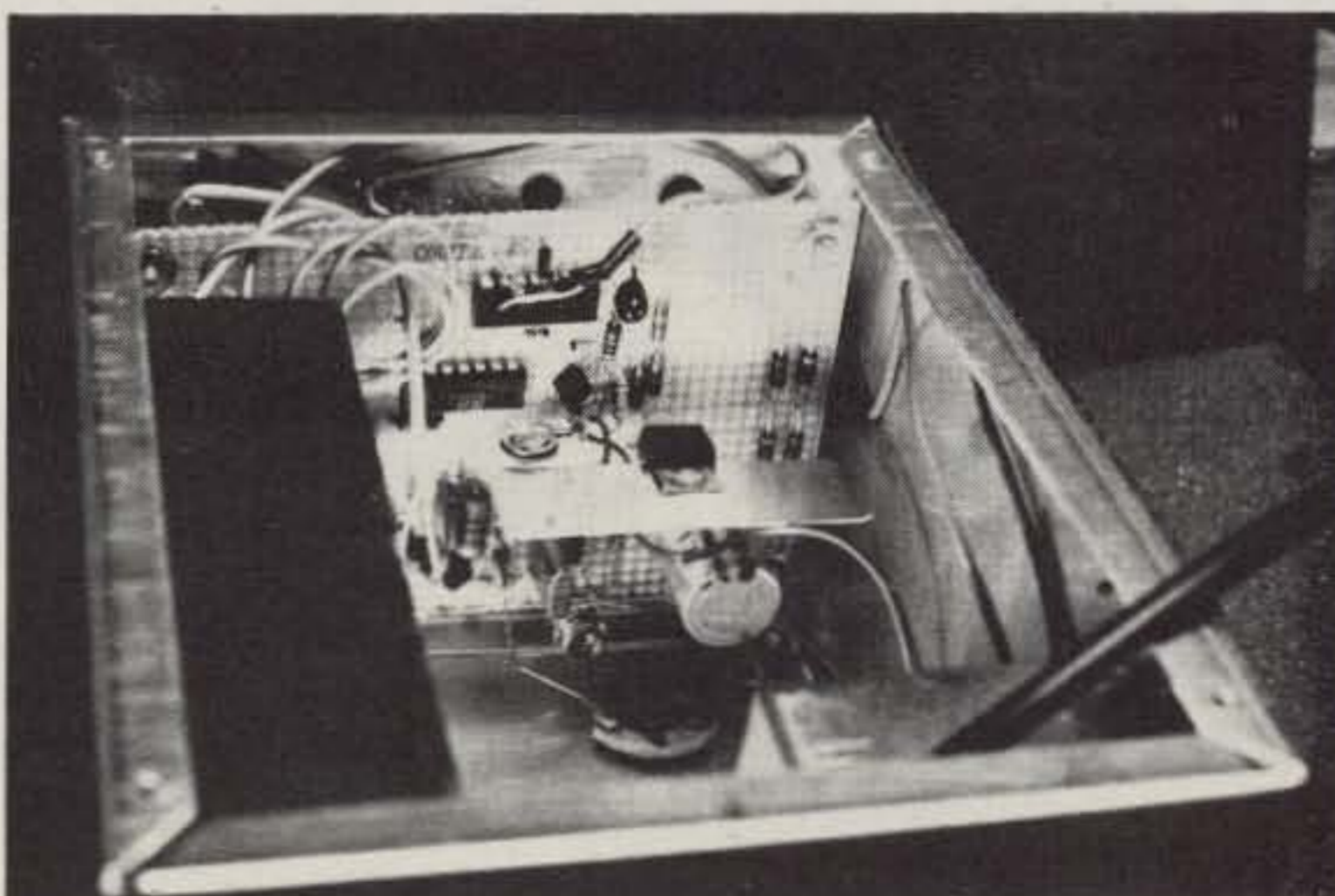

Photo 4. Behind the front panel; the receiver is mounted at the top with its input circuits away from the phase-locked oscillator which is mounted on the left wall.

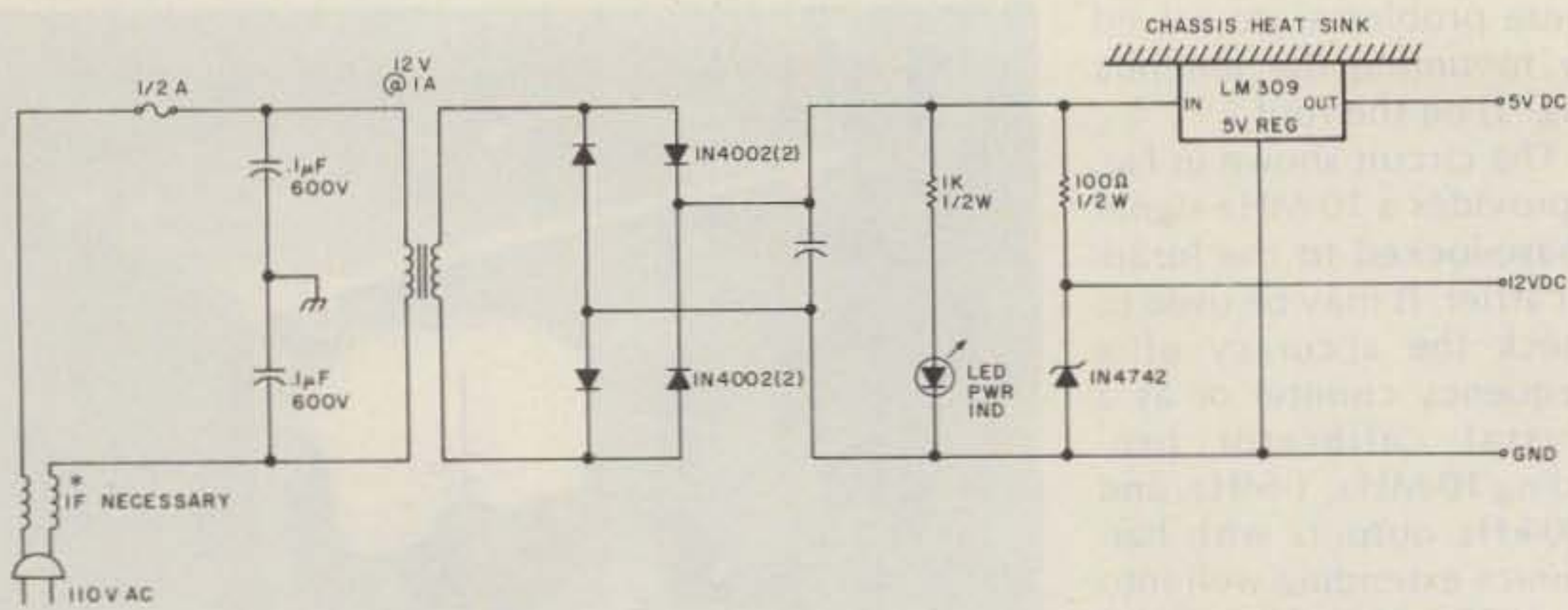

Fig. 4. Power supply for the calibrator.

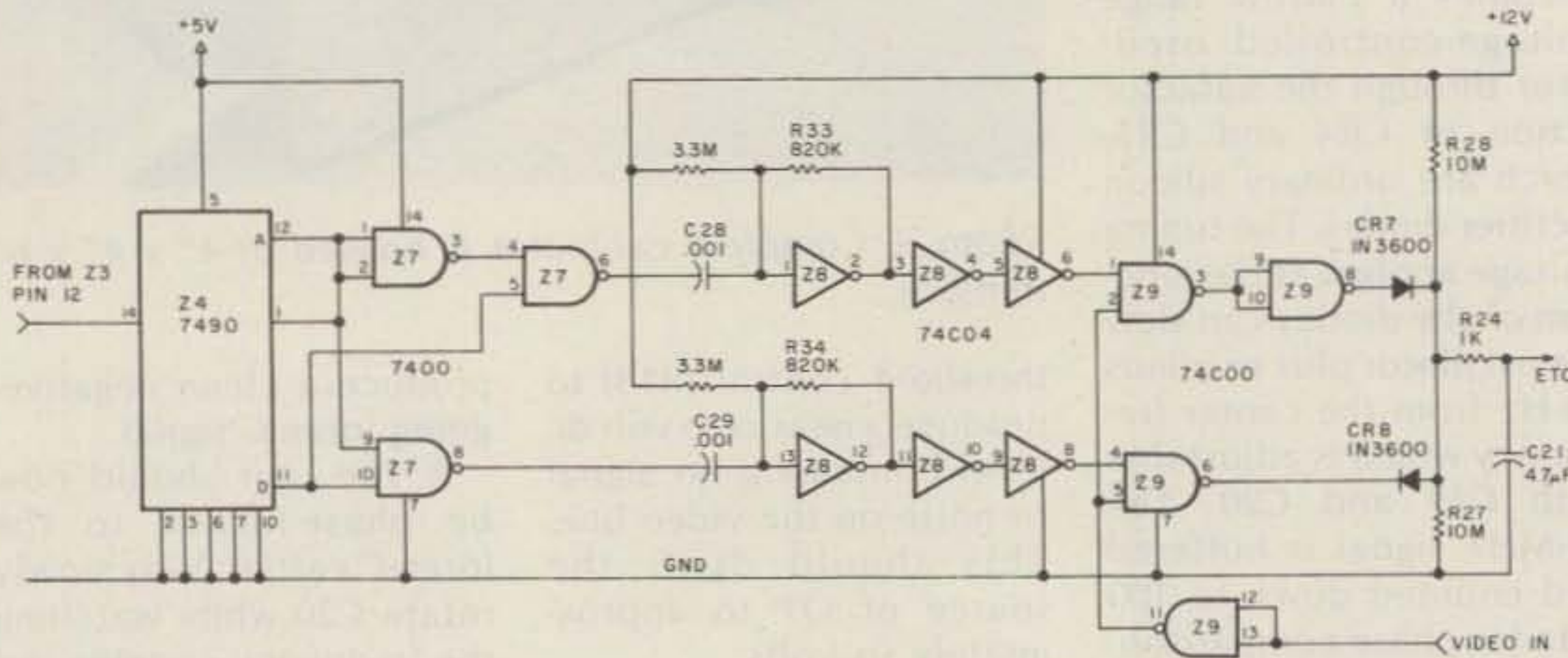

Fig. 5. This phase detector is useful when certain types of master-slave interference are encountered. These parts are inserted into the circuit of Fig. 3, while Z5, Z6, R32, and C27 are omitted.

10. Readjust R18 so that the PLL lock range is symmetrical with respect to the meter centered indication.

11. Adjust C20 to bring

M1 to center scale.

12. Slowly adjust R20 toward its minimum resistance position, stopping at the setting which gives the most stable frequency

counter indication.

13. The unit is now providing an extremely accurate 10-MHz signal which may be used for frequency calibration.

14. Should the PLL unlock due to signal dropout or room temperature excursions, slight readjustment of C20 should restore the phase-locked condition.

The calibrator shown in Photo 3 has maintained phase lock for days on end in a normal shirt-sleeve environment, yielding plus or minus one-Hz accuracy of the 10-MHz signal. If your version will be required to operate over large temperature variations, or you desire ridiculous frequency accuracy, consider mounting the vfo components in a temperature-controlled oven.

One problem that may be encountered in the operation of the calibrator results from the phase difference existing between the loran-C master and slave signals. This may cause the tuning voltage to fluctuate radically as the master and slave signals move in and out of coincidence. The solution to this problem depends upon your exact geographical location. If the master and slave signals arrive exactly in phase, there is no need to differentiate between them. If the phase difference is greater than about ten degrees but less than ninety degrees, the signals may be separated on the basis of their amplitude difference. This is accomplished by adjusting R13, the video threshold control, to pass only the stronger of the two signals. It may be helpful to position the loop to null the weaker signal. If the two signals differ by more than ninety degrees, the phase detector modification shown in Fig. 5 may be used, but it will reduce the vco lock range, and the 100-kHz video must be limited to a twenty-percent duty cycle.

This article presents basic concepts on which

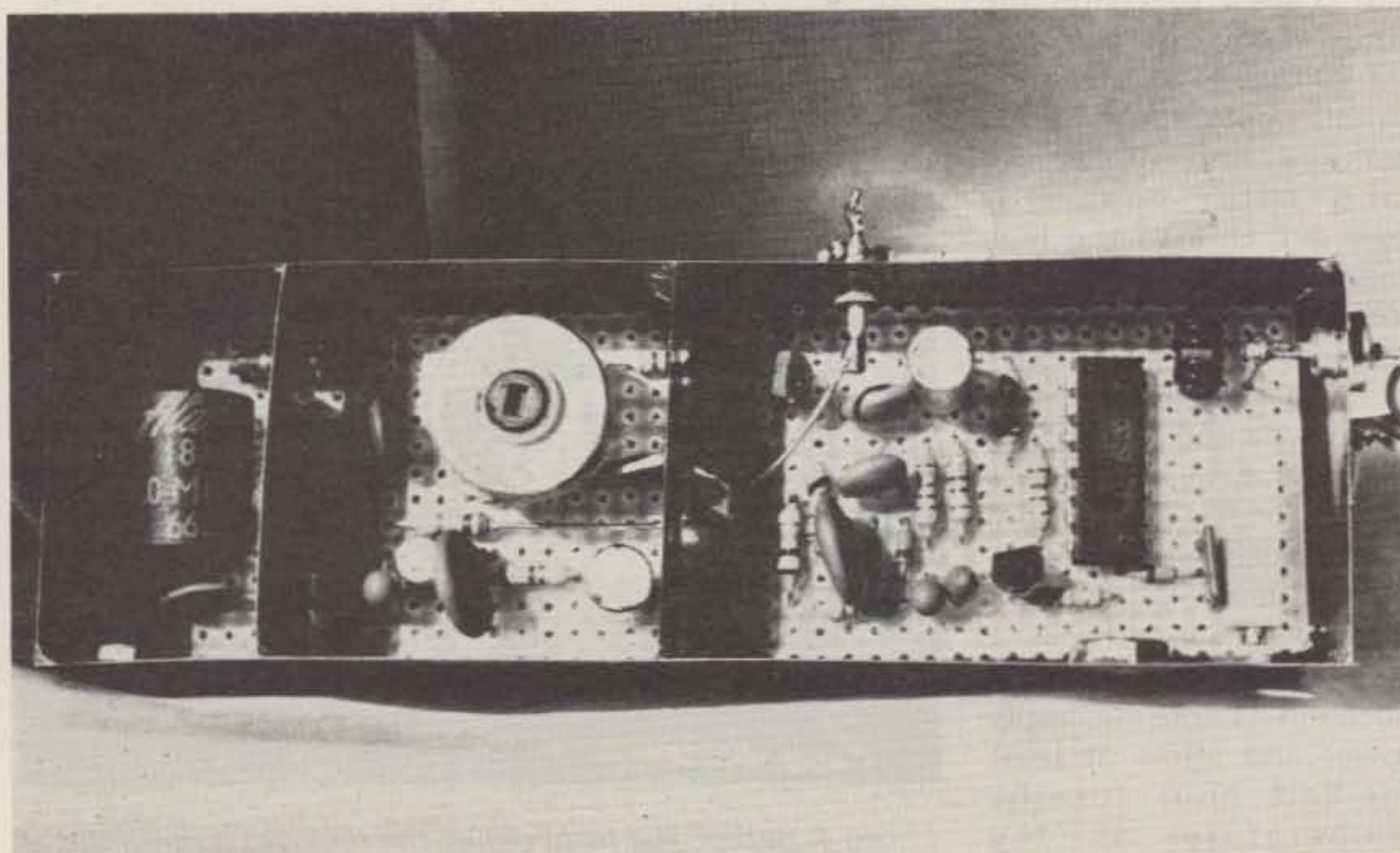

Photo 5. 100 kHz receiver. Notice shielding.

many variations are possible. The vco may operate at any frequency that can be divided down to exactly 100 kHz. It is possible to use an oscillator that is not crystal-controlled for the vco; however, the stability must be very high and the voltage-controlled tuning range very narrow (less than plus or minus one Hz per volt when divided down to 100 kHz). If upon construction of your receiver no loran-C signal of usable strength can be produced, try retuning to receive one of the stations listed in Table 1. These signals may be used for calibration in the same manner as loran-C, except that their frequencies are more difficult to relate to multiples of 100 kHz (refer to Fig. 6 for some suggested arrangements). If the station you choose emits A1 telegraphy, the phase discriminator shown in the loran-C unit will give

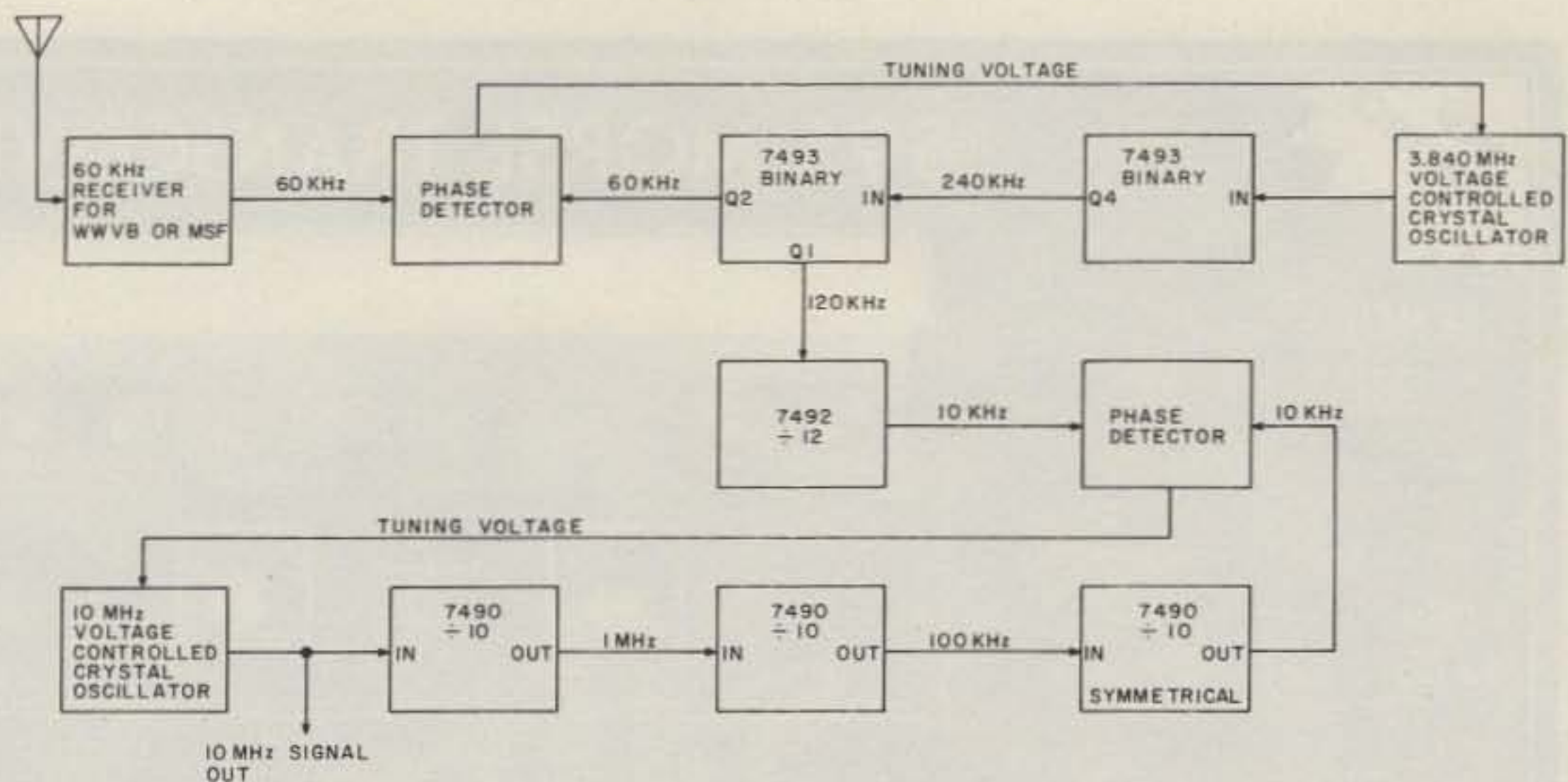

Fig. 6. A typical method of translating some VLF signal frequencies to a 10-MHz phase-locked crystal calibrator.

best results. If, however, an uninterrupted CW or amplitude modulated station is chosen, a more conventional phase discriminator may be used.

In this article I have attempted to cover every possible difficulty that may be encountered while employing these tech-

niques. However, my intent is not to scare anyone away from constructing a most useful tool for amateur work. I would suggest constructing the receiver described and observing the signals before proceeding to build the complete calibrator. If reasonable efforts are

made at shielding and sensible component layout is employed, little difficulty should be encountered duplicating the unit described. We may find that the VLF band, once only a curious phenomenon, will become very important to the serious radio amateur. ■

CONTESTS

from page 88

more = multiplier of 1.00; 300 to 499 Watts = 1.50; 101 to 299 Watts = 2.00; 100 Watts input or less = 4.00. Final score is total QSO points times IDX multipliers times power multiplier.

AWARDS:

For each mode and class of operation, awards will be issued to top scorers in each US state, Canadian province, DXCC country, and to each IDX listed island. Other special achievement awards will be issued as determined by the IDX Contest Committee. All committee decisions will be final.

LOGS AND ENTRIES:

Contestants must include a self-prepared log sheet for each band, and a self-prepared dupe sheet for all entries of 100 or more contacts. Entries must also include a summary sheet available from the contest committee. Entries without the official summary sheet will be treated as "check logs" and will not be eligible for awards. Log sheets must indicate: date/

time in GMT, band, station worked, RS(T) sent and received, DXCC country or IDX island worked. Entries must be postmarked no later than Jan. 4, 1979. All entries must include a large SASE. Foreign contestants enclose 3 IRCs. Every attempt will be made to publish an abbreviated form of the contest results in all major amateur publications. Multi-transmitter stations will not be eligible for awards. Failure to submit a dupe sheet for 100 or more contacts and operating more power than the power class multiplier claimed are both grounds for disqualification.

GRANDE RONDE RADIO AMATEURS

Grande Ronde Radio Amateurs, a small club located in Union County, eastern Oregon, is offering an award to any foreign or domestic amateur who submits evidence of two-way communications with three amateur radio stations in the Grande Ronde Valley. Any band or mode may be used and no QSLs need be sent. The fee for the award is \$1.00 or two

IRCs, and it will be sent postpaid upon receipt and verification of the application. Letter applications should include the callsigns, dates, and times of all contacts claimed

and should be sent to: June Campbell WB7FDB, Rt. 2, Box 2486, La Grande OR 97850. A limited number of honorary awards will be made at the discretion of club members.

Ham Help

I recently acquired a Dynasciences model 330 digital multimeter of the used variety, and it had no manuals or schematics with it. I would like to obtain these manuals and schematics if at all possible, and also would like any information on adding on the ac measurement capability. If anyone has the above manuals and schematics, I will be glad to pay for having copies made or whatever arrangement we can come up with.

Don E. Brown WB7FGO
Rt. 2 Box 949
Libby MT 59923

I'm looking for a ham in the Hollywood CA area who would like to share an apartment. He must have a setup capable of making phone contacts with southeast Florida.

R. Selken WB4VWV
3931 NW 31st Ave. Apt. 5
Ft. Lauderdale FL 33309

I am in need of diagrams and conversion information for a military R-392/URR radio receiver recently purchased. I could also use some information on getting into TTY.

Robert E. Bunn WA0LKE
Rt. 3, Box 565
West Plains MO 65775

Help! I'm looking for the name and address of someone on the east coast who will rewind a plate transformer for a Collins KWS-1.

Donald O. DeLung WB4LJE
830 Pinecrest Avenue
Bedford VA 24523

I need information leading to the name of a manufacturer and possible purchase of an allmode 6m, 2m, 1 1/4m, 3/4m transceiver tunable in 5 kHz steps or better.

Victor Ung WA6PDM
1980 Magnolia Dr.
Monterey Park CA 91754

NEW
FROM XITEX

\$95 MORSE TRANSCIEVER



SEND:

- 1 to 150 WPM (set from terminal)
- 32 character FIFO buffer with editing
- Auto Space on word boundaries
- Grid/Cathode key output
- LED Readout for WPM and Buffer space remaining

SERIAL INTERFACE:

- ASCII (110, 300, 600, 1200) or Baudot (45, 50, 57, 74) compatible
- Simplex Hi V Loop or T²L electrical interface
- Interfaces directly with the XITEX[®] SCT-100 Video Terminal Board; Teletypes[®] Models 15, 28, 33, etc.; or the equivalent

MRS-100 CONFIGURATIONS:

- \$95 Partial Kit (includes Microcomputer components and circuit boards; less box and analog components)
- \$225 Complete Kit (includes box, power supply, and all other components)
- \$295 Assembled and tested unit (as shown)

Overseas Orders and dealer inquiries welcome

COPY:

- 1 to 150 WPM with Auto-Sync.
- Continuously computes and displays Copy WPM
- 80 HZ Bandpass filter
- Re-keyed Sidetone Osc. with on-board speaker
- Fully compensating to copy any 'fist style'

See your local dealer or contact XITEX[®] direct.

MC/Visa accepted

XITEX CORP.
P.O. Box 20887
Dallas, Texas 75220
(214) 386-3859

FCC

Reprinted from the Federal Register.

from page 207

benefit of the handicapped, what standards should we apply for granting a waiver?

HOW TO COMMENT ON THIS INQUIRY

The FCC is very interested in any comments you or your group might have to help the Commission consider policies or rules to help meet the amateur radio communications needs of the handicapped. The Commission asks those submitting comments to evaluate each of the decision alternatives in terms of the decision factors we have outlined. (For example, what would the impact on the amateur service be if the Commission were to adopt alternative 2?) We also welcome suggestions about other decision alternatives and factors we may have omitted. All persons submitting comments should bear in mind the basic questions the Commission wishes to resolve:

The Commission's amateur examination program is partially founded on the proposition that the Commission is obligated to provide the handicapped with equal opportunity to obtain amateur operator licenses. If the Commission's commitment to equal opportunity is sound, is the Commission doing enough to guarantee that equality? If not, what else should we do?

The Commission does not afford the handicapped special consideration with respect to the passing standard on amateur radio telegraphy examinations. Is Commission policy in this regard sound? If not, how should we go about implementing a workable program of extending the handicapped special consideration in the administration and grading of amateur telegraphy examinations?

Comments are due no later than November 30, 1978. Reply comments (which are responses to comments filed by others) are due no later than December 29, 1978. You can read comments filed by others in the FCC's Public Reference Room, Room 239, 1919 M Street NW., Washington, D.C. The Commission is unable to furnish copies of comments submitted in a rulemaking, but, for a fee, our duplicating contractor will handle requests

for this kind of material: Downtown Copy Center, 1114 21st Street NW., Washington, D.C. 20037. Your comments should be addressed to: Secretary, Federal Communications Commission, Washington, D.C. 20554. Formal participants must file an original and 5 copies of their comments, reply comments and other materials, following instructions found in the FCC Rules. Participants wishing each Commissioner to have a personal copy of its comments may file an original and 11 copies. Members of the general public who wish to express their interest by participating informally may do so by submitting one copy. In addition, you may submit an informal comment over the Commission's unattended teletype (TTY) terminal by following this procedure:

1. Dial 202-254-9292 not a toll-free number.
2. You will receive the following message: You have reached an unattended TTY at the FCC in Washington. Please type in your message—it will be recorded automatically.
3. Upon completion of the automatic message, immediately start to type your reply. The machine will not give you a (GA) go ahead.
4. The unattended machine is activated by your TTY reply. Any silent period of 15 seconds will cut off your phone connection. It is important that you at least hit the period key during any delay that lasts 10 seconds. This will keep your telephone connection open until you have completed your message.

All comments should contain the correct docket No. of this inquiry. Further information concerning this inquiry may be obtained from Mr. Gregory M. Jones, Safety and Special Radio Services Bureau, at 202-634-6619 not a toll-free number. The deaf or hearing impaired may obtain additional information about this inquiry by calling the Commission's attended TTY at 202-632-6999 not a toll-free number.

FEDERAL COMMUNICATIONS
COMMISSION,
WILLIAM J. TRICARICO,
Secretary.

Ham Help

I have been out of amateur radio since 1961, so you can imagine my total bewilderment about types and manufacturers of amateur equipment these days. I appreciated the article in the August, 1978, issue, "Ham Radio Is NOT A Rich Man's Hobby," since I am in the process of reconditioning an NC-183D and a B&W 5100B. Both these pieces of gear were purchased new in 1955 and were used quite often for 5-6 years. Since that time, they have "collected dust" and been banged around during three changes of address.

The receiver needed a new power transformer and the electrolytic capacitors were replaced (after two of them "let loose" with a sharp pop). Since reading this article, however, I have decided to replace the paper bypass caps. It does need some alignment though, and I'm letting one of the local experts realign the beast.

The transmitter presents a different set of circumstances. I was always a CW-only operator, which was fine then. Since the 50s, SSB has become "the voice mode" more than AM. I am looking for an SSB exciter which can be made compatible with the 5100B—either one made by B&W or one from someone else which can be adapted. The other alternative is to obtain some schematics

of home-brew equipment from someone who has covered this same territory some 10-15 years ago.

So you see, I feel like Rip Van Winkle—can anyone help? I certainly would appreciate it.

Fred McKenzie
950 Damrosch St.
Largo FL 33541

I need a schematic and manual for a TRUVOM made by Eico (model #100A4).

Paul Hoy WA3YME
130 East Main St.
Tremont PA 17981

I need the schematic and operating manual for a Radio Manufacturing Engineering, Inc., model VHF-152. I will pay cost of reproduction.

H. Hansen
8 Abenaki Trail
Littleton MA 01460

I need an operation/maintenance manual and a schematic for a Dumont oscillograph, type 208-B, serial number 7683. If anyone could help me on this piece of equipment, it would be greatly appreciated. I will gladly reimburse any mailing or duplicating expenses incurred. Thank you.

David T. Baxter AD4X
204 East Depot Street
Greenville KY 42345

\$95 Stand Alone Video Terminal

```

αΒΥΣ εΒυλμνπΣφψωΩοιεε °±÷≈[ ]|←→↑↓
!"#$%&'()* +,-./012456789:;<=>?
@ABCDEFGHIJKLMNPOQRSTUVWXYZ[\]^_
`abcdefghijklmnopqrstuvwxyz{|}~

```



SCT-100 FEATURES:

- 64 X 16 line format with 128 displayable characters
- Serial ASCII or BAUDOT with multiple Baud rates
- \$187 Assembled or \$157 Kit (Partial Kit \$95)
- Full cursor control with scrolling and paging
- On board power supply
- Many additional features

Call or write today. MC/VISA accepted

XITEX CORP. P.O. Box #20887

Dallas, Texas, 75220 ● Phone (214) 386-3859
Overseas orders and dealer inquiries welcome

Social Events

SOUTH GREENSBURG PA NOV 4

The Foothills Radio Club of Greensburg will hold its annual swap-n-shop on Saturday, November 4, 1978, from noon to 5:00 pm, at St. Bruno's Church at the junction of U.S. Rte. 119 and Rte. 819 in South Greensburg, Pennsylvania, just off turnpike exit 8. There will be an indoor flea market. Talk-in on .07/.67 and .52. For further information, contact Melvin Ruble WA3RVD, Mark Drive, Delmont PA 15626.

HOUSTON TX NOV 4-5

The Houston chapter of Ten-X, S.H.O.T., will hold its second annual Houston Hambash on Saturday and Sunday, November 4 and 5, 1978, at Spring Creek Park. There will be a barbecue, soft drinks, beer, prize drawings, and planned activities for all, including the kids. Full camping facilities, including hookups, are available. All amateurs are invited. For more information, contact Bob Libbers WB5FII, 4034 Jackwood, Houston TX 77096.

NORTH FORT MYERS FL NOV 5

The Fort Myers Amateur Radio Club will hold its Hamarama 78 on Sunday, November 5, 1978, 8:00 am to

4:00 pm, at the Lee County Fairgrounds, North Fort Myers, Florida. The location is at the intersection of highways Fla. 31 and C-78. Admission is \$3.00 and children are free with parents. For further information, contact Bob W. Sloat K4VGN, Hamarama Committee Chairman, FMARC, PO Box 0537, Tice FL 33905.

FRAMINGHAM MA NOV 11

The Framingham Radio Club will host the largest indoor flea market in Massachusetts on Saturday, November 11, 1978, at the drill shed located in the rear of the Framingham Police Station, 81 Union Avenue, Framingham, Massachusetts. The event begins at 10:00 am, rain or shine. Door entry fee is \$1.00 per person and includes two chances for door prizes. Tables are \$5.00 for a six-foot table, \$3.00 for a half table. Tables are \$7.50 if not reserved in advance. Talk-in on .75/.15, .52, and CB channel 12. For advance reservations, send check to Framingham Radio Club, PO Box 3005, Framingham MA 01701, or phone (617)-877-7166.

MCAFEE NJ NOV 10-12

The Hudson Amateur Radio Council, Inc., will hold the ARRL Hudson Division Conven-

tion on Friday through Sunday, November 10-12, 1978, at the Playboy Resort and Country Club at Great Gorge in McAfee, New Jersey. There will be exhibits, a flea market, forums, and a banquet featuring the New York Mets' Ron Swoboda WA2HVM as speaker. Admission is \$3.50 in advance, \$5.00 at the door. The Saturday night banquet is \$15.00 in advance, \$17.00 at the door. There will be a large program for both hams and non-hams, plus a two-day women's program. Talk-in on 146.10/.70 and .34/.94. For complete details, contact Hank Wener WB2ALW, Chairman, 53 Sherrard Street, East Hills NY 11577.

SELLERSVILLE PA NOV 12

The RF Hill Amateur Radio Club will hold its Winter Indoor Hamfest II on Sunday, November 12, 1978, 9:00 am to 5:00 pm, at the Sellersville National Guard Armory, Rte. 152, Park Ave., Sellersville, Pennsylvania. The event will be all indoors and heated. Prizes and refreshments are planned. Talk-in on .28/.88 and .52. Donation is \$2.00; XYLS receive free admission. Dealers' admission is \$3.00. Bring your own tables. For more info, write Sam Cox WA3IUH, PO Box 29, Colmar PA 18915.

WEST MONROE LA NOV 12

The Louisiana Hamfest will be held on Sunday, November 12, 1978, at the West Monroe

Civic Center in West Monroe, Louisiana. Exhibitors are welcome. There will be swap tables available and prizes to be given away. For information, contact AE5V, 500 McMillan, West Monroe LA 71291.

FORT WAYNE IN NOV 19

The Allen County Amateur Radio Technical Society will hold its 6th annual hamfest on Sunday, November 19, 1978, 8:00 am to 4:30 pm, at the Allen County Memorial Coliseum, corner of Parnel and US 30 bypass north. Activities include prizes, forums, and indoor exhibition and flea market area. Admission is \$2.50 and children under 12 are free. Tables (3' x 8') are \$3.00. Talk-in on 146.28/.88 and 146.52. For details, write ACARTS, Inc., PO Box 342, Fort Wayne IN 46801. Include an SASE.

LAUREL MD NOV 26

The Columbia Amateur Radio Association will hold its 2nd annual hamfest on Sunday, November 26, 1978, beginning at 8:00 am, at the Laurel Race Way, three miles north of Laurel on Route 1. Admission is \$2.00 and tables are \$5.00. There will be food services, prizes, and a giant flea market. Everything is indoors. Talk-in on 147.735/.135, 146.16/.76, 146.52/.52, and CB channel 1. For information and reservations, contact Sue Crawford N3SC, 6880 Mink Hollow Road, Highland MD 20777.

Ham Help!

—a telephone aid for the blind

Jeff Wallis is blind and has been a ham radio operator for a number of years. His call is WB4LGI. I talked to Wallis a couple of times in the two meter band without being aware of his handicap.

After a few unfortunate experiences in different jobs and being mugged in downtown Miami a couple of times, Jeff landed a temporary job with the U.S. Customs Service as a radio and telephone operator. In

this position, Jeff is required to answer a five-line telephone. The ringing hold line in use is indicated by a flashing light below the push-button for each line. In his condition, Jeff was unable to operate this type of telephone.

On the two meter band, Jeff met Ian Seidler W4MRR, an engineer with Racal-Milgo Electronics, builders of computer equipment in Miami. Ian talked to Len Klein

WB4YJC, and with other hams at the company, they designed and built a very simple light-controlled solenoid that will tell at the touch of the hand which light is flashing. Cliff Bloom WD4LPU, a technician with ETC Radio in Lauderhill, Florida, built the "black box" with the components donated by different sources.

The design and building of this clever device involved lots of problems

because the telephone company does not permit any direct attachment to the telephone. The unit has its own power supply and is small and simple. The donors were Racal-Milgo, Deltrol Control, Guardian Relay, and Clairex. A complete diagram of the circuit is available free to anyone. Write to Ian Seidler W4MRR, Mail Station 4101, c/o Racal-Milgo, Inc., 8600 N.W. 41st St., Miami, Florida 33166. ■



Five lines control the telephone ready to be operated by blind persons.



Jeff Wallis WB4LGI with Cliff Bloom (left) and Ian Seidler W4MRR (right). Ian is showing Jeff how to operate the clever machine.

Pick a card...any card

CALL TOLL FREE

1-800-228-4097
Communications Center

443 N 48th Street
 Lincoln, Nebraska 68504
 In Nebraska Call (402)466-8402

1-800-634-6227
Communications Center
West ✓C58

1072 N. Rancho Drive
 Las Vegas, Nevada 89106
 In Nevada Call (702)647-3114

Sale subject to limited supply

K

YAESU
FT-901 DM
 List \$1459
 Price too low
 to print, call
 for quote.

9

 Buy a **FT-301**
 digital for
\$935 and get a
 power supply &
 CW filter free!

J

YAESU
FT-101E
 List \$799
 Price too low
 to print, call
 for quote.

J

YAESU
FT-7 Mobile
 List \$549
 Call for discount
 price

Q

KENWOOD
TS-820S
 List \$1099
 Call for low
 price

K

KENWOOD
TS-520s
 List \$739
 Our price too
 low to print,
 call for it!

2

KENWOOD
TR 7400
 List \$399
 Call for discount
 price

K

R4C List \$699
 Your price \$599
T4XC List \$699
 Your price \$599

10

YAESU
FT-227R
 List \$349
 Call for discount
 price

An Experimenter's Delight

— a lab bench with style

Frederick H. Raab WAIWLW
240 Staniford Road
Burlington VT 05401

With a little work, and not as much money as you'd think, you can build a professional-type lab bench tailored to your individual needs. You probably won't copy my design exactly, but it should give you some ideas and directions for your own design.

Some of the features I included are: lighted switches, one main on/off

switch, switched 220 V ac and 110 V ac outlets (the latter are quite handy for things like soldering pencils without an on/off switch), a ground fault indicator, ground posts, and switched dc power. The dc power is obtained from readily available surplus computer power supplies situated on the lower shelf; power is available from both binding posts and special outlets on the bench.

The Bench

I began this project by

looking at commercially available benches. I wanted something that looked good, would be convenient and flexible, could be disassembled for moving, and didn't cost too much. Usually, I found that ready-made lab benches either cost a fortune or

didn't meet my requirements. The exception was the Kewaunee Scientific assembly table given in Table 1. It is available in several lengths and colors, and its height is adjustable.

The table top, panels, legs, and lower shelf (Fig. 1) are assembled upside

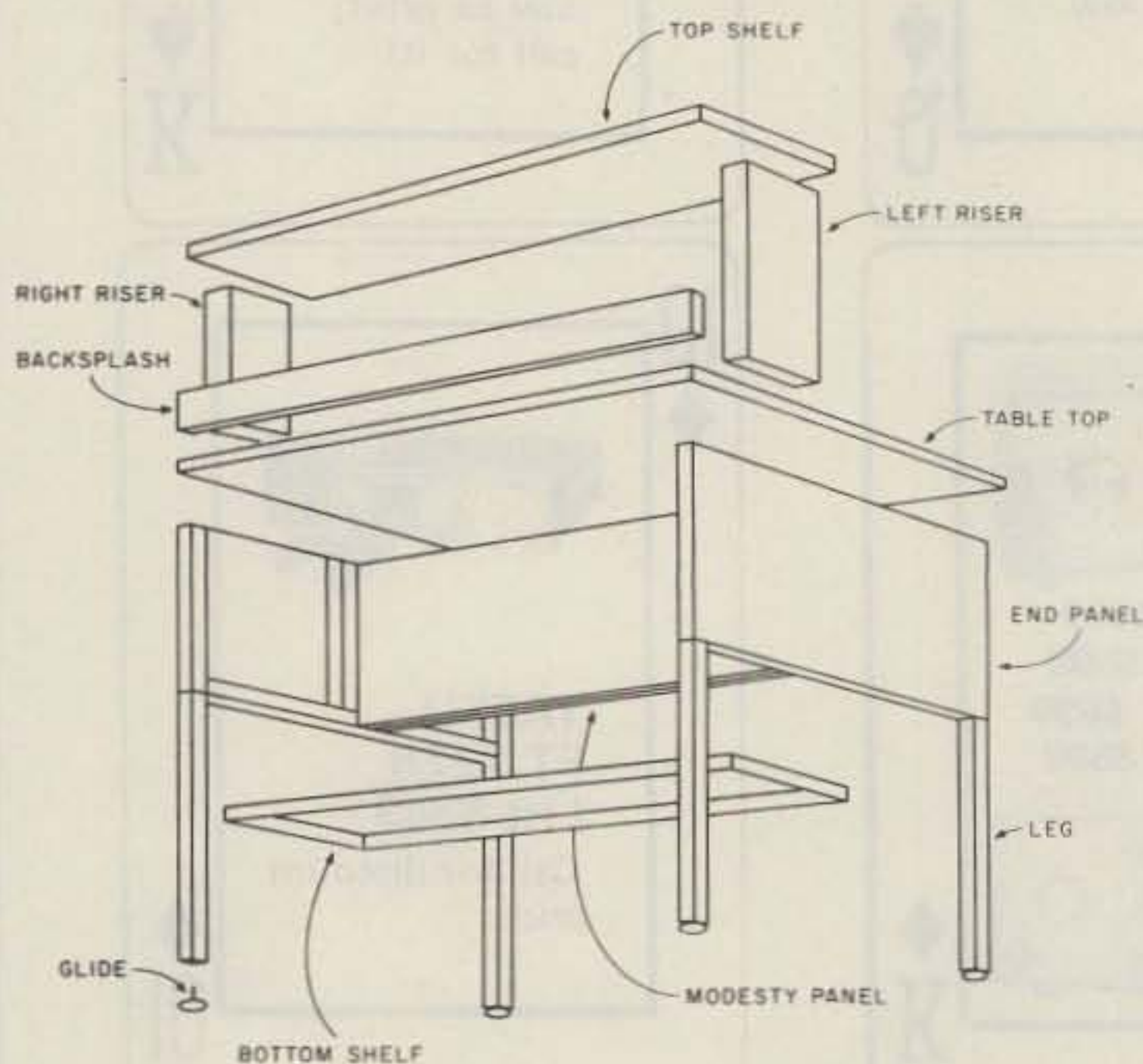

Fig. 1. Bench assembly details.

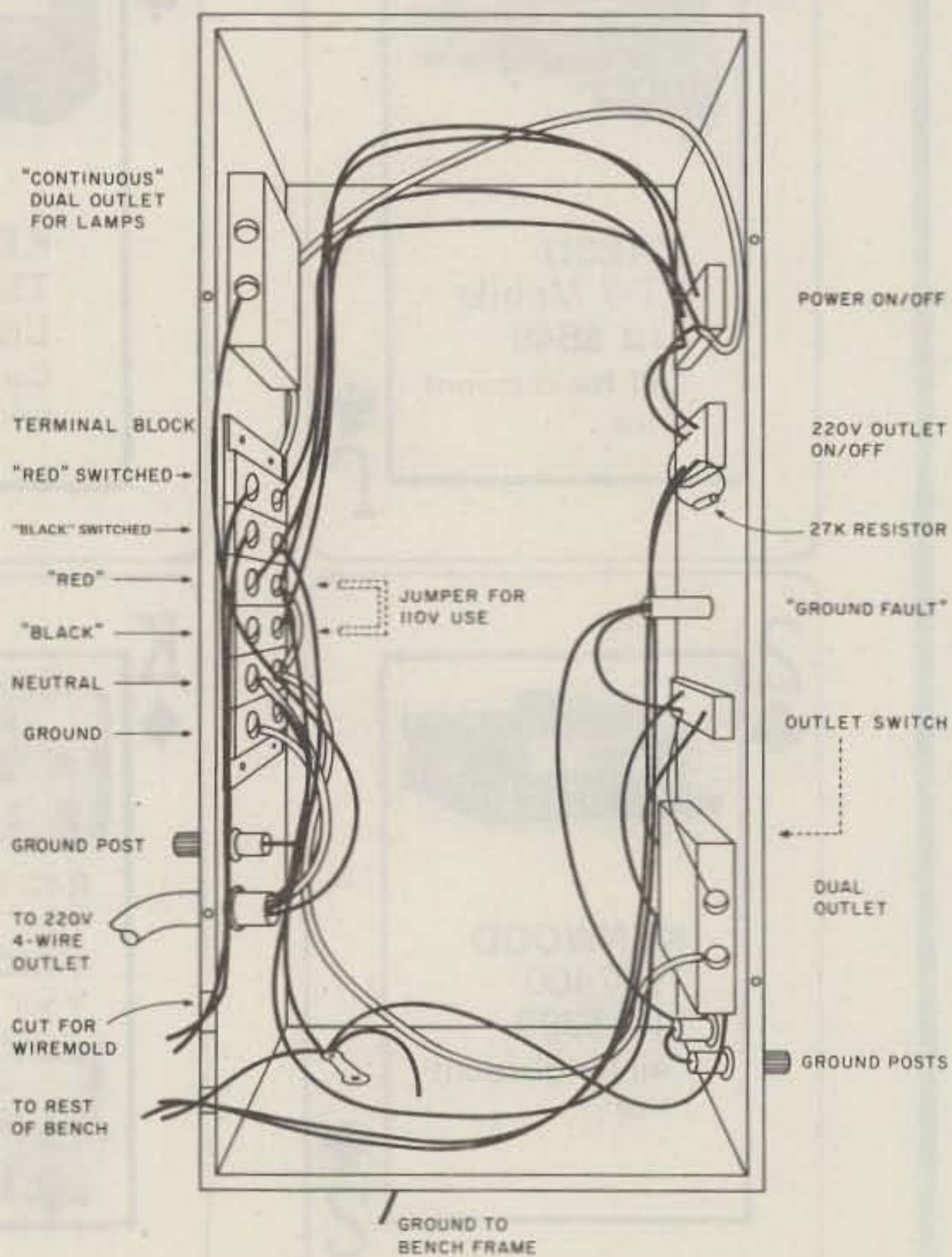

Fig. 2. Wiring and construction of right riser.

down, preferably on a carpeted floor. You will need to drill holes into the bottom of the table top for the screws that fasten the panels to the top. I suggest that you measure the depth to be drilled and mark it on the bit with a piece of masking tape; this will prevent you from drilling through the Formica™ on the other side. I assembled the table with the lower shelf open to the rear of the bench, rather than the front as shown in the instructions. This gets the shelf out of the way of your legs and also makes a convenient, but hidden, place to put transformers and power supplies. When the main portion of the bench is assembled, set it upright and mount the backslash with two angle brackets at about one-third and two-thirds of the distance from end to end. The ends of the backslash will later be fastened to the risers.

Risers

Since I wanted a number of special functions in the risers, it was easier to build my own rather than try to adapt the risers made for the bench. I used 8" x 17" x 3" aluminum chassis and covers for the risers. The functions I incorporated are shown in Table 2. You can adapt these to your own needs. I should note that the Honeywell lighted rocker switches seem to be quite convenient and are available with either 100 V ac or 14 V dc lamps.

Begin assembly of the risers by laying out the positions of the holes that must be cut. While these holes can be made with a nibbling tool and router, a set of chassis punches will do a much neater job. It will also be necessary to cut and to bend tabs for the Wiremold® conduit. To see what is required, take a look at the tabs that come

in the boxes.

When all this is done, the risers can be painted to match the bench and lettering can be added using decals or dry transfers. A coat of Krylon™ will preserve the lettering. The painted and lettered risers are then fastened to both the table top and the backslash. The top shelf is then mounted on the risers. Drill a hole through the bottom of each riser and the table top under it to allow the bench frame to be connected to ground.

I used residential-type surface-mounted Wiremold® for most of the power outlets on the bench. Five double boxes were installed on the backslash and connected with two strips of conduit. On top of each box, I mounted two grounding posts, and three of the five boxes hold two double outlets. One box has one double outlet and one 220 V ac outlet, and another has a dual 12 V dc outlet and a set of binding posts for the dc power supplies. Number 12 type THHN (conduit-type) wiring was used throughout.

Wiring the bench is straightforward, and I don't need to insult your intelligence by going into detail. The power cord is connected to four blocks of a six-terminal strip. The other two blocks are for the switched-power connections. The bench is wired as if 220 V ac is available; if only 110 V ac

Table
Lower shelf
Backslash
Upper shelf

Risers
Covers
Terminal block
Binding post, green
Neon lamp assembly

Wiremold® conduit
Double surface-mounting boxes
Dual grounding outlets
220 V ac outlet
Special purpose outlet
Cable clamps
No. 12 THHN wire, various colors
Heavy-duty line cord (3 or 4 wire)
Connector for above

Bench

| | |
|-------------|--------|
| Sturdilite* | PT-800 |
| Sturdilite* | LS-888 |
| Sturdilite* | BS-862 |
| Sturdilite* | RS-862 |

Risers

| | |
|-----------------|--------------|
| Bud chassis | AC-412 |
| Bud plate | BPA-1520 |
| TRW | 6-150 |
| EFJ | 111-0104-001 |
| Leecraft Tineon | 36EN-2315 |

Wiring

Table 1. Suggested parts. *These are 62½" long. For a 42½" length, use PT-700, BS-742, and RS-742. Manufacturer is Angle Steel Division, Kewaunee Scientific Corporation, Plainwell MI 49080.

power is available, simply jumper the two blocks in the terminal strip. Roughly half of the outlets are connected to the red side of the 220 V ac line and the remaining outlets are connected to the black side. The main power switch shuts off everything except one outlet on the back of the right riser (for lamps and clocks). This is an important safety feature, so make sure others in your household know about it.

Wires are routed around the edges of the risers, mostly for neatness (Fig. 2). The ground fault indicator is a neon lamp connected between the ground and neutral, and will light up if either becomes hot. All ground posts are connected by a common number 12 green wire, as is one

outlet in each box. The bench frame is grounded to each riser by wires running through the table top to the inside of the risers.

Finishing-up

By now you will need to clean the Formica™ top and vacuum debris out of the risers. Check out the wiring, first with an ohmmeter and then with 110 V ac. Place your power supplies on the back shelf and check their outputs. (Rubber feet on the power supplies will go a long way toward preventing them from making the bench hum.) Install the covers on the risers, put the bench in place, and adjust the feet to level the bench, if necessary. A swivel bar stool makes a nice lab stool! ■

Left riser, front
Switches for power supplies (4)
Switch for outlet
Dual outlet (top switched)
Ground posts (2)

Left riser, rear
Dual outlets for power supplies, individually switched (2)
Cable clamp, dc entrance

Right riser, front
Power on/off
220 V ac outlet on/off
Ground fault indicator
Switch for outlet
Dual outlet (top switched)
Ground posts (2)

Right riser, rear
Dual outlet, unswitched (for lamp and clock)
Cable clamp, power cord
Ground post

Table 2. Functions in the risers.

QUALITY and SERVICE SAME DAY SHIPMENT

TRANSISTORS, ETC.

| type | case | VCE | Ic | PD | Ft | HEP# | each | ten | |
|---------|-----------|--------|-------|-------------|--------|----------------|-------|--------|--------|
| MPS1010 | 18N | T092 | 40V | .1A | .3W | 50MHz | 724 | \$1.40 | \$3.50 |
| MPS1052 | PNP | T0202 | 40 | 1.5 | 1.0 | 150 | 53031 | .30 | 2.50 |
| MPS1056 | PNP | | 60 | 1.0 | 5.0 | 50 | | .35 | 3.00 |
| MPS1055 | PNP | T092 | 60 | .5 | 5.0 | 50 | 708 | .25 | 2.00 |
| 2N2222 | SCR | T0-5 | 25V | 1 AMP | .2ma | gate | | .30 | 2.50 |
| 2N2224 | SCR | T0-5 | 100 | 1 AMP | .02ma | | | .40 | 3.50 |
| 2N2225 | SCR | T0-5 | 150 | 1 AMP | .2ma | | | .45 | 4.00 |
| 2N2907 | PNP | T018 | 40 | .6 | .4 | 200 | 52 | .35 | 3.00 |
| 2N3440 | PNP | T0-5* | 250 | 1.0 | 10.0 | 50 | 53021 | .60 | 5.00 |
| 2N3565 | PNP | T0106* | 30 | .2 | .3 | 40 | 55 | .15 | 1.00 |
| 2N3639 | PNP | T092 | 12 | .1 | .2 | 350 | 67 | .20 | 1.50 |
| 2N3640 | PNP | T0106* | 15 | .2 | .2 | 400 | 67 | .15 | 1.00 |
| 2N3646 | PNP | T0106* | 15 | .2 | .2 | 400 | 50 | .15 | 1.00 |
| 2N3704 | PNP | T092 | 30 | .8 | .3 | 100 | 735 | .40 | 3.50 |
| 2N3903 | PNP | T092 | 40 | .2 | .3 | 300 | 736 | .20 | 1.50 |
| 2N3904 | PNP | T092 | 40 | .2 | .3 | 300 | 736 | .20 | 1.50 |
| 2N4248 | PNP | T092 | 40 | .1 | .2 | 40 | 715 | .15 | 1.00 |
| 2N4250 | PNP | T092 | 40 | .1 | .2 | 50 | 57 | .25 | 2.00 |
| 2N4400 | PNP | T092 | 40 | .2 | .3 | 200 | 736 | .15 | 1.00 |
| 2N4437 | PNP | T0106 | 30 | .5 | .2 | 250 | 736 | .20 | 1.50 |
| 2N5138 | PNP | T0106 | 30 | .1 | .2 | 30 | 52 | .20 | 1.50 |
| 2N5172 | PNP | T092 | 25 | .1 | .2 | 120 | 56 | .25 | 2.00 |
| 2N5210 | PNP | T092 | 50 | .05 | .3 | 80 | 728 | .30 | 2.50 |
| 2N5910 | PNP | T0106 | 20 | .1 | .3 | 700 | 52 | .30 | 2.50 |
| 2N5964 | PNP | T092 | 150 | .1 | .5 | 100 | 50025 | .25 | 2.00 |
| 016P1 | PNP | T098 | 12 | (high gain) | 10-pwr | DARL. | | .20 | 1.50 |
| D40C1 | PNP | T0206* | 30 | .5 | 6 | DARLINGTON | | .30 | 2.50 |
| D4101 | PNP | T0220 | 30 | 1.0 | 6 | 150 | 53027 | .35 | 3.00 |
| D448B | PNP | T0220 | 60 | 10.0 | 50 | | | .50 | 4.50 |
| RCA105 | PNP | T0220 | | | | | | .35 | 3.00 |
| MJE1091 | " | T0220 | 60 | 5.0 | 70 | PWR DARLINGTON | | 1.25 | 10.00 |
| MJE1100 | PNP | T0220 | 60 | 5.0 | 70 | PWR DARLINGTON | | 1.25 | 10.00 |
| TIP31A | PNP | T0220* | 60 | 3.0 | 40W | | | .40 | 3.50 |
| 2N6101 | PNP | T0220 | 80 | 10.0 | 75 | | | .60 | 6.00 |
| 2N4304 | N CHANNEL | FET | T0106 | CASE | sim. | HEP#02 | | .35 | 3.00 |
| 40327 | PNP | T0-5 | 300 | 1.A | 5W | | | .40 | 3.50 |

SPECIALS

| | | |
|----------------------------------|---|--------|
| uA776 | programmable operation amplifier | \$1.00 |
| F706BEC | Fairchild 5W audio pwr. amp. | |
| 14 pin DIP w/ integral heat sink | | 1.25 |
| AM-1 | Motorola MPC6070 1W audio amp (mini) | .40 |
| IM386 | low voltage audio pwr. amp. (mini) | 1.00 |
| MM5058 | 1024 bit static shift register (mini) | 1.50 |
| 2504T | Sig. dyn. 1024 bit shift (TO-99) | .75 |
| 747 | dual 741 operational amplifier DIP | .50 |
| 723 | 0-40V precision variable regulator DIP | .50 |
| CD4011 | CMOS gate | .19 |
| CD4025 | CMOS gate | .19 |
| MC1303 | stereo preamp (DIP) | 1.00 |
| LC1412 | Leads 12V 3A reg. (pulled out of computer board sockets) full spec. devices | 3.95 |
| 7402 | quad two input TTL NOR gate (DIP) | .12 |
| 7430 | eight input NAND gate (DIP) | .13 |
| 7492 | divide by twelve counter (DIP) | .30 |

TRANSISTOR BONANZA
\$6 per 100 - \$50 per 1000

PRIME TO-18 PLASTIC TRANSISTORS FROM A MAJOR SEMI HOUSE. THESE ARE FIRST GRADE DEVICES WITH CUT AND FORMED LEADS AND MARKED WITH A HOUSE NUMBER. THESE ARE NOT BARREL RECTIFIERS... PNP AND NPN AVAILABLE WE WILL SHIP 50/50 ON ANY MIX WITH 50 PENCE PER TYPE MINIMUM.

COUNTER DISPLAY KIT
Ideal module for home built counter projects. Includes 7490 decade counter 7475 latch, 7447 driver, and RCA 4" MONITOR display. PCB with plated thru holes and instructions supplied. KIT SUPPLIED FROM ONE TO TEN DIGITS PER BOARD (all interconnects plated).

\$5.89 per digit

DIP TRIMMER
12 TURN 1/4" 5K or 200K only mfg. DALE

\$1.50 TEN FOR \$4

ZERO CROSSING SWITCH
A.C. powered 14 pin DIP IC used to trigger TRIAC devices... RCA CA3079

60¢ea \$5-ten

1/2 WATT RESISTORS
39 ea. - 350, 150, 150, 6.8k, 11k 43k, 68k, 200k - 5 percent tol.

80 for \$4

BISTABLE RELAY
SPST W/DC 200 ohm coils 1 amp, 20 watt PC contacts Long life (1x10E4) oper. High speed (500 Hz) Hermetically sealed 3/16" x 1/2"

\$2.95 ea

OPTO ISOLATOR
FCD820 6PIN DIP WILL DRIVE A TTL GATE WITH TEN MA LED CURRENT

69¢ea ten \$6

Ge or Si SIGNAL DIODES
High quality, marked computer grade signal diodes. Leads trimmed for PCB mounting....

40 for \$2

POTTER BRUMFIELD
Type 100 relay 4 pin 1/2 contacts 12VDC 100mA

\$1.60 ea.

VARO SEMICONDUCTOR
EPOXY BRIDGE RECTIFIERS 10 AMP 50V VJ048

.90 ea. 10 for \$7.50 100-\$65

SUPER LED's
HIGH POWER LED's (2 AMPS MAX. 25A PEAK PULSE), TO-5 BASE W/6-32 STUD.

ME2 infra red w/low lens
ME5 infra red w/hi lens
M74 red w/low lens
M74H red w/high lens

\$4.95

ELEC-TROL 12 vdc REED RELAY
440 ohm coil
dpst n.o.

1.1"

PICTURE IS APPROXIMATION, RELAY HAS FOUR PINS ON ONE END AND TWO ON OTHER. PINS ARE SPACED .1" X 1". 1/2A CONTACTS.

direct LINE (916) 334 2161

TOLL-FREE TELEPHONE SERVICE

24 HOURS A DAY \$15 minimum order
7 DAYS A WEEK

DIAL: 800 423 2355 EXT 307

PHONE ORDERS CAN ONLY BE CHARGED TO MASTERCARD OR VISA/BANKAMERICARD

BABYLON ELECTRONICS BOX 41778 4811 MYRTLE SACRAMENTO, CA 95841

\$5 minimum order, add \$1 handling for orders under \$10. We pay 1st class or UPS on domestic orders for more than \$10. BAC, VISA, and MC accepted, shipping added.

NEW

Top-of-the-line performance for today's crowded HF bands



RTTY
FSK-1000 Demodulator

In the past, the serious hf dx-er had to spend over 500 dollars to attain this level of performance.

- State-of-the-art computer-aided design
- Unparalleled selectivity from selectable-bandwidth filters
- True limiterless operation over wide dynamic range
- Independent active detection for diversity operation
- Sophisticated decision level correction circuitry automatically maintains copy during selective fading
- FSK or mark-only autostart with selectable attack and threshold adjust
- ΔF precision shift tuning
- Quality components in rugged extruded aluminum enclosure

Now, the FSK-1000 demodulator will offer these features and more.

Introductory Price
Write for complete specifications.

IRL 127 **\$397 FOB**

2686 SOUTHRIDGE DR. COLUMBUS, OH 43224

Write for CATALOG
CRAMMED WITH GOV'T SURPLUS ELECTRONIC GEAR SEND 50¢ FOR HANDLING

ARC-5 TRANSMITTER
With all tubes & crystal brand new in original carton

\$12.95
(See 73 Magazine Sept. issue page 128 for conversion "The ARC Tuner")

AN/ART-13 TRANSMITTER
Makes a fine ham transmitter for 80, 40, 20 and 10 meters. 100 Watts output on AM, CW, & MCW. With all tubes... like new \$39.50

Terms: F.O.B. NYC. 25% deposit with order, balance COD or remittance in full. Subject to prior sale and price change.

G & G RADIO ELECTRONICS COMPANY 45-47 Warren St. (2nd floor) New York, N.Y. 10007

CTL-B Pat. 3,757,045



CTL-B-----\$39.00
BTL-A-----33.00
UTL-A-----25.00
ST- A-----18.00

Please Include Postage

Send For Free Descriptive Folder

B37

BROWN BROS. MACHINE CO.
5370 Southwest Ave. St. Louis, MO 63139

NEW ELECTRONIC PARTS

Brand name, first line components. Stocked in depth. 24 hour delivery. Low prices and money back guarantee on all products we carry.

STAMP BRINGS CATALOG

SPECIALS

KEYBOARD ENCLOSURES

| SIX SIZES | W | D | H | PRICE |
|-----------|-------|----|---|---------|
| 14" | 8.3" | 3" | | \$15.20 |
| 17" | 8.3" | 3" | | 18.35 |
| 20" | 8.3" | 3" | | 19.25 |
| 14" | 11.3" | 3" | | 16.50 |
| 17" | 11.3" | 3" | | 18.80 |
| 20" | 11.3" | 3" | | 20.75 |

Blue base, specify white or black top.

MAGNA-LITE JR ONLY \$5.79



RTTY
UT4 SPEED CVTR BOARD KIT \$109.95
BOARD ALONE \$18.95
AUTO CW ID KIT \$37.90

SHIPPING INCLUDED IN PRICE

Daytapro Electronics, Inc.
Formerly NuData Electronics D35
3029 N. WILSHIRE LN., ARLINGTON HTS. ILL. 60004
PHONE 312-870 0555

SEASON'S GREETINGS from 73

**GIVE 73 AT CHRISTMAS
and
take your pick of one of these
great books. . . our gift to you. . .**

Give a gift subscription to **73 Magazine** this year and receive from **73 Magazine** your choice of one of the two best selling books in the amateur radio field . . . **FREE** . . . our gift to you. Keep the book yourself or give it as a gift.

● **VOLUME IV—IC TEST EQUIPMENT**—it's easy and fun to build your own test equipment with ICs! Here in this fourth volume of the **73 TEST EQUIPMENT LIBRARY** are 42 home construction projects for building test equipment to work with your ham station and in servicing digital equipment. Counters, scalars, frequency standards, synthesizers, logic probes . . . **JUST ABOUT EVERYTHING** you need and can build with ICs.



● **WEATHER SATELLITE HANDBOOK**—Simple equipment and methods for getting good pictures from the weather satellite. Antennas, receivers, monitors, facsimile you can build, tracking, automatic control (you don't even have to be home). Dr. Taggart WB8DQT.

Just \$18 will buy a year's subscription for a friend and you receive a free book. Hurry! Send no money now, we'll bill you later. Your book will be sent after the "bill me" is paid.

73 Magazine will send a personalized Christmas card with your name to the lucky person receiving the subscription, and we'll send you the book of your choice. Be sure to order right away to assure the arrival of the first issue before St. Nick!

73 magazine
PETERBOROUGH NH 03458

"THE PROFESSIONALS"

NEW MODEL CTR-2A • 500 MHz & 1 GHz **COUNTERS**

NEW
Period
Measurement



NEW
Built-in
Pre-Amp

1 us to
1 sec.

10 mv @
150 MHz

The New Model CTR-2A Series Counters are designed and built to the highest standards to fulfill the needs of commercial communications, engineering labs and serious experimenters. With an accuracy of + .00005% (oven option) the CTR-2A can handle the most critical measurements and is about half the cost of other commercial counters.

If you need a reliable counter at an affordable price, the CTR-2A is the answer.

- Built-in Pre-Amp 10 mv @ 150 MHz
- 8 Digit .3" LED Display
- High Stability TCXO Time Base
- Built-in VHF-UHF Prescaler
- Automatic Dp Placement
- TCXO Std. ± 2 ppm
- Period Measurement (Optional)
- Input Diode Protected
- 12V-DC Operation (Optional)
- Oven Controlled Crystal (Optional) ± .5 ppm
- Selectable Gate Times - .1 & 1 sec.

| | |
|-------------------------------|----------|
| 500 MHz Kit CTR-2A-500K | \$249.95 |
| 500 MHz Assembled CTR-2A-500A | 349.95 |
| 1GHz Kit CTR-2A-1000K | 399.95 |
| 1GHz Assembled CTR-2A-1000A | 549.95 |

| | | | |
|------------------|---------|-----------------------|---------|
| OPTIONS | | | |
| 02) Oven Crystal | \$49.95 | 05) 10 sec. Time Base | \$ 5.00 |
| 03) .43" LED | 10.00 | 06) Period | 15.00 |
| 04) 12 V-DC | 10.00 | 07) Handle | 10.00 |

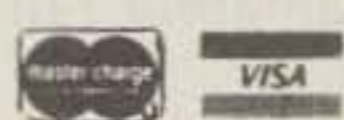

DAVIS ELECTRONICS 636 Sheridan Dr., Tonawanda, N.Y. 14150 716/874-5848

PROBES
Hi-Z
\$15.00
•
Low Pass
\$15.00

Jim DeNinno wants your name for his mailing list and is offering Three Super Specials to Get It!

3.95 BUYS ALL OF THIS Old & Rare Coins

- 1 Old Indian Head Cent
- 1 V Liberty Nickel
- 1 Buffalo Nickel
- 1 Large Cent eng.
- 1 1943 WWII Cent
- 1 Cent 1920 or Older
- 1 Wooden Nickel
- 1 D Mint Cent 25 years
- 1 5 Cent 25 years
- 1 1968 5 Penny unc.
- 1 1960 D Small Date

OR 3.95 BUYS THESE TWO RARE UNCIRCULATED COINS

The mint made a mistake but we didn't. Now is your chance to take advantage of their mistake.



OR 6.95 BUYS EVERYTHING IN BOTH OF THE ABOVE SPECIALS

- With Every Offer you Receive
- 1 Free Tax 5 Bill
 - More Free Coins
 - Or Free Brochures
- PLUS Add 1.25 for Package

JIM De NINNO & CO. ✓ D39

Source: Price Sheet, Department Store, Columbus, Pa. 18808 (717) 864-0302

125 KHZ TO 1000 MHZ ✓ F1 FREQUENCY METER

FR-149/USM-159 TRANSISTORIZED FREQUENCY METER



Covers 125 KHz to 1000 Mhz in three bands: 125 KHz-2.5 Mhz, 2.5-65 Mhz, and 65 to 1000 Mhz. Frequency fundamentals read from magnified, illuminated film strip. Unknown freq.

then identified using accompanying calibration book. Operates from either six "D" cell batteries or from 115/230 VAC 50-450 Hz. Size: 11 1/4 x 11 1/2 x 13". Sh. Wt.: 33 lbs. Used, repairable: **\$99.50** — Checked: **\$150.** MANUAL, partial reproduction: **\$10.00**

SG-12/URM-48 FM SIGNAL GENERATOR — 20-100 Mhz in five Bands, 85 lbs. Sh. Wt. - Used, Repairable: **\$165.00** — Checked: **\$235.00**

SG-3/URM-70 FM SIGNAL GENERATOR — 50-400 Mhz in three Bands, 90 lbs. Sh. Wt. - Used, Repairable: **\$225.00** — Checked: **\$295.00**

Note: Items over 50 lbs. shipped motor freight collect! All Prices F.O.B. Lima, Ohio. Please Allow for Shipping. Use your VISA or Mastercharge cards. Write for our Free WS-78 catalog and supplement. Address Dept. 73 • Phone 419/227-6573

FAIR RADIO SALES

1016 E. EUREKA • Box 1105 • LIMA, OHIO • 45802

DIP RELAY
SPST 5 vDC coil. Contacts 10 VA at 5A \$1.00 ea.



8 CONDUCTOR CORD
6 1/2 feet long, extra flexible with strain relief at one end. 3/32 OD. 50¢ ea., 10/\$4.00

COMPUTER GRADE LYTICS
1000 Mfd 50 vDC \$.85
2000 Mfd 50 vDC 1.25
8000 Mfd 25 vDC \$2.25
23000 Mfd 15 vDC 2.50



MOLEX IC SOCKET PINS
80¢/100 \$7.50/1000

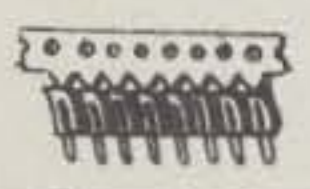

All merchandise 100% guaranteed. Please include postage with your order. Write for FREE Catalogue. **CHICAGOLAND** - Our Store Open Daily at 10:00 A.M.

R.W. ELECTRONICS, INC.
✓ R18 3203 North Western Avenue
Chicago, Illinois 60618
312-248-2480

electronic calculators

| LIST | HAM NET | TEXAS INSTRUMENTS ELECTRONIC CALCULATORS |
|----------|--|--|
| \$299.95 | \$269.95 | T.I.-59, 960 STEP PROGRAMMABLE SCIENTIFIC |
| 124.95 | 112.45 | T.I.-58, 480 STEP PROGRAMMABLE SCIENTIFIC |
| 59.95 | 53.95 | T.I.-57, 150 STEP PROGRAMMABLE SCIENTIFIC |
| 49.95 | 44.95 | T.I.-55, 32 STEP PROGRAMMABLE SCIENTIFIC |
| 59.95 | 53.95 | T.I. PROGRAMMER, CONVERTS DECIMAL/OCTAL/HEX |
| 69.95 | 62.95 | T.I. MBA, 5 TH POWER PROGRAMMED FINANCIAL |
| LIST | HEWLETT-PACKARD ELECTRONIC CALCULATORS | |
| \$750.00 | \$675.00 | H.P.-97, 224 STEP PROG SCIENTIFIC PRINT/VISUAL |
| 450.00 | 405.00 | H.P.-67, 224 STEP PROG SCIENTIFIC |
| 275.00 | 247.50 | H.P.-19C, 98 STEP PROG SCIENTIFIC PRINT/VISUAL |
| 175.00 | 157.50 | H.P.-29C, 98 STEP PROG SCIENTIFIC |
| 175.00 | 157.50 | H.P.-10 BASIC HAND HELD PRINTER/VISUAL |
| 325.00 | 292.50 | H.P.-91, PREPROGRAMMED SCIENTIFIC PRINT/VISUAL |
| 100.00 | 90.00 | H.P.-33E, 49 STEP PROG SCIENTIFIC |
| 80.00 | 72.00 | H.P.-32E, PREPROGRAMMED SCIENTIFIC WITH STAT |
| 60.00 | 54.00 | H.P.-31E, PREPROGRAMMED SCIENTIFIC |
| 495.00 | 445.50 | H.P.-92, PREPROGRAMMED FINANCIAL PRINT/VISUAL |
| 120.00 | 108.00 | H.P.-38E STEP PROGRAMMABLE SUPER FINANCIAL |
| 75.00 | 67.50 | H.P.-37E, PREPROGRAMMED FINANCIAL |

WE STOCK ALL HEWLETT-PACKARD CALCULATOR SOFTWARE AND ACCESSORIES

SEND ME THE CALCULATOR(S) INDICATED BELOW COMPLETE WITH INCLUDED ACCESSORIES, INSTRUCTIONS, AND MANUFACTURERS WARRANTY. I UNDERSTAND THAT IF I AM NOT COMPLETELY SATISFIED, I MAY RETURN IT WITHIN 10 DAYS FOR A COMPLETE REFUND (LESS SHIPPING)

MODEL(S) _____ QUANTITY _____ AMOUNT ENCLOSED \$ _____

WE HONOR _____ VISA _____ MASTERCARD _____ MONEY ORDERS _____ COD _____

ADD \$2.00 FOR POSTAGE AND HANDLING. PLEASE ALLOW 10 DAYS FROM DATE OF RECEIPT OF ORDER FOR DELIVERY. TEXAS RESIDENTS ADD 5% SALES TAX.

CARD NUMBER _____ EXPIRATION DATE _____

FULL NAME _____ CALL _____

STREET _____ CITY _____ STATE _____ ZIP _____

MORE LITERATURE MODEL(S) _____

*****DEALER INQUIRIES INVITED*****



MAIL TO: 6810 LARKWOOD
HOUSTON, TEX 77074
ATTN: STEVE, WA5OEN
PHONE: A.C. (713) 777-2673

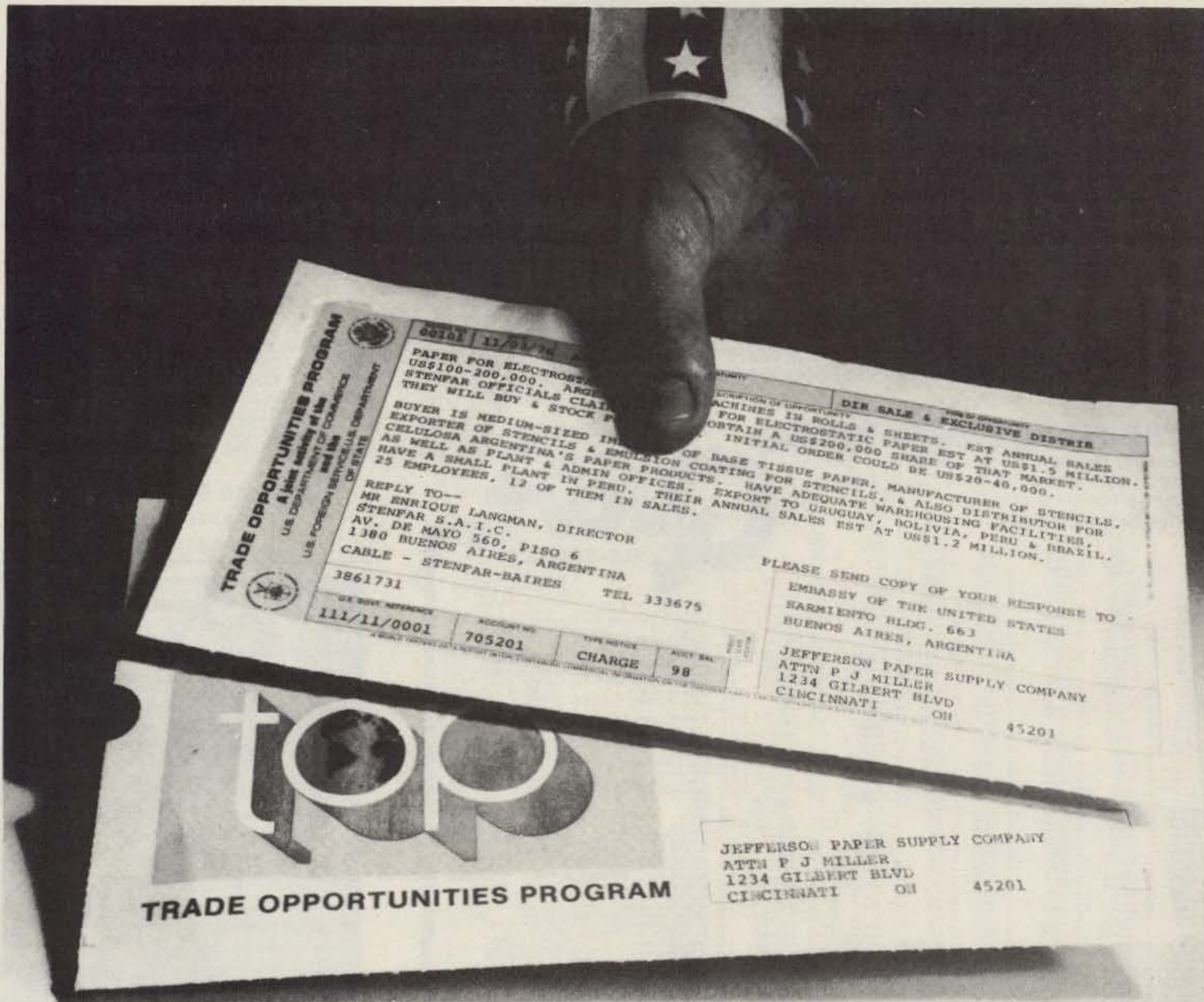

**To get overseas trade leads like this,
you could open offices in 127 countries.**

Or use our computer.

The U.S. Commerce Department's computer-operated Trade Opportunities Program (TOP) can supply you with immediate, continuing, specific leads tailored to your sales objectives for any of 127 countries. So if you can't be all over the world at one time, we've got the answer. Send us the coupon now and see how you can find where the live leads are living.

Secretary of Commerce
U.S. Department of Commerce, BIC-9A
Washington, D.C. 20230

Please tell me more about the Trade Opportunities Program (TOP).

Name

Title

Company

Address

City State Zip



A Public Service of This Magazine & The Advertising Council

JUST GETTING ON THE AIR? See Adirondack for



- New Equipment
- Used Gear
- Friendly Advice

ADIRONDACK Radio Supply

185-191 West Main Street • P.O. Box 88
Amsterdam, N.Y. 12010 Tel. (518) 842-8350
Just 5 minutes from N.Y. Thruway - Exit 27

P.O. Box 4430M Santa Clara, CA 95054

For will call only: (408) 988-1640

2322 Walsh Ave.

Quest

ELECTRONICS

Same day shipment. First line parts only. Factory tested. Guaranteed money back. Quality IC's and other components at factory prices.

INTEGRATED CIRCUITS

| Part No. | Manufacturer | Part No. | Manufacturer | Part No. | Manufacturer |
|----------|--------------|----------|--------------|----------|--------------|
| 74007TL | 74LS24N | 41 | LM340T-15 | 1.10 | |
| 74008 | 74LS24N | 35 | LM340T-18 | 1.10 | |
| 74009 | 74LS24N | 39 | LM340T-24 | 1.10 | |
| 74010 | 74LS24N | 30 | LM340T | 4.90 | |
| 74011 | 74LS24N | 30 | LM370 | 1.15 | |
| 74012 | 74LS24N | 35 | LM377 | 4.50 | |
| 74013 | 74LS24N | 47 | LM3900 | 5.00 | |
| 74014 | 74LS24N | 51 | LM3900N | 1.00 | |
| 74015 | 74LS24N | 51 | LM3900N | 1.00 | |
| 74016 | 74LS24N | 51 | LM3900N | 1.00 | |
| 74017 | 74LS24N | 51 | LM3900N | 1.00 | |
| 74018 | 74LS24N | 51 | LM3900N | 1.00 | |
| 74019 | 74LS24N | 51 | LM3900N | 1.00 | |
| 74020 | 74LS24N | 51 | LM3900N | 1.00 | |
| 74021 | 74LS24N | 51 | LM3900N | 1.00 | |
| 74022 | 74LS24N | 51 | LM3900N | 1.00 | |
| 74023 | 74LS24N | 51 | LM3900N | 1.00 | |
| 74024 | 74LS24N | 51 | LM3900N | 1.00 | |
| 74025 | 74LS24N | 51 | LM3900N | 1.00 | |
| 74026 | 74LS24N | 51 | LM3900N | 1.00 | |
| 74027 | 74LS24N | 51 | LM3900N | 1.00 | |
| 74028 | 74LS24N | 51 | LM3900N | 1.00 | |
| 74029 | 74LS24N | 51 | LM3900N | 1.00 | |
| 74030 | 74LS24N | 51 | LM3900N | 1.00 | |
| 74031 | 74LS24N | 51 | LM3900N | 1.00 | |
| 74032 | 74LS24N | 51 | LM3900N | 1.00 | |
| 74033 | 74LS24N | 51 | LM3900N | 1.00 | |
| 74034 | 74LS24N | 51 | LM3900N | 1.00 | |
| 74035 | 74LS24N | 51 | LM3900N | 1.00 | |
| 74036 | 74LS24N | 51 | LM3900N | 1.00 | |
| 74037 | 74LS24N | 51 | LM3900N | 1.00 | |
| 74038 | 74LS24N | 51 | LM3900N | 1.00 | |
| 74039 | 74LS24N | 51 | LM3900N | 1.00 | |
| 74040 | 74LS24N | 51 | LM3900N | 1.00 | |
| 74041 | 74LS24N | 51 | LM3900N | 1.00 | |
| 74042 | 74LS24N | 51 | LM3900N | 1.00 | |
| 74043 | 74LS24N | 51 | LM3900N | 1.00 | |
| 74044 | 74LS24N | 51 | LM3900N | 1.00 | |
| 74045 | 74LS24N | 51 | LM3900N | 1.00 | |
| 74046 | 74LS24N | 51 | LM3900N | 1.00 | |
| 74047 | 74LS24N | 51 | LM3900N | 1.00 | |
| 74048 | 74LS24N | 51 | LM3900N | 1.00 | |
| 74049 | 74LS24N | 51 | LM3900N | 1.00 | |
| 74050 | 74LS24N | 51 | LM3900N | 1.00 | |
| 74051 | 74LS24N | 51 | LM3900N | 1.00 | |
| 74052 | 74LS24N | 51 | LM3900N | 1.00 | |
| 74053 | 74LS24N | 51 | LM3900N | 1.00 | |
| 74054 | 74LS24N | 51 | LM3900N | 1.00 | |
| 74055 | 74LS24N | 51 | LM3900N | 1.00 | |
| 74056 | 74LS24N | 51 | LM3900N | 1.00 | |
| 74057 | 74LS24N | 51 | LM3900N | 1.00 | |
| 74058 | 74LS24N | 51 | LM3900N | 1.00 | |
| 74059 | 74LS24N | 51 | LM3900N | 1.00 | |
| 74060 | 74LS24N | 51 | LM3900N | 1.00 | |
| 74061 | 74LS24N | 51 | LM3900N | 1.00 | |
| 74062 | 74LS24N | 51 | LM3900N | 1.00 | |
| 74063 | 74LS24N | 51 | LM3900N | 1.00 | |
| 74064 | 74LS24N | 51 | LM3900N | 1.00 | |
| 74065 | 74LS24N | 51 | LM3900N | 1.00 | |
| 74066 | 74LS24N | 51 | LM3900N | 1.00 | |
| 74067 | 74LS24N | 51 | LM3900N | 1.00 | |
| 74068 | 74LS24N | 51 | LM3900N | 1.00 | |
| 74069 | 74LS24N | 51 | LM3900N | 1.00 | |
| 74070 | 74LS24N | 51 | LM3900N | 1.00 | |
| 74071 | 74LS24N | 51 | LM3900N | 1.00 | |
| 74072 | 74LS24N | 51 | LM3900N | 1.00 | |
| 74073 | 74LS24N | 51 | LM3900N | 1.00 | |
| 74074 | 74LS24N | 51 | LM3900N | 1.00 | |
| 74075 | 74LS24N | 51 | LM3900N | 1.00 | |
| 74076 | 74LS24N | 51 | LM3900N | 1.00 | |
| 74077 | 74LS24N | 51 | LM3900N | 1.00 | |
| 74078 | 74LS24N | 51 | LM3900N | 1.00 | |
| 74079 | 74LS24N | 51 | LM3900N | 1.00 | |
| 74080 | 74LS24N | 51 | LM3900N | 1.00 | |
| 74081 | 74LS24N | 51 | LM3900N | 1.00 | |
| 74082 | 74LS24N | 51 | LM3900N | 1.00 | |
| 74083 | 74LS24N | 51 | LM3900N | 1.00 | |
| 74084 | 74LS24N | 51 | LM3900N | 1.00 | |
| 74085 | 74LS24N | 51 | LM3900N | 1.00 | |
| 74086 | 74LS24N | 51 | LM3900N | 1.00 | |
| 74087 | 74LS24N | 51 | LM3900N | 1.00 | |
| 74088 | 74LS24N | 51 | LM3900N | 1.00 | |
| 74089 | 74LS24N | 51 | LM3900N | 1.00 | |
| 74090 | 74LS24N | 51 | LM3900N | 1.00 | |
| 74091 | 74LS24N | 51 | LM3900N | 1.00 | |
| 74092 | 74LS24N | 51 | LM3900N | 1.00 | |
| 74093 | 74LS24N | 51 | LM3900N | 1.00 | |
| 74094 | 74LS24N | 51 | LM3900N | 1.00 | |
| 74095 | 74LS24N | 51 | LM3900N | 1.00 | |
| 74096 | 74LS24N | 51 | LM3900N | 1.00 | |
| 74097 | 74LS24N | 51 | LM3900N | 1.00 | |
| 74098 | 74LS24N | 51 | LM3900N | 1.00 | |
| 74099 | 74LS24N | 51 | LM3900N | 1.00 | |
| 74100 | 74LS24N | 51 | LM3900N | 1.00 | |

SPECIAL PRODUCTS

| | | | | | |
|-------|---------|----|---------|------|--|
| 74101 | 74LS24N | 51 | LM3900N | 1.00 | |
| 74102 | 74LS24N | 51 | LM3900N | 1.00 | |
| 74103 | 74LS24N | 51 | LM3900N | 1.00 | |
| 74104 | 74LS24N | 51 | LM3900N | 1.00 | |
| 74105 | 74LS24N | 51 | LM3900N | 1.00 | |
| 74106 | 74LS24N | 51 | LM3900N | 1.00 | |
| 74107 | 74LS24N | 51 | LM3900N | 1.00 | |
| 74108 | 74LS24N | 51 | LM3900N | 1.00 | |
| 74109 | 74LS24N | 51 | LM3900N | 1.00 | |
| 74110 | 74LS24N | 51 | LM3900N | 1.00 | |
| 74111 | 74LS24N | 51 | LM3900N | 1.00 | |
| 74112 | 74LS24N | 51 | LM3900N | 1.00 | |
| 74113 | 74LS24N | 51 | LM3900N | 1.00 | |
| 74114 | 74LS24N | 51 | LM3900N | 1.00 | |
| 74115 | 74LS24N | 51 | LM3900N | 1.00 | |
| 74116 | 74LS24N | 51 | LM3900N | 1.00 | |
| 74117 | 74LS24N | 51 | LM3900N | 1.00 | |
| 74118 | 74LS24N | 51 | LM3900N | 1.00 | |
| 74119 | 74LS24N | 51 | LM3900N | 1.00 | |
| 74120 | 74LS24N | 51 | LM3900N | 1.00 | |
| 74121 | 74LS24N | 51 | LM3900N | 1.00 | |
| 74122 | 74LS24N | 51 | LM3900N | 1.00 | |
| 74123 | 74LS24N | 51 | LM3900N | 1.00 | |
| 74124 | 74LS24N | 51 | LM3900N | 1.00 | |
| 74125 | 74LS24N | 51 | LM3900N | 1.00 | |
| 74126 | 74LS24N | 51 | LM3900N | 1.00 | |
| 74127 | 74LS24N | 51 | LM3900N | 1.00 | |
| 74128 | 74LS24N | 51 | LM3900N | 1.00 | |
| 74129 | 74LS24N | 51 | LM3900N | 1.00 | |
| 74130 | 74LS24N | 51 | LM3900N | 1.00 | |
| 74131 | 74LS24N | 51 | LM3900N | 1.00 | |
| 74132 | 74LS24N | 51 | LM3900N | 1.00 | |
| 74133 | 74LS24N | 51 | LM3900N | 1.00 | |
| 74134 | 74LS24N | 51 | LM3900N | 1.00 | |
| 74135 | 74LS24N | 51 | LM3900N | 1.00 | |
| 74136 | 74LS24N | 51 | LM3900N | 1.00 | |
| 74137 | 74LS24N | 51 | LM3900N | 1.00 | |
| 74138 | 74LS24N | 51 | LM3900N | 1.00 | |
| 74139 | 74LS24N | 51 | LM3900N | 1.00 | |
| 74140 | 74LS24N | 51 | LM3900N | 1.00 | |
| 74141 | 74LS24N | 51 | LM3900N | 1.00 | |
| 74142 | 74LS24N | 51 | LM3900N | 1.00 | |
| 74143 | 74LS24N | 51 | LM3900N | 1.00 | |
| 74144 | 74LS24N | 51 | LM3900N | 1.00 | |
| 74145 | 74LS24N | 51 | LM3900N | 1.00 | |
| 74146 | 74LS24N | 51 | LM3900N | 1.00 | |
| 74147 | 74LS24N | 51 | LM3900N | 1.00 | |
| 74148 | 74LS24N | 51 | LM3900N | 1.00 | |
| 74149 | 74LS24N | 51 | LM3900N | 1.00 | |
| 74150 | 74LS24N | 51 | LM3900N | 1.00 | |
| 74151 | 74LS24N | 51 | LM3900N | 1.00 | |
| 74152 | 74LS24N | 51 | LM3900N | 1.00 | |
| 74153 | 74LS24N | 51 | LM3900N | 1.00 | |
| 74154 | 74LS24N | 51 | LM3900N | 1.00 | |
| 74155 | 74LS24N | 51 | LM3900N | 1.00 | |
| 74156 | 74LS24N | 51 | LM3900N | 1.00 | |
| 74157 | 74LS24N | 51 | LM3900N | 1.00 | |
| 74158 | 74LS24N | 51 | LM3900N | 1.00 | |
| 74159 | 74LS24N | 51 | LM3900N | 1.00 | |
| 74160 | 74LS24N | 51 | LM3900N | 1.00 | |
| 74161 | 74LS24N | 51 | LM3900N | 1.00 | |
| 74162 | 74LS24N | 51 | LM3900N | 1.00 | |
| 74163 | 74LS24N | 51 | LM3900N | 1.00 | |
| 74164 | 74LS24N | 51 | LM3900N | 1.00 | |
| 74165 | 74LS24N | 51 | LM3900N | 1.00 | |
| 74166 | 74LS24N | 51 | LM3900N | 1.00 | |
| 74167 | 74LS24N | 51 | LM3900N | 1.00 | |
| 74168 | 74LS24N | 51 | LM3900N | 1.00 | |
| 74169 | 74LS24N | 51 | LM3900N | 1.00 | |
| 74170 | 74LS24N | 51 | LM3900N | 1.00 | |
| 74171 | 74LS24N | 51 | LM3900N | 1.00 | |
| 74172 | 74LS24N | 51 | LM3900N | 1.00 | |
| 74173 | 74LS24N | 51 | LM3900N | 1.00 | |
| 74174 | 74LS24N | 51 | LM3900N | 1.00 | |
| 74175 | 74LS24N | 51 | LM3900N | 1.00 | |
| 74176 | 74LS24N | 51 | LM3900N | 1.00 | |
| 74177 | 74LS24N | 51 | LM3900N | 1.00 | |
| 74178 | 74LS24N | 51 | LM3900N | 1.00 | |
| 74179 | 74LS24N | 51 | LM3900N | 1.00 | |
| 74180 | 74LS24N | 51 | LM3900N | 1.00 | |
| 74181 | 74LS24N | 51 | LM3900N | 1.00 | |
| 74182 | 74LS24N | 51 | LM3900N | 1.00 | |
| 74183 | 74LS24N | 51 | LM3900N | 1.00 | |



GALLIUM PHOSPHIDE L.E.D.
Provides Higher Intensity Than Regular LED's; T1-3/4 Dome (Red Diffused) AND Part #114R 1-99... 22¢ 100+... 20¢ We stock the full line of AND L.E.D.'s



EXTRUDED HEAT SINK
O.D. 10 7/8" by 2 1/4" by 5/8"
Some may have pre-drilled holes \$1.49 ea.

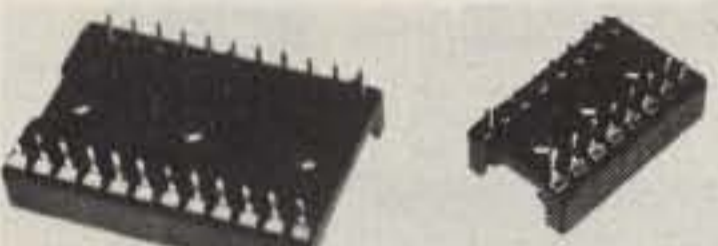

DIP SOCKET SPECIALS

| | | |
|------------------------------------|------|-----|
| 16 Pin Low Profile Solder Tab | 1-49 | 50+ |
| 18 Pin Standard Height Solder Tab | 20¢ | 15¢ |
| 24 Pin Low Profile Solder Tab | 25¢ | 20¢ |
| 24 Pin Low Profile Solder Tab GOLD | 60¢ | 55¢ |



5 FUNCTION L.C.D. WATCHES FROM NATIONAL SEMICONDUCTOR

- Hours
- Minutes
- Month
- Date
- Seconds

(Gold) Leatherette Band; (Chrome) Metal Band; (Gold) Metal Band; (Chrome) Leatherette Band. \$18.00 Each. Specify Model (Add \$1.00 For Metal Band) **A SPECIAL FACTORY PURCHASE!**



INSTRUMENT/CLOCK CASE KIT Perfect for your opto projects. Solid aluminum construction with real walnut sides. O.D. 5-3/8" by 5-3/8" by 2". \$6.95 ea.



EDGE CARD CONNECTOR
Cinch Jones 10/20 Pins .156 Spacing PC Mount 85¢

M-M Electronic Sales

A division of **united products Corporation**
Corp. Hdqts., 2322 1st Ave., Seattle, Wash. 98121 • (206) 682-5025

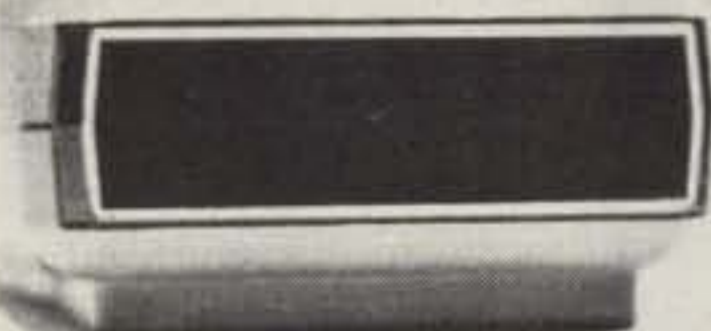

INSTRUMENT/CLOCK CASE KIT A real jewel for those smaller projects. Hinged top door allows you to hide your control area. O.D. 4 1/2" by 4" by 1 1/4". \$1.50 ea.



MULTIPLEXED CALCULATOR KEYBOARD Ideal for the experimenter. Easy-mounting with all terminations accessible. \$1.10.



CLOCK DISPLAY NATIONAL SEMICONDUCTOR 6 digit multiplexed display. 1/2" characters. (Common anode) A real buy at just \$1.00 ea.



TRANSFORMER P-C mount. pri. 110 VAC Sec. 12:6 @ 1 amp. \$1.25 ea.

1/4 WATT SANYO-OHM 5% RESISTORS CARBON FILM All standard EIA values. Multiples of 200 per value only. All non-standard values will be substituted by closest value. \$3.00 per pk. of 200; \$4.00 per pk. of 200 for values 1 Meg. and above.

SPECTRA-STRIP Multi-color ribbon cable #22 stranded. 20 cond. 75¢ a foot... 1-99; 50¢... 100+



36 PIN GOLD-PLATED HEADER Break off to desired length. Has dip spacing. List price \$1.36. Your price 65¢.

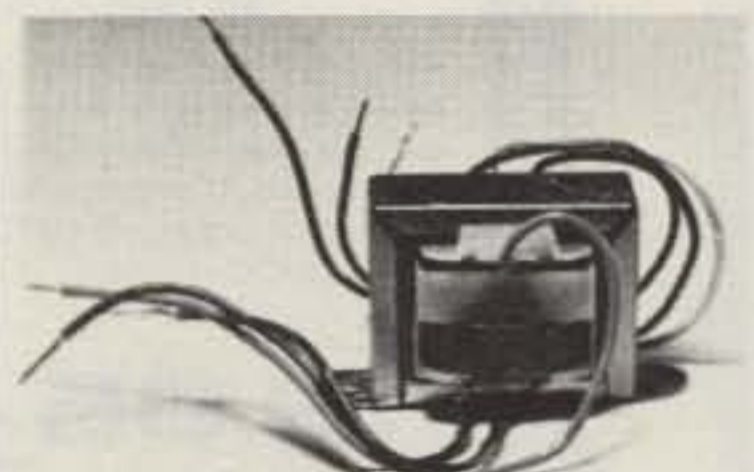

TRANSFORMER Pri. 110 VAC Sec. 11:2 and 5 VCT @ 1 amp. 95¢ ea.

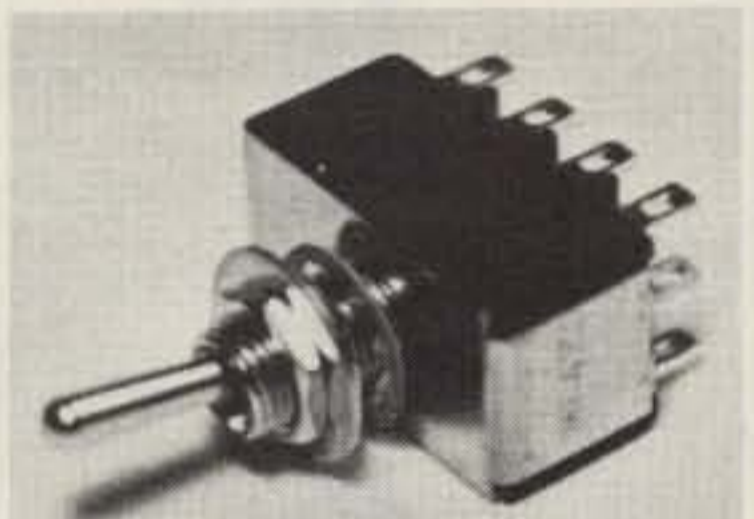

TOGGLE SWITCH J.B.T. #JMT 423, Subminiature 4 P.D.T. 5 amp. @ 125 VAC. LIST PRICE \$5.95. YOUR PRICE \$1.11 ea.

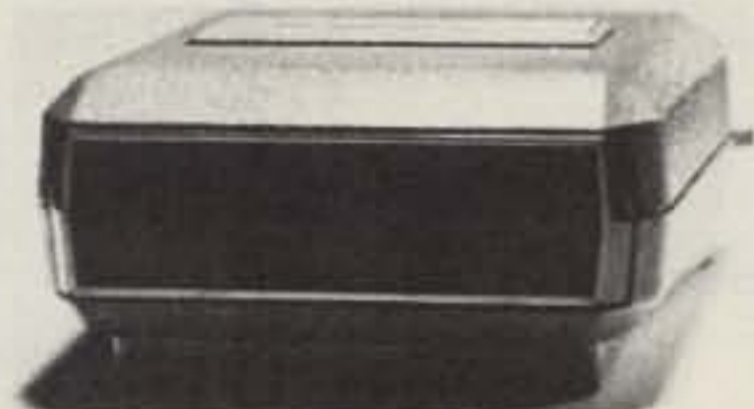

COMPLETE DIGITAL CLOCK

* Line rejects
* Returns
* They don't work right
* They don't do anything
We guarantee them to be defective. (A parts bonanza.)
Our retail store has yet to have a dis-satisfied customer. \$6.00 ea.

For MasterCharge/Visa Orders Use Our TOLL FREE HOT LINE 1-800-426-0634
For Areas Outside Washington (inc. Alaska & Hawaii)



TERMS
All orders shipped promptly. Minimum order \$5.00. Telephone orders accepted. All orders shipped U.P.S. or P.P. Add 5% extra for shipping and handling. Washington state residents add additional 5.4% sales tax.

ATTN: PURCHASING AGENTS
Our surplus division is always looking for new sources of inventory. For a prompt reply, send samples, a list or call us at (206) 682-5025.

Store Hours M-F 9-6 • SAT 9-5

O.E.M.'s WELCOME

TOLL FREE HOT LINE 1-800-426-0634
for areas outside Wash. State incl. Alaska and Hawaii

MasterCharge and Visa cards accepted. Money orders and your personal or company check are welcome. Funds made payable in U.S. currency only. No C.O.D. orders. Your satisfaction is guaranteed on all merchandise purchased. All merchandise subject to prior sale. Open account to govt. agencies and publicly funded schools.
FREE GIFT TO FIRST 2000 MAIL ORDER CUSTOMERS THIS MONTH.



D-C ADAPTER 22 volt @ 140 ma. Makes an excellent power supply! 95¢ ea.



CAPACITORS

| Capacitance | Voltage | Style | Price |
|-------------|---------|-------|-------|
| 1000uf | 25 VDC | P-C | 25¢ |
| 220uf | 25 VDC | P-C | 25¢ |
| 2000uf | 25 VDC | AXIAL | 50¢ |
| 40/40 | 150 VDC | AXIAL | 45¢ |
| 1uf | 15 VDC | AXIAL | 19¢ |

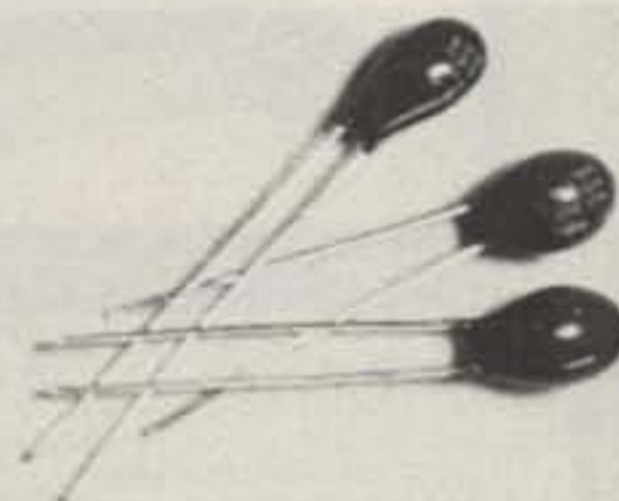

DIPPED TANTALUMS

| Capacitance | Voltage | Tol. % | Price |
|-------------|---------|--------|-------|
| 1uf | 50 V | 20 | 28¢ |
| 2.2uf | 50 V | 20 | 42¢ |
| 4.7uf | 50 V | 20 | 62¢ |
| 22uf | 20 V | 20 | 51¢ |

We stock the full line of MICONICS dipped tantalums.



DISCRETES

| | | |
|------------|----------------|-----|
| 1N4005 | 600V @ 1A | 20¢ |
| 1N4148 | | 13¢ |
| 1N3754 | | 20¢ |
| 2N3054 | | 95¢ |
| CR13(TO-5) | SCR 25V @ 1.6A | 30¢ |

SELECTED VALUES

| | |
|--|--------|
| Line cord #18ga 6' | 25¢ |
| F.I.F.O. (AMD2841) 64/4bit 16 pin Dip | \$2.00 |
| 10 Turn Trimpot (CTS308) P-C | |
| 100K | 75¢ |
| Coil Cord 2 Cond. 3' ext. | 95¢ |
| L.E.D. Fairchild FLV-118 (clr. red) | 20¢ |
| Acid Brush | 10¢ |
| Telescoping Antenna 3' | \$1.00 |
| Edge Meter 100-0-100 ua. 1/2" x 11/16" | \$2.00 |

#30 KYNAR Blk., Brn., Red., Or., Yel., Grn., Blu., Vio., Gry., Wh. We will do our best to ship the color you specify. To ensure prompt delivery of your order we will substitute colors should we be temp. out, unless you specify otherwise. **\$2.36 per hundred foot spool; \$14.16 per thousand foot spool; Multiples of 100' only.** Call us for quotes on larger quantities.

BULLET ELECTRONICS

✓ B8

P.O. BOX 19442E

DALLAS, TEX. 75219

(214)823-3240

MINI GRANDFATHER CLOCK KIT

- Complete Electronics!
- Chimes the hour (ie: 3 times for 3 O'clock)
 - Unique "swinging" LED pendulum
 - Tick tock sound matches pendulum swing.
 - Large 4 digit .5" LED readout
 - All CMOS construction
 - Complete electronics including transformer & speaker; drilled and plated PC boards measure 4.5" x 6.5"

39.95

Reviewed
in April
1978 RADIO
ELECTRONICS

BEAUTIFUL SOLID WALNUT

Custom case for above kit. Over 9 3/4" tall. 19.95



NEVER A SWEETER METER!

Beautiful American made panel meters are a snap to install. Huge 3 1/2" wide dials are easy to read. You would expect to pay more for each than we get for the pair! MATCHED SET 0-15VDC, 0-30ADC

12.95 Set

POWER SUPPLY KIT PS-14

- Better than 200MV load and line regulation
- Foldback Current Limiting
- Short Circuit Protected
- Thermal Shutdown
- Adjustable Current Limiting
- Less than 1% ripple.
- 15 amps 11.5 to 14.5V
- All parts supplied including heavy duty transformer.
- Quality plated fiberglass PC board.

Less Case,
meters & jacks
UPS SHIPPING
PAID!

REVIEWED IN 7/78 73 MAG.

15A CONT. 20A INT. 42.95

OVERVOLTAGE PROTECTION KIT 6.95

Provides cheap insurance for your expensive equipment. Trip voltage is adjustable from 3 to 30 volts. Overvoltage instantly fires a 25A SCR and shorts the output to protect equipment. Should be used on units that are fused. Directly compatible with the PS-12 and PS-14. All electronics supplied. Drilled and plated PC board. (Order OVP-1)

MK-05 MINI MOBILE CLOCK

The smallest and best priced mobile clock kit on the market. Designed to be a mobile clock from the ground up. There has been no compromise on quality.

FEATURES:

- Quartz crystal timebase
- Toroid & zener noise & overvoltage protection.
- Magnified .15", 6 digit LED readout.
- Complete with presettable 24 hr. alarm.
- 9-14 VDC @ 40 to 50 ma.
- Readouts can be suppressed
- EASY, QUICK ASSEMBLY
- All components required included (you supply the speaker).
- Top quality drilled and plated PC boards.

12.95

Small enough to
mount in the
instrument panel!

Clock board: 2.6" x 2"
Readout board: 2 3/8" x .75"

New!

UNIVERSAL SOUND EFFECTS BOARD

HAVE YOU EVER WISHED YOU COULD DUPLICATE THE SOUND OF A STEAM TRAIN OR A PHASOR GUN? HOW ABOUT GUNSHOTS, WHISTLES, SIRENS, BARKING DOGS AND OTHER SOUND EFFECTS? NOW YOU CAN WITH OUR PROGRAMMABLE SOUND EFFECTS KIT. IT USES THE NEW 28 PIN T.I. SOUND SYNTHESIZER CHIP, SN76477 AND SUPPORT CIRCUITRY. 5 TO 12VDC IS REQUIRED TO GIVE APPROX. 1/4 WATT OF AUDIO OUTPUT. WE PROVIDE THE P.C. BOARD, PARTS AND INSTRUCTIONS ALONG WITH A CHART TO PROGRAM SOME COMMON SOUNDS. USE YOUR IMAGINATION TO CREATE ORIGINAL SOUND EFFECTS.

ORDER: SE-01 14.95 (Less Spkr.) 3/39.95

6 DIGIT ZULU CLOCK KIT

At last a clock for HAMS. Designed with large bright LED digits to enhance your shack. The unit is a pleasure to assemble and so easy on the budget! You get top quality parts and plated PC Boards. The unique design of the board set eliminates the headaches of running wires between clock and readout board. As a bonus the unit has a switchable timer that can be reset to zero without disturbing real time. Elapsed time in minutes and seconds up to 25 minutes. Six full sized FND510 readouts and colons making viewing easy from across the room. Does NOT use the old style 5314 chip. **DUE TO A SPECIAL PURCHASE WE HAVE A LIMITED QUANTITY.**

COMPLETE ZULU CLOCK KIT

Includes: All components, plated, drilled PC Boards, large easy to read instructions, and AC transformer. Clock board: 2 3/4" X 4 3/4" Readout Board: 1 1/2" X 4 3/4"

16.00

24 Hr. Format Only
Hand made solid hardwood case for the Zulu Clock. Includes ruby front filter and back panel.

6.95

MK-03A CLOCK/TIMER KIT

Features 24 hour Zulu time and up to 24 hours of elapsed time on the same set of six digit LED readouts. Totally independent operation of both functions. Clock has presettable alarm with 10 minute snooze. Timer has reset, hold, and count functions. Full noise and overvoltage protection. 24 hour only. Readouts has dimmer feature or they can be turned off without disturbing the clock or timer. Timebase included (.01% accuracy). Because of the many options and mounting considerations the case and switches are not included. Switches are standard types. Will fit inside standard aircraft instrument case.

9-14VDC

28.95

WARBLE ALARM KIT

A fun EASY kit to assemble that emits an ear piercing 10 watt dual tone scream. Resembles European siren sound. Great for alarms or toys. Operates from 5-12VDC at up to 1 amp (using 12VDC*8 ohm speaker). Over five thousand have been sold. All parts including PC board, less speaker.

2.50

ORDER WB-02

MOBILE CLOCK CALENDAR KIT

Seems like everybody sells digital clock kits, however we have the only low cost **DIGITAL CLOCK / CALENDAR** for Mobile operation. We provide quality plated through hole boards and step-by-step instructions, parts overlays and schematics. This clock has many features and we supply all the parts but a small speaker. Fantastic for car, boat or Van.

- Integral Timebase (.01% ACC)
- Large 4 DIGIT LED display with AM/PM indicators
- Flashing colon at 1HZ rate
- Special noise and overvoltage protection for mobile use
- Auxiliary output will drive relay or TRIAC to control external equipment
- 5% Wx1 3/4x2 1/2 D
- Built in ignition blanking turns off readouts when not in use
- Presettable alarm with Snooze
- Special "SleepTimer"

23.50 NO CASE

12 VAC XFMR for 110 VAC
1.50
24 Hour Format add
2.00

- ★ ADD 5% FOR SHIPPING
- ★ TX. RES. ADD 5% STATE SALES TAX
- ★ FOREIGN ORDERS ADD 10% (20% AIRMAIL) U.S. FUNDS ONLY

- ★ NO C.O.D.'S
- ★ SEND CHECK M.O. OR CHARGE CARD NO.
- ★ PHONE ORDERS ACCEPTED ON VISA AND MASTERCARD ONLY



YOU'VE SEEN IT ON QUALITY
STEREO GEAR

SUPER DEAL!

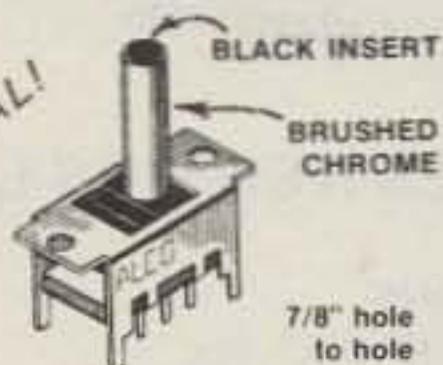

DPDT Toggle
ALCO CST-022
.3A @ 125V

.49

Diodes

| | | |
|--------|--------------------------------------|----------|
| 1N4003 | 200V 1A | 15/1.00 |
| 1N4006 | 800V 1A | 12/1.00 |
| 1N270 | Germanium Diode | 8/1.00 |
| 1N38A | Germanium Diode | 10/1.00 |
| 1N4148 | Cut & Bent for PC Board Insertion | 100/1.25 |

UNMARKED POWER DIODES with
cathode bands. Guaranteed to be at least
400PIV @ 1A. 100% Good parts. Epoxy
case.

25/1.00

NEW ITEMS:

| | | |
|----------|--|-----|
| MV1624 | Varicap Diode 10pfd Nom. 2:1 Tuning Range | 49¢ |
| 2N5583 | High Freq. Amp 1 Watt @ 1.5 GHZ! TO-5 Case style, House # | 50¢ |
| MFC4000B | 1/4 Watt Audio Amp 4 pin plas- tic pack | 50¢ |
| HI10103 | 100V 3A SCR Ultra sensitive gate drives from TTL. TO-220 | 55¢ |
| HI03SS | 50V 3A Triac Sensitive Gate TO-5 | 40¢ |

FND510 69¢

COMMON ANODE READOUT "V"
CHARACTER
LIMIT 24 PER CUSTOMER!

| | | | |
|-------|--------|--------|-------|
| LED'S | JUMBO | RED | 5/.89 |
| | | GREEN | 4/.89 |
| | MEDIUM | RED | .15 |
| | | MINI | |
| | | GREEN | .16 |
| | | RED | .10 |
| | | YELLOW | .16 |

1.5V 10-30 ma

MC1351P FM-IF AMP AND DISCRIMINATOR



USED IN FM & TV SOUND
CIRCUITS. REQUIRES MINI-
MUM EXTERNAL COMPO-
NENTS. 14 PIN DIP. DIRECT
REPLACEMENT FOR HEPC
6060, ECG 748 and MANY
OTHERS. HOUSE #

50¢

MC3301P HOUSE

4 OP AMPS IN ONE PACKAGE USES
SINGLE SUPPLY. (4 to 28VDC)
INTERNALLY COMPENSATED. SIMILAR
TO MC3401, BUT HIGHER GAIN.

49¢

ALL COMPONENTS 100% GUARANTEED

| | | |
|-----------|---------------------------------------|--------|
| CA3011 | WIDEBAND IF AMP w/specs | 50¢ |
| 2N3569 | NPN EPOXY 1W | 6/1.00 |
| 741 | OP AMP 8 PIN DIP | 5/1.00 |
| 723 | VOLTAGE REG. 14 PIN DIP | 50¢ |
| MPS6530 | NPN HOUSE # | 8/1.00 |
| 725 | OP AMP LOW NOISE HOUSE # | 99¢ |
| 7815 | 15V 1A REGULATOR HOUSE # | 69¢ |
| LM340T-12 | 12V 1A VOLT. REG. w/specs | 75¢ |
| TCA430 | QUAD OSCILLATOR 1/specs | 69¢ |
| 2N4343 | P CHANNEL J FET | 4/1.00 |
| 2N6111 | PNP MED PWR 40W TO-220 | 3/1.00 |
| 2N6028 | PROGRAMMABLE UNIJUNC- TION w/specs | 50¢ |
| TRIAC | 200V 8A UNMARKED | 3/1.00 |

MC1469R POSITIVE VOLTAGE REGULATOR

1/2 AMP COMPLETE SPECS AND
APPLICATIONS SHOW HOW TO BUILD
FIXED OR VARIABLE POWER SUPPLIES
FROM 3 TO 36VDC. DRIVE EXTERNAL
SERIES PASS FOR CURRENT TO 20
AMPS!

1.25 EA.
10/10.00

HOUSE #

25A
100V
SCR
1.95



Perfect for battery
chargers, switching
supplies, crowbars, etc.

739 FAIRCHILD



DUAL LOW NOISE
AUDIO PRE-AMPLIFIER

89¢ 2/1.69

HOUSE # PNP POWER

TD-3
150 WATTS
80 VDC
10 AMPS



IDENTICAL TO 2N6790 1.00

MPF131 N-CHANNEL DUAL GATE MOSFET

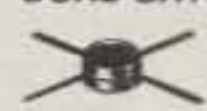

50¢

DESIGNED FOR AMPLIFIER AND
MIXER APPLICATIONS TO 300
MHZ. PLASTIC CASE. UNITS
ARE HOUSE NUMBERED WITH
SPECS.

FANTASTIC SOUND EFFECTS CHIP

AVAILABLE ONLY FROM BULLET!

THIS 28 PIN MARVEL CONTAINS A LOW
FREQUENCY OSCILLATOR, VCO, NOISE
OSCILLATOR, ONE SHOT, MIXER AND
ENVELOPE CONTROL. WITH 8 PAGE
MANUAL. 5 to 9VDC

3.95

EMITTER RESISTORS

HARD TO FIND

VALUES!

.1 ohm @ 5W

.25 ohm @ 5W

YOUR CHOICE...

7/1.00

HOUSE #

LM3900 QUAD NORTON AMP

WE BOUGHT A LARGE
QUANTITY OF THESE HOUSE
NUMBERED PARTS AT A
BARGAIN PRICE THAT
ALLOWS US TO SELL THEM
AT A LOW, LOW

39¢

IL-1 OPTO ISOLATORS

BY LITRONIX 6 PIN DIP
STANDARD PINOUT LED-
TRANSISTOR COMBINATION.

50¢

WHILE THEY LAST!



WIREWRAP Wire

30 Gauge
KYNAR® Insulat.

500 FT

4.50

MJ900 - MJ1000

COMPLEMENTARY PNP, NPN DARLING-
TON POWER TRANSISTORS. 8 AMPS.
WE SUPPLY A SCHEMATIC TO BUILD A
HIGH POWER (35W) LOW DISTORTION
AUDIO AMP WITH ONLY ONE
ADDITIONAL TRANSISTOR AND A
DOZEN INEXPENSIVE COMPONENTS!
TO-3 CASE STYLE. BUY A PAIR FOR

\$3.00!

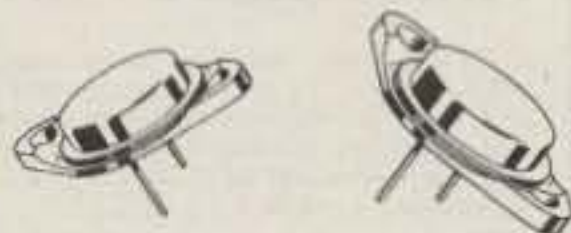

CAPACITORS

SMALL SIZE!



| | |
|-------------------------------|--------------|
| 2200 MFD @ 16 VDC RADIAL | 3/1.00 |
| 500 MFD @ 35VDC | 5/1.00 AXIAL |
| 220 MFD @ 25VDC | 7/1.00 AXIAL |
| 1 MFD @ 20VDC DISC CERAMIC | 15/1.00 |

| | | |
|--------|------------------|--------|
| .022 | @ 100VDC Mylar | 8/1.00 |
| .22 | @ 50VDC Mylar | 6/1.00 |
| 1.5mfd | @ 400VDC Mylar | 4/1.00 |
| .1mfd | @ 35V Tant Axial | 6/1.00 |
| .47mfd | @ 35V Tant Axial | 6/1.00 |
| 2.2mfd | @ 35V Tant Axial | 5/1.00 |
| 22mfd | @ 20V Dip Tant | 4/1.00 |
| 33mfd | @ 10V Dip Tant | 4/1.00 |

ZENER GRAB BAG

A very nice assortment of 1/4, 1/2
& 1W zeners. Voltage ranges
are from 2.7 to 30 VDC. Most
have house # but we provide a
cross over list to standard
numbers. A great buy for any
shop. 12 different types.

69¢

NO COD'S

ADD 5% FOR SHIPPING

ORDERS UNDER \$10.

SEND CHECK OR MONEY

TEX RESIDENTS ADD 5% TAX

ADD .75 for HANDLING

ORDER OR CHARGE CARD NO. FOREIGN ORDERS ADD 10%,

PHONE ORDERS ACCEPTED ON VISA & MC

COPYRIGHT

NEW

Frequency Counter \$89.95 kit



UTILIZES NEW MOS-LSI CIRCUITRY

You've requested it, and now it's here! The CT-50 frequency counter kit has more features than counters selling for twice the price. Measuring frequency is now as easy as pushing a button, the CT-50 will automatically place the decimal point in all modes, giving you quick, reliable readings. Want to use the CT-50 mobile? No problem, it runs equally as well on 12 V dc as it does on 110 V ac. Want super accuracy? The CT-50 uses the popular TV color burst freq. of 3.579545 MHz for time base. Tap off a color TV with our adapter and get ultra accuracy — .001 ppm! The CT-50 offers professional quality at the unheard of price of \$89.95. Order yours today!

- CT-50, 60 MHz counter kit \$ 89.95
- CT-50 WT, 60 MHz counter, wired and tested 159.95
- CT-600, 600 MHz prescaler option for CT-50, add 29.95

SPECIFICATIONS

- Sensitivity: less than 25 mv.
- Frequency range: 5 Hz to 60 MHz, typically 65 MHz
- Gatetime: 1 second, 1/10 second, with automatic decimal point positioning on both direct and prescale
- Display: 8 digit red LED .4" height
- Accuracy: 2.0 ppm, .001 ppm with TV time base!
- Input: BNC, 1 megohm direct, 50 Ohm with prescale option
- Power: 110 V ac 5 Watts or 12 V dc @ 1 Amp
- Size: Approx. 6" x 4" x 2", high quality aluminum case

Color burst adapter for .001 ppm accuracy

- CB-1, kit \$14.95



CLOCK KIT 6 digit 12/24 hour

Want a clock that looks good enough for your living room? Forget the competitor's kludges and try one of ours! Features: jumbo .4" digits, Polaroid lens filter, extruded aluminum case available in 5 colors, quality PC boards and super instructions. All parts are included, no extras to buy. Fully guaranteed. One to two hour assembly time. Colors: silver, gold, black, bronze, blue (specify).
Clock kit, DC-5 \$22.95
Alarm clock, DC-8, 12 hr only 24.95
Mobile clock, DC-7 25.95
Clock kit with 10 min ID timer, DC-10 ... 25.95
Assembled and tested clocks available, add \$10.00

CHEAP CLOCK KIT \$8.95

- | | | | |
|-------------------|---------------------------------------|-----------------|--------------------|
| DC-4 Features: | Does not include board or transformer | PC Board \$2.95 | Transformer \$1.49 |
| • 6 digit .4" LED | | | |
| • 12 or 24 format | | | |

VIDEO TERMINAL KIT \$149.95

A compact 5 x 10-inch PC card that requires only an ASCII keyboard and a TV set to become a complete interactive terminal for connection to your microprocessor asynchronous interface. Its many features are single 5-volt supply, crystal controlled sync and baud rates (up to 9600 baud), 2 pages of 32 characters by 16 lines, read to and from memory, computer and keyboard-operated cursor and page control, parity error display and control, power-on initialization, full 64-character ASCII display, block type left thru cursor, Keyboard/computer control backspaces, forward spaces, line feeds, rev. line feeds, home, returns cursor. Also clears page, clears to end of line, selects page 1 or 2, reads from or to memory. The card requires 5 volts at approx. 900 ma and outputs standard 75 ohm composite video.

- | | |
|---------------------------------|----------|
| TH2216 Kit | \$149.95 |
| TH2216, Assembled and Tested | 229.95 |
| VO-1, Video to RF Modulator Kit | 6.95 |

CAR CLOCK KIT \$27.95



- | | | |
|-----------------------------------|---------|--|
| 12/24 Hour 12 Volt AC or DC | | AUTO-DIMMER \$2.50 |
| • High Accuracy (1 minute/month) | | Automatically adjusts display brightness according to ambient light level for DC-11 Car Clock. |
| • 6 jumbo .4" LED readouts | | |
| • Easy, no-polarity hookup | | |
| • Display blanks with ignition | | |
| • Case, mounting bracket included | | |
| • Super instructions | | |
| Complete Kit, DC-11 | \$27.95 | |

MINI-KITS

STONE DECODER KIT

A complete tone decoder on a single PC Board. Features: 400-5000 Hz adjustable frequency range, voltage regulation, 567 IC. Useful for touch-tone decoding, tone burst detection, FSK demod, signaling, and many other uses. Use 7 for 12 button touchtone decoding. Runs on 5 to 12 volts.
Complete Kit, TD-1 \$4.95



SUPER SLEUTH AMPLIFIER

A super-sensitive amplifier which will pick up a pin drop at 15 feet! Great for monitoring baby's room or as a general purpose test amplifier. Full 2 watts of output, runs on 6 to 12 volts, uses any type of mike. Requires 8-45 ohm speaker.
Complete Kit, BN-9 \$4.95

FM WIRELESS MIKE KIT

Transmit up to 300' to any FM broadcast radio, uses any type of mike. Runs on 3 to 9 V. Type FM-2 has added super sensitive mike preamp.
FM-1 \$2.95 FM-2 \$4.95

COLOR ORGAN/MUSIC LIGHTS

See music come alive! 3 different lights flicker with music or voice. One light for lows, one for the mid-range and one for the highs. Each channel individually adjustable, and drives up to 300 watts. Great for parties, band music, nite clubs and more.
Complete Kit, ML-1 \$7.95

LED BLINKY KIT

A great attention getter which alternately flashes 2 Jumbo LEDs. Use for name badges, buttons, or warning type panel lights. Runs on 3 to 9 volts.
Complete Kit \$2.95

POWER SUPPLY KIT

Complete triple regulated power supply provides variable 115 volts at 200 mA and +5 volts at 1 Amp. 50 mV load regulation good filtering and small size. Kit less transformers. Requires 6-8 V at 1 Amp and 18 to 30 VCT.
Complete Kit, PS-3LT \$6.95



SIREN KIT

Produces upward and downward wail characteristic of police siren. 5 watts audio output, runs on 3-9 volts, uses 8-45 ohm speaker.
Complete Kit, SM-3 \$2.95

DECADE COUNTER PARTS

Includes: 7490A, 7475, 7447, LED readout, current limit resistors, and instructions on an easy to build low cost frequency counter.
Kit of parts, DCU-1 \$3.50

600 MHz PRESCALER



Extend the range of your counter to 600 MHz. Works with all counters. Less than 150 mv sensitivity. Specify -10 or -100
Wired, tested, PS-1B \$59.95
Kit, PS-1B \$44.95

30 watt 2 meter Power Amp

The famous RE class C power amp now available mail order! Four Watts in for 30 Watts out, 2 in for 15 out, 1 in for 8 out, incredible value, complete with all parts, instructions and details on T-R relay. Case not included.
Complete Kit, PA-1 \$22.95

CALENDAR ALARM CLOCK

Has every feature one could ever ask for. Kit includes everything except case, build it into wall, station or even car!
FEATURES:
• 6 Digits, 5" High LED • 12/24 Hour Format
• Calendar shows mo, day • Snooze button
• True 24 Hour Alarm • 7001 chip does all!
• Battery back up with built-in on chip time base
Complete Kit, less case, DC-9 \$34.95

| LINEAR | | REGULATOR | | TRANSISTORS | |
|------------|--------|------------|-------|-------------------|-----------|
| 5314 Clock | \$2.95 | 555 | \$.50 | MRF-238 30W VHF | \$11.95 |
| 74S00 | .35 | 556 | .75 | NPN 2N3904 type | 10/\$1.00 |
| 74S112 | .75 | 566 | 1.49 | PNP 2N3906 type | 10/\$1.00 |
| 7447 | .79 | 567 | 1.49 | NPN Power Tab 40W | 3/\$1.00 |
| 7473 | .35 | 1458 | .50 | PNP Power Tab 40W | 3/\$1.00 |
| 7475 | .50 | LED DRIVER | 7812 | FET MPF-102 type | 3/\$2.00 |
| 7490A | .55 | 75491 | .50 | UJT 2N2646 type | 3/\$2.00 |
| 74143 | 3.50 | 75492 | .50 | 2N3055 NPN Power | .75 |

DIODES: 1KV, 2.5A 5/\$1.00 100V, 1A 10/\$1.00 1N914A type 50/\$2.00

LED DISPLAYS

- FND 35975
- FND 510 1.25
- DL 707 1.25
- HP 7730 1.25

Red Polaroid Filter ... 4.25" X 1.125"59

741 OP-AMP SPECIAL

Factory prime mini dip with both Xerox and 741 part numbers
10 for \$2.00

SOCKETS

- 14 PIN 5/\$1.00
- 16 PIN 5/\$1.00
- 24 PIN 2/\$1.00
- 40 PIN 3/\$2.00

FERRITE BEADS

- with info and specs 15/\$1.00
- 6 hole Balun Beads 5/\$1.00

ramsey electronics

P.O. Box 4072 Rochester NY 14610

(716) 271-6487

TELEPHONE ORDERS WELCOME

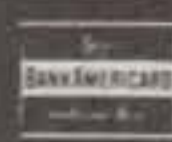

Satisfaction guaranteed or money refunded. COD, add \$1.00. Orders under \$10 add \$.75. NY residents add 7% tax. Add 5% for postage, insurance, and handling. Minimum order \$6.00.

NEW FM/CW EXCITER KITS

BUILD UP YOUR OWN GEAR FOR MODULAR STATIONS, REPEATERS, & CONTROL LINKS
 • Rated for Continuous Duty • Professional Sounding Audio • Built-in Testing Aids



T50 Six Channel, 2W Exciter Kit for 2M, 6M, or 220 MHz \$49.95

FAMOUS HAMTRONICS PREAMPS

let you hear the weak ones!

Great for OSCAR, SSB, FM, ATV. Over 10,000 in use throughout the world on all types of receivers.

P9 Kit \$12.95
P14 Wired \$24.95

Deluxe vhf model for applications where space permits.

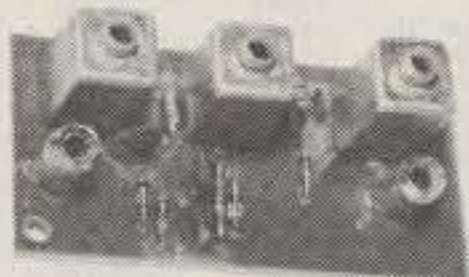

- 1-1/2 x 3" • Covers any 4 MHz band • 12 Vdc
- Ideal for OSCAR • Diode protection • 20dB gain

| MODEL | RANGE |
|-----------|-----------------|
| P9-LO | 26-88 MHz |
| P9-HI | 88-172 MHz |
| P9-220 | 172-230 MHz |
| P14 Wired | Give exact band |



P8 Kit \$10.95
P16 Wired \$21.95

- Covers any 4 MHz band • 20 dB gain • 12 Vdc
- Miniature VHF model for tight spaces - size only 1/2 x 2-3/8 inches.

| MODEL | RANGE |
|-----------|-----------------|
| P8-LO | 20-83 MHz |
| P8-HI | 83-190 MHz |
| P8-220 | 220-230 MHz |
| P16 Wired | Give exact band |

P15 Kit \$18.95
P35 Wired \$34.95

- Covers any 6 MHz band in UHF range of 380-520 MHz
- 20 dB gain • Low noise



YOU ASKED - HERE THEY ARE! VHF Linear PA's

- Use as Linear or Class C PA's • For XV-2 Xmtg Converters, T50 Exciters, or any 2W Exciter

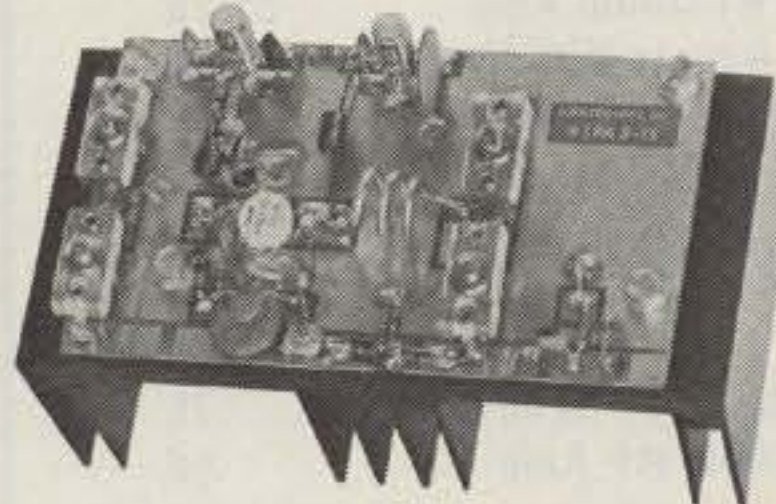

LPA 2-15 Kit \$59.95

- 15W out (linear) or 20W (class C) • Solid State T/R Switching • Models for 6M, 2M, or 220 MHz

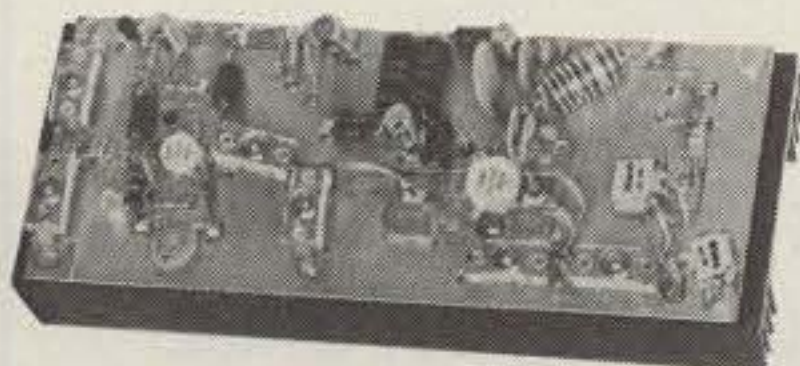

LPA 2-45 Kit \$109.95

- 45W out (linear) or 50W (class C)

• Models for 6M or 2M
 LPA 8-45 Kit \$89.95
 For 2M, 8-10W in, 45W out

AT LAST! 6M, 2M, & 1 1/4 M SSB TRANSMITTING CONVERTERS At a price you can afford

Use inexpensive recycled 10 or 11 meter ssb exciter on VHF bands!

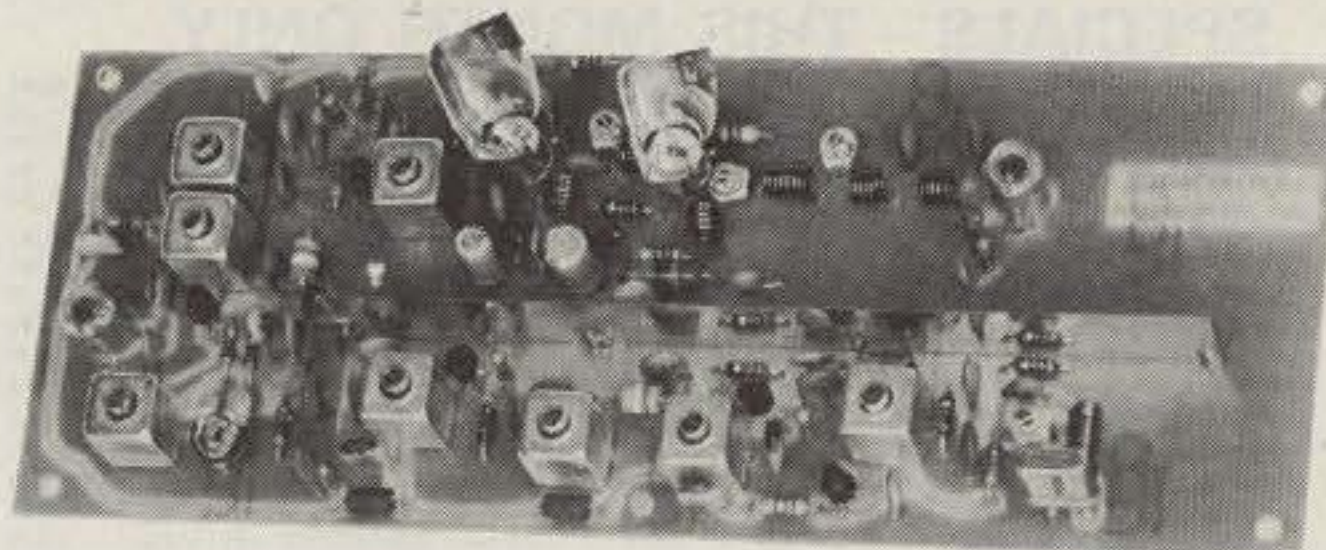

FEATURES:

- Linear Converter for SSB, CW, FM, etc.
- A fraction of the price of other units
- 2W p.e.p. output with 1 MW of drive
- Use low power tap on exciter or attenuator pad
- Easy to align with built-in test points

XV2-() TRANSVERTER KIT \$59.95
A25 Optional Cabinet for Xverter&PA \$20

Frequency Schemes Available:

| | | |
|-------|-------------|--------------|
| XV2-1 | 28-30 MHz = | 50 - 52 MHz |
| XV2-2 | 28-30 MHz = | 220-222 MHz |
| XV2-4 | 28-30 MHz = | 144-146 MHz |
| XV2-5 | 28-29 MHz = | 145- 146 MHz |
| XV2-6 | 26-28 MHz = | 144-146 MHz |

New VHF&UHF Converter Kits

let you receive OSCAR signals and other exciting SSB, CW, & FM activity on your present HF receiver.



either one
- ONLY \$34.95
 including crystal

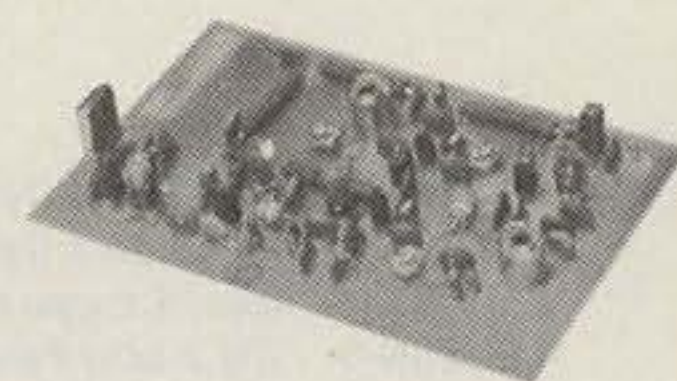

| MODEL | RF RANGE (MHZ) | I-F RANGE |
|---------|---------------------------------|-----------|
| C50 | 50-52 | 28-30 |
| C144 | 144-146 | 28-30 |
| C145 | 145-147 (OSCAR) | 28-30 |
| C146 | 146-148 | 28-30 |
| C110 | Aircraft | 28-30 |
| C220 | 220 band | 28-30 |
| Special | Other i-f & rf ranges available | |

| MODEL | RF RANGE (MHZ) | I-F RANGE |
|----------------------------------|---------------------------------|-----------|
| C432-2 | 432-434 | 28-30 |
| C432-5 | 435-437 (OSCAR) | 28-30 |
| C432-7 | 427.25 | 61.25 |
| C432-9 | 439.25 | 61.25 |
| Special | Other i-f & rf ranges available | |
| A9 Extruded Alum Case/Connectors | | \$12.95 |

VHF/UHF FM RCVR KITS

- ★ NEW GENERATION RECEIVERS
- ★ MORE SENSITIVE ★ MORE SELECTIVE (70 or 100 dB)
- ★ COMMERCIAL GRADE DESIGN
- ★ EASY TO ALIGN WITH BUILT-IN TEST CKTS
- ★ LOWER OVERALL COST THAN EVER BEFORE



R70 6-channel VHF Receiver Kit for 2M, 6M, 10M, 220 MHz, or com'l bands..... \$69.95
 Optional xtal filter for 100 dB adj chan 10.00



R90 UHF Receiver Kit for any 2 MHz segment of 380-520 MHz band..... \$89.95

* FREE 1978 CATALOG *

NEW JUNE 1978 CAT. IS YOURS FOR THE ASKING!

IT'S EASY TO ORDER!

☎ CALL OR WRITE NOW FOR FREE CATALOG OR TO PLACE ORDER!

☎ PHONE 716-663-9254. (Answering service evenings and weekends for your convenience. Personal service 9-5 eastern time.)

☎ Use credit card, c.o.d., check, m.o.

☎ Add \$2.00 shipping & handling.

IN CANADA, send to Comtec; 5605 Westluxe Ave; Montreal, Que H4W 2N3 or phone 514-482-2640. Add 38% to cover duty, tax, and exchange rate.

hamtronics, inc.

182-J Belmont Rd; Rochester, NY 14612 H16

VARIABLE POWER SUPPLY KIT \$11⁹⁵

- Continuously Variable from 2V to over 15V
- Short-Circuit Proof
- Typical Regulation of 0.1%
- Electronic Current Limiting at 300mA
- Very Low Output Ripple
- Fiberglass PC Board Mounts All Components
- Assemble in about One Hour
- Makes a Great Bench or Lab Power Supply
- Includes All Components except Case and Meters

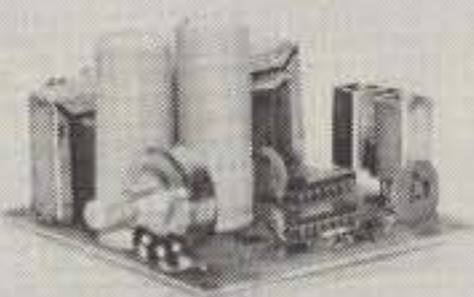

ADD \$1.25 FOR POSTAGE/HANDLING

FREE

IC or FET's WITH
\$5 & \$10 ORDERS.[†]
DATA SHEETS
WITH MANY ITEMS.

SPECIALS—THIS MONTH ONLY

| | | | | | |
|---|---|--------|---------|--------------------------------------|--------|
| 1N34A | Germanium Diode 60V 10mA | 10/\$1 | LM308H | Low Bias Current Op Amp-Super 709 | \$0.84 |
| 1N270 | Germanium Diode 80V 200mA | 4/\$1 | LM309K | 5 Volt Regulator TO-3 | .84 |
| 1N914 | Silicon Diode 100V 10mA | 25/\$1 | LM317K | Adjustable Voltage Regulator 2-37V | 3.50 |
| 1N6263 | Hot Carrier Diode (HP2800, etc.) | \$1.00 | LM380N | 2 Watt Audio Power Amplifier DIP | .94 |
| F7 | Power Varactor 1-ZW Out @ 432MHz (Specs & Circuits included with F7) | \$2.00 | NE565A | Phase Locked Loop DIP | .94 |
| DIODE GRAB BAG—Mixed zeners, rectifiers, etc. | | 50/\$1 | LM723CN | Precision Voltage Regulator DIP | 3/\$1 |
| 2N706 | NPN High-Speed Switch 75ns | 4/\$1 | LM747 | Dual 741 Compensated Op Amp DIP | 2/\$1 |
| 2N918 | UHF Transistor—Osc/Amp up to 1 GHz | 4/\$1 | 2102 | 1024-Bit Static RAM (1024 x 1) DIP | \$1.75 |
| 2N2609 | P-Channel FET Amplifier 2500µmhos | \$1.00 | 27400E | FET-Input Op Amp-like NE 536/µA740 | 1.95 |
| 2N2920 | NPN Dual Transistor 3mV Match β225 | 2.95 | CA3018A | 4-Transistor Array/Darlington | .99 |
| 2N3904 | NPN Amp/Switch β100 40V 200mA | 8/\$1 | CA3028A | RF/IF Amplifier DC to 120MHz | 1.45 |
| 2N4122 | PNP RF Amplifier & Switch | 3/\$1 | CA3075E | FM IF Amp/Limiter/Detector DIP | 1.45 |
| 2N4869E | N-Channel Audio FET Super Low-Noise | 2/\$1 | RC4558 | Dual High Gain Op Amp mDIP | 3/\$1 |
| 2N4888 | 150 Volt PNP Transistor for Keyer | 2/\$1 | N5556V | Precision Fast Op Amp mDIP | 2/\$1 |
| E112 | N-Channel FET VHF RF Amp | 3/\$1 | N5558V | Dual Hi Gain Op Amp-Comp. mDIP | 3/\$1 |
| TIS74 | N-Channel FET High-Speed Switch 40ns | 3/\$1 | 8038 | Function Generator/VCO with circuits | \$3.75 |
| LP-10 | LOGIC PROBE kit—TTL, CMOS, etc. Machined case included—½ hr. assembly | \$7.85 | | | |

SEND FOR ADVA'S NEW 1979 CATALOG
NEARLY 1000 SEMICONDUCTORS, KITS, CAPACITORS, ETC.—SEND 25¢ STAMP.

OTHER ADVA KITS:

LOGIC PROBE KIT—Use with CMOS, TTL, DTL, RTL, HTL, HINIL and most MOS IC's. Built-in protection against polarity reversal and overvoltage. Draws only a few mA from circuit under test. Dual LED readout. Complete kit includes case and clip leads. **ONLY \$7.85**

FIXED REGULATED POWER SUPPLY KITS—Short-circuit proof with thermal current limiting. Compact size and typical regulation of 0.5% make these ideal for most electronic projects. Available for 5V @ 500mA, 6V @ 500mA, 9V @ 500mA, 12V @ 400mA, 15V @ 300mA. Specify voltage when ordering. **\$8.95 ea.**

These easy-to-assemble kits include all components, complete detailed instructions and plated fiberglass PC boards. Power supply kits do not include case or meters. Add \$1.25 per kit for postage and handling.

MAIL NOW! FREE DATA SHEETS supplied with many items from this ad. **FREE ON REQUEST**—741 Op Amp with every order of \$5 or more—749 Dual Op Amp or two E100 FET's with every order of \$10 or more, postmarked prior to 12/31/78. One free item per order. **ORDER TODAY!**—All items subject to prior sale and prices subject to change without notice. All items are new surplus parts—100% functionally tested.

WRITE FOR FREE CATALOG #79 offering over 700 semiconductors carried in stock. Send 25¢ stamp.

TERMS: Send check or money order (U.S. funds) with order. Add 5% postage for U.S., Canada and Mexico. \$1.00 handling charge on orders under \$10. Calif. residents add 6% sales tax. Foreign orders add 10% postage. COD orders—add \$1.00 service charge.

MORE SPECIALS:

RC4195DN ±15V @ 50mA VOLTAGE REGULATOR IC. Very easy to use. Makes a neat Highly Regulated ±15V Supply for OP AMP's, etc. Requires only unregulated DC (18–30V) and 2 bypass capacitors. With Data Sheet and Schematics. 8-pin mDIP **\$1.25**

RC4136 Quad 741 Low-Noise Op Amp mDIP **\$0.95**

LM1304 FM Multiplex Stereo Demodulator DIP **0.99**

LM2111 FM IF Subsystem (IF Amp, Det., Limiter) DIP **0.99**

1N6263 Hot Carrier Diode 0.4V @ 1mA 0.1ns DO-35 **1.00**

ZENERS—Specify Voltage 3.3, 3.9, 4.3, 5.1, 6.8, 8.2, 9.1, 10, 12, 15, 16, 18, 20, 22, 24, 27, or 33V (±10%) 1 Watt 3/\$1.00

- MONEY-BACK GUARANTEE
- ALL TESTED AND GUARANTEED

ADVA

ELECTRONICS
BOX 4181 GB, WOODSIDE, CA 94062
Tel. (415) 328-1500

| DIODES | TRANSISTORS | TRANSISTORS | TRANSISTORS | LINEAR IC's |
|------------------------|-----------------|----------------|------------------|-----------------|
| ZENERS & RECTIFIERS | 2N706 \$0.24 | 2N4091 3/\$1 | 2N5638 2/\$1 | LM340K-5 \$1.20 |
| 1N456 to 1N458 6/\$1 | 2N718 .24 | 2N4092 \$0.75 | 2N5640 2/\$1 | LM340T-F 1.20 |
| 1N483 to 1N486 6/\$1 | 2N720 .48 | 2N4121 3/\$1 | CP643 \$4.00 | LM340T-F 1.20 |
| 1N746 to 1N759 4/\$1 | 2N918 3/\$1 | 2N4122 3/\$1 | CP650* \$5.00 | LM340T-F 1.20 |
| 1N914* 15/\$1 | 2N1613 \$0.29 | 2N4124 5/\$1 | CP651 \$4.00 | LM340T-F 1.20 |
| 1N962 to 1N974 4/\$1 | 2N1711 .29 | 2N4248 5/\$1 | E100 4/\$1 | LM340T-F 1.20 |
| 1N3064 6/\$1 | 2N1890 .38 | 2N4249 5/\$1 | E101 3/\$1 | LM340T-F 1.20 |
| 1N3060 6/\$1 | 2N1893 .38 | 2N4250 4/\$1 | E102 3/\$1 | LM340T-F 1.20 |
| 1N4001* 12/\$1 | 2N2219 .24 | 2N4274 5/\$1 | E175 3/\$1 | LM380N 1.29 |
| 1N4002 12/\$1 | 2N2222 6/\$1 | 2N4302 \$0.29 | MPF102 to* 3/\$1 | NE555V* 2/\$1 |
| 1N4003 12/\$1 | 2N2222A 5/\$1 | 2N4303 .29 | MPF104 3/\$1 | NE556A \$0.90 |
| 1N4004 12/\$1 | 2N2967* 5/\$1 | 2N4308 5/\$1 | MPF112 4/\$1 | LM709CN .29 |
| 1N4005 10/\$1 | 2N3553 \$1.50 | 2N4338 \$1 | MPF5815 3/\$1 | LM709CN .29 |
| 1N4006 10/\$1 | 2N3563 6/\$1 | 2N4360M 2/\$1 | MP5815 3/\$1 | LM723H 2/\$1 |
| 1N4007 10/\$1 | 2N3564 4/\$1 | 2N4391 \$1 | SE1001 4/\$1 | LM723H* 3/\$1 |
| 1N4148 15/\$1 | 2N3965 to 6/\$1 | 2N4392 \$0.90 | SE1002 4/\$1 | LM739N \$1.00 |
| 1N4154* 25/\$1 | 2N3966 6/\$1 | 2N4416 2/\$1 | SE2001 4/\$1 | LM741CH 3/\$1 |
| 1N4370 to 1N4372 2/\$1 | 2N3968 6/\$1 | 2N4416A \$0.80 | SE2002 4/\$1 | LM741CN* 4/\$1 |
| 1N4454 15/\$1 | 2N3969 5/\$1 | 2N4856 to \$1 | SE5001 to 3/\$1 | LM741CN14 .34 |
| 1N4728 to 1N4753 3/\$1 | 2N3970 5/\$1 | 2N4867E 2/\$1 | SE5003 3/\$1 | LM741CN14 .34 |
| 1N5231 4/\$1 | 2N3988 to 3/\$1 | 2N4888E 2/\$1 | TIS73 to 3/\$1 | 748CJ DIP .35 |
| 1N5238 4/\$1 | 2N3989 3/\$1 | 2N4888E 2/\$1 | TIS75 3/\$1 | 748CJ DIP 1.00 |
| | 2N3990 3/\$1 | 2N4888E 2/\$1 | | 845CP mDIP .80 |
| | 2N3991 to 4/\$1 | 2N4888E 2/\$1 | | LM1304N 1.15 |
| | 2N3994 \$2 | 2N4888E 2/\$1 | | LM1458N* 3/\$1 |
| | 2N3994 \$2 | 2N4888E 2/\$1 | | LM2111N \$1.40 |
| | 2N3994 \$2 | 2N4888E 2/\$1 | | XR2556CP 1.55 |
| | 2N3994 \$2 | 2N4888E 2/\$1 | | 27400E 1.95 |
| | 2N3994 \$2 | 2N4888E 2/\$1 | | CA3028A 1.45 |
| | 2N3994 \$2 | 2N4888E 2/\$1 | | CA3048 .84 |
| | 2N3994 \$2 | 2N4888E 2/\$1 | | CA3075N 1.45 |
| | 2N3994 \$2 | 2N4888E 2/\$1 | | CA3086* .62 |
| | 2N3994 \$2 | 2N4888E 2/\$1 | | LM3080N .55 |
| | 2N3994 \$2 | 2N4888E 2/\$1 | | RC4194D 1.50 |
| | 2N3994 \$2 | 2N4888E 2/\$1 | | RC4194TK* 2.50 |
| | 2N3994 \$2 | 2N4888E 2/\$1 | | LM100H \$7.50 |
| | 2N3994 \$2 | 2N4888E 2/\$1 | | LM301AN .27 |
| | 2N3994 \$2 | 2N4888E 2/\$1 | | LM307H .27 |
| | 2N3994 \$2 | 2N4888E 2/\$1 | | LM4250CN 2.00 |
| | 2N3994 \$2 | 2N4888E 2/\$1 | | LM308N .88 |
| | 2N3994 \$2 | 2N4888E 2/\$1 | | LM309K .94 |
| | 2N3994 \$2 | 2N4888E 2/\$1 | | LM311N .90 |
| | 2N3994 \$2 | 2N4888E 2/\$1 | | NE555V .50 |
| | 2N3994 \$2 | 2N4888E 2/\$1 | | LM320K-5 1.35 |
| | 2N3994 \$2 | 2N4888E 2/\$1 | | LM320K-12 1.35 |
| | 2N3994 \$2 | 2N4888E 2/\$1 | | LM320K-15 1.35 |
| | 2N3994 \$2 | 2N4888E 2/\$1 | | DM75492 .89 |

*SUPER SPECIALS:

| | | | | |
|----------|---|--------|--------------------------|--------|
| 1N34 | Germanium Diode | 10/\$1 | FSA2501M Diode Array | 2/\$1 |
| 1N914 | 100V/10mA Diode | 20/\$1 | MPF102 200MHz RF Amp | 3/\$1 |
| 1N4001 | 50V/1A Rectifier | 15/\$1 | 40673 MOSFET RF Amp | \$1.75 |
| 1N4154 | 30V 1N914 | 25/\$1 | LM324 Quad 741 Op Amp | .94 |
| BR1 | 50V ½A Bridge Rec | 4/\$1 | LM376 Pos Volt Reg mDIP | .55 |
| 2N2222 | NPN Transistor | 6/\$1 | NE555 Timer mDIP | .38 |
| 2N2907 | PNP Transistor | 6/\$1 | LM723 2-37V Reg DIP | 3/\$1 |
| 2N3055 | Power Xistor 10A | \$0.75 | LM741 Comp Op Amp mDIP | 6/\$1 |
| 2N3904 | NPN Amp/Sw β100 | 6/\$1 | LM1458 Dual 741 mDIP | 3/\$1 |
| 2N3906 | PNP Amp/Sw β100 | 6/\$1 | CA3086 5 Trans Array DIP | .62 |
| CP650 | Power FET ½Amp | \$5 | RCA29 Pwr Xistor 1A 30W | .70 |
| RF391 | RF Power Amp Transistor 10-25W @ 3-30MHz TO-3 | \$5.00 | | |
| 555X | Timer 1µs-1hr Different pinout from 555 (w/data) | 3/\$1 | | |
| RC4194TK | Dual Tracking Regulator ±0.2 to 30V @ 200mA TO-66 | \$2.50 | | |
| RC4195TK | Dual Tracking Regulator ±15V @ 100mA (TO-66) | \$2.25 | | |
| 8038 | Waveform Generator ~∇∇∇ Wave With Circuits & Data | \$3.75 | | |

NEW SPECIALS

| | | |
|---|---|---------|
| LM318CN | High Speed Op Amp 50V/µs mDIP | \$0.94 |
| LM318D | High Speed Op Amp 50V/µs DIP | .90 |
| LM339N | Quad Comparator Single or Dual Supply | .79 |
| LM380N-8 | ½W Audio Power Amplifier 8-22V | .90 |
| NE567V | Tone Decoder (PLL) 0.01Hz to 500kHz | .99 |
| XR567CP | Tone Decoder (PLL) 0.01Hz to 500 kHz | .99 |
| LM723CN | Precision Voltage Regulator 2-37V DIP | 3/\$1 |
| LM747CN | Dual 741 Compensated Op Amp | 2/\$1 |
| SAD1024 | Dual 512 Stage (1024) Audio Delay Line "Bucket Brigade" Appl. Data included | \$18.95 |
| XR2206CP | Function Generator with applic. data | 4.40 |
| XR2242CP | Long-Range Precision Timer µs to days | 1.50 |
| 1 YEAR TIMER Kit-2 XR2242's and Applic. Note | | 3.00 |
| LM2901N | Quad Comparator +5V or 2 to 36VDC | \$1.20 |
| CA3018A | 4-Transistor Array/Darlington | .99 |
| CA3028A | RF/IF Amplifier DC to 120MHz | 1.25 |
| RC4558 | Dual High Gain Op Amp mDIP | 3/\$1 |
| SPACER Kit - 4 ea of 5 assorted size spacers | | \$1.00 |
| ±15 VOLT Regulated Power Supply Kit-Easy assembly, 5mV regulation, 100mA, fully protected. Includes all components and hardware, no PCB or case—Add \$1.50 for shipping | | \$13.95 |

| | | |
|---|---------------------------------------|--------|
| 1N270 | Germanium Diode 80V 200mA | 4/\$1 |
| 1N823 | Temp Comp Reference 6.2V±5% ±.005%/°C | \$0.60 |
| 1N914 | Silicon Diode 100V 10mA | 25/\$1 |
| 1N3044 | 100V Zener 1W—Better than an OB3 | .75 |
| 1N3045 | 110V Zener 1W—Better than an OB2/OC3 | .75 |
| 1N3071 | 200V 100mA Switching Diode 40ns | .30 |
| 2N2915 | NPN Dual Transistor 3mV Match β100 | \$1.95 |
| 2N3819M | N-Channel RF FET 100MHz Amp | .35 |
| 2N4020 | PNP Dual Transistor 5mV Match β250 | 5.00 |
| 2N4445 | N-Channel FET 5Ω Switch | 3.50 |
| 2N5394E | Ultra-Low Noise J-FET Audio Amp | \$1.25 |
| 2N5912 | Dual J-FET RF Dif Amp to 800MHz | 2.90 |
| 2N6028 | Programmable Unijunction Transistor | .45 |
| 2N6449 | 300 Volt N-Channel J-FET Amp/Sw | 2.00 |
| CP640 | Broadband FET RF Amp 140dB Dyn Range | \$4.50 |
| E304 | N-Channel RF FET 3.8dB NF @ 400MHz | .50 |
| MPSA12 | NPN Darlington Transistor β20,000 | .75 |
| TIS88 | N-Channel FET 400MHz RF Amp | .60 |
| RESISTOR Kit—150 pcs ¼W, 20 most common values, individually packaged, 5 to 20 pcs each | | \$4.95 |
| PC BOARD Mounting Kit—8 ea spacer, screw, nut and washer—32 pcs total. | | \$1.00 |

SEND FOR ADVA'S NEW 1979 CATALOG
NEARLY 1000 SEMICONDUCTORS, KITS, CAPACITORS, ETC.—SEND 25¢ STAMP.

ADVA

ELECTRONICS

BOX 4181 GB
WOODSIDE, CA 94062
Tel.(415) 328-1500

**ALL
NEW**

Real-State-of-the-Art

TWO NEW AC•DC•BATTERY PORTABLE COUNTERS

OPTO-8000 .1A 10Hz to 600 MHz — FREQUENCY COUNTER

- Precision TCXO time base 0.1 PPM Stability 17-40°C
- Super Sensitivity with preamps in both HI-Z & 50 Ohm inputs <10mV to 50MHz, 25 mV @ 150 MHz <50mV to 600MHz
- Auto Decimal Point ● Aluminum Case ● Socketed IC's
- Three position attenuator: X1, X10, X100 (avoids false counting)

| | | | |
|----------------|---------------------|-------|----------|
| #OPTO-8000.1A | Factory Assembled | | \$329.95 |
| #OPTO-8000.1AK | Kit Form | | \$279.95 |
| #NI-CAD-80 | NI-CAD Battery Pack | | \$ 19.95 |

OPTO-7000 10 Hz to 600 MHz MINIATURE COUNTER

- XTAL (TCXO) Time Base ±.08PPM/°C
- Aluminum Case ● HI-Z & 50 Ohm inputs
- 1 Sec. & 1/10 Sec. Gate times ● Auto Dec. Pt.
- Built-in Prescaler and Preamps Standard

| | | |
|-------------|---|----------|
| #OPTO-7000 | Factory Assembled - 1 Year-Guar.. | \$139.95 |
| #OPTO-7000K | Kit Form..... | 99.95 |
| #AC-70 | AC Power Pack..... | 4.95 |
| #NI-CAD-70 | NI-CAD Battery Pack..... | 19.95 |
| #TCXO-70 | Precision TCXO Time Base <0.1PPM, 17-40°C..... | 79.95 |

ACCESSORIES

PROBES:

| | | |
|------------|---|---------------------|
| #P-100 | 50 Ohm, 1X | \$13.95 |
| #P-101 | Lo-Pass..... | 16.95 |
| #P-102 | H1-Z, 2X | 16.95 |
| # AP- 8015 | UHF Counter Preamp 20 MHz to 600 MHz 15-50 DB Gain (Not Shown) .. | \$49.95/Kit \$39.95 |

#D-450 Antenna

Rubber Duck RF Pick-up 450 MHz ... \$12.50

#D-146 Same as above

146.5MHz..... \$12.50

#RA-BNC Right-Angle BNC Adapter for
above Antenna

2.95

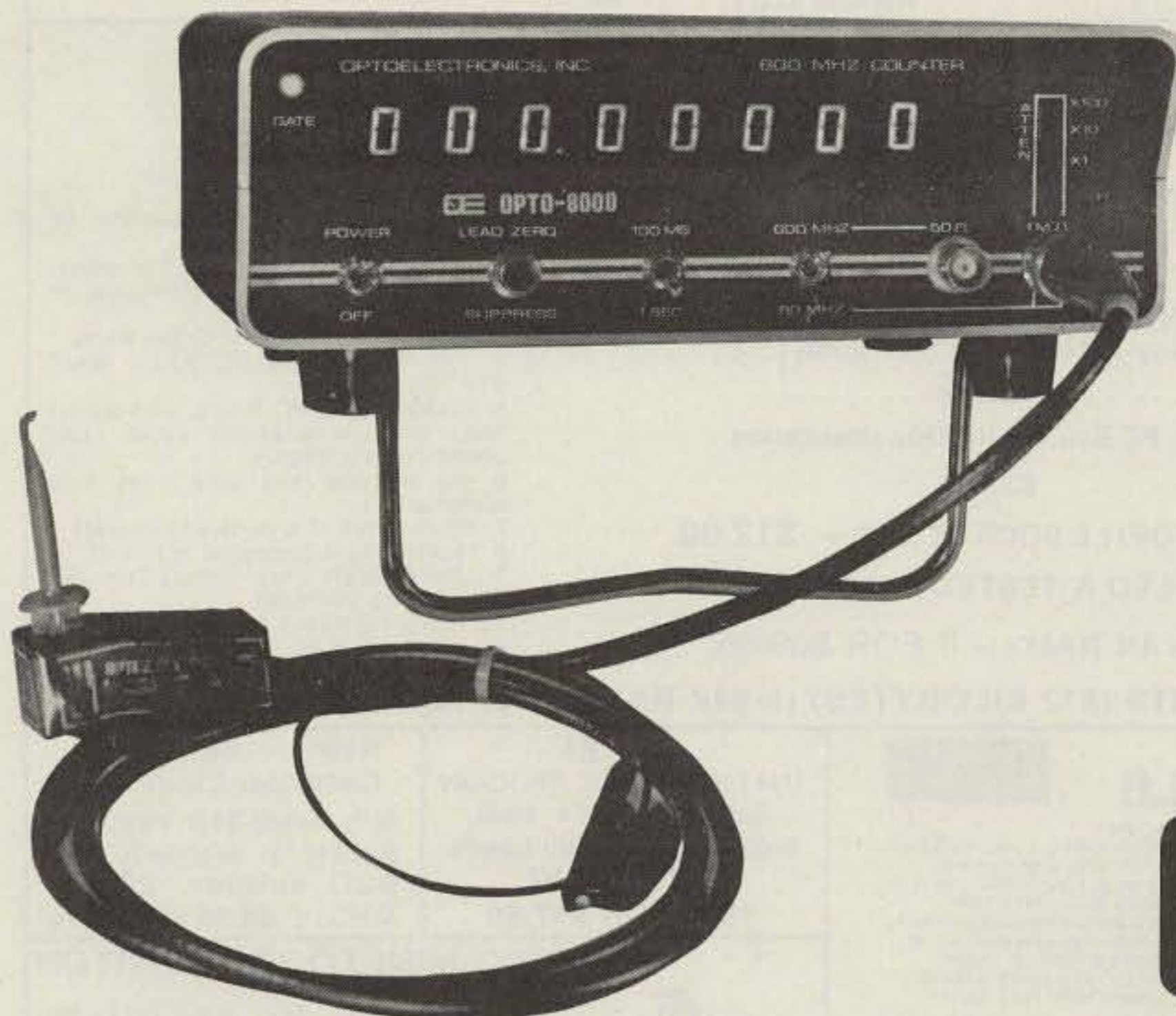

✓ 03

OPTOELECTRONICS, INC.

5821 NE 14 Avenue
Ft. Lauderdale, FL 33334
Phones: (305) 771-2050 771-2051

Phone orders accepted

ORDER FACTORY DIRECT — PHONE OR MAIL

TERMS: Orders to U.S. and Canada, add 5% to maximum of \$10.00 per order for shipping, handling and insurance. To all other countries, add 10% of total order. Florida residents add 4% state tax. C.O.D. fee: \$1.00. Personal checks must clear before merchandise is shipped.

New!

16K E-PROM CARD

IMAGINE HAVING 16K OF SOFTWARE ON LINE AT ALL TIME!

KIT FEATURES:

1. Double sided PC board with solder mask and silk screen and gold plated contact fingers.
 2. Selectable wait states.
 3. All address lines & data lines buffered!
 4. All sockets included.
 5. On card regulators.
- KIT INCLUDES ALL PARTS AND SOCKETS** (except 2708's). Add \$25. for assembled and tested.

S-100 (Imsai/Altair) Buss Compatible!

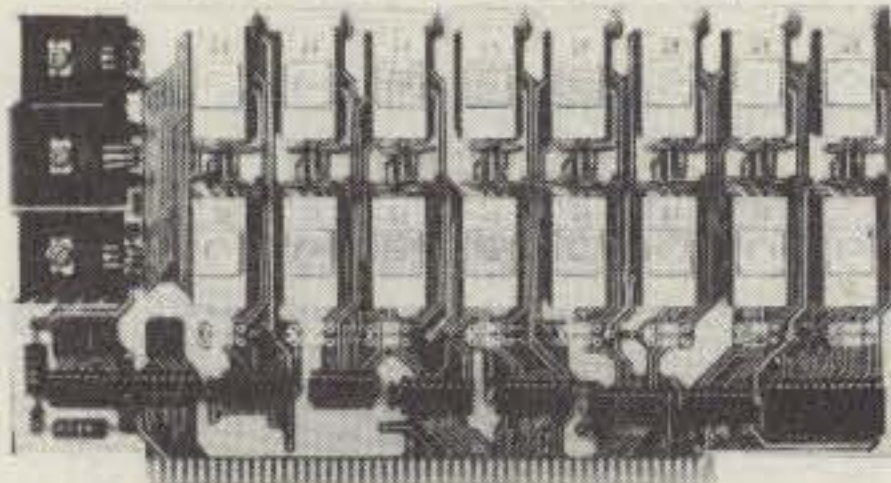

PRICE CUT!

\$57.50 kit

SPECIAL OFFER:

WAS \$69.95

Our 2708's (450NS) are \$8.95 when purchased with above kit.

Fully Static!

8K LOW POWER RAM KIT - \$149.00

S-100 (Imsai/Altair) Buss Compatible!

2 KITS FOR \$279

KIT FEATURES:

1. Doubled sided PC Board with solder mask and silk screen layout. Gold plated contact fingers.
2. All sockets included.
3. Fully buffered on all address and data lines.
4. Phantom is jumper selectable to pin 67.
5. FOUR 7805 regulators are provided on card.

ADD \$20 FOR 250NS

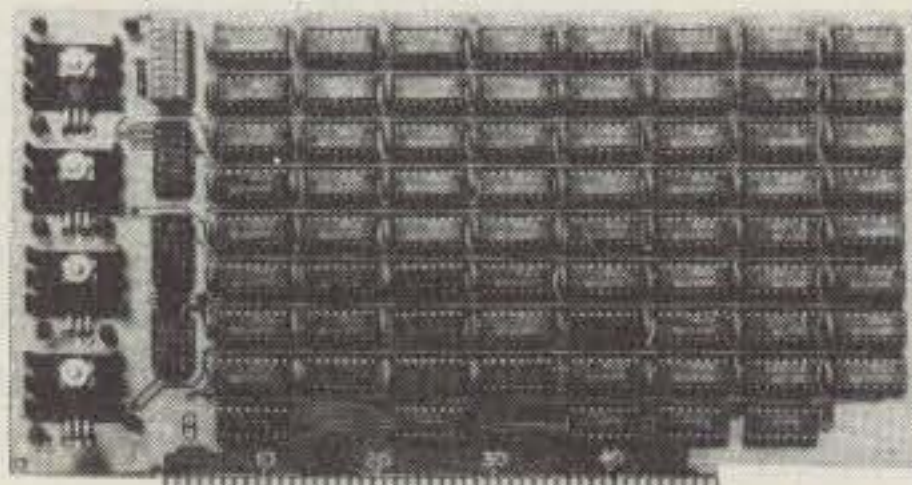

USES 21L02 RAM'S!

Fully Assembled & Burned In

\$179.00

Blank PC Board w/ Documentation

\$29.95

Low Profile Socket Set 13.50

Support IC's (TTL & Regulators)

\$9.75

Bypass CAP's (Disc & Tantalums)

\$4.50

MOTOROLA QUAD OP - AMP
MC 3401. PIN FOR PIN SUB.
FOR POPULAR LM 3900.

3 FOR \$1

ALARM CLOCK CHIP
N.S. MM5375AA. Six Digits.
With full Data. New!

\$2.49 each

FULL WAVE BRIDGE
4 AMP. 200 PIV.

69¢ 10 FOR \$5.75

NOT ASSOCIATED WITH DIGITAL
RESEARCH OF CALIFORNIA, THE
SUPPLIERS OF CPM SOFTWARE.

MOTOROLA 7805R VOLTAGE REGULATOR
Same as standard 7805 except 750 MA output.
TO-220. 5VDC output.

44c each or 10 for \$3.95

450 NS! 2708 EPROMS
Now full speed! Prime new units from a major U.S. Mfg. 450 N.S.
Access time. 1K x 8. Equiv. to 4-1702 A's in one package.

~~\$15.75 ea.~~ **\$9.95** ~~4 FOR \$50.00~~
PRICE CUT

16K STATIC RAM KIT

OUR LATEST COMPUTER KIT!

FULLY S-100 COMPATIBLE!

FULLY STATIC, AT DYNAMIC PRICES!

WHY THE 2114 RAM CHIP?

We feel the 2114 will be the next industry standard RAM chip (like the 2102 was). This means price, availability, and quality will all be good! Next, the 2114 is FULLY STATIC! We feel this is the ONLY way to go on the S-100 Buss! We've all heard the HORROR stories about some Dynamic Ram Boards having trouble with DMA and FLOPPY DISC DRIVES. Who needs these kinds of problems? And finally, even among other 4K Static RAM's the 2114 stands out! Not all 4K static Rams are created equal! Some of the other 4K's have clocked chip enable lines and various timing windows just as critical as Dynamic RAM's. Some of our competitor's 16K boards use these "tricky" devices. But not us! The 2114 is the ONLY logical choice for a trouble-free, straightforward design.

BRAND NEW!

\$359.00
COMPLETE KIT

SPECIAL
INTRODUCTORY OFFER!
Buy 2 KITS (32K) for \$650
450 NS

Blank PC Board with Documentation

\$33.00

LOW PROFILE SOCKET SET - \$12.00

ASSEMBLED & TESTED - ADD \$30.00

2114's 4K RAM's - 8 FOR \$69.95

KIT FEATURES:

1. Addressable as four separate 4K Blocks.
2. ON BOARD BANK SELECT circuitry. (Cromemco Standard!) Allows up to 512K on line!
3. Uses 2114 (450NS) 4K Static Rams.
4. ON BOARD SELECTABLE WAIT STATES.
5. Double sided PC Board, with solder mask and silk screened layout. Gold plated contact fingers.
6. All address and data lines fully buffered.
7. Kit includes ALL parts and sockets.
8. PHANTOM is jumpered to PIN 67.
9. LOW POWER: under 2amps TYPICAL from the +8 Volt Buss.
10. Blank PC Board can be populated as any multiple of 4K.

SUPER SPECIAL: BUY 32 KITS (512 KILOBYTES) (8-64K BANKS) for \$9,995.00

NATIONAL SEMICONDUCTOR JUMBO CLOCK MODULE



ASSEMBLED! NOT A KIT!

ZULU VERSION!
We have a limited number of the 24 HR Real time version of this module in stock
#MA1008D - \$9.95

PERFECT FOR USE WITH A TIMEBASE.

\$6.95

2 FOR \$13

(AC XFMR \$1.95)

COMPARE AT UP TO TWICE OUR PRICE!

MANUFACTURER'S CLOSEOUT!

MA1008A
BRAND NEW!

- FEATURES:
- FOUR JUMBO 1/2 INCH LED DISPLAYS
 - 12 HR REAL TIME FORMAT
 - 24 HR ALARM SIGNAL OUTPUT
 - 50 OR 60 Hz OPERATION
 - LED BRIGHTNESS CONTROL
 - POWER FAILURE INDICATOR
 - SLEEP & SNOOZE TIMERS
 - DIRECT LED DRIVE (LOW RFI)
 - COMES WITH FULL DATA

SALE!
1N4148 DIODES. SILICON.
Same as 1N914. New, factory prime, Full Leads.
100 FOR \$2
1000 FOR \$17.50

New! REAL TIME
Computer Clock Chip
N.S. MM5313. Features BOTH 7 segment and BCD outputs. 28 Pin DIP. \$4.95 with Data

MICRO-MINI TOGGLE SWITCH



99¢ EACH

SPDT. By RAYTHEON. MADE IN USA! WITH HDWR.

6 FOR \$5

Digital Research Corporation

(OF TEXAS)

P. O. BOX 401247 • GARLAND, TEXAS 75040 • (214) 271-2461

TERMS: Add 30¢ postage, we pay balance. Orders under \$15 add 75¢ handling. No C.O.D. We accept Visa, MasterCard, and American Express cards. Tex. Res. add 5% Tax. Foreign orders (except Canada) add 20% P & H. 90 Day Money Back Guarantee on all items.

DC PANEL METER

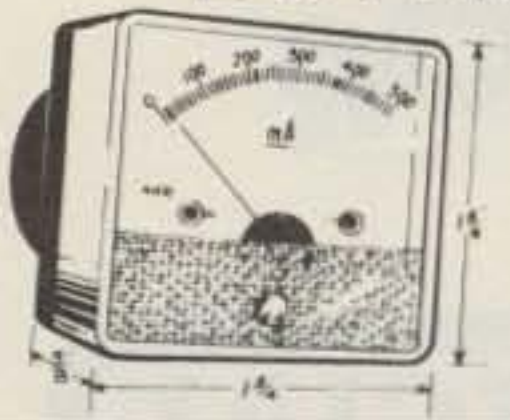

TDP QUALITY.
SMALL SIZE.
500 MA. F.S.

\$2⁹⁹ each

POWER RESISTORS



15 OHM 22W - 3 FOR \$1
150 OHM 5W - 5 FOR \$1



TRIM POTS

MINIATURE SIZE!
100 K OHMS



6 FOR \$1

CLAIREX OPTO ISOLATORS

Lamp and Photocell combination.
Lamp is 5 volts. Photocell range is 100K OFF, to 300 OHMS ON.



2 FOR \$1

EXPERIMENTERS PHOTO AMPLIFIER

Mini Dip, 8 Pin Clear Package. MFG. for a large camera outfit. Contains a silicon light sensor and some sort of OP AMP. Sorry, **NO DATA**. You figure them out!
SUPER DEAL!

2 FOR \$1

EXPERIMENTER CRYSTAL #5

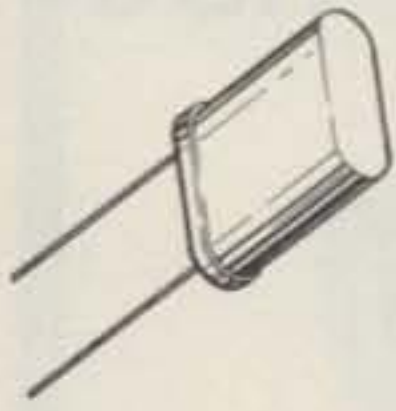

4.000 MHZ
Perfect for Micro Processors

\$1⁷⁵ each

HP LED READOUTS



NINE DIGITS.
COMMON CATHODE. NEW!
#5082-7430

75¢ 3 FOR \$2

ITT READOUT DRIVER IC

#508
HAS 8 DARLINGTON
DIGIT DRIVERS.
18 PIN DIP.

3 FOR \$1

RESISTOR NETWORK

By CTS. Has eight 5.6K Resistors in one 16 PIN DIP.

4 FOR \$1



EXPERIMENTERS KEYBOARD

Brand New by Digitran.
Used in Hand Held Calculators.

75¢ 3 FOR \$2

SCIENTIFIC CALCULATOR SET

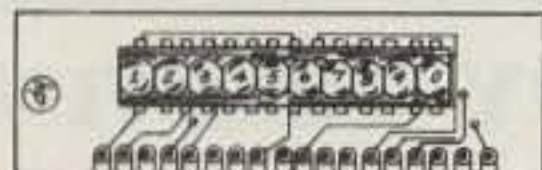

WITH MEMORY!

CONSISTS OF MOSTEK MK50310 CHIP (FEATURES SCIENTIFIC NOTATION), MATCHING DIGITRAN KEYBOARD, AND HEWLETT PACKARD 10 DIGIT READOUT. REQUIRES ONLY 12 VDC and 2-75492 DRIVERS TO OPERATE. **WITH DATA!** USE YOUR IMAGINATION AND BUILD INTO YOUR OWN EXOTIC ENCLOSURE. **VERY LIMITED STOCK. COMPUTES TO 10⁹⁹.**

\$3⁹⁹

(FOR ALL 3 PIECES!)

PLUG IN CLOCK TRANSFORMER



11.3 VAC 1.9 WATTS.

LIMITED STOCK **\$1⁹⁹** each

FACTORY SECONDS

MINI DIGITAL ALARM CLOCKS



SECONDS AND DISTRIBUTOR RETURNS. MOST ARE EASILY REPAIRED. (COLD SOLDER JOINTS, ETC.) FEATUES MOSTEK MK50250 CLOCK CHIP. THESE ARE COMPLETE UNITS, **NOT KITS**. ORIGINALLY SOLD FOR \$39.95, SOLD AS IS, **NO WARRANTY**. MEASURES ONLY 2 3/4 IN. CUBIC.

WITH SCHEMATIC!

LIMITED STOCK!

\$5⁹⁹ each

RADAR DETECTOR BOARDS

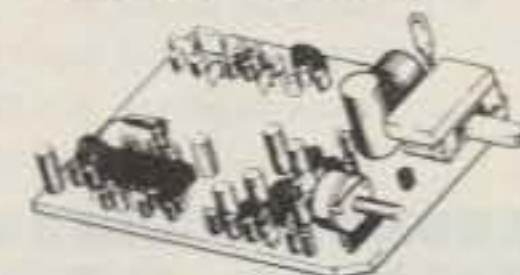

MAIN PC BOARDS USED IN "X" BAND DETECTORS. **ALL NEW**. MANY GOOD PARTS. SORRY, **NO DATA**.

LIMITED STOCK! **\$1⁴⁹** each

Digital Research Corporation ✓ D20
(OF TEXAS)

P.O. BOX 401247 • GARLAND, TEXAS 75041 • (214) 271-2461

TERMS: Add 30¢ postage, we pay balance. Orders under \$15 add 75¢ handling. No C.O.D. We accept Visa, MasterCard, and American Express cards. Tex. Res. add 5% Tax. Foreign orders (except Canada) add 20% P & H. 90 Day Money Back Guarantee on all items.

IT'S THE TIME OF THE YEAR FOR SPECIALS!

NO-TIME-LIKE-THE-PRESENT SPECIAL

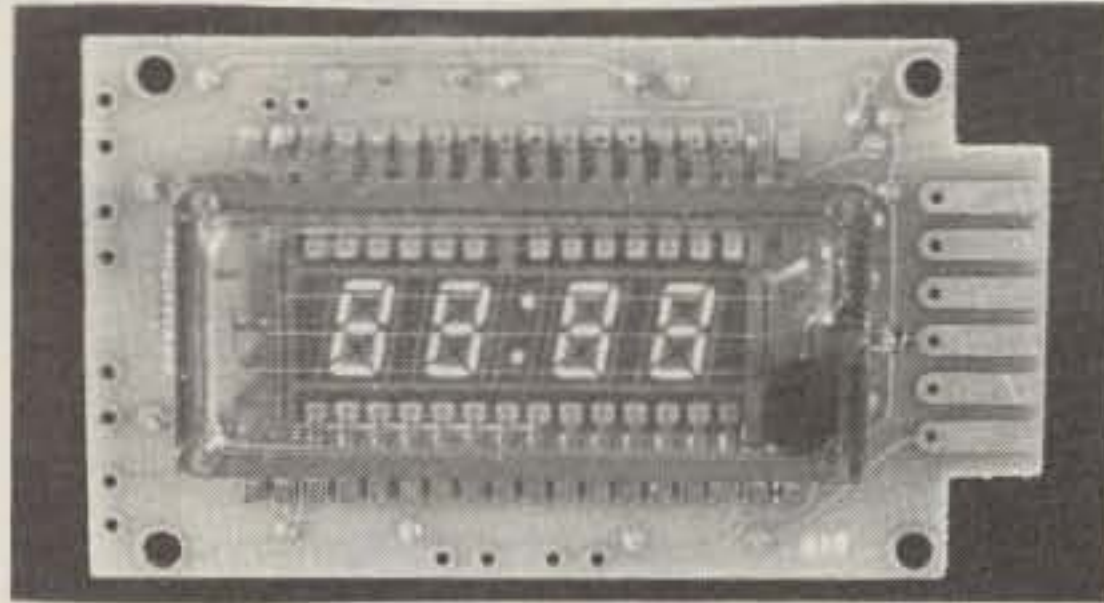

We think the MA1003 clock module is the best clock module going . . . add three time-setting switches, a source of power, and you're up and running. It has its own crystal controlled timebase so you can run it from 12V DC — ideal for car, van, truck, boat, field day, or any other mobile application. Large (0.3") blue-green fluorescent readouts are visible under ambient light conditions that would wash out LEDs. Also, there are special options for car applications (for example, turning on headlights dims the display slightly for night viewing). All in all, whether you need one for yourself or want to present someone with a neat gift, this is an excellent choice. Includes applications data.

Our regular price is \$16.50 each, or 3/\$46. But if you order before November 30, 1978 and mention the magic words "73 Magazine", take 5% off. There's no time like the present!

12 VOLT, 8 AMP POWER SUPPLY: \$44.50

This isn't exactly a special, but then again we haven't raised the price in quite some time . . . in this day and age, that counts for something.

This supply is ideal for powering anything that needs 12V DC with a lot of current capacity, such as transceivers, portable TVs and tape players, monitoring equipment, or even bunches of floppy disc drives. Handles 12A with a 50% duty cycle. Includes crowbar overvoltage protection, current limiting, adjustable output 11-14V, custom wound extra-heavy duty transformer, filter caps, and rectifier diodes mount on circuit board). Does not include case or hardware. With full assembly instructions.



HEATH H8 MEMORY SPECIAL



Heath H8 owners are recognizing that Econoram VI™ offers a truly superior value; where else can you find a 12K board at this price that is fully static, draws a minimal amount of current, and is expressly engineered for full electrical and mechanical compatibility with the H8? Our regular price is \$235 per "unkit" (sockets and bypass caps are pre-soldered in place), but if you mention our special you can now have two "unkits" for only \$399. This is a limited quantity special, so don't delay if your H8 is looking for more memory.

CRYSTALS

Whenever we advertise crystals they always sell well. Here's hoping the magic continues to work —

| | |
|-----------|---|
| XT500K | 500 KHz, series mode, fundamental, wire leads, HC6/U package . . . \$4.95 |
| XT1M | Same as above, but 1 MHz . . . \$5.95 |
| XT1.84320 | Same as above, but 1.84320 MHz . . . \$5.95 |
| XT2M | Same as above, but 2 MHz . . . \$5.95 |
| XT3.58M | Same as above, but colorburst (3.58 MHz) . . . \$2.25 |
| XT4M | 4 MHz, series mode, fundamental, HC18 pkg . . . \$4.95 |
| XT4.5315M | Same as above, but 4.5315 MHz . . . \$4.95 |
| XT5M | Same as above, but 5 MHz . . . \$4.95 |
| XT8M | Same as above, but 8 MHz . . . \$4.95 |
| XT9M | Same as above, but 9 MHz . . . \$4.95 |
| XT10M | Same as above, but 10 MHz . . . \$4.95 |
| XT12M | Same as above, but 12 MHz . . . \$4.95 |
| XT15M | Same as above, but 15 MHz . . . \$4.95 |
| XT18M | Same as above, but 18 MHz . . . \$4.95 |
| XT20M | Same as above, but 20 MHz . . . \$4.95 |

TERMINAL STRIPS: 30/\$2.00

There are two ways to buy terminal strips. Either go to your local chain store and pay through the nose for quantities of one, or stock up when you see a really good price. Needless to say, we recommend the latter. This is an assortment of 6 and 7 lug types (center lug grounded); no choice, but 7 lug strips predominate.

95H90 HIGH SPEED PRESCALER:

Here is a good price on an item that's pretty much mandatory for high frequency counter construction. While they last. **\$9.50**

A VERY QUIETING SPECIAL

Sprague 2 x 30 Amp Line Filter (stock #Z-048): \$22.50. We don't have that many of these hanging around, so if you know what they're good for, better order before the word gets around.

OUR FLYER LISTS MANY OUTSTANDING BARGAINS ALONG WITH OUR REGULAR REPERTOIRE OF MEMORY BOARDS, COMPUTER ITEMS, AND MUSIC KITS. SEND US YOUR NAME AND ADDRESS, AND WE'LL GET ONE TO YOU RIGHT AWAY. NEED IT IMMEDIATELY? AVOID THE BULK RATE DELAY BY SENDING US 41¢ AND WE'LL SEND IT OUT FIRST CLASS.

GODBOUT

BILL GODBOUT ELECTRONICS
BOX 2355, OAKLAND AIRPORT, CA 94614

TERMS: Add \$1 handling to orders under \$15. Allow up to 5% shipping, more for 12V supply (excess refunded). We prefer street address for UPS deliver. VISA®/Mastercharge® (\$15 min) call our 24 hr. order desk at (415) 562-0636. CODs OK with street address. Californians add sales tax. ✓ G4



ELPAC POWER SUPPLIES

Completely Assembled

SPECIFICATIONS:

105-125/210-250 Vac, 47-440 Hz Input:

- Line Regulation $\pm 0.1\%$
- Load Regulation $\pm 0.1\%$ no-load to rated-load
- Output Ripple and Noise $\pm 0.1\%$ p-p dc to 10 MHz
- Input/Output Isolation 100 megohm dc, 900 Vac
- Short Circuit Current 35% rated current

| PART NO. | RATINGS | | | PRICE |
|--------------------------------------|--|-------|------|---------|
| | WATTS | VOLTS | AMPS | |
| SOLV15-5* | 15 | 5 | 3 | \$39.95 |
| SOLV15-12* | 18 | 12 | 1.5 | 39.95 |
| SOLV30-5 | 30 | 5 | 6 | 59.95 |
| SOLV30-12 | 48 | 12 | 4 | 59.95 |
| OVP1 | over voltage protection for SOLV30-5,-12 | | | 9.95 |
| *SOLV15-5, 12 includes OVP installed | | | | |

SUP 'R' MOD II

UHF Channel 33 TV Interface Unit Kit



- Wide Band B/W or Color System
- Converts TV to Video Display for home computers, CCTV camera, Apple II, works with Cromeco Dazzler, SOL-20, IRS-80, Challenger, etc.
- MOD II is pretuned to Channel 33 (UHF).
- Includes coaxial cable and antenna transformer.

MOD II \$29.95 Kit

CRYSTALS

THESE FREQUENCIES ONLY

| PART NO. | FREQUENCY | CASE | PRICE |
|----------|-------------|------|-------|
| CY1A | 1.000MHz | HC33 | 5.95 |
| CY1.84 | 1.8432MHz | HC33 | 5.95 |
| CY2A | 2.000MHz | HC33 | 5.95 |
| CY2.01 | 2.010MHz | HC33 | 1.95 |
| CY2.50 | 2.500MHz | HC33 | 4.95 |
| CY3.27 | 3.2768MHz | HC33 | 4.95 |
| CY3.57 | 3.579545MHz | HC33 | 4.95 |
| CY3A | 4.000MHz | HC18 | 4.95 |
| CY4.91 | 4.915MHz | HC18 | 4.95 |
| CY7A | 5.000MHz | HC18 | 4.95 |
| CY5.18 | 5.185MHz | HC18 | 4.95 |
| CY6.14 | 6.144MHz | HC18 | 4.95 |
| CY8.40 | 6.400MHz | HC18 | 4.95 |
| CY6.55 | 6.5536MHz | HC18 | 4.95 |
| CY12A | 10.000MHz | HC18 | 4.95 |
| CY14A | 14.31818MHz | HC18 | 4.95 |
| CY19A | 18.000MHz | HC18 | 4.95 |
| CY18.43 | 18.432MHz | HC18 | 4.95 |
| CY22A | 20.000MHz | HC18 | 4.95 |
| CY30A | 32.000MHz | HC18 | 4.95 |

Custom Cables & Jumpers



DB 25 Series Cables

| Part No. | Cable Length | Connectors | Price |
|-----------|--------------|---------------|-------------|
| DB25P-4-P | 4 Ft. | 2-DP25P | \$15.95 ea. |
| DB25P-4-S | 4 Ft. | 1-DP25P/1-25S | \$16.95 ea. |
| DB25S-4-S | 4 ft. | 2-DP25S | \$17.95 ea. |

Dipped Jumpers Plugs

| Part No. | Length | Pin Config | Price |
|-----------|--------|------------|------------|
| DJ14-1 | 1 ft. | 1-14 Pin | \$1.59 ea. |
| DJ16-1 | 1 ft. | 1-16 Pin | 1.79 ea. |
| DJ24-1 | 1 ft. | 1-24 Pin | 2.79 ea. |
| DJ14-1-14 | 1 ft. | 2-14 Pin | 2.79 ea. |
| DJ16-1-16 | 1 ft. | 2-16 Pin | 3.19 ea. |
| DJ24-1-16 | 1 ft. | 2-24 Pin | 4.95 ea. |

For Custom Cables & Jumpers, See JAMECO 1979 Catalog for Pricing

1/16 VECTOR BOARD

| Part No. | Material | Dimensions | Price |
|----------|----------------|--------------|-------|
| PHENOLIC | 54P44 052XXXP | 4.50 x 6.50 | 1.72 |
| PHENOLIC | 169P44 062XXXP | 4.50 x 7.00 | 3.89 |
| EPOXY | 64P44 062WE | 4.50 x 6.50 | 2.07 |
| EPOXY | 84P44 062WE | 4.50 x 8.50 | 2.56 |
| EPOXY | 169P44 062WE | 4.50 x 17.00 | 5.04 |
| EPOXY | 169P44 062WE | 8.50 x 17.00 | 9.23 |
| EPOXY | 169P44 062WEC1 | 4.50 x 17.00 | 6.80 |

CONNECTORS

25 Pin-D Subminiature

| | | |
|--------------------|-----------------------------|--------|
| DB25P(as pictured) | PLUG | \$2.95 |
| DB25S | SOCKET | 3.50 |
| DB51225-1 | Cable Cover for DB25 P or S | 1.75 |

MOLEX CONNECTOR PINS

| | |
|---------|---------------------------------|
| M-530-1 | \$1.95/100 pins (minimum order) |
| | \$16.00/1000 pins |

INSTRUMENT/CLOCK CASE

Injection molded unit. Complete with red bezel. 4 1/2" x 4" x 1-9/16"

\$3.49

MICROPROCESSOR COMPONENTS

| | | | |
|----------------------------------|---------|---|---------|
| COP 1802 CPU | \$19.95 | Z80(780C) CPU | \$19.95 |
| P8085 CPU | 19.95 | Z80A(708-1)CPU | 24.95 |
| 8080A CPU | 9.95 | 2650 MPU | 26.50 |
| 8212 8-Bit Input/Output | 3.25 | MC6800 MPU | 14.95 |
| 8214 Priority Interrupt Control | 5.95 | MC6810API 128 x 8 Static Ram | 5.95 |
| 8216 Bi-Directional Bus Driver | 3.49 | MC6821 Periph. Interface Adapter(6820) 7.49 | |
| 8224 Clock Generator/Driver | 3.95 | MC6830L8 1024 x 8 Bit ROM(68A30) | 14.95 |
| 8228 System Controller/BusDriver | 5.95 | MC6850 Asynchronous Comm Adapter | 7.95 |
| 8251 Prog. Comm. Interface | 7.95 | MC6852 Syn. Serial Data Adapter | 9.95 |
| 8253 Prog. Interval Timer | 14.95 | MC6880 (MC6726) Quad Trn State Bus Trans. | 2.25 |
| 8255 Prog. Periph. Interface | 9.95 | MC6802 MPU w/Clock & Ram | 24.95 |
| 8257 Prog. DMA Control | 19.95 | | |

SPECIAL REQUESTED ITEMS

| TELEPHONE | ICM CHIPS | NMOS READ ONLY MEMORIES | MISCELLANEOUS |
|-------------------|-----------------|-------------------------|-----------------------|
| KEYBOARD CHIPS | ICM7045 \$24.95 | MC68571 \$13.50 | 11090 \$19.95 |
| AY-5-9100 \$14.95 | ICM7205 19.95 | MC68574 13.50 | MC3061P 11.95 |
| AY-5-9200 14.95 | ICM7207 7.50 | MC68575 13.50 | MC14081.7 4.95 |
| AY-5-9500 4.95 | ICM7208 19.95 | | MC14081.8 5.75 |
| AY-5-2376 14.95 | ICM7209 6.95 | | 95H90 11.95 |
| HD0165 7.95 | | | LD110/111 \$25.00/set |
| 74C922 9.95 | | | MC4016(74416) 7.50 |
| | | | 4N31 3.95 |

TV GAME CHIP SET

AY-3-9500-1 Chip and 2.010 MHz Crystal \$7.95

NEW

The Sinclair PDM35. A personal digital multimeter for only \$59.95

Now everyone can afford to own a digital multimeter.

The Sinclair PDM35 is supplied in a plastic carrying case with test leads and probes. Includes a user's manual and Operator's Manual.

The Sinclair PDM35 is a fully automatic digital multimeter. It features a large LCD display, auto-ranging, and a 3 1/2 digit display. It can measure DC voltage, AC voltage, DC current, AC current, resistance, and continuity.

| PART NO. | DESCRIPTION | PRICE |
|----------|---|---------|
| PDM35 | Digital Multimeter (Completely Assembled) | \$59.95 |
| PDM-AC | 117 volt AC Adapter | 6.95 |
| PDM-DP | Deluxe padded carrying case | 6.95 |

BK PRECISION 3 1/2-Digit Portable DMM

- Overload Protected
- 1" high LED Display
- Battery or AC operation
- Auto Zeroing
- 1mv, 1ua, 0.1 ohm resolution
- Overrange warning
- 10 meg input impedance
- DC Accuracy 1% typical

Ranges: DC Voltage - 0-1000V
AC Voltage - 0-1000V
Freq. Response - 50-400 Hz
DC/AC Current - 0-100mA
Resistance - 0-10 meg ohm
Size - 4" x 4" x 2"

Model 2800 \$99.95

Includes test leads, operating manual and spare fuse

100 MHz 8-Digit Counter

- 20 Hz-100 MHz Range
- Four power sources: 4 x batteries, 110 or 220V with charger
- Crystal-controlled timebase
- Fully Automatic
- Portable - completely self-contained
- Size - 1.75" x 7.38" x 5.63"

MAX-100 \$134.95

Accessories:
AC Adapter BC-28 \$9.00
Rechargeable Batteries BP-26 20.00
Carrying Case LC-28 7.50

KEYBOARDS Hexadecimal Key Pad

63-Key Unencoded Keyboard

This is a 63-key, terminal keyboard newly manufactured by a large computer manufacturer. It is unencoded with SPST keys, unattached to any kind of PC board. A very solid molded plastic 13 x 4" base suits most applications. **IN STOCK \$29.95/each**

19-key pad includes 1-10 keys, ABCDEF and 2 optional keys and a shift key. \$10.95/each

\$5.00 Minimum Order - U.S. Funds Only California Residents - Add 6% Sales Tax Spec Sheets - 25¢ 1979 A Catalog Available - Send 41¢ stamp

NEW 1979 Catalog

Jameco ELECTRONICS

MAIL ORDER ELECTRONICS - WORLDWIDE ✓ J1
1021 HOWARD AVENUE, SAN CARLOS, CA 94070
Advertised Prices Good Thru November

PHONE ORDERS WELCOME (415) 592-8097

The Incredible "Pennywhistle 103" \$139.95 Kit Only

The Pennywhistle 103 is capable of recording data to and from audio tape without critical speed requirements for the recorder and it is able to communicate directly with another modern terminal for telephone "teaming" and communications. In addition, it is free of critical adjustments and is built with non-precision, readily available parts.

Data Transmission Method - Frequency Shift Keying, full-duplex (half-duplex selectable)

Maximum Data Rate - 300 Baud

Data Format - Asynchronous Serial (return to mark level required between each character)

Receive Channel Frequencies - 2025 Hz for space, 2225 Hz for mark

Transmit Channel Frequencies - Switch selectable: Low (normal) - 1070 space, 1270 mark; High - 025 space, 2225 mark

Receive Sensitivity - -46 dbm acoustically coupled

Transmit Level - 15 dbm nominal, Adjustable from -6 dbm to -20 dbm

Receive Frequency Tolerance - Frequency reference automatically adjusts to allow for operation between 1800 Hz and 2400 Hz

Digital Data Interface - EIA RS-232C or 20 mA current loop (receiver is optoisolated and non-polar)

Power Requirements - 120 VAC, single phase, 10 Watts

Physical - All components mount on a single 5" by 9" printed circuit board. All components included. Frequency Counter and/or Oscilloscope to align.

The Original the 3rd Hand \$9.95 each

- Leaves two hands free for working
- Clamps on edge of bench, table or work bench
- Position board on angle or flat position for soldering or clipping
- Sturdy, aluminum construction for hobbyist, manufacturer or school rooms

TRS-80 16K Conversion Kit

Expand your 4K TRS-80 System to 16K. Kit comes complete with:

- * 8 each UPD416 (16K Dynamic Rams)
- * Documentation for conversion

TRS-16K \$115.00

Special Offer - Order both your TRS-16K and the Sup'R' MOD II Interface kit together (retail value \$144.95) for only \$139.95

IMK 3 1/2 DIGIT DPM KIT

- New Bipolar Unit
- Auto Zeroing
- 5" LED
- Auto Polarity
- Low Power
- Single IC Unit

Model KB500 DPM Kit \$49.00 Model KB503 5V Power Kit \$17.50

JE701 Clock Kit \$19.95 per Kit

- 6 Digit, 300 Height Common Cathode Display
- Uses MM5314 Clock Chip
- Push Button Switches for setting Hours, Minutes & Hold
- Easily Viewable to 20 Feet
- Simulated Walnut Case
- 115 VAC Operation
- 12 or 24 Hour Format
- Includes all Components & Case

JE803 PROBE \$9.95 Per Kit

The Logic Probe is a unit which is for the most part independent in insuring accurate logic functions. TTL, DTL, RTL, CMOS. It derives the power it needs to operate directly off of the circuit under test. Drawing a current 10 mA max. It uses a MAX91 leadout to indicate any of the following states by these symbols: (H) 1 (LOW) 0 (PULSE) P. The Probe can detect high frequency pulses to 45 MHz. It can't be used if MOS levels or circuit damage will result.

printed circuit board

T2L 5V 0.5A Supply \$9.95 Per Kit

This is standard TTL power supply using the well known LM309K regulator IC to provide a solid 0.5 AMP of current at 5 volts. We try to make things easy for you by providing everything you need in one package including the hardware for only

PROTO BOARDS

PROTO BOARD 6 \$15.95 (6" long X 4" wide)

| | |
|-------------------------------|--------------------------------|
| PB100 - 4.5" x 6" | \$ 19.95 |
| PB101 - 5.8" x 4.5" | 22.95 |
| PB102 - 7" x 4.5" | 26.95 |
| PB103 - 9" x 6" | 44.95 |
| PB104 - 9.5" x 8" | 54.95 |
| PB203 - 9.75 x 6 1/2 x 2 1/4 | 75.00 |
| PB203A - 9.75 x 6 1/2 x 2 1/4 | 124.95 (includes power supply) |

PROTO CLIPS

| | |
|--------|--------|
| 14 PIN | \$4.50 |
| 16 PIN | 4.75 |
| 24 PIN | 8.50 |
| 40 PIN | 13.75 |

| DIODES/ZENERS | | | | SOCKETS/BRIDGES | | | | TRANSISTORS, LEDS, etc. | | | | | |
|---------------|-------|--------------|-----|-----------------|-----|--------------|------|-------------------------|-------------------------------|---------------------------|--|--|------|
| 1N914 | 100v | 10mA | .05 | 8-pin | pcb | .20 | ww | .35 | 2N2222 | NPN (2N2222 Plastic .10) | | | .15 |
| 1N4005 | 600v | 1A | .08 | 14-pin | pcb | .20 | ww | .40 | 2N2907 | PNP | | | .15 |
| 1N4007 | 1000v | 1A | .15 | 16-pin | pcb | .20 | ww | .40 | 2N3906 | PNP (Plastic - Unmarked) | | | .10 |
| 1N4148 | 75v | 10mA | .05 | 18-pin | pcb | .25 | ww | .75 | 2N3904 | NPN (Plastic - Unmarked) | | | .10 |
| 1N4733 | 5.1v | 1 W Zener | .25 | 22-pin | pcb | .35 | ww | .95 | 2N3054 | NPN | | | .35 |
| 1N753A | 6.2v | 500 mW Zener | .25 | 24-pin | pcb | .35 | ww | .95 | 2N3055 | NPN 15A 60v | | | .50 |
| 1N758A | 10v | " | .25 | 28-pin | pcb | .45 | ww | 1.25 | T1P125 | PNP Darlington | | | .95 |
| 1N759A | 12v | " | .25 | 40-pin | pcb | .50 | ww | 1.25 | LED Green, Red, Clear, Yellow | | | | |
| 1N5243 | 13v | " | .25 | Molex pins | .01 | To-3 Sockets | .25 | | D.L.747 | 7 seg 5/8" High com-anode | | | 1.95 |
| 1N5244B | 14v | " | .25 | 2 Amp Bridge | | 100-prv | .95 | | MAN72 | 7 seg com-anode (Red) | | | 1.25 |
| 1N5245B | 15v | " | .25 | 25 Amp Bridge | | 200-prv | 1.95 | | MAN3610 | 7 seg com-anode (Orange) | | | 1.25 |
| | | | | | | | | | MAN82A | 7 seg com-anode (Yellow) | | | 1.25 |
| | | | | | | | | | MAN74A | 7 seg com-cathode (Red) | | | 1.50 |
| | | | | | | | | | FND359 | 7 seg com-cathode (Red) | | | 1.25 |

| C MOS | | - T T L - | | | | | | | | | |
|-------|------|-----------|------|-------|------|--------|------|--------|------|---------------|------|
| 4000 | .15 | 7400 | .10 | 7473 | .25 | 74176 | .85 | 74H72 | .35 | 74S133 | .40 |
| 4001 | .15 | 7401 | .15 | 7474 | .30 | 74180 | .55 | 74H101 | .75 | 74S140 | .55 |
| 4002 | .20 | 7402 | .15 | 7475 | .35 | 74181 | 2.25 | 74H103 | .55 | 74S151 | .30 |
| 4004 | 3.95 | 7403 | .15 | 7476 | .40 | 74182 | .75 | 74H106 | .95 | 74S153 | .35 |
| 4006 | .95 | 7404 | .10 | 7480 | .55 | 74190 | 1.25 | | | 74S157 | .75 |
| 4007 | .20 | 7405 | .25 | 7481 | .75 | 74191 | .95 | 74L00 | .25 | 74S158 | .30 |
| 4008 | .75 | 7406 | .25 | 7483 | .75 | 74192 | .75 | 74L02 | .20 | 74S194 | 1.05 |
| 4009 | .35 | 7407 | .55 | 7485 | .55 | 74193 | .85 | 74L03 | .25 | 74S257 (8123) | 1.05 |
| 4010 | .35 | 7408 | .15 | 7486 | .25 | 74194 | .95 | 74L04 | .30 | | |
| 4011 | .20 | 7409 | .15 | 7489 | 1.05 | 74195 | .95 | 74L10 | .20 | 74LS00 | .20 |
| 4012 | .20 | 7410 | .15 | 7490 | .45 | 74196 | .95 | 74L20 | .35 | 74LS01 | .20 |
| 4013 | .40 | 7411 | .25 | 7491 | .70 | 74197 | .95 | 74L30 | .45 | 74LS02 | .20 |
| 4014 | .75 | 7412 | .25 | 7492 | .45 | 74198 | 1.45 | 74L47 | 1.95 | 74LS04 | .20 |
| 4015 | .75 | 7413 | .25 | 7493 | .35 | 74221 | 1.00 | 74L51 | .45 | 74LS05 | .25 |
| 4016 | .35 | 7414 | .75 | 7494 | .75 | 74367 | .75 | 74L55 | .65 | 74LS08 | .25 |
| 4017 | .75 | 7416 | .25 | 7495 | .60 | | | 74L72 | .45 | 74LS09 | .25 |
| 4018 | .75 | 7417 | .40 | 7496 | .80 | 75108A | .35 | 74L73 | .40 | 74LS10 | .25 |
| 4019 | .35 | 7420 | .15 | 7496 | .80 | 75491 | .50 | 74L74 | .45 | 74LS11 | .25 |
| 4020 | .85 | 7426 | .25 | 74100 | 1.15 | 75492 | .50 | 74L75 | .55 | 74LS20 | .20 |
| 4021 | .75 | 7427 | .25 | 74107 | .25 | | | 74L93 | .55 | 74LS21 | .25 |
| 4022 | .75 | 7430 | .15 | 74121 | .35 | | | 74L123 | .85 | 74LS22 | .25 |
| 4023 | .20 | 7432 | .20 | 74122 | .55 | | | | | 74LS32 | .25 |
| 4024 | .75 | 7437 | .20 | 74123 | .35 | 74H00 | .15 | | | 74LS37 | .25 |
| 4025 | .20 | 7438 | .20 | 74125 | .45 | 74H01 | .20 | 74S00 | .35 | 74LS38 | .35 |
| 4026 | 1.95 | 7440 | .20 | 74126 | .35 | 74H04 | .20 | 74S02 | .35 | 74LS40 | .30 |
| 4027 | .35 | 7441 | 1.15 | 74132 | .75 | 74H05 | .20 | 74S03 | .25 | 74LS42 | .65 |
| 4028 | .75 | 7442 | .45 | 74141 | .90 | 74H08 | .35 | 74S04 | .25 | 74LS51 | .35 |
| 4030 | .35 | 7443 | .45 | 74150 | .85 | 74H10 | .35 | 74S05 | .35 | 74LS74 | .35 |
| 4033 | 1.50 | 7444 | .45 | 74151 | .65 | 74H11 | .25 | 74S08 | .35 | 74LS86 | .35 |
| 4034 | 2.45 | 7445 | .65 | 74153 | .75 | 74H15 | .45 | 74S10 | .35 | 74LS90 | .55 |
| 4035 | .75 | 7446 | .70 | 74154 | .95 | 74H20 | .25 | 74S11 | .35 | 74LS93 | .55 |
| 4040 | .75 | 7447 | .70 | 74156 | .70 | 74H21 | .25 | 74S20 | .25 | 74LS107 | .40 |
| 4041 | .69 | 7448 | .50 | 74157 | .65 | 74H22 | .40 | 74S40 | .20 | 74LS123 | 1.00 |
| 4042 | .65 | 7450 | .25 | 74161 | .55 | 74H30 | .20 | 74S50 | .20 | 74LS151 | .75 |
| 4043 | .50 | 7451 | .25 | 74163 | .85 | 74H40 | .25 | 74S51 | .25 | 74LS153 | .75 |
| 4044 | .65 | 7453 | .20 | 74164 | .60 | 74H50 | .25 | 74S64 | .15 | 74LS157 | .75 |
| 4046 | 1.25 | 7454 | .25 | 74165 | 1.10 | 74H51 | .25 | 74S74 | .35 | 74LS164 | 1.00 |
| 4049 | .45 | 7460 | .40 | 74166 | 1.25 | 74H52 | .15 | 74S112 | .60 | 74LS193 | .95 |
| 4050 | .45 | 7470 | .45 | 74175 | .80 | 74H53J | .25 | 74S114 | .65 | 74LS367 | .75 |
| 4066 | .55 | 7472 | .40 | | | 74H55 | .20 | | | 74LS368 | .65 |

| 9000 SERIES | | LINEARS, REGULATORS, etc. | | | | | | | | | |
|-------------|-----|---------------------------|------|-----------------|------|--------------|------|-------------------|------|--------------|------|
| 9301 | .85 | 95H03 | 1.10 | MCT2 | .95 | LM320T5 | 1.65 | LM340K15 | 1.25 | LM723 | .40 |
| 9309 | .35 | 9601 | .20 | 8038 | 3.95 | LM320T12 | 1.65 | LM340K18 | 1.25 | LM725N | 2.50 |
| 9322 | .65 | 9602 | .45 | LM201 | .75 | LM320T15 | 1.65 | LM340K24 | 1.25 | LM739 | 1.50 |
| | | | | LM301 | .45 | LM324N | 1.25 | 78L05 | .75 | LM741 (8-14) | .25 |
| | | | | LM308 (Mini) | .95 | LM339 | .75 | 78L12 | .75 | LM747 | 1.10 |
| | | | | LM309H | .65 | 7805 (340T5) | .95 | 78L15 | .75 | LM1307 | 1.25 |
| | | | | LM309K (340K-5) | .85 | LM340T12 | .95 | 78M05 | .75 | LM1458 | .65 |
| | | | | LM310 | .85 | LM340T15 | .95 | LM373 | 2.95 | LM3900 | .50 |
| | | | | LM311D (Mini) | .75 | LM340T18 | .95 | LM380 (8-14 PIN) | .95 | LM75451 | .65 |
| | | | | LM318 (Mini) | 1.75 | LM340T24 | .95 | LM709 (8, 14 PIN) | .25 | NE555 | .35 |
| | | | | LM320K5 (7905) | 1.65 | LM340K12 | 1.25 | LM711 | .45 | NE556 | .85 |
| | | | | LM320K12 | 1.65 | | | | | NE565 | .95 |
| | | | | | | | | | | NE566 | 1.25 |
| | | | | | | | | | | NE567 | .95 |

| MICRO'S, RAMS, CPU'S, E-PROMS | | | |
|-------------------------------|------|---------|------|
| 74S188 | 3.00 | 8214 | 8.95 |
| 1702A | 4.50 | 8224 | 3.25 |
| MM5314 | 3.00 | 8228 | 6.00 |
| MM5316 | 3.50 | 8251 | 8.50 |
| 2102-1 | 1.45 | 8255 | 8.50 |
| 2102L-1 | 1.75 | 8T13 | 1.50 |
| 2114 | 9.50 | 8T23 | 1.50 |
| TR1602B | 3.95 | 8T24 | 2.00 |
| TMS 4044 | 9.95 | 8T97 | 1.00 |
| | | 2107B-4 | 4.95 |
| 8080 | 8.95 | 2708 | 9.50 |
| 8212 | 2.95 | Z80 PIO | 8.50 |

INTEGRATED CIRCUITS UNLIMITED 19

7889 Clairemont Mesa Boulevard, San Diego, California 92111
(714) 278-4394 (Calif. Res.)

All orders shipped prepaid No minimum
Open accounts invited COD orders accepted

Discounts available at OEM Quantities California Residents add 6% Sales Tax
All IC's Prime/Guaranteed. All orders shipped same day received.

24 Hour Toll Free Phone 1-800-854-2211 American Express / BankAmericard / Visa / MasterCard

| SPECIAL DISCOUNTS | |
|-------------------|--------|
| Total Order | Deduct |
| \$35 - \$99 | 10% |
| \$100 - \$300 | 15% |
| \$301 - \$1000 | 20% |

POLY PAKS® DISCOUNT ALLEY

WE'RE PUTTING "GREENBACKS" IN YOUR POCKET!

Poly Paks, originator of the world famous PENNY SALE, now introduces DISCOUNT ALLEY, with the best bargains available anywhere! For any \$15 ad, TAKE 10% DISCOUNT! Or, for any \$50 shipment of material from this ad, TAKE 25% DISCOUNT! NOBODY GIVES THE CONSUMER DISCOUNTS LIKE POLY PAKS!

300 CFM HIGH POWER BLOWER
 Made by Fasco! For home, shop, industry! 115VAC, 2.2 Amps. Overall size 14" long x 4-3/4" wheel size 5/8 dia, 3" deep. Removed from new equipment. Wt. 12 lbs. Cat. No. 5165
\$12.50

NEW! DIGITAL CAPACITANCE METER KIT
 • 5 Ranges! Measure any capacitor value from 100 pF to 10,000 uF! Five ranges: 0-1uF, 10uF, 100uF, 1000uF, 10,000uF. Also tests leakage! Directly reads all types of capacitors at the touch of a button. Easy to assemble! Complete kit, nothing else required. With step-by-step instructions. Size 6 1/4 x 2 1/4 x 5 1/4" deep, vinyl covered wooden cabinet. Wt. 2 lbs.
 Cat. No. 5238 Capacitance Meter Kit \$69.95
 Cat. No. 5239 Capacitance Meter Wired \$95
 • Four .5" digits!
 • You've seen it at twice the price!

RIBBON CABLE AT THIN PRICES • Ultra flat! • 28 AWG

| Cond | Size | 3 ft. | 5 ft. | 10 ft. | 20 ft. |
|------|--------------|-------|--------------|--------------------------|--------------|
| 25 | 4 ft. \$1.98 | 36 | 3 ft. \$1.98 | 40 | 3 ft. \$1.98 |
| 26 | 4 ft. \$1.98 | 50 | 2 ft. \$1.98 | 50 | 2 ft. \$1.98 |
| 34 | 3 ft. \$1.98 | 80 | 2 ft. \$1.98 | No. 3839 and conductors. | |

SANYO AUDIO AMPLIFIER MODULES
 Easy to build a complete audio amplifier for hi-fi, tape, AM, FM, PA, and more! Response 20-20,000 Hz, less than 5% distortion at full power. Efficient heat radiating construction. Output 8 ohms. Size 3 1/4 x 2 x 1/4" thick approx. Wt. 8 oz. With instructions.

| Cat. No. | Type | Watts-RMS | Sale |
|----------|----------|-----------|--------|
| 5350 | STK-009 | 13 | \$8.88 |
| 5351 | STK-013 | 15 | 11.50 |
| 5352 | STK-028 | 20 | 14.88 |
| 5411 | STK-056 | 30 | 18.88 |
| 5228 | STK-050 | 50 | 26.88 |
| 5353 | STK-014* | 15x2 | 18.88 |

*Stereo

1N4000 EPOXY RECTIFIERS

| Cat. No. | Type | PIV | Sale |
|----------|--------|-----|-------------|
| 2377 | 1N4001 | 50 | 10 for .49 |
| 2378 | 1N4002 | 100 | 10 for .59 |
| 2379 | 1N4003 | 200 | 10 for .69 |
| 2380 | 1N4004 | 400 | 10 for .89 |
| 2381 | 1N4005 | 600 | 10 for 1.09 |
| 2382 | 1N4006 | 800 | 10 for 1.49 |

Order by Cat. No.

BLOCK FANS \$9.95
 For cooling, flushing, heating and ventilating! Quiet & dependable. Lightweight, flame retardant. 3 blades or better (sorry, no choosing). Removed from new equipment. Ship wt. 1 1/4 lbs. Cat. No. 92CU3108
 • Famous USA Makers! • 4-11/16" sq. 1 1/2" deep.

30 WATT STEREO AMPLIFIER KIT \$24.95
 Easy to build, assemble in minutes. Uses two 15 watt Hybrid Amplifier Modules with heat sinks included! Power output 2 x 15W RMS, both channels into 8 ohms from 40-22,000 Hz. Total distortion less than 1%. Size: 5 1/4 x 2-3/4" x 1". Wt. 1 lb. Cat. No. 5408 Made For Fisher!
 • Use with any preamp!

POCKET VOM \$8.88
 1% precision resistors, D'Arsonval movement with burnout protection. Measures DC volts 0-15-150-1000; AC Volts 0-15-150-1000; DC Current 0-150mA; Resistance X1000 ohms. Sensitivity 1000 ohms per volt AC/DC. Uses AA penlite cell, not included. Size 2-3/8" x 3 1/2" x 1-3/8". Wt. 6 oz. Cat. No. 3921
 • 1000 ohms per volt!

FREQUENCY COUNTER PRESCALER KIT \$24.95
 Fits inside our Frequency Counter Cabinet. Requires +5VDC, 100mA. With instructions. Works with all frequency counters!
 Cat. No. 5215 PRESCALER KIT \$24.95
 Cat. No. 5225 PRESCALER W/LED \$34.95 • Extends range to 500 MHz!

MICROPROCESSORS! MEMORIES! SUPPORT!
 Order by Cat. No. 3459 and type

| | |
|-------------|----------------|
| 8008 \$7.95 | 8259 19.95 |
| 8080A 9.95 | 2102-L1 \$1.59 |
| 8212 3.50 | 1103 .79 |
| 8214 7.95 | MMS260 .99 |
| 8216 3.50 | MMS262 .39 |
| 8224 3.50 | MMS280* 3.95 |
| 8228 6.95 | MK200P-11 3.95 |
| 8238 7.95 | MK4096 3.95 |
| 8251 9.95 | MK4116 19.95 |
| 8253 19.95 | 1702A 4.95 |
| 8255 10.50 | MMS202 2.95 |
| 8257 19.95 | 2708 10.95 |

SOLAR ENERGY DISCS
 Converts sunlight directly to electricity! All discs 0.5VDC. Add in series or parallel for higher voltages and amperages.

| Cat. No. | Size | mA | Sale |
|----------|--------|------|-------|
| 5046 | 2" | 200 | 3.95 |
| 3211 | 2 1/4" | 500 | 5.50 |
| 3862 | 3" | 1000 | 8.88 |
| 3788 | 3 1/2" | 1500 | 10.95 |
| 5075 | 4" | 1500 | 12.95 |

FULL WAVE BRIDGE RECTIFIERS

| PIV | 2 AMP (#1346) | 6 AMP (#2456) | 10 AMP (#2447) | 25 AMP (#2273) |
|-----|---------------|---------------|----------------|----------------|
| 50 | .59 | .88 | 1.29 | 1.59 |
| 100 | .69 | .99 | 1.49 | 1.79 |
| 200 | .79 | 1.25 | 1.69 | 2.25 |
| 400 | .89 | 1.50 | 1.99 | 2.49 |
| 600 | .99 | 1.75 | 2.25 | 3.75 |
| 800 | 1.19 | 1.95 | 2.50 | 4.50 |

Order by Catalog Number and voltage.

BARGAIN PRICED ONE-LINE SPECIALS

- ULTRASONIC TRANSDUCER, 42kHz, alarms, remote cont. (#5375) 1.49
- DYNAMIC MIKE, 500 ohm impedance, with stand. (#5330) 1.95
- LED RAY DIODES, emits coherent beam, 5-9W. (#3508) 6.88
- 12VDC BLOCK RELAY, 5A contacts, SPDT, 700 ohms (#4032) 1.00
- RED DISC SPECIAL, Erie, mostly marked, pop values (#5341) 150 for 2.00
- LONG LEAD DISC CAPACITORS, pop values, asst'd. (#2898) 100 for \$2.00
- TRANSISTOR 'LYTICS, asst. pop values, upright, axial. (#2747) 50 for \$2.00
- MOLEX IC SOCKET PINS, cut to any length. (#3144) 200 for \$2.00
- AXIAL ELECTROS, asst'd values & capacitance. (#3227) 40 for 2.00
- LED DRIVER IC'S, untest'd, like 75491-2, 50X+ good. (#3360) 30 for \$2.00
- JUMBO RED LED'S, 100X prime, long leads. (#3389) 15 for \$2.00
- LINE CORDS, 18ga, 2 cond, with plug, 5 ft. (#3843) 8 for \$2.00
- HARDWARE SURPRISE! screws, nuts, washers, and more. (#3967) 500 pc for \$2.00
- TUBULAR CAPACITORS, asst values from 100 pf up. (#35A219) 70 for \$1.00
- COILS AND CHOKES, RF, AF, osc, peaking, and more. (#35A207) 60 for \$1.00
- RCA PLUGS & JACKS, for audio, RF, etc. (#35B402) 15 for \$1.00
- SLIDE SWITCHES, pop types, from SPST up. (#1495) 20 for \$1.00
- 9 VOLT BATTERY SNAPS, fits std types. (#2852) 6 for \$1.00
- 1N4148 SWITCHING DIODES, like 1N914, 100X prime. (#3000) 20 for \$1.00
- UTILITY AC OUTLET, rect mounting. (#3582) 6 for \$1.00
- 1 AMP CIRCUIT BREAKERS, glass, thermal. (#3905) 2 for \$1.00
- CAPACITOR SPECIAL, discs, mylar, lytics, more (#2738) 100 for 2.00
- VOLTAGE REGULATORS, hobby LM320, 340, TO-3 (#3330) 10 for 2.00
- PANEL SWITCHES, slides, rotaries, mod, etc (#3288) 30 for 2.00
- RESISTOR SPECIAL, 1/4 to 1W, carbon, metal (#3054) 200 for 2.00
- HALF WATTERS, resistors, carbon, metal (#3046) 200 for 2.00
- NATIONAL IC BONANZA, linears, 7400s ROMS (#2860) 100 for 2.00
- LM340T VOLTAGE REGULATORS, 5 to 24V, TO-220 (#2635) 15 for 2.00
- POLYSTYRENE CAPS, asst'd values, voltage, hi-Q (#2729) 100 for 2.00
- BRIDGES, untested, 2, 4, 6, amp, full wave (#4022) 20 for 2.00
- MIXED READOUTS, hobby, untested, .127, .3, .5, etc. (#3619) 15 for 2.00
- QUARTER WATTERS, resistors, metal film, marked (#3413) 150 for 2.00
- PLASTIC TRANSISTORS, untested, TO-92 (#2604) 100 for 2.00
- PREFORMED RESISTORS, 1/4, 1/2, 1W, 2K marked, asst'd (#2608) 200 for 2.00
- PRECISION RESISTORS, 1/4, 1/2, 1W, 1%, 2% marked (#2428) 200 for 2.00
- DIPPED MYLARS, shiny finish, asst'd values (#2597) 60 for 2.00
- VOLUME CONTROLS, audio, linear, asst'd values (#2421) 30 for 2.00
- CLOCK CHIPS, National, hobby & untested, alarm (#5089) 30 for 2.00
- MMS262 2K RAMS, hobby, untested (#3940) 30 for 2.00
- PUSH SWITCHES, push-to-break, apt, alarm (#5289) 10 for 2.00
- CD-4000 SERIES CMOS, untested, 50% useable yield (#5284) 25 for 2.00
- CONDENSER MIKES, sensitive, 500 ohms 1.5 Volts (#3178) 1 for 2.95
- UNMARKED CAPACITORS, polystyrene, molded, pop values (#3805) 250 for 2.00
- IC SOCKETS, 14, 18 pin, solder tail. (#3621) 8 for 2.00
- PC TRIM POTENTIOMETERS, thumbwheel, screwdriver ass't. (#3345) 30 for 2.00
- SLIDE VOLUME CONTROLS, asst'd values, duals, singles (#3057) 15 for 2.00
- CRYSTALS, may include CB, Ham & more (#3250) 10 for 2.00
- TERMINALS STRIPS, from 2 lugs up (#3136) 100 for 2.00
- NE-ZNEON LAMPS, all 100% good (#2613) 30 for 2.00
- SHIELDED CABLE, 1 cond, mikes, phones, (#3577) 40 ft. for 2.00
- SOUND TRIGGER, sound triggers scr w/amp (#3625) 3 for 2.00
- VEEDER ROOT COUNTER, 000-999, reattachable, panel mt. (#5081) 1 for 1.49
- DUAL GATE MOSFET, sim. to 3N200, 3N187, for RF & Mixer (#5101) 2 for 1.00
- LCD THERMAL INDICATORS, 88-108°F, 7x1", flexible (#5195) 2 for 1.00
- JOYSTICK, four 100K pots, (#3908A) 1 for 2.95
- EEOO THUMBWHEEL SWITCH, BCD, 0-7 (#2870A) 1 for 1.49
- PLESSEY TV SIDEBAND FILTER, for chan. 3 or 4 (#3975) 1 for 1.95
- 9V NI-CAD CHARGER PAK, plug-in, 125ma, 125 VAC pri (#4098) 2 for 1.49
- DATA ENTRY PUSH-SWITCHES, apst, norm open, for keyboards (#5279) 20 for 2.00
- SN7400 TTL ICs, untested 50X+ yield, pop types (#2415) 75 for 2.00
- MINI DIP ICs, linears, untested 50X+ yield, pop types (#3245) 100 for 2.00
- LM380 AUDIO IC'S, 2 watts on-a-dip 50X+ yield (#5284) 30 for 2.00
- LINEARS, OP AMPS, untested 50X+ yield, amps-dips-minidips (#2416) 75 for 2.00
- LED WATCH GUTS, men's, how good? We don't know (#5267) 1 for 1.95
- SLIDE SWITCHES, asst pop styles (#1495) 10 for 1.00
- UPRIGHT ELECTROS, asst'd values & capacitance. (#3226) 40 for 2.00
- PREFORMED DISC CAPACITORS, marked values, asst'd (#2605) 150 for 2.00
- CALCULATOR KEYBOARDS, 20 keys and up. (#5371) 10 for 2.00
- ALARM WARNING STICKERS, for windows, 2-3/4" x 3" (#5338) 3 for 1.00
- CALCULATOR SWITCHES, SPST-N.O., asst'd, 1/4" sq. (#3524) 10 for 1.00
- ITT 6 DIGIT COUNTER, 110VAC, with mounting flange (#5392) 1 for 1.95
- 2N2369 TRANSISTORS, NPN switch, like 2N2222. (#1992) 6 for 1.00
- FACTORY REJECT DIODES, zeners, rect, signal, untested (#5369) 2000 for 1.00

8 DIGIT FREQUENCY COUNTER \$77
 Easy to read .35" led digits, dependable MOS/LSI circuitry. Quartz crystal controlled for high accuracy! Displays internal frequency standard at the touch of a button. Built in power supply! Flip-top black vinyl covered wooden cabinet for easy access.

• More features for the money!
 • Easy to assemble and calibrate!

SPECIFICATIONS:
 SENSITIVITY: 25mV to 35 MHz, 50 mV to 50 MHz.
 FREQ. RANGE: 10Hz to 50MHz, optional prescaler to 500 MHz.
 RESOLUTION: 1 Hz @ 1 sec, 10 Hz @ 10 sec.
 GATE TIMES: 1 and 0.1 sec.
 INTERNAL FREQUENCY STANDARD: 5.24288 MHz
 INPUT IMPEDANCE: 1 megohm

ACCURACY: 1 PPM @ 4 MHz
 LEAD ZERO BLANKING
 SIZE: 6 1/4 x 2 1/4 x 5 1/4" deep. WT: 2 lbs.
 POWER REQUIREMENTS: 110VAC, 60 Hz.

Cat. No. 4049 COUNTER KIT... \$77
 Cat. No. 4050 COUNTER WIRED & CALIBRATED... \$112
 Cat. No. 5433 COUNTER WITH PRESCALER WIRED & CALIBRATED... \$150

TTL'S

| | | | |
|------------|-------------|-------------|--------------|
| SN7400 .12 | SN7453 .12 | SN7492 .39 | SN74158 .49 |
| SN7401 .12 | SN7454 .19 | SN7493 .43 | SN74161 .49 |
| SN7402 .14 | SN7455 .12 | SN7494 .49 | SN74163 .69 |
| SN7403 .12 | SN7456 .19 | SN7495 .39 | SN74164 .39 |
| SN7404 .14 | SN7460 .12 | SN7496 .12 | SN74165 .69 |
| SN7405 .14 | SN7465 .12 | SN7498 .12 | SN74166 .69 |
| SN7406 .12 | SN7470 .12 | SN7499 .12 | SN74173 .99 |
| SN7409 .20 | SN7472 .12 | SN74100 .79 | SN74174 .79 |
| SN7410 .12 | SN7473 .29 | SN74107 .25 | SN74175 .69 |
| SN7411 .19 | SN7474 .29 | SN74109 .29 | SN74177 .59 |
| SN7413 .19 | SN7475 .39 | SN74113 .49 | SN74179 1.49 |
| SN7416 .25 | SN7476 .35 | SN74114 .25 | SN74180 .39 |
| SN7418 .25 | SN7477 .39 | SN74121 .29 | SN74182 .29 |
| SN7420 .12 | SN7478 .12 | SN74123 .39 | SN74190 .79 |
| SN7421 .25 | SN7482 .12 | SN74132 .65 | SN74191 .99 |
| SN7423 .12 | SN7483 .59 | SN74140 .39 | SN74192 .69 |
| SN7426 .12 | SN7485 .69 | SN74145 .59 | SN74193 .69 |
| SN7430 .14 | SN7486 .25 | SN74151 .55 | SN74194 .69 |
| SN7437 .12 | SN7488 .79 | SN74153 .55 | SN74195 .19 |
| SN7438 .14 | SN7489 1.25 | SN74155 .49 | SN74197 .69 |
| SN7440 .12 | SN7490 .39 | SN74156 .29 | SN74199 .79 |
| SN7441 .49 | SN7491 .19 | SN74157 .55 | SN74200 1.99 |
| SN7443 .29 | | | SN74201 .59 |
| SN7444 .12 | | | SN74202 .25 |
| SN7446 .65 | | | SN74204 2.49 |
| SN7447 .65 | | | SN74205 .99 |
| SN7450 .12 | | | SN74208 2.95 |
| SN7451 .12 | | | SN74209 .99 |

Order By Cat. No. 1981 & Type No.

DISCRETE LED CLOSEOUT
 6 for \$1

| Cat. No. | Description |
|----------|----------------------|
| 2135 | Jumbo Red |
| 2790 | Jumbo Red Clear |
| 1944 | Jumbo Yellow |
| 2138 | Jumbo Green |
| 2793 | Jumbo Amber |
| 2137 | Micro Red |
| 1948 | Micro Yellow |
| 2140 | Micro Green |
| 2143 | Micro Amber |
| 1788 | Micro Top-hat Red |
| 1802 | Micro single pin Red |

Jumbo .34" high
 Medium .24" high
 Micro .21" high

Order in multiples of 6 of each type.

MOTOR SPEED CONTROL "BASIC" KIT \$2.95
 Controls up to 10 AMps, 1000 watts! Works with noninductive type motors and incandescent lights. Varies from 5% to 95%. Wt. 10 oz. Cat. No. 5327
 *Basic kits include all necessary electronic components, less PC board, case, line cord, transformer, or battery. Easy to breadboard, with instructions.

GIANT MINI TOGGLE SWITCHES
 • 3A 125VAC contacts or better!
 • Top USA makers!

| Cat. No. | Contacts | Sale |
|----------|----------|------|
| 4036 | SPDT | 89c |
| 5085 | SPDT | 99c |
| 4037 | DPDT | 1.29 |
| 5422 | DPDT | 1.49 |
| 5434 | 3PDT | 1.69 |
| 5087 | 4PDT | 1.95 |

*center off

LINEAR "POP" OP AMPS:

| | | |
|----------------|----------------|--------------|
| LM300N .49 | LM339N .99 | LM556N .99 |
| LM300H .49 | LM340K-5V .99 | LM558N .29 |
| LM301V .25 | LM340K-6V .99 | LM561N 1.99 |
| LM301H .25 | LM340K-12V .99 | LM565N .89 |
| LM307V .25 | LM340K-15V .99 | LM565H .79 |
| LM308V .29 | LM340K-18V .99 | LM567V 1.20 |
| LM308H .59 | LM340K-24V .99 | LM703H .39 |
| LM309K .99 | LM340T-5V .99 | LM704H .19 |
| LM311V .29 | LM340T-6V .99 | LM709H .19 |
| LM320T-5V .99 | LM340T-8V .99 | LM710N .29 |
| LM322N .79 | LM340T-12V .99 | LM711N .39 |
| LM322H .59 | LM340T-15V .99 | LM723N .49 |
| LM324N .89 | LM340T-18V .99 | LM733N .59 |
| LM339N .99 | LM340T-24V .99 | LM741V .19 |
| LM340K-5V .99 | LM350N .79 | LM741H .19 |
| LM340K-6V .99 | LM377N 1.49 | LM747H .39 |
| LM340K-12V .99 | LM3795 5.50 | LM747H .39 |
| LM340K-15V .99 | LM380N .89 | LM1304N .99 |
| LM340K-18V .99 | NE531H 1.49 | LM1310N .99 |
| LM340K-24V .99 | NE532N .25 | MC1312N 2.49 |
| LM340T-5V .99 | NE540N 2.50 | LM1414V .49 |
| LM340T-6V .99 | NE555V .39 | LM1458V .20 |
| LM340T-8V .99 | | LM1800N .20 |
| LM340T-12V .99 | | LM3028H .69 |
| LM340T-15V .99 | | LM3900N .20 |
| LM340T-18V .99 | | LM3909V .69 |
| LM340T-24V .99 | | LM4250H 1.09 |
| LM350N .79 | | 75451 .29 |
| LM377N 1.49 | | 75453 .29 |
| LM3795 5.50 | | 75491 .49 |
| LM380N .89 | | 75492 .49 |
| NE531H 1.49 | | 75494 .69 |
| NE532N .25 | | PA263 .77 |
| NE540N 2.50 | | DM8864 .99 |
| NE555V .39 | | |

Order by Type No.
 Case code: T=TO-220 Power Tab;
 V=Mini dip; K=TO-3; H=TO-5; N=DIP.

DIP SWITCHES

| Cat. No. | Switches | Sale |
|----------|----------|------|
| 3668 | 2 | .77 |
| 3669 | 3 | .88 |
| 3021 | 4 | .99 |
| 2677 | 7 | 1.79 |
| 5164 | 8 | 1.99 |
| 3672 | 10 | 2.50 |

Order by Cat. No.

Send for new FREE 20 page catalog **FREE!**
 including the best bargains on:
 • SEMICONDUCTORS • Solar Energy!
 • Computer Components • Fiber Optics!
 • Over 400 assortments! • Plus more-n-more!
 • Digital clocks and test equipment! • IC'S
 • Hi-Fi stereos, speakers! • LED'S

SEND FOR YOURS NOW!

POLY PAKS®
 COD'S MAY BE PHONED!
 P.O. BOX 942-A11
 SO. LYNNFIELD, MA 01940

Terms: Add Postage Rated: Net 30
 Phone: (617) 245-3828
 Retail: 16-18 Del Carmine St. P2
MINIMUM ORDER: \$8 Wakefield, MA

ORDERING INSTRUCTIONS:
 When ordering, always use catalog number

ASSOCIATED RADIO

✓ A50

913-381-5900

8012 CONSER BOX 4327
OVERLAND PARK, KANSAS 66204



CALL US WITH YOUR REQUIREMENTS



AMERICA'S #1 Real Amateur Radio Store

TRADE SELL BUY

NOTE

**SEND \$1.00 FOR OUR CURRENT CATALOG OF
NEW AND RECONDITIONED EQUIPMENT.**

***ALSO WE PERIODICALLY PUBLISH A LIST OF
UNSERVICED EQUIPMENT AT GREAT SAVINGS.
A BONANZA FOR THE EXPERIENCED OPERATOR.
TO OBTAIN THE NEXT UNSERVICED BARGAIN LIST,
SEND A SELF ADDRESSED STAMPED ENVELOPE.**



Call our toll-free number first

... and it's the last call you'll have to make!

(NO CHARGE TO CALLING PARTY)

1-800-325-3030

CALL FOR THE BEST PRICE AND FAST DELIVERY

ON THE FOLLOWING LINES:

- | | | |
|---------|-----------|---------|
| ATLAS | ICOM | SWAN |
| COLLINS | INFO-TECH | TEMPO |
| DENTRON | KENWOOD | TEN-TEC |
| DRAKE | MOSLEY | WILSON |
| HY GAIN | STANDARD | YAESU |

... AND MANY OTHERS.

HAM RADIO CENTER

8340-42 Olive Blvd. P.O. Box 28271 St. Louis, MO 63132





7294 N.W. 54 STREET
MIAMI, FLORIDA 33166

SURPLUS ELECTRONICS CORP. ✓S43

PHONE: (305) 887-8228

TWX: 810-848-6085

WHOLESALE - RETAIL

| | | | | | | |
|---|--|--|---|---|---|--|
| <p>RADIO TRANSMITTER Type T-20/ARC-5 5.3 to 7 MC or 4-5.3 MC Brand new—Never used— Tubes alone are worth the price \$24.95 only 30 left less cover</p> | <p>— NORTH ELECTRIC TRANSFORMER — 2470—9024 117 V 50/60 Hz—Multiple windings will produce: + 24 V dc—50 Amp + 12 V dc—100 Amp - 12 V dc—50 Amp Other voltages can be obtained, complete with specification sheets—Limited Qty. \$49.95 \$49.95</p> | | <p>KESTER #44—SOLDER 63/37 Alloy .032 diameter. —5lb. Spools Only— \$6.00 per lb.</p> <hr/> <p>12 Vdc SIRENS Very Loud \$8.95</p> | | | |
| <p>SURPRISE PACKAGE Resistors, Caps, Semis, Pots, Relays, etc. We guarantee it to be \$25.00 worth of material. Every package is different. \$5.00</p> | <p>TEXAS INSTRUMENT KEYBOARD \$1.95 ea., 5 for \$8.00 10 for \$13.95</p>  <p>Has 3 slide switches—28 different keys— keypads re- movable by removing 4 screws.</p> | | <p>CERAMIC PRECISION CAPS-ERIE 47 pF—100 V 220 pF—100 V \$.10 ea. 470 pF—100 V 500 pF—100 V 15 for \$1.00 560 pF—100 V 1000 pF—100 V 50 for \$3.25 2000 pF—100 V</p> | | | |
| <p>White Porcelain Egg Insulator 1½" x 1" 50¢ ea 3 for \$1.25</p> | <p>SIGNAL DIODE 1N4148 \$ 5.00 per hundred \$25.00 per thousand or, 15 for \$1.00</p> | <p>POWER MATCH CONVERTER Pearce-Simpson —Max Loads 30 Watts converts: for positive 6 to 12 Vdc } or negative 6 to 18 Vdc } ground systems 12 to 24 Vdc } 3½" x 3½" x 2" \$7.95</p> | <p>STANCOR TRANSFORMER #P-818OB—117 V in— 25.2 V ct at 1 Amp \$3.00 ea., 2 for \$5.00 3 for \$6.50</p> | | | |
| <p>Neon Panel Light 110 Vac Amber, w/ built in resistor & wire leads—3 for \$1.50</p> | <p>WIRE WOUND RESISTORS .1 Ohm—5 W .10 Ohm—10 W @ 15¢ each</p> | | <p>MUFFIN FANS 3 Blades, 110 Vac, 4¾" sq. Removed from equipment— Excellent condition—\$4.95</p> <hr/> <p>"New" Muffin Fans 3 Blades-110 Vac, 4¾" sq. \$9.95</p> | | | |
| <p>PANEL METERS 2¼" x 2¼" also 2¼" x 3" 10-0-10 dc Amps } \$4.00 ea 0-20 dc Volts } 25-0-25 dc Volts } 2 for 0-25 dc Volts } \$7.00 0-50 ac Volts } -Shunt Required-</p> | <p>New Dry Nickel-Cadmium Battery 2¼" x 2¾" x 8¾" General Electric 12.0 Volts dc @ 4.0 Amp hrs. \$19.95 while they last.</p> | | <p>TRIMMER CAPS Small enough to fit in your watch— 3.5 to 20 pF 5 to 30 pF 7 to 40 pF \$.75 ea., 2 for \$1.25 5 for \$3.00</p> | | | |
| <p>POWER SUPPLY 110 AC to 12 VDC 550 mA 23 Watts 3½" w x 4" h x 6½" d \$9.95</p> | <p>HOOK-UP WIRE Size 20 or 22— various colors— no color selection solid \$6.00/1000' \$10.00/2000'</p> | <p>POLYFOAM COAX—50R Equal to RG174 \$4.95/100' Low Loss Polyfoam Coax Cable</p> | <p>JOY STICK For TV games and hi fi with four, 100K pots 2¾" X 2¾" X 1" with 1" handle—\$3.95</p> | | | |
| <p>Heavy Duty Instrument Case Grey vinyl over wood—inside also lined w/ vinyl & foam padding. Flip- top w/ handle and keylock w/ key. inside dem. 4½"D x 8¼"W x 10"H \$25.00 value—\$9.95</p> | <p>E2000 Memory 52 x 52 200 WD 12 DG \$4.95</p> | | <p>New Boxer Fans 5 Blades 110V ac 4¾"—\$11.95</p> | | | |
| <p>Varo Bridge Rectifier 10 amps. 220 Vdc—\$1.50</p> | | | | | | |
| <p>SPECIALS—SPECIALS—SPECIALS—SPECIALS—SPECIALS—SPECIALS—SPECIALS—SPECIALS</p> | | | | | | |
| <p>Computer Grade Caps 1000 mf—50 V 10,000 mf—20 V 8200 mf—25 V 30,000 mf—15 V 21,000 mf—25 V \$2.50 ea.</p> | <p>CTS DIP Switches 8 position \$1.25 ea., 2 for \$2.00</p> | <p>Trimmer Cap Arco/Elmenco PC-402 2 to 20 pF \$.60 ea. 5 for \$2.50, 15 for \$5.00</p> | <p>MASSA Ultrasonic Transducer 37 or 40 kHz \$1.50 ea. 2 for \$2.50, 5 for \$5.00</p> | <p>Relay—P & B 4 PDT—110 Vdc 6050 Ohm coil 10 Amp contacts \$1.50 ea., 2 for \$2.75, 3 for \$3.25</p> | <p>Bourns Trimpot #200L—1—201M 200 Ohm \$1.50 ea., 2 for \$2.50, 5 for \$6.75</p>  | <p>Stancor Transformer #P-8650 Step down/isolation 117Vpai-12V6.5Amp. w/cord & receptacle \$5.95</p> |

TERMS: All material guaranteed • If for any reason you are not satisfied, our products may be returned within 10 days for a full refund (less shipping). Please add \$3 for shipping and handling on all orders. Additional 5% charge for shipping any item over 5 lbs. COD's accepted for orders totaling \$50.00 or more. All orders shipped UPS unless otherwise specified. Florida residents please add 4% sales tax. Minimum order \$15.00.

EQUIPMENT / COMPONENTS / WIRE & CABLE / ACCESSORIES

GET YOUR

NEW 1979

Published December 1st, 1978

RADIO AMATEUR CALLBOOKS

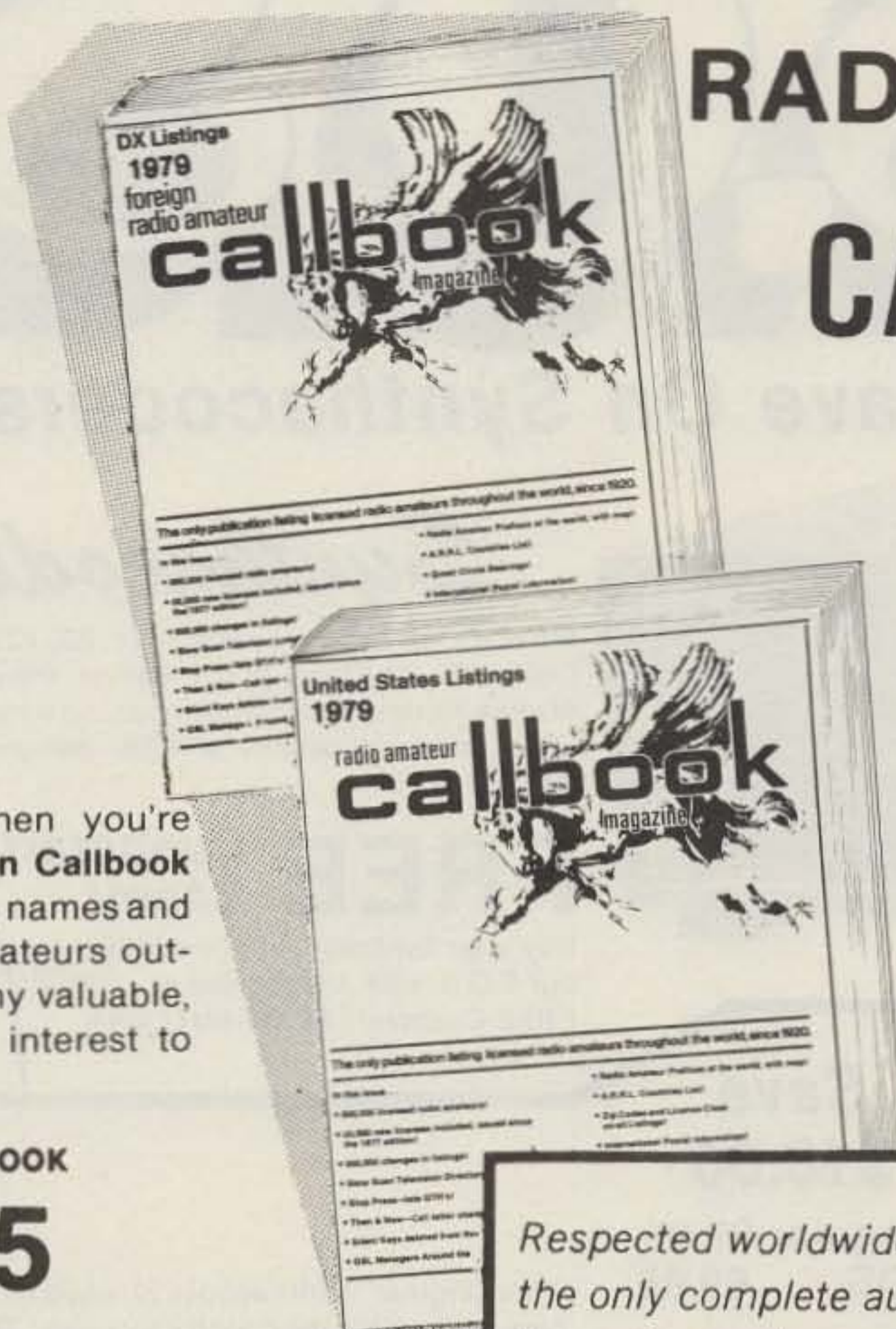

Specialize in DX? Then you're looking for the **Foreign Callbook** with over 280,000 calls, names and addresses of radio amateurs outside the USA plus many valuable, additional features of interest to the DX'r.

FOREIGN CALLBOOK
\$14.95
PLUS SHIPPING

The **U.S. Callbook** has over 350,000 W & K listings. It lists calls, license classes, names and addresses plus the many valuable back-up charts and references you come to expect from the **Callbook**.

UNITED STATES CALLBOOK

\$15.95
PLUS SHIPPING

*Respected worldwide as
the only complete authority
for radio amateur
QSL and QTH information.*

See your favorite electronics dealer for the latest issue or order direct from the publisher using handy order form.

Payment in U.S. funds must be sent directly to publisher not through a bank.

ORDER FORM

| Item | Price Each | Shipping | Total Price |
|---|------------|----------|-------------|
| <input type="checkbox"/> U. S. CALLBOOK | \$15.95 | \$1.75 | \$17.70 |
| <input type="checkbox"/> FOREIGN CALLBOOK | \$14.95 | \$1.75 | \$16.70 |

Illinois residents only add 5% sales tax _____

Name _____

Address _____

City _____

State _____ Zip _____

Charge my: Visa Card Master Charge

Card No. _____ Expiration Date _____

Dept. B _____ Signature _____

TOTAL _____

**Radio
Amateur** ✓ R1
callbook, INC.

925 SHERWOOD DRIVE
LAKE BLUFF, ILLINOIS 60044



HOLIDAY SALE

HOLIDAY SALE

S.O.S.

"Save On Synthacoders"



Synthacoder 509

Provides full frequency coverage, 220-225 MHz, for your Midland 509, Cobra 200, or Clegg 76 transceiver. Provides simplex, repeater, and reverse modes on all frequencies. New improved interface circuit provides greater flexibility and RF immunity. FULLY ASSEMBLED & CALIBRATED

FREE Cushcraft Beam!

still only \$129**

Buy your Synthacoder 509 during our S.O.S. sale and receive a FREE Cushcraft BEAM ANTENNA

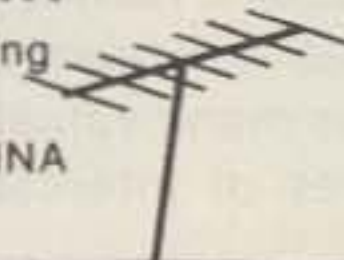

ATTENTION 22S OWNERS!

Save \$18.00

Regular 87.95
SOS 69.95



"The Original" Synthacoder 22, used by many hundreds of ICOM owners throughout the country for years! The ultimate in frequency control for the 22S. Full thumbwheel control in 15 KHz steps. You won't want to miss out on this SOS Super Saver!

SYNTHACODERS ARE AVAILABLE THRU YOUR LOCAL DEALER

We Are About To Announce Some New "SUPER PRODUCTS" WATCH FOR OUR ADS

E12 Engineering Specialties

P.O. Box 2233
1247 Commercial Avenue
Oxnard, California 93030
(805) 486-0817



- Yes I want to take advantage of your SOS Super Saver!
- Please RUSH my Synthacoder 509 and FREE BEAM ANTENNA. Enclosed is my \$129.95 plus \$3.00 postage and handling.
 - Please RUSH my Synthacoder 22. Enclosed is my \$69.95 plus \$2.00 postage and handling.
- California residents add 6% sales tax.

\$ _____ Check Money Order Charge Card

Please charge my Master Charge BankAmericard/VISA

Credit Card # _____ Expiration date _____

Signature _____

Name _____ Call _____

Address _____

City _____ State _____ Zip _____

73-11



Does Your Unit Cover The New Sub-Band 144.5 - 145.5 MHz? The FM2015R Does. PLUS MARS-CAP!

OVERVOLT 12

Crow Bar circuit protects Transceivers & Tape Decks from runaway power supply voltage that can zap expensive components. OV 12 causes fuse in Power Supply to blow if voltage exceeds preset level (approx. 16 to 18 volts). Rated at 25 Amperes. \$ 7.95
Model OV5. Protects 5 Volt circuits. Triggers at 7.5 Volts \$ 7.95
Other units available at 3.3 to 100 Trigger Voltages \$10.95 ea

THE LUNCH COUNTER

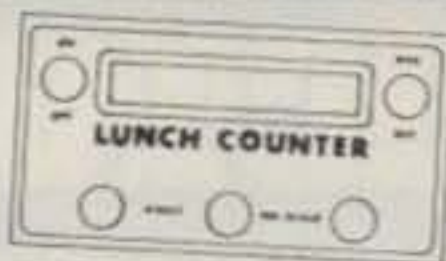

Build a 600 MHz 6 Digit Frequency Counter. We supply 3 PC Boards, Silk Screened Front Panel and complete Instructions Only \$14.95

Chips used in Counter
11C90 Prescaler \$14.50
74C925 9.95
F9368 (2 used) ea 3.95

All Solid State-CMOS PLL digital synthesized - No Crystals to Buy! 5KHz steps - 144 - 149 MHz-LED digital readout PLUS MARS-CAP *

• 5 MHz Band Coverage - 1000 Channels (instead of the usual 2MHz to 4MHz-400 to 800 Channels) • 4 CHANNEL RAM IC MEMORY WITH SCANNING • MULTIPLE FREQUENCY OFFSETS • ELECTRONIC AUTO TUNING - TRANSMIT AND RECEIVE • INTERNAL MULTIPURPOSE TONE OSCILLATOR • RIT • DISCRIMINATOR METER - 15 Watts Output - Unequaled Receiver Sensitivity and Selectivity - 15 POLE FILTER, MONOLITHIC CRYSTAL FILTER AND AUTOMATIC TUNED RECEIVER FRONT END, COMPARE! • Superb Engineering and Superior Commercial Avionics Grade Quality and Construction Second to None at ANY PRICE.

INTRODUCTORY PRICE
\$449.95



ALD1158

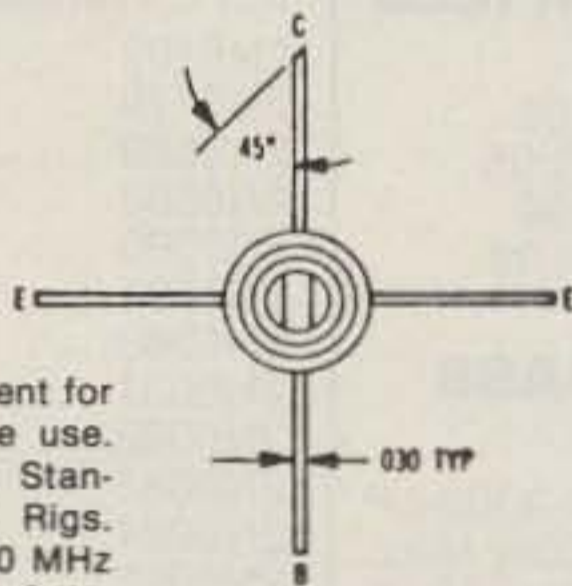

Hard to find replacement for VHF Mobile & Marine use. Successfully used in Standard and other VHF Rigs. Rated 12 Watts at 200 MHz 12.5 Volts with 5.3 DB Gain. Heat Sink stud (8/32) isolated from leads. Only \$12.30

RF DEVICES

| | | | | |
|--------|-------|---------|----------|---------|
| 2N2876 | 18W | 200 MHz | T060 | \$12.35 |
| 2N3375 | 3.0W | 400 MHz | T060 | 5.60 |
| 2N3553 | 2.5W | 175 MHz | T039 | 1.40 |
| 2N3866 | 1.0W | 400 MHz | T039 | 1.25 |
| 2N3926 | 7.0W | 175 MHz | T060 | 6.30 |
| 2N4427 | 1.0W | 175 MHz | T039 | 1.35 |
| 2N5589 | 3.0W | 175 MHz | MT71 | 4.75 |
| 2N5590 | 10W | 175 MHz | MT72 | 7.80 |
| 2N5591 | 25W | 175 MHz | MT72 | 10.25 |
| 2N5913 | 1.75W | 175 MHz | T039 | 1.70 |
| 2N6080 | 4.0W | 175 MHz | MT72 | 5.40 |
| 2N6081 | 15W | 175 MHz | MT72 | 8.45 |
| 2N6082 | 25W | 175 MHz | MT72 | 10.95 |
| 2N6083 | 30W | 175 MHz | MT72 | 12.30 |
| 2N6084 | 40W | 175 MHz | MT72 | 16.30 |
| 2N6094 | 4.0W | 175 MHz | X106 PNP | 6.60 |
| 2N6095 | 15W | 175 MHz | X106 PNP | 8.50 |
| 2N6096 | 30W | 175 MHz | X106 PNP | 10.35 |
| 2N6097 | 40W | 175 MHz | X106 PNP | 20.00 |

ALDELCO KITS

DUAL DIGITAL 12/24 HOUR CLOCK KIT NOW WITH A NEW WALNUT GRAIN WOOD CABINET



Features:
12 or 24 Hour Operation on either clock
Each Clock separately controlled
Freeze feature for time set
Easy assembly for clock and cabinet

**BIG
0.5 LEADS**

MODEL ALD 5-W **ONLY \$49.95**

LEDS

Monsanto MAN 72 Red LED Readout .300" High, Common Anode. ONLY \$.89

Monsanto MV5053 JUMBO LED and Holder only .25
LED Holders .10
Jumbo Red LEADS 8 for \$1.00
Jumbo Green, Orange or Yellow LEADS 5 for \$1.00

FETS

| | |
|--------|------|
| 40673 | 1.55 |
| MPF102 | .55 |
| 2N3819 | .35 |
| 2N5457 | .50 |
| 2N5458 | .50 |
| 2N5459 | .55 |
| 2N5485 | .50 |

DARLINGTON

| | |
|---------|-----|
| MPSA 13 | .80 |
| MPSA 14 | .40 |
| 2N5306 | .50 |
| SCR | |
| C 106A | .55 |
| C 106B | .65 |
| C 122B | .85 |

— THE MIMIC —

PROGRAMMABLE IAMBIC MEMORY KEYS

- Four memory inputs, sixty letters each
- Five minutes of memory @ 10 wpm
- Operates on 110 V ac and 8-16 vdc
- Triggered clock for memory recording
- Built-in side tone monitor
- Speed control 5 to 40-plus wpm
- Two to three times the memory of nearest competitor



Comes in attractive light blue cabinet measuring 2 1/2" high x 4" wide x 5" deep.

KIT ONLY \$79.95
Kit with set of paddles . . . \$104.95
Assembled unit . . . 99.95
Paddles only . . . 29.95

VOLTAGE REGULATORS

| | |
|-----------------|-----------------|
| TO220 Package | |
| Positive \$1.00 | Negative \$1.25 |
| 7805 | 7905 |
| 7806 | 7906 |
| 7808 | 7912 |
| 7812 | 7915 |
| 7815 | 7918 |

CLOCK CHIPS

| | |
|--------|------|
| 5313 | 3.49 |
| 5314 | 3.49 |
| 5316 | 3.95 |
| 5375 | 3.95 |
| CT7001 | 6.95 |

ALARM CLOCK KIT

6 Big 0.5 LED Displays * On Board AC Transformer * 12 Hour Format with 24 Hour Alarm * Snooze Feature * Elapsed Timer. Timer feature makes this Popular in Broadcast Stations. It's a natural for cars, boats and campers when used with optional crystal time base. Fits our standard cabinet. \$19.95
Crystal time base when purchased with clock. \$2.95

12 or 24 HOUR DIGITAL CLOCK KIT

Uses 0.5 Display LED. 5314 Clock Chip. Freeze feature for accurate set, fits our standard cabinet. **ONLY \$18.95**

CLOCK CABINETS

Woodgrain or black leather ea. \$4.95

CRYSTAL TIME BASE KIT

Includes PC Board, Crystal, all parts and instructions. \$4.95

CLOCK FILTERS

Blue, Red, Green, Amber or Smoke \$.60

Blinky Flasher Kit

PC board, 555 & all parts works on 9 volts. Mouse button—\$1.00

DIGITAL MULTIMETER & THERMOMETER

3 1/2 Digit—5 ranges on each function AC/DC .2 Volts to 2000 Volts Current 2 Microamps to 2 Amps Resistance 2000 Ohms to 2 Megohms. Includes PC Board, ICL7107 Chip and all parts. Only \$49.95

CRYSTAL SOCKETS

HOLDS 8 HC25U . . . \$.59
Single HC25U29

Amphenol

8 Pin Round IC Socket .44



NEW!

Tunable 420 MHz Fast Scan TV Converter

Receive Fast Scan Amateur TV in the 420 to 450 MHz Band with any TV set. Low noise, high gain rf Amp with Varactor tuned input and outputs. Built in AC supply. Comes in two tone walnut & beige cabinet measuring 1 7/8" x 4 1/4" x 4 1/8". Factory wired with 2 year guarantee. \$59.95

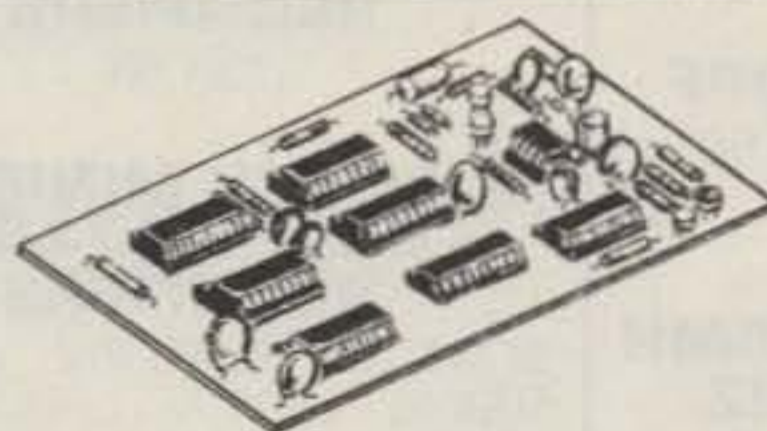

ACCUKEYER KIT

- Self Completing Dots & Dashes
- Provision for attachment of 256 or 512 Bit Memory for DX or Contest work
- Iambic Operation
- Single Dot & Dash Memories

Revised version of the Accukeyer featured in the ARRL Handbook. Has more logical IC Layout and ON Board sidetone Oscillator. Includes PC Board, TTL ICs, 555 Timer, IC Sockets, Switch, Speaker, Transistors, capacitors and resistors. Requires 5 VDC. **ONLY \$19.95**

ACCUKEYER MEMORY KIT

Simple low cost Memory Kit. Uses 2 programmable 1101 Memory chips. Provides 2 canned messages of 30 Characters each. Adaptable to Handbook and other Accukeyers. Includes PC board (same size as accukeyer board) and all parts. Requires 5 VDC, 9 VDC. \$19.95

SEMICONDUCTORS SURPLUS

✓ S63

2822 North 32nd Street/Unit -1 Phoenix, Arizona 85008 (602) 956-9423

We accept checks, MasterCard, and Visa

R.F. CONNECTORS

| | |
|-----------|------|
| SO-239 | 49 |
| PL-259 | 59 |
| UG-175 | 39 |
| M-358 | 1.95 |
| M-359 | 2.00 |
| PL-258 | 2.00 |
| UG-88E/U | 89 |
| UG-492A/U | 2.00 |
| UG-306B/U | 2.00 |
| UG-290A/U | 99 |
| UG-274/U | 2.00 |
| UG-260B/U | 1.10 |
| UG-273/U | 2.50 |
| UG-201A/U | 2.50 |
| UG-58/U | 1.99 |
| UG-491A/U | 2.25 |
| UG-260/U | 99 |
| UG-1094/U | 89 |

FERRITE BEADS

12/.89 or 100/4.00

TOROIDAL CORES

T-37-6 6/1.00 25/4.00 50/6.00
100/10.00

TOROIDAL CORES

T-30-2 & T-30-12 5/1.00

1N914/1N4148

30/1.00 or 120/3.00

2C39/7289 TUBES

\$4.00 each or 10/\$35.00

TRIMMERS 5-80PF

45¢ each or 10/ 3.50 or
100/25.00

CHOKE (U252) 2.5MH 150 MA 30 MHZ

2/\$1.00

TRIMMER CAPS

Small enough to fit in your
watch 3.5-11 pf 75¢ each or
10/\$6.00

RG-174 52 OHM COAX MADE BY H.P.

\$5.00/100 ft.

MINIATURE SWITCHES

SPST ON-ON 3/1.00 Used

F.E.T.S

| | |
|---------|------------------|
| MPF4391 | .75 or 10/6.50 |
| MPF112 | .69 or 10/5.50 |
| MPF102 | .43 or 10/3.50 |
| 40673 | 1.39 or 10/10.00 |
| 3N128 | 1.35 or 10/10.00 |
| 2N5248 | .60 or 10/4.50 |
| MPF131 | .60 or 10/5.00 |
| 2N4303 | .45 or 10/3.50 |
| 2N3958 | 2.95 each |
| MFE2000 | .90 or 10/8.00 |
| MFE2001 | .99 or 10/8.00 |
| MFE2008 | 4.20 or 10/36.00 |
| MFE2009 | 4.80 or 10/39.00 |
| MFE3002 | 3.35 each |
| MMF-5 | 5.00 each |
| MFE120 | 1.00 or 10/8.50 |
| 2N3436 | 2.25 each |
| 2N4416 | 1.00 each |
| MFE131 | 1.05 each |

PISTON CAPS 1.2-10 PF

75¢ each or 10/5.50

LM566V VCO Function Generator

99¢ each

LM340T-5 & LM340T-12

75¢ each

1500PIV 1.5 AMPS RECTIFIERS

10/1.50

SEMTECH MINISTIC, HIGH VOLTAGE RECTIFIERS

SFMS 20K 20,000 PIV
500ma \$1.99 each

MOTOROLA I.C.s

MC4024P & MC4044P \$3.27 ea.

HEP 170 2.5 AMPS

1000PIV 10/2.00 or
100/14.50

MOTOROLA R.F. AMPS

MC1550G 1.50 each
MC1590G 6.90 each

NEW WHISPER FANS

115 VAC \$9.95 each

POTTER & BRUMFIELD RELAYS

12VDC 4PDT 3Amps 2.95
12VDC SPDT 25Amps 5.95
12VDC 2PDT 3Amps 1.99
12VDC 4PDT 25Amps 6.99

DRAKE LOW PASS FILTERS

TV-42-LP TV-3300-LP
100W Max. 1000W Max.
30 MHz \$9.95 30 MHz \$19.95

TUBES

| | |
|------------|--------|
| 2E26 | 5.00 |
| 3B28 | 5.00 |
| 4X150A | 15.00 |
| 4CX250B | 24.95 |
| 4CX250R | 29.95 |
| 4CX250F | 26.00 |
| 6146 | 3.99 |
| 6146A | 5.25 |
| 6146B | 6.25 |
| 6146W | 6.95 |
| 6360/A | 7.95 |
| 6907 | 35.00 |
| 6939 | 5.96 |
| 7289 | 9.95 |
| 7984 | 6.95 |
| 8072 | 45.00 |
| 8106 | 1.75 |
| 8560A/AS | 30.00 |
| 8950 | 5.95 |
| 6KD6 | 4.65 |
| 6LQ6/6JE6 | 6.20 |
| 811 | 6.00 |
| 811A | 10.95 |
| 717A | 8.00 |
| 572B/T160L | 29.00 |
| 4-400AX | 39.95 |
| 4-125A | 20.00 |
| 4CX15000A | 150.00 |
| 8437 | 250.00 |
| 7007/6166A | 600.00 |
| 3-500Z | 69.00 |

R.F. TRANSISTORS

| | |
|-------------|-------|
| 2N2857 | 1.80 |
| 2N2857JAN | 2.35 |
| 2N2947 | 16.00 |
| 2N3375 | 6.00 |
| 2N3553 | 1.80 |
| 2N3818 | 5.50 |
| 2N3866 | 1.05 |
| 2N3866JAN | 3.14 |
| 2N3866JANTX | 4.25 |
| 2N3925 | 6.00 |
| 2N3948 | 2.00 |
| 2N3950 | 26.00 |
| 2N3960 | 4.70 |
| 2N4072 | 1.70 |
| 2N4427 | 1.24 |
| 2N4877 | 2.57 |
| 2N4957 | 2.50 |
| 2N5108 | 3.90 |

R.F. Transistors, con't.

| | |
|---------|-------|
| 2N5109 | 1.55 |
| 2N5179 | 59 |
| 2N5589 | 4.00 |
| 2N5583 | 5.00 |
| 2N5590 | 6.00 |
| 2N5591 | 10.00 |
| 2N6080 | 5.00 |
| 2N6081 | 6.00 |
| 2N6082 | 10.75 |
| 2N6083 | 12.00 |
| 2N6084 | 13.00 |
| 2N6095 | 10.00 |
| 2N6097 | 27.00 |
| MRF502 | 99 |
| MRF8004 | 69 |
| SS2548 | 75 |
| 40281 | 10.90 |
| 40282 | 11.90 |

BRIDGES 25 AMPS 500PIV

\$2.99 each

ROTRON FEATHER FANS

Factory Fresh Type 213
230VAC 20W Max. \$12.95

MUFFIN FANS, REMOVED

from new equipment \$6.95

TEKTRONIX SCOPES

545/CA Plug-in \$499.95
HP Model 651A Test Oscilla-
tor \$299.95

ELECTRO/DATA PANORAMIC RECEIVER PLUG-IN UNIT

Model PN1011, will work in
Tektronix Scopes and will make
into Spectrum Analyzers. 1000
to 12,000 MHz \$299.95

LINEAR I.C.s

| | |
|-----------|------|
| LM308H | 1.00 |
| LM309K | 1.00 |
| LM380N-14 | 60 |
| LM301V | 30 |
| LM301H | 30 |
| LM1458V | 50 |
| LM304H | 79 |
| LM307V | 35 |
| LM310H | 2.00 |
| LM312 | 1.75 |
| LM555V | 49 |
| LM555H | 5.00 |
| LM318H | 1.00 |
| LM324N | 1.00 |

HUNG UP ON HOMEBREW? See Whitehouse . . .



MICROWAVE ASSOCIATES®

NEW!

Set of 2 GUNNPLEXER™ TRANSCEIVERS

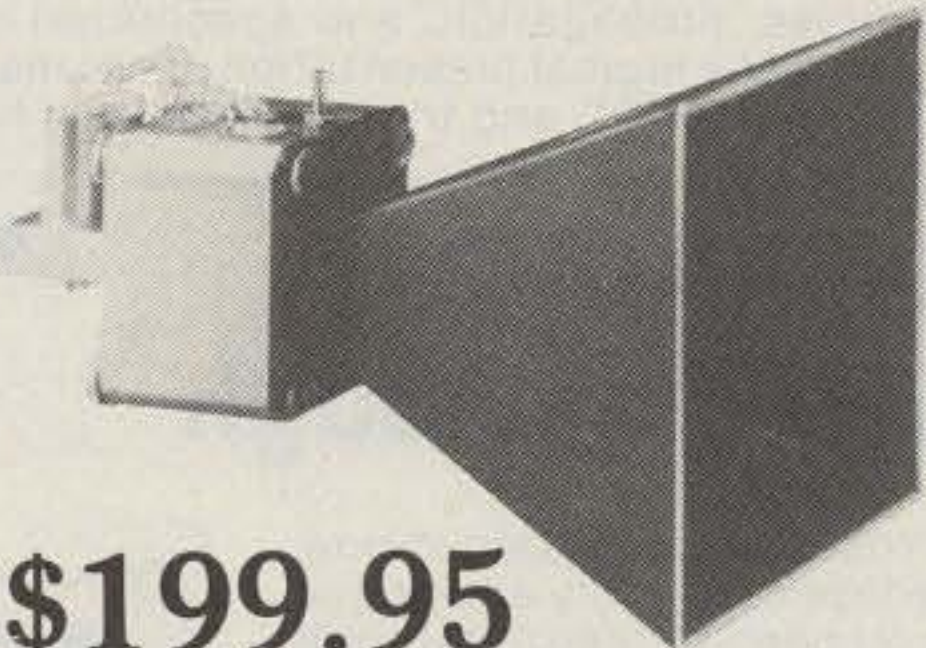

Designed to operate in the 10.0 to 10.5 GHz band.

only **\$199.95**

Featuring: low cost • high sensitivity • integrated assembly • electronically tunable • high reliability • low operating voltage

Explore, discover and enjoy alternative modes of Amateur communication. Like linking remote receivers to VHF repeaters, transmitting video (not slow scan), linking homemade computers, duplex mountain top or over water duct DXing and more!

Send for a complete introductory booklet on the MICROWAVE Gunnplexer.

for the most complete selection of hard-to-find homebrew parts and money-saving kits. Whitehouse saves you time (and that's money!) by rounding up all the parts — the fun's all yours.

TRANSMATCH PARTS

Look and Compare these prices!

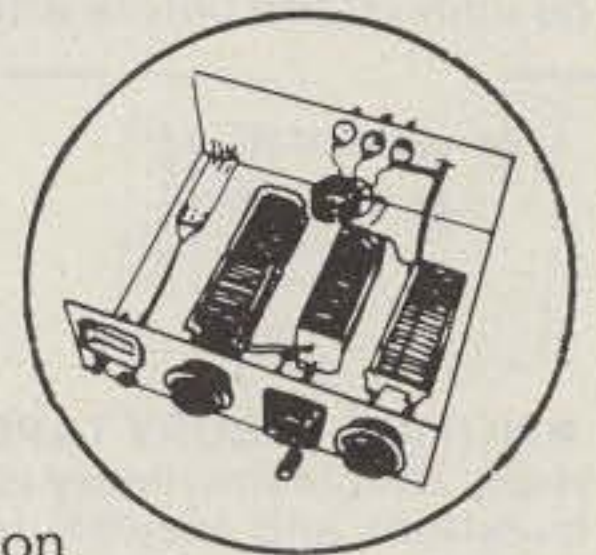

WHITEHOUSE SPECIAL

W2192 Dual Section Capacitor

W1350 Single Section Capacitor

229-203 28mh Roller Inductor by Multronics

3902-1 B&W Turns Counter

Order TWS **\$129.95**

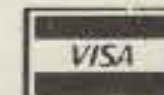

VISA and Master Charge orders welcomed



division
varian

NEW!

now available
from Whitehouse

World's finest:

- Power Tubes
- Sockets & Socket Parts
- Chimneys, Plate Caps, etc.



Whitehouse has the parts for your homebrew amplifier. Let us send you a complete list of parts and prices — the lowest prices you'll find anywhere.

4CX250B

3CX1500



MICROWAVE ASSOCIATES

100 WATT NON-INDUCTIVE LOADS

For phased arrays using Wilkinson power dividers or dummy loads, antenna terminations and other applications.

100 OHM MA 422-85112 \$12.95

50 OHM MA 422-42011 \$9.95

Send for Free Catalog
(603) 673-7724

RF NOISE BRIDGE KIT

Build it yourself and get all the features at half the cost.

Know more about your antenna, 160 through 6 meters. Kit includes all parts and a reprint of the HAM RADIO Magazine February 1977 article plus details on construction, calibration and use. Drill a few holes, solder a few joints and save a lotta bucks.

SAVE \$20.00

Whitehouse priced at

\$29.95

Please add \$2.00 per order for shipping and handling. Thank you.

G.R. WHITEHOUSE & CO. ✓W7
23 Newbury Drive, Amherst, NH 03031

RADIO BOOKSHOP

LICENSE STUDY GUIDES & TAPES

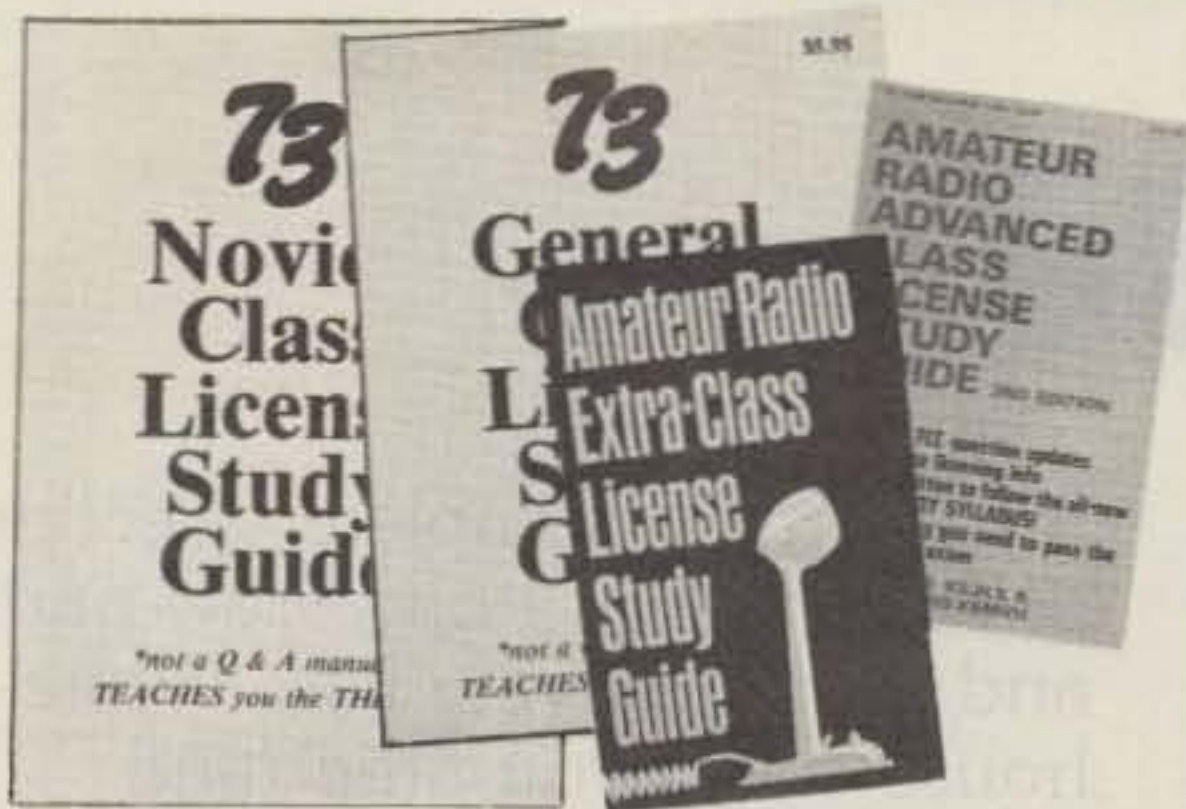

● **NOVICE STUDY GUIDE—SG7357**—Here is a completely new study guide and reference book for the potential ham. This is not a question/answer memorization course. Electronic and radio fundamentals are presented and explained in an easy-to-understand fashion, preparing the beginner for the Novice exam. Includes the latest FCC amateur regulations, as well as application forms. Easily the best path into the exciting world of ham radio! \$4.95.*

● **GENERAL CLASS STUDY GUIDE—SG7358**—A complete theory course for the prospective General or Technician. This reference explains transistor, amplifier, and general radio theory, while preparing the Novice for the "big" ticket. After getting your ticket, you'll use this guide again and again as an electronic reference source. Not a question/answer guide that becomes dated when the FCC updates the amateur exams. \$5.95.*

● **ADVANCED CLASS STUDY GUIDE—SG1081**—Ready to upgrade your license? To prevent retaking the FCC theory exam, you need the 73 Advanced theory guide. SSB, antenna theory, transmitters, and electronics measuring techniques are covered in detail in this easy-to-follow study guide. Special modes and techniques, such as RTTY, are also treated. An engineering degree is not necessary to master Advanced theory—try this book before visiting the examiner's office! \$5.95.*

● **EXTRA CLASS LICENSE STUDY GUIDE—SG1080**—Before going for your 1 × 2 call, it pays to be a master of the Extra class electronic theory. This study guide is the logical extension of the 73 theory course. All the theory necessary to pass the exam is presented. Antennas, transmission lines, swr are discussed, as well as noise, propagation, and specialized communication techniques. This book is not a classroom lecture or memorization guide, but rather a logical presentation of the material that must be understood before attempting the Extra exam. Save yourself a return trip to the FCC and try the 73 method first! \$5.95.*



NOVICE THEORY TAPES Startling Learning Breakthrough



● **NOVICE THEORY TAPES—CT7300**—Startling Learning Breakthrough. You'll be astounded at how really simple the theory is when you hear it explained on these tapes. Three tapes of theory and one of questions and answers from the latest Novice exams give you the edge you need to breeze through your exam. 73 is interested in helping get more amateurs, so we're giving you the complete set of our tapes for the incredibly low price of **ONLY \$15.95.***

Scientists have proven that you learn faster by listening than by reading because you can play a cassette tape over and over in your spare time—even while you're driving! You get more and more info each time you hear it.

You can't progress without solid fundamentals. These four hour-long tapes give you all the basics you'll need to pass the Novice exam easily. You'll have an understanding of the basics which will be invaluable to you for the rest of your life! Can you afford to take your Novice exam without first listening to these tapes? Set of 4—\$15.95.*



SSTV

● **SLOW SCAN TELEVISION TAPE—CT7350**—Prize-winning programs from the 73 SSTV contest. Excellent for Demo! \$5.95.*



73 CODE SYSTEM TAPES

code, sent at the official FCC standard (no other tape we've heard uses these standards, so many people flunk the code when they are suddenly—under pressure—faced with characters sent at 13 wpm and spaced for 5 wpm). This tape is not memorizable, unlike the zany 5 wpm tape, since the code groups are entirely random characters sent in groups of five.

"COURAGEOUS"

20+ WPM—CT7320—Code is what gets you when you go for the Extra class license. It is so embarrassing to panic out just because you didn't prepare yourself with this tape. Though this is only one word faster, the code groups are so difficult that you'll almost fall asleep copying the FCC stuff by comparison. Users report that they can't believe how easy 20 per really is with this fantastic one hour tape.

Any Four Tapes For \$15.95! *
\$4.95 Each! *

"GENESIS"

5 WPM—CT7305—This is the beginning tape for people who do not know the code at all. It takes them through the 26 letters, 10 numbers and necessary punctuation, complete with practice every step of the way using the newest blitz teaching techniques. It is almost miraculous! In one hour many people—including kids of ten—are able to master the code. The ease of learning gives confidence to beginners who might otherwise drop out.

"THE CANADIAN"

10+ WPM—CT7310—73 hasn't forgotten the Canadian hams—our 10 WPM tape prepares you to breeze through your country's licensing exams. Like the other code groups, the tape is not memorizable and, once mastered, provides a margin of safety in the actual text situation.

"OUTRAGEOUS"

25+ WPM—CT7325—This is the tape for that small group of overachieving hams who wouldn't be content to simply satisfy the code requirements of the Extra Class license. It's the toughest tape we've got and we keep a permanent file of hams who have mastered it. Let us know when you're up to speed and we'll inscribe your name in 73's CW "Hall of Fame."

"THE STICKLER"

6+ WPM—CT7306—This is the practice tape for the Novice and Technician licenses. It is made up of one solid hour of

"BACK BREAKER"

13+ WPM—CT7313—Code groups again, at a brisk 13 per so you will be at ease when you sit down in front of the steely-eyed government inspector and he starts sending you plain language at only 13 per. You need this extra margin to overcome the panic which is universal in the test situations. When you've spent your money and time to take the test, you'll thank heavens you had this back-breaking tape.



73 Radio Bookshop • Peterborough NH 03458. Be sure to include check or detailed credit card information.

* Add \$1.00 handling charge for orders under \$10.00. Note: Prices subject to change on books not published by 73 Magazine.

FOR CUSTOMER SERVICE CALL 603-924-6132

Radio Bookshop

73 TECHNICAL LIBRARY

● **BEHIND THE DIAL**—BK7307—By Bob Grove. Get more fun out of shortwave listening with this interesting guide to receivers, antennas, frequencies and interference. \$4.95.*

● **THE CHALLENGE OF 160**—BK7309—is the newest book in the 73 technical library, dedicated to 160 meter operating. Si Dunn provides all necessary information to get started on this unique band. The all-important antenna and ground systems are described in detail. The introduction contains interesting photos of Stew Perry's (the King of 160) shack. This reference is a must for new and experienced "Top Band" operators. Price: \$1.95.*

● **IC OP-AMP COOKBOOK**—BK1028—by Walter G. Jung. Covers not only the basic theory of the IC op amp in great detail, but also includes over 250 practical circuit applications, liberally illustrated. 592 pages, 5½ × 8½, softbound. \$12.95.*

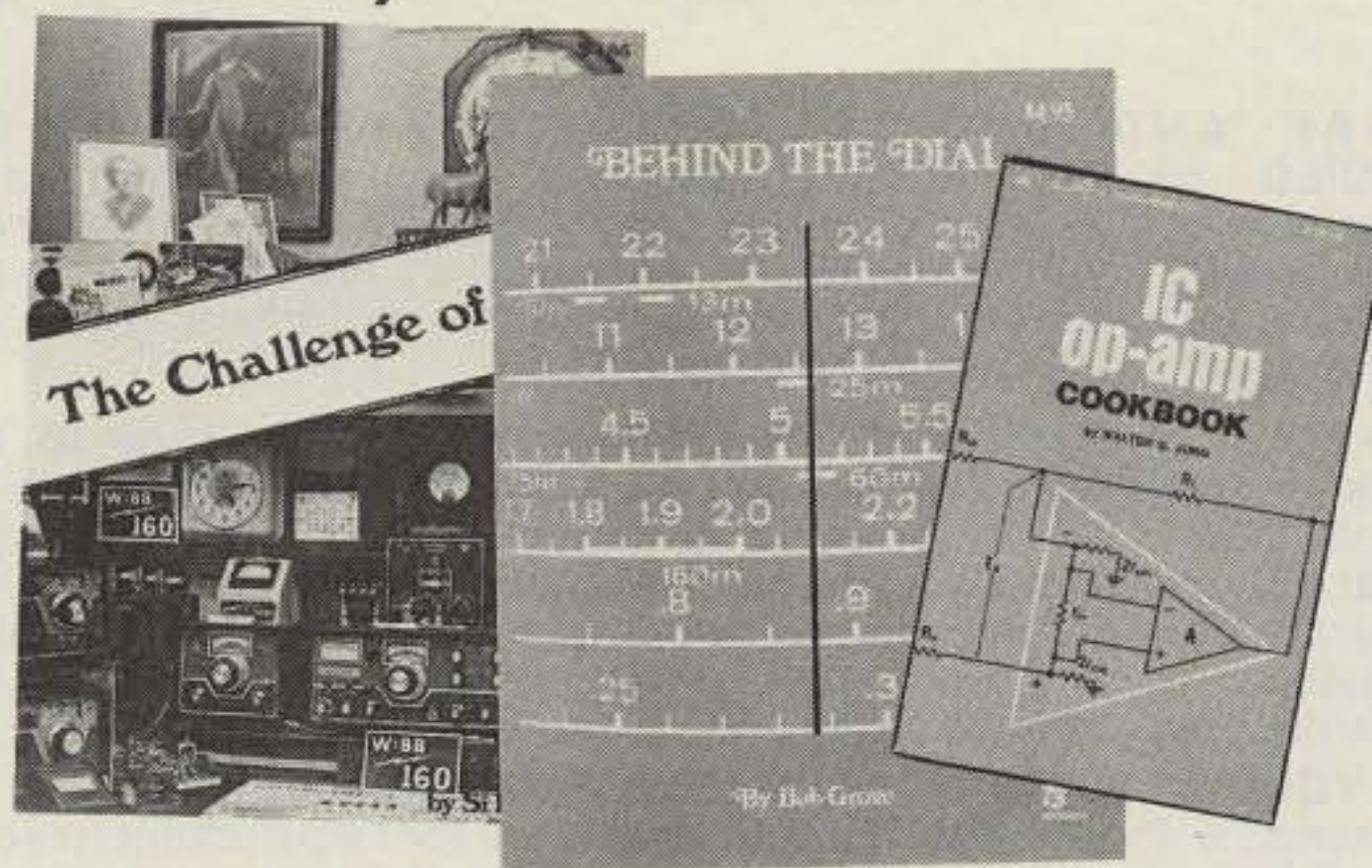

● **INTRODUCTION TO RTTY**—BK7380—A beginner's guide to radioteletype including teletypewriter fundamentals, signals, distortion and RTTY art. You can be a RTTY artist! A 73 publication. \$2.00.*

● **THE NEW RTTY HANDBOOK**—BK7347—is a new edition and the only up-to-date RTTY book available. The state of the art has been changing radically and has made all previous RTTY books obsolete. It has the latest circuits, great for the newcomer and expert alike. \$5.95.*

● **PROPAGATION WIZARD'S HANDBOOK**—BK7302—by J. H. Nelson. When sunspots riddled the worldwide communications networks of the 1940's, John Henry Nelson looked to the planets for an answer. The result was a theory of propagation forecasting based upon interplanetary alignment that made the author the most reliable forecaster in America today. The book provides an enlightened look at communications past, present, and future, as well as teaching the art of propagation forecasting. \$6.95.*

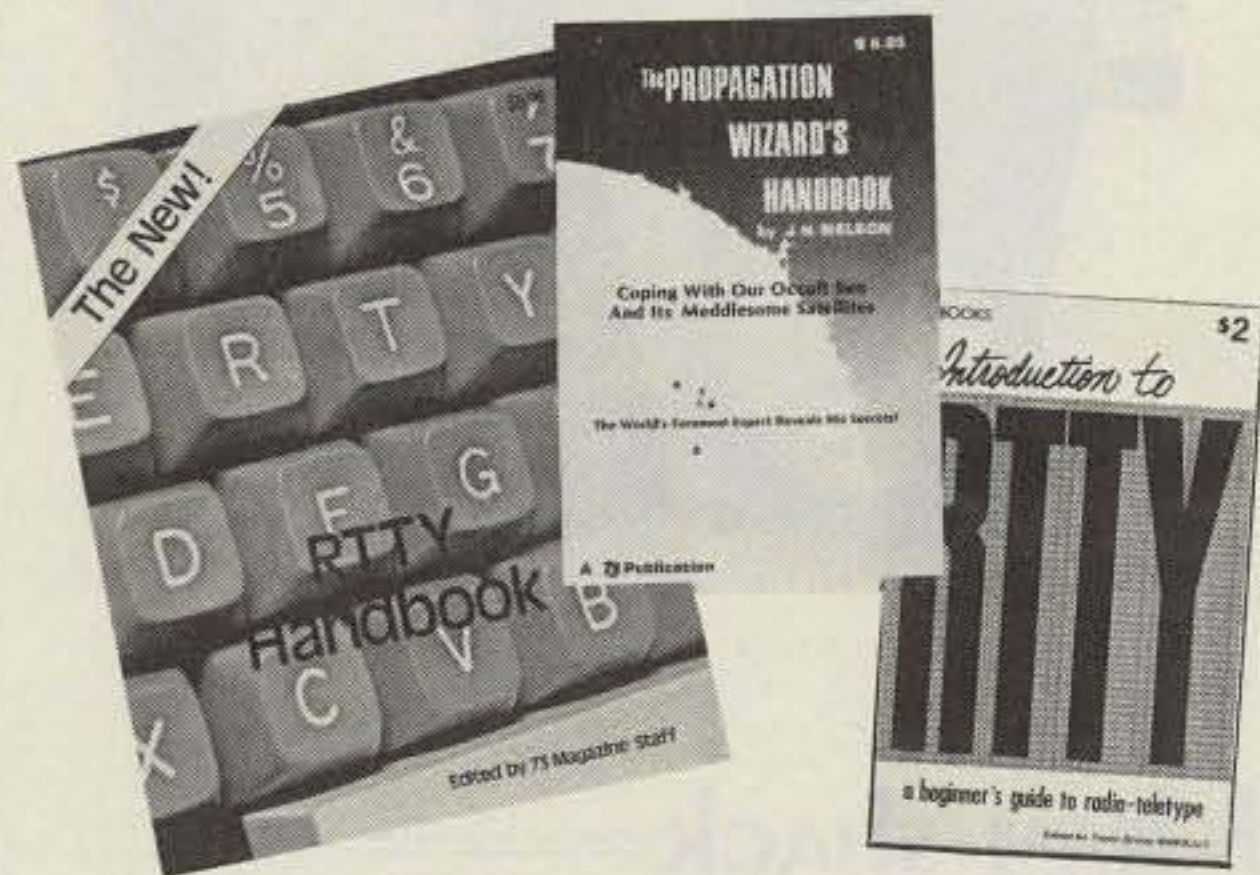

● **SSB... THE MISUNDERSTOOD MODE**—BK7351—by James B. Wilson. Single Sideband Transmission... thousands of us use it every day, yet it remains one of the least understood facets of amateur radio. J. B. Wilson presents several methods of sideband generation, amply illustrated with charts and schematics, which will enable the ambitious reader to construct his own sideband generator. A must for the technically-serious ham. \$5.50.*

● **SSTV HANDBOOK**—BK7354(hardcover), BK7355(softcover)—This excellent book tells all about it, from its history and basics to the present state-of-the-art techniques. Contains chapters on circuits, monitors, cameras, color SSTV, test equipment and much more. Hardbound \$7.00, softbound \$5.00.*

● **WEATHER SATELLITE HANDBOOK**—BK7370—Simple equipment and methods for getting good pictures from the weather satellite. Antennas, receivers, monitors, facsimile you can build, tracking, automatic control (you don't even have to be home). Dr. Taggart WB8DQT. \$4.95.*



ANTENNAS

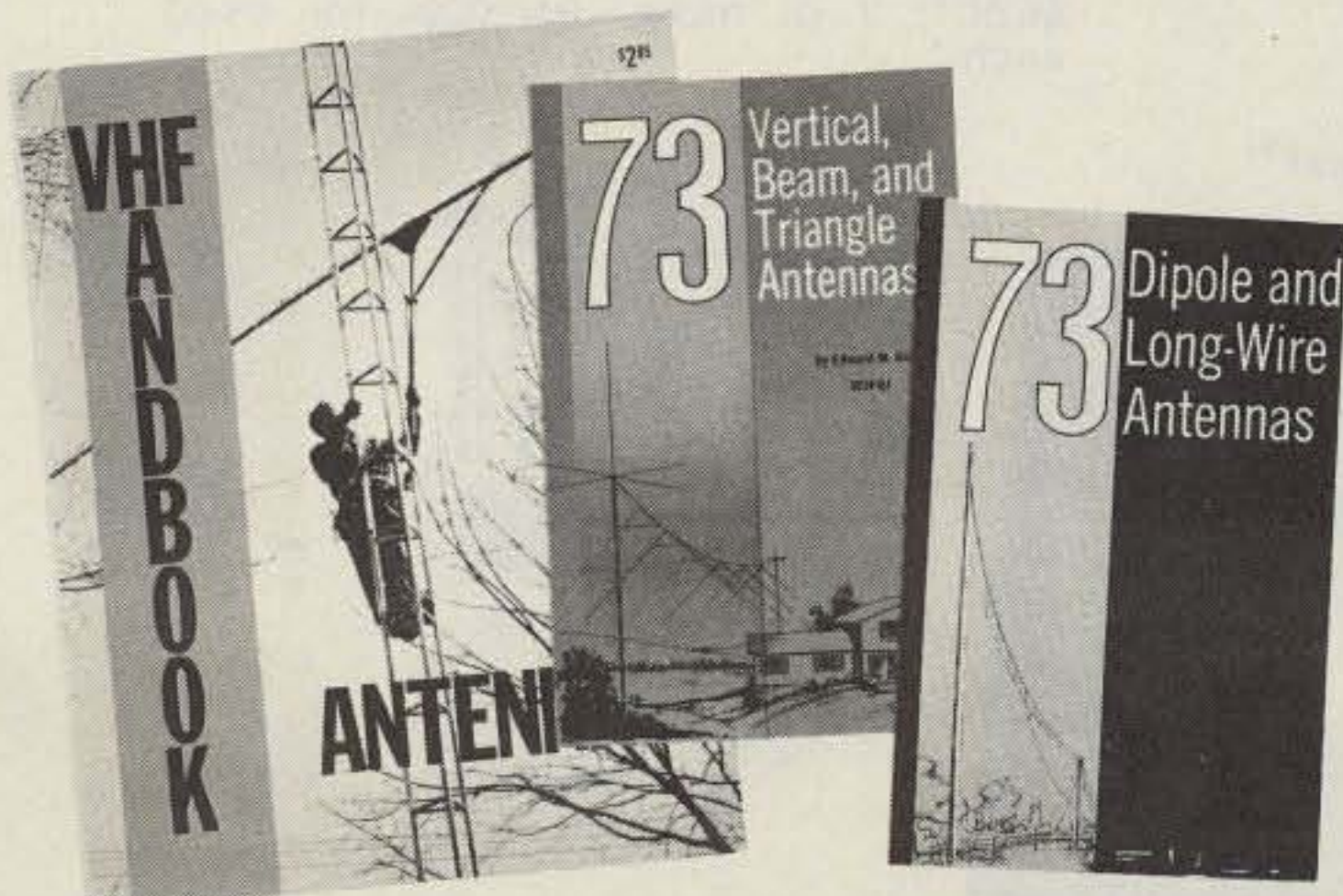

● **73 DIPOLE AND LONG-WIRE ANTENNAS**—BK1016—by Edward M. Noll W3FQJ. This is the first collection of virtually every type of wire antenna used by amateurs. Includes dimensions, configurations, and detailed construction data for 73 different antenna types. Appendices describe the construction of noise bridges, line tuners, and data on measuring resonant frequency, velocity factor, and swr. \$5.50.*

● **73 VERTICAL, BEAM AND TRIANGLE ANTENNAS**—BK1069—by Edward M. Noll W3FQJ. Describes 73 different antennas for amateurs. Each design is the result of the author's own experiments covering the construction of noise bridges and antenna line tuners, as well as methods for measuring resonant frequency, velocity factor, and standing-wave ratios. 160 pages. \$5.50.*

● **VHF ANTENNA HANDBOOK**—BK7368—The NEW VHF Antenna Handbook details the theory, design and construction of hundreds of different VHF and UHF antennas... A practical book written for the average amateur who takes joy in building, not full of complex formulas for the design engineer. Packed with fabulous antenna projects you can build. \$4.95.*

73 Radio Bookshop • Peterborough NH 03458. Be sure to include check or detailed credit card information.

* Add \$1.00 handling charge for orders under \$10.00. Note: Prices subject to change on books not published by 73 Magazine.

FOR TOLL FREE ORDERING CALL 1 800 258 5473

RADIO BOOKSHOP

TEST EQUIPMENT

● **RF AND DIGITAL TEST EQUIPMENT YOU CAN BUILD**—BK1044—Rf burst, function, square wave generators, variable length pulse generators—100 kHz marker, i-f and rf sweep generators, audio osc, af/rf signal injector, 146 MHz synthesizer, digital readouts for counters, several counters, prescaler, microwave meter, etc. 252 pages. \$5.95.*

● **VOL. I COMPONENT TESTERS**—LB7359—... how to build transistor testers (8), diode testers (3), IC testers (3), voltmeters and VTVMs (9), ohmmeters (8 different kinds), inductance (3), capacity (9), Q measurement, crystal checking (6), temperature (2), aural meters for the blind (3) and all sorts of miscellaneous data on meters... using them, making them more versatile, making standards. Invaluable book. \$4.95.*

● **VOL. II AUDIO FREQUENCY TESTERS**—LB7360—... jam packed with all kinds of audio frequency test equipment. If you're into SSB, RTTY, SSTV, etc., this book is a must for you... a good book for hi-fi addicts and experimenters, too! \$4.95.*

● **VOL. III RADIO FREQUENCY TESTERS**—LB7361—Radio frequency waves, the common denominator of Amateur Radio. Such items as SWR, antenna impedance, line impedance, rf output and field strength; detailed instructions on testing these items includes sections on signal generators, crystal calibrators, grid dip oscillators, noise generators, dummy loads and much more. \$4.95.*

● **VOL. IV IC TEST EQUIPMENT**—LB7362—Become a troubleshooting wizard. All you need to know about pulse, audio and sync generators, frequency counters, digital component testers, logic probes and more! Plus a cumulative index for all four volumes of the 73 Test Equipment Library. \$4.95.*



THE WELL-EQUIPPED HAM SHACK

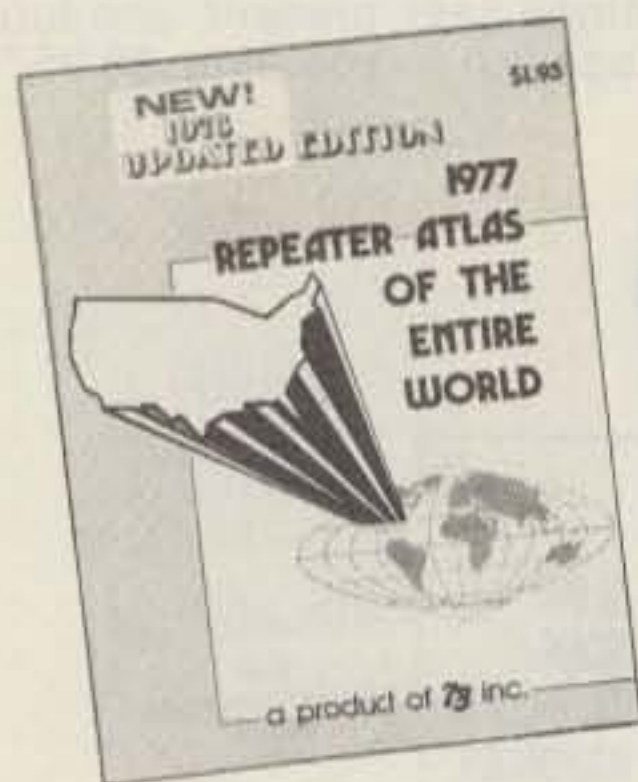

● **NEW REPEATER ATLAS OF THE ENTIRE WORLD**—BK7345—150% as big as any list ever available—nearly 900 more repeaters listed. New improved maps show the locations by frequency of every repeater in the States. Only \$1.95.*

● **QSL CARDS**—73 turns out a fantastic series of QSL cards at about half the cost of having them done elsewhere because they are run as a fill-in between printing books and other items in the 73 Print Shop. 250 Style W—QW0250—for \$8.95*; 500 Style W—QW0500—for \$13.95*; 250 Style X—QX0250—for \$8.95*; 500 Style X—QX0500—for \$13.95*; 250 Style Y—QY0250—for \$8.95*; 500 Style Y—QY0500—for \$13.95.*

● **73 MAGAZINE BINDERS**—Preserve and protect your collection for your lifetime! There's no excuse for lost issues when you have these handsome red binders with gold lettering. Order 1—BN1001—for \$6.50*; 2 or more—BN1002—for \$6.00 each.*

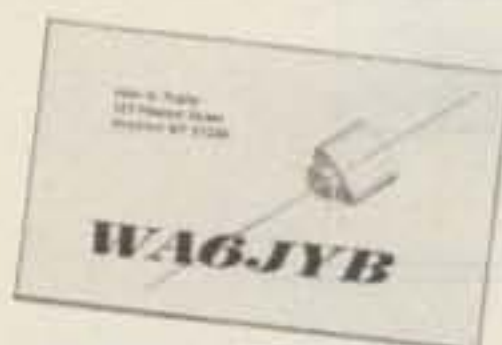

Style X



Style W



Style Y

● **BACK ISSUES**—Complete your collection—many are prime collectibles now, classics in the field! A full collection is an invaluable compendium of radio and electronics knowledge! \$2.00 each*, or 5 for \$5.00.*

● **LIBRARY SHELF BOXES**—These sturdy white, corrugated, dirt-resistant boxes each hold a full year of 73 or Kilobaud. With your order, request self-sticking labels for any of the following: 73, Kilobaud, CQ, QST, Ham Radio, Personal Computing, Radio Electronics, Interface Age, and Byte. Order 1—BX1000—for \$2.00*; order 2-7—BX1001—for \$1.50 each*; order 8 or more—BX1002—for \$1.25 each*.



73 Radio Bookshop • Peterborough NH 03458. Be sure to include check or detailed credit card information.
* Add \$1.00 handling charge for orders under \$10.00. Note: Prices subject to change on books not published by 73 Magazine.

FOR CUSTOMER SERVICE CALL 603 824 6422

**21,560
pages.**



**That's the size of the world's
most comprehensive guide to
the subject of ham radio:
18 years of 73 Magazine.**

The back issues of 73 are a gold mine of interesting articles. Unlike the other magazines, which fill their pages with activity reports, there's little to go stale in 73. You'll find pioneering articles on SSTV, FM, repeaters, ICs, and computers. Even the editorials are fun as Wayne Green's dire predictions, like the debacle of incentive licensing, have come to pass.

Clip the coupon below and send for 73's new back issue catalogue. Treat yourself (or a friendly ham) to some fun, and a fantastic bargain to boot.

YES! Rush me 73's FREE Back Issue Catalogue!

Name _____

Address _____

City _____ State _____ Zip _____

S11

73 **magazine**
PETERBOROUGH NH 03458

IS HARD COPY STORAGE A PROBLEM?



73, as thick as it is, is more like a floppy when it comes to standing on the bookshelf. Try the 73 Library Shelf Boxes, . . . sturdy corrugated white dirt resistant cardboard boxes which will keep them from flopping around. We have self-sticking labels for the boxes, too, not only for 73, but also for *Kilobaud* . . . and for *CQ*, *QST*, *Ham Radio*, *Personal Computing*, *Radio Electronics*, *Interface Age*, and *Byte*. Ask for whatever stickers you want with your box order. They hold a full year of 73 . . . or *Kilobaud*. Your magazine library is your prime reference, keep it handy and keep it neat with these strong library shelf boxes . . . One box is \$2.00, 2 boxes are \$3.00 and eight boxes are \$10.00. Be sure to specify which labels we should send. Have your credit card handy and call our toll-free order number 800-258-5473, or use the order card in the back of the magazine and mail to:



MOVING?

Let us know 8 weeks in advance so that you won't miss a single issue of 73 Magazine. Attach old label where indicated and print new address in space provided. Also include your mailing label whenever you write concerning your subscription. It helps us serve you promptly. Write to:



- Address change only
- Extend subscription
- Enter new subscription
- 1 year \$15.00
- Payment enclosed (1 extra BONUS issue)
- Bill me later

If you have no label handy, print OLD address here.

AFFIX LABEL

Name _____ Call _____

Address _____

City _____ State _____ Zip _____

print NEW address here:

Name _____ Call _____

Address _____

City _____ State _____ Zip _____

PROPAGATION

by
J. H. Nelson

EASTERN UNITED STATES TO:

| | GMT: | 00 | 02 | 04 | 06 | 08 | 10 | 12 | 14 | 16 | 18 | 20 | 22 |
|--------------|------|-----|-----|----|----|----|----|-----|-----|-----|-----|-----|----|
| ALASKA | 14 | 7A | 7 | 7 | 7 | 7 | 3A | 7 | 14 | 21 | 21A | 21 | |
| ARGENTINA | 14 | 14 | 7A | 7B | 7 | 7 | 14 | 21A | 21A | 21A | 21A | 21 | |
| AUSTRALIA | 21 | 14 | 7B | 7B | 7B | 7B | 7B | 14 | 21 | 21 | 21 | 21A | |
| CANAL ZONE | 14 | 7A | 7 | 7 | 7 | 7 | 14 | 21A | 21A | 21A | 21 | 21 | |
| ENGLAND | 7 | 7 | 7 | 7 | 7 | 7B | 14 | 21A | 21A | 21 | 14 | 7 | |
| HAWAII | 21 | 14 | 7B | 7 | 7 | 7 | 7 | 7B | 14 | 21A | 21A | 21 | |
| INDIA | 7 | 7 | 7B | 7B | 7B | 7B | 14 | 21 | 14 | 14B | 14B | 14B | |
| JAPAN | 14 | 14B | 7B | 7B | 7 | 7 | 7 | 7B | 7B | 7B | 7B | 14 | |
| MEXICO | 14 | 14 | 7 | 7 | 7 | 7 | 7A | 14A | 21A | 21A | 21A | 21 | |
| PHILIPPINES | 14 | 14 | 7B | 7B | 7B | 7B | 7B | 14 | 14 | 14 | 14B | 14 | |
| PUERTO RICO | 14 | 7 | 7 | 7 | 7 | 7 | 14 | 21A | 21A | 21A | 21 | 14 | |
| SOUTH AFRICA | 14 | 14B | 14B | 7B | 7B | 14 | 21 | 21A | 21A | 21A | 21 | 21 | |
| U. S. S. R. | 7 | 7 | 3A | 3A | 7 | 7B | 14 | 21A | 14 | 14B | 7B | 7 | |
| WEST COAST | 21 | 14 | 7A | 7 | 7 | 7 | 7 | 14 | 21 | 21A | 21A | 21 | |

CENTRAL UNITED STATES TO:

| | | | | | | | | | | | | |
|--------------|-----|-----|-----|----|----|----|----|-----|-----|-----|-----|-----|
| ALASKA | 21 | 14 | 7 | 7 | 7 | 7 | 3A | 7 | 14 | 21 | 21A | 21 |
| ARGENTINA | 21 | 14 | 14 | 7B | 7 | 7 | 14 | 21A | 21A | 21A | 21A | 21 |
| AUSTRALIA | 21A | 14 | 14 | 7B | 7B | 7B | 7B | 14 | 21 | 21 | 21 | 21A |
| CANAL ZONE | 21 | 14 | 7A | 7 | 7 | 7 | 14 | 21A | 21A | 21A | 21A | 21A |
| ENGLAND | 7 | 7 | 7 | 7 | 7 | 7B | 14 | 21A | 21A | 21 | 14 | 7B |
| HAWAII | 21 | 14 | 14 | 7 | 7 | 7 | 7 | 7 | 14 | 21A | 21A | 21A |
| INDIA | 14 | 14 | 7B | 7B | 7B | 7B | 7B | 14 | 14 | 14B | 14B | 14B |
| JAPAN | 21 | 14 | 7B | 7B | 7 | 7 | 7 | 7 | 7B | 7B | 14B | 21 |
| MEXICO | 14 | 14 | 7 | 7 | 7 | 7 | 7 | 14 | 21A | 21A | 21 | 21 |
| PHILIPPINES | 21 | 14 | 7B | 7B | 7B | 7B | 7B | 7 | 14B | 14B | 14B | 14 |
| PUERTO RICO | 14 | 7A | 7 | 7 | 7 | 7 | 14 | 21 | 21A | 21A | 21A | 21 |
| SOUTH AFRICA | 14 | 14B | 14B | 7B | 7B | 7B | 14 | 21A | 21A | 21A | 21 | 21 |
| U. S. S. R. | 7 | 7 | 3A | 3A | 7 | 7B | 7B | 14 | 14 | 14B | 7B | 7B |

WESTERN UNITED STATES TO:

| | | | | | | | | | | | | |
|--------------|-----|-----|----|----|----|----|----|-----|-----|-----|-----|-----|
| ALASKA | 21 | 14 | 7 | 3A | 3A | 7 | 3A | 3A | 7 | 14 | 21 | 21A |
| ARGENTINA | 21 | 14 | 14 | 7B | 7 | 7 | 7B | 14 | 21A | 21A | 21A | 21A |
| AUSTRALIA | 21A | 21A | 14 | 14 | 7B | 7B | 7B | 7 | 14 | 21 | 21 | 21A |
| CANAL ZONE | 21 | 14 | 7A | 7 | 7 | 7 | 7 | 14 | 21A | 21A | 21A | 21A |
| ENGLAND | 7B | 7 | 7 | 7 | 7 | 7B | 7B | 14B | 21 | 21 | 14 | 7B |
| HAWAII | 28 | 21A | 14 | 14 | 7 | 7 | 7 | 7 | 14 | 21A | 21A | 28 |
| INDIA | 14A | 14 | 7B | 7B | 7B | 7B | 7B | 7B | 14 | 14 | 14B | 14B |
| JAPAN | 21A | 21 | 14 | 7B | 7 | 7 | 7 | 7 | 7B | 14 | 21 | |
| MEXICO | 21 | 14 | 7A | 7 | 7 | 7 | 7 | 14 | 21A | 21A | 21 | 21 |
| PHILIPPINES | 21A | 21 | 14 | 7B | 7B | 7B | 7B | 7B | 14 | 14 | 14B | 14 |
| PUERTO RICO | 21 | 14 | 7A | 7 | 7 | 7 | 7 | 14 | 21A | 21A | 21A | 21 |
| SOUTH AFRICA | 14 | 14B | 7B | 7B | 7B | 7B | 7B | 14 | 21A | 21A | 21A | 21 |
| U. S. S. R. | 7B | 7 | 7 | 3A | 7 | 7B | 7B | 14B | 14 | 14B | 7B | 7B |
| EAST COAST | 21 | 14 | 7A | 7 | 7 | 7 | 7 | 14 | 21 | 21A | 21A | 21 |

- A = Next higher frequency may also be useful
- B = Difficult circuit this period
- F = Fair
- G = Good
- P = Poor
- SF = Chance of solar flares

november

| sun | mon | tue | wed | thu | fri | sat |
|----------------|------------------|-------------------|-------------------|-------------------|----------------|----------------|
| ☉ ☽ ☿ ♁ | | | 1 G | 2 G | 3 G | 4 G |
| 5 G | 6 G/SF | 7 F/SF | 8 P/SF | 9 P/SF | 10 F | 11 F |
| 12 F | 13 F | 14 F | 15 G | 16 G | 17 G | 18 G |
| 19 G | 20 G | 21 F | 22 F | 23 G | 24 G | 25 G |
| 26 F | 27 F | 28 P/SF | 29 P/SF | 30 P/SF | | |

READER SERVICE

| | | | |
|---|---|--|--|
| A46 ABC Communications 72 | D39 Jim DeNinno & Co. 292 | M62 Mid Com Electronics, Inc./Edgecom 63 | U2 Unarco-Rohn 251 |
| A1 Adirondack Radio Supply . 119, 294 | D15 DenTron 5 | M41 Midland International 185 | U8 United Products 295 |
| A24 Adva Electronics 300 | D20 Digital Research Corp. 302, 303 | M57 Monroe Electronics 88 | U6 Universal Amateur Radio Service, Inc. 209 |
| A60 AED Electronics 134 | D23 Dovetron 110 | N2 New-Tronics 213 | V1 Vanguard Labs 209 |
| A2 Aidelco 313 | D25 DSI Instruments 23, 135, 211 | O5 OK Machine & Tool 147, 149, 173 | V5 VHF Engineering 221 |
| A57 Alliance Manufacturing Co. 19 | E1 ECM Corporation 101 | O3 Optoelectronics, Inc. 301 | V18 VHF Engineering/Edgecom 55 |
| A47 Aluma Tower Company 152 | E19 Edgecom 51 | P15 Pace-Traps 101 | W17 Westcom Engineering 21, 27 |
| A40 Amateur Radio Supply of Nashville, Inc. 205 | * Electronic Systems 167 | P30 Palomar Electronics 27 | W18 Western Electronics 214 |
| A51 Amateur Radio of Rochester 206 | E12 Engineering Specialties 312 | * Palomar Engineers 251 | W7 G.R. Whitehouse & Co. 315 |
| A67 Amperex Electronic Corporation 93 | F1 Fair Radio Sales 292 | P31 Panasonic 41 | W2 Wilson Electronics 3 |
| A62 Antenna Specialists 19 | F5 Fleisher Corporation 101 | P41 P.C. Electronics 105 | X1 Xitex 284, 285 |
| A68 Apollo Products 207 | G12 Germantown Amateur Supply 87 | P2 Poly Paks 307 | Y1 Yaesu Electronics Corp. CIII, 111, 215 |
| A6 Apron Laboratories 294 | G20 G & G Radio Electronics Co. 290 | P26 Printed Circuit Products 110 | Z1 ZZZ Electronics, Inc. 134, 206 |
| A50 Associated Radio 308 | G4 Godbout Electronics 304 | P21 Priority One 145 | From 73 Pages 291, 316-322 |
| A63 Astral Electronics Corporation 209 | * HAL Communications Corp. 207 | Q3 Quest Electronics 294 | |
| A64 Aureus Electronics, Inc./Edgecom 79 | H24 Hal-Tronix 241 | R1 Radio Amateur Callbook, Inc. 311 | |
| B1 Babylon Electronics 290 | H2 Ham Radio Center 33, 309 | R10 Rainbow Industries 190 | |
| B23 Barker-Williamson 88 | H16 Hamtronics, NY 299 | R8 Ramsey Electronics 29, 298 | |
| B32 Bay-Com 105 | H8 Hamtronics, PA 228-237 | R15 Rolin Distributors 88 | |
| B29 Britt's 2-Way Radio 119 | H26 Hartwell's Office World 292 | R21 Rush Electronics 294 | |
| B37 Brown Bros. Machine Co., Inc. 290 | H5 Heath Company 195 | R18 R.W. Electronics, Inc. 292 | |
| B8 Bullet Electronics 296, 297 | H3 Henry Radio CII | S63 Semiconductors Surplus 314 | |
| B30 Burghardt Amateur Center 223 | I1 ICOM 17, 107 | S3 Sentry 214 | |
| C88 C & A Electronic Enterprises 127 | * Instant Software 264, 265 | S39 Sere-Rose & Spencer Electronics 101 | |
| C3 Clegg 123, 129, 175, 187 | I9 Integrated Circuits, Unltd. 306 | S33 S-F Amateur Radio Services 165, 214 | |
| C21 Coakit 105 | I27 IRL 290 | S67 S.G.C. 62 | |
| C83 Cohoon Amateur Supply 219 | J1 Jameco Electronics 305 | S8 Spectrum Communications 225 | |
| C95 Cohoon Amateur Sup./Edgecom 47 | J2 Jan Crystals 21 | S10 SST Electronics 93, 196, 197 | |
| C63 Colorado Silver Company 105 | J8 JRS Electronics 110 | S50 O.C. Stafford Electronics 101 | |
| C75 Comm Center, Laurel 149 | K13 Kantronics 19 | S18 Standard Communications 191 | |
| C58 Communications Ctr., NE 189, 287 | * Kenwood CIV, 6-13 | S64 Steven Products 243 | |
| C96 Communications Ctr., NE/Edgecom 73 | K14 Key Electronics 105 | S38 Stuart Electronics 80, 81 | |
| C89 Communications Services 152 | * Kilobaud 253 | S43 Surplus Electronics 310 | |
| C6 Communications Specialists 24, 25 | L9 Long's Electronics 176-181 | * Ten-Tec 34, 35 | |
| C90 Curtis Electro Devices 21 | L10 L-Tronics 159 | T34 Thomas Communications 277 | |
| D6 Peter W. Dahl Company 87 | L17 Lunar Electronics 220 | T44 Tower Electronics Corp./Edgecom 67 | |
| D10 Davis Electronics 292 | M35 Madison Electronics Supply 31 | T18 Trac Electronics, Inc. 183, 190 | |
| D35 Daytapro Electronics, Inc. 290 | M36 Maggiore Electronic Labs 141 | T35 Trans Com 105 | |
| D31 Delaware Amateur Supply 101 | M56 Marko Manufacturing, Inc. 152 | T3 Tufts Radio Electronics 246-249 | |
| | M52 MFJ Enterprises 89, 183, 243 | T45 Tufts Radio Electronics/Edgecom 59 | |
| | M48 Microtronics 294 | | |

*Reader Service inquiries not honored.

BOOKS, ETC.

| | |
|---|--|
| BK1016 73 DIPOLE & LONG WIRE ANTENNAS \$ 5.50 | QW0500 QSL CARDS—STYLE W—500 \$13.95 |
| ST0000 73 BACK ISSUE \$ 3.00 | QX0250 QSL CARDS—STYLE X—250 \$ 8.95 |
| ST2500 73 BACK ISSUES—25 OUR CHOICE \$10.00 | QX0500 QSL CARDS—STYLE X—500 \$13.95 |
| ST0500 73 BACK ISSUES—5 YOUR CHOICE \$ 5.00 | QY0250 QSL CARDS—STYLE Y—250 \$ 8.95 |
| ST1000 73 BACK ISSUES—10 YOUR CHOICE \$12.00 | QY0500 QSL CARDS—STYLE Y—500 \$13.95 |
| ST2501 73 BACK ISSUES—25 YOUR CHOICE \$20.00 | BK7345 REPEATER ATLAS \$ 1.95 |
| BK7307 BEHIND THE DIAL \$ 4.95 | BK1044 RF DIGITAL TEST EQUIPMENT \$ 5.95 |
| BN1001 BINDER—73—1 \$ 6.50 | BK7347 RTTY HANDBOOK \$ 5.95 |
| BN1002 BINDER—73—2&UP \$ 6.00 | BX1000 SHELF BOX—1 \$ 2.00 |
| BK7309 CHALLENGE OF 160 \$ 4.95 | BX1001 SHELF BOX—2 \$ 1.50 |
| CT7305 CODE TAPE—5 WPM \$ 4.95 | BX1002 SHELF BOX—8 UP \$ 1.25 |
| CT7306 CODE TAPE—6 WPM \$ 4.95 | BK7351 SSB THE MISUNDERSTOOD MODE \$ 5.50 |
| CT7310 CODE TAPE—10 WPM \$ 4.95 | BK7354 SSTV HANDBOOK (HARDCOVER) \$ 7.00 |
| CT7313 CODE TAPE—13 WPM \$ 4.95 | BK7355 SSTV HANDBOOK (SOFTCOVER) \$ 5.00 |
| CT7320 CODE TAPE—20 WPM \$ 4.95 | CT7350 SSTV TAPE \$ 5.95 |
| CT7325 CODE TAPE—25 WPM \$ 4.95 | SG1081 STUDY GUIDE—ADVANCED CLASS \$ 5.95 |
| CT7399 CODE TAPE—LEARN MORSE CODE \$ 4.95 | SG1080 STUDY GUIDE—EXTRA CLASS \$ 5.95 |
| CT7394 CODE TAPES (ANY FOUR ABOVE) \$15.95 | SG7358 STUDY GUIDE—GENERAL CLASS \$ 5.95 |
| BK7321 GUIDE TO HAM RADIO \$ 4.95 | SG7357 STUDY GUIDE—NOVICE CLASS \$ 4.95 |
| BK7325 HOW TO BUILD A MICROCOMPUTER \$ 9.95 | LB7359 TEST EQUIP LIB V1—COMP TESTERS \$ 4.95 |
| BK1028 IC OP AMP COOKBOOK \$12.95 | LB7360 TEST EQUIP LIB V2—AUDIO TESTERS \$ 4.95 |
| BK7380 INTRO TO RTTY \$ 2.00 | LB7361 TEST EQUIP LIB V3—RADIO EQUIP \$ 4.95 |
| CT7300 NOVICE THEORY TAPES \$15.95 | LB7362 TEST EQUIP LIB V4—IC TEST EQUIP \$ 4.95 |
| BK1100 PRACTICAL TEST INSTRUMENTS \$ 4.95 | BK1069 VERTICAL BEAM & TRIANGLE ANTNS \$ 5.50 |
| BK7302 PROPAGATION WIZARD'S HANDBOOK \$ 6.95 | BK7368 VHF ANTENNA HANDBOOK \$ 4.95 |
| QW0250 QSL CARDS—STYLE W—250 \$ 8.95 | BK7370 WEATHER SATELLITE HANDBOOK \$ 4.95 |

THE CHRISTMAS GIFT OF A LIFETIME!

YAESU ANNOUNCES THEIR SENSATIONAL COMPUTER AGE CPU-2500R/K 2-METER 25 WATT TRANSCEIVER



Again, Yaesu, THE RADIO, takes a giant step forward with their computer age 4-bit Central Processor Unit controlling the Phase Locked Loop. It allows selection of 800 PLL channels with touch button station selection built into the optional keyboard mike . . . **PLUS** automatic scan, up or down across the entire 2 meter band . . . **PLUS** four memory channels . . . **PLUS** optional tone squelch encoding . . . **PLUS** tone burst . . . **PLUS** high SWR and reverse voltage polarity protection . . . **PLUS** 3/25 watts of power . . . **PLUS** fixed ± 600 KHz offsets . . . **PLUS** programmable offsets . . . **PLUS** tone pad microphone option . . . **PLUS** bright 3/8" LED six digit frequency display and another LED for memory display . . . and much more.

The CPU-2500R/K is a space age radio for discriminating amateurs utilizing the latest solid state techniques and it's on your dealer's shelf today!

Price And Specifications Subject To
Change Without Notice or Obligation



YAESU *The radio.*

YAESU ELECTRONICS CORP., 15954 Downey Ave., Paramount, CA 90723 • (213) 633-4007
YAESU ELECTRONICS Eastern Service Ctr., 9812 Princeton-Glendale Rd., Cincinnati, OH 45246

TR-7600



EVERY FEATURE YOU COULD POSSIBLY WANT IN A 2-METER FM RIG IS AVAILABLE NOW IN THE KENWOOD TR-7600

...THE RADIO THAT REMEMBERS

Even without its optional "Remote Controller," the TR-7600 gives you...

- Full 4-MHz coverage (144.000-147.995 MHz) on 2 meters • 800 channels • Dual concentric knobs for fast frequency change (100-kHz and 10-kHz steps)
- 5-kHz offset switch • MHz selector switch...for desired band (144, 145, 146, or 147 MHz) • Mode switch

for operating simplex or for switching the transmit frequency up or down 600 kHz for repeater operation... or for switching the transmitter to the frequency you have stored in the TR-7600's memory (while the receiver remains on the frequency you have selected with the dual knobs) • Memory channel...with simplex or repeater (plus or minus 600 kHz transmitter offset) operation.

The optional Remote Controller, with a built-in microprocessor, provides more operating features to the TR-7600 2-meter FM transceiver than found in any other rig! With the Remote Controller attached to your TR-7600, you can...

- Select any 2-meter frequency • Store frequencies in six memories • Scan all memory channels • Auto-

Actual Size



Remote Controller

- atically scan up all frequencies in 5-kHz steps
- Manually scan up or down in 5-kHz steps • Set lower and upper scan frequency limits • Reset scan to 144 MHz
- Stop scan (with HOLD button) • Cancel scan (for transmitting) • Automatically stop scan on first busy or open channel • Operate on MARS (143.95 MHz)

Subject to FCC approval.