



73

September 1963

~~was 40¢~~

Now Only 40¢

Amateur Radio

**TOWERS
ETC.**



"S" SERIES

AUDIO & POWER TRANSFORMERS & REACTORS For Complete Ham Systems

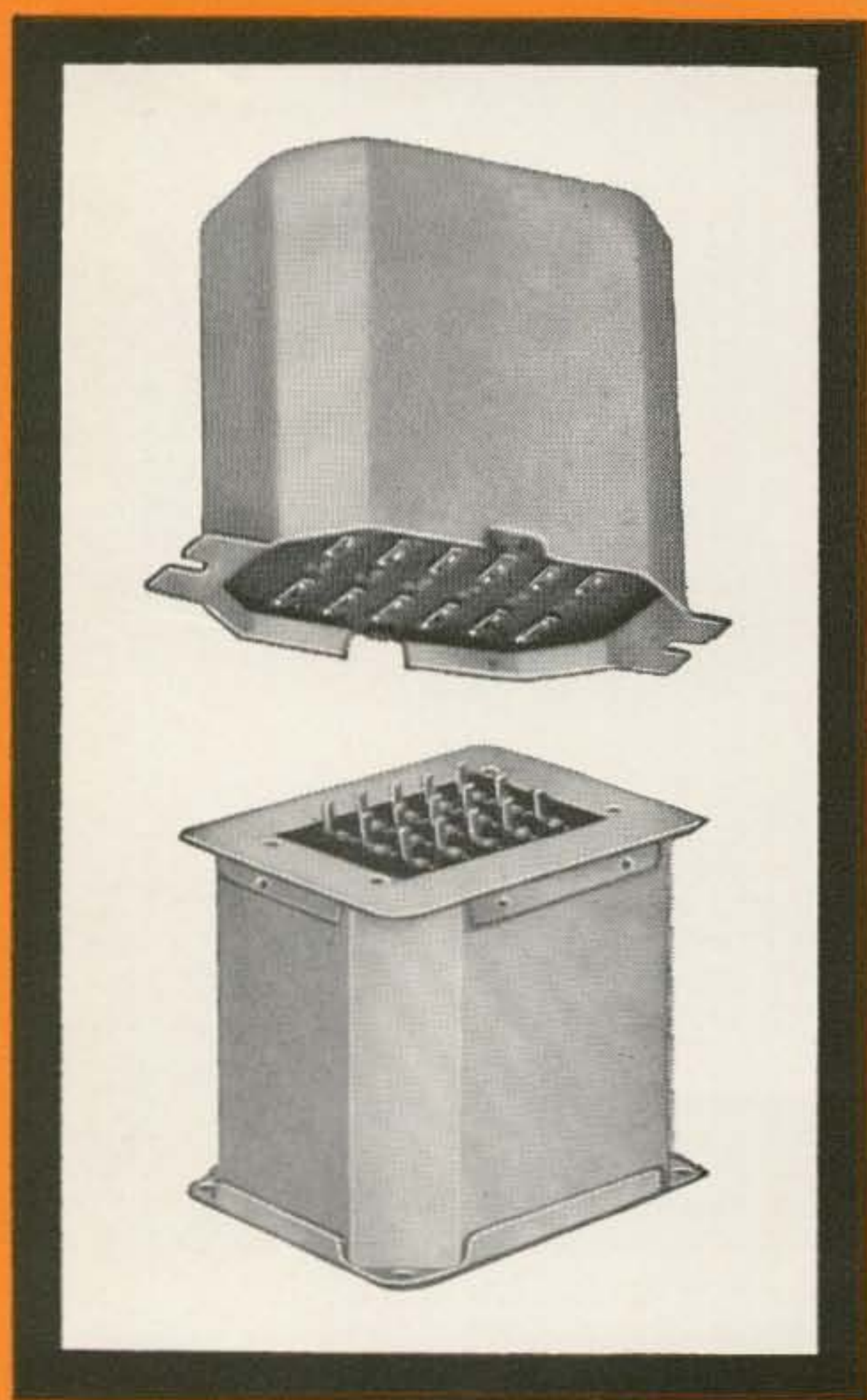

**Popular Priced
Matched Components
for
Power Supplies
Modulation
Pre-Amp &
Power Amplifiers
... for entire ham rigs**

Thirty years of attention to ham requirements have resulted in a complete line of reliable, high quality components geared especially to your needs. The "S" series of audio and power transformers and reactors, designed specifically for ham and PA service, are completely matched for compatibility in constructing a rig. These are popular priced units which afford the ham the full benefits of UTC's established excellence for quality components coupled with high reliability.

Write for catalog of over
1,000 STOCK ITEMS



UNITED TRANSFORMER CORP.

150 VARICK STREET, NEW YORK 13, N. Y.

PACIFIC MFG. DIVISION: 3630 EASTHAM DRIVE, CULVER CITY, CALIF
EXPORT DIVISION: 13 EAST 40th STREET, NEW YORK 16, N. Y. CABLES: "ARLAB"

73

Magazine

Wayne Green W2NSD/1
Editor, etcetera

September, 1963

Vol. XIV, No. 9

Cover:
Tri-Ex Tower

Cast Iron Balun	W4WKM	8
Using ferrite core inductors. 73 parts kit available.		
CW Noise Limiter	W6SFM	10
Or have you noticed that your noise limiter turns off on CW?		
Errorless RTTY Converter	K5JKX	12
Well, almost errorless.		
Bourbon S-Meter	W6TKA	18
As contrasted with the more popular Scotch S-Meters. Parts kit on this.		
Cartoon	Rodgers	20
Har de har.		
Towers	K1APA	22
Compendium.		
VHF Receiver	WØRQF	26
Module type construction, tuner for VHF converters.		
Heliwhip Tuning	W2IAZ	34
It is kind of foolish not to have your mobile whip tuned.		
Propagation	Nelson	38
What time to where, maybe.		
UHF Cavity Design	K5JKX	40
Maybe you aren't on 6M or up, but you can learn something anyway.		
Dual Antenna System for Mobile	W2IAZ	48
For multiband operation. The XYL will have a fit.		
73 Tests and HX-20	K6KGS	52
Mobile sideband for us paupers. Works fine.		
Variable Inducer	WB2CQM	56
Remote controlled antenna tuning.		
AM Quiz	W5EHC	60
Maybe you need to sit down and read some of our technical articles.		
Rotten CW	W1GQJ	62
Right.		
Monitor Scope	W5JSN	66
If you haven't bought one, you'd better build one. This'ns easy.		
Q-5'er Reborn	W4WKM	70
Should never have died.		
Code Master	K6OKX	76
Take one phonograph, add ingenuity.		
Save that Mil	K1JWU	75
Efficiency pointers for mobile work.		

Cartoon	31
Polar Relay Hash	51
Hi-Par Hilltopper	58
Bandswitching	57
Diode Interference	79
Silent Key	86
S Line	86

73 Magazine is published monthly by 73, Inc., Peterborough, N. H. The phone number is 603-924-3873. Subscription rates are still abysmally low at \$3.50 for one year, \$6.50 for two years, and \$9.00 for three years in North America and U.S. possessions. Foreign subscriptions are \$4.00 per year. Second class postage is paid at Peterborough, New Hampshire and at additional mailing offices. Printed in the U.S.A. Entire contents copyright 1963 by 73, Inc. Postmaster: please send form 3579 to 73 Magazine, Peterborough, New Hampshire. If you like to read this fine print so much we'll use more of it. Mention it when you subscribe.



The way things are popping these days we need a weekly newsletter to keep up instead of a monthly magazine. The biggest bombshell was the publication of part of the "Doyle Diaries" by Evans K6BX in his Newsletter. I'm pretty sure that you won't read one word about this in QST or me-too CQ, which leaves only 73 to spill the beans.

Those of you who are morbidly addicted to my editorials know that I take an awfully dim view of the way K6BX goes about things. He is usually sickently pompous and emotional in his rantings and often destructive. Well, he hasn't changed. His latest Newsletter emotes and pompouses on for 28 pages; it is a lulu. I enjoyed it.

The important part of the Newsletter, almost hidden amongst the onrush of hysteria, was a word quote of a letter purportedly written by ex-League Director John Doyle W9GPI. I had heard rumors of such letters and how they exposed a plot on the part of a few Directors to take over the ARRL and run it with an iron fist. I had heard that these letters were involved with the sudden resignation of Doyle a few months back. The letter published by K6BX describes in fairly good detail the whole plot . . . the way these men went about reworking the ARRL management system so they could control it . . . their incredible plans for the future . . . and he pulls no punches, naming names and giving intimate secrets about Huntoon . . . Hoover . . . control of QST . . . Budlong being fired . . . how they brow-beat wishy-washy Directors into letting all this happen . . . and on and on.

If the material is a hoax then we should see a healthy legal suit developing. If it is factual, and the details of the letter are hard not to believe since the plans laid out jibe so closely with the events that have happened, then the question arises, "what can be done about the situation and how can it be prevented from happening again?" Since this throws a dark cloud over the election of the present Directors one solution might be to turn their chairs over to the Vice-Directors. These gentlemen could then set about eliminating the new

de W2NSD

never say die

Executive Committee system of running things which virtually invites someone to step in and become dictator, with concomitant building funds, cancellations of national conventions, and proposed rules changes being forced down the members' throats.

I suspect that K6BX's News Letter #14 (30¢) may have to go into additional printings.

Incentive Licensing

My mailbag runneth over. A few in favor of restricted voice bands have written in . . . "get all those damned lids off the phone bands" . . . and a couple of thousand opposing it have registered their protest. I've been accused of bias . . . and I admit it. To get the opposite bias you'll just have to read QST.

I do join the proponents of incentive licensing in one thing: decrying the large number of amateurs who, once they have obtained their license, are content to buy a station and settle back to just plain operating. Few of these chaps read 73 for we have little of interest for them, so there isn't much point in my talking about it here.

But must we turn to government edict to force these lazy amateurs to mend their ways? Must we inconvenience or discourage tens of thousands of amateurs who do take an interest in their hobby? Perhaps there is another way. I know this is heretical in these days of leaping socialism, but my tendency is to try to get along with a minimum of laws and a maximum of understanding and cooperation.

What other incentives are there besides frequency allocations? I'm sure we can come up with something else. Power differentials have been suggested. This, like frequency segregations, would be difficult to police, requiring the FCC monitoring stations to increase their staffs or else forget the whole thing. There are so many multi-kilowatt stations on the air today undetected that it just isn't feasible.

Special call signs have been suggested. I'm inclined to like this idea. Since the old order of call signs has been virtually wrecked we might be able to set up a call sign system which

LAFAYETTE RADIO ELECTRONICS

FREE!

1964 Catalog
No. 640

422 Giant-
Size Pages

LAFAYETTE—"WORLD'S AMATEUR &
ELECTRONICS SHOPPING CENTER"



GIVES YOU '64
MORE IN

MORE HAM GEAR . . . for receivers, transmitter, as well as the smallest accessory, more amateurs everywhere make Lafayette their headquarters for all their gear.

MORE CITIZENS BAND •
MORE TEST EQUIPMENT •
MORE TOOLS •
MORE TUBES •
MORE STEREO HI-FI •
MORE TAPE RECORDERS •
MORE P. A. EQUIPMENT •

MORE SERVICE . . . more and more orders fully processed in 24 hours.

MORE BUYING POWER . . . choose from LAFAYETTE'S three Easy-Pay Credit Plans. NO MONEY DOWN — up to 24 months to pay — as little as \$5 monthly.

Mail the Coupon
for your FREE
1964 Lafayette Catalog

LAFAYETTE DELUXE 6-METER TRANSCEIVER HE-45-B

- High Efficiency—Up to 100% Modulation
- Superheterodyne Receiver Section for 50-54 MC
- 3-Stage, 14-Watt Transmitter
- Built-in 117V AC and 12VDC Power Supplies
- Complete with Push-to-Talk Ceramic Mike, Crystal for 50.12 MC, Detachable Mounting Bracket, All Power Cables



119⁹⁵
No Money Down HE-45B
\$6 Monthly Made in U.S.A.



Imported

LAFAYETTE AMATEUR COMMUNICATIONS RECEIVER

KT-320 HE-30
Semi-Kit Wired
64⁹⁵ 79⁹⁵
No Money Down
\$5 Monthly

- Tunes 550 KCS to 30 MCS in 4 Bands
- Built-in Q Multiplier
- 8 Tubes plus Rectifier Tube
- 1 RF + 2 IF Stages for High Gain Reception



KT-390 No Money Down
Made in U.S.A. \$5 Monthly

LAFAYETTE STARFLITE 90-WATT PHONE AND CW TRANSMITTER KIT

- 90 Watts Phone or CW in 80 Thru 10 Meters
- Built-in 3-Section Low-Pass Filter
- Clear, Chirpless, Grid Block Keying
- Easy to Build and Operate

LAFAYETTE Radio ELECTRONICS

CUT OUT AND PASTE ON POSTCARD

Mail Order & L.I. Sales Center
111 Jericho Turnpike, Syosset, L.I., N.Y.

OTHER LOCATIONS

New York, N. Y.
100 6th Ave.
Jamaica, N. Y.
165-08 Liberty Ave.
Scarsdale, N. Y.
691 Central (Park) Ave.
Bronx, N. Y.
542 E. Fordham Rd.

Newark, N. J.
24 Central Ave.
Paramus, N. J.
182 Route 17
Plainfield, N. J.
139 W. 2 St.
Boston, Mass.
110 Federal St.
Natick, Mass.
1400 Worcester St.



LAFAYETTE Radio ELECTRONICS
Dept. 731-3 P.O. Box 10
Syosset, L.I., N.Y. 11791

Send me the FREE 1964 Lafayette Catalog
No. 640.

Name _____

Address _____

City _____ Zone _____ State _____

WHEN YOU ARE
TOWER MINDED,
DON'T SETTLE FOR
LESS THAN
E-Z WAY
QUALITY

AT

\$99.50

MODEL HD-40
(DIP PAINTED)

AM. NET

- **Diagonal Bracing**
combats twist and torsion
- **Cranks-Up or Down**
for easy access to beam and rotor
- **Electric Arc Welded**
no bolts or rivets to shear
- **55,000 PSI Steel**
more strength per pound
- **Dip Painted**
complete heavy coverage inside and outside

The "Challenger" is 40 ft. of quality tower, designed for the budget minded ham. Exclusive E-Z Way design gives you top features that are often copied but never approach proven E-Z Way quality. Supports a Quad or any small beam having a wind area of 4.0 sq. ft. or less at 40 ft. in 60 MPH winds. NO GUYS! When larger beam is used tower should be guyed at top.

Model HD-40 Painted ..	\$ 99.50
Model BAHD-40 Painted	106.25
(Building Attach)	
Model GPKHD-40 Painted	149.50
(Ground Post Tilt)	
Model HD-40 Galv.	134.50
Model BAHD-40 Galv. ..	141.25
(Building Attach)	
Model GPKHD-40 Galv.	184.50
(Ground Post Tilt)	

Freight prepaid anywhere 48 USA

E-Z WAY TOWERS, Inc.

P.O. BOX 5767

TAMPA 5, FLORIDA

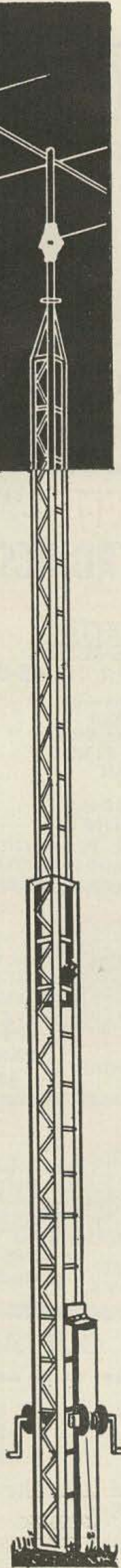

would reflect license qualifications. Suppose we establish six grades of licenses: Novice, Technician, General, Advanced (same technical exam as Extra, but without 20 wpm code), Extra, and Special (particularly awful exam). The class of license could be designated by the second letter of the call and the status of this special letter would I'll bet, drive a lot of fellows toward higher classes of license. "Double-you Bee Two See Cue Em, this is Double-you (heh, heh) Ess Two En Ess Dee." Well, you know that CQM isn't going to stand that one for long. The extra letter in the call would be a mark of accomplishment and would be much sought after. The lazy amateur would be branded as such every time he goes on the air.

ARRL

If my mail reflects the anti-segregation feelings of the amateurs so strongly, I can just imagine the tenor of the mail flooding in down at Newington. In spite of this mail, the August issue of QST is virtually silent on the subject. One letter in favor, none against, and not one word in the editorial. We don't find out what is really going on until we check into the mice-type in the "Happenings" where we find that the ARRL has submitted two petitions to the FCC, both requesting the assignment of portions of the bands for higher grades of licenses.

There are indications that the pressure of resigning members and irate manufacturers and distributors is being felt. We shall see in the September QST how much they have backed down. It is possible that they may ask that small segment of the phone bands (50 kc) be set aside for higher classes of licenses. This is a good compromise for it is doubtful if the FCC would set themselves up with such a monitoring headache, which would let the whole mess blow over.

The Institute

The shocking exposure of the ARRL by K6BX and the cynical admittance by the League in the July QST editorial that they had no intention of polling the members before making even the most drastic of decisions for them has brought in such a pile of mail demanding that something be done that I have taken a little time off from my mad race to keep everything running here and tried to work out a possible solution to the problem.

The first step in solving a problem is to identify the problem. Perhaps I am oversimplifying things, but it seems to me that

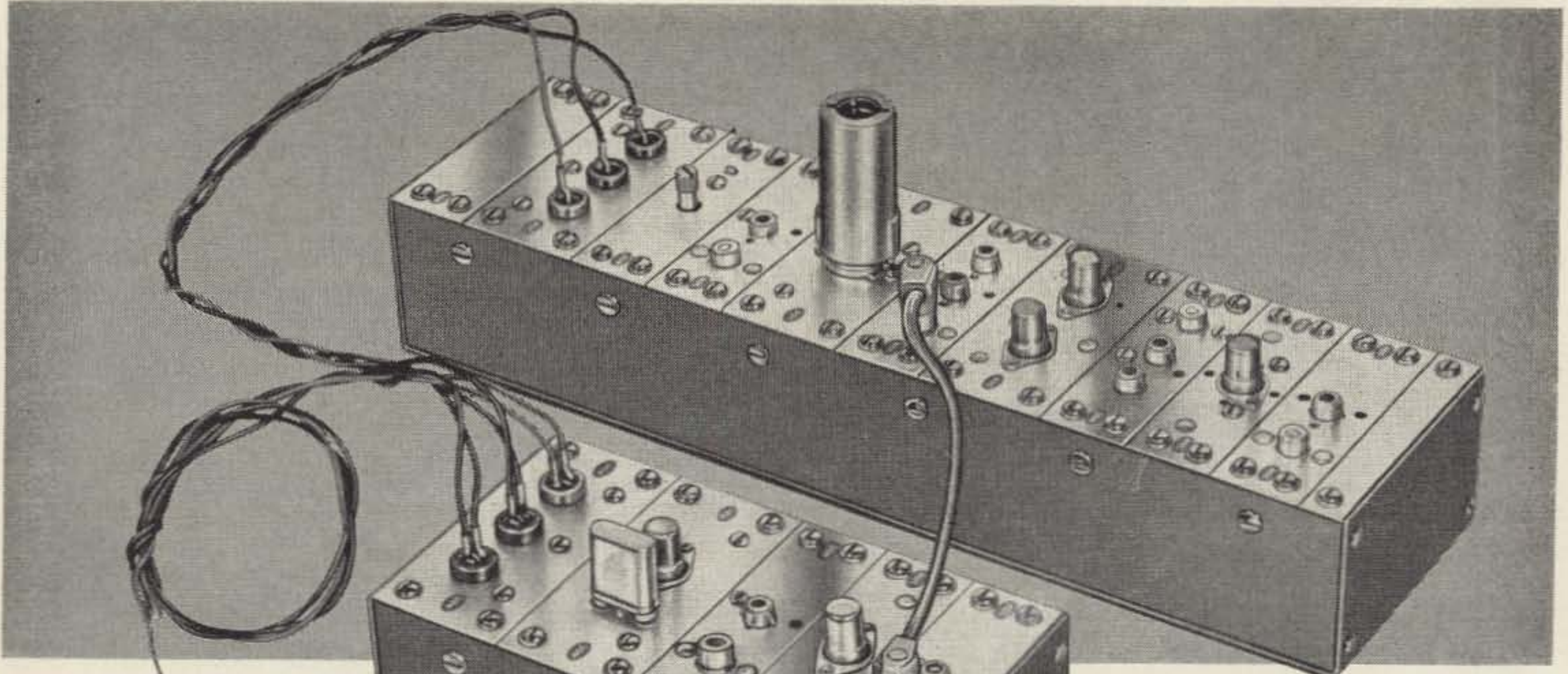

**Build
This...**

AOC 2-METER CONVERTER

A COMPLETE KIT USING INTERNATIONAL PREWIRED AOC UNITS

- 2 RF STAGES
- 3 DB NOISE FIGURE

Everything that you need for building a 2-meter converter with International Add-On-Circuits. Simple step-by-step instructions show you how to assemble the factory prewired units. Now . . . packaged in kit form for easy construction!

The converter kit includes input circuit, nuvistor grounded grid preamplifier, nuvistor/cascode preamplifier, innerstage coupling coil, mixer, IF output coil, oscillator tuning coil, oscillator, power connectors, hookup wire, special molded cables, hardware, and cases. **Specify IF desired when ordering.**

In addition . . . the AOC units in your converter are designed so that each circuit may be removed for modification or change. At a later date . . . the same circuits may be used to construct other electronic equipment. You never discard an Add-On-Circuit because of obsolescence.

**AOC
DESIGN SHEET**

Customer Name: _____ Date: _____
 _____ Year: _____ of _____

The following is our suggested AOC board for building:

1	2	3	4	5	6	7	8	9	10
11	12	13	14	15	16	17	18	19	20

Case
 Plate Power Resistor
 Vibe
 Control
 Resistor Power Resistor
 Vibe
 Control
 Total Cost of Material This Sheet

Bill of Materials				Bill of Materials				Bill of Materials			
Quantity	Part No.	Part Name	Notes	Quantity	Part No.	Part Name	Notes	Quantity	Part No.	Part Name	Notes

18 NORTH LEE STREET INTERNATIONAL CRYSTAL MFG. CO., INC. OKLAHOMA CITY, OKLAHOMA

AOC units may be used to build receivers, transmitters, or other gear. For complete details of available AOC units write International today!

2-Meter Converter, Complete.....\$59.50

BUILD WITH INTERNATIONAL AOC AND YOUR EQUIPMENT WILL NEVER BE OBSOLETE



International Crystal Mfg. Co., Inc.
 18 North Lee
 Oklahoma City, Oklahoma
 Please rush details on AOC units.

Name _____

Address _____

City _____ Zone _____ State _____

6 FOR 6

ELEMENTS

METERS

Another outstanding 6 meter beam by Cush Craft. Elements are full size $\frac{3}{4}$ " .058 wall aluminum tubing. Boom is 20' x $1\frac{1}{2}$ " .058 wall aluminum tubing. Mast support is 6" x 6" formed aluminum plate with 2" ubolts. All parts are marked for quick, neat assembly, without special tools. Weighs only 17 lbs. Preassembled "Reddi Match" provides direct 52 ohm feed, and 1 to 1 SWR. FORWARD GAIN 11.2 db FRONT TO BACK RATIO 20 db. Buy CUSH CRAFT for more Solid Value and Performance.

FULL SIZE
WIDE SPACED

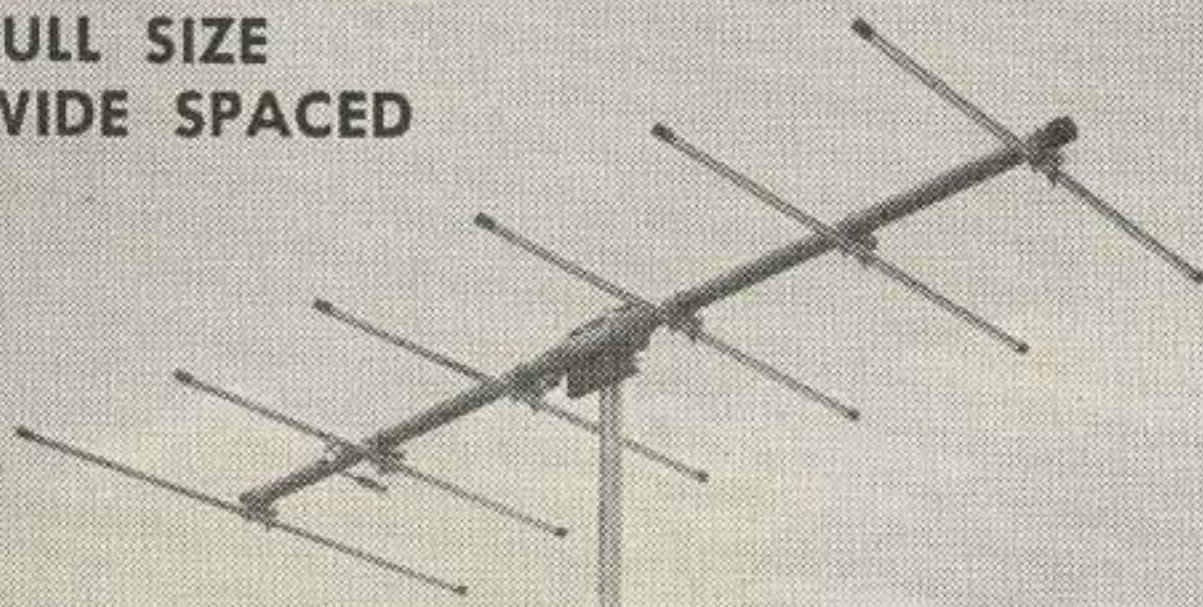

MODEL NO. A50-6

\$32.50 net

THE BIG WHEEL

Horizontally polarized, omnidirectional gain antenna features low-Q, large capture area, ease of matching and improved band width. 2 and 4 stack models available.

Model ABW-420—1 bay, $\frac{3}{4}$ meter	\$8.95
Model ABW-220—1 bay, $1\frac{1}{4}$ meter	10.95
Model ABW-144—1 bay, 2 meter	12.95

VHF BEAMS

Rugged, lightweight, and real performers. Booms, 1" diameter aluminum tubing elements $\frac{3}{16}$ " diameter aluminum rod preassembled on booms. Transformer dipole or Reddi Match. Dual and Quad Arrays available.

Model A144-11—11 element, 2 meter, boom 12'	\$12.75
Model A144-7—7 element, 2 meter, boom 8'	8.85
Model A220-11—11 element, $1\frac{1}{4}$ meter, boom 8.5'	9.95
Model A430-11—11 element, $\frac{3}{4}$ meter, boom 5'	7.75

6 METER BEAMS

Full size, wide spaced, booms $1\frac{1}{4}$ " and $1\frac{1}{2}$ " diameter, elements $\frac{3}{4}$ " diameter aluminum tubing. Reddi Match for direct 52 ohm feed 1:1 SWR.

Model A50-3—5 element, 6 meter, boom 6'	\$13.95
Model A50-5—5 element, 6 meter, boom 12'	\$19.60
Model A50-6—6 element, 6 meter, boom 20'	32.50
Model A50-10—10 element, 6 meter, boom 24'	49.50
Model A50-3P—Portable 3 element, 50" x 4" folded	10.95

VHF MOBILE HALOS

Aluminum construction; machined hardware; Reddi Match for 52 or 72 ohm direct feed. 2 meter. Dual halo two bands one 52 ohm feed line.

Model AM-2M—2 meter, with mast.	\$8.70
Model AM-22—2 meter, stacked Complete	14.95
Model AM-6M—6 meter, with mast.	12.50
Model AM-26—6 and 2 dual halo, with mast	17.45

VHF COLINEAR ARRAYS

Lightweight mechanically balanced VHF antenna systems. Extremely high power gain, major front lobe, low SWR, and broad band coverage; low angle of radiation and large capture area. 32 and 64 element arrays available.

Model CL-116—2 meter, 16 element colinear.	\$16.00
Model CL-216— $1\frac{1}{4}$ meter, 16 element colinear.	12.85
Model CL-416— $\frac{3}{4}$ meter, 16 element colinear.	9.85
Model CL-MS—Universal matching stub matches 300 ohm 16 element antennas to 200, 52, or 72 ohm feed lines.	4.75

See your distributor or write for Free Catalog

Cush Craft

621 HAYWARD ST.

MANCHESTER N. H.

our difficulty is one of communication . . . which is a strange one for a hobby such as ours. But see if I'm not right in this. I suspect that we need a good method of communications for all amateurs to know what is going on and to participate in the formation of new rules or modifications of old ones. If we could find some way to provide a bias-free method of letting amateurs know what each other are thinking I believe that our hobby would run a lot smoother.

Now . . . how do we accomplish such a thing? Well, I have a suggestion.

I propose that we set up an Area Coordinator for each call area who will report on the matters discussed and resolved by clubs within his area. Each Area Coordinator will have Division Directors for each section of his area and these men will attend local club meetings and report on the decisions reached by clubs within their sections. An Area Coordinator might have from five to fifteen Division Directors to keep him up to date on all of his area. The DD will be in touch with the clubs on a direct basis and in touch with club officers so that his reports will reflect the thinking of the amateurs in his section. The Area Coordinator will make a report including the information from the DD's and this report will be published each month by the Institute of Amateur Radio and copies will be distributed to AC's, DD's, all officials of the FCC, ARRL Directors and officers, all government offices in any way involved with amateur radio (MARS, etc.), and by suscription to any amateurs interested in knowing just what is what for the nominal subscription rate of \$1 per year, which doesn't cover the costs involved by a long shot, but which will weed out those upon whom it might be wasted.

This whole thing will take a bit of doing, but I think we can get it set up before the end of the year.

This will provide a means for all amateurs who are interested enough in their hobby to attend club meetings or write to their Division Director with their opinions to know what is going on and to wield some influence in the course of amateur affairs. Our little bulletin should be invaluable to the FCC in their honest attempt to manage our hobby in our best interests and should be equally helpful to ARRL Directors, perhaps preventing them from going off on a tangent undesired by the amateurs because of the personal influence of one or two Directors. Since the ARRL is not providing any such service I hope they won't

(Turn to page 88)



UNBEATABLE!

That's the opinion of VHF'ers
EVERYWHERE!

Clegg THOR 6 60 watt phone or CW transceiver for 6 meters. Built-in VFO, push-to-talk & keying relay. Receiver features nuvistorized front end crystal lattice filter. BFO for SSB and CW reception . . . price \$349.95.



. . . and the best way to verify these opinions is right at your own receiver.

Listen across six or two. Pick out the best signals and you will find a piece of Clegg equipment behind them every time! Listen to the ham who's hearing and working the choice DX . . . the guy who's digging them out of the QRM and noise . . . he's probably using Clegg gear too!

A little more eavesdropping will provide the clincher. The enthusiastic, on the air endorsements by Clegg users (and those who wish they were) should convince the most skeptical. They all add up to the one word . . . "UNBEATABLE". So . . . times a'wasting . . . see your dealer today. He's got a Clegg rig to match any pocket-book or any requirement.

MOBILE OPERATION



Now you can run a mobile "power house" using the new Clegg Model 418 transistorized 12V DC power supply/modulator unit to power your THOR 6 transceiver.

Visit your distributor today and see the famous Clegg family that is making VHF history.



ZEUS 6 & 2 meter transmitter 185 watts AM & CW . . . \$695.00 amateur net



INTERCEPTOR 6 & 2 meter receiver . . . \$473.00 amateur net



VENUS 6 SSB transceiver 185 watts PEP coming soon.



99'er six meter 8 watt transceiver . . . \$159.95 amateur net

See your Distributor or write for information.

Clegg
LABORATORIES
DIV. OF SQUIRES-SANDERS, INC.

RT. 53, MT. TABOR, N. J.
TELEPHONE 627-6800

A Cast-Iron Balun

73 Parts Kit

Roy Pafenberg W4WKM
316 Stratford Avenue
Fairfax, Virginia

Photo Credit: Morgan S. Gassman, Jr

Ferrite components and ferrite core inductors have come into general use in recent years. Despite their appearance in a very wide range of common equipments, many amateurs remain unaware of the amateur equipment applications of these materials and commonly available components. Commercial applications range from the "rod" antennas used in transistor portables to the universally used ferrite core TV horizontal deflection components. One component, which has immediate amateur application, is the broad band matching transformer, or balun, which is widely used in modern TV tuners.

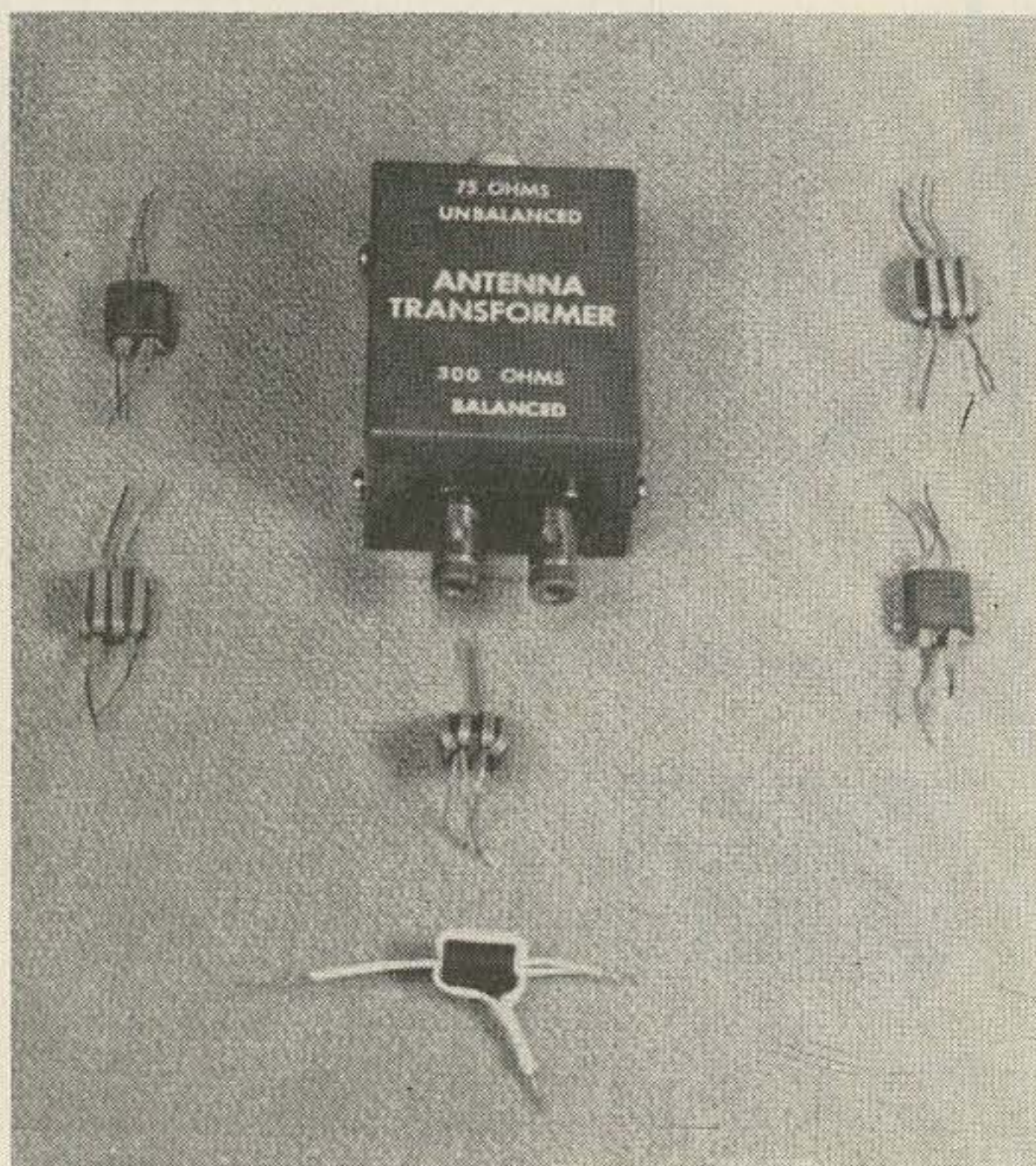

The balun is housed in a Minibox and commercial decals finish off the job. Various views of the unmounted balun are also shown.

Before we go into the applications of the ferrite core unit, a review of the baluns in current amateur use is in order. Baluns (BALanced to UNbalanced rf transformers) are widely used to effect transition from balanced to unbalanced transmission lines with an impedance transformation of 4 to 1. In amateur VHF practice, the most common form of balun is of the coaxial cable type.¹

In this configuration, a half-wave phasing section of coaxial cable is connected in parallel with the coaxial transmission line. The balanced connection is made across the center conductor terminations of the phasing section which provides the required 180° phase reversal. Since the voltages at the unbalanced end of the circuit are in parallel and the voltages at the balanced end are in series, there is a 4 to 1 impedance step-up from the unbalanced line to the balanced output. While performance of these coaxial line baluns is excellent, there are obstacles. The major problems are the length of line required for the phasing section at the lower frequencies and the limited bandwidth over which a particular balun will operate.

The limited bandwidth problem is overcome in the untuned coil balun. In this configuration, two bifilar wound coils are connected as shown in Fig. 1. At the series connected end, the lines are balanced to ground and will match an impedance of twice the characteristic impedance of the line. At the parallel connected, or unbalanced, end the circuit will be matched by an impedance of half that of the coiled lines. This results in an impedance transformation of 4 to 1. For this circuit to work, the input must be effectively decoupled from the

1. "Coaxial Baluns," WA2INM; December 1962, 73 Magazine

output and this must be accomplished without introducing excessive losses.

In theory, this condition will occur only when the coiled transmission lines are an odd multiple of a quarter wave in length. However, in practice, the coiled lines serve as a choke which effectively decouples the input from the output. Since the inductance of the choke is not critical, these baluns will function over a wide range of frequencies. Bandwidths of 10 to 1 are normal with the lower frequency limit being that at which the windings are less than a quarter wave in length.

The familiar "ladder" coils used in the antenna input circuit of early television receivers were a commercial application of this type balun. Many amateurs have used these coils in their VHF installations with good results. It should be noted that in this discussion only the most common series-parallel balun configuration is treated. This connection results in the 4 to 1 impedance transformation and a transition from balanced to unbalanced lines. Other connections are possible but are beyond the scope of this article. It is in this 75 to 300 ohm, unbalanced to balanced configuration that the TV baluns have been most often used.

With the availability of economical, modern ferrite core materials, their use in TV receiver baluns was a logical development. Since the efficiency of the ferrite core baluns for receiving applications in the range of 54 to 216 mc has been proven in several million TV receivers, it was considered worthwhile to try these units at the lower frequencies. In addition, it was desired to test them in low power transmitting applications. John Landek W9WOK, of Admiral was approached for details on these units and he kindly came through with the information and some samples of the coils used in Admiral TV receivers.

These baluns were used unchanged in the tests that were conducted. The windings of the baluns were connected as is shown in Fig. 1 and the balanced termination connected to a 200 ohm resistive load. The unbalanced termination was connected through a commercial SWR meter to the output of a 3.5 to 60 mc low power transmitter. RG-58/U cable was used between the transmitter, the SWR meter and the balun. The 4 to 1 ratio of SWR meter and the balun. The 4 to 1 ratio of the balun is maintained in this test and use of the 50 ohm line enabled use of the 50 ohm SWR meter and a commercial 50 ohm rf power meter for comparative tests. Subsequent on the air tests verified that similar results are obtained in 75 ohm unbalanced to 300 ohm balanced applications.

The transmitter was modulated about 90% with a 1000 cycle test tone and the balanced deflection plates of a monitor scope were connected across the 200 ohm load. The purpose of the scope was to observe the modulated rf envelope for flat-topping or other evidence of balun core saturation on modulation peaks. Rf voltage across each half of the 200 ohm load resistor was measured with a Hewlett-Packard 410B VTVM and the actual power in the load computed from these readings. These readings were verified by substituting a commercial rf power meter for the balun and 200 ohm load. The commercial SWR meter was left in the line and switched to the relative power position to insure that the transmitter output remained essentially unchanged under both test conditions. The fingers and the nose were used to gauge heating of the balun core and windings.

The transmitter was tuned up on 6 meters into the 50 ohm power meter and the loading adjusted for 15 watts output. After the SWR was verified as being essentially 1 to 1, the output was transferred to the balun terminated in the 200 ohm load. Transmitter tuning was touched up for exactly 15 watts output and the SWR was read and recorded. This procedure was repeated on 10, 20 and 40 meters. The balun did not heat excessively at any frequency and no distortion of the modulated rf envelope was noted. Results of these tests were as follows:

Frequency in mc	54	28	14	7
SWR	1.1:1	1.2:1	1.4:1	1.6:1

The transmitter was retuned to 54 mc and the power increased until excessive heating of the balun was observed. The SWR rose slightly at this power level but the rf envelope remained undistorted on modulation peaks. This test was repeated with other baluns of the same type and in each case, excessive heating was noted at between 20 and 25 watts.

Based on these tests, it appears that the unmodified TV baluns will be perfectly satisfactory for use on 6 and 10 meters, could be used on 20 meters and *might* be used on 40 meters. Just to play it safe, a maximum power of 20 watts should not be exceeded. Although the TV baluns were not tested on 2 meters, there is no reason why they should not be fully satisfactory

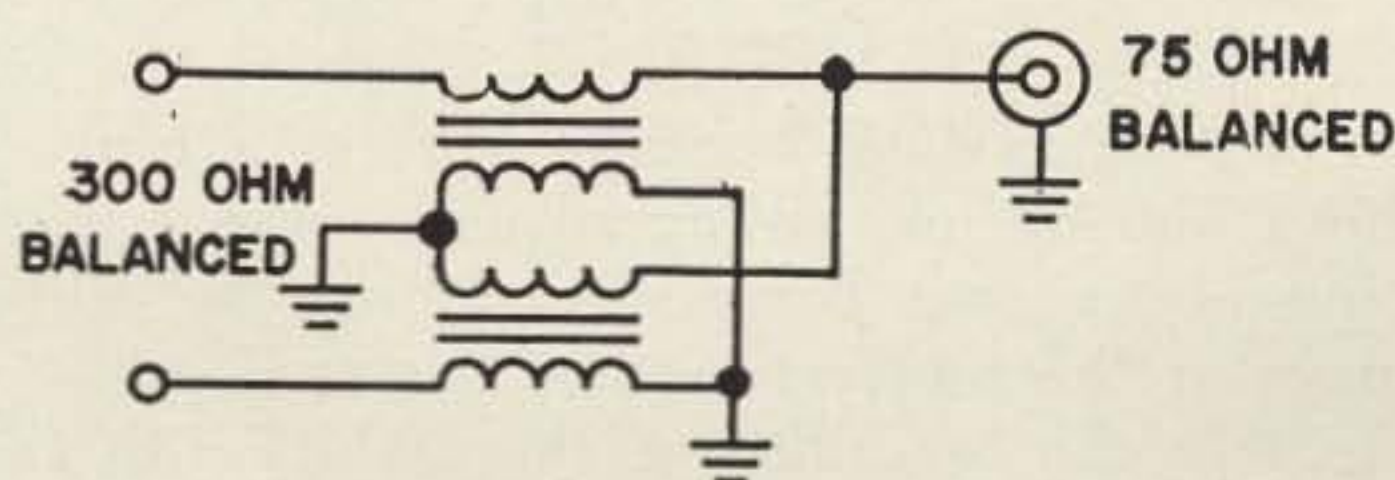

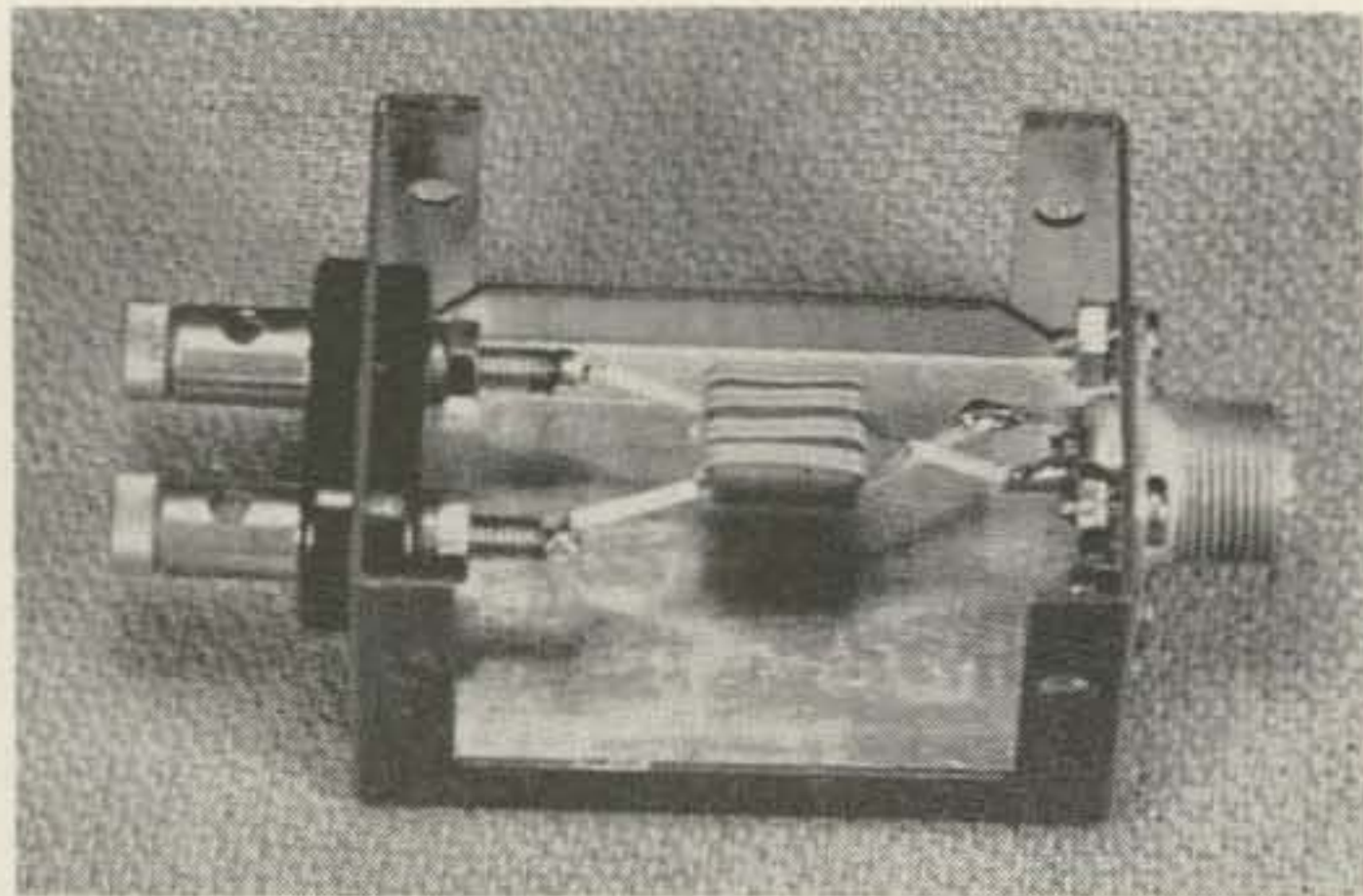

The ferrite core balun is connected to the coaxial receptacle and the binding post terminals. The balun is supported by its leads.

at these frequencies. As mentioned, the baluns were used unchanged. Somewhat better low frequency performance might be obtained by increasing the number of turns in the windings. However, it is believed that General Ceramics Q-2 ferrite material is used in the cores. General Ceramics recommends this material for use in wide band transformers between 10 and 225 mc so it is doubtful that performance at the lower frequencies could be greatly improved.

Since these baluns are used in most TV sets today, supply should be no problem. Various makes of sets were checked and part numbers obtained. Checks with the local distributors of the various brand sets disclosed that most stock the balun coils. However, since Standard Coil

tuners are very widely used and since regular parts distributors stock replacement parts, Standard Coil part numbers are listed. The coil is stocked as an assembly and a few other parts which are not used in this application come mounted on the board. However, the price is still reasonable. Antenna Transformer, Standard Coil Part Number 31T-413, is the replacement part for the various Model "T" tuners and it sells for \$1.90 net. The Antenna Input Assembly for the "FN" and "FD" series of tuners, Standard Coil Part Number 31T3398-01 or -02, sells for \$1.15 net.

The photographs show a very convenient method of mounting the ferrite core TV balun. The case is a Bud 2 3/4" x 2 1/8" x 1 5/8" Minibox. An SO-239 coaxial connector is mounted on one end of the box with a ground lug secured under one of the mounting nuts. A dual, insulated binding post assembly is mounted on the other end of the box. The balun is wired between the terminals, supported by its leads. Although valuable in the shack, this unit is equally valuable in the shop for various balanced to unbalanced matching jobs.

... W4WKM

Parts Kit Available	
Complete kit, including coil, box, SO-239 coax connector and screw terminals.	
W4WKM-1 Kit (order from 73, Peterboro, N. H.)	\$3.00

Noise Limiter for CW

73 Parts Kit

Joe Williams W6SFM

The CW noise limiter shown in the diagram is useful with that type of receiver whose ANL works great on phone but which is next to useless when the set is operated in the CW mode. When connected as indicated, this accessory becomes a form of frequency selective short clamp. In most cases it won't be necessary to remove the receiver from its cabinet in order to make the hook up.

Operation

Since many CW operators prefer a tone of about 500 cycles, all signal and noise energy lying above that frequency within the audio image of the receiver can be trimmed without affecting the legibility of the code. With the

diode noise limiter connected and with the receiver gain controls set at normal, the clipping

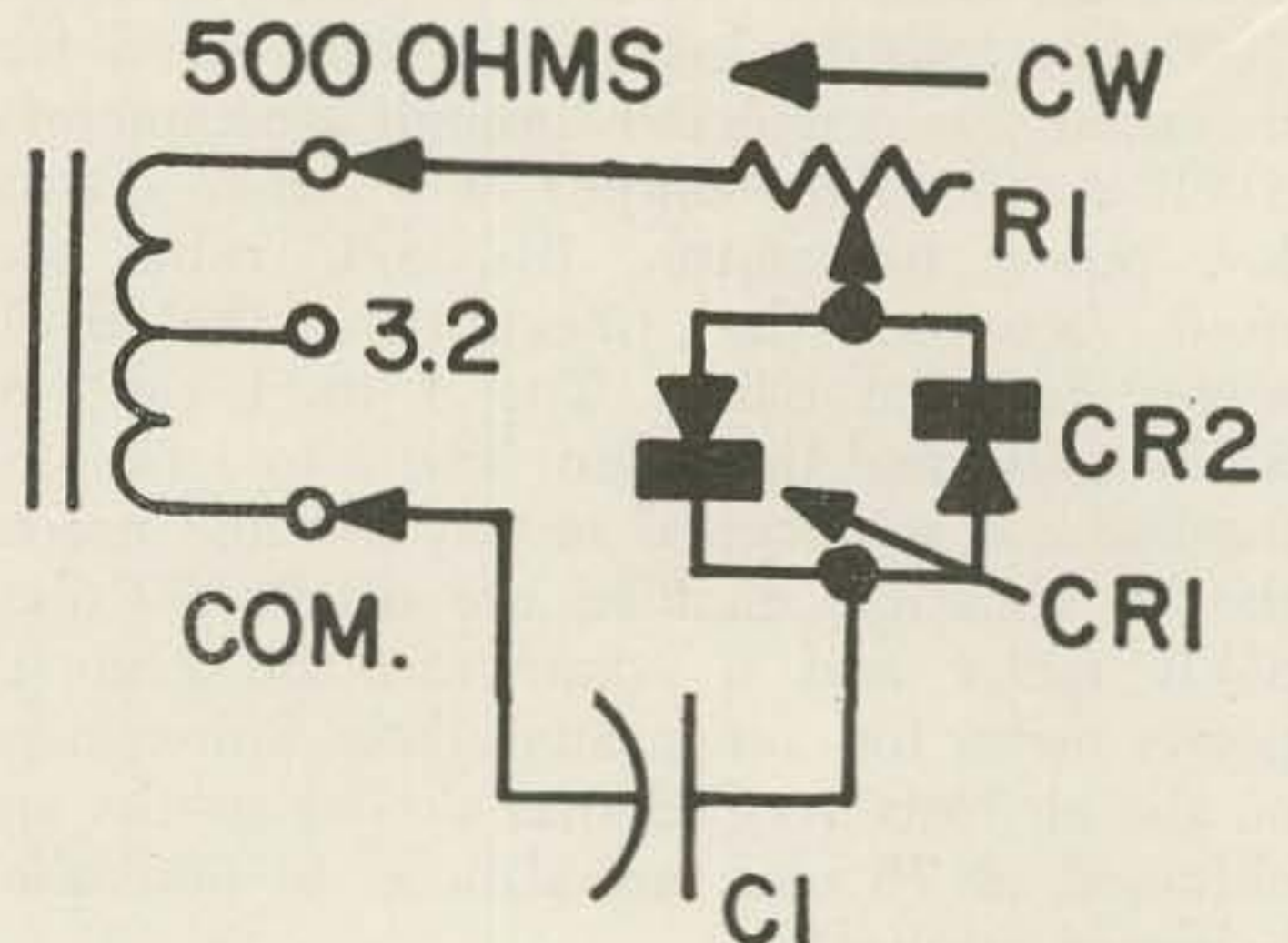

New from Gonset

A HIGH QUALITY TRANSISTORIZED SSB TRANSCEIVER



that is

ULTRA-COMPACT • LIGHT WEIGHT • low in cost

Gonset has scored a breakthrough with the new "Sidewinder"—a 2 meter SSB, AM and CW transceiver that combines technical excellence with contemporary design and compact, sturdy construction.

The Gonset "Sidewinder" provides coverage of the entire 2 meter band in four segments 1 Mc wide. It has built-in VFO and the receiver is *completely* transistorized. There are a total of 21 transistors, 6 diodes and three tubes in the "Sidewinder," which operates on either SSB, AM or CW.

The power supply is designed for snap-on back or remote installation and is available either as a kit or a wired and tested unit.

CHECK THESE DELUXE FEATURES AT YOUR LOCAL DISTRIBUTOR!

- Receiver and transmitter utilize dual conversion.
- Designed for mobile and fixed station operation.
- Illuminated dial and "S" meter.
- High voltage power supply is used only in transmit mode.
- Highly Stabilized VFO.
- Crystal lattice filter for both receiver and transmitter.
- 20 watts PEP input SSB, 6 watts input AM, 20 watts input CW.

Transceiver: 8¾" wide, 4¾" high, 7" deep.
Weight: 7 lbs.-10 oz. Amateur net price \$349.95

Power supply: 8¾" wide, 4¾" high, 5½" deep.
Weight: 11 lbs.-2 oz. Amateur net price—kit \$39.95
Wired and tested unit \$49.95

The new Gonset "Sidewinder" SSB Transceiver will be on display at your local distributor's in August.

GONSET® INC.
A SUBSIDIARY OF ALTEC LANCING
801 SOUTH MAIN STREET, BURBANK, CALIFORNIA

control, R1, is advanced. When noise pulses of sufficient amplitude appear across the secondary of the output transformer, either or both of the diodes will conduct and a partial short circuit will be applied to the secondary through R1 and C1. C1 will, of course, exhibit less ac resistance at the higher audio frequencies and the threshold of avalanche of the diodes will occur earlier at those frequencies. This action takes the sting out of ignition noise, QRN and power line transients. When a noise spike causes the clamp to make, the entire audio product of the receiver is shunted for a few microseconds. The code tones being received will be perforated but unharmed. In severe noise, if the value of R1 is further reduced, the incoming CW signals will trigger the noise limited and the CW will chop holes in the noise with an action like that of a cookie cutter. This sounds a bit strange but often makes otherwise unreadable signals stand out so that they can be copied.

The Connections

Where the receiver has the familiar screw type connectors on the rear apron which are marked 500 ohms, 3.2 ohms and Common—the noise limiter is connected to the 500 ohm post and to Common. If your receiver has only a voice coil connection or has a self contained speaker, the limiter can be connected between the plate of the audio output tube and Ground. If this type of hook up is used, R1 should be 10K ohms and C1 should be a .47 mfd at 400 volts.

... W6SFM

Parts Kit Available

We've gathered the two diodes, pot and condenser into a package for you. Catalog price is \$3.59 on the parts. W6SFM-2 Kit (order from 73, Peterboro, N. H.)\$3.00

Errorless RTTY Converter

Jim Kyle K5JKX
1236 N. E. 44th Street
Oklahoma City 11, Okla.

Many RTTY converters, both with transistors and with vacuum tubes, have been described in the past few years. However, only one—the W2JAV unit—has taken full advantage of the 100-percent redundancy inherent in the RTTY code.

That term "redundancy," in case it threw you, is one bandied about by specialists in the field of information theory, and means simply that (in this case) you get two specific items of information at any given instant to tell you what the fellow on the other end sent.

It is inherent in any form of FSK, because if at any one instant a *mark* is being transmitted a *space* cannot be. If you receive both a *mark* and a *space* simultaneously, then something is wrong.

Thus, if our converters were designed so that we had signals available to indicate what was *not* being sent as well as what was, we could reduce errors by requiring both a *mark* and "not-space" to indicate a *mark*, and vice versa.

This, of course, is done in the W2JAV unit—but the converter described here, designed by use of symbolic logic and digital techniques

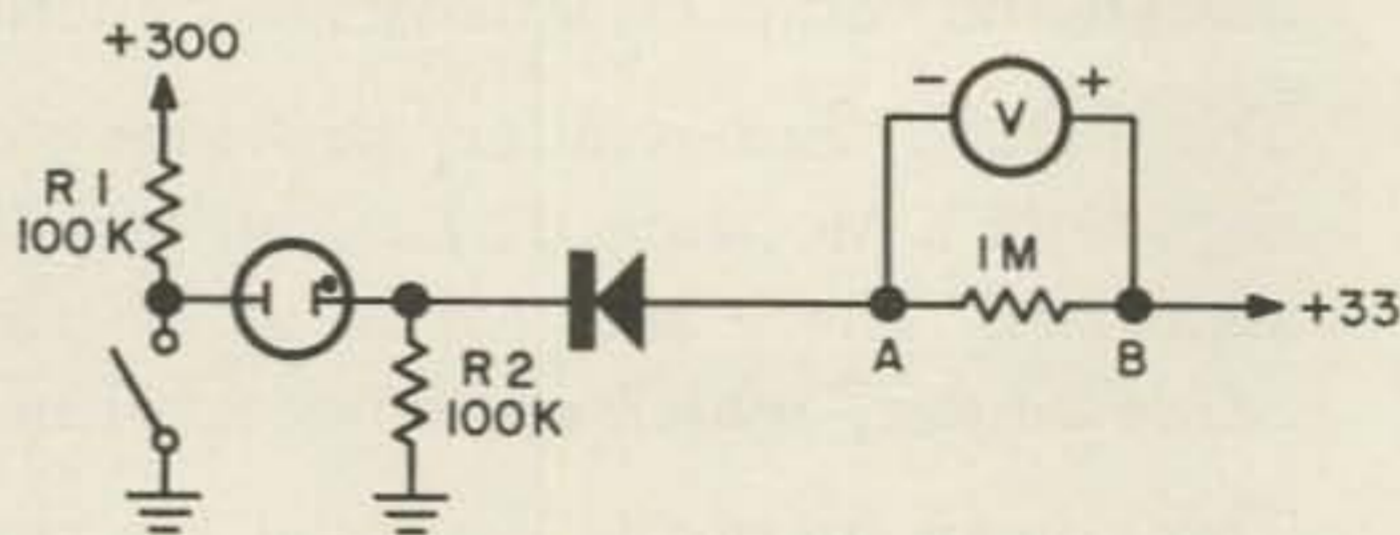

FIGURE 1

Fig. 1. Simplified schematic showing operation of "and" gates, with neon switches. Spst switch at left represents output stage of Schmitt trigger. With switch closed, neon goes out. Diode is forward biased and 33-volt supply flows to ground through 1-meg resistor, diode, and R2 in series. Meter reads approximately 30 volts across 1-meg resistor. With switch open, neon lights and approximately 100 volts appears across R2. Diode is reverse-biased and no current flows from 33-volt supply through 1-meg resistor. Meter reads zero volts. If left half of circuit (all components to left of point A) is duplicated and connected in parallel at point A, **both** switches must be open before current flow through 1-meg resistor is halted.

learned during a two-year bout with the computer industry, offers a few additional advantages.

Among these advantages are the fact that the printer is never allowed to run open, no tuning meter or scope is used yet immediate visual indication of proper tuning is given, and modern filter techniques together with efficient noise-pulse elimination permit copy under the most severe QRM conditions.

The never-run-open feature is brought about by holding the printer magnet energized at all times *unless* a specifically identified *space* signal is being received. When tuned off channel, tuning through a signal, or receiving only noise, the printer merely sits there.

Tuning indication is by means of a bank of four neon bulbs, which serve a double purpose. Originally included in the design to act as switches in the classic manner, they were brought out to the front panel when it was

realized that they offered a valuable aid to tuning and troubleshooting in case of QRM.

Since a seven-position front-panel switch offers the option of "bilateral" (a term invented here to describe the *mark-plus-not-space* requirement) copy, *mark-only* copy, or *space-only* copy in both normal and inverted positions, as well as a seventh "no copy" position to insure absolute quiet while tuning under difficult QRM conditions, versatility is about as great as could be hoped for. Though the switch makes things look complicated, it is actually simple to wire in due to the digital circuits employed.

The heart of this converter is the combination of the neon switches and the "and" gate. Fig. 1. is a simplified schematic showing how this works; only one neon and one diode are shown.

The spst switch at the left of the illustration represents the output section of the associated

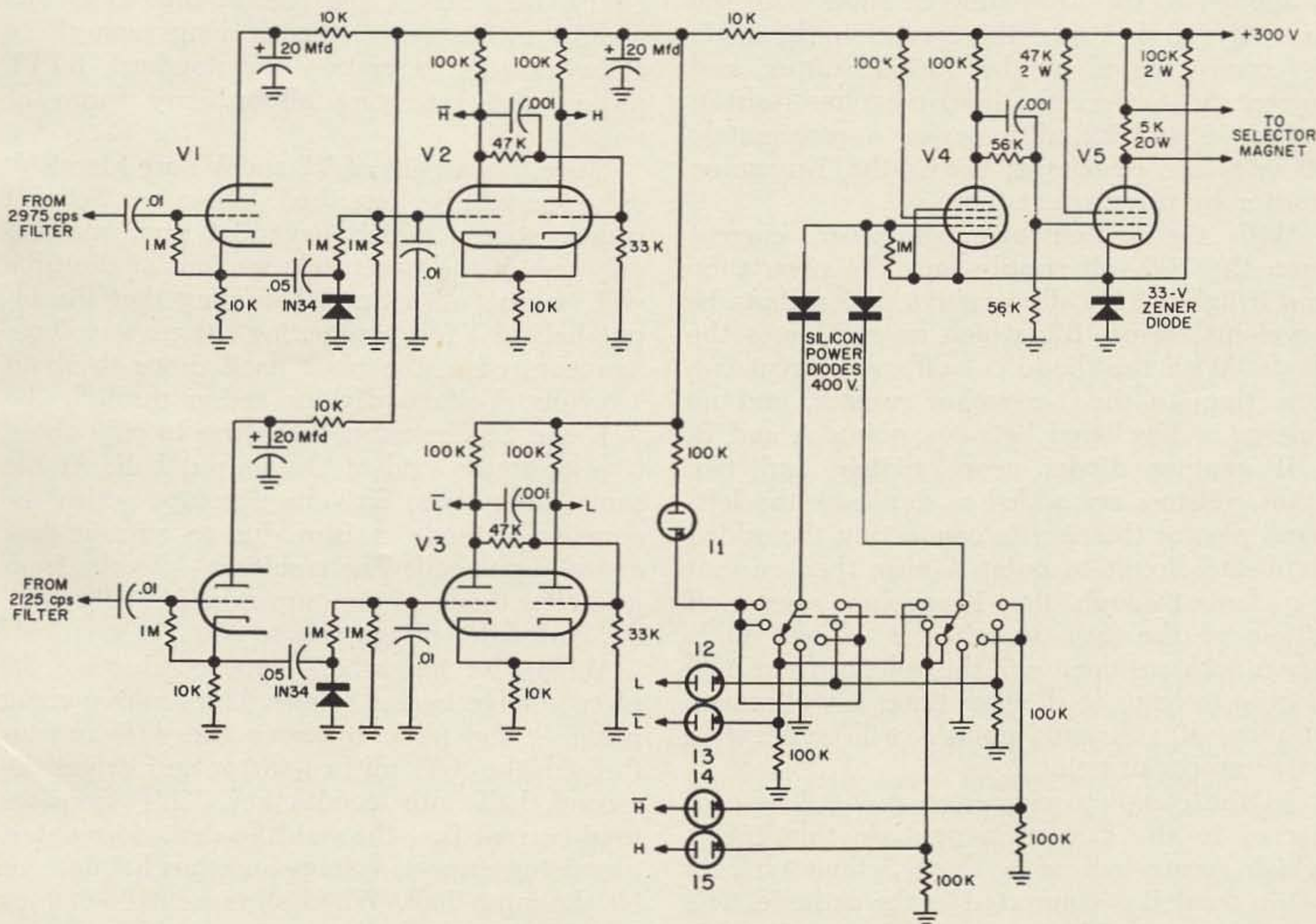

SCHEMATIC DIAGRAM OF DIGITAL RTTY CONVERTER
FIGURE 2

- | | |
|---|-------------|
| Switch Positions: | |
| 1—Mark only | } Mark low |
| 2—Space only | |
| 3—Bilateral | |
| 4—No copy | } Mark high |
| 5—Bilateral | |
| 6—Space only | |
| 7—Mark only | |
| V ₁ , V ₂ , V ₃ —12AX7 | |
| V ₄ —6AU6 | |
| V ₅ —6EM5 | |
| I ₁ , I ₅ —NE2 | |

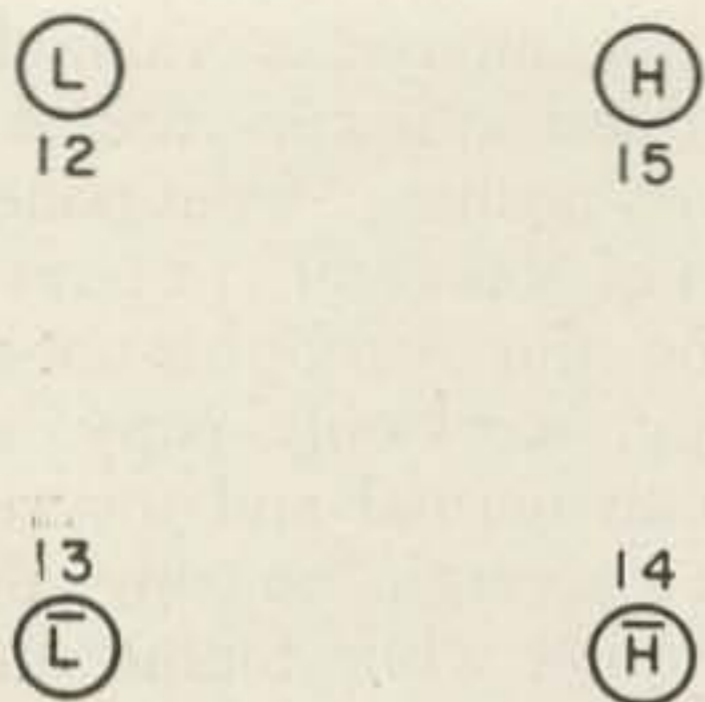

FIGURE 3

VISUAL TUNING INDICATOR PATTERN LAYOUT.
SEE TEXT FOR DETAILS.

Schmitt trigger tube and will be either open or closed. Actually, with the values given on the full schematic, about 15 volts will appear at the upper end of the "switch" when it is "closed" but for purposes of explanation it is close enough to a dead short.

With the switch closed, not enough voltage is applied to the neon tube to allow it to fire so it stays dark. Under this condition, the diode is forward biased by the 33-volt supply, and current flows through the 1-megohm resistor, the diode, and R2, all in series. Approximately 30 volts are developed across the 1-megohm resistor by this current flow.

With the switch open, however, current from the 300-volt supply fires the neon tube and it lights. This allows about 100 volts to be developed across R2, which reverse-biases the diode. With the diode cut off, no current can flow through the 1-megohm resistor, and no voltage is developed between points A and B.

If another diode, neon, switch, and two 100K resistors are added to duplicate the left-hand part of the circuit, connecting the added duplicate circuit to point A also, then current can flow through the 1-megohm resistor if either of the spst switches is closed. Only when *both* are open will the voltage from A to B drop to zero; at all other times it will remain at about 30 volts, and point A will be negative with respect to point B.

In the complete converter, point A is connected to the grid of a pentode tube (V4) which forms half of a third Schmitt trigger while point B is connected to the cathode. The tube chosen, a 6AU6, cuts off at considerably less than -30 volts, so that it remains cut off at all times except when both switches are closed.

But at this point, we're a bit ahead of our explanation of the way this gadget works. Let's back up a bit, like all the way back to the receiver.

The complete schematic of the converter, Fig. 2, does not show the input amplifier or the

filters. This is because they are not particularly critical. No limiter is necessary, but a band-pass filter from 2 to 3 kc is a definite asset. My own preference is for the 5-section filter described earlier in these pages, fed by a 6J6 operated grounded-grid for simplicity—but even a single-section toroid will surprise you when used with this converter following it, because of the extremely light loading presented by the detectors of Fig. 2.

The first stage shown in the schematic is a dual cathode follower, using half of a 12AX7 in each channel. This is used primarily as an impedance-matching device to prevent the diode detectors from loading the filter outputs.

The 1N34 diode detectors are fairly conventional except that they are connected to give positive-going output with signal. The two 1-megohm resistors and the .01 mfd capacitor between the diode and the following-stage grids form a time-delay filter which prevents noise pulses from triggering the following circuitry. Both attack and release time constants are 10 milliseconds; this is long enough to allow positive operation on standard RTTY pulses while rejecting all ordinary forms of noise.

Since the circuits of V2 and V3 are identical, only one will be described. These are Schmitt trigger stages, which have the property that only one of the two triode sections of the tube will conduct at a time. Assuming that the input half of V2 is conducting, its plate voltage as measured at the plate itself drops to about 15 volts. Voltage divider action through the 47K and 33K resistors drops this to only about 6 volts at the grid of the output half. At the same time, about 25 volts develop across the common cathode resistor due to current flow in the input half. The resulting -19 volts from grid to cathode of the output half cut this side off, and plate voltage rises to 300.

When the input half stops conducting, its plate voltage begins to rise. The positive-going pulse at the plate bypasses the 47K resistor through the .001 mfd capacitor and drives the second half into conduction. This increases total current flow through the cathode resistor, increasing cathode voltage and thus helping cut off the input half. When all current flow stops in the input half, the positive voltage developed through its plate resistor, the 47K, and the 33K resistor all in series help maintain conduction in the output half.

Thus you can see that the output half is conducting unless an external signal forces the input half to conduct, and when this happens the output half ceases to conduct. In consequence, we have a high voltage at the plate

FOR THE BEST SUPPLY MONEY CAN BUY...

YOU'LL DISCOVER THE POWER SUPPLY YOU'VE BEEN LOOKING FOR

from **LINEAR SYSTEMS INC.**



FOR MOBILING

THE POPULAR 350-12

- INPUT** — 12-14 V.DC
- OUTPUT** — 800 V @ 400 MA or
600 V @ 500 MA
and 275 V @ 200 MA
0-110 @ 30 MA Negative
Adjustable Bias

- FEATURES** — ONE CONVERTER ADAPTABLE TO ALL EQUIPMENT
- POWER CAPABILITY IS 350 WATTS — MOST POWERFUL CONVERTER IN ITS CLASS
 - PROVEN PERFORMANCE AND SATISFACTION GUARANTEED
 - QUALITY COMPONENTS & EXCELLENT WORKMANSHIP
 - RUGGED — CAN OUTLAST AND OUTPERFORM OTHER BRANDS UNDER ADVERSE CONDITIONS
- \$125**

350-6 — FOR 6 VOLT MOBILE OPERATION **\$165**

350-24 — FOR MARINE & AIRCRAFT SERVICE **\$165**

500-12 — AN INCREASINGLY POPULAR MOBILE SUPPLY FOR THOSE WANTING GREATER POWER

INPUT — 12-14 V.DC

OUTPUT — 1250 V.DC 400 MA **\$150**
300 V.DC 200 MA
90 V.DC Negative Adjustable Bias

1000-12 — A POWERHOUSE IN A SMALL PACKAGE — FOR KILOWATT MOBILE LINEARS

INPUT — 12-14 V.DC

OUTPUT — 2000 to 3000 V.DC **\$250**
300 V.DC 100 MA
0-110 V.DC Negative Adjustable Bias

INVERTERS | 12 V.DC to 120 V.AC

FOR PORTABLE OPERATION OF RADIO - TV - SMALL TRANSMITTERS & RECEIVERS - FANS - BLOWERS - SMALL TOOLS & APPLIANCES

INV-12150 150 W CONTINUOUS



4" x 4" x 6"
6½ lbs.

\$60

INV-12400 400 W PEAK 300 W CONTINUOUS



4½" x 7" x 9"
16 lbs.

\$120



CONSERVATIVE MECHANICAL & ELECTRICAL DESIGN IN ALL LINEAR SYSTEMS POWER SUPPLIES ASSURES RELIABLE OPERATION UNDER ALL CONDITIONS

FOR FIXED STATION

THE ADAPTABLE 350-AC

- INPUT** — 117 V.AC 50-60 CYCLE
- OUTPUT** — SAME AS 350-12
6.3 V.AC 6A
12.6 V.AC 6A
12.0 V.DC @ 200 MA

- FEATURES** — GENERAL PURPOSE SUPPLY CAPABLE OF DELIVERING WELL-REGULATED, RIPPLE-FREE DC POWER
- IDEAL FOR POWERING MOST OF THE PRESENT DAY COMMUNICATIONS EQUIPMENT
 - CABLES AVAILABLE FOR CONNECTION TO MOST EQUIPMENT
- \$99.50**

LINEAR AMPLIFIER | LSA-3

NEW • COMPACT • BROADBAND
20 - 40 - 80 METERS

- INPUT** — 25 WATTS
- OUTPUT** — 500 WATTS PEP
- FEATURES** — SMALL PACKAGE

4½" H x 6½" W x 10" D
5¼ lbs.

— FOR MOBILE OR FIXED STATION
With Companion
AC or DC POWER SUPPLIES



\$250

Order Through Your Dealer or
Write For Further Information

LINEAR SYSTEMS INC.

605 UNIVERSITY AVENUE
LOS GATOS, CALIFORNIA

of the input half and a low voltage at the output plate in the absence of driving signal, and the reverse when a signal is present. One of the two halves is conducting at all times.

This situation is noted on the schematic by marking the lead from the plate of the output half of V2 "H" for high-frequency-signal-present, and the plate of the input half "not-H" (denoted by a bar over the H on the drawing), for high-frequency-signal absent.

Similarly, the corresponding plates of V3 are marked "L" and "not-L".

The "H", "not-H", "L", and "not-L" signals obtained from V2 and V3 are fed to the neon-switch and "and" gate section whose basic operation was described previously. A brief bout with symbolic logic equations which won't be repeated here showed that it would be necessary to use the "H" and "not-L" signals together to identify a mark-low *space* signal, and the "L" and "not-H" signals similarly for mark-high copy. Under any other possible combination of input signals, we want the printer magnet to hold in the "mark" position.

However, to allow copying from the *mark* or *space* signals only, in case the other side of the signal is jammed by QRM, we must be able to defeat the bilateral feature. This is accomplished by I1 and its associated resistors, which furnish a "fictitious" "H" or "not-L" signal is required.

The seven-position switch selects the proper combination of input signals so that the "and" gate will allow V4 to conduct whenever a "space" signal is being received and at no other times. In the "no-copy" position V4 is permanently cut off.

Both V4 and V5 are part of a power Schmitt trigger which includes the printer magnet itself as its output load. When V4 is cut off, it holds V5 in conduction and the printer magnet is pulled in. When V4 conducts, its plate voltage drops so low that V5 is cut off, and the magnet drops out. The 5K resistor swamps inductive surges from the magnet, while the Zener diode holds cathode voltage fixed at 33 volts positive. A stiff voltage divider might do as well, but the plate current of V5 is something like ten times that of V4 so the Zener is a worthwhile investment.

Magnet current may be set, if desired, by adjusting the value of the screen resistor of V5. I operate my Model 15 at anywhere from 18 to 45 MA without troubles.

Power requirements for this converter are relatively modest, but it should have its own supply. A 100-MA supply will be more than ample. Regulation of the supply is not critical;

any small receiver-type transformer should do.

Now to get back to that visual tuning we mentioned once and never came back to. It revolves around the four neon-switch bulbs 12 through 15. If they are arranged in a pattern similar to that shown in Fig. 3, the light pattern itself will indicate proper tuning.

When no signal is coming through either channel, both "not" bulbs (13 and 14) will light and the pattern will be a horizontal bar across the bottom of the square.

In the rare event of QRM in both channels, both "true" bulbs (12 and 15) will light and the bar will move to the top of the square. This is a most improbable pattern to observe.

A steady carrier or tone in either channel will cause the upper bulb in the associated channel to light. For instance, steady carrier in the upper channel would cause 15 to light but would not affect 12 or 13.

Normal frequency of RTTY pulses is about 23 cps; the eye cannot detect pulses faster than about 18 cps. Thus, an incoming RTTY signal properly tuned will make *all* four bulbs appear to be lit simultaneously. The receiver can be tuned for this condition with the converter switch in "no copy," and a flick to either "mark high bilateral" or "mark low bilateral" should result in perfect copy.

Should you be hit by a QRM, a glance at the lights will tell you whether it is in the upper or lower channel; you can then operate the switch to continue copy from the remaining clear channel.

If you want to operate several pieces of equipment from this converter, it's easy to do so. Simply *parallel* all the magnets. Use a 5K resistor at each magnet, to absorb the inductive kicks. That's it—and happy *digital RTTY!*

... K5JKX

FOREIGN SUBSCRIPTIONS

The foreign subscription rate to 73 is \$4.00 U. S. per year, however we will accept cash or checks in foreign funds at the following rates:

Canada	\$3.75	Germany	16 DM
Mexico	\$44	Hong Kong	\$23
Austria	115 sh	Italy	2500 Lx
Australia	36/	Netherlands	14.50 F1
Belgium	200 BF	Norway	29 NKr
Denmark	27.60 DKr	Portugal	1150 Es
England	28/6	Spain	200 Ptas
Finland	14.2 FM	Sweden	20.80 SKr
France	20 NF	Switzerland	17.50 SFr

FRESH UP WITH 6-UP 73's new VHF magazine.

\$2.00 a year — send name, call, address.
First issue, August, almost gone.
Don't miss it.

6-UP — Peterborough — N. H.

NEW!

The NEW Waters Universal Hybrid Coupler (Model 3002) has all the features of the old Coupler plus a built-in compression amplifier added to the microphone circuit. Built-in battery. Amplification can be adjusted from 0-12 db by front panel control. Output limited by compression so peaks will not exceed set level.

\$69.95

Retrokit: modifying model 3001 to 3002: \$19.95



COMPRESSOR — PATCH

ALSO NEW!

Two models to fit all Collins equipment. Model 337-S1A is designed to exactly fit the 75S1: \$39.95. The Model 340-A (no holes to drill) fits the KWM-2,2A Collins: \$53.75. You'll bless the day you added this to your Collins.

For all Collins Rec. & Xcvrs.
For 75S-1: 337-S1A
For KWM-2(A): 340-A
No holes to drill.

\$39.95

\$53.75

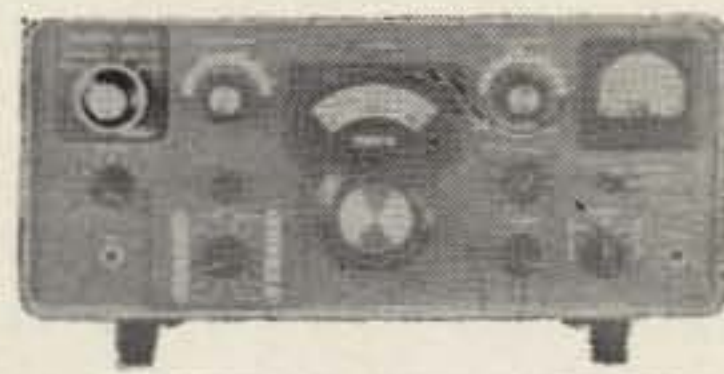
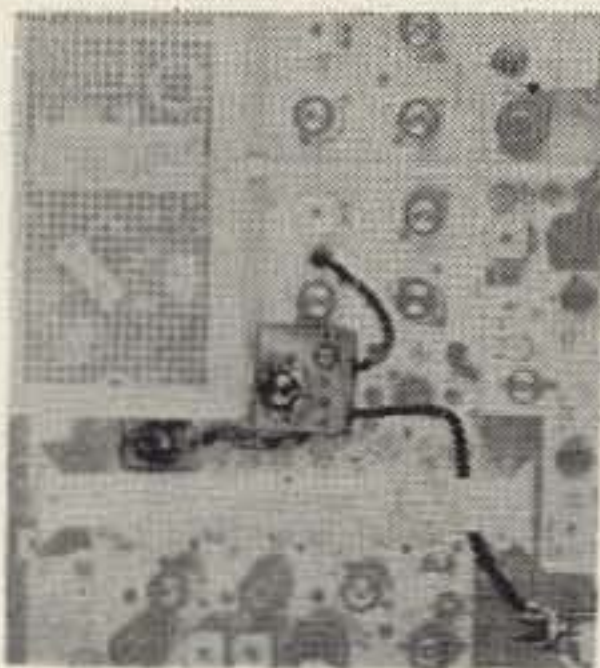

Q-MULTIPLIER NOTCH FILTER

OLD!

BUT NOT VERY



DUMMY
(?)

LOAD
WATT-
METER

Full KW
Warning light
Meter reads:
10-100-1000W
Won't leak
Model 334

\$79.75

SWITCHES

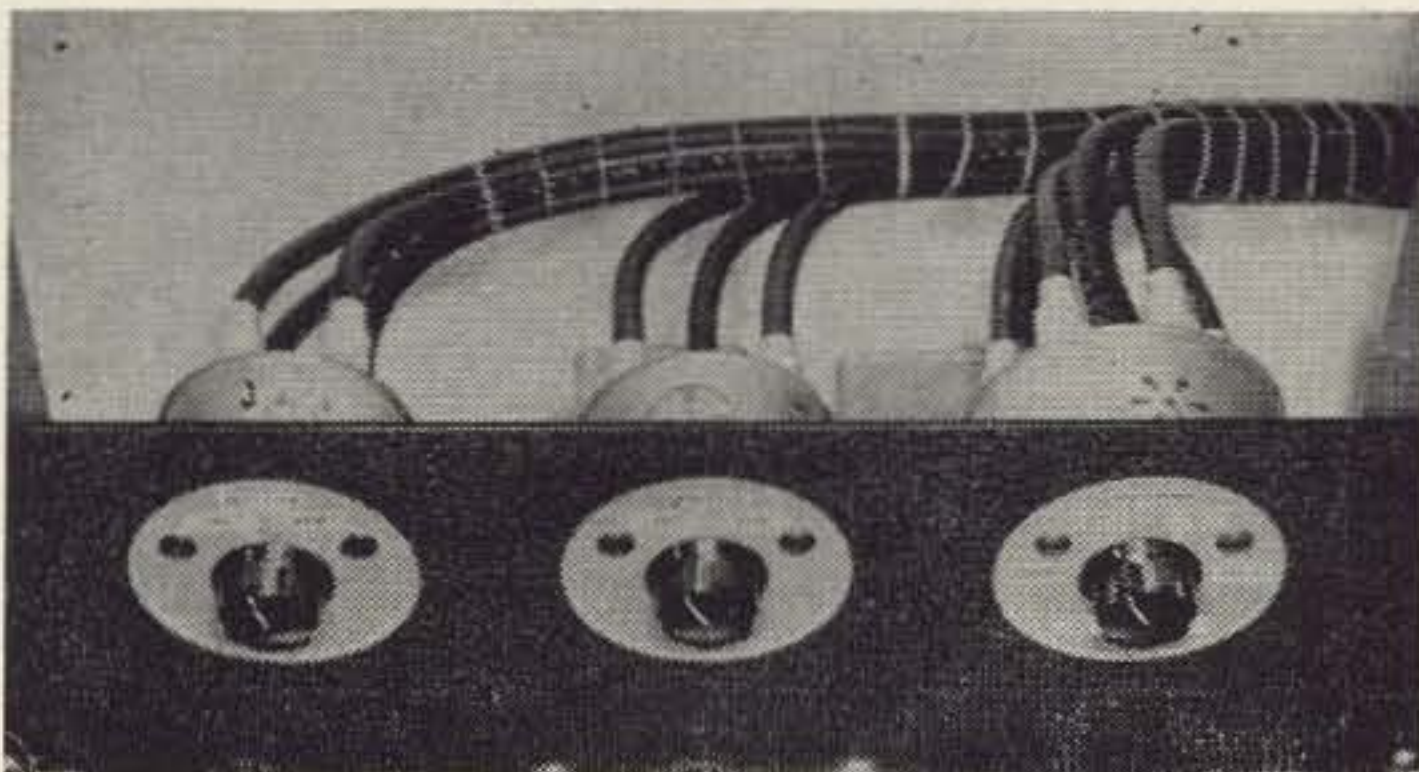

Three types: one pole-six throw for antenna switching, \$12.95; one pole-two throw in case you don't have so many antennas or want to use a dummy load, \$11.45; transfer switch for switching power amplifier in and out, \$11.45. All are canned for protection. All have SO-239 type connectors.

WATERS MFG. INC.

WAYLAND
MASS.

The Bourbon S-Meter

73 Parts Kit

Richard Van Wickle W6TKA
643 Aurora Avenue
Santa Barbara, Calif.

This article bears its rather strange title because the author is tired of hearing reports from other amateurs who say they are using Scotch S meters.

Seriously, the point of this article is to tell those who have receivers with no S meters how to install S meters. The process is easier than you think. We should also mention that the material presented herein is not new; this article is simply a refresher course in S-metermanship.

S meters perform a number of valuable functions, such as observing changes in signal strength as a beam is rotated, aligning the receiver, and as a basis for lying to another station regarding his signal strength. There are many receivers in use today, either surplus or home built, which do not have S meters. Installation of an S meter in most of these receivers (providing they have an avc and the avc is working) is relatively simple.

The basic S meter bridge circuit is shown in Fig. 1. You can build the gadget in a 5" x 2 1/4" x 2 1/4" minibox. There will be four leads going to the receiver from the S meter: ground, filament voltage, plate voltage, and avc. A Jones Type AB male connector can be mounted on the box and a Type AB female connector on the receiver, with a cable between using cor-

responding connectors. Or, if you want to—and have the room—you can build the unit right into the receiver.

The meter is a 0-1 milliammeter, either a Shurrite Model 850, or similar inexpensive meter. Several of the amateur radio supply houses stock reasonably priced meters manufactured in Japan which are quite adequate for this purpose.

The thing that scares a lot of hams away from attaching an S meter to their receiver is that they don't know how to identify the avc line. Avc means, of course, automatic volume control. Perhaps a more accurate term would be "automatic gain control," but either way this is how it works: the average rectified dc voltage, developed by the received signal across a resistance in the detector circuit, is used to vary the bias on the rf and if amplifier tubes. This voltage is proportional to the average amplitude of the signal so the gain is reduced as the signal strength becomes greater. Thus, the avc tends to keep the receiver output level relatively constant, regardless of input signal. The more stages controlled by the avc, the better the control, and the more constant the gain will remain.

Fig. 2 shows a typical avc circuit. By referring to the schematic for your own receiver (if you don't have one, do your best to get one—they're mighty handy) you should be able to easily locate the avc line. If you have no schematic, you can find the avc line by remembering that the identifying characteristics of the line are that the grid resistors from the controlled stages (usually one or more if and rf stages) are all connected to a common line which connects, through a resistor, to a diode—most often one of the diodes in a dual-diode-triode tube.

Now, getting back to our S meter circuit, this is the way it works: the voltage developed by the avc circuit is very nearly a logarithmic function of the incoming signal, so if the S meter tube plate current is proportional to the

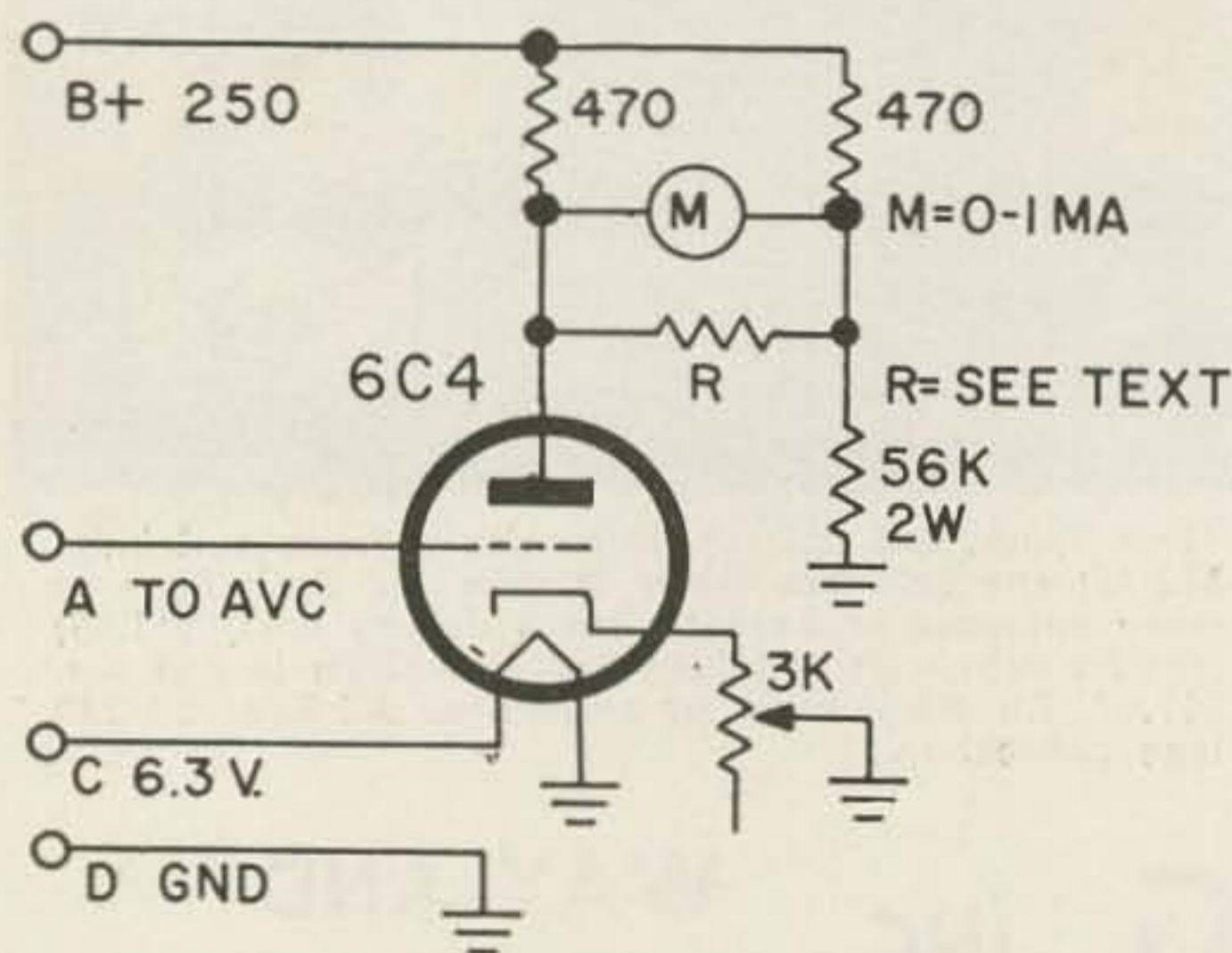

FIG 1 BRIDGE S-METER CIRCUIT

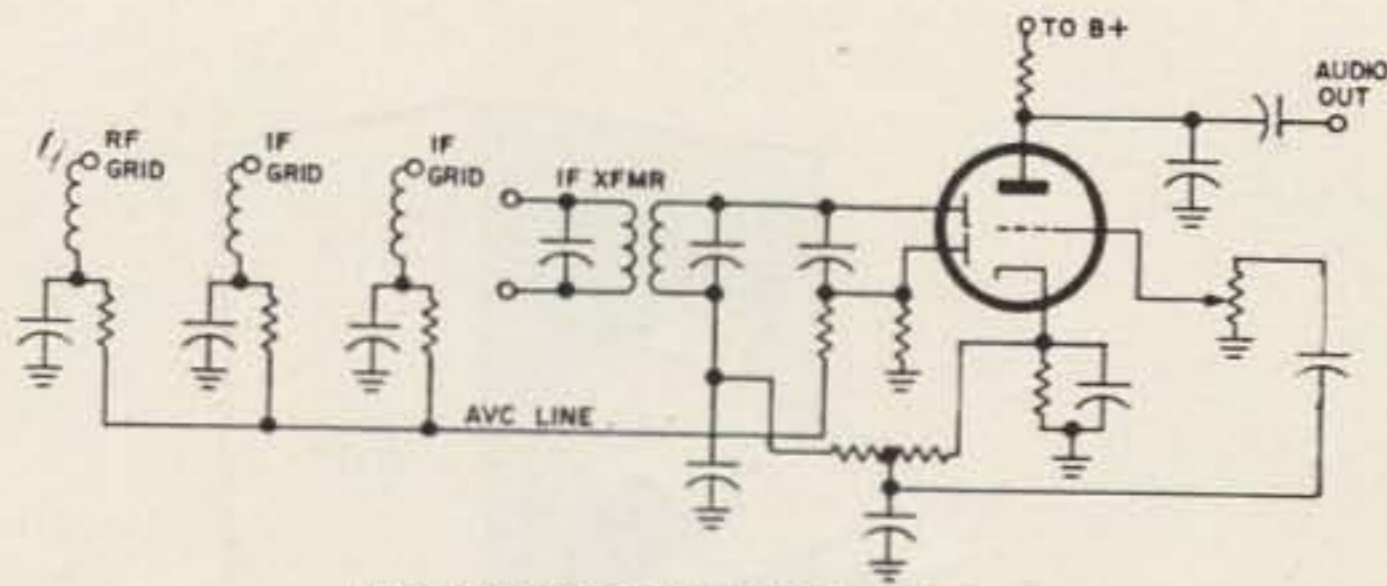

FIG 2 AUTOMATIC VOLUME CONTROL CIRCUIT

grid voltage, the meter will read according to a linear decibel scale. This means that readings won't all be bunched up at one end of the meter scale. This meter, when adjusted as we will describe, will handle a signal range of around 80 db.

Having located the avc line, provided for the necessary four connections, and constructed the S meter, we can now attach, in the receiver, connection A to the avc line, B to B+ (approximately 250 volts), C to the 6.3-volt filament circuit, and D to chassis ground. Don't put the 6C4 in its socket just yet. Turn on the receiver and adjust the resistor across the meter until the meter reads full scale. The value of the resistor, which will probably be in the neighborhood of a few ohms will depend upon the internal resistance of the meter unit.

Then, having arrived at the proper shunt resistance, put the 6C4 in the socket, allow it to warm up, and, with a short length of wire or a clip-lead, short the avc line to ground so that the 6C4 grid will be grounded. Adjust the 3000 ohm potentiometer until the meter reads zero. Now disconnect the avc from ground. The meter will now follow signal variations up to the point at which the voltage is high enough to cut off the 6C4 plate current.

Now to calibrate the meter. Assuming that a full-scale reading on the meter is an 80 db, signal, and that, since S meter units are usually considered to each be equal to six db, S9 will equal 54 db, with each tenth of a milliamp division equalling eight db. S9, then occurs at 0.675 ma, 0.7 is two db over S9, 0.9 is 18 db over S9. (By George, this is a stingy S meter!)

If you would like to give higher signal reports and thus make more friends (the degree of friendship increases as the square of the signal report given by the receiving station), at the sacrifice of accuracy, just multiply the figures given above by any factor you desire!

... W6TKA

Parts Kit Available

The parts for this doohinky are packaged by 73, Peterboro, N. H. Ask for W6TKA-2 Kit \$6.50

Communications, mobile radio...

A First Class FCC License

...or Your Money Back!



Your key to future success in electronics is a First-Class FCC License. It will permit you to operate and maintain transmitting equipment used in aviation, broadcasting, marine, microwave, mobile communications, or Citizens-Band. Cleveland Institute home study is the ideal way to get your FCC License. Here's why:

Our training programs will *quickly* prepare you for a First-Class Commercial Radio Telephone License with a Radar Endorsement. Should you fail to pass the FCC examination after completing your course, you will get a *full refund* of all tuition payments. You get an FCC License . . . or your money back!

You owe it to yourself, your family, your future to get the complete details on our "proven effective" Cleveland Institute home study. Just send the coupon below TODAY. There's no obligation.

MAIL COUPON TODAY FOR FREE CATALOG

Cleveland Institute of Electronics

1776 E. 17th St., Dept. ST-5
Cleveland 14, Ohio

Please send FREE Career Information prepared to help me get ahead in Electronics, without further obligation.

CHECK AREA OF MOST INTEREST -

- | | |
|---|--|
| <input type="checkbox"/> Electronics Technology | <input type="checkbox"/> First-Class FCC License |
| <input type="checkbox"/> Industrial Electronics | <input type="checkbox"/> Electronic Communications |
| <input type="checkbox"/> Broadcast Engineering | <input type="checkbox"/> _____ other _____ |

Your present occupation _____

Name _____ Age _____
(please print)

Address _____

City _____ Zone _____ State _____

Accredited Member National Home Study Council

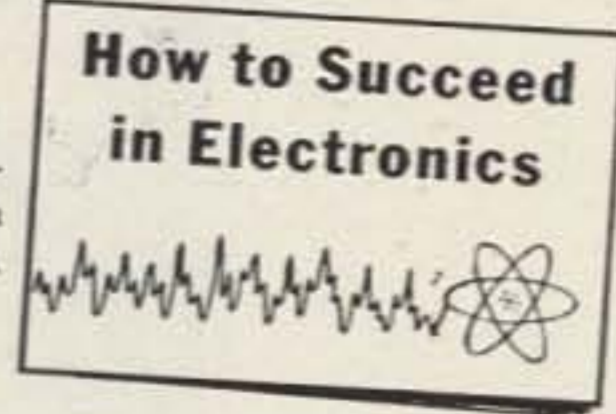

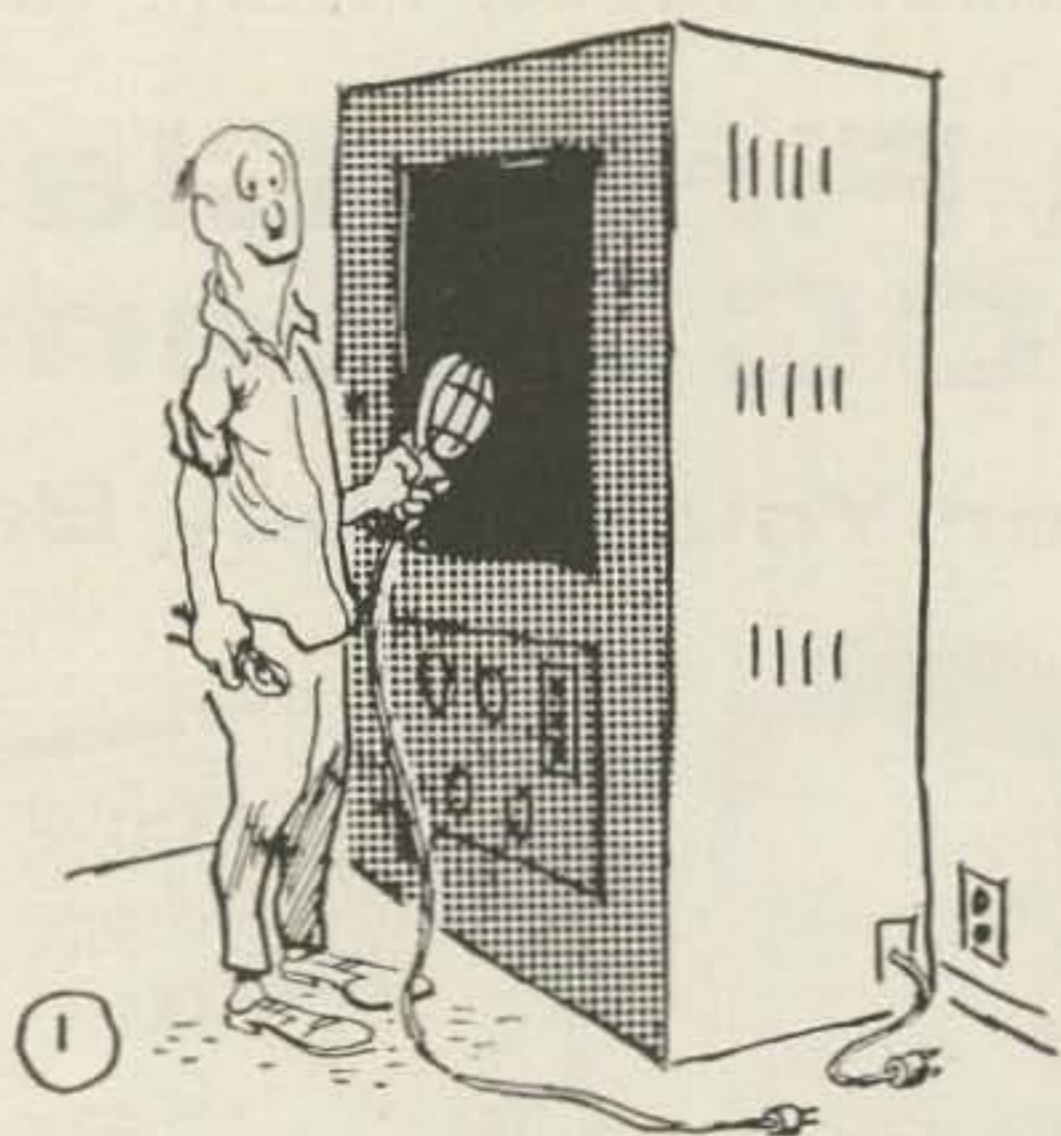

BOY, THESE KING-SIZE CABINETS ARE THE CAT'S-MEOW!

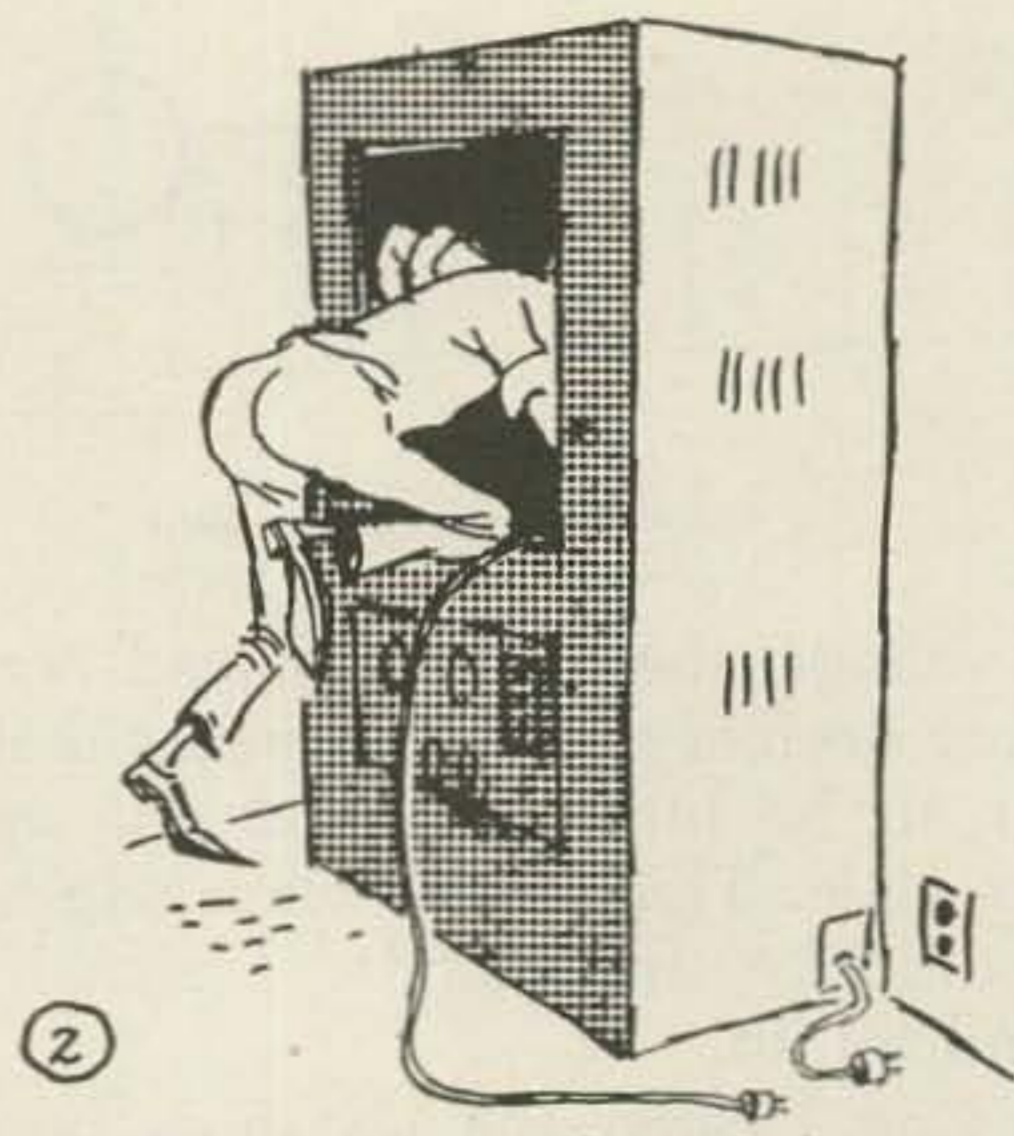

NO TROUBLE TRACING CIRCUITS WITH THIS RIG...

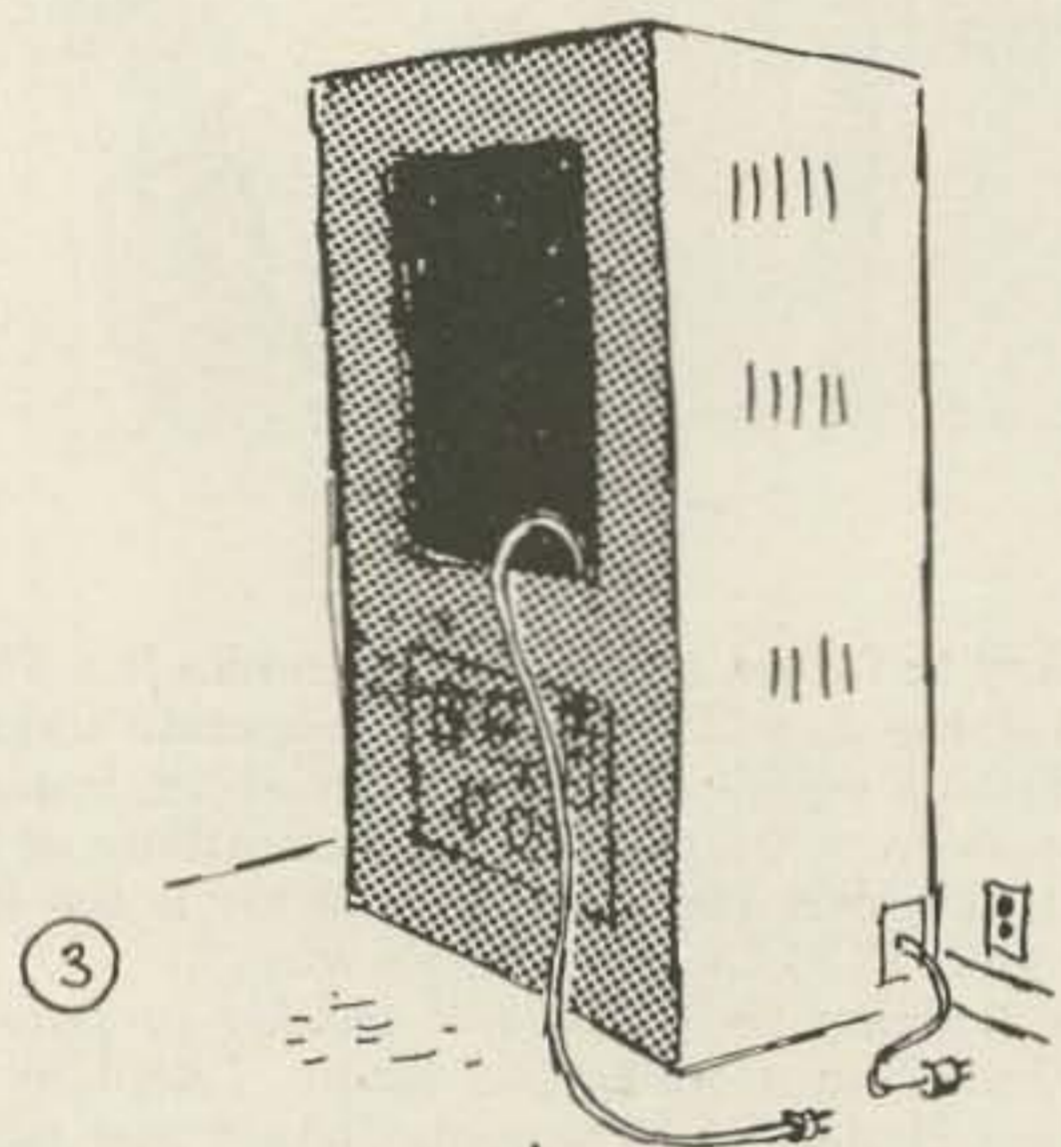

HEY, MABEL! PLUG MY DROP-LIGHT IN, PLEASE!

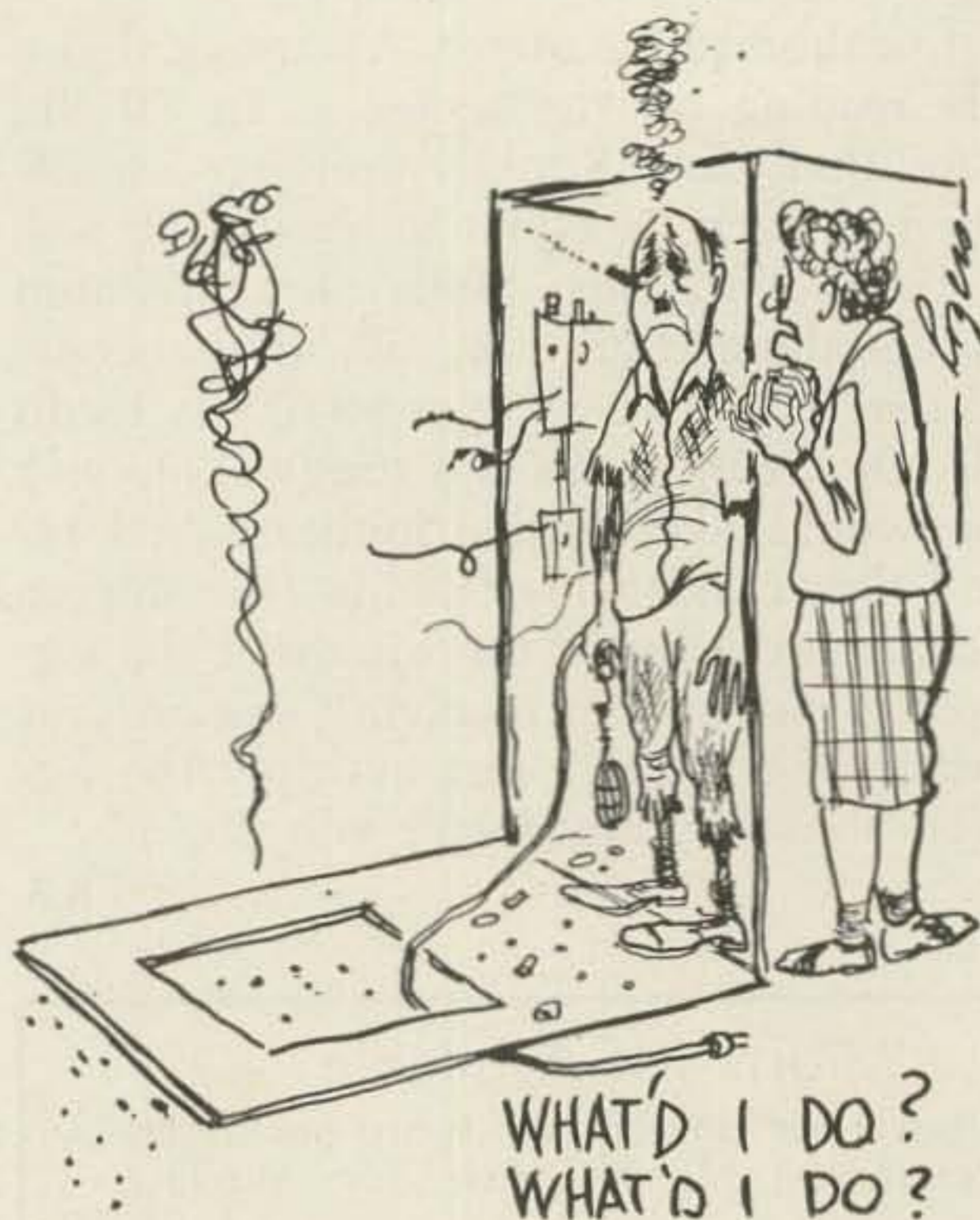
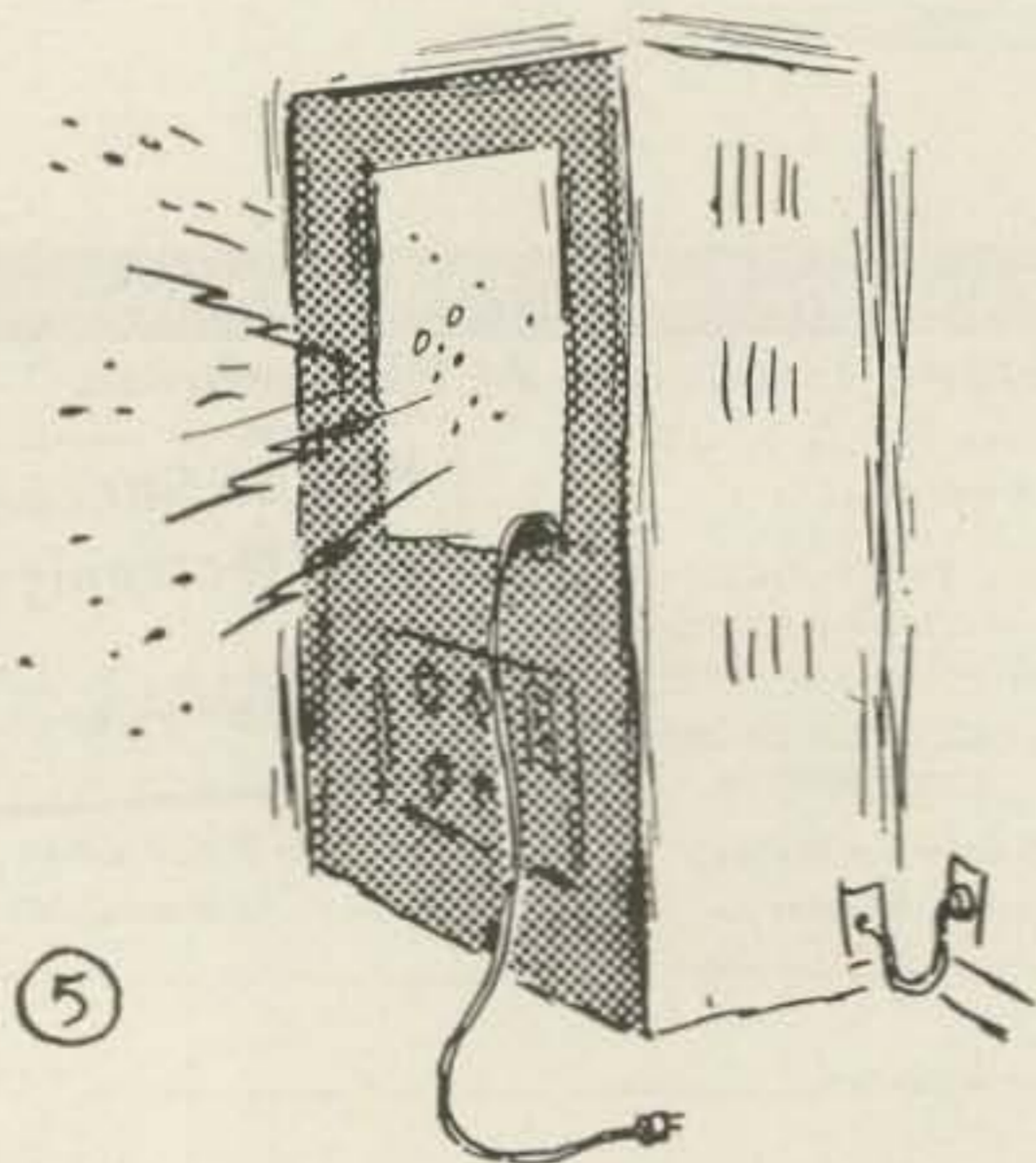

WHAT'D I DO?
WHAT'D I DO?

NEW Mosley EL TORO antennas

TW-3X
\$19.95

TW-3X Jr.
\$14.95
NS-3



- **THREE MODELS** - Mosley El Toro antennas are available in three models, TW-3X - NS-3 and TW-3X Jr., designed to give outstanding performance. These versatile antennas were developed for the ham with a limited budget, limited space and the traveler working portable.

- **THREE BAND OPERATION** - Mosley TW-3X and TW-3X Jr. antennas operate on 20, 40 & 75/80 meters. Mosley NS-3 (Novice Special) operates on 15, 40 & 80 meters. All Mosley antennas feature pretuned, compact design & excellent broad band characteristics.

- **TWO POWER RATINGS** - Mosley TW-3X has an AM rating of 1000 watts input to the final amplifier and a CW/SSB rating of 2000 watts P.E.P. Mosley TW-3X Jr. and NS-3 (Novice Special) have ratings of 300 watts on AM & 1000 watts input to the final amplifier on CW and SSB.

Mosley El Toro antennas are trap type grounded quarter wave antennas using a unique method of tuning and a single 52 ohm coax line. Antenna is 58 ft. long and can be mounted to fit most any location. No radials are needed when mounted at ground level. Antennas come pretuned, in kit form and can be easily adjusted to resonate at any portion of the rated bands.

Mosley Electronics, Inc.

4610 N. LINDBERGH BLVD., BRIDGETON, MISSOURI

63044

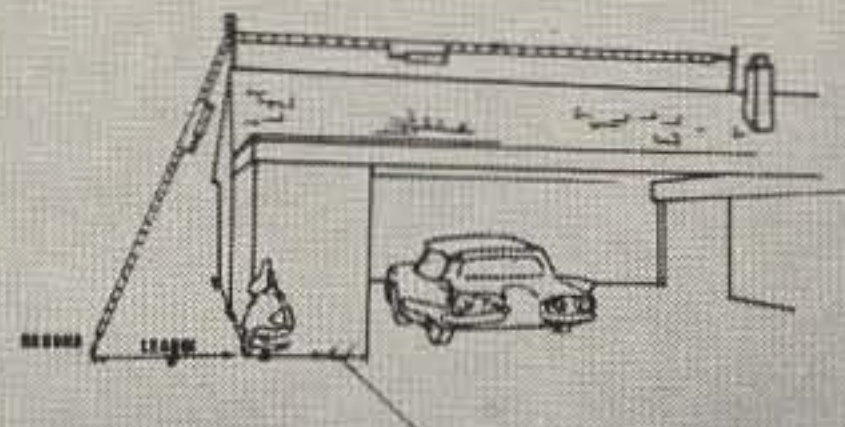
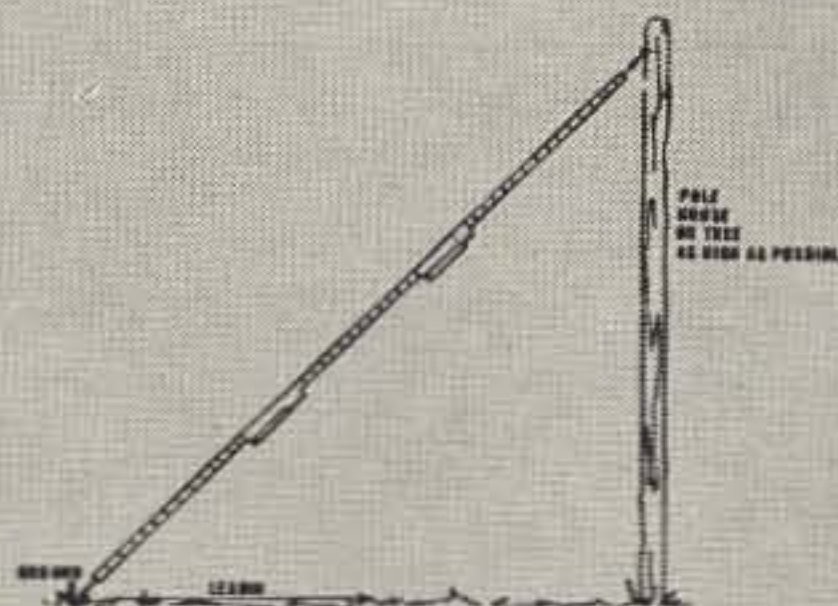



HERE IS THE TOWER WE PROMISED YOU— YOUR BEST BUY IN A FREE STANDING TOWER

Here at last is a low cost free standing tower with all the quality of design and construction that the biggest most expensive TRI-EX TOWERS are famous for. This crank-up tower is free standing — no guying is required — even in hurricane winds with extremely large antenna loads topside! For convenience in antenna installation, either the TILT-OVER or GIN-POLE accessories illustrated are available at moderate extra cost. Write today for complete data on these and other TRI-EX towers. There is a TRI-EX tower to fit YOUR antenna requirements.

ILLUSTRATED MODEL NUMBER	HEIGHT	PRICE (STANDARD FINISH)
HM-354 (3 sections) and TBC	Extended: 54' Collapsed: 20'-1"	\$425.75

NOTE THESE WIND LOAD CAPABILITIES:
(Based on a six foot mast above the tower, with the center of the antenna at the top of the mast: i.e. 60 feet above ground.)

UNIFORM BUILDING CODE WIND PRESSURE	ANTENNA projected area
20 lbs./sq. feet	10 sq. feet
30 lbs./sq. feet	5 sq. feet
L.A. City Code (Strong Winds and Earthquakes)	10 sq. feet

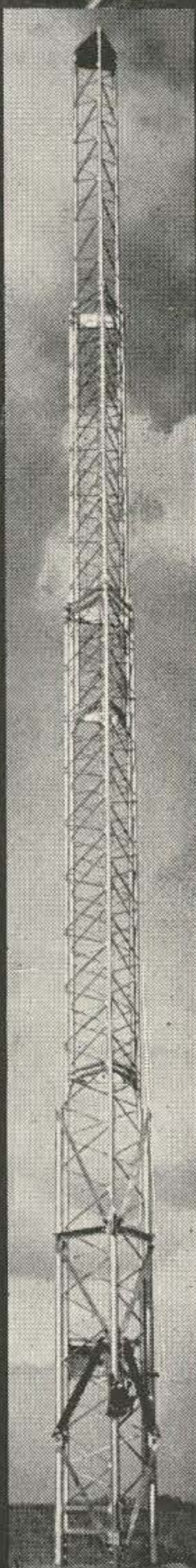

Towers

Val Barnes K1APA

Hams press almost anything into service to hold up their antennas. Chimneys, trees and telephone poles may be used a lot, but there is nothing quite as satisfactory as a good tower. In years gone by a ham had to either build his own out of available materials (latticework or ladders) or else try to find an old windmill or broadcast tower. The advent of fringe area television and burgeoning commercial services have brought many manufacturers into the economy tower making business. You can now buy a complete tower with guys for just about what you would have had to pay for food to build your own rickety monstrosity a few years back.

Perhaps you've held back on buying a tower because you are worried about getting it erected. Well, I've proven rather conclusively that you can pick two hams at random with no previous experience and still get just about any ham tower up in the air in a few hours. Using unbelievably incompetent help I've recently erected a 120 foot tower, then used it to remove a 64 element two meter beam from a nearby 100 foot tower. Then I took both towers down and set them up again at the 73 Mountain VHF Station, along with two other 60 foot towers and a new 100 footer. My main helper in most of this is a ham we all call Goat Boy because he spends a great deal of his time butting heads with our pet goat. He's ahead, but his attention seems to wander a lot these days.

Towers. Before buying you'll want to make the decision about whether you are going to buy a crank-up type or a regular un-crank-up type. If you like to make adjustments on beams or change antennas every now and then without risking a nasty fall you should eye the crank-ups.

Though several manufacturers have designed their towers to stand up without guys (some up to 70 feet), it has been my experience that most hams eventually put more on top of the



Tri-Ex TOWER CORPORATION
127 EAST INYO STREET / TULARE, CALIFORNIA

MANUFACTURER	MODEL	TYPE	MAX. HGT. FT.	MIN. HGT. FT.	VERTICAL MEMBERS (INCHES)	WIDTH AT BASE (INCHES)	WEATHER PROOFING	AV. COST \$/FT	TOTAL COST	WGT. (LBS)
E-Z Way	6046	CU TO	60	26	---	---	HD galv.	5.40	324	---
	HD-40	CU TO	40	24	0.84 OD	8.5	Al. Enamel	2.48	264.00	400
	RBS-40	CU TO	41	25	1.05 OD	10	Al. Enamel	4.14	244.50	350
	RBX-40	CU TO	41	25	1.32 OD	14	Al. Enamel	5.32	350.00	488
	RBS-50	CU TO	51	35	1.05 OD	10	Al. Enamel	4.38	314.50	418
	RBX-60-3	CU TO	60	25	1.32 OD	14	Al. Enamel	5.58	455.00	610
	RBX-70-3	CU TO	73	30	1.32 OD	14	Al. Enamel	6.64	730.00	861
	G10	SS	210	10	1 OD	9.75	HD galv.	2.55	404.20*	430*
	G40	SS	300	10	1.25 OD	16	HD galv.	3.65	517.60*	660*
HP-34	SSNG	34	34	---	9.75	HD galv.	2.20	84.95	---	
Heights KTV	A120	SSNG	120	8	Aluminum	26, 11	none	6.87	894.00	329
	1200-G	SS	130	10	1 OD 14 ga.	12	HD galv.	2.75	537.20*	498*
	1600	SS	130	10	1 OD 14 ga.	16	HD galv.	3.25	593.23*	454*
	1600-XX	SS	130	10	1 OD 14 ga.	16	HD galv.	4.00	673.20*	606*
Mosley	100	CU HB	105	21.5	---	17.6	Epoxy Resin	---	510.51	395
	300	CU HB	88	21	---	20.6	Epoxy Resin	3.54	440.11	390
	400	CU HB	37	20.3	---	14.75	Epoxy Resin	3.92	208.66	165
	500	CU HB	88	21.7	---	26.6	Epoxy Resin	5.42	698.80	620
	600	SS NG	50	50	1.66 OD x .128	28	Epoxy Resin	6.50	324.95	445
	650	CU TO HB	54	21	---	---	Epoxy Resin	6.86	515.90	935
	700	CU TO HB	71	21.5	---	---	Epoxy Resin	11.45	1009.90	1745
	750	CU TO HB	71	21.5	---	---	Epoxy Resin	14.00	1189.90	1785
Rohn	6	CU	71	20	1 OD 14 ga.	14.5	HD galv.	3.98	395.60	370
	25	TO	48	21.5	1.25 OD 16 ga.	12.5	HD galv.	5.63	207.10	350
	25	SS	280	10	1.25 OD 16 ga.	12.5	HD galv.	2.61	402.95*	513*
	45	SS	350	10	1.25 OD	16.75	HD galv.	4.89	706.90*	884*
Supreme	40-1	CU	40	23	1.12 OD 17 ga.	8.75	Al. Paint	2.97	129.00	132
	40-2	CU	40	23	1.12 OD 17 ga.	8.75	Al. Paint	3.72	159.00	140
	40-3	CU	40	23	1.12 OD 17 ga.	8.75	Al. Paint	5.97	253.50	170
	60-4	CU	60	24	1.12 OD 17 ga.	11.25	Al. Paint	6.57	414.50	350
	60-5	CU	60	24	1.12 OD 17 ga.	26.5	Al. Paint	11.56	695.00	425
Tristao	100	CU HB	105	21.5	---	17.6	Epoxy Resin	3.32	476.31	395
	300	CU HB	105	21.75	---	23.5	Epoxy Resin	3.89	593.17	520
	400	CU HB	105	22	---	26.6	Epoxy Resin	5.72	817.40	790
	500	CU HB	105	22.5	---	30.5	Epoxy Resin	7.46	1073.65	890
Tri-Ex	HM-354	CU TO HB	54	20	1.5 OD x 0.12	23	HD galv.	9.43	509.00	850
	SX-6105	CU HB	105	21.8	1.25 OD x .083	27.6	Epoxy Resin	9.87	1124.83	1030
	HM-237	CU TO HB	37	20	1.50 OD x 0.12	23	HD galv.	7.40	359.95	385
	HS-6105	CU HB	105	20	1.250 OD x .083	24.75	Epoxy Resin	8.07	951.27	870
	H-471	CU HB	71	20	1.25 OD x .083	19.37	Epoxy Resin	4.41	387.24	365
	T-588	CU HB	88	21	1 OD x .065	13.87	HD galv.	2.53	426.55	280
	10	SS	120	10	1 OD x .065	14	Epoxy Resin	2.51	612.57	485
	EMPIRE	CU HB	46	20	16 ga.	---	HD galv.	2.42	205.01	176
Vesto WRL	VHP	SS NG	100	22	2.5 x 2.5 L	---	HD galv.	13.12	1312.00	3000
	SPIRE JR	SS NG	8	8	U Channel	34	galv.	2.12	16.95	---
	SPIRE	SS NG	32	32	U Channel	19.75	galv.	1.56	49.95	115
	SPIRE	SS NG	40	40	U Channel	22.3	galv.	1.81	72.25	160
	SPIRE	SS NG	48	48	U Channel	25	galv.	2.20	105.50	230

CU TO = crank-up, tilt over
SS = self-supporting
SS NG = self-supporting, no guys
CU HB = crank-up, hinged base

CU = crank-up
HD galv. = hot-dipped galvanized
AVERAGE COST = exclusive of guys, base, etc.
*Computed for 100 foot tower.

tower than the manufacturer had in mind when he calculated wind loads and it is well worth the added expense and bother to put in some guys. You can guy the tower to trees, houses or even screw anchors which all the tower companies have available. With a little extra effort you can use the guys as an inverted V antenna for the lower frequencies.

The minimum height of a tower is either the cranked-down height or else the length of one section of a regular tower. The size and gauge of the vertical legs gives you a good indication of the strength of the tower. The

leg-to-leg distance is the width at the base. Crank-up towers naturally are smaller at the top since each section slides down inside the one below it.

If you have a rigorous climate you may pay more than passing attention to the finish. The hot-dipped galvanized is a bit more durable and thus is more expensive.

The cost-per-foot does not include guys and other accessories and is thus merely a relative figure. The total cost of the tower does include everything.

Many manufacturers can supply special top

sections to fit just about any commercial rotor. KTV has an arrangement for cranking your rotor and beams up and down the side of the tower called Hy-Track.

When you consider that raising your beam even thirty feet can make a world of difference it is worth while to take a close look at this chart. About the only tool you'll need that is special is a "gin" pole and this can be bought or borrowed from most tower companies. If you are going to do any great amount of high work you might do well to invest \$17 in a lineman's belt or else hound the surplus

houses until you find one at a bargain.

We have one tilt-over crank-up tower and it is a great comfort, though I must admit to a slight wince at the initial cost. This is mighty handy for us when we get in a new antenna to test out. It only takes a few minutes to go out and crank it down, then over so we can remove the old antenna and install a new one. Inside of a half hour it is back up ready to use.

While most tower manufacturers are extremely helpful and have interesting and educational literature, you may have as much trouble as we did with a couple. Good luck.

Institute of Amateur Radio

Membership in the Institute is growing rapidly. Yearly membership costs only \$1.00. Purpose: to make ham radio more fun. Programs: Group trip to Europe in October. Protection of minority groups (such as ham-TV'ers who are trying to open frequencies on two and six for experimental purposes; ARRL opposed). Protection of minority groups (such

as General and Conditional Class licensees who have suddenly found that they need protection). Establishment of communications between all amateurs, the FCC, the ARRL, government agencies, etc. We desperately need your help, won't you join? Send your name, call and address with \$1 to Institute of Amateur Radio, Peterborough, N. H.

Read about the great, new

SWAN SW-240 →

*and then order it from HENRY
for immediate delivery*

**Best Terms and Trades and our
Famous PERSONAL SERVICE**

SW-240 \$320.00 SW-117AC \$95.00 SW-12DC \$115.00

11240 West Olympic Blvd.

Los Angeles 64

Ph. (213) BR 2-0861, GR 7-6701



Henry Radio Stores

Butler 1, Missouri

ORchard 9-3127

931 N. Euclid Ave.,

Anaheim, Calif.

PR 2-9200

STILL LEADING THE FIELD...THE SWAN SW-240



NOW ...
WITH NEW STYLING
AND EXTENDED
CW COVERAGE
14,000-14,350 KC
7,000-7,300 KC
3,650-4,000 KC*

240 watts PEP input. High frequency crystal lattice filter. Precision tuning mechanism. Exceptional frequency stability. Receiver sensitivity better than one microvolt. Automatic gain control. ————— **\$320**
 Break-in CW operation.

MOBILE MOUNTING KIT

Locking type, including speaker switch, with front-mounted mike jack... **\$19.50**

SIDEBAND SELECTOR KIT

Provides both opposite sideband and AM receive position... **\$18**

* Kit for full 80 meter coverage available.

SWAN POWER SUPPLIES

SW-117AC (illustrated) for home station. With 5 x 7 speaker and phone jack... **\$95**

SW-12DC for mobile operation. With pre-wired cables and installation hardware... **\$115**

ASK THE HAM WHO OWNS ONE

 **SWAN**
 ELECTRONICS CORP.
 Oceanside, California

Louis Hutton WØRQF
 2608 S. Fern
 Wichita 17, Kansas



A VHF Receiver

For some time I had been using the ten meter band on my receiver as a tunable *if* for a six meter and two meter converter. This mode of operation tied up the ten meter band and limited my coverage on the VHF bands. The idea began to dawn that what I needed was a separate VHF receiver capable of covering the full four megacycles of the six and two meter bands. The receiver described in this article

consists of a tunable *if* covering a four megacycle range from 14 mc to 18 mc. Detectors are provided for AM, CW and SSB. Controls include audio and rf gain, noise limiter, SSB/CW-AM mode, avc, and selection of either a six or two meter converter or tunable *if* input. The approximate cost of the receiver including the two VHF converters and all new components will be less than \$200. A minimum of

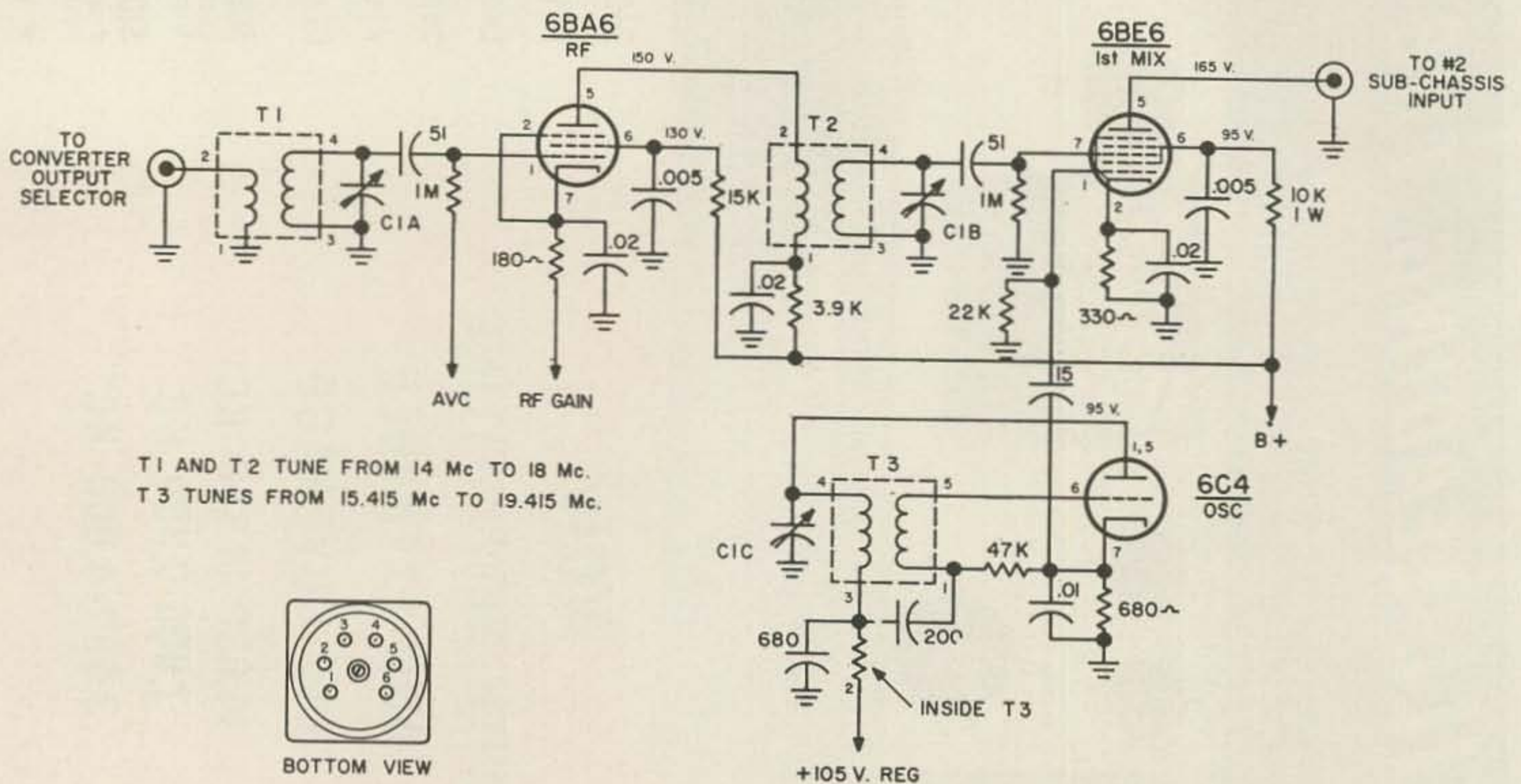

T1 AND T2 TUNE FROM 14 Mc TO 18 Mc.
 T3 TUNES FROM 15.415 Mc TO 19.415 Mc.



BC-455, 6 to 9 Mc RF, MIX AND OSC COILS

#1 SUB-CHASSIS VHF RECEIVER
 14 Mc - 18 Mc TO 1415 Kc IF

OVERLOAD? NOISE? CROSS-MODULATION?

Not with the Amplidyne Nuvistor Converters

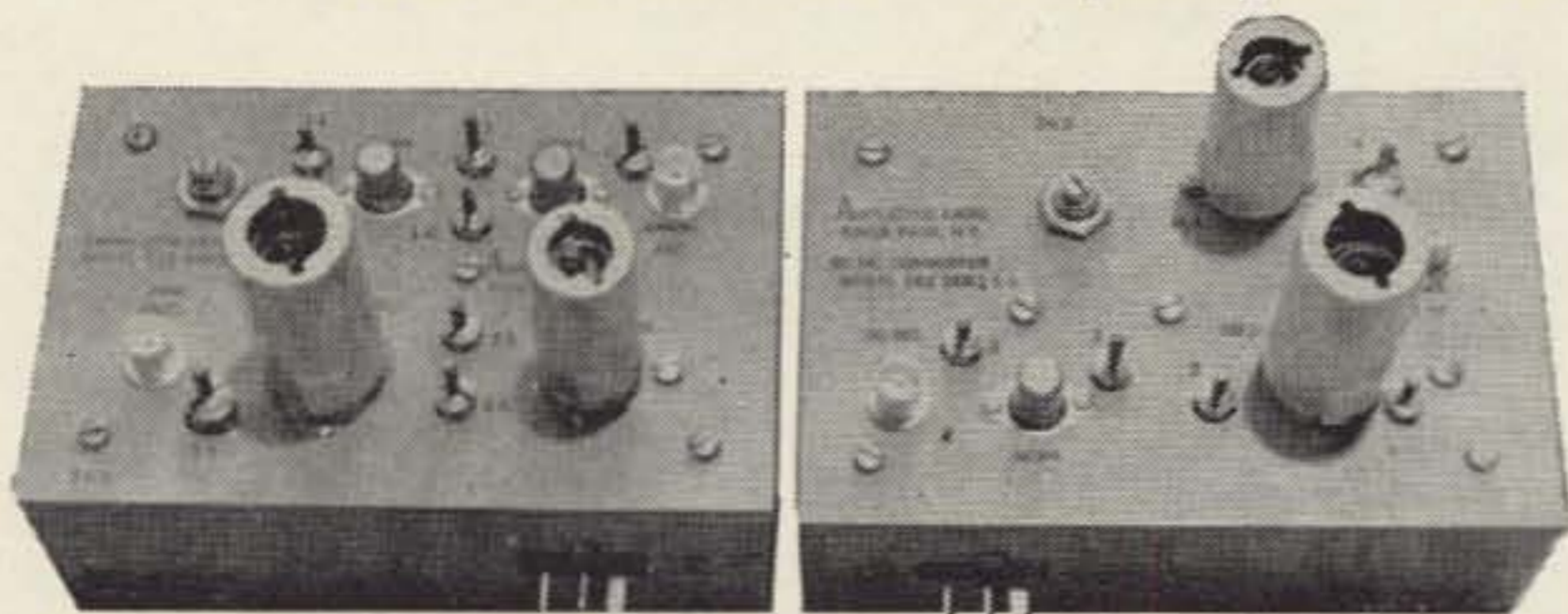

C-23 4x6x2" C-61

	C-61	C-23
Input	50-54	144-148
Noise figure	2.5db	3.0db
Gain	25db	30db
Output	14-18mc standard (any other \$1 additional)	
Impedance	50 ohms	50 ohms
PRICE	\$28.50	\$34.25

ADJUSTABLE I.F. GAIN, TRIODE MIXER, .005 XTAL INSIDE CHASSIS TO PREVENT DRIFT, 6CW4 GROUNDED GRID R.F. AMPS

NUVISTOR PREAMPS

P-25-144-148 mc \$9.75
P-62- 50- 54 mc 9.75

MATCHING SUPPLY FOR

C-61 and C-23 solid state \$9.75

All Amplidyne products are guaranteed for TWO years against component failure and one year on tube failure.

COMING SOON

6 & 2 meter 60 watt xmtr, plate modulated.
220 & 432 nuvistor converters

Send check or money order today

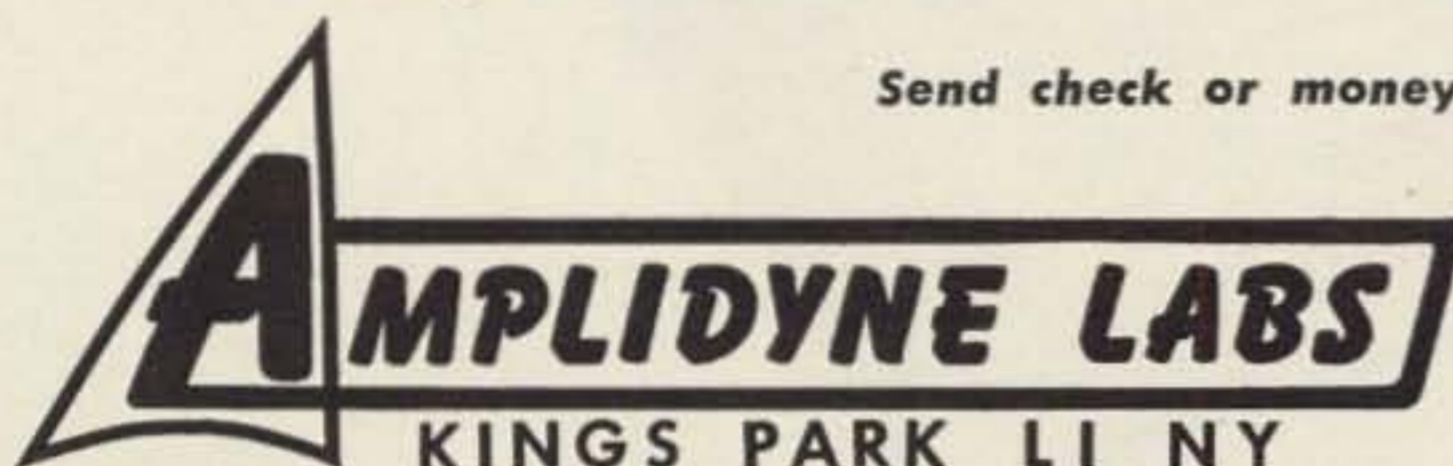

BOX 673

Write for technical info

tube types were used in order to keep tube inventory reasonable. Some of these new receivers use a different type tube for each stage of the set. Although the junk box collection for this project was started over a year ago the construction took about a month and a half of evenings and weekends. Assembly of the two commercial VHF converters required about six evenings of time.

Circuit Description

The receiver circuitry begins with an AMECO six or two meter Nuvistor equipped converter whose output covers the 14 mc to 18 mc band. A selector switch controls the B+ to each converter and the appropriate rf output to the input of the receiver. The receiver consists of four sub-chassis. The first is a tunable front end covering 14 mc to 18 mc whose output is 1415 kc. The second sub-chassis amplifies the 1415 kc signal through one stage of *if* and converts it to 239 kc. The third sub-chassis consists of two stages of low frequency *if* amplification and an AM detector, avc detector, and the ANL stage. The fourth sub-chassis includes the SSB/CW detector, bfo and the tuning meter detector. The power supply and audio stages are located on the main chassis.

Construction

Two surplus ARC-5 command type receivers were acquired for junking purposes. These two units covered the range from 3 mc to 6 mc, and 6 mc to 9 mc. The tuning condenser and the associated coils were removed from the 6 mc to 9 mc unit for use in the first sub-chassis. The gear mechanism was removed from the tuning condenser. All the rotor plates but two were pulled from the rf and mixer sections of the tuning condenser. Three rotor plates were left on the oscillator section. The rotor plates with all the slots that are used for tracking purposes

(Turn to page 30)

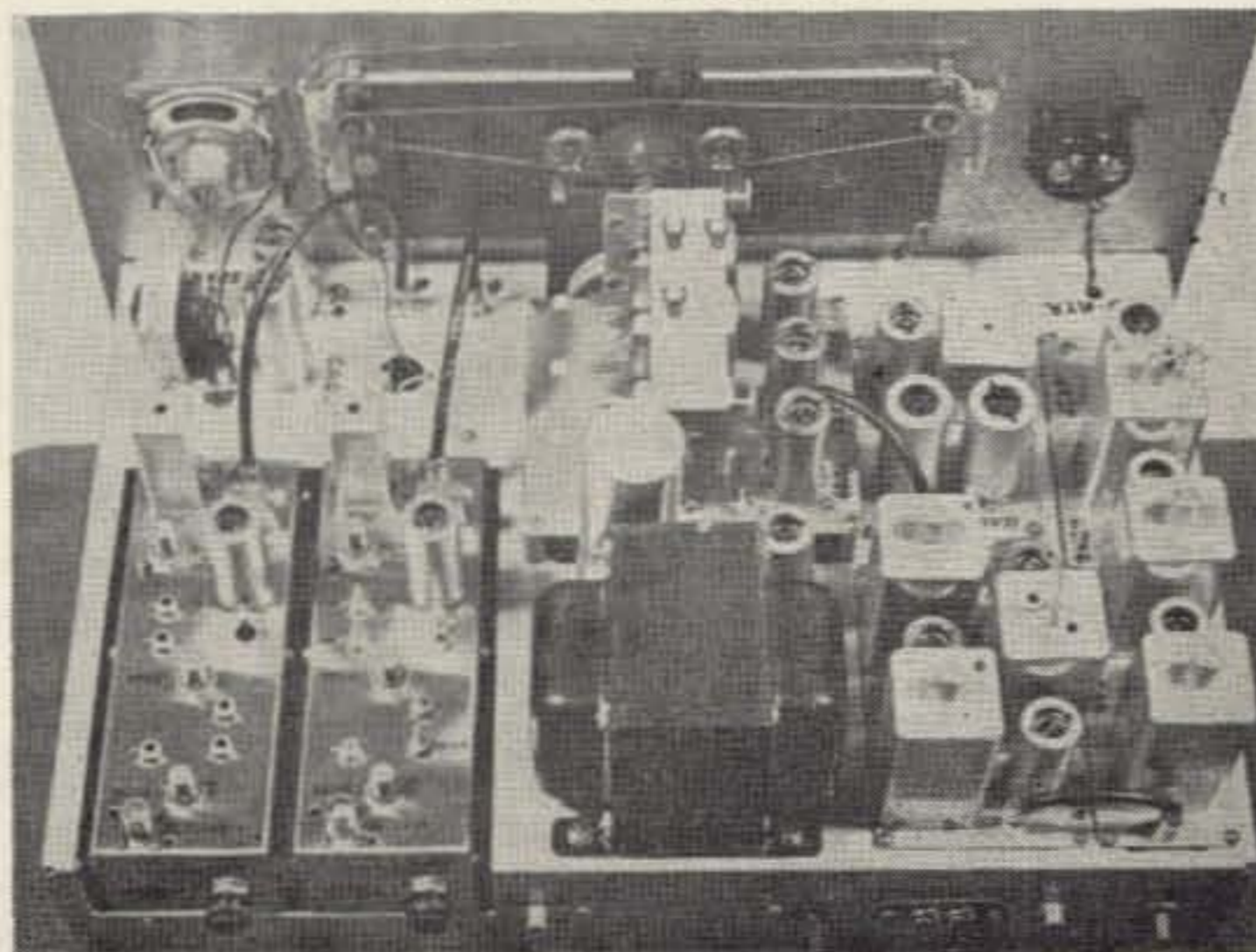

NEW!



An Economy Converter

6M ONLY \$31⁹⁵

Dear OM:

There are quite a few VHF converters on the market today. Some of them are pretty good, some are unbelievably terrible. After looking over the available converters we decided that we could do better. We have. Only a ham could afford to put the months of lab time into the development of something like this, trying every known circuit and testing each under the worst possible ham band conditions.

We reached several interesting conclusions as a result of all this research. 1) The noise figures claimed for several brands of converters seem to have been determined in advertising departments instead of labs. 2) If it doesn't work too well, gold plate it. 3) It is standard practice to use the cheapest parts available even if it does reduce the life expectancy of the converter or cut down on its

performance. 4) Some converters were obviously thrown together from old magazine articles and there wasn't even a sign that an engineer had been near them. 5) There should be a market for a well engineered converter.

Naturally, for our own use, we pulled out all the stops and built the last word in state-of-the-art VHF engineering. When we figured out what it cost to build this converter we could see that this wasn't going to be very popular. Not many hams are going to spend \$98.50 for a converter, no matter how unbelievably it performs. After all, how many hams are so avid about working DX that they want to pull extremely weak signals out of the noise? Just a handful of meteor-scatter addicts, aurora hounds and the like would ever need the gain and the rejection of adjacent signals that our DGC models afford.

Matching Power Supply HJS \$9.95

Delivery Date, Sept. 1

You can't put units like our DGC Converters on the market and sell enough to stay around. Which thought sent us back to the workbench and eventually brought about the economy converter, the model HJC-50. This one is designed to compete with any other converter on the market price-wise and we are sure enough of its operation to give a money-back guarantee that it will outperform any other commercially made converter, regardless of price, except our DGC units. The HJC-50 uses a nuvistor front end for low noise figure. It is crystal controlled for stability. The HJC-50 is designed to be used with 14-18 mc receiver tuning. Thus you can tune the 50.0-50.4 mc band even if you only have a ham-band only receiver which tunes from 14.0-14.4 mc, and this covers virtually all of the presently used six meter band.

These converters are available by direct mail order only. This is necessary if we are to maintain our low price. The model HJC-50 converters are

now in stock for immediate delivery and all orders will be filled the day received. The DGC converters are custom built to your specifications. Please, if you must have one of these, specify the band it is to cover (50-144-220-432 mc) and the i-f output frequency. We will build your unit and individually test it, furnishing you the test result certificate and customizing it with your call engraved.

The DGC converters are built into a solid aluminum extruded case which can be used on the operating table or else mounted on a rack panel. It is attractively finished in bright red and black. It is entirely nuvistorized, using the new 6DV4 (hang the expense) for the front end.

The HJC converters are available in the 50 mc model at present, with higher frequency models in the works. Watch for our ads. We have a lot more gadgets just about ready for production too.

Val Barnes K1APA & Sam Harris W1FZJ

CUSTOM MADE

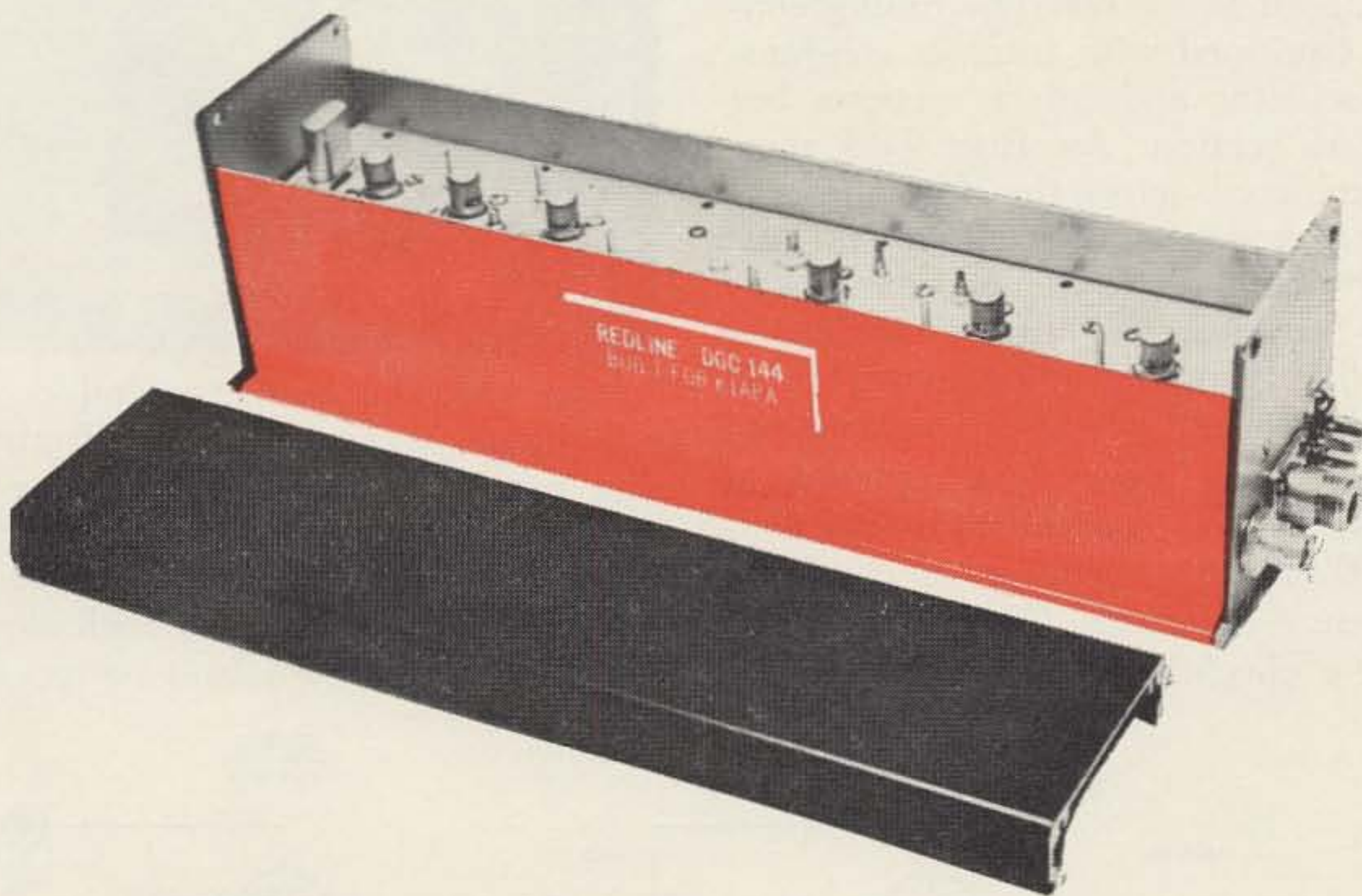

Money Is No Object Converter

DGC-50	98.50
DGC-144	98.50
DGC-220	98.50

These units are individually made to your specifications. Please state band and desired output i-f.

REDLINE

Jaffrey, New Hampshire

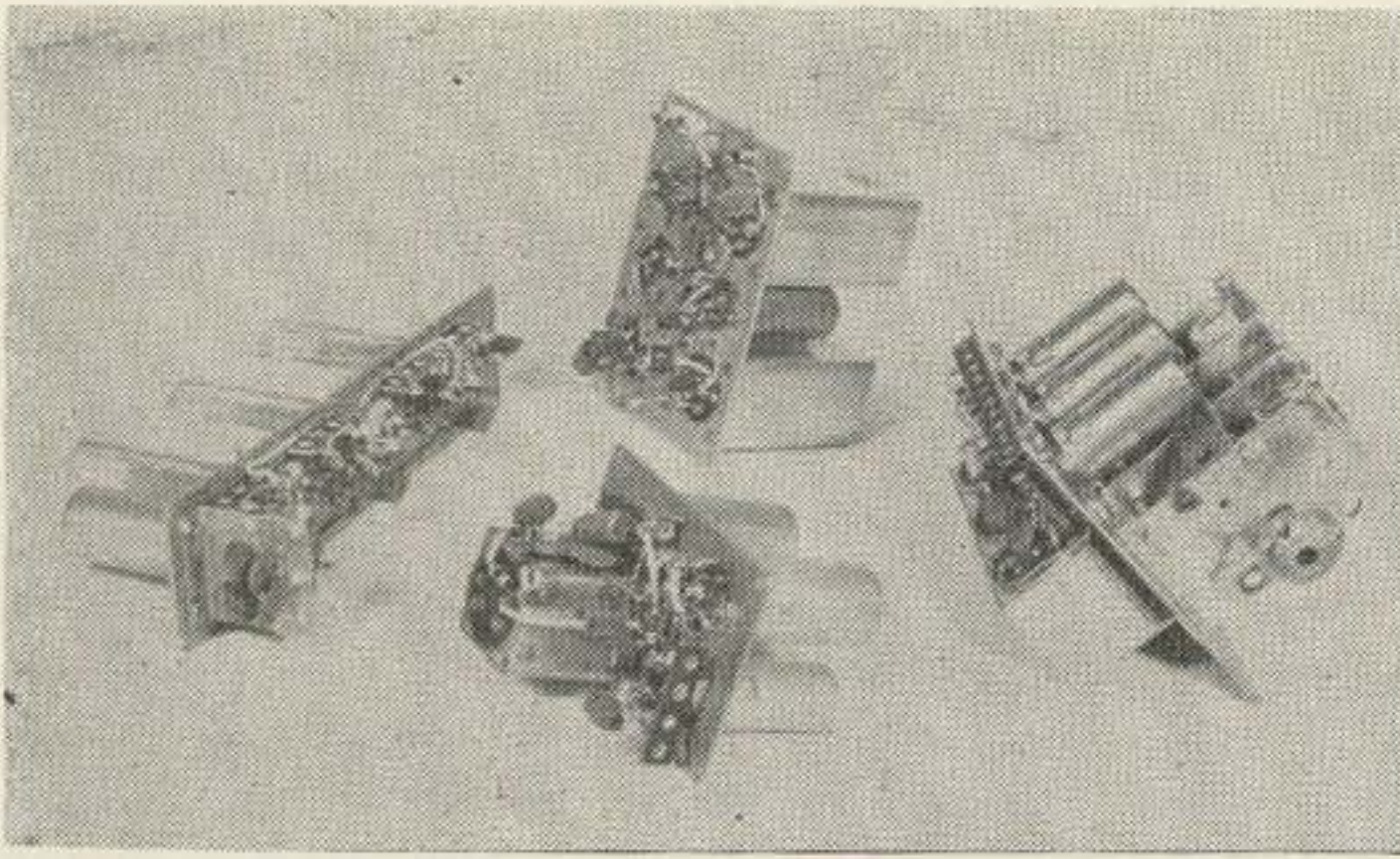

were left on the rotor also. The oscillator, mixer and rf grid coils were modified by removing half the turns plus one. The original *rf* coil was connected to the antenna through a coupling condenser. This coil is further modified by adding a new antenna winding over the cold end of the coil for antenna and ground connections. This coil is made from some of the wire removed during the above changes. It consists of about five turns. The tuning condenser comes equipped with trimmer condensers for the oscillator and mixer sections but none for the rf section. An Erie 7-45 mmf trimmer was soldered across the rf tuning section of the three gang condenser. One end was soldered to the stator and the other end soldered to the frame of the tuning condenser. This will provide trimming adjustments for all three stages of the front end to aid in tracking.

The modified coils were then replaced in their shield cans and each one breadboard connected to the three gang condenser to check for proper frequency coverage. The rf coil and mixer coil were checked for proper frequency

coverage using a Grid Dipper. The oscillator circuit was tacked together and the frequency coverage checked with a Frequency Meter. The oscillator must cover from 15.415 mc to 19.415 mc, if a 1415 kc *if* is to be used. The rf and mixer coils must cover the 14 mc to 18 mc of course. The powered iron slugs found inside the coil forms were backed off until they were almost to the end of their travel. The trimmer condensers on the three gang tuning condenser are used to set the high frequency end of the dial, and the slugs are used to set the low frequency end of the dial. As would be expected in any coil tracking job there is interaction between adjustments.

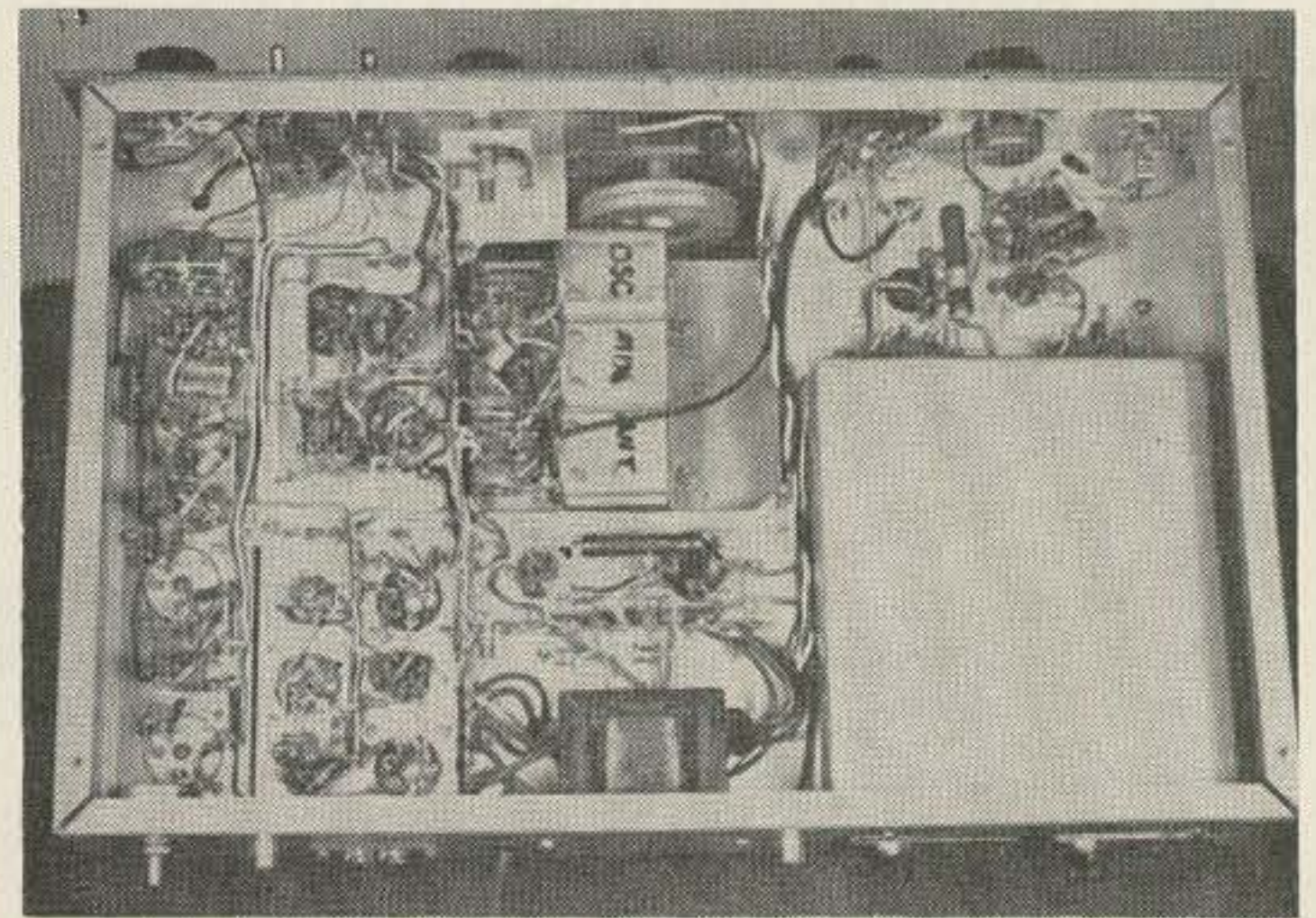

The 1645 kc oscillator coil on the second sub-chassis was constructed from a salvaged slug tuned coil form and mounted in one of the scrapped Command Receiver *if* cans. Its resonant frequency was determined by a Grid Dipper. After I was fairly well along with this sub-chassis one of my ham visitors quietly men-

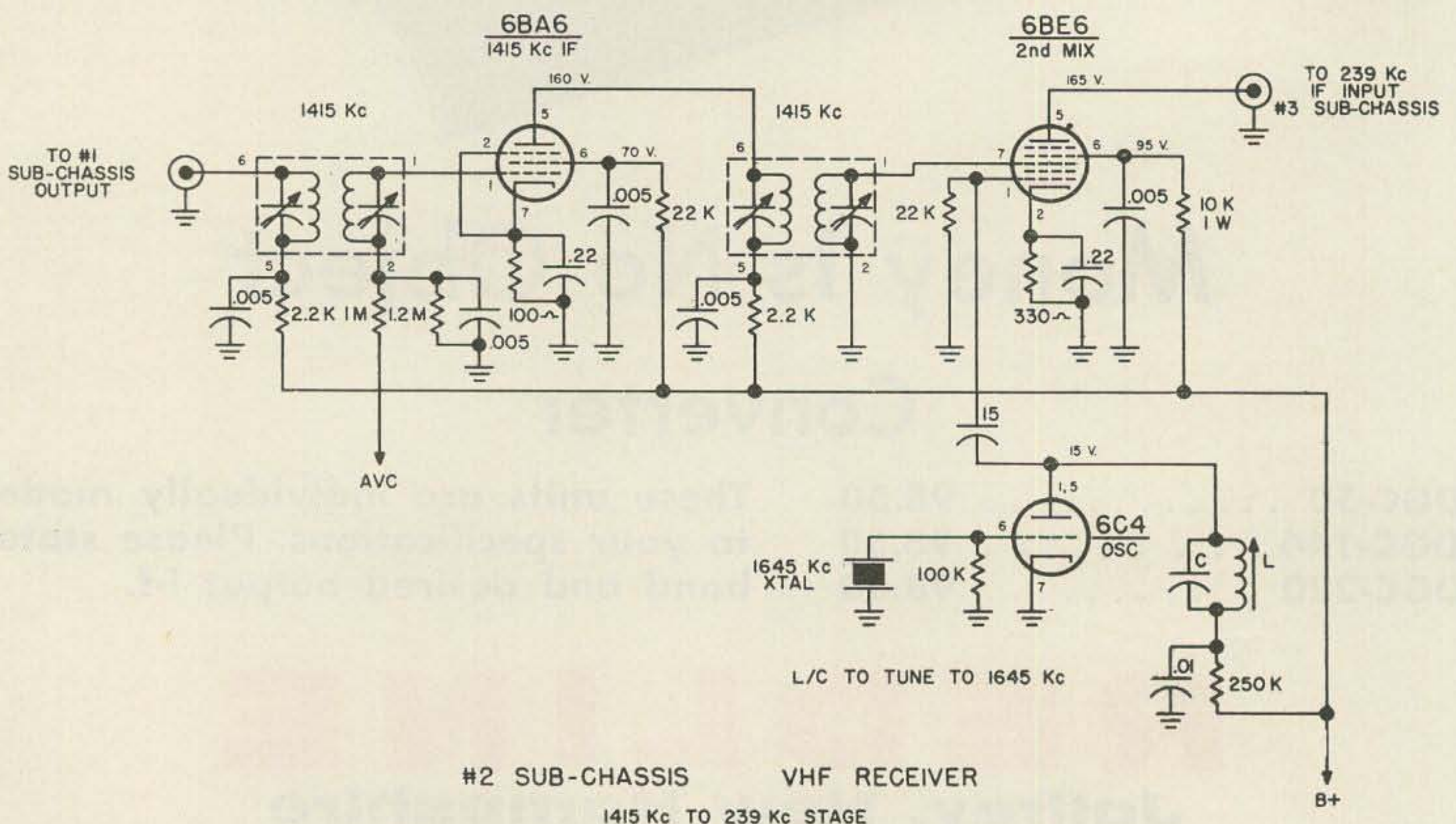

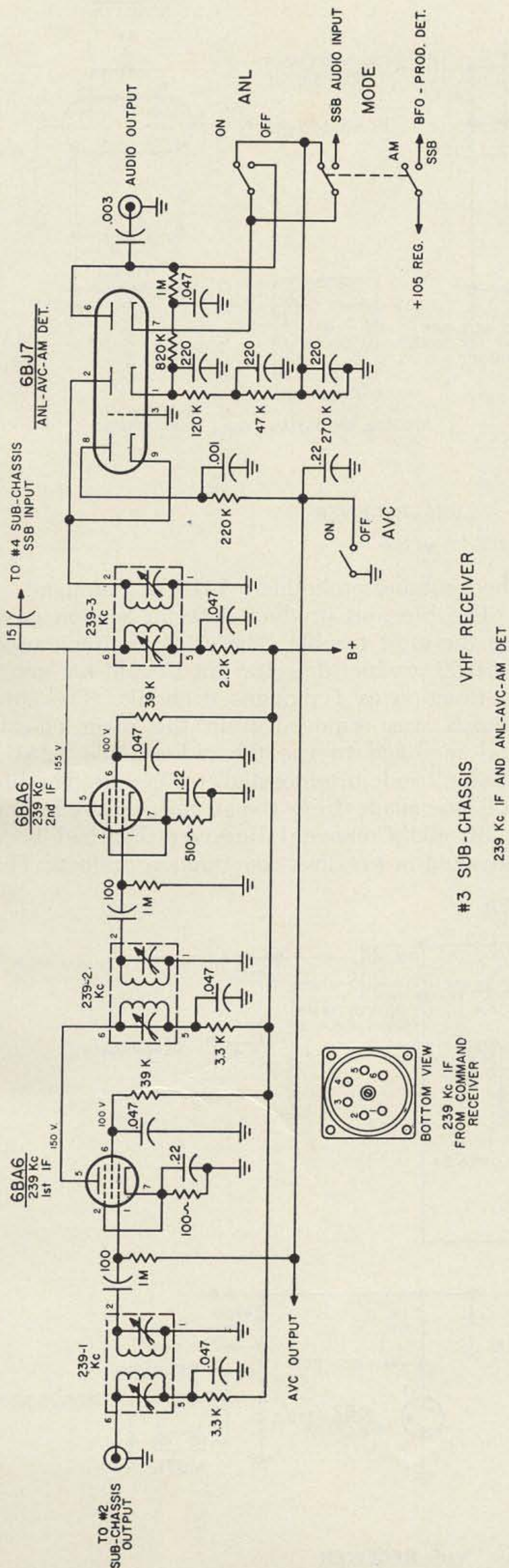

eliminate ignition system inter- ference

webster **band-
spanner.**
**ELECTRO
SHIELD
KIT**

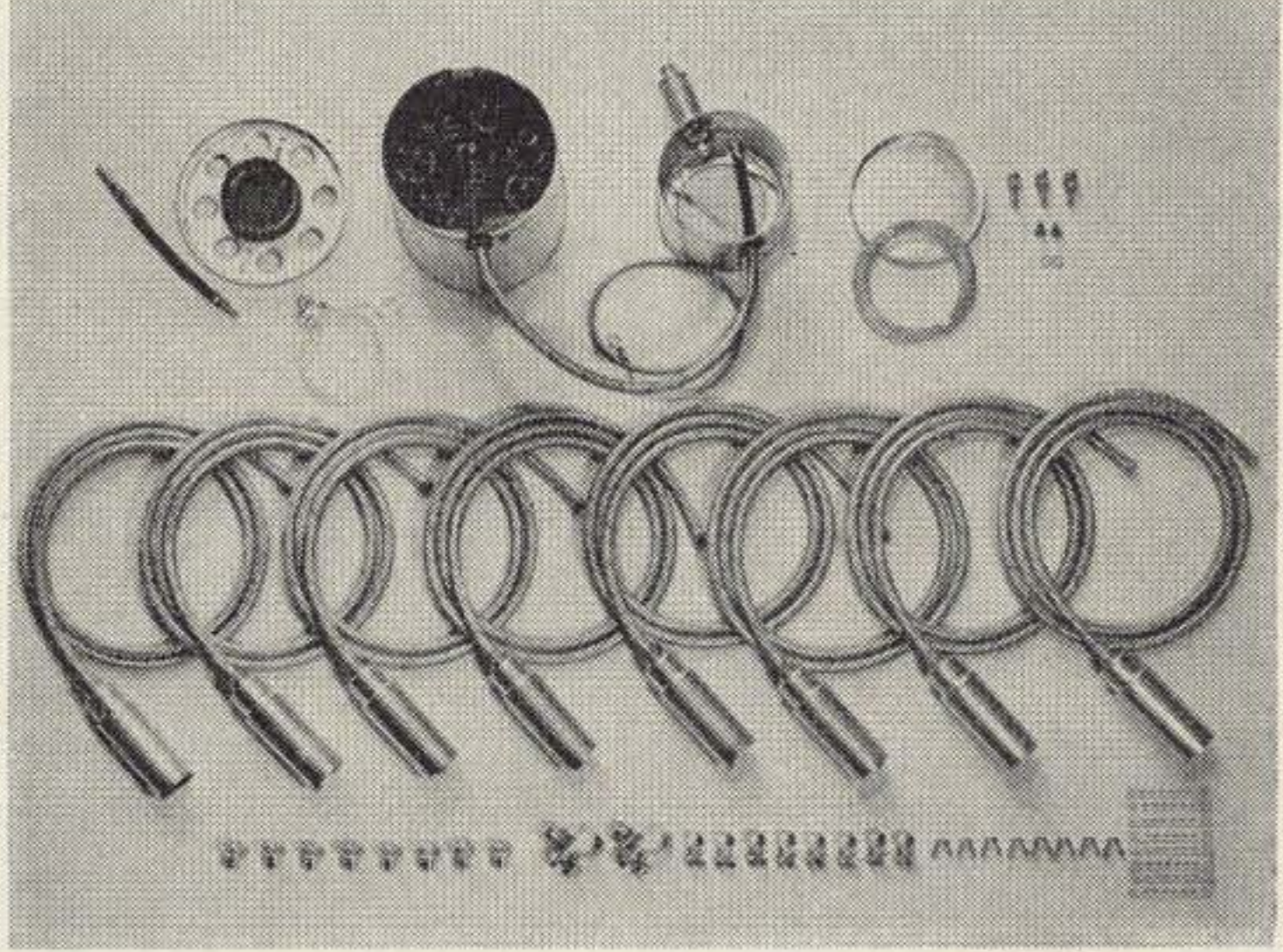

ELECTRO SHIELD prevents radiation—stops ignition noise at its source—by completely enclosing the entire ignition system, coil, plugs, distributor. **Entirely mechanical**, no phasing or filtering.

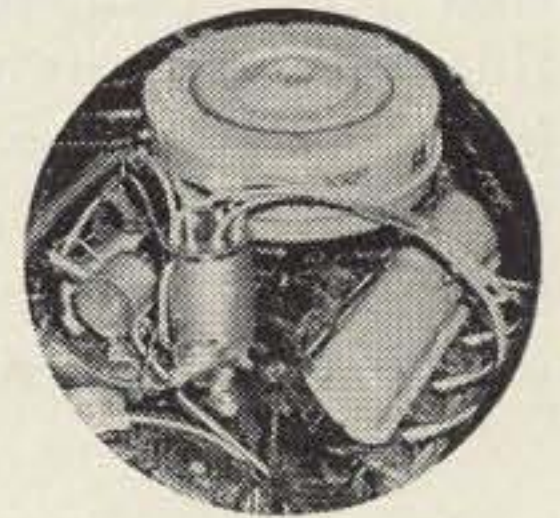

Now in kit form for substantial saving! Complete as illustrated. New cap and total shield for distributor—coil shield and filter—plug shields and leads. Snap-on plug connections are **swaged**—won't pull out or loosen. Plug shields have molded inserts which eliminate sparkover also waterproof plug. Kit includes all necessary hardware and full instructions. Typical installation is shown in circle.

Two kits available for 8 cylinder cars:
For '57-'63 Buick, Cadillac, Chevrolet, Corvette, International Harvester, Oldsmobile, Pontiac and Rambler.
MODEL 5500-DR-8
For '57-'63 Ford, Mercury, Lincoln, Thunderbird.
MODEL 5500-F8
Complete assemblies available for most 6 and 8 cylinder cars, also 4 cylinder VW's.

kit **49⁹⁵**
Plus F.E.T.

Please send information on Electro-shield and Band-spanner antennas and mounts.

Name _____

Number _____ Street _____

City _____ Zone _____ State _____

BAND-SPANNER 317 Roebling Road, South San Francisco, Calif.

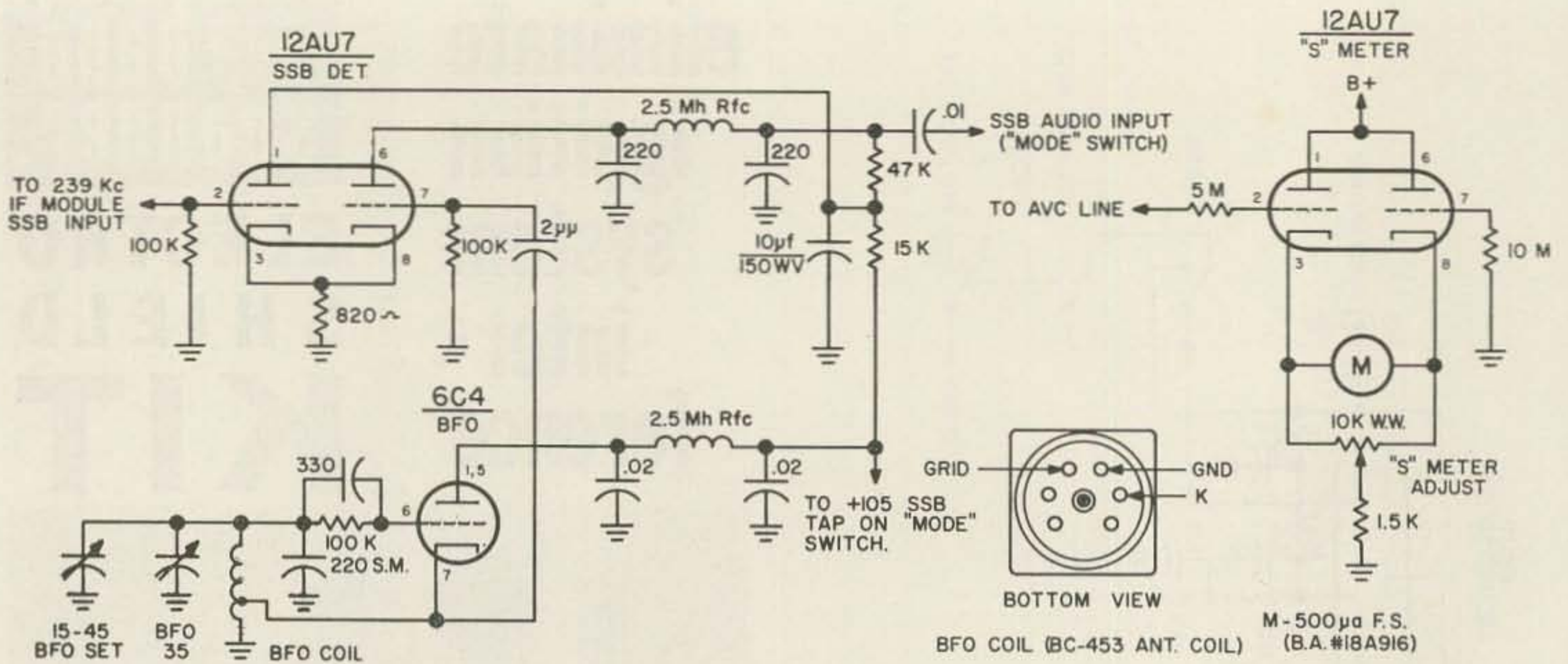

#4 SUB-CHASSIS VHF RECEIVER
PRODUCT DETECTOR-BFO-"S" METER

tioned that there was a broadcast station on 1410 kc in the vicinity. This resulted in some head scratching and scheming to keep wire lengths short for minimum spurious pickup and I was most happy to find no birdies from that station in the final product. When the third sub-chassis was finished wiring I hooked it up to a power supply and signal generator for *if* alignment. After this stage was aligned the second sub-chassis was temporarily connected to the third sub-chassis and given a

checkout and preliminary 1415 kc alignment.

The bfo and product detector section gave me the most trouble. The original circuit used a 6BE6 product detector but I could not get it to function as I thought it should. The sub-chassis was removed from the main chassis and modified to use the old reliable 12AU7 double triode product detector circuit. The bfo coil was made from the rf coil removed from a BC-453 Command Receiver that had been salvaged in previous construction projects. The

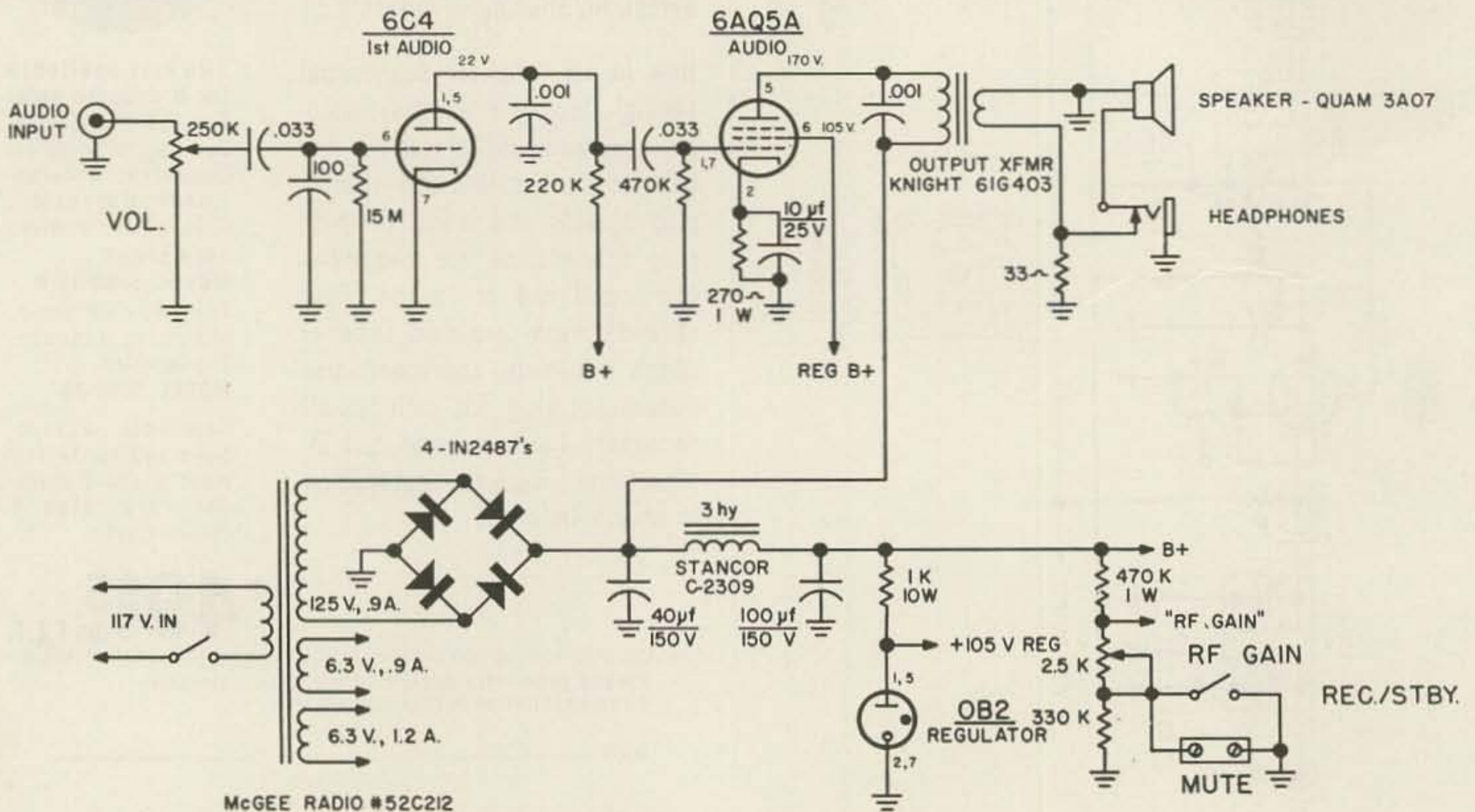

#5 MAIN FRAME VHF RECEIVER
AUDIO-POWER SUPPLY



COAXIAL TYPE SWITCHES

... multi-position, single or multiple gang

Now you can switch coaxial line circuits quickly and without error. These handy, inexpensive units are available with "UHF", "BNC", "N" and Phono type connectors for use with either 52 or 75 ohm lines. Phono connector types are specific for Hi-Fi applications. Other types are designed to handle RF Power up to 30 MC, 1 KW input.

Stock items ready for shipment are:

Model 550A—Single gang, single pole, 5 position switch with UHF connectors. Price: \$8.25 each.

Model 551A—Single gang, 2 pole, 2 position special purpose switch with UHF connectors. Ideal for switching any device in or out of series connection in coax line circuits. Price: \$7.95 each.

Model 560—Single gang, single pole, 5 position switch, same as Model 550A except with BNC type connectors. Price: \$11.95 each.

Model 561—Single gang, 2 pole, 2 position special purpose switch, same as Model 551A except with BNC type connectors. Price: \$9.95 each.

Model 570—Single gang, single pole, 5 position switch, same as Model 550A except with N type connectors. Price: \$13.35 each.

Model 580—Single gang, single pole, 5 position switch, same as Model 550A except with Phono type connectors. Price: \$7.35 each.

Multiple gang types, up to 6 gang for single pole—5 position switches, and as required for 2 pole—2 position switches, are made to order with any connector types listed above. Prices on request.

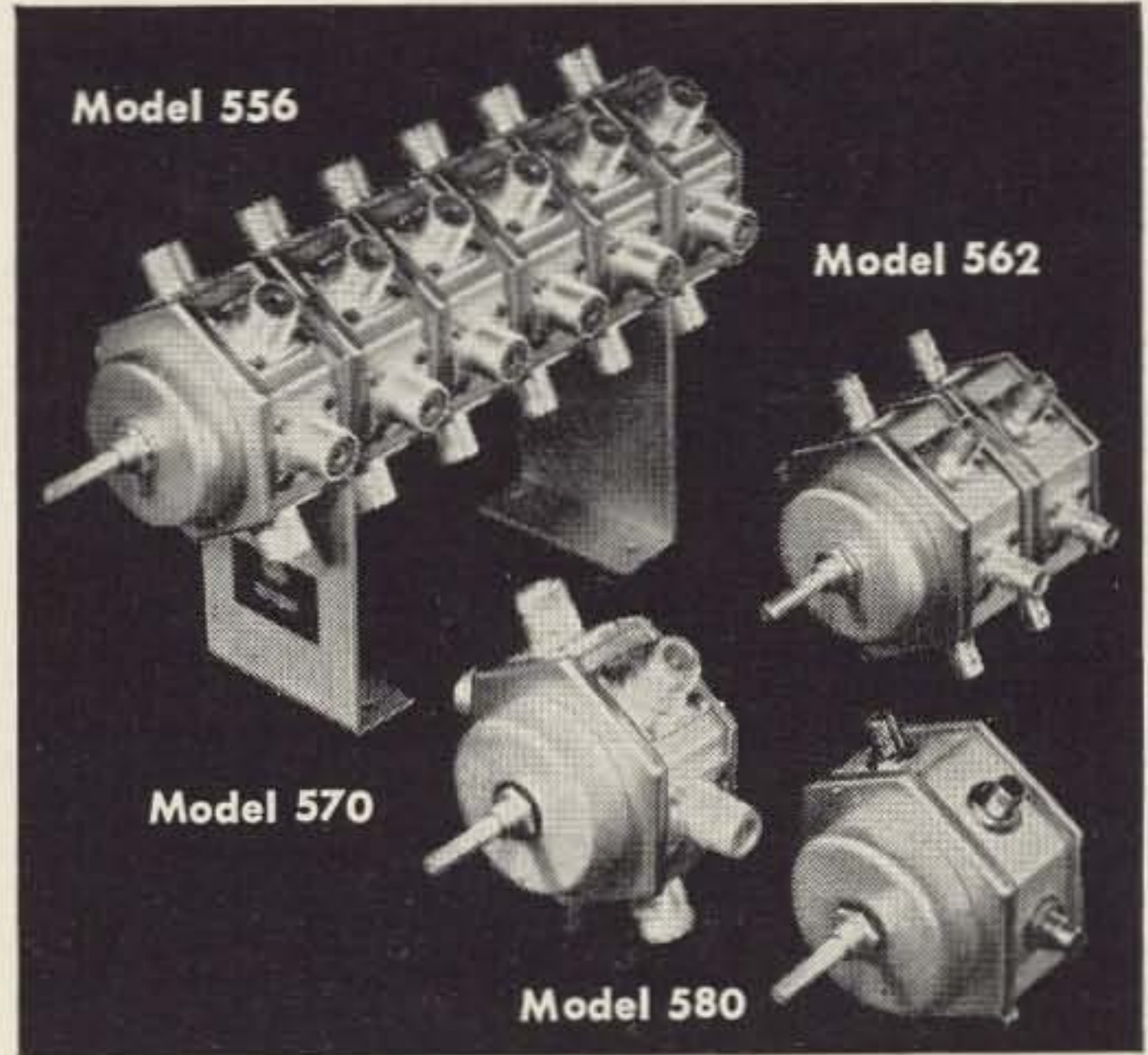

Barker & Williamson, Inc.

Bristol, Pennsylvania, STilwell 8-5581

Foreign Sales—Royal National Corp., 250 West 57th St., New York 19, N.Y.

OTHER B&W EQUIPMENT: Transmitters AM-CW-SSB • Transistorized Power Converters and inverters • Dip Meters • Matchmasters • Frequency Multipliers • Low Pass Filters • T-R Switches • R. F. Filament Chokes • Transmitting R. F. Plate Chokes • Band-Switching Pi-Network Inductors • Cyclometers • Antenna Coaxial Connectors • Baluns • Variable Capacitors • Toroidal Transformers • Fixed and Rotary edgewound Inductors • Plug-in Coils with fixed and variable links • Straight type air wound coils in a variety of dimensions.

biggest problem using this coil was that I could not tell for sure at what frequency it was oscillating. Harmonics from the oscillator leaked into the 1415 kc *if* stage making it difficult to set the injection level on the product detector. A careful check of the frequency by a Frequency Meter indicated that it was too high. Additional padder condenser brought it down to the proper frequency of 239 kc. This cleared up the last of the troubles with the receiver.

The cabinet is a LMB model W1D using a 11" x 17" x 3" chassis. The front panel was painted and striped in the same manner as my 500 watt linear amplifier that was described in a recent issue of 73 Magazine. The chrome trim on the front panel came from the dash of a junked car. The dial is one of those fine Ed-dystone units made in England. I added internal lighting by installing a pilot light at each end of the dial assembly. The pointer on the dial and the tuning meter are painted a bright red. The cabinet is a light grey, the front panel is dull black and dark grey. The dial is calibrated from 14 mc to 18 mc using the frequency meter. The remainder of the dial scales are geared to this calibration. Typical 432 mc and 1296 mc converters suitable for use with this receiver may be found in the 1963 *Radio Amateur's Handbook*.

... WØRQF



"Receiver? Now what would **she** do with a receiver?"

Heliwhip Tuning without Pruning

Frank Mohler W2IAZ
187 Broad Street
Eatontown, New Jersey

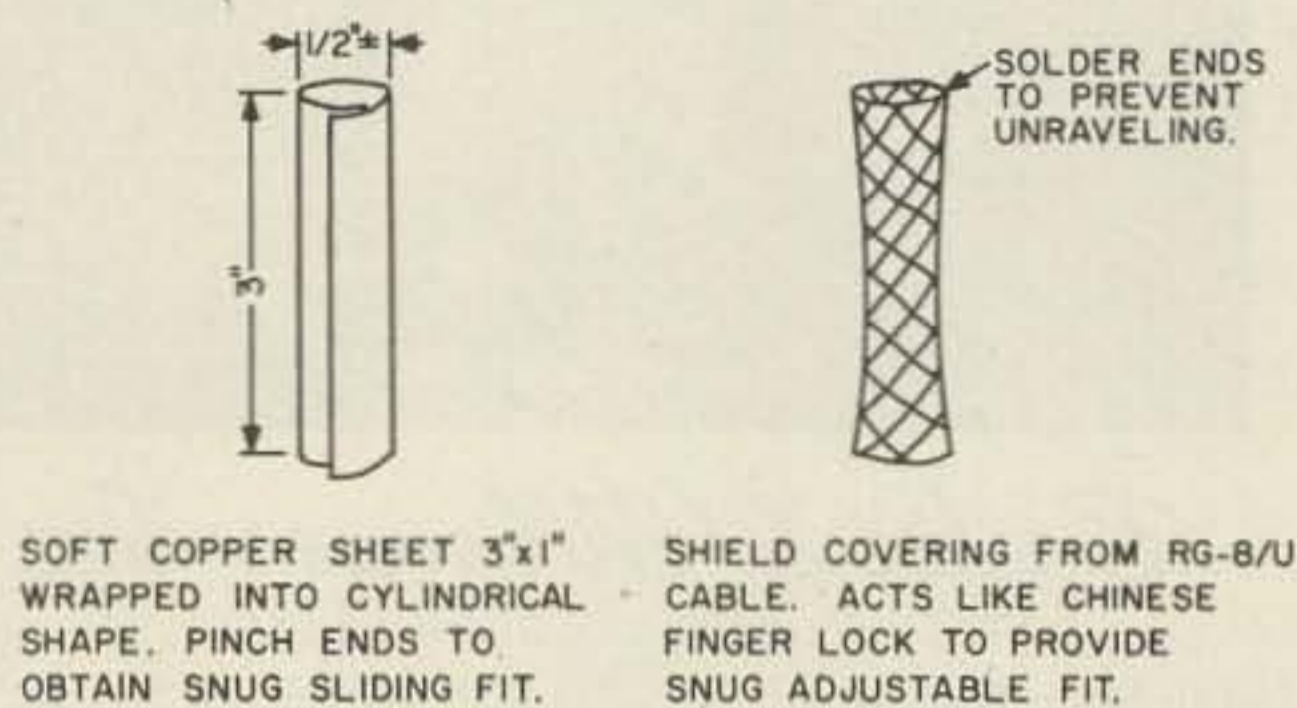

TYPES OF TUNING CYLINDERS
FIGURE 1

After using heliwhips for mobile operation during the past few months, I was able to arrive at a few conclusions you may find interesting. In the first place, the heliwhip is an efficient, high-Q antenna and offers the unique appearance. However, like base-loaded and center-loaded whip antennas, the heliwhip is frequency conscious and restricts QSY operations to a narrow portion within a band.

After a series of tests and measurements, I learned that a given heliwhip has a bandwidth that is approximately equal to 1 percent of the antenna's optimum frequency. For example, a heliwhip peaked to 3900 kc has a bandwidth of about 39 kc (.01 x 3900). Satisfactory operation with this heliwhip is therefore limited to the range of frequencies 3880 kc to 3920 kc, or roughly 20 kc either side of the optimum frequency.

The same bandwidth percentage (1%) is applicable to the other bands. For 40-meter operation, a heliwhip pruned to 7250 kc will be useful over the band 7215 kc to 7285 kc. A 20-meter heliwhip cut for 14,250 kc is good over the range 14,180 kc to 14,320 kc. When peaked to 21,300 kc, a 15 meter heliwhip permits satisfactory operation over a range of frequencies 100 kc on either side of the resonant point.

A review of the bandwidth capabilities of

each antenna reveals that a heliwhip cut for optimum operation in the middle of the band will provide adequate coverage on all bands except 40 and 75 meters. Unlike the base-loaded and center-loaded whip antennas, the heliwhip has no provisions for altering the operating frequency. After the wires of the heliwhip had been irrevocably cut, or pruned, to a desired frequency, operators accepted the sad fact that QSY operations were severely limited. However, owners of heliwhips need not be shackled to a narrow band of operation. By using the simple tuning technique described in the next paragraph, the operator can peak-tune his heliwhip antenna to any part of the band, including the cw portion at the low end and the MARS frequencies outside the high end.

Heliwhip Tuning System

Heliwhips, as you know, are made by spirally winding the wire on a fiberglass core. Because of this unique construction, heliwhips can be peak-tuned to different parts of the band in less time than it takes to tune a guitar string. All you need is a 3-inch cylinder of copper or aluminum that will fit snugly over the helical windings of the antenna. By sliding this metal cylinder up or down on the heliwhip, the resonant frequency of the antenna is lowered or raised. Fig. 1 shows two types of tuning cylinders you can make. In an emergency, alu-

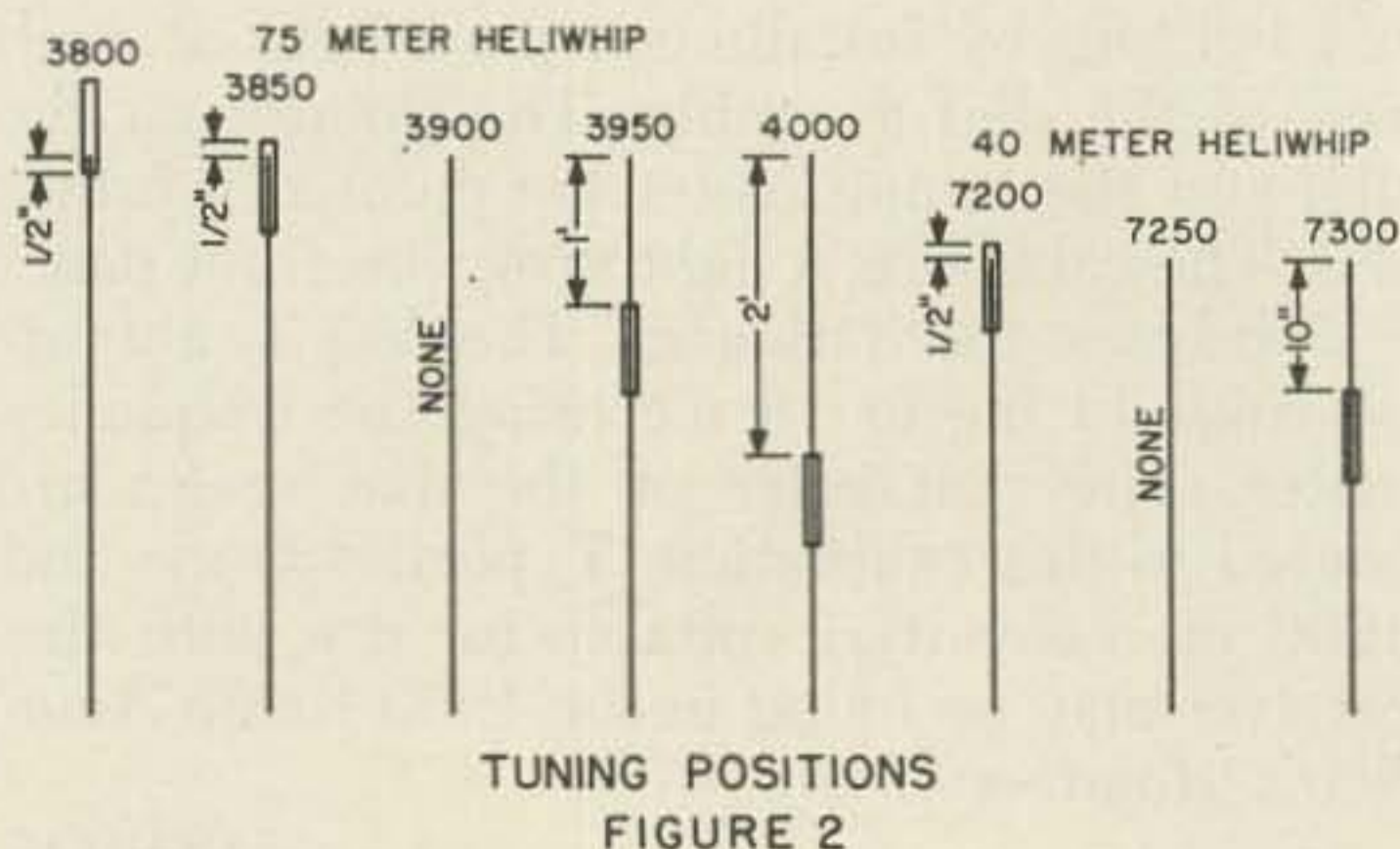

TUNING POSITIONS
FIGURE 2

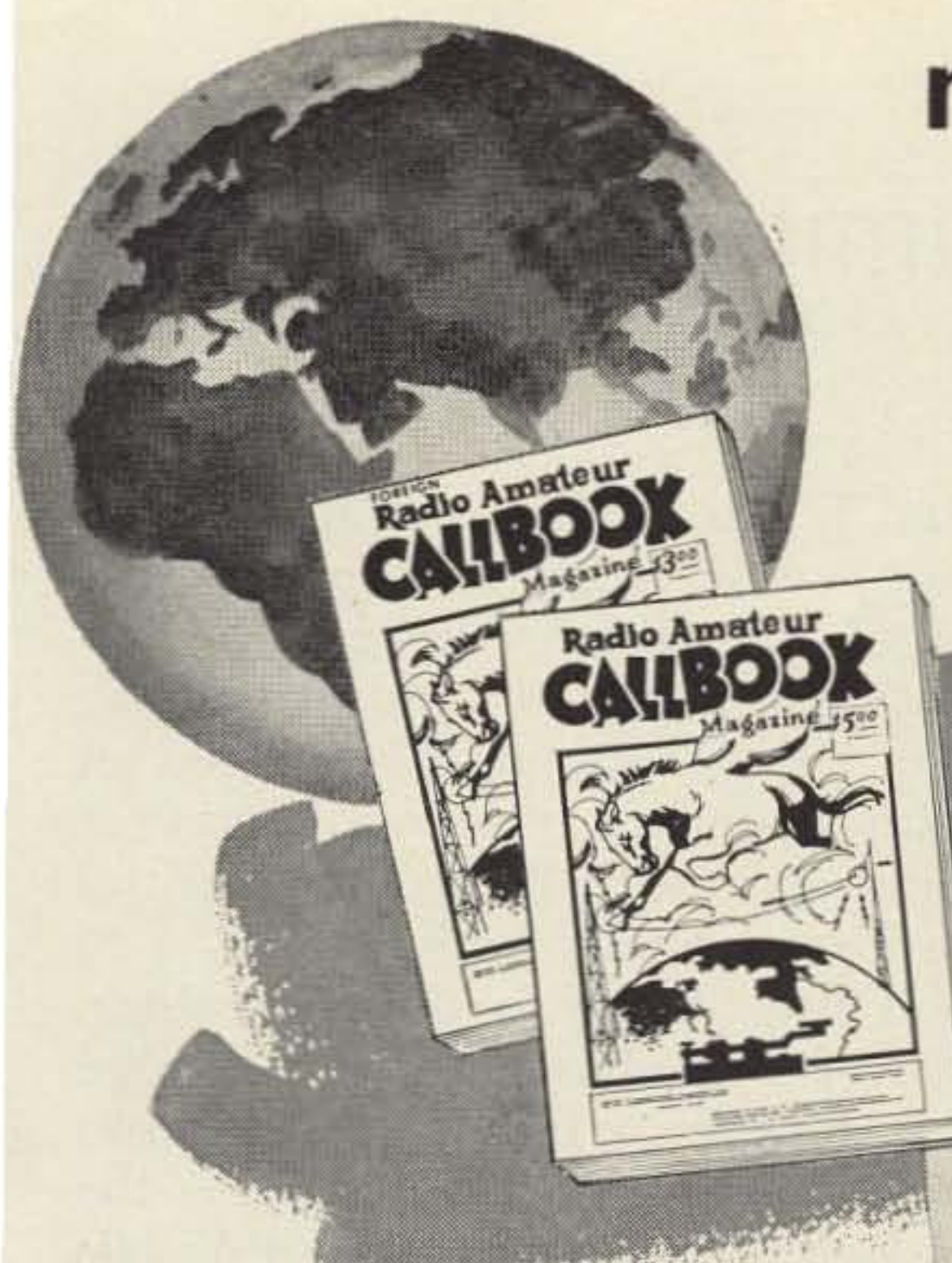

new issue just out!

the radio amateur **CALLBOOK**

Essential QTH information for all radio amateurs and SWL's. Each quarterly issue of the CALLBOOK is completely revised to bring you the most up-to-date information on QTH's.

PLUS THESE EXTRA FEATURES!

- Great Circle Bearings
- Great Circle Charts
- Prefixes by Countries
- International "Q" Signals
- World Time Chart
- International Postal Information
- And many other features

P.S. ORDER THESE VALUABLE RADIO AMATEUR GUIDES, TOO!

- Radio Amateur DX Guide—62 pages of vital data; 291 Great Circle Bearings for 22 major U.S. cities; Prefix Map, Time Conversion Table, DX Log, plus other features.....\$2.00
- World Prefix Map—Full color, 29" x 42", shows prefixes on each country . . . DX zones, time zones, cities, cross referenced tables \$1.00
- World Atlas—Only Atlas compiled for amateurs. Polar projection, six continents, prefixes on each country . . . full color, 16 pages.....\$1.00

CALLBOOK of United States Listings
(Over 250,000 K & W calls)

Each quarterly issue..... **\$5.00**

CALLBOOK of Foreign Listings (Over 100,000 calls outside the U.S.A.)

Each quarterly issue..... **\$3.00**

Write for illustrated brochure!

RADIO AMATEUR CALLBOOK

Dept. B, 4844 W. Fullerton Ave., Chicago 39, Ill.

See your favorite dealer today for your latest issue or order direct from the publisher (add 25c for mailing).

minum foil from a pack of cigarettes can be used.

The table in Fig. 2 shows the position of the tuning cylinder for each 50 kc change in the range 3800 to 4000 kc. Similar settings for the 40-meter heliwhip are also given. Present calibration marks on the heliwhip permit rapid positioning of the tuning cylinder when optimum operation on a different part of the band is desired.

Operating Notes

Newly purchased heliwhips are designed by the manufacturer to resonate at the low-frequency end of the phone band. An unpruned 75-meter heliwhip will, therefore, operate best on 3800 kc. To facilitate QSY operations within a band, I peak-tuned each antenna to the middle of the band. In this way, the amount of deviation required to tune up on either band edge is kept to a minimum.

Heliwhips provide high-Q, above-average radiation efficiency when the antenna is peak-tuned to the desired frequency. However, QSY operations are handicapped by the lack of provision for tuning the antenna to different frequencies. To overcome this advantage, while enjoying the efficiency of these unobtrusive antennas, try the "tuning without pruning" sliding cylinder. Man, it's the most!

... W2IAZ

2 ANTENNAS IN 1

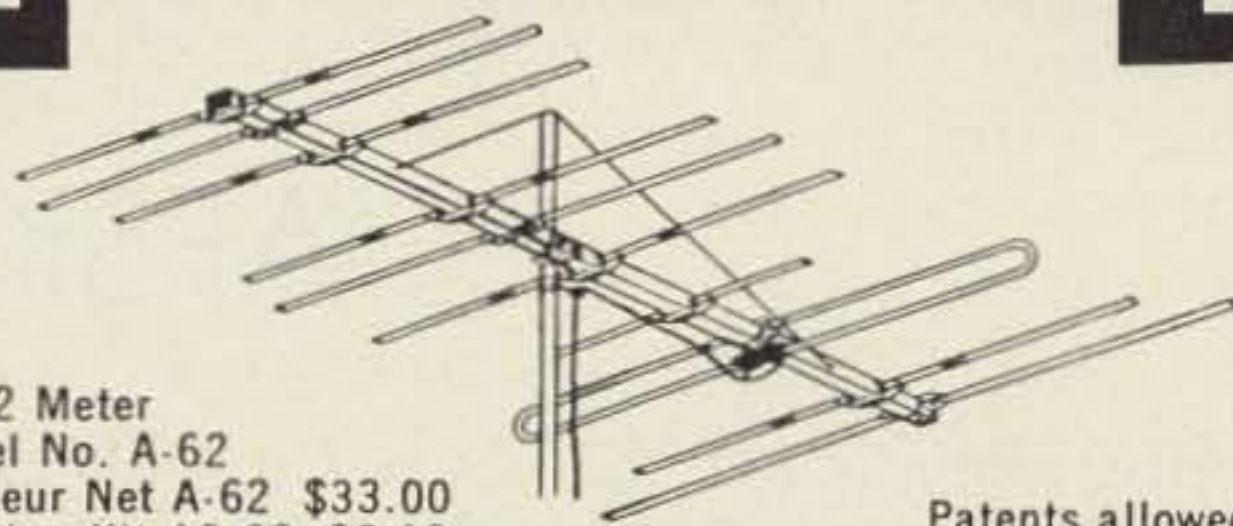

6 & 2 Meter
Model No. A-62
Amateur Net A-62 \$33.00
Stacking Kit AS-62 \$2.19

Patents allowed
and pending

**The Only Single Feed Line
6 and 2 METER
COMBINATION YAGI ANTENNA**

another first from **FINCO®**

ON 2 METERS

- 18 Elements
- 1 — Folded Dipole Plus Special Phasing Stub
- 1 — 3 Element Colinear Reflector
- 4 — 3 Element Colinear Directors

ON 6 METERS

- Full 4 Elements
- 1 — Folded Dipole
- 1 — Reflector
- 2 — Directors

See your FINCO Distributor
or write for Catalog 20-226

THE FINNEY COMPANY

Dept. 20

Bedford, Ohio

Rate of Change Limiter cont.

Shortly after receiving the September 73, I got busy and built the rate-of-change limiter by K5JKX. There were some rather obvious improvements to be made, especially to the load impedance, which I felt you might want to pass along to your readers.

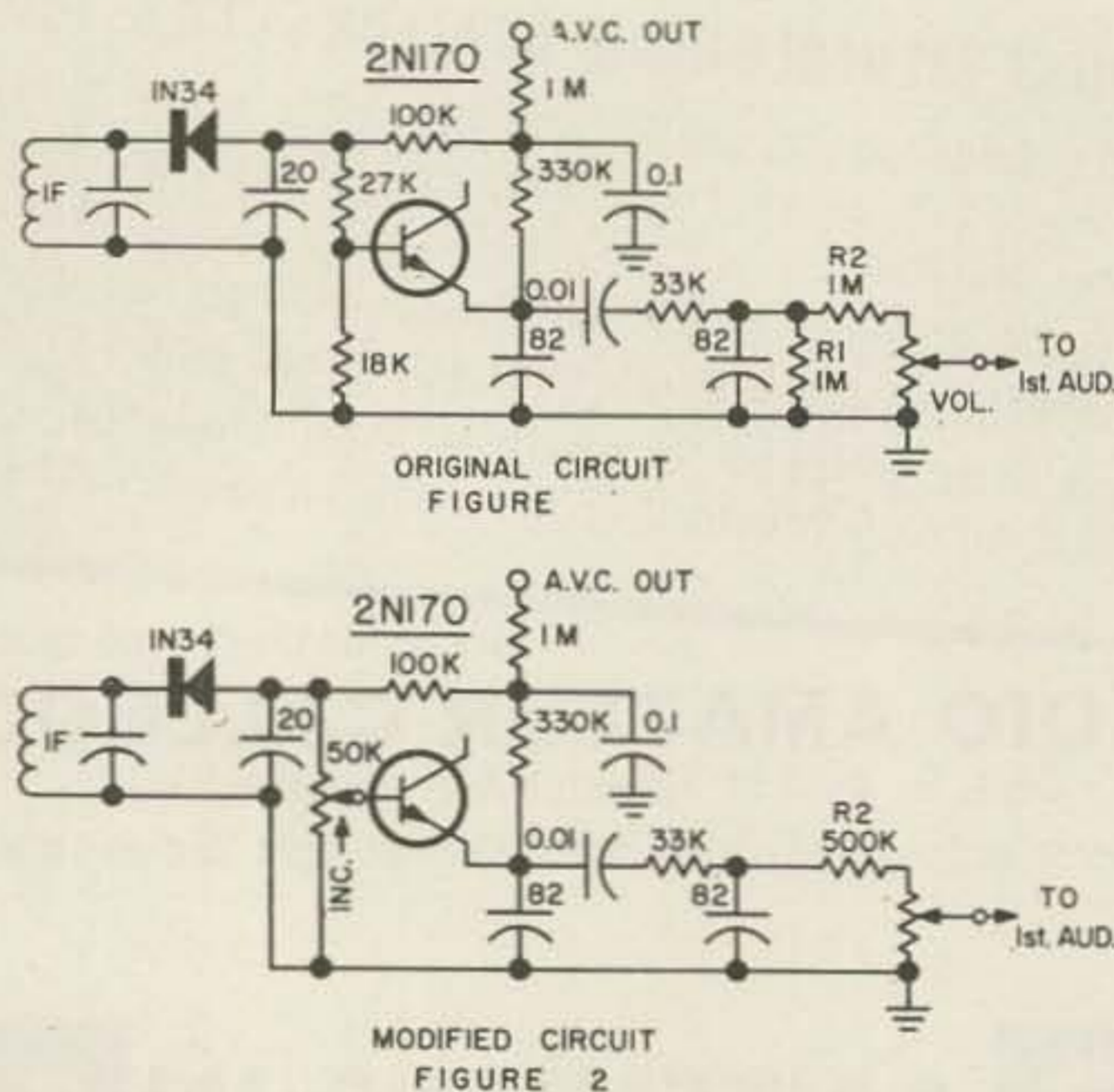

Refer to Fig. 1. The load on the limiter consists of R_1 in parallel with the series resistance made up of R_2 and the volume control. For a 500K control, this load would be 600K, not 1 megohm. If 3 volts audio appeared at the limiter output, only 1 volt would appear on the 1st audio grid with the volume control wide open; a loss of about 9 db.

As shown in Fig. 2, the fixed load resistor, R_1 , is omitted. R_2 is chosen to give a total resistance of 1 megohm when placed in series with the volume control. In this case, the limiter sees a load of 1 megohm, and 1.5 volts of the 3 volt audio would be impressed on the 1st audio grid; a loss of only 6 db. (The 6 db figure quoted by Kyle must have been for a 1meg control, in which case neither R_1 nor R_2 would have been required.)

A further refinement is the use of a 50K potentiometer in place of the 27K and 18K resistors. This allows the effective bias to be set for optimum noise suppression.

Since adding this unit to my Lafayette HE-30 receiver, I can operate with my 8 foot strip fluorescent on!

... K5HPT

AFSK Oscillator

After completing the Twin City TU AFSK oscillator, the main drawback was that the space tone (2975 cycles) was 50 percent lower in level than the mark tone (2125 cycles). All kinds of equalizing configurations were tried to no avail. Finally a 30K-ohm 1 watt resistor was shunted across the toroid coil L1, to equalize the Q when the IN54's were switched to mark and space tones. Sure enough this method resulted in a considerable improvement between the level of the two tones.

The correct value of resistor depends on how active the circuit is oscillating. Choose a value between 25 and 40K-ohms that will allow the least resistance to be shunted across L1 and still not cause the oscillator to be sluggish by oscillating intermittently.

Now the reports on VHF AFSK are amazing with only a 1 db difference or less between the mark and space tones resulting in a marked improvement with stations reporting solid copy

—plus the ability to work more DX. The same approach works equally well with other AFSK circuits.

... K4GRY

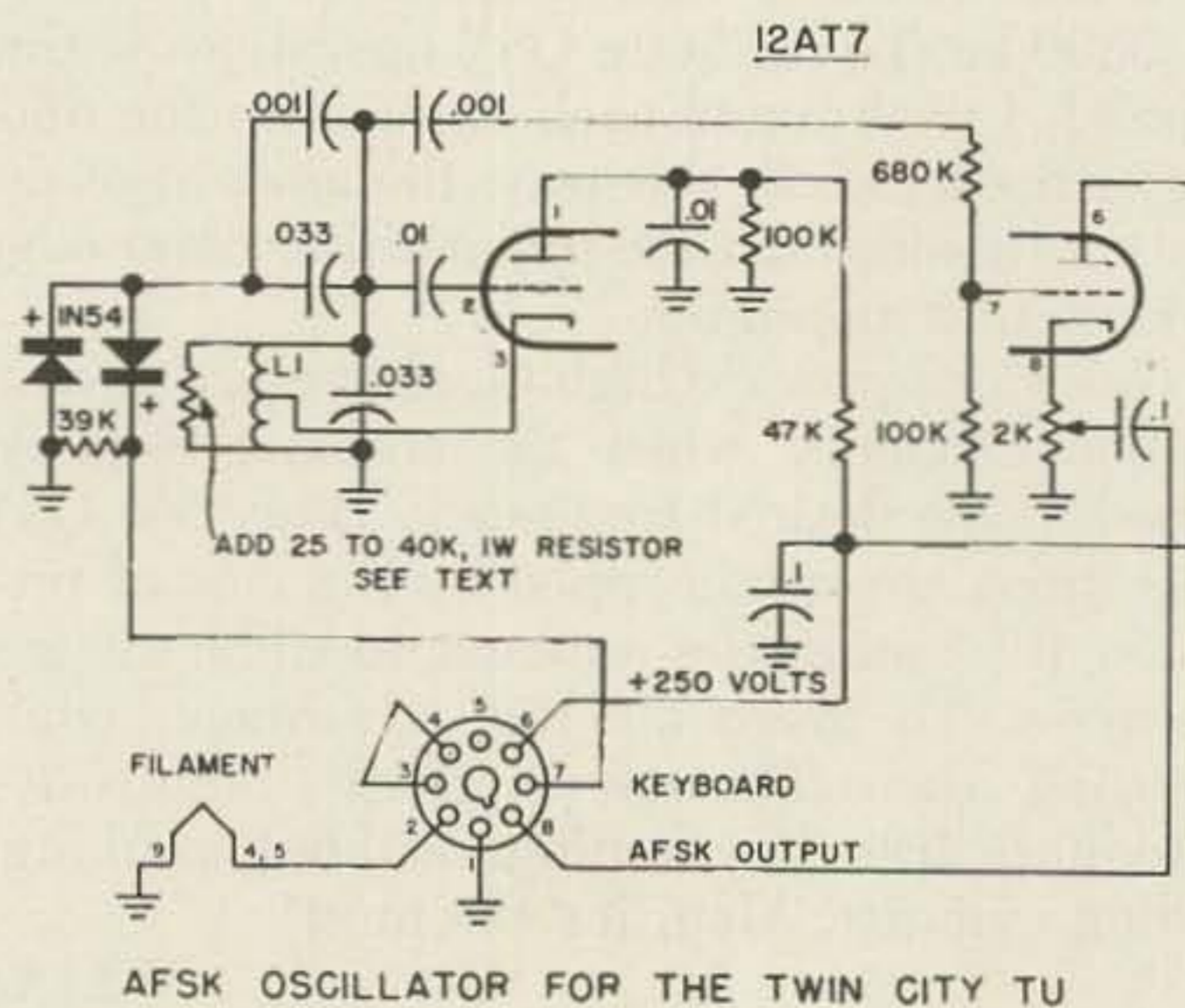

KTV

A SELF-SUPPORTING TOWER UP TO 70 FEET!

The new KTV 1600XX series of communications towers can be installed up to heights of 70 feet withing guying! The 16" wide ten foot long tower sections are joined by double welded-on sleeves on each of the three legs, making one of the strongest tower leg joints ever achieved and avoiding the usual difficulty of the jamming of tower sections. This also avoids the weakness created by holes in the structural members.

The vertical sections are made of 1" diameter 14 gauge steel tubing and the cross ties are 16 gauge tubular steel, wrapped around the vertical tubing every 12" and welded. Any tendency to twist is prevented by the 5/16" continuous XX steel rods which are welded inside the triangular structure. The end product is a tower that is strong enough to support a tribander easily at 50' without guys. This tower can be run as high as 250' with guying every 40' above 65'.

Order your tower direct from this ad or, if you have any special problems or questions, drop us a line.

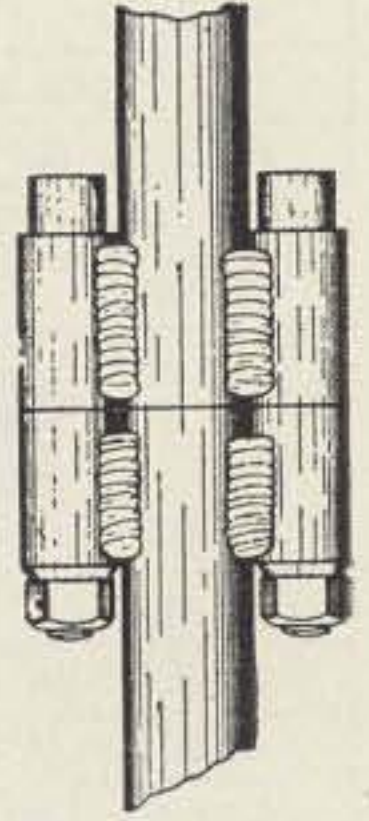
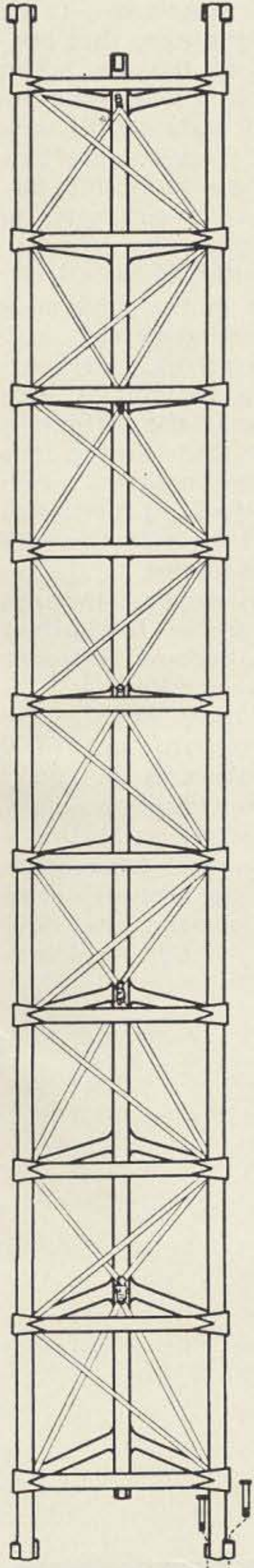

HY-TRACK

KTV is the only manufacturer of the Hy-Track, an assembly which bolts to your KTV (or other make) tower and allows you to crank your complete rotator and beam up and down the side of the tower in seconds. The Hy-Track consists of a set of rails and a rotator platform and mast bearing which move up and down the rails. On guyed towers it is a simple matter to loosen the guys and lower the beam . . . you don't have to worry about the KTV tower because it is designed to be self-supporting up to 70'. The Hy-Track is particularly handy if you don't want to have to climb up and down your tower to make changes in your antenna, or if you are interested in avoiding the shortage of life that frequently accompanies falling off towers and heart attacks. The complete Hy-Track assembly, all set to go, costs \$189.50 to fit on a 30' tower. Add \$20 for each extra ten feet of tower. The basic assembly weighs 60 lbs. plus 20 lbs. for each extra ten foot section.

PRICES

Figure that each ten foot section of 1600XX tower costs \$40.00 and weighs 50 pounds. The short 42" top section is \$20 with a 1 1/4" or 2" mast hole (specify) and \$23 with a 2 1/2" or 3" mast hole. For other size masts write for prices. The rotor mount plate is adjustable and can be placed at any level to match your mast length. It is suitable for the popular rotators such as the Ham-M, CDR, and Hy-Gain. Special plates are available for other rotors. All tower sections are made of 14 gauge galvanized steel.

Base for mounting tower in concrete	\$26.00	20 lbs.
Angle roof mount	\$26.00	20 lbs.
Three foot roof mount for flat roofs	\$32.00	46 lbs.
Wall bracket	\$18.50	12 lbs.
42 gauge galvanized screw anchors	\$ 7.50	7 lbs.
3/16" aircraft cable 1500 lb. test	ft. .20	65 lbs./M
Cable clamps	.20	
Tower bolts	.30	
10' 1 1/4" 16 gauge mast tube	\$ 5.00	9 lbs.
10' 1 1/4" galvanized pipe	\$ 9.00	16 lbs.
Erection fixture (jin pole)	\$28.00	30 lbs.

KTV Towers

Sullivan, Illinois

Propagation Charts

For DX work we will usually find that when working on the proper frequency the best signals are to be found during that portion of the day when the sun is shining on both ends of the circuit. The poorest signals are found just before the sun sets, or rises, on the Western terminal of the circuit. This is the frequency transition period.

During summer, when twilight is prolonged, the effect is least but during the winter months when the twilight period is short the effect can be quite severe.

As we pass through September this effect will become increasingly manifest.

During even quite severe disturbances DX signals can be good during the daylight hours but go bad near the sunset hour often not to return until daylight the next day.

J. H. Nelson

EASTERN UNITED STATES TO:

GMT-	00	02	04	06	08	10	12	14	16	18	20	22
ALASKA	20	40	40	40	40	40	40	40	20	20	20	20
ARGENTINA	15	20	40	40	40	40	20	15	15	15	15*	15*
AUSTRALIA	15	20	40	40	40	40	40	40	40	40	20	15
CANAL ZONE	20	40	40	40	40	40	20	20	20	15	15	15
ENGLAND	40	40	40	40	40	20	20	20	20	20	20	20
HAWAII	15	20	40	40	40	40	40	40	20	20	20	20
INDIA	40	40	40	40	40	40	20	20	20	20	20	40
JAPAN	20	40	40	40	40	40	40	40	40	40	40	20
MEXICO	20	20	40	40	40	40	40	20	20	20	15	15
PHILIPPINES	20	20	40	40	40	40	40	40	40	40	40	20
PUERTO RICO	20	40	40	40	40	40	20	20	20	20	15	15
SOUTH AFRICA	20	40	40	40	40	20	20	20	15	15	15	20
U.S.S.R.	40	40	40	40	40	40	20	20	20	20	20	40

CENTRAL UNITED STATES TO:

GMT-	00	02	04	06	08	10	12	14	16	18	20	22
ALASKA	20	20	40	40	40	40	40	40	40	20	20	20
ARGENTINA	15	20	20	40	40	40	20	15	15	15	15*	15*
AUSTRALIA	15	15	20	40	40	40	40	40	40	40	20	15
CANAL ZONE	15	20	40	40	40	40	20	15	15	15	15	15*
ENGLAND	40	40	40	40	40	40	20	20	20	20	20	20
HAWAII	15	15	20	40	40	40	40	40	20	20	20	15
INDIA	40	40	40	40	40	40	40	20	20	20	20	20
JAPAN	20	20	40	40	40	40	40	40	40	40	20	20
MEXICO	20	20	40	40	40	40	40	20	20	20	20	20
PHILIPPINES	20	20	40	40	40	40	40	40	40	40	40	20
PUERTO RICO	20	20	40	40	40	40	20	20	15	15	15	15
SOUTH AFRICA	20	40	40	40	40	40	20	20	20	20	15	20
U.S.S.R.	40	40	40	40	40	40	40	20	20	20	20	40

WESTERN UNITED STATES TO:

GMT-	00	02	04	06	08	10	12	14	16	18	20	22
ALASKA	20	40	40	40	40	40	40	40	40	40	40	20
ARGENTINA	15	20	20	40	40	40	40	20	15	15	15	15*
AUSTRALIA	15	15	20	20	40	40	40	40	40	40	20	15
CANAL ZONE	15	20	40	40	40	40	40	20	20	15	15	15
ENGLAND	40	40	40	40	40	40	40	20	20	20	20	40
HAWAII	15	15	20	20	40	40	40	40	20	20	20	15
INDIA	20	20	40	40	40	40	40	40	20	20	20	20
JAPAN	20	20	20	20	40	40	40	40	40	40	20	20
MEXICO	20	20	40	40	40	40	40	20	20	20	20	15
PHILIPPINES	20	20	20	20	40	40	40	40	40	40	40	20
PUERTO RICO	15	20	40	40	40	40	40	20	20	20	15	15
SOUTH AFRICA	20	40	40	40	40	40	40	20	20	20	20	20
U.S.S.R.	40	40	40	40	40	40	40	40	20	20	40	40

*Possible 10 meter openings on Es dates.

Es means the possibility of a high MUF and/or freak conditions.

PROPAGATION FORECAST

DATE	1	2	3	4	5	6	7	8	9	10	11	12	13	14	15	16	17	18	19	20	21	22	23	24	25	26	27	28	29	30	
GOOD																															
FAIR																															
BAD																															
Es																															

☐ = INDICATES PREVALENT CONDITIONS

15 KC BANDPASS



OVER THE
.54 TO 31.5 MC
FREQUENCY RANGE

IN THE *New*

GPR-91 RXD COMMUNICATIONS RECEIVER

This new GPR-91RXD Communications Receiver has all of the features — selectivity, sensitivity and reliability — of our GPR-90RXD receiver.

AND IN ADDITION has 15 kc bandpass for ISB reception of four discrete voice channels or up to 64 teletypewriter channels, when used with our Model SBC-2, Sideband Converter.

Two of these receivers, with common oscillators, such as TMC Model VOX-5, (see line illustration at left) make one of the finest diversity receivers available on the market today.

Our engineering department will be happy to discuss ancillary equipment in our general catalog that may be used with this receiver to fill any of your requirements.

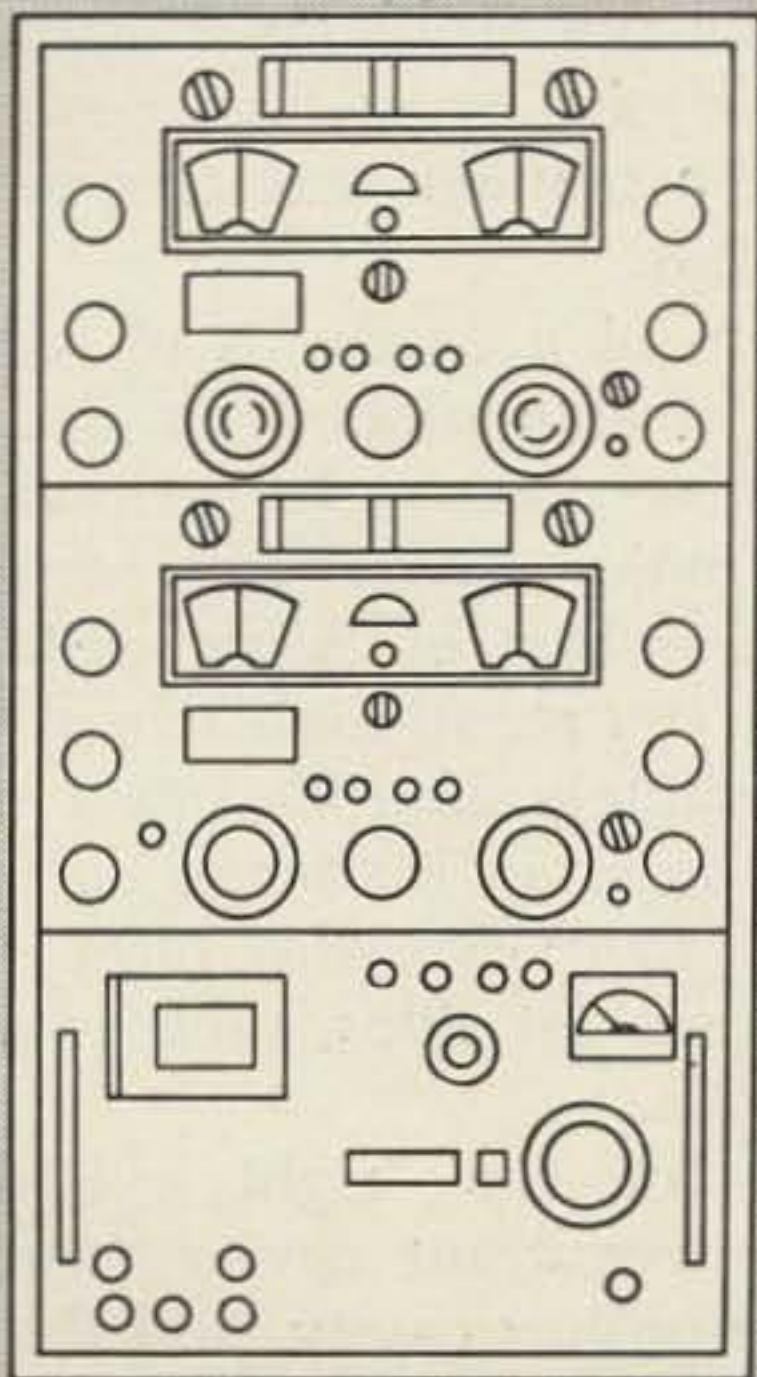

Request TB 3009

**THE TECHNICAL MATERIEL
CORPORATION** MAMARONECK, N. Y.

and Subsidiaries OTTAWA, CANADA • ALEXANDRIA, VA. • GARLAND, TEXAS • OXNARD, CALIF. • SAN LUIS OBISPO, CALIF. • POMPANO BEACH, FLA. • LUZERN, SWITZERLAND

UHF Cavity Design

Jim Kyle K5JKX
1236 N. E. 44th
Oklahoma City 11, Okla

While thousands of published words have been expended on the subject of tank-circuit design for the lower frequencies, we've seen almost nothing in print in the ham magazines concerning design of cavities for UHF use. But with the rapidly growing move to ever higher frequencies, some idea of how to design a cavity is essential for the do-it-yourselfer.

"Why design a cavity?" you may ask, and the question is in order. The first answer is that you almost have to design one when you need it since they are not off-the-shelf items, and published designs (even) are few and far between. On top of that, any published design is almost useless to you unless you are using the exact same circuit and components—since cavity dimensions depend on a whole flock of variables, not just upon frequency alone.

So let's proceed into the only-partially-charted byways of the UHF regions, and take a look at how to design cavities:

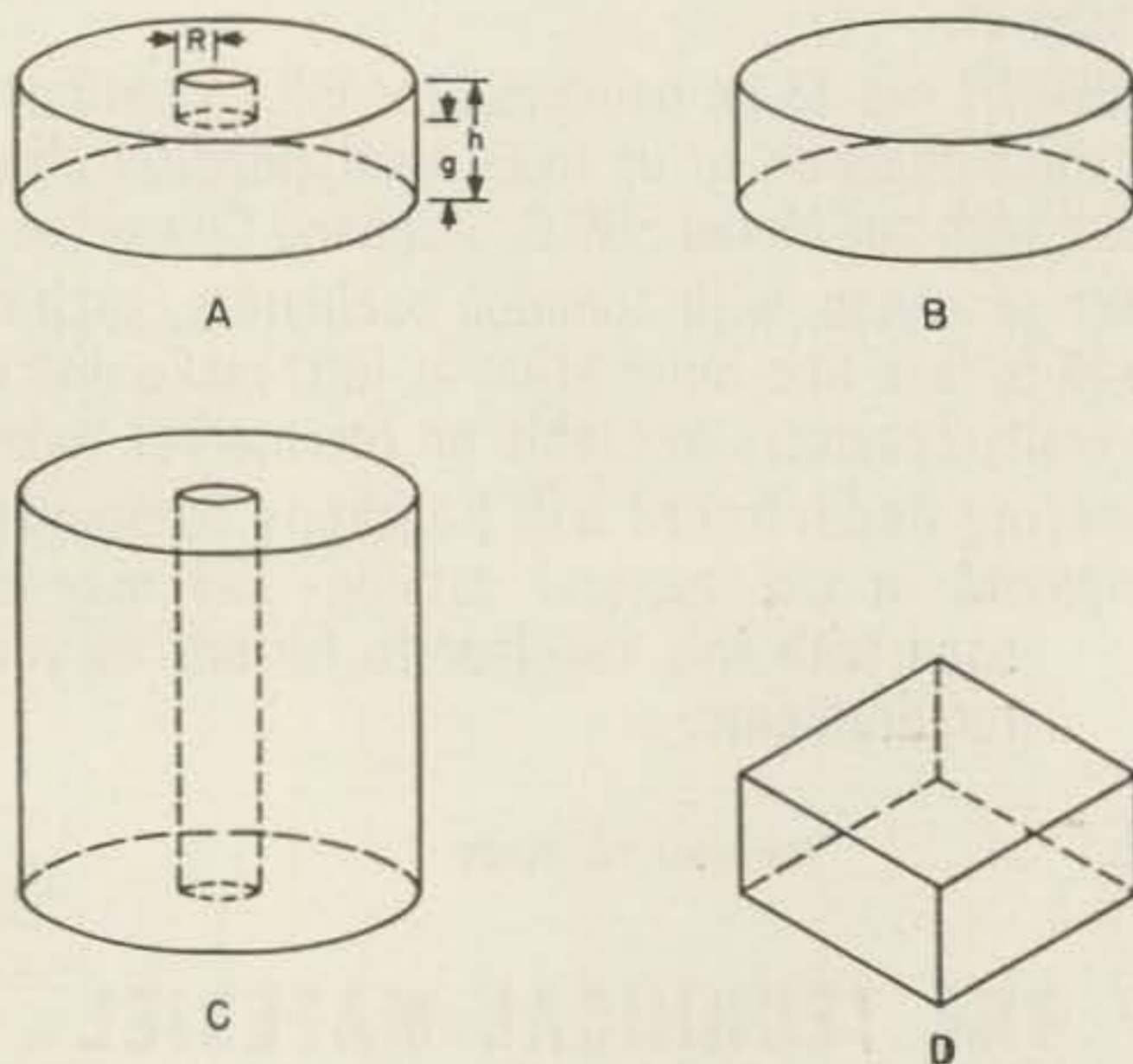

TYPES OF CAVITIES
FIGURE 1

A good first step would be to examine just what a cavity is. By definition, a cavity is *any* space fully enclosed by conductive material. The shape of the space is immaterial, but will influence the frequencies of resonance. The cavity will be resonant at every frequency at which any dimension is an integral number of half-wavelengths—and it follows automatically that every cavity has an infinite number of possible resonant frequencies.

However, this seemingly discouraging fact is of little immediate concern, because for our purposes we are using the cavity either as a filter or as a tank circuit, and in either case we are going to supply energy at a frequency which is at least approximately known. So long as only *one* of the infinite number of possible resonant frequencies is within the area we want to use, we will have no trouble.

Of course, should the cavity also be resonant to a low-order harmonic of our intended frequency, we might have problems. Fortunately, the most practical design types have resonances separated in such a manner that this problem seldom if ever arises.

By our definition of a cavity, it includes all shapes. However, design procedures differ for the different possible shapes. In general, they boil down to two major classes, with some subgroups. One class is that of "right cylindrical cavities," which if you recall high school geometry will be immediately identified as a section of circular pipe; the other is that of "prismatic cavities", which in more everyday terms means a closed box with six flat sides, such as a cube or a covered chassis.

The subclasses of the "right cylindrical" group include the reentrant cavity (the most general type), the pillbox cavity, and the coaxial line. The reentrant consists of a tube closed at each end, with a concentric post inside. A

DRAKE MODEL **TR-3** SIDEBAND TRANSCEIVER



Dimensions: 5½" high,
10¾" wide, 14¾" deep.

\$550⁰⁰
AMATEUR NET

FULL FREQUENCY COVERAGE all amateur bands 10 thru 80 meters
UPPER and LOWER SIDEBAND on all bands
VOX or PTT
OUTPUT IMPEDANCE ADJUSTABLE with pi-network
300 WATTS P.E.P. on SSB
CONTROLLED CARRIER SCREEN MODULATOR for AM built-in
SHIFTED CARRIER CW, 260 watts input
TWO SPECIAL 9 Mc CRYSTAL FILTERS for sideband selection
LINEAR PERMEABILITY TUNED VFO
SEPARATE RF and AF GAIN CONTROLS
FULL AGC with Drake dual time constant system
2.1 KC PASSBAND
100 KC CRYSTAL CALIBRATOR built-in
SEPARATE RECEIVER S-METER and TRANSMITTER PLATE AMMETER
ONLY ONE DPDT RELAY USED — RF switching limited to antenna

Due to the 300 watt P.E.P. input rating, the TR-3 will require a power supply capable of low voltage at high current with very good dynamic regulation.

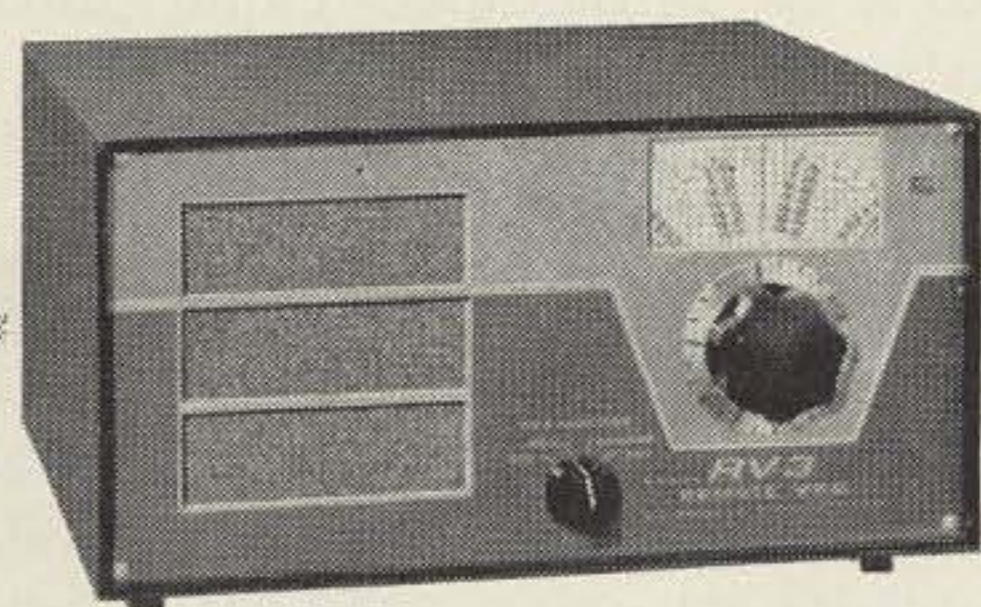

REMOTE VFO

Model RV-3 . . . \$79.95

Consists of same VFO as TR-3, cathode follower, voltage regulator and required control circuitry to permit reception, transmission, or transceiver operation on a separate frequency in the same band to which TR-3 is tuned. Includes 5-inch speaker, 3-foot interconnecting cable and space for AC Power Supply.

Dim: 5¾" h, 10¾" w, 11½" d.

RV-3 makes an ideal all-band transmitting VFO for 10B, 20A, and similar 9 MC exciters.

Write for Free TR-3 Brochure and list of Authorized Distributors.

R. L. DRAKE COMPANY
BOX 185-AC • MIAMISBURG, OHIO, 45342

TR-3 ACCESSORIES

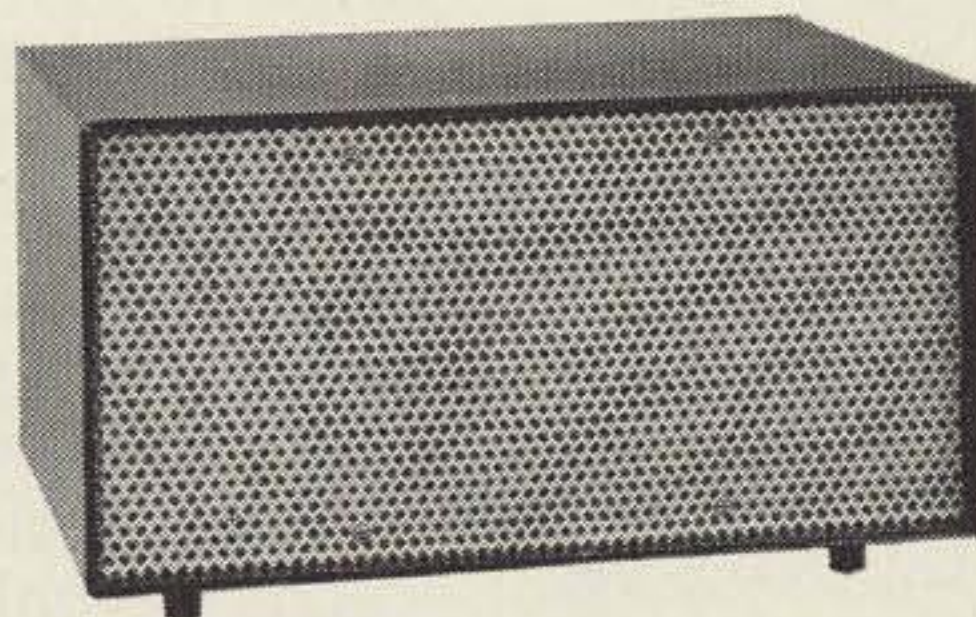

MATCHING SPEAKER

Model MS-3 . . . \$19.95

Contains a 5 x 7 inch heavy magnet speaker.

Styled to match TR-3 Transceiver.

Dim.: 5¾" h, 10¾" w, 11½" d.

POWER SUPPLIES

AC Power Supply
Model AC-3 \$79.95

Will mount in rear of MS-3 and RV-3 cabinets.

Dimensions: 5" x 5" x 10¼".

DC Power Supply
Model DC-3 \$129.95

MMK-3
Mobile Mounting Kit
\$6.95

Contains brackets and hardware for under-dash or hump mounting.

“gap” is left between the end of the post and the far wall of the tube. Fig. 1-A shows a perspective drawing of a reentrant cavity.

The pillbox cavity may be thought of as the limiting case of a reentrant, in which the gap has been increased until it extends the full length of the cavity. Similarly, the coaxial line forms the other extreme, in which gap spacing drops to zero and the center “post” is connected to each end plate. Fig. 1-B shows a pillbox cavity, while the coaxial line is sketched in Fig. 1-C.

The prismatic cavity is shown in Fig. 1-D. Though it is easier to build one of these, the design techniques are so involved that we won't go into them here. Frequently, once design of a reentrant cavity is completed, you can transform it into a prismatic cavity of square cross-section without extreme difficulty. This, however, does not always hold true—if you try it after reading this, it's at your own risk.

Having met the four most common types of cavity (even though three are of the same general type, it's more common to speak of them as separate types for reasons which will become apparent as we continue); let's see how they work.

The job of a cavity is to determine frequency, and it does this by virtue of its dimensions. Detailed explanation of just *how* it does this leads us directly into Maxwell's field equations, complete with partial derivatives, so if you're interested we pass you to the references for details. What we're interested in here is the manner in which dimensions determine the frequency.

Most UHF enthusiasts are already familiar with the resonant line section and half-wave repeater. Briefly, a quarter-wave section of coaxial transmission line shorted at one end and open at the other acts like a tank circuit. Similarly, a half-wave section shorted at both ends also acts like a tank. This half-wave section is actually a coax-line cavity; in this case the length of the line is determining the resonant frequency of the cavity.

As we change the coaxial-line cavity to a reentrant type by introducing the gap at one end, and maintain the gap spacing constant, we will find that to hold the same resonant frequency the line must be shortened. As we shorten the line still more, keeping the frequency constant (as well as the gap spacing), we find that the diameter must be increased to maintain resonance.

When we reach the other extreme of the pillbox cavity by this process, in which the length (now called height since it is so small

in comparison to some other dimensions) is the same as the gap spacing and the center post disappears, we will find that the resonant frequency is now controlled entirely by the *diameter* of the cavity. Under these conditions, we can make the height almost anything we want within reason and the resonant frequency will remain the same!

Thus we have seen that in the coax-line cavity the frequency is determined by length with diameter making little difference, while in the pillbox it's the diameter that counts and height has little effect. But how about that in-between reentrant that we sort of skipped over?

It's a complex problem, since in the reentrant four variables all work together to determine the resonant frequency. If any three are kept unchanged, the fourth will determine the frequency. But if two are varied at the same time, the frequency *may* just sit still! These variables are the cavity diameter, the post diameter, the gap spacing, and the height (or length).

At this point, let's pause for a moment and see how the characteristics of any tank circuit may be described. The usual specification at low frequencies is by inductance, capacitance, and load resistance (the last is not always specified as such but is inherent in any application). However, the tank can also be specified by resonant frequency, Q , and shunt resistance—a means of specification which is gaining in popularity as more homebrewers acquire grid-dippers. “Tune to resonance at 50 mc” is a not uncommon thing to see on a schematic these days.

In the cavity region, induction and capacitance tend to lose their meanings since they do not relate directly to any dimension. About the only way to specify a cavity is by resonant frequency and Q .

We have seen how certain dimensions control the resonant frequency. How about Q ?

The Q (unloaded Q , that is) of a cavity depends primarily upon the rf conductivity of the material from which the cavity is made and upon the frequency of operation. However, it may be severely degraded by unwise choice of dimensions for the cavity.

For instance, we have seen how in the pillbox cavity the frequency is determined entirely by the diameter and that height is almost immaterial. But height of the pillbox can have an important effect on cavity Q .

It's almost obvious that if the height is reduced to zero the Q must also become zero, since the cavity as such ceases to exist. Actually, Q will have its maximum value with an infinitely high cavity—but this is scarcely practi-



I'M USING A NEW CONCEPT
IN CIRCUIT DESIGN...



.. SMALL SPRINGS FACILITATE
EASY PART-REMOVAL ...OOPS!

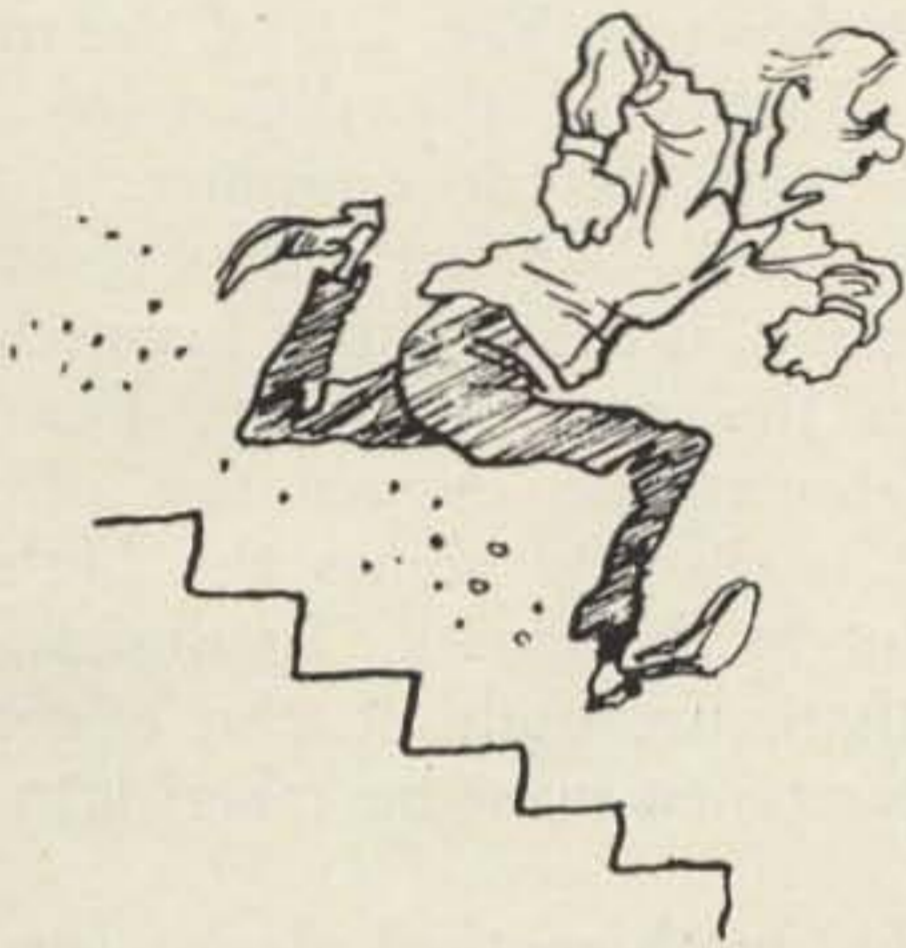

THAT POWER XSTOR COST ME \$15!



LADY, MAY I GET MY TRANSISTOR
OFF YOUR HAT?



SOMETIMES EXPLANATIONS
ONLY CONFUSE THE ISSUE

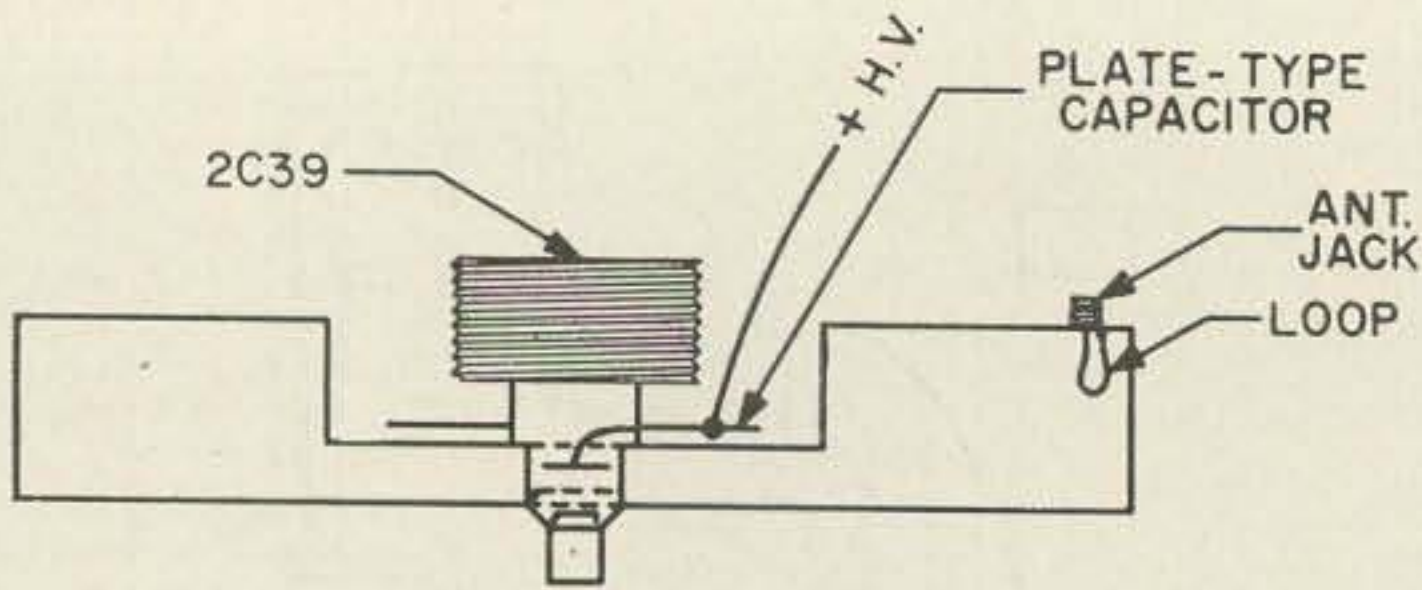

TUBE IN REENTRANT CAVITY
FIGURE 2

cal. It will still have half of this maximum value when the height is reduced to 0.192 wavelength. Therefore, if the height is kept greater than 1/5 wavelength it will do little harm to the Q of the cavity.

As height decreases, so does Q—but not in a straight-line manner. To reduce the Q to one-tenth of its theoretical maximum value, the height would have to be reduced to 0.021 wavelength. Since this represents a cavity only about 3/4 of an inch high at 300 mc, where the diameter would be about 30 inches, and since a Q of one-tenth maximum would still be in the neighborhood of 1,000, you can see that any reasonable height is satisfactory from a Q standpoint.

Similar conditions prevail in the coax-line cavity. Here, Q will be at its maximum for a certain definite ratio of conductor diameters, which gives a characteristic impedance of 77 ohms. With this ratio fixed, the Q will be maximum when cavity diameter is infinite, and will approach zero as the diameter approaches zero. However, again, within practical limits the diameter (and even the ratio of diameters) is immaterial.

In the reentrant cavity, all the factors which affect frequency also have their effects upon cavity Q. Due to the interactions between the four variables, little can be given concerning the ways in which these effects show up. However, in practice all will be negligible.

All the foregoing, of course, assumes that the interior surface of the cavity possesses good rf conductivity. If you build a cavity out of nichrome, naturally its Q will be way down. But with 5-mil silver plating, Q values will be far greater than you have been used to seeing at the lower frequencies. A Q of 1,000 would be astronomical for a conventional coil—it's considered pretty low for a cavity!

And up to this point our discussion has concerned unloaded cavities. They're nice from a theoretical point of view because nothing from outside the cavity has any effect—but for the same reason they are useless. To make use of a cavity in any way, we must load it in some

way, either by coupling it into a transmission line to act as a filter, or by coupling it to the plate of a tube to act as a tank circuit.

Coupling to any cavity may be accomplished in either of two ways: electric coupling, by use of high-impedance capacitive coupling to its electric field, or magnetic coupling, an inherently low-impedance technique for coupling to the magnetic field of the cavity.

Electric coupling is accomplished by either inserting a probe (or miniature antenna) into the cavity at a high-impedance point in the cavity, or by placing an electron tube across the highest-impedance point in the cavity so that its plate is connected to one side of the cavity and its cathode to the other. An example of this latter type of coupling is shown in Fig. 2. The ease of this type of coupling makes the reentrant cavity a natural for tank-circuit use.

Magnetic coupling is accomplished by inserting a loop into the cavity; the usual place is near a corner or across one end. The antenna coupling circuit shown in Fig. 2 is of the magnetic variety, illustrating the difference between magnetic and electric coupling.

Not yet discussed, but very important in actual cavity design, is the effect of lumped capacitance upon the cavity's action. For example, the plate-cathode capacitance of the tube in Fig. 2 is directly across the highest-impedance point in the cavity. To design the cavity rather than just build it, the effect of this added capacitance must be taken into account.

Unfortunately, mathematical design procedure for cavity resonators takes no account of the exact effects of such lumped capacitances except in the special case of the coax-line cavity. In the coax-line, the effect of lumped capacitance is to electrically lengthen the line. The resulting effect is expressed by the formula shown in Fig. 3, which states that the effective line length of the line itself in electrical degrees is equal to the angle whose tangent multiplied

FOR RESONANCE:

$$X_c = Z_0 \tan L$$

Given C and L:

$$f = \frac{0.159}{C \cdot Z_0 \cdot \tan L}$$

where f is in Mc if
C is in μf and Z_0
is in ohms

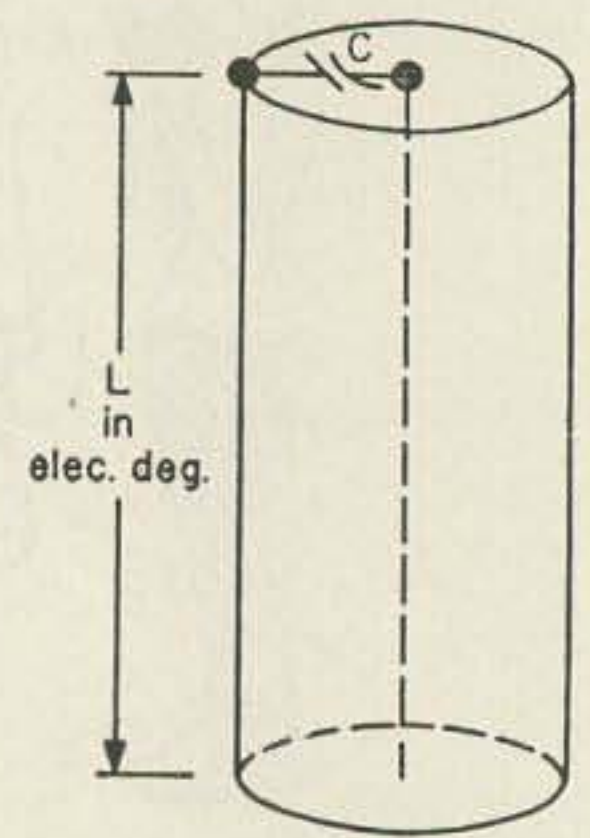

LOADING A COAX CAVITY
FIGURE 3

TABLE I—Thermal Qualities of Some Cavity Materials

Material	Expansion Coefficient PPM/degree F	Frequency Change in cps/mc/degree F
Steel	6	6
Copperclad Steel	7	7
Copper	10	10
Yellow Brass	11	11
Aluminum	13	13

by the line impedance is equal to the capacitive reactance of the lumped capacitance. Or, in simpler language, the line is tuned to a lower frequency which can be calculated.

Addition of lumped capacitance to the other types of cavity resonators also lowers the resonant frequency, but calculation of the exact amount by which the frequency is lowered is a much more difficult problem. The most practical way for the homebrew ham to take this factor into account is to design the resonator for a frequency approximately double that which he desires, then load the cavity with additional capacitance after tubes are installed until it resonates at the desired point.

This specific factor—lack of knowledge concerning the exact effects of capacitance loading upon the characteristics of a cavity—is one of the biggest drawbacks in cavity design today. It makes successful design of a “ring amplifier” a tedious, cut-and-try process instead of the simple procedure it at first appears to be. Some of the more ambitious UHF men, such as K2TKN, have gone to the lengths of building specialized laboratory test equipment in attempts to learn more about these factors; their results will be interesting and useful.

Before moving on to discuss the actual procedure for design of a cavity, let's spend a couple of minutes looking at some purely mechanical—but still important—factors which influence the frequency stability of the finished cavity.

It's well to remember that the dimensions of the cavity are the major influence upon its resonant frequency—and all materials change dimension under the influence of temperature. Thus you should choose the material for the cavity not only on the basis of its strength, expense, or conductivity—but also on the basis of its thermal coefficient of expansion (how much it changes size when it gets hot).

These coefficients of expansion are listed in Table 1 for the more popular cavity materials, together with the frequency changes in cycles per megacycle per degree F. As temperature rises, the frequency will increase. Note that the old chassis favorite, aluminum, comes in in last place in this listing! And the listing is in

GENERALIZE YOURSELF! LEARN RADIO CODE

The EASY WAY

No Books To Read—No Visual Gimmicks To Distract You. Just listen and learn

Based on modern psychological techniques — This course will take you beyond 13 w.p.m. in LESS THAN 1/2 THE TIME

Available also on magnetic tape
See Your Dealer Now!



Album Contains Three 12" LP's 2 1/2 Hr. Instruction

Life Story of Nikola Tesla

Now, learn code and something else at the same time. Fascinating story and code practice at same time. \$2.49



EPSILON RECORDS

2769 CAROLINA
REDWOOD CITY, CALIF.

6 METER CONVERTER WITH NUVISTOR PRE-AMP

Unbeatable performance at an unbeatable price. Only \$10.00 ppd. Complete with 6U8A, 6CW4 tubes and choice of 36 mc. crystal for 14-18 mc. output or 49.4 mc. crystal for broadcast band output. Fully assembled, tested and guaranteed. Sensitivity .1 microvolt. Noise figure 2.5 db.
VANGUARD ELECTRONIC LABS
190-49—99th Ave. Dept. H-9
Hollis 23, N. Y.

GIANT GROVE SALE ! ! !

- PROTECT YOUR MOBILE EQUIPMENT—
Auto Burglar Alarm ea: ONLY \$3.49
- 6CW4 Tubes ea: \$1.69

GET ALL OF THAT SIGNAL OUT WITH LOW LOSS FOAM COAX CABLE

- RG58U ... 50 ft. \$2.49 ... 100 ft. \$3.99
- RG8U ... 50 ft. \$4.95 ... 100 ft. \$8.99

- 6.3V—5A—Filament Xformer ea: SALE \$1.49
- 12.6V—5A—Filament Xformer ea: SALE \$1.49
- Multi-tap Filament Xformer ea: SALE 69c
- 70VCT—160ma Power Xformer 3 for \$1.00
- Pwr Xformer Pri-6V-12V-110V;
Sec-720VCT @ 75ma ea: Sale \$2.99
- Tunable Generator Suppressor ea: \$1.99
- SN-3—15 pc Mobile Noise Suppressor Kit
—includes Tunable Gen Supp etc
(Reg \$10.00 val) SALE PRICE \$4.99
- 400mfd Condenser—75V 3 for \$1.00
- 4 Transistor P.P. Audio Amp w/schematic
SALE \$3.99
- 4P—D.T.—12V Plug-in Relay w/socket
(reg \$8.00 val) SALE 99c

FREE CATALOGUE of GROVE SALE BARGAINS

Check items wanted. Return ad or order with check or money order. Include postage, excess refunded. 50c service charge on orders under \$5.00. Beams and 102" whips shipped Railway Express, 50% deposit on C.O.D.'s

- DEALERS: Write for Quantity Prices!

GROVE ELECTRONIC SUPPLY COMPANY

4001 W. School St.

Chicago 41, Illinois

Phone 283-6160

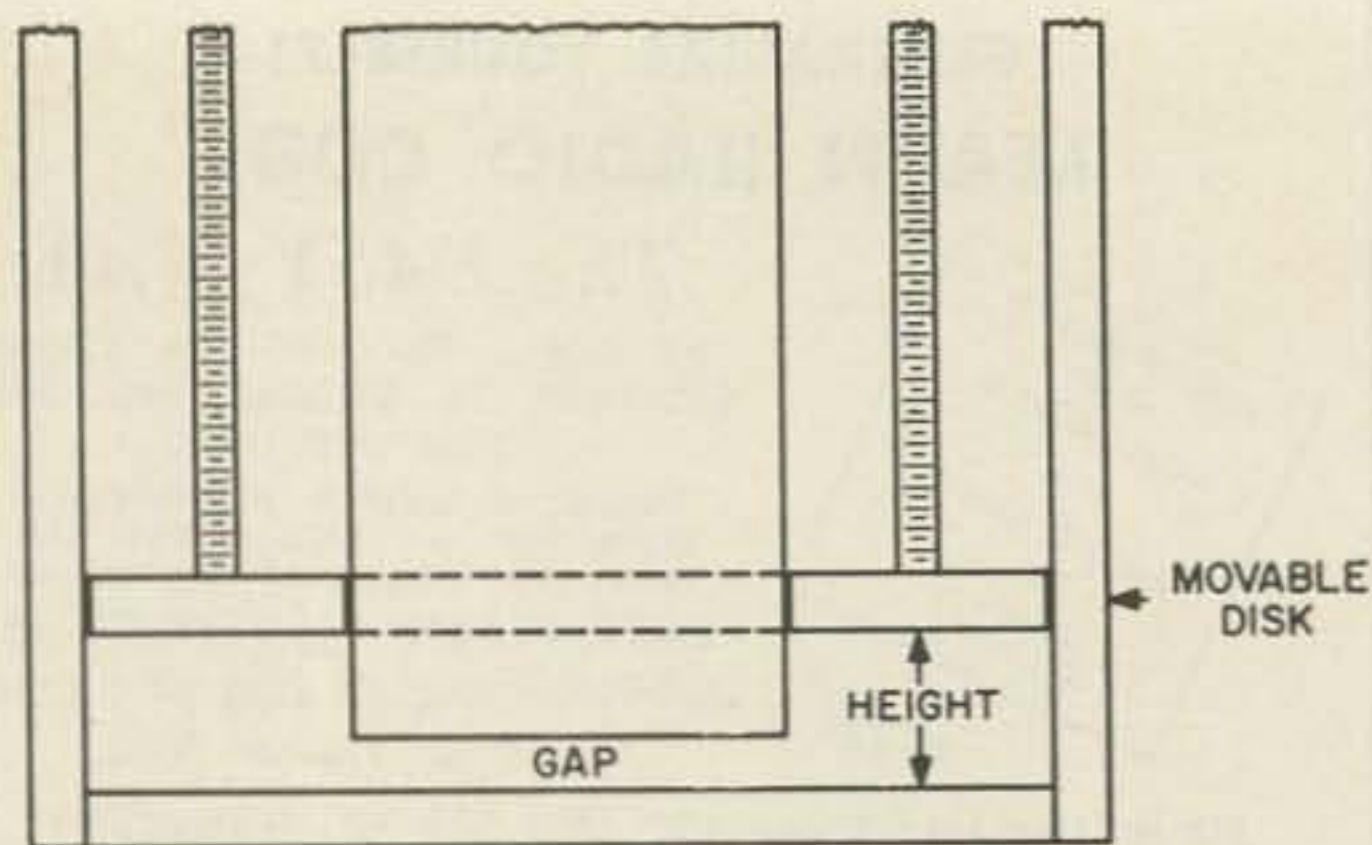

TUNING REENTRANT BY VARYING HEIGHT
FIGURE 4

order of desirability, with the most stable materials at the top of the table. Probably the most reasonable compromise would be the use of copper, which combines good plating qualities, good expansion properties, and ease of working.

The resonant frequency of the cavity will also be affected by the humidity—and this you have precious little control over. Taking 60 percent relative humidity as the starting point, an increase of humidity to 100 percent will cause the frequency to decrease by 0.006 percent—a change of 6 kc per megacycle. Decreasing humidity to 20 percent causes frequency to increase about the same amount. Changes of air temperature have similar effects but of much smaller degree.

Since you can't do much about humidity effects, it might seem pointless to mention them. However, they are mentioned just so you will know about them when they show up. They can be compensated for by retuning the cavity at each use.

Speaking of tuning, we have so far made no mention of it, although obviously a practical cavity for ham use must make some provisions for frequency adjustment.

As we saw earlier, a cavity may be tuned by adjustment of its length, or, if it is of the reentrant type, by changing the gap spacing. The length may be adjusted as shown in Fig. 4. The gap spacing, similarly, may be changed by the technique shown in Fig. 5.

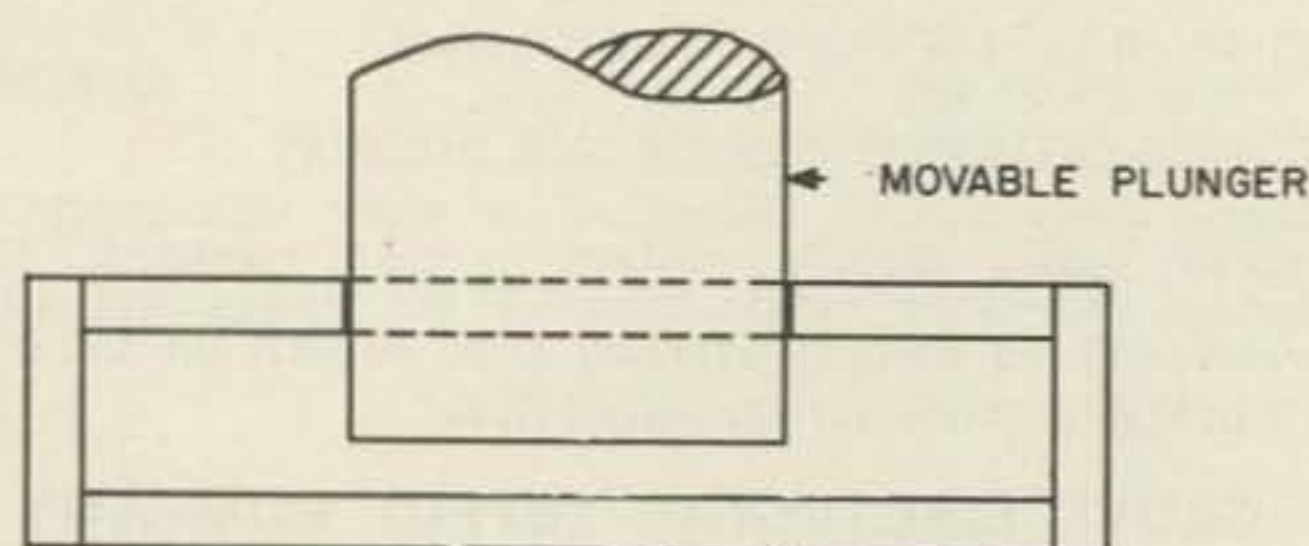

TUNING REENTRANT BY VARYING GAP
FIGURE 5

If tuning is done by changing the length, frequency will decrease as gap spacing detuning is by means of changing gap spacing, frequency will decrease as gap spacing decreases.

Another method of tuning a cavity, frequently used in ham construction, is that shown in Fig. 6. This uses a modified neutralizing-capacitor plate to change the value of a lumped capacitance in the cavity, and its effect on a given cavity is difficult to predict. As capacitance increases, however, frequency will decrease.

So now, after all the background and theoretical material, we're ready to attack the problems of actual cavity design.

Design of a coax-line cavity is simplicity itself; simply divide the wavelength corresponding to the desired resonant frequency by two, multiply by the velocity factor of the line (if you are using a solid coax—otherwise this is irrelevant, since the velocity factor of an air-filled line is 1.0), and you have the length. Diameters can be whatever you require. Remember, though, to design for a frequency approximately twice that at which you intend to operate, to allow for loading effects and have room for tuning.

For a pillbox cavity, divide the wavelength corresponding to design frequency by 2.61 to determine the radius of the cavity; diameter will be twice this figure. Height is immaterial so long as it is greater than 0.021 wavelength.

However, both coax-line and pillbox cavities find only limited ham applications. By far the most useful all-around cavity design is the reentrant style—and since its design involves a function of not one but four variables, design charts are necessary.

Figs. 7 and 8 are a pair of these charts; Fig. 7 applies to reentrant cavities in which the ratio of diameters of the center post and the cavity itself is 2.25, while Fig. 8 is for a diameter ratio of 3.50. For intermediate diameters, these charts will give a range of values and the desired values will lie within this range.

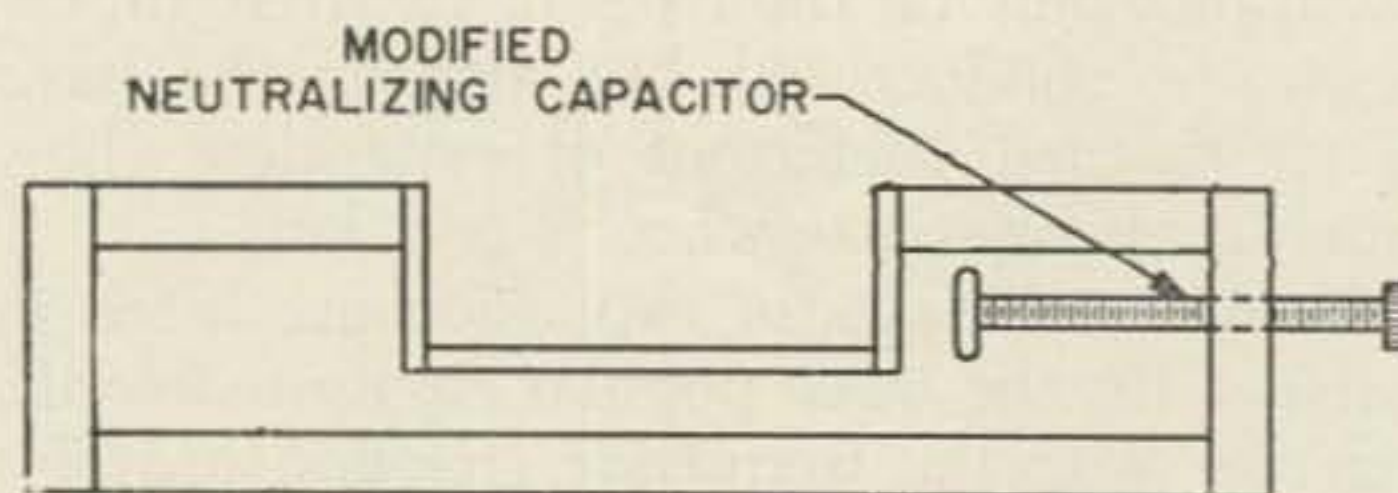

CAPACITOR TUNING OF CAVITY
FIGURE 6

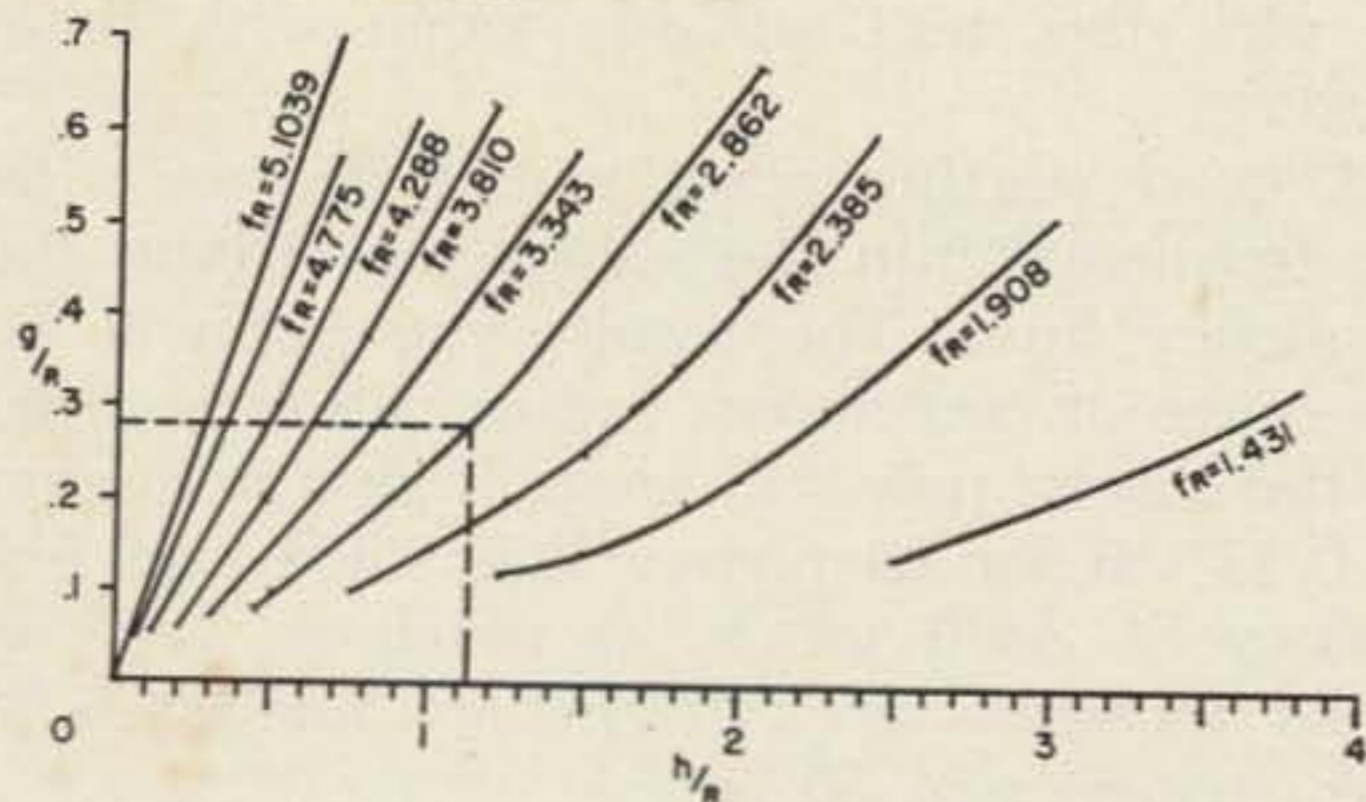

RATIO = 2.25
FIGURE 7

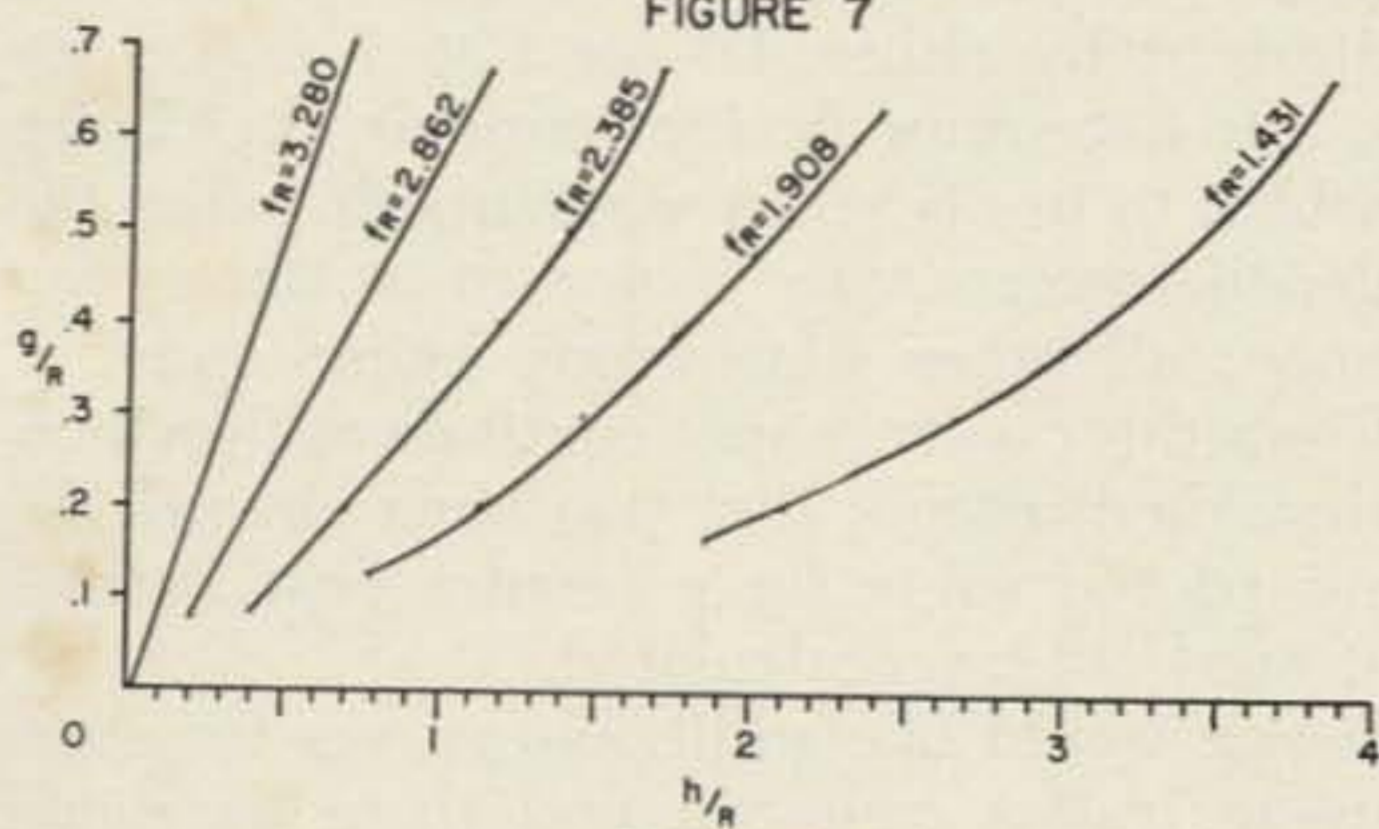

RATIO = 3.50
FIGURE 8

Frequency is shown in kilomegacycles—this will be true only if all dimensions are measured in centimeters. The conversion from centimeters to inches follows the equation 2.54 centimeters equals one inch.

These charts are somewhat complex and their use is best shown by working out an example. Let's design a cavity to operate at a frequency of 1296 mc and using a cavity diameter of 4¼ inches. A center post diameter of 1¼ inches will result in a diameter ratio of 2.25, so we now turn to Fig. 7.

The small amount of specification we have already done has fixed the values of two of our four variables, leaving only gap spacing and cavity height to determine from the chart. But before we can do this, we must determine which of the frequency lines to use.

Note that gap spacing, cavity height, and frequency are all given in terms of their relationship to center-post radius (rather than diameter). Thus, our first step is to convert the center-post diameter of 1.75 inches to a radius in centimeters. Multiplying the inch measurement by 2.54 converts to centimeters, and dividing by two converts diameter to radius. Our figure (calculated by a six-place log table) is 2.2225 cm; we round off at this point to 2.2. Multiplying this by the design frequency in kmc (1.296) gives us 2.8578; using the line marked 2.862 will be plenty close enough for our purposes.

Next step is to note the possible range of values covered by the frequency line chosen;

TONS OF AMATEUR EQUIPMENT IN STOCK

WESTERN RADIO

SAN DIEGO

1413 India Street BE 9-0361
MON - FRI 8:30 to 8:00 SAT 8:30 to 5:00

TRANSISTOR IGNITION

Described in the June issue of Popular Electronics. Complete kit of Components including Delco 2N1970 transistors. All components guaranteed for one year. Improves gasoline mileage and extends life of spark plugs and points. Full instructions.

Only \$14.95 postpaid USA

Order Today

A & F ELECTROMART

1616 S. 81st Street Milwaukee 14, Wisconsin

QSLs Samples 25c (refundable) Wildcat Press, 6707 Beck Ave., North Hollywood, Calif.

TELETYPEWRITER EQUIPMENT AND COLLINS

51J2, 51J3, R-390A/URR Receivers (.50-30.5 MC). Teletype Printers #14, #15, #19, #20, #26, #28. Kleinschmidt Printers #TT-4A, TT-76, TT-98. Telewriter Frequency Shift Converter. Boehme Keyers for CW. For general information & equipment list, write

ALLTRONICS HOWARD CO.,

Box 19, Boston 1, Mass. Richmond 2-0048.

All Nuvistor 6 Meter Converter (2-6DS4) Cascode RF Amp (2-6CW4) Osc. and Mixer. Low cross-modulation, no neutralizing. A smooth operating unit of advanced design, low noise with high sensitivity proximity oscillator will accept any 3rd overtone xtal for any I.F. from BC to 20MC. Requires only 10MA at 100V for plus 30 DB gain.

"WA6YST—Very much satisfied" "KITCU—FB."

"WAØAIZ—Works great."

Circuit board wired and tested, less tubes and xtal ..\$6.50PP

2 Meter model of above. 10MC & 50MC I.F.\$7.50PP

The above units are now available mounted in a 3 x 4 x 5 aluminum case with antenna, output & power connectors mounted on rear of box. Cover lifts off for instant adjustment of unit. Green jewel pilot lite on front of case gives on-off indication. ADD\$6.50

"Little Gem" 6 Meter Transmitter and Exciter Unit. Our most popular item. If you plan to get on 6 meters give this a try. If you are on 6 get one and have a ball. A highly efficient RF section. Unit uses low cost SMC xtals and will give up to 3 watts into the antenna. Unit doubles in the final, requires no neutralizing, and has no danger of out of band operation. Uses one 6AU8 tube. Fully tuneable-variable capacitors—Built in antenna coupler. This unit can be used as a driver stage for linears and PA's to several hundred watts. Ideal for mobile rig. "From W4BIR—Have worked 19 states with 'Little Gem'—remarkable performance."

Circuit board wired and tested—\$6.50. With 6AUB tube—\$7.50

5 Watt Audio Board & Modulator for above. Xtal or carbon mike input. Uses 12AX7 & 6AQ5. Circuit board—\$4.50. Set of tubes—\$2.00.

The above units are available mounted in aluminum holders with all connectors—ADD\$2.50

6 and 2 Meter Cascode Nuvistor Pre-Amps. S/N-3DB up to 20DB gain. Input & output fully tuneable with ceramic trimmers. Only 2½"x2". Fits anywhere. Ideal for communicators, HE-45, HQ-110 etc. Circuit board wired and tested—\$4.00PP Also for citizen band 27MC.

The above unit is available mounted in 3x4x5 aluminum case with all connectors on rear. Front of case has green jewel on-off lite & 0-100 gain control. De-lux mount—ADD\$6.50

GEM ELECTRONICS

P.O. BOX 203 TREMONT CITY, OHIO
PHONE — TERRA HAUTE 282 URBANA, OHIO EXCHANGE

in this case gap spacing can range from a g/r of 0.08 to 0.67, with corresponding h/r values from 0.42 to 2.05. Converting these figures to centimeters by multiplying them by r (2.2) we find that gap spacing can range from 0.176 cm (less than 1/10 inch) to 1.474 cm (just over half an inch). With the smaller gap, height will be 0.924 cm (about 3/8 inch) while with the larger one, height will be 4.51 cm (just over 1 3/4 inches).

From these ranges, we can pick either the gap spacing or the cavity height we prefer, and the other dimension will then be read from the curve. Let's choose a gap spacing of 1/4 inch just to illustrate how the process works.

After converting the 1/4-inch spacing to centimeters and dividing it by r , we come up with a g/r value of 0.285. We locate this value on the g/r scale by interpolation (dotted line in Fig. 7) and follow over until it intersects the frequency line marked 2.862, then drop vertically to the h/r scale (dotted vertical line) to find the h/r value. In this example, it is 1.11. Multiplying by r , we obtain 2.442 cm as the height of our cavity—or just under one inch.

The final cavity dimensions, in inches, then become a diameter of 4 1/4, a center-post diameter of 1 3/4, a gap spacing of 1/4 inch, and a cavity height of 0.961 inches. Making the top plate variable as shown in Fig. 4 allows easy variation of cavity height to allow for final tuning of the cavity.

In this example, we chose a frequency and a diameter, and from those determined the rest of the cavity dimensions. But what if we are free to use any diameter we want—how do

we pick the most suitable value with these charts?

A good starting point would be to divide the frequency into the values marked on the frequency lines. The results you get will be the range of center post radius values covered by the charts; they will range from a minimum of 0.43 cm for frequency line 1.431 and frequency of 3300 mc to as much as 100 cm (39.4 inches!) for a frequency line of 5.00 and frequency of 50 mc.

Once you pick a suitable center post radius, multiply it by either 4.5 for Fig. 7 or 7.0 for Fig. 8 to determine cavity diameter; the choice of which to use is yours, remembering that the larger-diameter cavity tunes to a lower frequency, all other dimensions being equal.

From this point, simply continue as previously described, except that you have already determined the value for r (center post radius) so it need not be recalculated.

If you would like additional curves for other diameter ratios, you can find them on pages 73 through 75 of "Klystrons and Microwave Triodes", a volume of the MIT Radiation Laboratory Series published by McGraw-Hill and available in many libraries. However, you should seldom need them.

We hope that this material is of some help to the would-be UHF experimenter; those looking for more data can find it in the above-mentioned volume, as well as in *Reference Data for Radio Engineers* published by ITT-Kellogg and to a lesser extent in the past three editions of *Radio Handbook*. Both these volumes are available from Radio Bookshop.

Dual Antenna System for Mobile

Frank Mohler W2IAZ
187 Broad Street
Eatontown, New Jersey

A motorist is already familiar with a dual roadway which reduces congestion on highways. Use of the dual antenna system offers similar relief from overcrowded airways for the modern mobileer.

Some Mobiling Problems

Did you ever work mobile and encounter the following frustrating situations? Situation 1—You are in contact with a local station on 75 meters. As you travel away from his station he reports that QRM is beginning to clobber your low-powered signal. His signal is loud and

clear in your mobile receiver and you would like to continue the QSO. What can you do? Or take situation 2—You are looking for a local QSO to get information about the unfamiliar area through which you are traveling. You take a look-see over the different bands with your receiver and tune in a local roundtable on the 75 meter band. You would like to get into this net but your antenna is a 15 meter whip and the 75 meter heliwhip is stored inside the car. To change antennas would take about a minute or so but to perform this change requires that you stop the car. In many cases, such as

when driving on the Freeway or other public racetrack, you are unable to stop the car and perform this operation in safety. What can you do? Or take Situation 3 which happens all too often—You are tuned up on 75 meters but the band is so congested that all attempts to raise a contact are fruitless. You then tune the receiver across the other bands and hear the familiar voice loud and clear on the 15 meter band. It's old buddy Jake that you haven't worked "in a long distance." He is telling someone that he is about to QRT and will stand by for any final remarks before pulling the big switch. Band conditions are good and you know from past experience that you can snare good old Jake if only you had the 15 meter antenna on your transmitter. You have only seconds in which to change antennas and tune up on 15 meters but there isn't time for you to find a safe place to stop the car and make the change. What can you do?

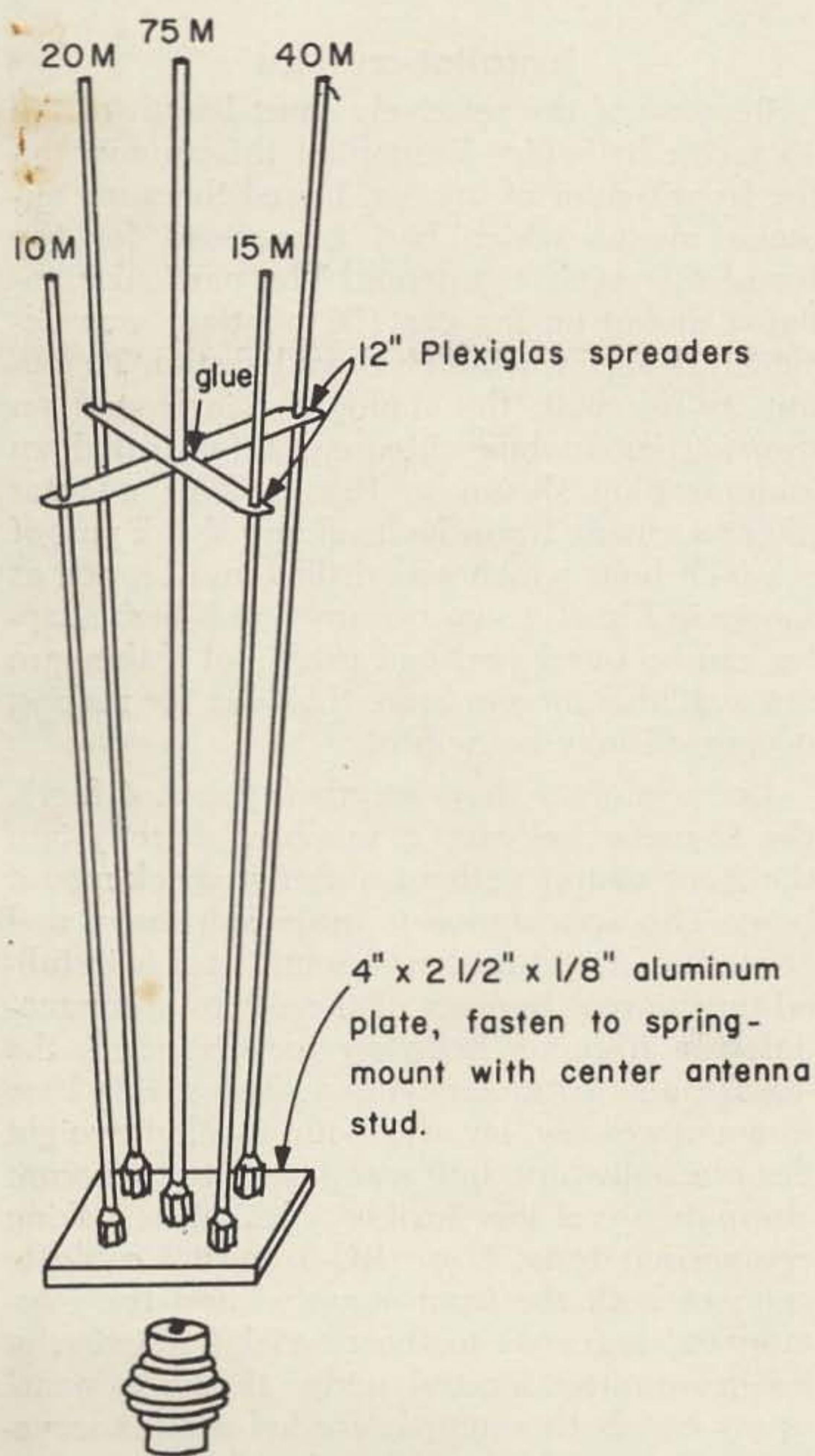

FIGURE 1



A Few Solutions

The obvious solution to such frustrating predicaments is to be prepared with an all-band antenna system that will permit you to band-hop in seconds. What is equally important, but often overlooked, is the ability to change bands without having to stop the car to make antenna adjustments.

One method for accomplishing this is to install an autotune system in which a remote-controlled reversible motor is used to tune a base-loading antenna coil. The disadvantages of cost, complexity, and low radiation efficiency make this method too unappealing to me.

A second method is to install the Umbrella Stand or Porcupine Array shown in Fig. 1. The bristling appearance of this all-band mobile antenna system is so startling that I recommend its use only to those who have exceptionally strong gastric systems. As I say, this method will work if you can (UGH) stand the sight. Technical details are shown in Fig. 1. The aluminum adaptor plate will accommodate sepa-

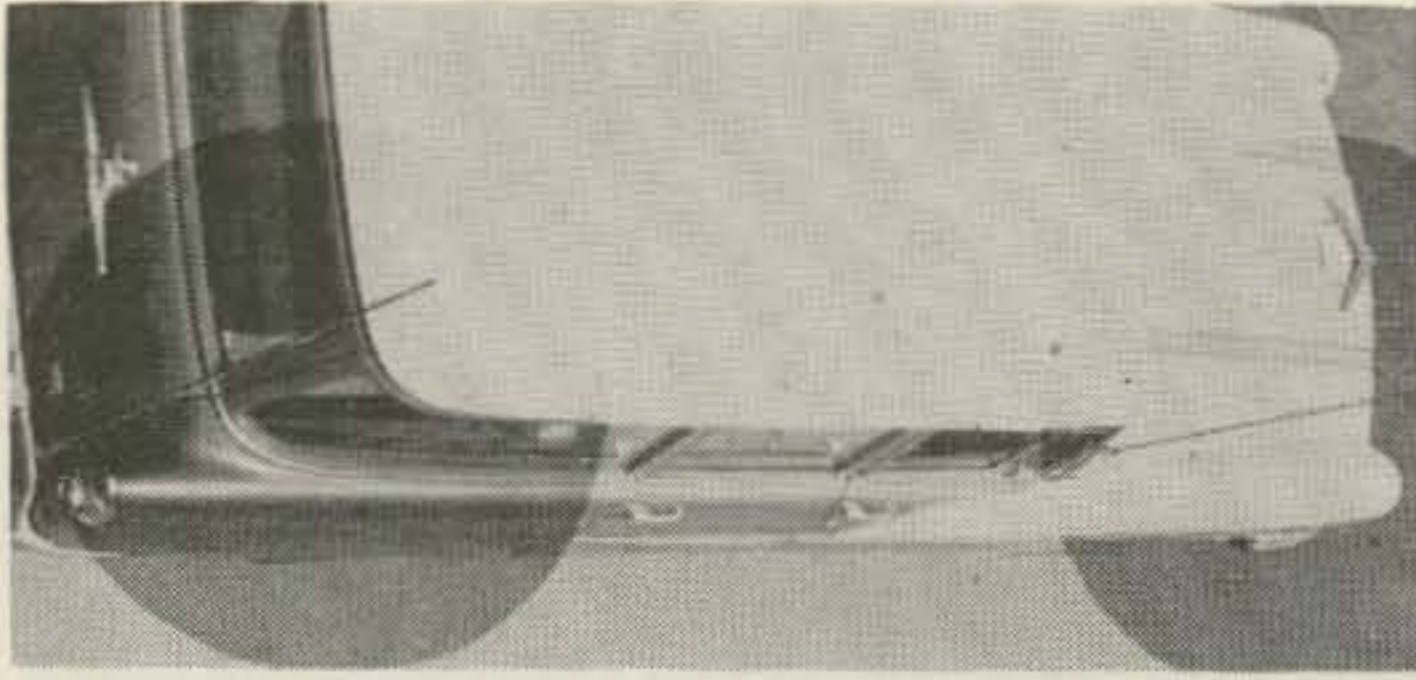

rate heliwhips for five different bands. Removal of the cented heliwhip allows rapid disassembly for traveling through civilized areas.

As a compromise solution, the mobileer might try the dual antenna system that is relatively uncomplicated, is presentable in appearance, and is guaranteed to double your enjoyment of mobile operation.

Dual Antenna System

The idea is simple enough. Just mount two antennas on the car; one at the front, and one at the rear. Then connect both transmission lines—yes, BOTH of them—to the transmitter. I use a T-junction coaxial fitting on my transmitter to make this connection. In my mobile station, I normally use a 15 meter heliwhip mounted on the front fender of the car and a 75 meter heliwhip mounted on the rear bumper. Purists can install and use an additional selector switch at the transmitter to permit alternate use of either antenna. I learned that such a switch is an unnecessary luxury, for on trying the dual antenna system I found that each antenna performed normally. Apparently, the correct antenna doesn't know or care that a wrong antenna is also connected to the transmitter. To change bands can be done without stopping the car or fiddling around with roller adjustments, sliding contacts et al. With my bandswitching transmitter, I can bandhop in the same time it takes to tune a receiver to a different band, a matter of seconds.

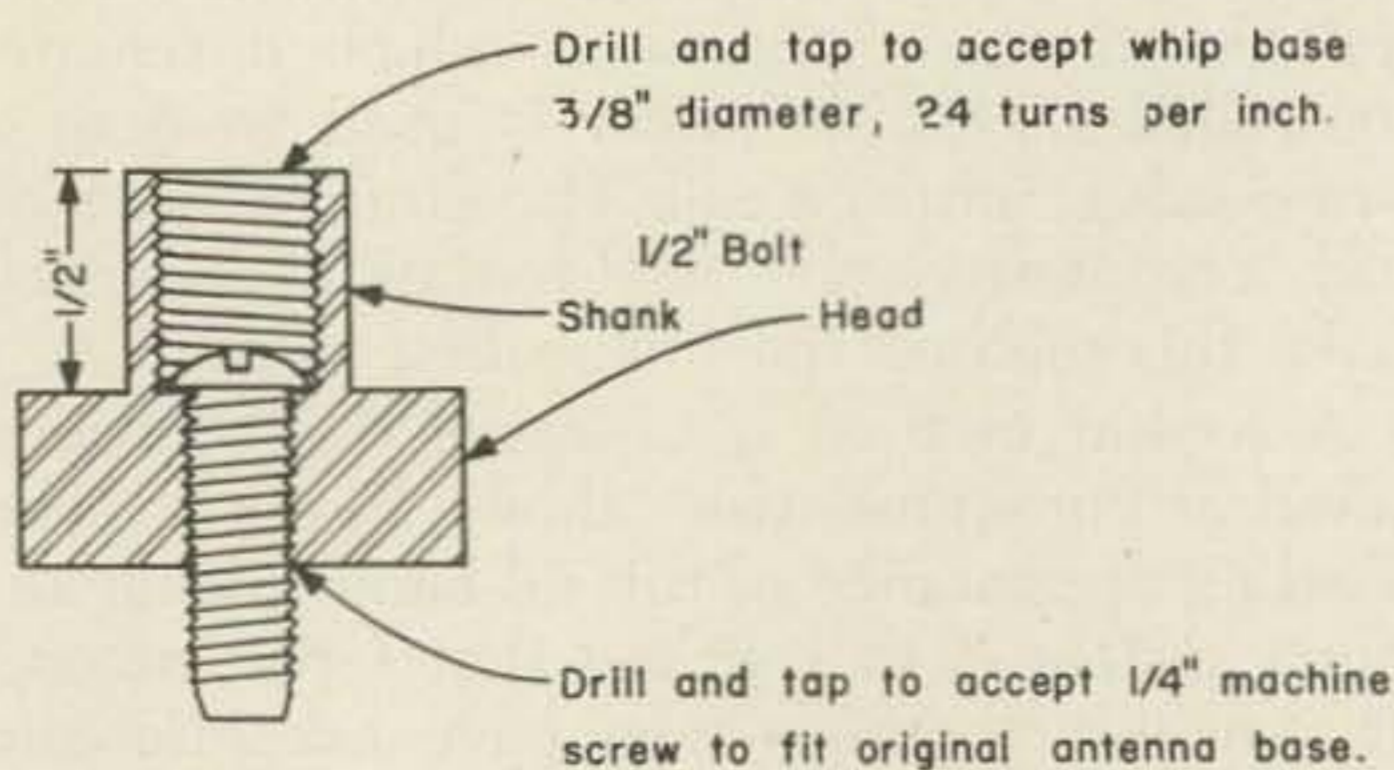

ANTENNA BASE ADAPTER
FIGURE 2

Advantages of the Dual Antenna System

Now how does this dual antenna system offer the solution to the situations discussed at the beginning of this article? Take the first situation—The other station is beginning to lose you because of QRM on 75 meters. The solution: Tell him, even if you do have to repeat 5 or 6 times that you will QSY to 21.3 mc but will continue to listen to him on 75 meters. From experience, this method works almost all of the time and allows a satisfactory continuation of the QSO which otherwise would have been unhappily ended.

Situation 2 as well as Situation 3 offers no problem when this dual antenna system is used. Without stopping the car to make antenna adjustments, you merely bandswitch your transmitter to the alternate band. In less time than it takes to say, "Allagazandas Ragtime Bebob" you can be working out on the alternate band and you have a good chance of hooking old buddy Jake before he pulls the big switch.

Installation Tips

Because of the relatively short length of the 15 meter heliwhip, I mounted this antenna on the front fender of my car. I used the same antenna mount which had been used for the broadcast receiver antenna. The particular antenna mount on my car (56 pontiac) was designed to accept a 1/4-inch threaded stud. To permit its use with the standard 3/8-inch stud on transmitting mobile antennas, I fabricated an adaptor plug shown in Fig. 2. This adaptor plug was made from the head and shank part of a 1/2-inch bolt, which was drilled and tapped as shown in Fig. 2. I suppose any 1/4 to 3/8-inch adaptor can be purchased and used, but if they are not available in your area, this idea for making it yourself may be helpful.

Because of its short length (approx. 4 feet), the 15-meter heliwhip is mounted directly into the front mount without a spring shock-mount base. The appearance is quite shipshape and attractive. A spring shock-mount base is installed on the rear bumper of the car to accommodate the 75-meter heliwhip (or alternately the 40, 20, and 10 meter whips). The spring base is not necessary for use with the lightweight flexible heliwhips but was installed to permit alternate use of less flexible types when making comparison tests. I use RG-8 coaxial cable to connect both the front-mounted and the rear-mounted antennas to the coaxial T-junction at the transmitter located under the dash panel of my car. Both antennas are fed simultaneously by the transmitter, although only the antenna which is resonant to the transmitter frequency

will act like it is in the system.

Operating Suggestions

When using the dual antenna system in mobile operation, I find that a certain technique is worth practicing to avoid unsatisfactory completion of a QSO. While in contact with another station, I will make it a point to explain that I can switch instantly to an alternate band if deteriorating band conditions cause a serious reduction in signal readability. For example,

when working on 75 meters, I generally inform the other station operator that my alternate frequency will be 21.3 mc in the event of serious interruption or interference to my signal. Instantaneous switching to an alternate, less congested, band has enabled me to complete mobile QSO's which otherwise would have been left dangling in midair like _____ you _____ beginning _____ 50 percent _____ sput _____ lose _____ sputter _____ 73 _____ phfitt. . . . W21AZ

Eliminating Polar Relay Hash

George Oberto K4GRY

Vacuum tube or transistor type keyers feeding directly to the selector magnet of a teletype printer is often preferred by most radioteletype enthusiasts, because of the elimination of the polar relay with its radiated hash problems. If we can get rid of the troublesome relay hash, a properly adjusted polar relay is preferred, because of the extra range that will enable us to dig down in the QRM for the weaker RTTY signals.

In using several RTTY converters, with and without a polar relay, it was decided to try and eliminate the troublesome hash from the polar relay contacts, keying a 60 ma loop, feeding the selector magnet of a model 15 page printer.

The circuit uses several of the popular methods to adequately suppress the polar relay hash. Four .001 mfd ceramic capacitors are wired, as shown, two across the bottom and two across the top of the three 1 mh rf chokes. At the bottom of the rf chokes the popular hash suppression circuit consisting of a 390-ohm 2 watt resistor and a .1 mfd capacitor is utilized. A .005 mfd ceramic capacitor is wired from each side of the .1 mfd capacitor to ground.

The entire assembly is installed in a small aluminum minibox and all wires including the printer cord are well shielded (using two wire shielded cable) with the printer, converter, and receiver connected to a common

ground; preferably a cold water pipe or a ground rod driven deep into the earth. The receiving antenna should use coax cable to feed the antenna. The end result is the elimination of all traces of radiated hash from finding its way into the receiver's antenna system.

. . . K4GRY

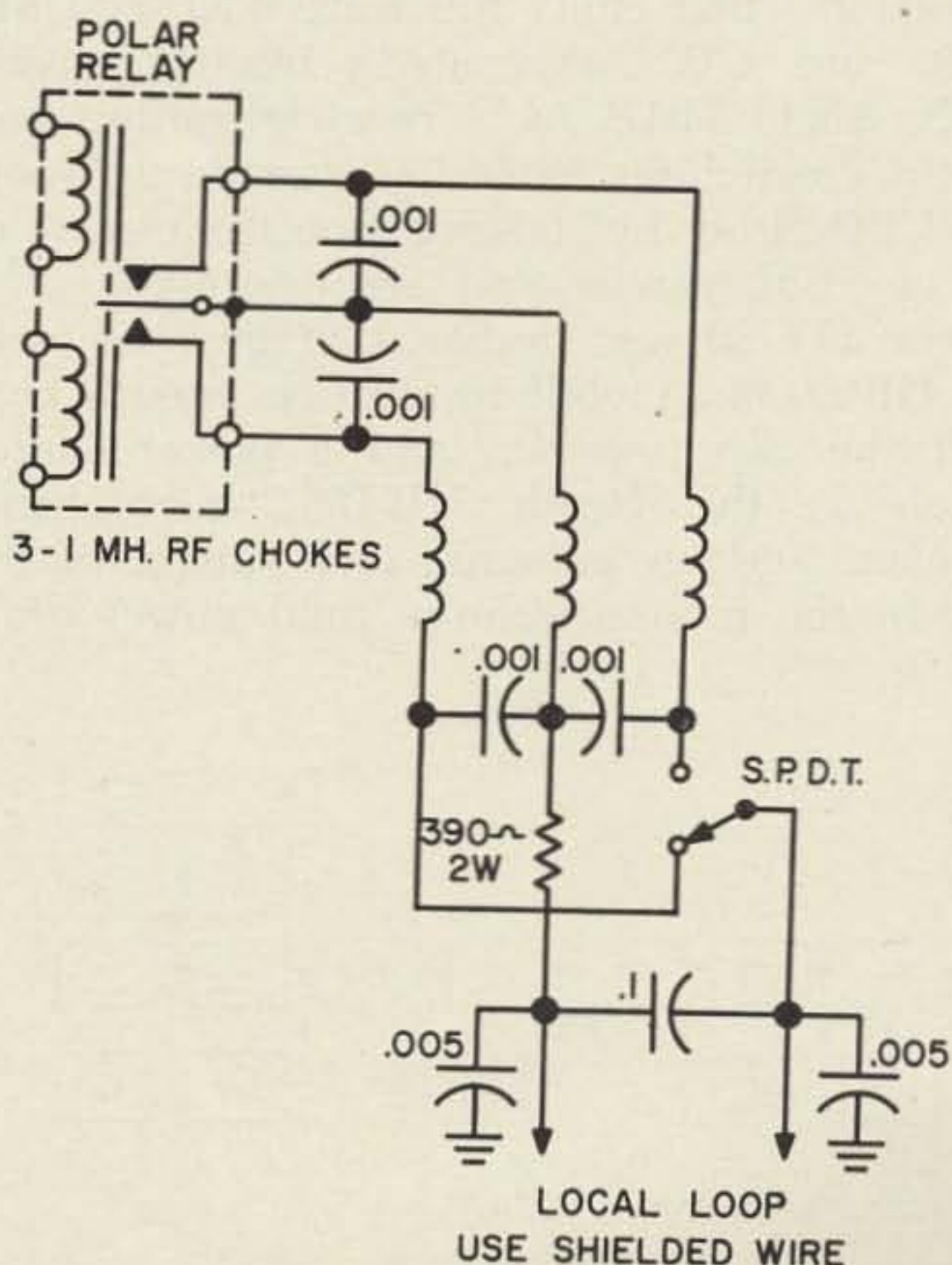



73 Test the Heath HX-20

Robert Buas K6KGS

Heath Company calls their new HX-20 a MOBILE SSB TRANSMITTER. All this it is, and more. Compactly packaged is a complete filter SSB transmitter/exciter for mobile, portable, or fixed use. Advanced mechanical and electrical design make the HX-20 a real performer. Modern styling and "ease-of-operation" make this unit a natural mobile transmitter. It is the opinion of the author that Heath has come out on top AGAIN.

The HX-20 sports an 11 tube circuit (not to mention the 7 diodes and 2 gas voltage regulators) that emits 100 watts PEP of USB, LSB, and CW. Associated circuits provide VOX, ANTI-TRIP, ALC, receiver muting, and antenna switching. Provision is made to "spot" the VFO either by "talking it on frequency" or by inserting carrier and zero-beating.

The HX-20 was designed to be used with the HR-20 in a mobile installation. Simply connect the two together, add a power source (such as the Heath HP-10), microphone, speaker, and an antenna, and you're on the air. In the mobile lash-up, total power draw

on the battery on voice peaks is 150 watts, from a 12 volt dc source. Receiving power is 80 watts. All oscillators in the HX-20 run continuously, accounting for the additional power drain.

For fixed use, the HX-20 may be used to excite a 1 KW linear amplifier (such as the Heath HA-10) or may be operated "barefoot." The 6146 power amplifier develops up to 50 watts average output on all bands. Hetrodyne circuitry and temperature compensation of the VFO are used to obtain maximum frequency stability and image rejection.

A block diagram of the HX-20 is shown in Fig. 1. As one might imagine, the schematic is very involved, thus it was omitted here. A triple-conversion hetrodyne circuit is used to obtain SSB at the desired output frequency. All oscillators are crystal controlled, with the exception of the VFO, of course.

Audio from a high-impedience microphone is amplified in the pentode section of a 6EA8. The triode section of the same tube acts as a cathode follower to provide the proper match for the crystal filter. A sample of this audio is amplified in $\frac{1}{2}$ a 12AU7, the VOX amp. This VOX audio is rectified and used to control the relay amp, the triode half of a 6EA8. The other half of the 12AU7 is used as a carrier generator for the crystal filter, the frequency being crystal controlled at 4990 kc. Output of this stage is coupled to the Balanced Modulator, two matched germanium diodes. A path for inserting carrier is provided for tune-up and CW operation.

The lower sideband of the DSB suppressed-

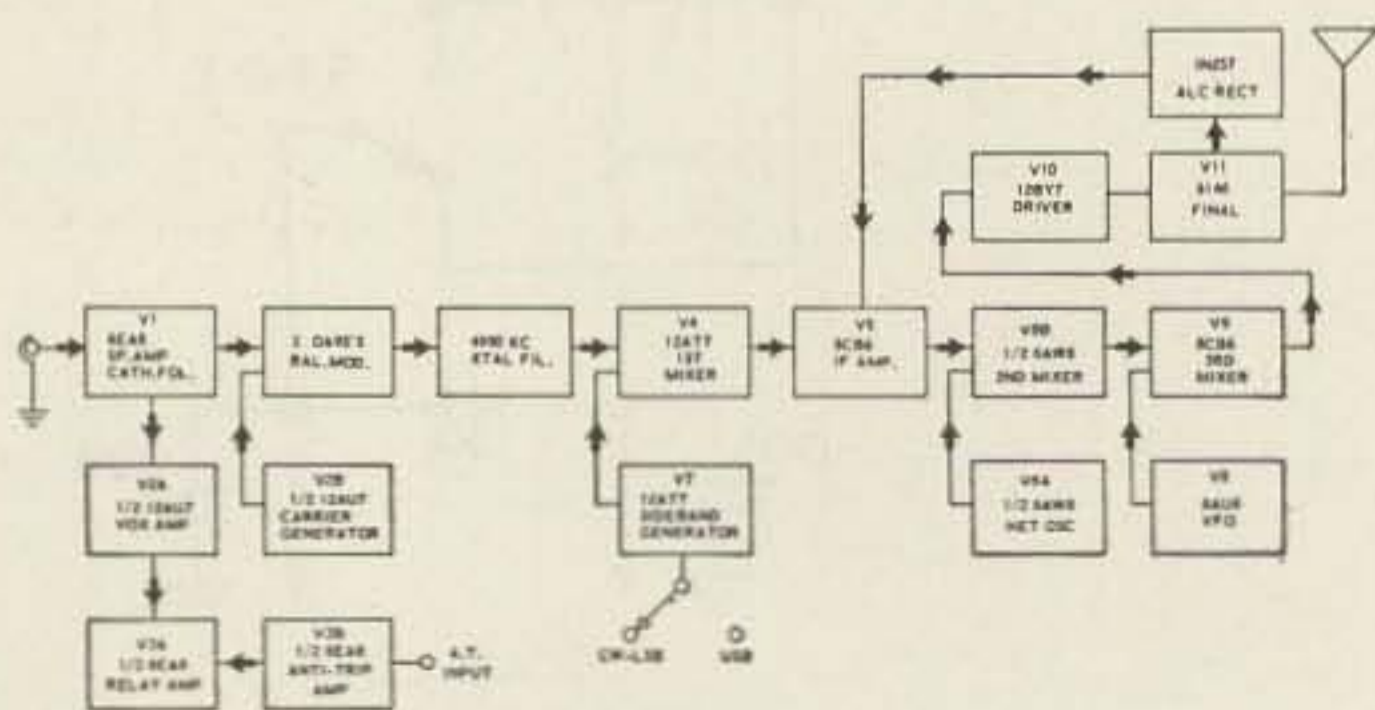

Fantastic Inventory Clearance Sale

of A-1 Reconditioned Gear—Now through Sept. 30, 1963—ACT NOW!

Terms of Sale: ★ 30 Day Guarantee ★ Full Credit Within 6 Months on Higher Priced New Equipment ★ You can pay as little as 10% down and take up to three years to pay—However—send CASH IN FULL whenever possible since CASH—NO TRADE orders will take preference during this special sale which positively ends September 30, 1963. After that, write for current listing. ORDER NOW—DIRECT FROM THIS AD.

AMECO TX-86 Xmtr \$ 69 PS-3 Pwr Sup 24	GLOBE LA-1 Lin \$ 69 PA-1 Attenuator 9 PH-1 Ph Patch 19 UM-1 Modulator 29 SS-3 Q-Mult 9 VOX-10 Control 9 VHF-62 Hi-Bander 99 65-B Xmtr 44 SD-75A 79 Chief 90 29 Chief 90A 34 Chief Deluxe 39 DSB-100 Xmtr 49 Champ 300 125 Champ 300A 149 Champ 350 199 King 500 249 King 500A 275 6 meter VFO 29 680 Xmtr 39 680A Xmtr 44 755A VFO 39 GONSET Comm II 6m \$129 Comm III 6m 149 Comm III 2m 179 Comm IV 2m 269 Comm IV 220 mc 199 GPP-1 Ph Patch 19 G-28 10m Xcvr 119 G-43 Rec 79 G-63 Rec 129 G-66 Rec 69 G-66B Rec 79 3-way Sup 19 Thin Pak 19 G-76 Xcvr 199 G-76 AC Sup 69 G-76 DC Sup 59 G-77 Xmtr 119 G-77A Xmtr 139 GSB-100 Xmtr 225 GSB-101 Linear 175 GC-105 2M 169 G-150 AM Xcvr (148.14 mc) 99 Tri-Band Conv AS-IS 10 Super 6 Conv 19 3066 6m Conv 24 Super 12 Conv 34 Aircraft Rec 59 6m Lin II 89 3163 Marine Conv 19 Commander 39 3357 VFO 49 2m VFO & Pre-Amp 29	HALLICRAFTERS—Cont. S-53A Rec \$ 49 SX-62 Rec 149 SX-71 Rec 99 SX-73 Rec 395 S-76 Rec 75 S-81 Rec 39 S-85 Rec 69 SX-88 Rec 275 S-95 Rec 34 SX-96 Rec 125 SX-99 Rec 84 SX-100 Rec 179 SX-101 Rec 175 SX-101 Mk III Rec 199 SX-101A Rec 225 S-102 Rec 29 S-106 Rec 29 S-108 Rec 89 SX-110 Rec 99 SX-111 Rec 169 SX-115 Rec 325 SX-117 Rec 279 S-120 Rec 39 SX-140 Rec 69 HAMMARLUND HK-1B Keyer \$ 25 HC-10 Slicer 79 HX-50 Xmtr 299 HQ-100 Rec 99 HQ-100C Rec 109 S-100 Spk 9 HQ-110 Rec 125 HQ-110C Rec 134 HQ-120 Rec 69 HQ-129X Rec 99 HQ-140X Rec 125 HQ-145 Rec 149 HQ-145XC Rec 175 HQ-150 Rec 149 HQ-160 Rec 199 HQ-170 Rec 199 HQ-170C Rec 209 HQ-180C Rec 299 HARVEY WELLS R-9A Rec \$ 49 APS-50 Sup 19 TBS-50 Xmtr 29 TBS-50C Xmtr 34 TBS-50D Xmtr 39 T-90 Xmtr 59 80T Xmtr AS-IS 25 Any TBS-50 series Xmtr AS-IS 25 HEATH Sixer \$ 39 AT-1 Xmtr 19 CA-1 Alarm 4 MP-1 12v Sup 29 MR-1 Rec 49 MT-1 Xmtr 49 QF-1 Q-Mult 9 RX-1 Rec 149 TX-1 Xmtr 169 VF-1 VFO 17 VHF-1 Seneca 159 GD-1B Grid Dip 24 AR-3 Rec 29 HG-10 VFO 29 HP-10 DC Sup 29 SB-10 SSB adapter 59 HD-11 Q-Mult 14 DX-20 Xmtr 24 HP-20 AC Sup 29 HR-20 Rec 99 DX-40 Xmtr 39 DX-60 Xmtr 59 DX-100 Xmtr 99 DX-100 B Xmtr 149 0-11 Scope 29 JOHNSON Adventurer \$29 Challenger 69 6 & 2 Conv (28-30) 39	JOHNSON—Cont. 6 & 2 Conv (14-18) \$ 39 Invader 200 399 Invader 2000 795 6 & 2 Lin 325 10m Messenger 69 Navigator 89 Pacemaker 199 Ranger 139 Ranger II 239 Thunderbolt 325 122 VFO 25 Valient 225 Viking I Xmtr 75 Viking II Xmtr 99 "500" Xmtr 395 Mobile Xmtr As-Is 25 KNIGHT V-44 VFO \$ 19 T-50 Xmtr 29 R-55 Rec 29 T-60 Xmtr 39 R-100 w/S meter 69 R-100A Rec 79 T-150 Xmtr 89 L&W LW-50 Xmtr \$29 LAFAYETTE HE-10 Rec \$ 59 HE-45 Xcvr 69 LAKESHORE Bandhopper VFO \$ 59 Phasemaster II 119 Phasemaster IIB 179 LINCOLN L-2754 6m Xcvr \$ 39 LOUDENBOOMER Mk II Lin & Sup \$299 MORROW 3-band conv AS-IS \$ 10 5-band conv AS-IS 20 MBR-5 Rec 39 MB-6 Rec 59 RVP-250 Sup 19 MB-560 Xmtr 59 MB-565 Rec 49 RTS-600S AC Sup 29 RTV-630 12v Sup 29 MOSLEY CM-1 Rec \$119 NATIONAL HFS Rec \$ 89 HRO-50 Rec 125 HRO-50T Rec 149 SW-54 Rec 29 NC-57 Rec 49 HRO-60 Rec 249 NC-88 Rec 64 NC-98 Rec 79 NC-125 Rec 79 NC-140 Rec 139 NC-155 Rec 139 NC-173 Rec 79 NC-183 Rec 119 NC-183D Rec 179 NC-188 Rec 69 NC-190 Rec 149 NC-240C Rec 69 NC-270 Rec 159 NC-300 Rec 179 6m Conc 24 2m Conv 29 NC-303 Rec 275 XCU-303 Calib 9 P&H DI-1 Scope \$ 59 6-150 Mixer 219 LA-400 Lin 79 MARS Thunderbird Xmtr \$ 39 POLYTRONICS 62B Xcvr \$279	PRECISION E-200C Sig Gen \$ 49 RME VHF-152A Conv \$ 34 4300 Rec 99 4301 Slicer 49 4350 Rec 119 4350A Rec 129 6900 Rec 199 REGENCY ATC-1 Conv \$ 39 SWAN SW-120 Xcvr \$179 SW-140 Xcvr 169 TMC GSB-1 Slicer \$ 69 GPR-90 Rec 299 TAPETONE XC-50N (30.5-34.5) \$ 29 XC-51 (10-14) 29 XC-50 (14-18) 29 XC-50C (26-30) 29 TC-220G (20-25) 129 345 Skysweep 125 TECRAFT 6m Xmtr \$ 29 PTR-2 AC Sup 19 6m Conv (14-18) 24 2m Xmtr 34 220mc Conv (15-30) 24 TRANSCOM 6m Xcvr AS-IS \$ 20 WRL SB-175 Xmtr \$ 69 PSA-63A AC Sup 19 CITIZEN'S BAND ECI Linear Amp \$ 99 GLOBE CB-100 12 & 110 \$ 49 CB-110A 59 HALLICRAFTERS CB-3 12 & 110 \$ 89 HAMMARLUND CB-23 Xcvr \$149 HEATH CB-1 \$ 29 GW-10 110v 44 GW-10D 12v 49 GONSET G-12 12 & 110 \$69 G-14 6 & 110 69 G-14 12 & 110 79 G-15 6 & 110 79 KNIGHT C-11 110v \$ 19 CB-27 110v 44 POLYTRONICS Polycom II 12 & 110 \$ 69 RCA RCM-P3A-5 12 & 110v \$ 79 REGENCY CBM-27 6 volt \$ 59 CB-27 110 volt 59 ED-27M 12 & 110 69 UTICA MC-27 \$ 89 NEW The following items are new, factory-sealed, offered at special prices. CENTRAL ELECTRONICS MM-2 kit \$ 50 MM-2 wired 89 COLLINS 75S-1 Rec \$375 COMMUNICATIONS, INC. Speakeasy \$ 10 DAYSTROM DM-348 CB kit \$ 50 DEWALD TR-850 6m Xcvr \$ 39	DRAKE 584-A Ph Patch \$ 19 GLOBE Chief Deluxe \$ 39 GONSET G-14 6 & 110 CB \$ 90 G-14 12 & 110 CB 90 G-15 6 & 110 CB 120 G-76 Xcvr 329 G-76 AC Sup 115 G-76 DC Sup 115 3311 88-108 FM Conv 12v B+ 35 GR-111 Rec 59 3357 6,2,1 1/4 m VFO 59 3275 6m Conv 29 3261 Super 12 Conv 59 GENERAL CRYSTAL 40MA Ant \$ 15 5HA-F Ant 20 HAMMARLUND HQ-145C Rec \$200 HY-GAIN 48D Ant \$ 10 RBX-1 Rotor 150 JOHNSON Ranger I kit \$200 MOSLEY CM-1 Spk \$ 9 PHILMORE CR-5AC Rec kit \$ 25 TC-612 CB kit 25 POLYTRONICS PC-6 6m AC only \$225 PC-N 6 & 110 CB 110 SR-23 CB 250 SONAR 40m Xcvr \$225 SWAN SW-140 Xcvr \$200 TECRAFT CC-220 Conv (28-30) \$ 20 CC-3/21 15m Conv (3.5mc IF) 10 CC5/144 2m Conv (14-18) 20 NEW DISPLAY The following items have been on display for a short time in protective plastic bags. All are complete with guarantees, original boxes—just like new, but at special savings. ELMAC PMR-8 Rec \$152 AF-68 Xmtr 165 M-1070 Sup 56 M-1071 kit 40 HALLICRAFTERS CB-3A CB \$135.95 CB-5 CB 149.15 HA-2 Transvertor 249 HA-6 Transvertor 249 P-26 AC Sup 69 SX-100 Rec 249 SX-111 Rec 199 FPM-200 Xcvr 1495 S-119 Rec 25 HAMMARLUND CB-23 Xcvr \$191.25 JOHNSON Messenger I CB 118.95 Messenger II CB w/ new tunable rec 135.95 The following kits are new, but for some reason have been opened. We guarantee them all to be complete. Save now! HT-40K Xmtr \$69 SX-140K Rec 89 S-119K Rec 19
---	---	---	---	--	--



AMATEUR ELECTRONIC SUPPLY

3832 WEST LISBON AVENUE
MILWAUKEE 8, WISCONSIN

Phone—West 3-3262

Visit our CHICAGO and ORLANDO Stores. See our full page ads in this magazine.

Ship Me: _____
1st Choice _____
2nd Choice _____
I enclose \$ _____ and will pay balance
 COD 1 Year 2 Years 3 Years
NAME _____ CALL _____
ADDRESS _____
CITY _____ STATE _____
 Send latest listing.

ONE FOR ALL!

and all from ONE!

the TOPAZ UNIVERTER 300 XL—ONE rugged, reliable supply to power any popular transceiver.

the TOPAZ UNIVERTER 300 XL—A Lifetime Investment—Built for rough weather, rough usage, and years after years of trouble-free service.

the TOPAZ UNIVERTER 300 XL features:
300 conservative watts @ 800, 700, or 600 Volts Hi B
275 Volts Low B
-50 to -90 Volts Potentiometer-adjusted Bias
Input 11 to 15 Volts DC
Weight 8 lbs.



T O P A Z
I N C O R P O R A T E D

The TOPAZ UNIVERTER 300 XL **\$119.95**

see your dealer or write today!

3802 HOUSTON ST., SAN DIEGO 10, CALIF. • CYPRESS 7-4815

Dust-proof, dirt-proof, kick-proof, spray-proof deep-drawn steel housing. Ideal for under-hood mounting—But attractive for visible mounting—QUIET enough to mount by your ear.

Uses rugged new transistors. Ratings conservative. Impossible to damage by short circuit. All cables included: 8-ft. red cable to battery, 5-ft. cable to transceiver, 18" cable for ground.

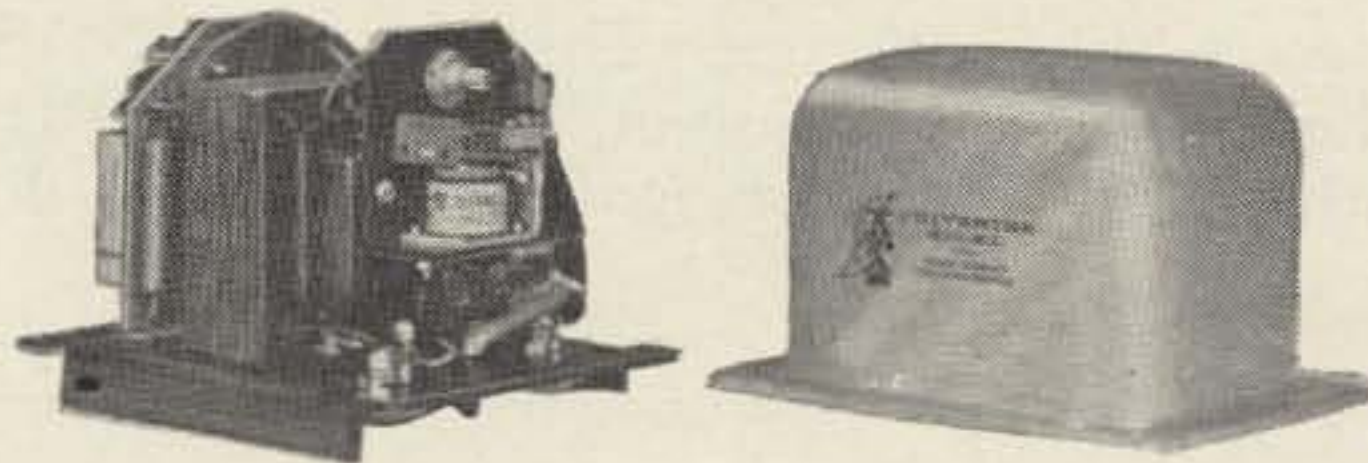

VFO. The "sniffer" circuit is also shown in Fig. 2.

Anti-trip audio from the receiver is amplified in the pentode half of a 6EA8 and rectified to provide negative bias to compensate for receiver pick-up in the microphone. This negative anti-trip voltage is applied to grid of the VOX relay amp along with the VOX voltage.

Some hold-up in production must have existed at Heath when the author ordered his HX-20 because it was back-ordered two weeks. The kit was well packed; no damage was found on unpacking. Even the cardboard box survived the 2500 mile trek in one piece. All the components are of highest quality, as in the HR-20. All tube sockets are ceramic. The output coil is wound on a 2" ceramic form. Parasitic suppressors are used in the Driver and Final Amplified stages. All leads at rf ground are well by-passed. Twenty-two heavily plated steel brackets make up the HX-20 chassis and internal shields. When bolted together, these parts make an extremely rugged framework. VFO drive gears are spring loaded to eliminate backlash. This rugged construction and spring loading contribute greatly to the excellent stability of the VFO. Although the HX-20 is well shielded, it is not difficult to build. Heath says that approximately 45 hours of construction time is required. The amount of time required varies with the experience of the builder. This figure represents the time required of a relatively inexperienced constructor. Patience is of the essence in the building of this kit. In places, components are wired 4 and 5 layers thick. A very professional job of wiring can be achieved

if the builder carefully studies the instruction manual previous to picking up the screwdriver and pliers.

Upon completion of wiring, the HX-20 was given a thorough resistance check before power was applied. Finding no errors, power was turned on; no smoke resulted. Alignment is straight forward, and no re-peaking was required. A VOM will not work when one is tuning up the heterodyne oscillator. An 11 meg input VTVM must be used. Even then, grid voltage was found to be a little below specified on 10 meters.

Since the author dislikes the use of RCA phono connectors at RF, BNC type UHF connectors were used in place of the connectors supplied. The phono connectors would, no doubt, work well, but the authors HX-20 and HR-20 are moved from the rack in the mobile regularly, placing undue wear on the coax cables. It was found that straight through operation of the 6AW8 second mixer on 75 meters did not supply enough drive to the 6CB6. Thus, the 2.7K resistor, R38, was changed to 4.7K, 1 watt. This solved the problem.

The specification sheet states that carrier suppression is 50 db while suppression of the unwanted sideband is 55 db. The proof of the pudding was the "on-the-air" test. Excellent reports were received, on both quality and signal strength. Frequency stability is remarkable. The HX-20 was clamped in a paint mixer and allowed 30 minutes to warm up. After warmup, the output frequency was heterodyned with a 10 meter harmonic of the 100 kc frequency standard. After 15 minutes

of vigorous mixing, the HX-20 had moved only 1500 cps. Someone try this test on a 32S1. No one has volunteered the use of one here, yet!

Other than the stability test, the HX-20 was compared with a KWM-2. The HX-20 lacks the frequency "re-setability" that the KWM-2 possesses. Careful interpolation can bring the HX-20 within 1.5 kc, whereas the M-2 can come within 200 cps. There is only 3 db difference in power output. VOX, ANTI-TRIP, and ALC tied for first. As far as size goes, the

KWM-2 is a transceiver and the HX-20 is a transmitter. No valid comparison can be made. Note gents that the HX-20 is just a tad smaller than the 32S1.

For the money, it will be extremely hard to do better than the HX-20. It is the opinion of the author that the HX-20 and HR-20 make one of the best rigs on the air today—with the added consolation that one does not have to sacrifice one of his gold fillings.

. . . K6KGS

Remotely Controlled Variable Inductor

Ronald Lumachi WB2CQM
73 Bay 26th St.
Brooklyn 14, New York

I faced the problem of changing antenna inductance in relation to ground potential. When I decided to become sophisticated and raise my 32' vertical plus coil from 40' (roof-top) to a height of 71'. Although the physical transfer of the antenna to its new position was made without difficulty, when my bridge and dipper were placed on the line, I was shocked to note the resonance change. Since I am somewhat inhibited about climbing to the tops of swaying towers, some remote means of altering inductance was needed. A system controlled from the shack was the answer.

Since I am new to amateur radio I had originally turned to the Command series of transmitters for a first rig. My original purchase was an 80 meter BC-696. The variable inductor (to resonate long wires) had been removed and thrown into the junk box. After meditating for a long period of time, this piece of valuable equipment was exhumed from the maze of wires, tubes, shoes and other choice bits of equipment that make up the average ham

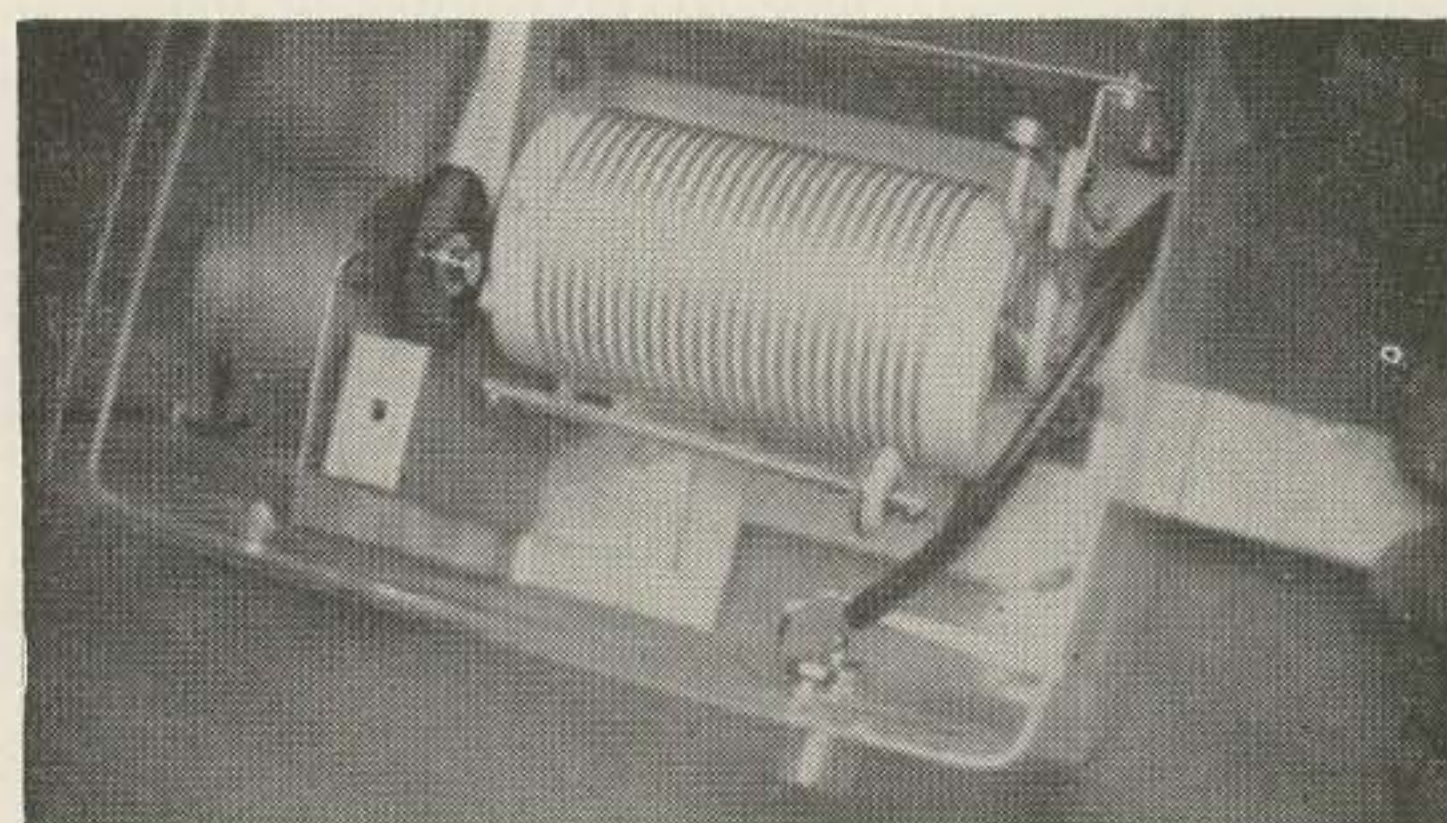

shack. This undistinguished bit of equipment was to provide the solution to this quasi-intricate dilemma. I realized that variable inductance, controlled remotely was feasible and extremely inexpensive.

The parts required are:

- 1 5" x 7½" x 4" plastic food container & cover
- 1 female co-ax connector
- 1 1-5 rpm motor (Barry's Elect. NYC, \$1.59)
- 2 right angle fittings constructed from scrap
 - a. 6 x 3 x 2¼"
 - b. 3½ x 2 x 1¼"

The right angle supporting the variable inductor is cut and tapped as per Fig. 1.

The small right angle is cut from scrap metal to provide the mounting for the motor. The dimensions are as per Fig. 2. In my case the
(Turn to page 58)

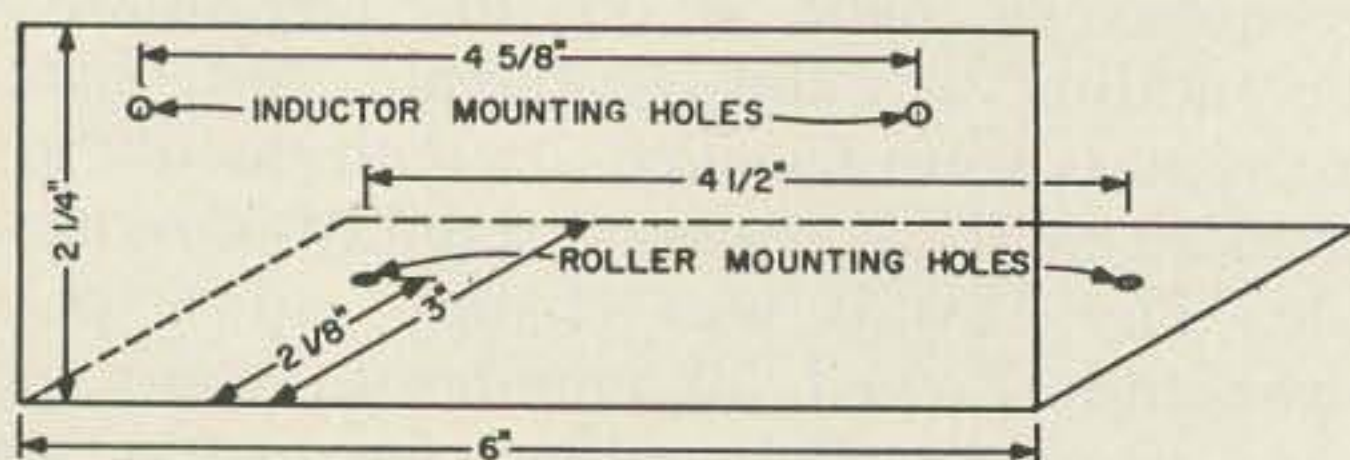

RIGHT ANGLE FOR VARIABLE INDUCTOR

FIGURE 1

Efficient Bandswitching

In building or designing that new band-switching transmitter, receiver, converter, signal generator and so forth with one or several bands at a VHF frequency, it is best that the leads be short and direct as possible, and the grid input and plate output wiring properly isolated from each other to obtain maximum circuit efficiency.

It often being the case, it is impossible to get that grid or plate circuit wired into the the bandswitch properly. A simple way to overcome this is to use one or more relays in conjunction with the bandswitch when switching to a VHF band. The relays can be a dpdt, spdt, or what we need for switch contacts, and by mounting the relay close to the grid input and plate output circuits this results into a well performing circuit.

To control the relays the band switch is wired up to energize the relay solenoid when switched to its band position on the band-switch. Six, 12 and 110 volt ac or dc relays will work okay and be sure that the current drain of the relay solenoid is low to prevent pitting of the bandswitch contacts.

... K4GRY

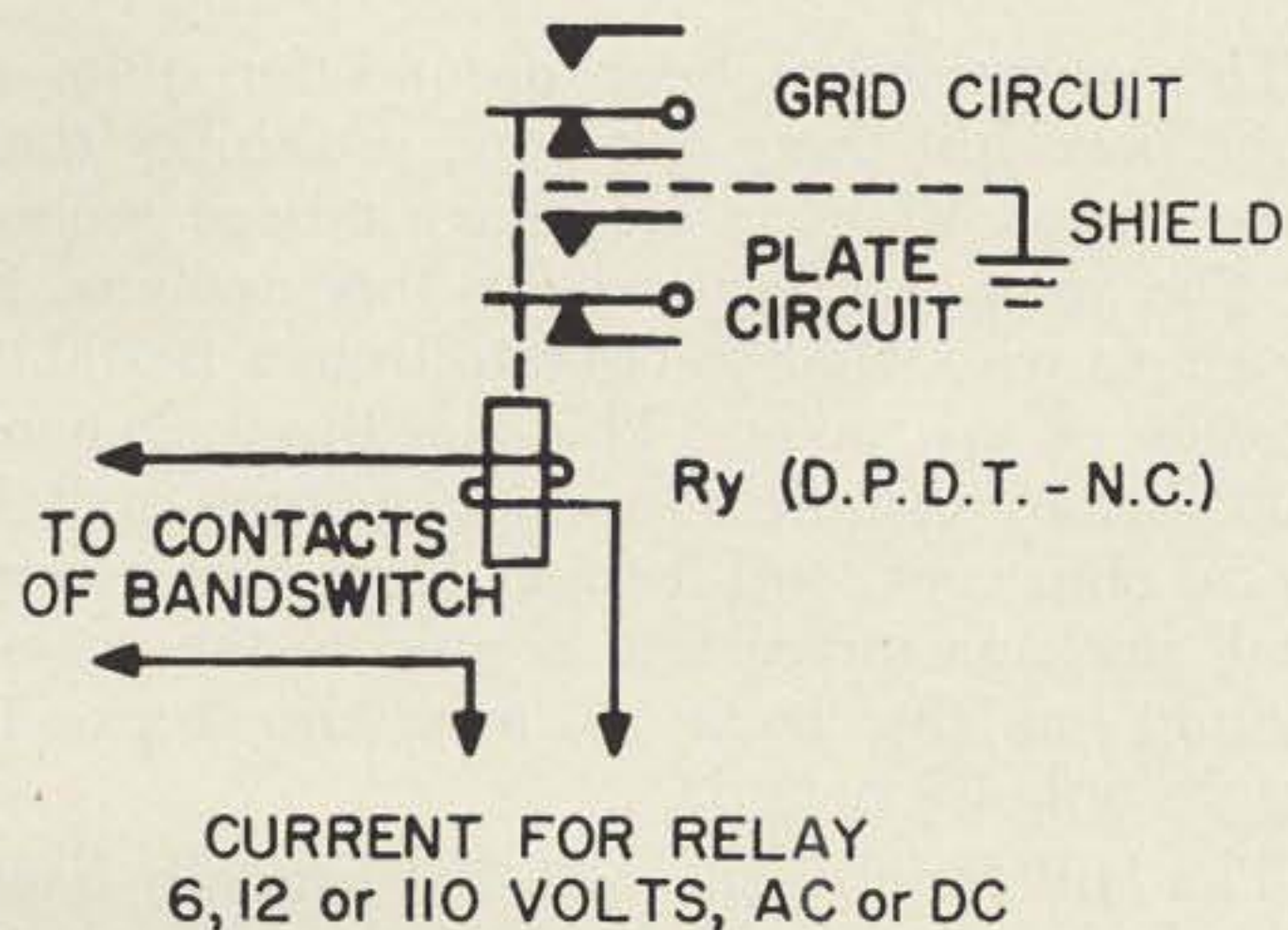

USE AS MANY RELAYS AS NECESSARY FOR LOW-LOSS BANDSWITCHING AT VHF.

P & H "Spitfire"

KILOWATT MOBILE
(or fixed)



LA-500M LINEAR AMPLIFIER

- ★ 1000 WATTS PEP POWER
- ★ SINGLE KNOB TUNING
- ★ BUILT IN ANTENNA SWITCHING
- ★ 6 TUBES IN GROUNDED GRID
- ★ LOW TUBE REPLACEMENT COST
- ★ CHROME PLATED CABINET 3"X12"X15"
- ★ REQUIRES 900 to 1200 VDC AT 500 MA AVERAGE — 1 AMP PEAK
- ★ AIRCRAFT TYPE METER ILLUMINATION

PRICE \$189.95

Amateur Net

Available NOW

Thru Your Distributor

Power Supplies For LA-500M

Model PS-1000 115 V.A.C. For Fixed Station \$119.95

Model PS-1000B 12 V.D.C. For Mobile Station \$179.95

P & H ELECTRONICS, INC.

424 COLUMBIA STREET • LAFAYETTE, INDIANA

TRANSISTORS *** NEW

I.F., Converter, switch, Audio—PNP—also high frequency. power*—2N1434, etc. CBS—20 Watt, 1.5 amp. Others, higher wattage. Brand New—original package—GUARANTEED—R.C.A., C.B.S., RAYTHEON, U.S. TRANSISTOR.

Full Leads.

2 K ohm volume control with switch (CTS) miniature printed circuit.

TERMS:* 3 for \$1.00

- Power Transistors, \$.60 each
 - volume control—3 for \$1.00
- Minimum order \$3.00 prepaid
Postage Free in U.S.

Parts for 2 Watt audio power amplifier \$3.00.

3 Transistors, including 1 power transistor, resistors and capacitors together with schematic. Can be built in a 2" x 2" box.

Write for additional catalog.

TRANSISTORS-UNLIMITED, CO.

POST OFFICE BOX #442,
GREAT NECK, L. I., NEW YORK

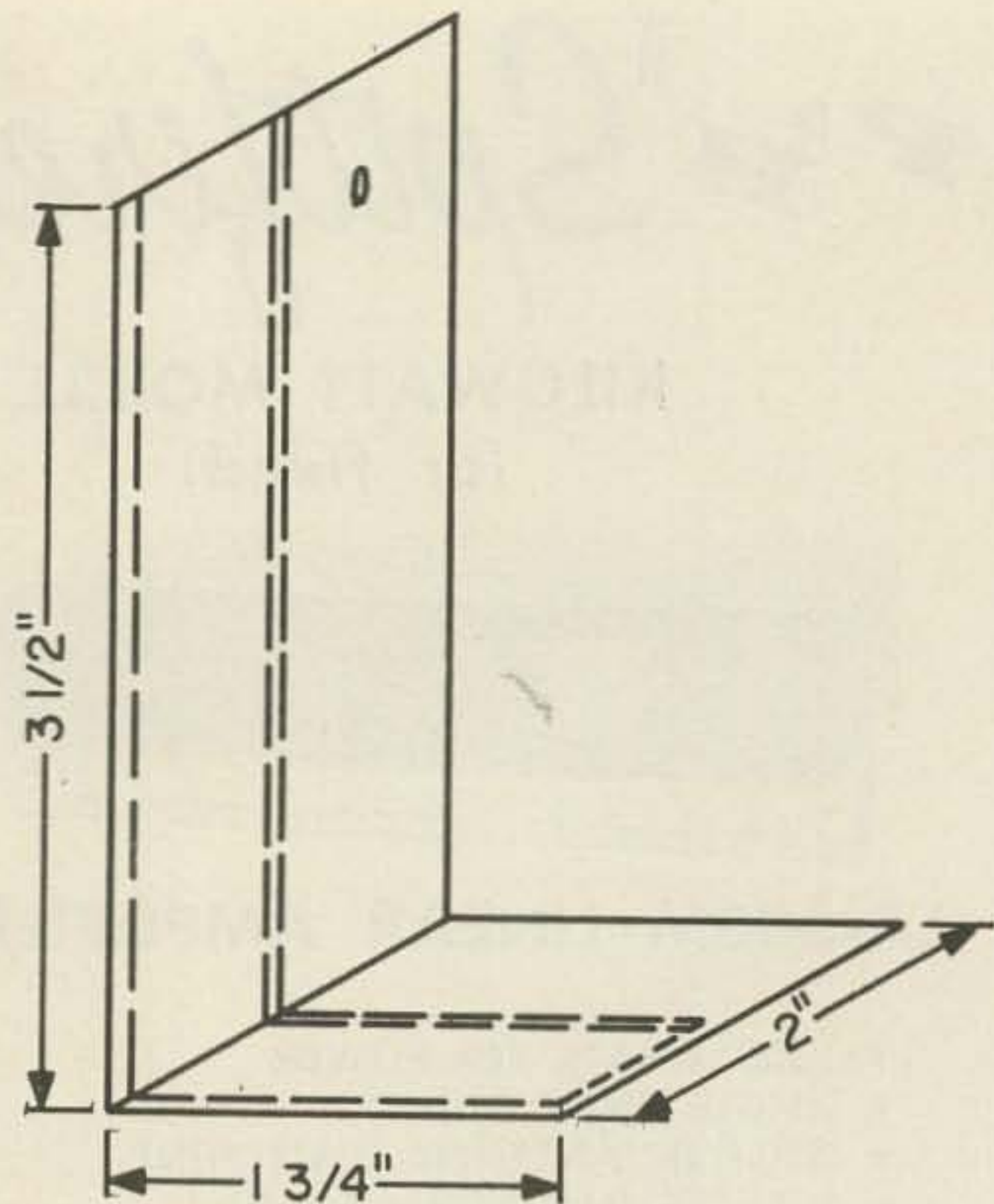

**MOTOR MOUNTING BRACKET
FIGURE 2**

sheet metal needed to be reinforced by a heavier angle. I felt it was easier to work with this material and later slip heavier gauge metal into position for the extra support. Needless to say, one could construct this support at the outset in a heavier material. The additional brace is portrayed by the dotted line in Fig. 2.

A careful examination of the roller indicated that the thumb wheel originally used to drive the inductor could be removed. This was tapped with a small drill and threaded roughly with a bolt of comparable size. This gear was then placed on the shaft of the motor with a bit of glue judiciously applied to lock this assembly. The motor and gear were then placed on the small right angle and only *one* hole was drilled to accommodate this mechanism. This was done to allow the motor to pivot on a lobed

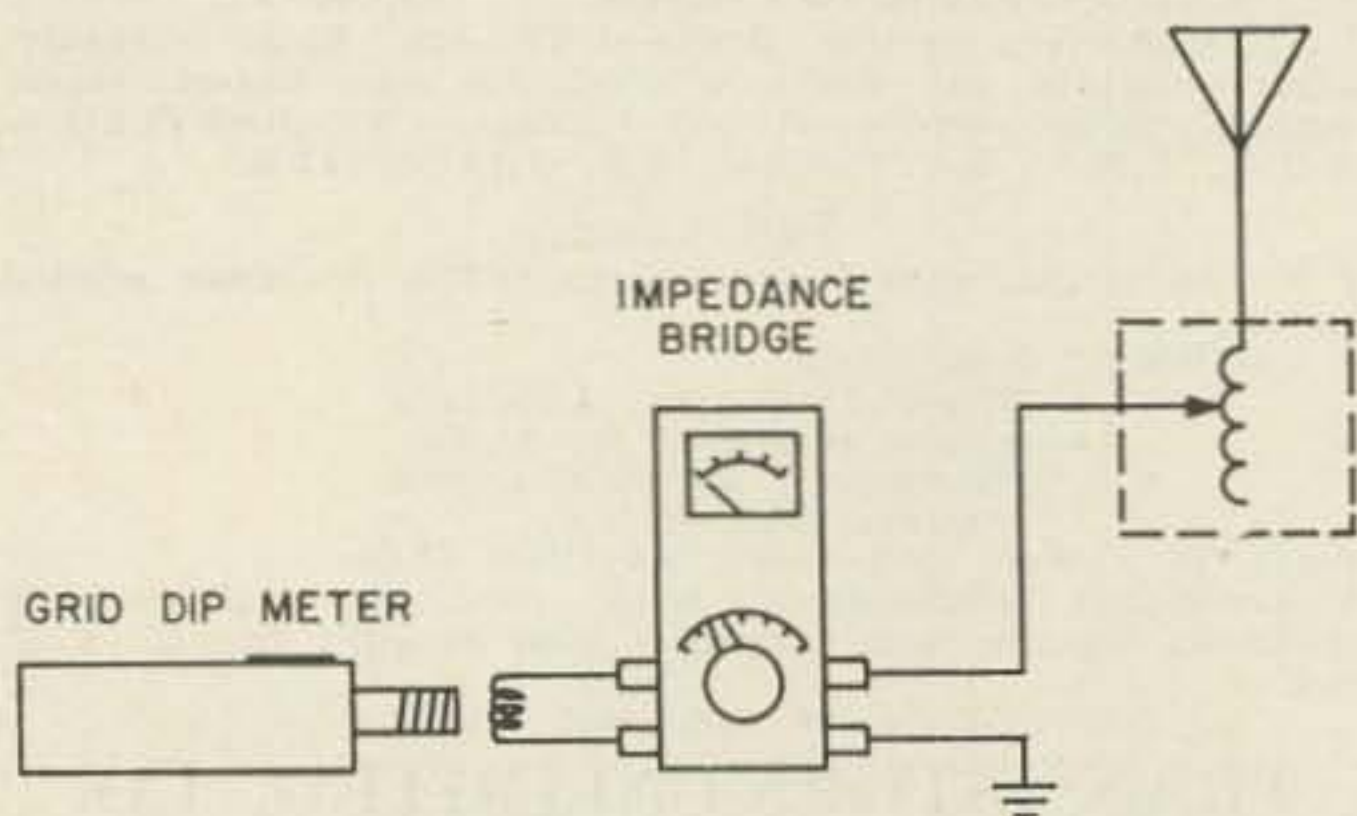

FIGURE 3

plane until a perfect mesh was made between the gears. The nut and bolt were then firmly tightened and to date (after hours of testing) have proved capable of support.

The system was then placed in the plastic food container for protection against the weather, and the bolts inserted through the large right angle, through the roller support, and terminated on the outside of the container. The result is an integrated unit ready for installation on the line, but only after a test run, for it is imperative that the two gears track well. This can be accomplished by bending the motor right angle support ever so slightly in order to accomplish proper working relationships.

The electrical connections are standard as per Fig. 3. The lead from the antenna is connected to one end of the coil (an arm is provided in the original equipment) and the coax fitting is connected to the roller. A length of cable provides the avenue for transmission of power.

With the variable inductor in place on its lofty perch, and protected within its plastic container, one need only plug in a 115 v line (connected to the motor) and watch his bridge. When the meter indicates a null, the plug is pulled from the socket and the radiating system is tuned to the desired frequency.

... WB2CQM

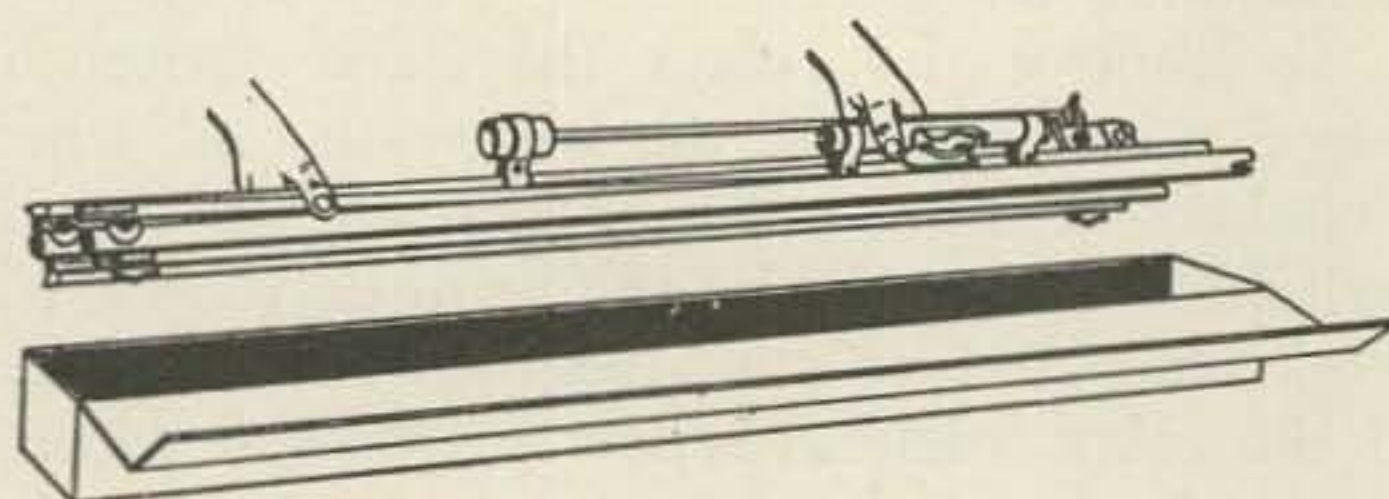

Hi-Par Hilltopper

This antenna has been around for quite a while now, but there is a good possibility that some of you VHF'ers may have missed seeing it. The main application for this antenna is for chaps who want to operate from a portable location on six meters. This is a three element Yagi beam, complete with a gamma match for 52 ohm coax, and it folds down into a very small package for carting around in the car or lugging on the back to mountain tops. It weighs only 3 3/4 pounds.

The Hilltopper is so small that I usually have it packed away in the back of the VW along with a Lafayette HE-45B, just in case any mountains happen to loom up during a trip. The other day, just for the heck of it, Virginia

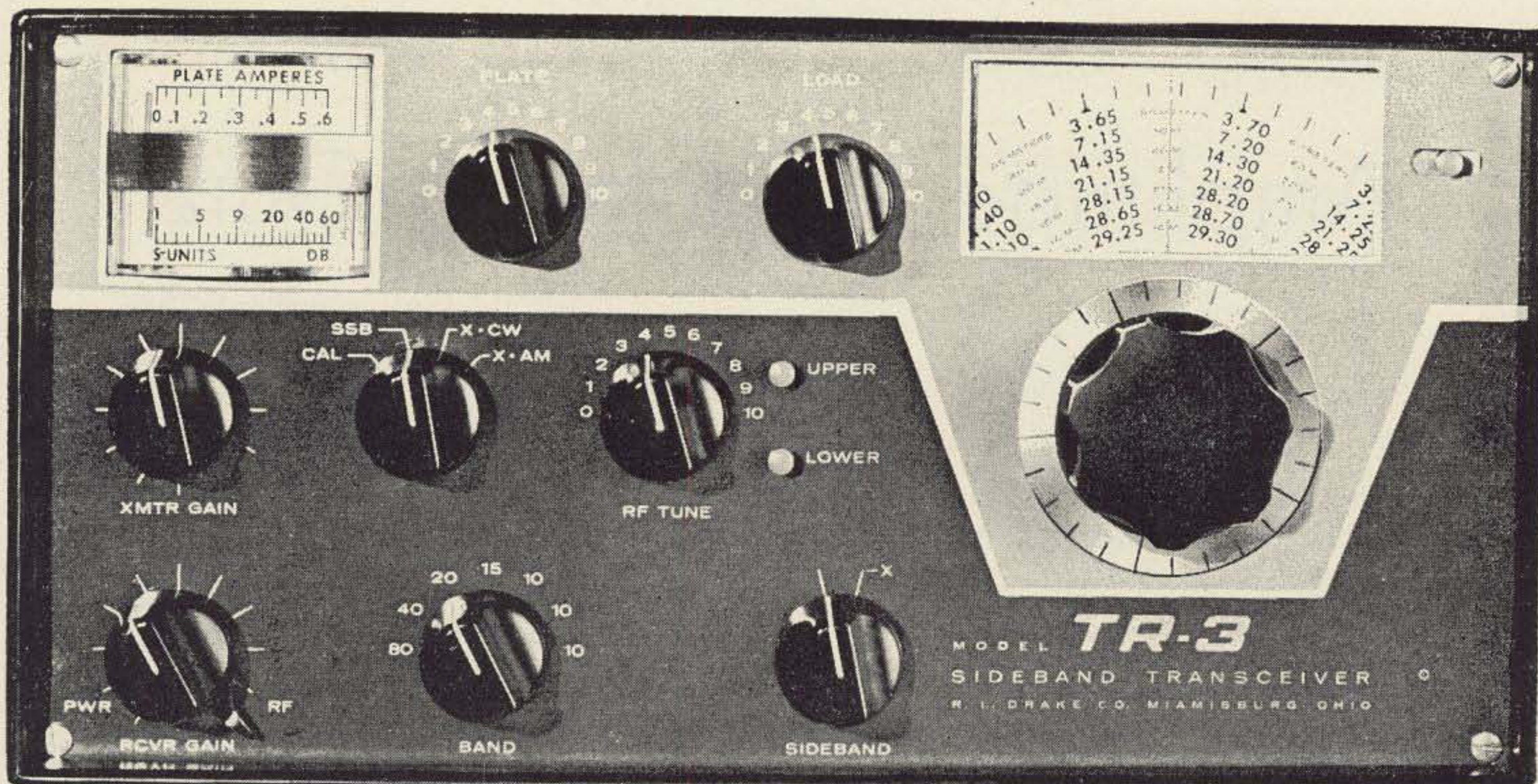

"We've Tried Them—They're Great!"

Buy Your DRAKE TR-3 From Us \$495 (Prepaid in U.S.A.)

SINCE 1933

FAST SERVICE

Phone CY 4-0464

QUEMENT ELECTRONICS

1000 SOUTH BASCOM AVENUE

SAN JOSE, CALIFORNIA

"Northern California's Most Complete Ham Store"

and I zipped up to the top of Pack Monadnock and within three minutes I was on the air. Stations well over a hundred miles away were worked with fine reports.

The beam takes less than two minutes to assemble. All of the screws are tightened with wing-nuts, so you don't have to fight with a screw-driver. The elements fold along the boom and the boom comes apart in the middle so that the package goes down to only 40" long, 3½" x 4½" square. The ends of the elements telescope in for folding.

Most rigs are designed to work with 52 ohm coax, so the built in gamma match solves a lot of problems that might be troublesome with the more common beams and their 300 ohm feed which would then have to be fed through a balun to the rig.

The Hilltopper was used exclusively during the June VHF QSO Party with the Clegg Thor and turned in a remarkable performance. 247 stations were contacted in 31 ARRL sections. When you consider that one of the most formidable six meter installations in the country also worked only 31 sections, using a kilowatt and a 64 element beam, the Hilltopper did amazingly well. Costs \$11.95 from Hi-Par, Fitchburg, Mass.

LOW FREQUENCY CRYSTALS IN HERMETICALLY SEALED HC-6/U HOLDERS. CRYSTALS SELL AT \$1.05 EACH POSTPAID USA. Please include 2nd choice. Frequency listed in kilocycles.

131.104	226.000	236.000	244.000	252.000	260.000	268.000
276.000	284.000	292.000	300.000	308.000	316.000	324.000
332.000	340.000	348.000	356.000	364.000	372.000	380.000
388.000	396.000	412.000	420.000	428.000	456.3000	773.958
831.250	816.667	859.375	1001.042	1400.000		

"73" SPECIAL LOW FREQUENCY CRYSTALS IN HERMETICALLY SEALED HC-6/U HOLDERS. CRYSTALS SELL AT 55c each postpaid USA. Include 2nd choice. Freq. in Kcs.

1843.750	2007.500	2070.250	2072.000	2075.000	2172.250	2172.500
2176.500	2185.625	2194.125	2202.583	2208.313	2212.063	2214.000
2214.563	2223.250	2243.500	2250.000	2265.250	2293.750	2681.000
2695.000	2715.000	2782.000	2855.000	2877.000	2887.000	2894.000
2990.000	2998.000	3000.000	3005.000	3020.000	3035.000	3052.500
3057.500	3143.5000	3154.500	3156.500	3158.500	3161.500	3166.000
3173.000	3181.250	3181.250	3203.500	3207.250	3217.500	3248.875
6000.000	7005.556	7083.333	7144.444	7258.333	8387.500	

LOW FREQUENCY CRYSTALS IN FT-243 HOLDERS. CRYSTALS SELL AT \$1.05 each postpaid USA. Please give 2nd choice selection. Freq. in Kcs.

1005	1010	1085	1100	1115	1125	1130	1200	1240	1400	1405
1440	1495	1500	1700	1705	1710	1765	1780	1820	1880	1890
1905	1910	1915	1920	1925	1930	1935	1940	1945	1950	1955
1960	1965	1970	1975	1980	1985	1990	2005	2010	2015	2020
2025	2030	2035	2040	2045	2050	2055	2060	2065	2070	2075
2080	2085	2090	2095	2100						

Your purchases will keep ads running. Service to Amateurs by an Amateur W3UGD

QUAKER ELECTRONICS

P.O. Box 215, Hunlock Creek, Penna.

Keep watching "73" for more down to earth prices on crystals

Amplitude Modulation Quiz

Carl Drumeller W5EHC
5824 N.W. 58th
Oklahoma City 22, Oklahoma

1. A sine wave fed into a modulator will cause the modulated RF envelope to resemble the following wave-form:

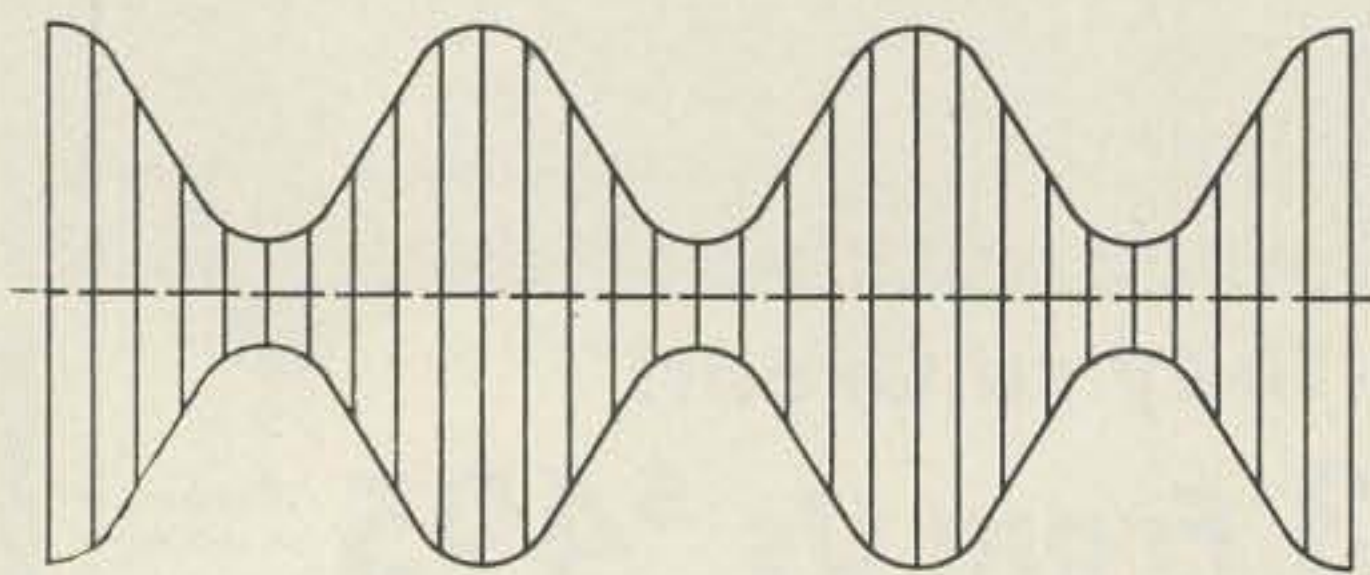

If the audio wave-form is not symmetrical but looks like this:

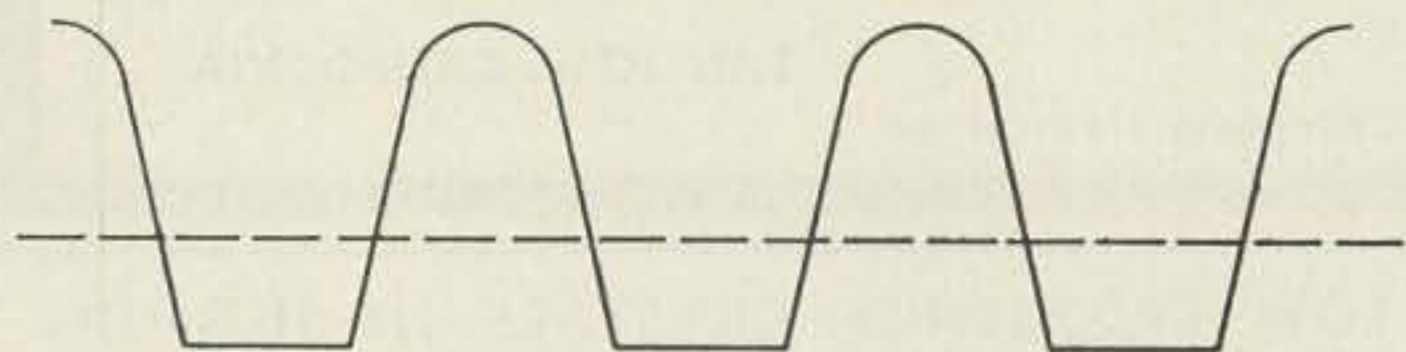

The modulated RF envelope then would look like this:

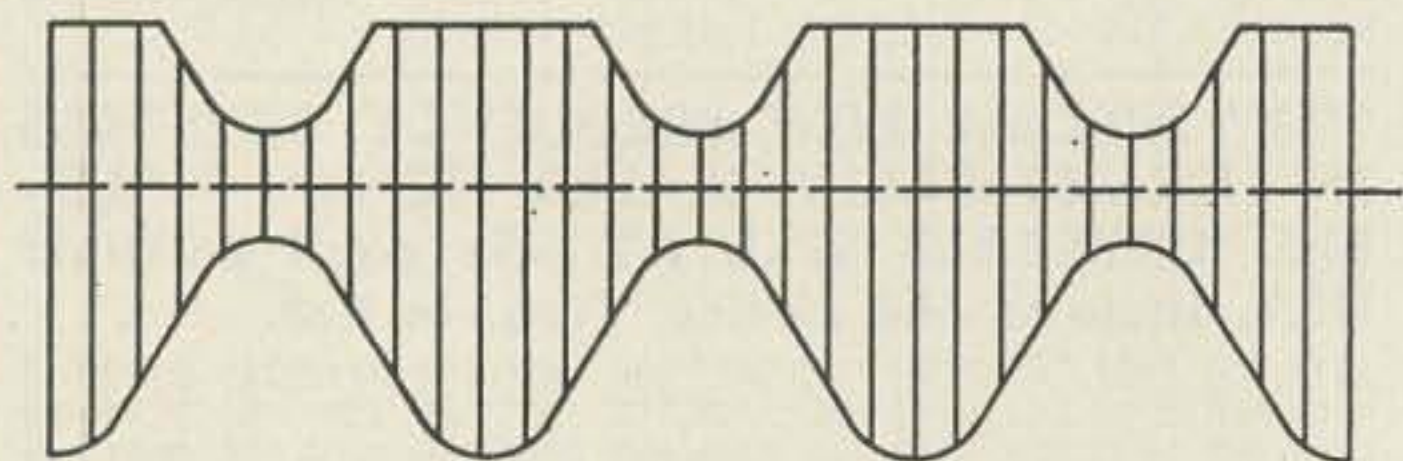

- True
 False

2. When a plate-modulated power amplifier is being modulated 100% by a sine wave, the instantaneous plate-to-cathode voltage, as read by an af (not rf) VTVM, will:
- A. Remain constant if the stage is properly adjusted.
 - B. Vary from 1.414 times the plate supply voltage to 0.707 times the plate supply voltage.
 - C. Vary between zero and twice the plate supply voltage.

3. The instantaneous peak rf power output of a plate-modulated rf power amplifier being modulated 100% by a sine wave is:
- A. Same as the average unmodulated power output.
 - B. Twice the average unmodulated power output.
 - C. Four times the average unmodulated power output.
4. "Sidebands" normally are present in the radiated output of every radiotelephone transmitter, even when the transmitter is properly adjusted and operated.
- True
 False
5. Production of harmonics of the normal rf operating frequency can be reduced by reducing the rf grid excitation to the modulated power amplifier. In view of this correct statement, the question is: "Can this be done to a plate-modulated rf power amplifier without causing its signal to occupy more than its normal share of the frequency spectrum?"
- Yes
 No
6. If the audio system of a radiotelephone transmitter is so operated as to cause the production of af harmonics within the audio system, this will cause the transmitter to produce rf harmonics.
- True
 False
7. The loss of one tube in a Class B push-pull audio modulator will cause the transmitter's rf envelope (as viewed on an oscilloscope) to appear non-symmetrical.
- True
 False
8. The loss of one tube in a Class B push-pull audio modulator will cause a reduction in the audio power produced by the modulator. In view of this true statement, the question is: "Will the total bandwidth of the radiated rf signal be greater than if both tubes were functioning normally?"
- Yes
 No

30th ANNIVERSARY OPEN HOUSE

for
RADIO
AMATEURS . . .

- ★ Personalized Service
- ★ Trade-ins
- ★ Time Payments
- ★ Engineering Dept.
- ★ Top Brand Lines

REFRESHMENTS & PRIZES!

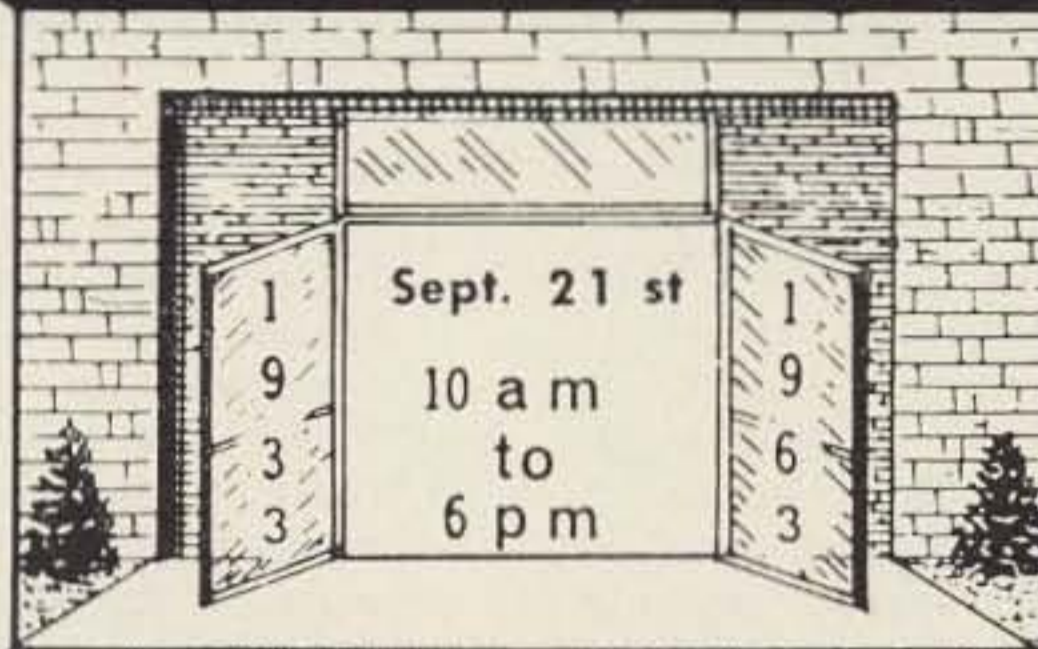

SERVICING
as well . . .

- ★ Dealers
- ★ Servicemen
- ★ Industry & Gov't.
- ★ Contractors
- ★ Hi-Fi Audiophiles
- ★ Citizens Band
- ★ Business Radio

EVANS RADIO

"Your Friendly Supplier"

ROUTES 3A, 89, & 93 ● BOW JUNCTION ● CONCORD, N. H.

COME PREPARED—MANY CASH SPECIALS

9. The dc milliammeter in the plate circuit of a plate-modulated rf power amplifier "wiggles" when the transmitter is modulated by a Class B modulator. Check each of the following items that you believe might cause an indication.

- ___ A. Too little rf grid excitation.
- ___ B. Too much rf grid excitation.
- ___ C. "Flat" tube in rf power amplifier (loss of cathode emission).
- ___ D. Over-modulation
- ___ E. Under-modulation.
- ___ F. Poor voltage regulation in the rf power amplifier power supply.

10. A conventional plate-modulated AM transmitter, with no phase modulation or frequency modulation present, sometimes will have more power in one sideband (upper or lower) than in the other sideband.

- ___ True
- ___ False

ANSWERS TO AMPLITUDE MODULATION QUIZ

1. The statement is false. Invariably, the lower half of the envelope of an amplitude-modulated rf wave-form will be a mirror-image of the upper half.
2. C. This is in accord with the explanation customarily given.

TRANSISTORIZED IGNITION SYSTEM for Cars - Trucks & Boats



- Boosts Engine Performance
- Reduces Fuel Consumption
- Increases Spark Plug Life
- Eliminates Engine Tune-ups
- Ends Bluing of Points
- Easily Converts to Conventional System
- More Efficient 2 Transistor Circuit
- Simple to Install & Service
- Fully Guaranteed

6-12V Neg Gnd. Only

\$39⁹⁵ NET

DISTRIBUTOR INQUIRIES INVITED

ALCO ELECTRONIC PRODUCTS INC.
LAWRENCE 3, MASS.

3. C. If, as in the conventional explanation of the process of plate modulation, it is assumed that the instantaneous plate-to-cathode voltage has been doubled at the positive peak of the audio modulating cycle, then the instantaneous plate current also will have been doubled. This, then, will cause the instantaneous peak power to be four times greater than the quiescent power.
4. This statement is, of course, true. Sidebands, an inevitable product of modulation, should never be confused with "splatter," a product of improper modulation.
5. The answer is no. To be plate-modulated, a stage must be operated Class C. This, among other things, means that it must have sufficient grid excitation to operate at full efficiency when the instantaneous plate voltage is double its normal value. All Class C stages deliver their rf power to the plate tank circuit in pulses. This, of course, predisposes toward the production of rf harmonics. This, in a well-designed transmitter, is minimized by the use of a tank circuit of proper Q. To drop the rf grid excitation sufficiently to make an appreciable improvement in the reduction of rf harmonics would require the stage to operate without sufficient rf drive to comply with the prerequisite. Therefore the rf output envelope would be "flattopped," causing the production of spurious frequencies far beyond the normal channel of legitimate sidebands.
6. This statement is false. There is no relationship between af harmonics in the audio systems and rf harmonics in the rf system.
7. This statement is false. As mentioned before, there always is symmetry between the upper and lower halves of the rf envelope from an amplitude-modulated transmitter.
8. The answer is yes. The loss of one tube in a Class B audio stage will cause the audio wave-form to be non-symmetrical, indicating the presence of harmonics.

These harmonics will cause the width of sidebands ancillary to the radiated rf signal to be many times their normal width.

9. Choice A is correct. Too little rf drive will not permit the dc plate current to rise fully on the positive crest of the modulating af wave-form. It can, however, go down the full amount. The average value, therefore, will be less than the resting value; so the meter "wiggles" with modulation.
Choice B is not correct. Too much grid excitation to a pentode or a tetrode tube can cause its total output to drop. This drop, however, would not be noticeable more on modulation peaks than at other times.
Choice C is correct. If the tube in the modulated stage is lacking in total cathode emission, it will not be able to supply sufficient plate current to permit the plate current to rise fully during positive modulation crests.
Choice D is correct. If the stage is operating in a husky Class C condition, the plate current can rise to more than twice its quiescent value on the positive modulation crests. It cannot, however, drop beyond zero on the negative modulation crests; therefore it will flicker during over-modulation.
Choice E is not correct. Under conditions of less than 100% modulation, the plate dc current meter of a plate-modulated Class C rf power amplifier should remain static. Any movement may be taken as an indication of malfunctioning.
Choice F is correct. This is a design problem, one that seldom is correctly solved in either amateur-built or commercially-built amateur transmitters.
10. This statement is false. An examination of the formula for an amplitude-modulated rf wave (available in any good electronic textbook) will show that the power in the upper sideband always is exactly equal to the power in the lower sideband.

Rotten CW*

**(with sincere apologies to the memory of T.O.M.)*

Alex Tremblay W1GQJ
27 North Avenue
St. Johnsbury, Vermont

With the renewed interest in amateur radio telegraphy and the advent on the market of several automatic telegraph keys, (including mine), it would seem very apropos to review the practices of many of the CW fraternity. Some of these habits are incredible. A lid with a bug at ten words per minute will still be a lid at forty-five per with a fully automatic key as he sends dots at a seventy word rate and dashes at a thirty-five word rate, with six dots for "H". A small minority uphold the finest amateur radio traditions by setting a good example either by their silence, when called for, or by their adherence to near perfection when using the International Morse Code.

Reaching all the way back to a book published in 1917, we come up with the interesting fact that a dash is equal in time duration to one

dot, one space and one dot. The space between characters (dots and dashes) is equal in time duration to one dot. The space between letters of the same word is equal in time duration to two dots (a dash). The space between words is equal in time duration to three dots (equal to A, N or S).

Now that we understand the makeup of perfect CW, let us analyze what is actually being sent on the Amateur bands. Here, we may pause and reflect on the plight of the handicapped. Some of this newly developed automatic code sending equipment should prove to be the "equalizer" that will help them in sending CW as well or better than the physically normal. Looking over any busy CW band, The Old Man (bless his memory) certainly would have complained about ROTTEN CW!

Your personal attention is a "must" at WRL. Our 18 hams are at your service day or nite. Write, phone, or wire.



Leo I. Meyerson, WØGFQ

WRL SELLS TO YOU DIRECT

Postpaid! *
\$15⁹⁵

"MULTI-PAK" PSA-63

Universal AC P.S. Silicon rectifiers. Dual HV 600V/300V @ 300Ma, 210W. Max. Bias 0-90 VAC. Also available customized for Swan, G76, etc. Wt. 15 lbs. Wired \$39.95.



\$24⁹⁵ Kit

ANTENNA TUNNER



Mini-Matcher MM-100 100 watt Kit. Matches end fed wires 1/2 wave or multiplies to 50-75 ohm coax. Xmtr. output. Steel case, 4x5x4". 150 watts SB, 100CW, 75AM. Wt. 3 lbs.

\$10⁹⁵

MK. II
WVG

All Band Vertical - Self supporting. Tunes to any amateur band 10 through 80 meters. Designed to be fed with 52 ohm coaxial cable. Maximum power 1KW AM, 2KW PEP. Overall height 18 ft. *Postpaid (Continental USA)

WRITE FOR OUR FREE FLYER & LIST OF OVER 1,000 PIECES OF QUALITY RECONDITIONED EQUIPMENT - TERMS - TRADES

TECH-CEIVER 6A

6 Meter Transceiver—Mobile—Fixed—Compact. Size; 5"H, 9 1/4"W, 6"D. 5W. input with 8Mc xtals, PTT. Rec. 1/2uv, tunes 49-54 Mc, AVC, ANL, stable, selective, speaker. Wt. 9 lbs. Less P.S. Kit \$39.95

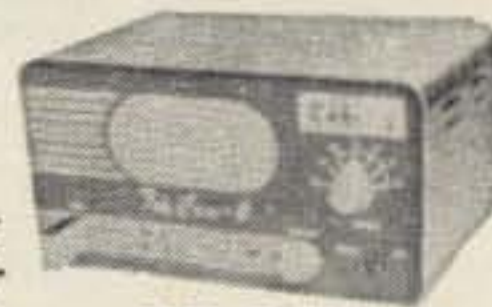

\$39⁹⁵

PREAMPLIFIER DB-68

Wired Preselector — 6-80 Meters. 6 triode tube sections for average 24DB gain. Tunable, built-in 115VAC P.S., coax or twin lead, illuminated dial. 6 3/4"x6-5/8"x7 1/2". Sh. wt. 10 lbs. 1 yr. parts warranty. WRL Import.



\$39⁹⁵

WRL

WORLD RADIO LABORATORIES, Inc.

3415 W. B'dway • Council Bluffs, Ia.

Leo, sell me direct Deskkit Q Multiplier On-The-Air Box Multi-Pak P.S. Tech-Ceiver 6A Add to my Charg-A-Plan Check enclosed Additional information on _____ . FOB WRL C 12

Name _____ Call _____

Address _____

City _____ State _____

The complaint would be perfectly justified in the light of present day technology which has given us exotic (imagine!!) instruments to help us send perfect code.

Careful listening will turn up some interesting facts:

1. The letter H has three to twelve dots.
2. The letter S has two to five dots.
3. The letter C often comes out N N.
4. The word TEST sounds like NV; always!!
5. The word AND should always be sent: PD.
6. NAME should usually come out: NAG!!
7. The numeral 3 sounds like a Swedish call sign.
8. The first dash sent with a sideswiper should always be extra long and the last dash in any character should always be cut off a bit short (Sounds like an idiotic pastime, already!)
9. A string of dots from a sideswiper should be either erratic or slurred. (7, 8 and 9 are supposed to make you sound like a real old-timer.)

Heaven forbid that all CW men should send exactly alike. The individuality shown is a good thing, BUT, gentlemen—dashes THREE dashes long; just because you once sent Land Morse for the railroad—wel-l-l . . . Those operators

produced by radio club action quite often sound just like their teacher. When they finally get their own "ticket," they will all have the short dots, long dashes and triple spacing just like they heard it at the club.

A few of our so-called speed merchants also have some odd habits which may mislead listeners into thinking that RTTY is not necessary with these fellows around. In order to figure how fast these people are going, we will have to know at what rate per second dots and dashes should be sent in order to accomplish a certain "word per minute" rate. The answer is simply that the number of dashes per second, times five, equals the word per minute rate. An easier way is to look at the sweep second hand of a watch or clock and run dashes for five seconds while counting them. The number of dashes in that period is your "word per minute" rate providing you send at that rate for a full minute. The dots will have to be twice as numerous in the same period. Each word averages five letters.

One night recently, one station, with a near perfect first was pounding a bug at an eight dash per second speed for a "word per minute" rate of forty, and, in each minute managed to send 195 letters. Dividing this total by five gave 39 words per minute. Subtracting an error

and a repeated word, the net words was thirty-eight. Most operators would consider this quite an accomplishment. The other station, using a fully automatic key was doing twelve dashes per second for a word per minute rate of sixty while putting in some extra spacing. The total letters per minute came to 220 instead of the nearly 300 expected. Dividing this total by five gave a result of forty-four for each minute and subtracting four words in error, we came up with a total of only forty words for each minute. Considering all the noise that was being made on the frequency, it was reasonable to expect a lot of words go with it.

A few stations are the practitioners of an unusual habit. They apparently never extend their acquaintance beyond one, and at the most, two, other hams and always on the same band and same frequency. This is such an odd phenomenon in contrast to the familiar "hail and farewell" of a lot of operators, that it was decided to "read the mail." These two birds were only doing a rough twenty-five per, but they could have been sending in Chocktaw for all that was gained by listening. Their sending was so erratic that only by picking them up for a little while during several evenings was it finally possible to make out their call signs. Errors were made in nearly every word and about every third word was split in two and sent as part of the next word, presumably because the sender had to stop and figure how to spell it. The speed varied between extra long dashes and bursts of dots with short and long spacing. Evidently, these two understood only each other as they were never heard working any other station. Here was a horrible example of "rotten CW" at its worst. But, it had its good side in displaying for all to hear the liberties that can be enjoyed so long as they do not infringe on the liberties of others. Such "rotten" operating would undoubtedly call for the FCC to decide that in view of the fact that its monitoring facilities could not understand what was being sent, it **MUST** be in code or cipher in violation of section 12.105 of the Amateur Radio Regulations. These people could then be rehabilitated and soon become outstanding operators at thirteen per in the International Morse Code.

While we are on the subject of the FCC, mention should be made of section 12.133 that has to do with purity and stability of emissions. Many hams have not heard of this, or if they have, the part that they particularly noticed is the one that says: "For the purposes of this section a spurious radiation is *any* radiation from a transmitter which is *outside* the frequency band of emission normal for the type

of transmission employed, etc." To them, this must mean that any type of carrier with thumps, clicks, youps, musical saw effects, rattling marbles from bouncing relays, scratching from dirty contacts, backwaves forty kilocycles removed from carrier due to parasitics, etc., is OK so long as these "bonuses" remain within the boundaries of the band being used. One can only wonder if these lads will ever realize just how much noise they are making over and above that amount needed for reliable communication.

Back in the thirties, a real op felt definitely undressed unless he wore, while on the air, the latest model Dynatron frequency-meter-monitor. It must be that the monitor habit perished during WW2 as witness even some real oldtimers who go by the click in their "cans," asking; "Hw duz mi sig snd to u om?" Apparently, many never knew or have forgotten that a monitor was originally (and still is) a device with tuned circuits which picked up your signal OFF the air and let you know what it really sounded like. That small standby five tube receiver which has been collecting dust can now come into its own. With a very short antenna attached and usually with no antenna whatsoever, it becomes an excellent tuned CW monitor. Sliding off one can a bit, its speaker will let you know how your own rig is doing.

There is little doubt that a sidetone generator helps in sending better code, especially in conjunction with a fully automatic key. (This is so much fun that sometimes the spacing between words is left out.) The statement is made that the sidetone proves by its tape-like sound that good code is being sent. Sure! Sure, the sidetone sounds perfect but what does the actual transmitted signal sound like? "Soam, hw duz mi sig snd to u?"—"Your characters are perfectly formed, your spacing is out of (indeed) this world BUT you've got a backwave that sounds like the guy slamming the car door on a TV commercial."—Wonder how much of that showed up in the speaker of his sidetone generator. A real Radio Frequency Monitor, tuned or untuned, will not only help you send better code, but will also tell you what a lid you are until you clean up your signal. This last may be the main reason for the lack of monitoring facilities at those stations where the need is greatest.

Maximum utility can be realized by keying in one of the low power stages; preferably the oscillator or oscillator/first buffer. Automatic or fixed bias or a clamp tube become a "must" on the following stages, but the extra effort is well worthwhile considering the flexibility obtained. This brings up the question from many

MARS CONTROL CONSOLE

\$5750



The Mars Control Console contains in one unit a Kilowatt SWR Bridge measuring both 52 or 75 ohms—Hybrid phone patch—Internal speaker with provision to switch to external speaker if desired, plus several switches for control of xmtr, receiver, etc. as desired. All this at an amazing low price.

PAUSAN COMPANY

MARS MOBILE TRANSMITTER

\$5950



The popular MARS Mobile re-appears in a new dress and improved design. Bandswitching 75-40 with 18 watts input and plenty of good audio. Measures only 3½ x 5 x 7. Switches to either 6 or 12 volt operation. Requires 300 volts at 150 mills. Completely wired ready to operate less crystal mike and power supply.

SAN RAFAEL CALIF.

hams who wonder why they get a "ee-youp" report when keying the oscillator. Many of them run a full gallon and they complain that their lights blink in time with the keying. Here is visible evidence that there is so much voltage drop on the ac side of the power supplies that not enough dc is supplied to the VR tubes to give them anything to regulate. As a consequence, the oscillator "ee-youps"! These boys need to know a lot about adequate wiring.

Differentius Keyitis is the prodigious name of an affliction borne by one who can be heard most any time adjusting (he claims) his keying characteristics. He also, must be without a monitor because he is always in doubt as to the quality of his signal. One of these has a voltage regulation problem plus a bouncing relay contact. It has often been hinted that he sounds like a musical saw with the "beat" like loose marbles in a paper bag. The musical ear must be lacking because the signal quality never improves. The real contemptible cad though, is the habitual vfo swisher who can never be identified except during a contest.

The fully automatics come in for their share of criticism as they adjust their monsters by making endless strings of dots and dashes on the Ham bands while performing these adjustments. The trick is to achieve perfection in the generation of pulses which eventually become dots and dashes. This search for the ultimate does set an example of some sort, but, it should be remembered that we are using this medium not for extreme accuracy for a shot around the moon, but for normal conversation and traffic handling.

This points up several facts absorbed during

thirty years of hamming, plus fifteen years previously spent in various experiments. This included (while still in grammar school) the building and operating of a Model "T" Spark rig which used to put old KDKA, WGY etc., off the air locally until an alert constabulary ferretted us out!!!

- FACT 1. A poor note can not only be tolerated but actually enjoyed if from an old friend who has not been heard in a long time. He will be glad to know what his signal sounds like so he can apply corrective measures.
2. Good CW is extremely enjoyable if there is a very slight variation in character lengths, spacing, etc., indicating that a human is manipulating the key. This becomes even more interesting if the operator actually has something to say besides commenting on: the wx, band condx and rig hr is a blankit rng 15Z? ? ? 1H7 . . . 157 watts to a ---
3. Perfect code from a machine is an enduring joy to copy if the receiving end also consists of a machine.
4. Abbreviating the characters on your new automatic so as to sound fully automated will not get you too many ragchews. Try sounding like people again. You will be pleasantly surprised at the results.
5. While the technical prowess of a 'phone operator does not depend on the "DB's over S9" his receiver indicates; when using a key, all the way from the "hand pump" to the most exotic automatic, your CW is *YOU!*



Capt. John Sury W5JSN
139 Nebraska Rd.
Dyess AFB, Texas

Monitor Scope

Have you been thinking about building a monitor scope? This may be the project just for you. Not a whole lot of effort or pocket funds are needed. It sure is nice to monitor your own signal when transmitting as well as helping your fellow hams with their signal. The monitor will not take up much space in your shack because it only measures 5" high by 5" wide by 9½" deep. It could keep you from getting a notice from an "OO."

On transmissions the scope can monitor signals from 80 thru 2 meters. A choke of approximately 1 mh is employed in the input to the crt when transmitting on SSB on the 40, 20 and 15 meter bands and a plug in tuned circuit on 80, 40, 10, 6 and 2 meters. Hams who only work 15 and 20 do not need the tuned circuit. Using a Heath Seneca 6 and 2 a desirable wave shape was observed when modulating normally, but when hitting it hard the peaks were cut off as a result of over modulation. A beautiful trapezoid was observed on SSB. In receive a series of trapezoids were observed on SSB and a series of envelopes on AM. When using a plate modulated transmitter the modulation may be fed to the horizontal and the rf to the vertical. This has not been attempted by the

author because he does not own a plate modulated transmitter.

The horizontal sweep generator is a sawtooth wave shape which is variable between 15 and 50 cps. A 30 cps sweep produces a clean trapezoid, envelope or carrier.

Let's get with the building by starting with the chassis. You can purchase a ready made 5 x 9½ x 2" aluminum chassis at your neighborhood electronics store. Drill and cut out all holes as indicated in the chassis layout. It sure can save you a lot of trouble because the author had quite a time trying to locate everything on this small chassis. Obtain some panel

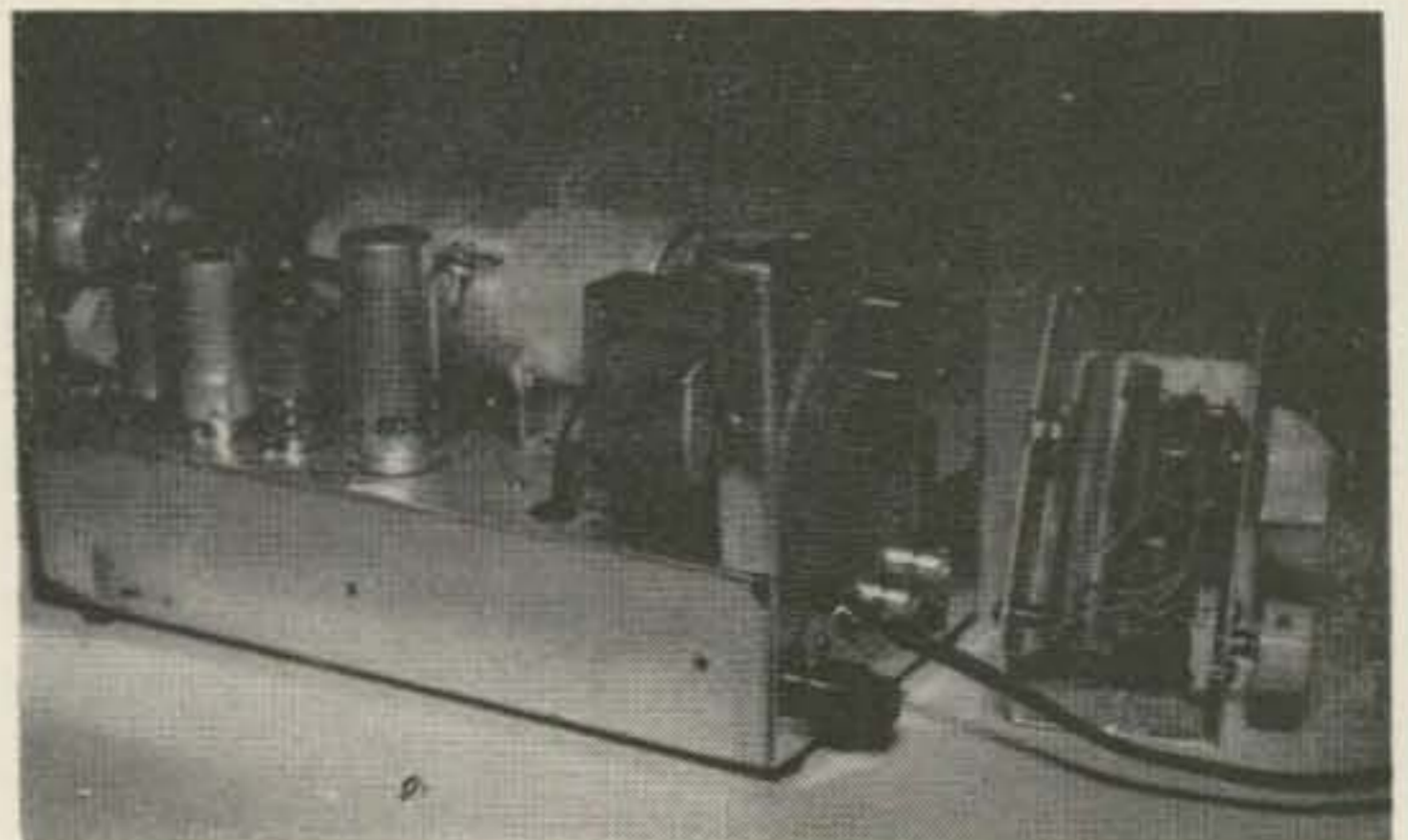

material, 1/16 to 1/8 inch thick aluminum, and cut out all holes as indicated. Lay aside the front and rear panels and install transformer, sockets and terminal strips. A bag of 25 assorted terminal strips may be purchased at an electronic supply house for less than a half of a dollar. In one of these bags you can find the ones just to fit your needs.

Power Supply

This is a low voltage supply as scopes go. A Knight transformer furnishes 125v each side of center tap at 25 ma and 6.3 volts at 1 amp. Even though the current for all tubes total 1.2 amp for filament, the scope has been left on for hours without ill effects or overheating. A voltage doubler is taken off one end of the secondary to give approximately 480v to the crt circuit while the low voltage is obtained from

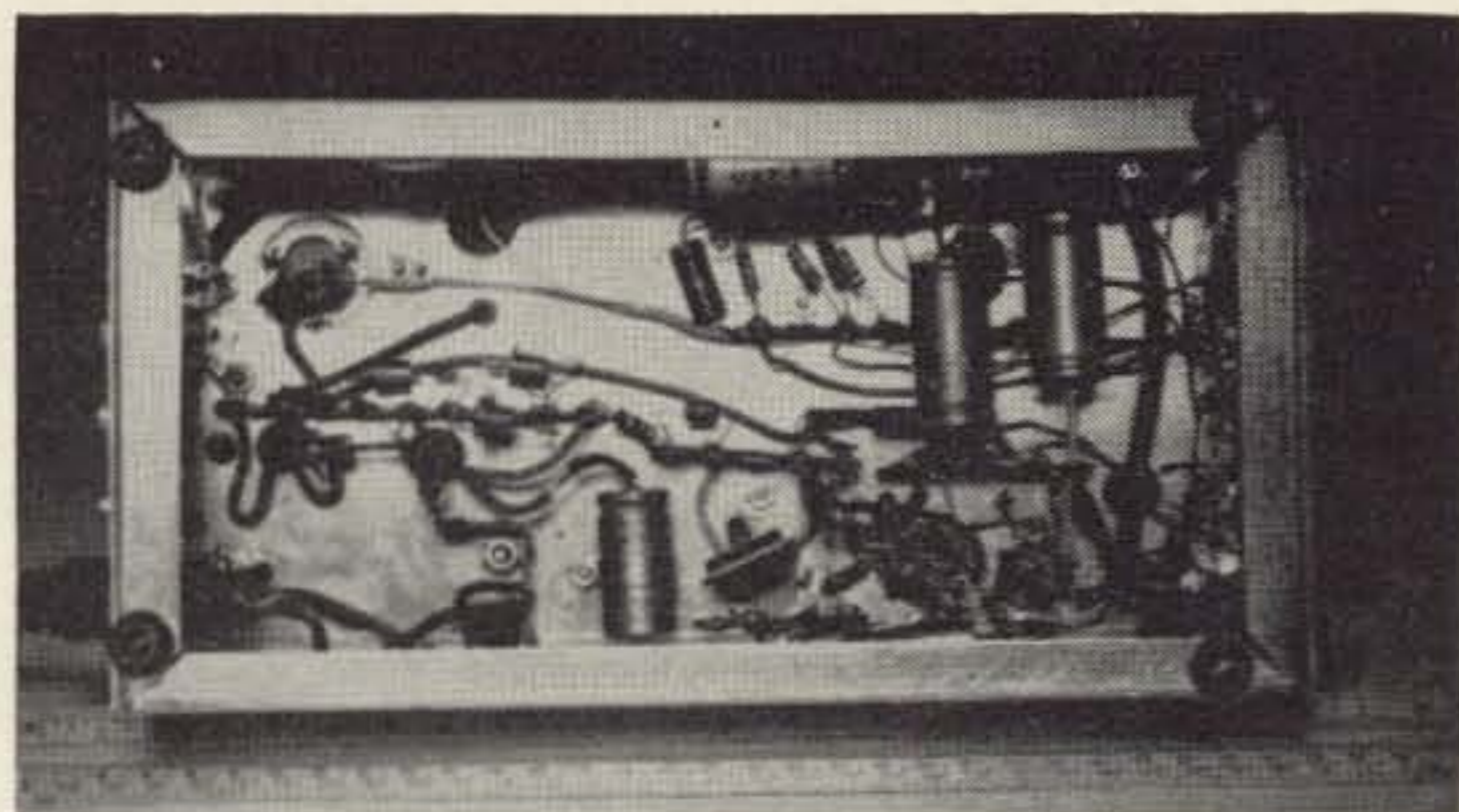

the center tap. The crt has more than enough brightness and response. Bargain basement silicon power diodes are used for the power supply.

The CRT circuit is just the old standard circuit used on many scopes. A 2AP1 tube or equivalent is used. The 2AP1's were readily available at one time on the surplus market.

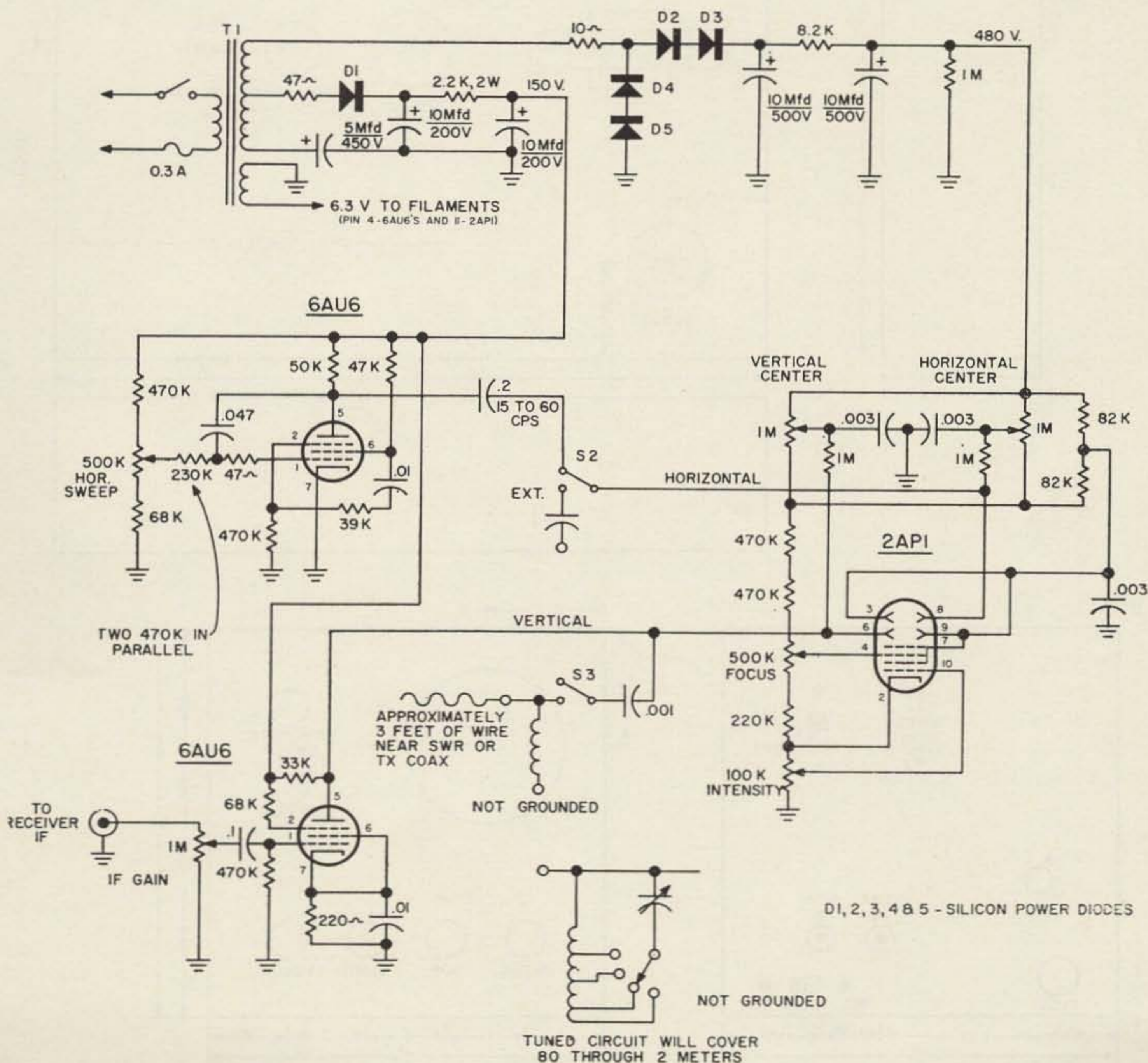

MONITOR SCOPE
FIGURE 1

We Goofed! AND THEN You Goofed!



YES we were frank to admit our mistakes in July 73. So we tried to make it up to you and those of you who missed in July had another chance in August. See our full page "GOOF UP" ads in both issues for details!

HOWEVER there is still lots of goodies left and we are even lowering the "BROOM" on some of them. We ask you to simply compare these prices with those of any other ham supplier. Even the cheap and dirty ones can't match these.

WE have the "BIG BROOM" out now for sure and are going for a "CLEAN SWEEP" this time. All, used gear is fully reconditioned and guaranteed 100%. The new gear is new and (confidentially) so are the demonstrators. We know these prices look too low but frankly we just want to sell out and start over.

OF COURSE these prices are for cash and no trade but man what bargains they are!!!!

—73—

Stan Burghardt W ϕ BJV

OUT THEY GO!

RECONDITIONED 100% GUARANTEED TRADE-IN'S

Special Cash Price	Special Cash Price	Special Cash Price	Special Cash Price
Central Electronics 20A Exciter 119.00	Gonset G-66 & G-77 Mobile pkg. 179.00	Hammarlund HQ-110C Receiver 149.00	Knight VFO 19.00
Central Electronics MM1 Scope 49.00	Gonset G66B 12 vdc supply \$99.00	Hammarlund HQ-110 Receiver 139.00	Mosley CM-1 & spkr. Receiver 135.00
Central Electronics VFO 29.00	Gonset GSB-101 KW Linear 199.00	Hammarlund S-100 spkr. 5.00	National NC-400 Receiver 295.00
Collins 75A1 Receiver 189.00	Hallicrafters HT-37 Transmitter 349.00	Harvey Wells T90 Xmtr 12 vdc 89.00	P&H LA-400C linear amplifier 169.00
Collins 75A4 Receiver 375.00	Hallicrafters S85 Receiver 69.00	James C-1050 supply 10.00	Swan SW-120 159.00
Collins 312B-2 Console 49.00	Hallicrafters SX-99 Receiver 79.00	Johnson 114-520 Automatic key 10.00	Swan 175/Topaz dc 229.00
Collins 270G-3 Speaker 8.00	Hallicrafters SX-99 & spkr. 84.00	Johnson Viking II Transmitter 139.00	Swan 175/Heath HP10 dc & HP20 ac 229.00
Collins 270G-1 Sneaker 5.00	Hallicrafters SX-71 Receiver 89.00	Johnson Invader 2000 2 Kw Pep 595.00	Tecraft TR-20-50 6mtr xmtr. 29.00
Elmac AF-67 Mobile Transmitter 79.00	Hallicrafters S-53A Receiver 39.00	Johnson Invader 200 Transmitter 399.00	Vibroplex orig STD & case 15.00
Elmac A-54H Mobile Transmitter 39.00	Hallicrafters R-46B spkr. 6.00	Johnson Viking I (as is) 59.00	Ameco CB6 6 meter Converter & Supply 19.00
Elmac PSA500 AC Supply 15.00	Hallicrafters SX-101 MK IIIA 199.00	Johnson Viking I Xmtr. 99.00	Collins 30L1 Linear 375.00
Globe 755A VFO 25.00			Globe 65A Transmitter 29.00
Globe AT-3 Antenna Tuner 5.00			National NC109 Receiver & Speaker 89.00

SPECIAL CLOSEOUT BRAND NEW EQUIPMENT

Item	Regular Net	Special Cash Price	Item	Regular Net	Special Cash Price
Bud CR1741G Cabinet	16.20	8.00	Hallicrafters SR150 Transceiver	650.00	495.00
Clegg Zeus 6/2 Transmitter	695.00	565.00	Johnson Invader 200	619.00	449.00
Clegg Interceptor 6/2 Receiver	473.00	385.00	National NC270 Receiver	279.95	179.00
Clegg Thor 6 Transceiver/AC supply	349.95	279.00	Swan SW-120 Transceiver	275.00	179.00
Gonset GR211 Receiver	76.98	39.00	Swan SW-140 Transceiver	275.00	179.00

SPECIALS ON DEMONSTRATORS ALL LIKE NEW WITH GUARANTEE

Item	Regular Net	Special Cash Price	Item	Regular Net	Special Cash Price
Collins KWM-2 Transceiver	1150.00	895.00	Hallicrafters SX-117 Receiver	389.00	275.00
Collins 62S-1 6/2 Converter	895.00	749.00	Hallicrafters HT-40 Transmitter	109.95	79.00
Hallicrafters S-108 Receiver	139.95	99.00	Hallicrafters SX-140K Receiver Kit	114.95	69.00
Hallicrafters HA-6 6mtr Transceiver	349.50	199.00	Hammarlund HX-50	449.50	299.00
Hallicrafters SX-111 Receiver	279.95	179.00	Hunter Bandit 2000A Linear	575.00	449.00
Hallicrafters S-119 Receiver	49.95	29.00	Loudenboomer KW Linear with power supply	438.00	338.00
Hallicrafters C-119 Receiver Kit	39.95	24.00			

See our ad in the June issue of 73 for complete price information and pictures of the Transceiver Hit Parade. Be sure to send for our "Transceiver Packet" which gives full information on the leading brands. And, if you really want to make yourself drool, send for our New Equipment Catalog and our revised monthly Used Gear Bulletin.

All subject to prior sale

AMERICA'S MOST RELIABLE DEALER



BOX 37A, WATERTOWN, SOUTH DAKOTA

PHONE
Area Code 605
TU 6-5749

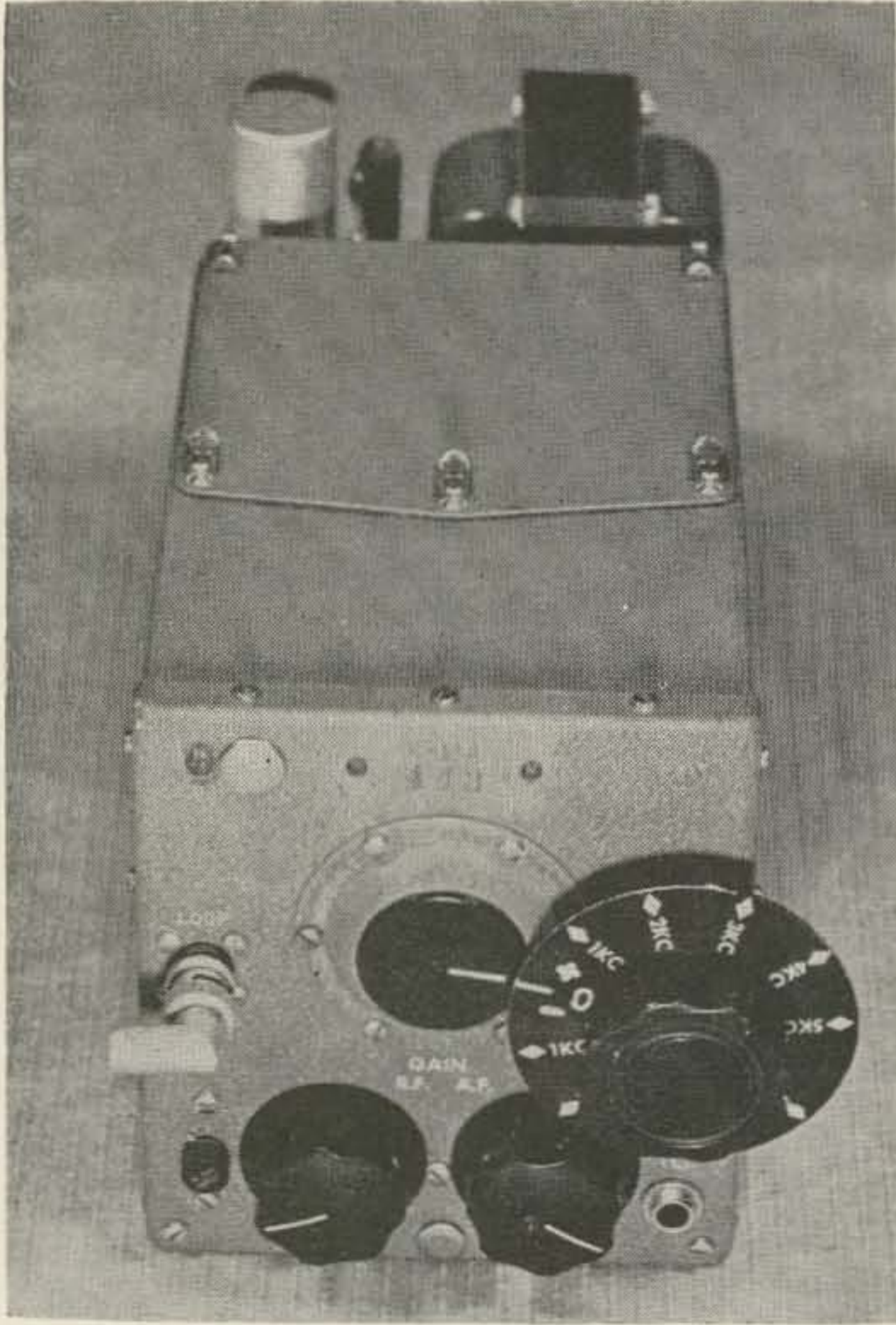

The completed Q5-er conversion.

A late entry to the famous Command Set line-up is the Aircraft Radio Corporation Type 12 equipment. This is a commercial, light aircraft radio set consisting of a number of individual components that can be arranged to meet navigational, VHF and UHF requirements.

Certain of these postwar production, navigation and VHF radio components were adopted by the military services for light aircraft use. It should be noted that, while the equipment is commonly known as the ARC-12, this is a commercial designation and not the military nomenclature. Although not treated in this article, one grouping of this equipment provides two-way UHF communications. This equipment has been designated as the AN/ARC-60.

Since some of the items are entering the surplus market, they are worthy of amateur attention. The R-510/ARC and the R-511/ARC are likely to be available to the amateur in fair quantity. The VHF equipment is now available in small quantities but the light aircraft market will probably absorb most of the supply.

The ARC-12 equipment is beautifully constructed, using loctal tubes and circuitry which is improved over the BC-435-R-23/ARC pro-

The Q-5er Reborn

Roy Pafenberg W4WKM
316 Stratford Avenue
Fairfax, Virginia

Photos by Morgan S. Gassman, Jr.

totypes. Changes required to adapt this unit to amateur use will be mentioned later. Physical construction is very similar to the earlier Command Set receivers. The rear chassis connector has been eliminated and all connectors appear on the front panel. No dial scale or dial drive is included on this series of receivers, although the conventional worm drive is provided for the tuning capacitor. Two antenna inputs are supplied. A low impedance loop input is terminated on a BNC coaxial fitting and the long wire antenna input is connected to a front panel binding post. An internal relay switches between the two inputs. The photographs show construction details of the unmodified R-511/ARC receiver.

Aside from the limitations imposed by the lack of a bfo circuit, any of the standard Q5-er modifications are applicable to the receiver and good results may be expected. Conversion of these receivers follows the same pattern as for the more familiar Command Set receivers. A power supply must be constructed for operation from the 115 volt line and the dynamotor mounting plate provides a suitable chassis. Incidentally, the dynamotor mounting dimensions and connections are identical to those of the AN/ARC-5 dynamotor. The power connectors are removed from the front panel, audio and rf

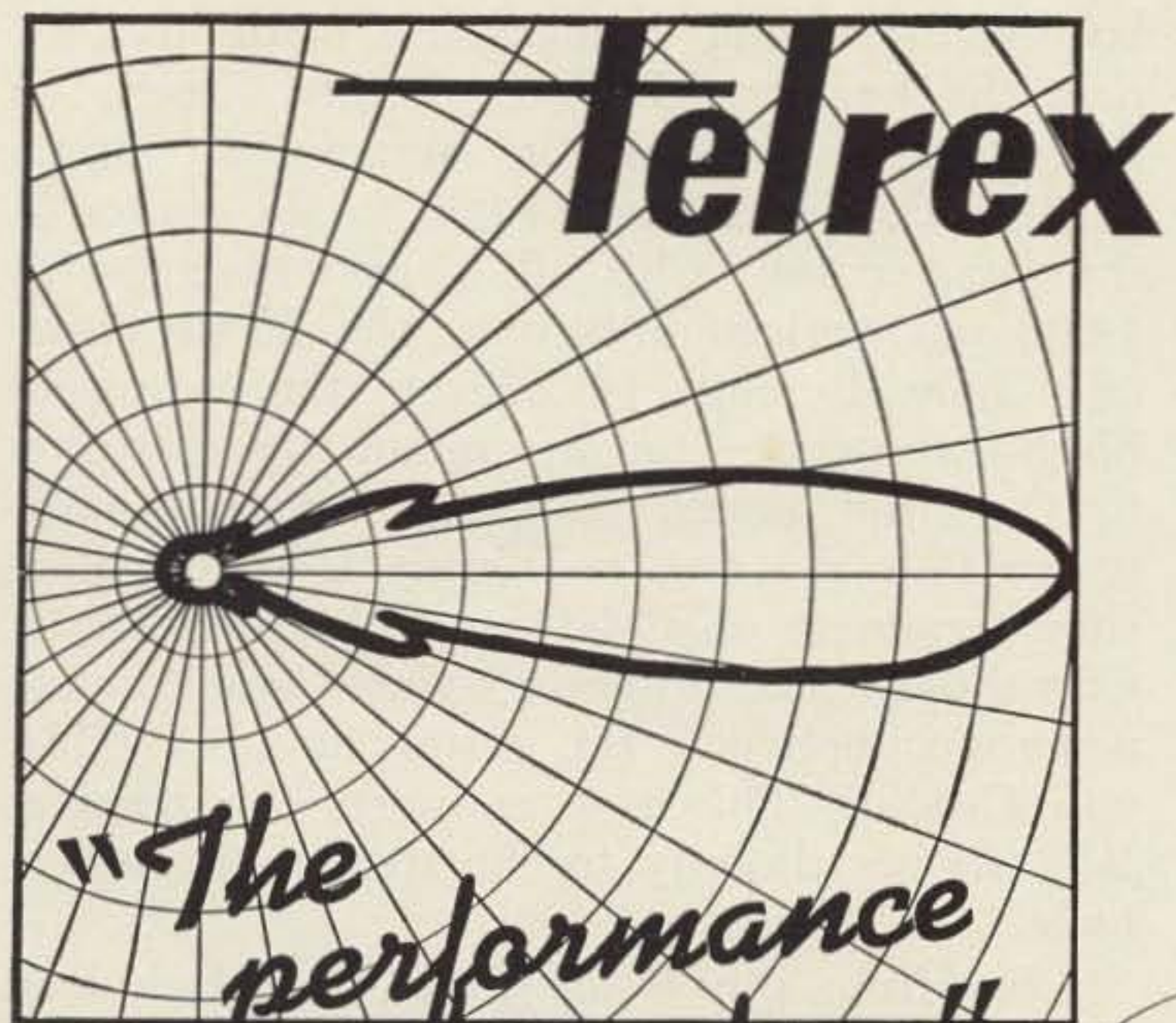

"BEAMED-POWER" ANTENNAS and ANTENNA SYSTEMS

The Choice of the Discriminating
Communication Engineer... the
Man who Never Settles for Any-
thing Less than THE-VERY-BEST!

You too — can enjoy World renowned Telrex performance and value!
Send for PL77 condensed data and pricing cata-
log, Describing the World's most popular anten-
nas from \$6.95 to \$999.00. Expanded data sheets
—Your favorite band, also available.

"— with a
MATERIAL DIFFERENCE!"

ANTENNAS

SINCE
1921

Communication and TV Antennas

telrex LABORATORIES

ASBURY PARK 40, NEW JERSEY, U.S.A.

gain controls are installed and a tuning knob and dial scale are provided.

The ac power supply is constructed on the former dynamotor mounting plate and is installed in the same manner as the dynamotor. Construction of the power supply is greatly simplified and circuit changes minimized by use of a power transformer specifically designed for such applications. This transformer is available from Fair Radio Sales Company, 2133 Elida Road, Lima, Ohio. The transformer carries the part number 619 and sells for \$3.95.

Remove the dynamotor from the plate, leaving the connector in place. The mounting centers of the transformer specified enabled it to be mounted using existing holes. Carefully drill out the rivets securing the retaining clips at one end of the plate and insert $\frac{1}{2}$ " 4-40 machine screws from the under side of the plate. Make a pile up of washers to the same shape and size as the defunct shoulder rivets and place over the screws. Solder 6" insulated leads to each contact of the ex-dynamotor connector and dress toward the other end of the plate. Place the transformer over the screws and secure one side, using a flat washer, lock washer and nut on each screw. Enlarge the two holes falling under the other two transformer mounting slots to accept #8 screws and dress the transformer leads toward the empty end of the plate. Insert $\frac{3}{4}$ " 8-32 machine screws in these holes, install $\frac{1}{4}$ " spacers between the plate and the transformer, and secure, using lock washers and nuts.

The balance of the power supply compo-

nents are mounted on a $1\frac{1}{4}$ " x $2\frac{3}{8}$ " aluminum plate. This sub-chassis is mounted on $\frac{3}{4}$ " metal posts, using 3 existing holes enlarged to pass 6-32 machine screws. For the want of a better small connector, a miniature crystal socket is mounted on this plate to permit connection of the ac line switch leads. The 6 x 4 heater is operated from the 5 volt winding of the transformer and no ill effects have been noted as a result of the reduced voltage. The 100 ohm surge resistor, which is listed as a 2 watt unit is shown as a 10 watt wire wound resistor in the photograph. After components are mounted and clearances checked, the assembly may be wired as a standard full wave supply. The photographs show the details and no difficulty should be experienced. This power supply is, of course, equally applicable to either the SCR-274-N or the AN/ARC-5 receivers.



The R-511/ARC receiver before conversion.

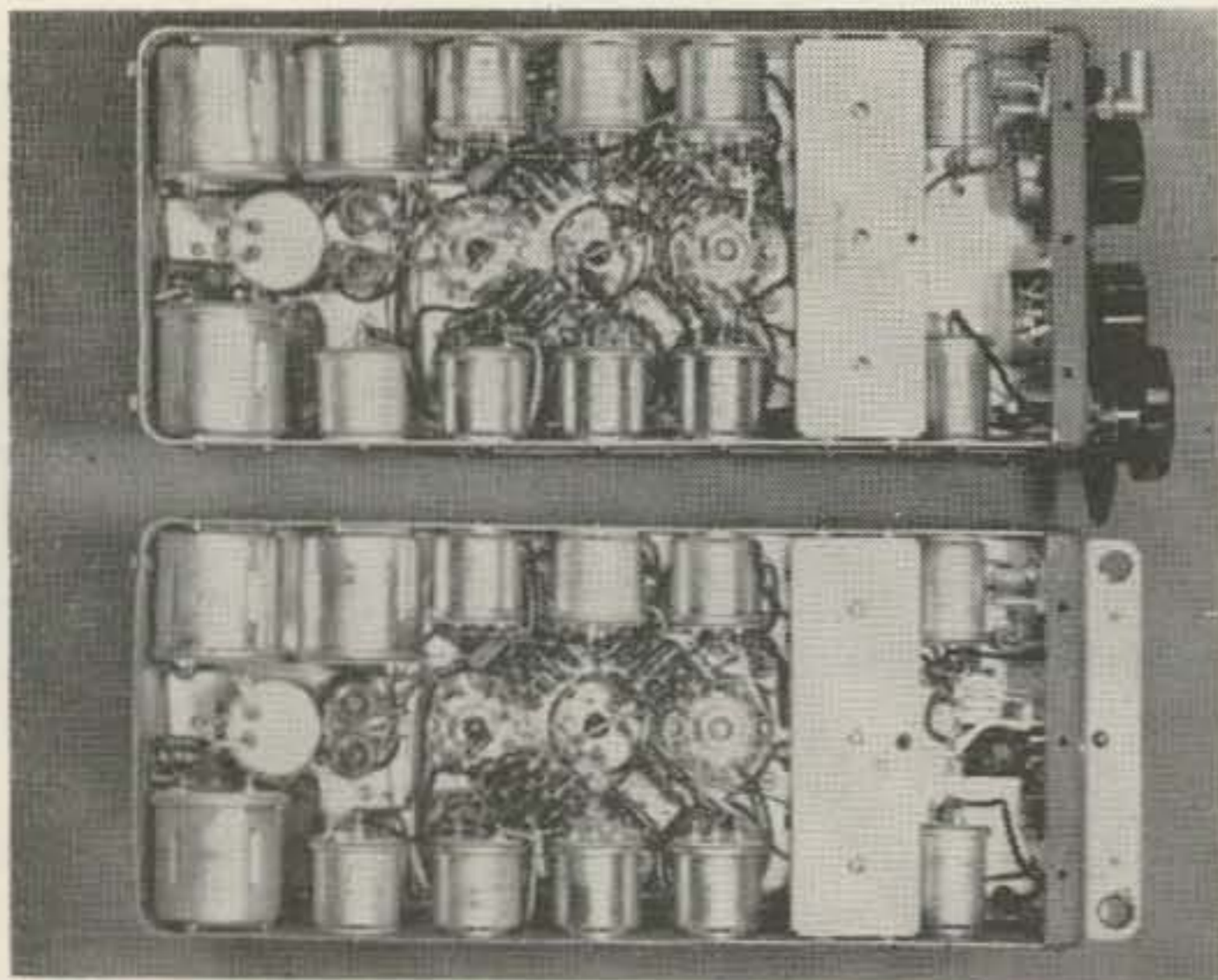

The converted receiver is above, the unmodified unit below.

The actual modification of the receiver is next on the agenda. Remove the screws holding the bottom plate and the outer cover of the receiver. Remove the two front tubes and loosen the front *if* can to permit removal of the tuning capacitor shield. Set the covers and mounting hardware aside for future use. Remove the screws and ground post which secure the mounting bracket to the bottom of the front panel. Discard the angle bracket and the ground post, reinstalling the screws.

Clip the blue lead connected to the antenna binding post and fish it through the chassis. Remove and discard the binding post, filling the hole with a snap plug. Unsolder the blue lead, along with C-601 and R-601, from the ceramic insulator next to the antenna trimmer. Clip the other ends of these components from the lug on the trimmer capacitor and discard C-601 and R-601. Unsolder from the relay contact the gray lead which runs to the antenna connector, J-601 and connect this lead to the vacant terminal of the ceramic insulator. Remove the second gray lead which runs between a relay contact and pin 5 of L-601A, the antenna coil. Connect a 50 mmfd mica capacitor between pin 5 of L-601A and the insulator to which J-601 is terminated and solder this connection.

Remove and discard the two blue leads which run between the antenna trimmer and a relay contact and between pin 6 of L-610A and a relay contact. Remove the ceramic capacitor C-602, connected between pins 1 and 6 of L-601A and strap these two pins with a length of bare wire. This completes the antenna input circuit changes. The tuning capacitor cover may now be replaced, the *if* can be tightened down and the tubes inserted.

The next steps remove the front panel power connectors and the now unused antenna re-

lay. Minor wiring changes are made to connect the heater and plate circuits directly to the dynamotor connector. Remove the metal extrusion which mounts J-606 to the center of the front panel. Clip all leads connected to J-606 and work them through the chassis clearance hole. Remove J-606 from the extrusion, discard the connector and mount the extrusion to the front panel, using the original hardware. Pull the two red leads free to where they terminate on C-634 and pin 1 of T-601. Clip these leads, discarding them, and connect a jumper between the terminals of C-633A and C-633B. This step connects the receiver B+ circuits directly to the dynamotor receptacle.

Clip, from pin B of J-602, the black lead which connects to the negative terminal of C-608 and solder this lead to the ground lug of the antenna trimmer. Clip, from the terminals of J-604, the black and brown leads formerly connected to J-606, the black lead which runs to pin C and the brown lead which runs to pin A of J-603. Remove and discard the white lead which runs between pin D of J-603 and one terminal of the filament choke, L-612. Remove one of the white leads from the other terminal of the choke and solder it to the vacated terminal. This removes the filament circuit from the front panel connectors and connects the low inductance choke in the filament circuit of the receiver. Clip the two green leads from pin E of J-603 and dress them aside for future connection to the rf gain control. This frees all wiring from J-602, J-603 and the antenna relay except for the leads which interconnect these components. Remove these parts and discard as a unit. All wiring in the receiver should be terminated except for the two green and one black leads which will connect to the rf gain control.

Drill out the spacer studs which were used to mount the antenna relay and the two center captive nuts at the bottom of the front panel. Cut a 1¼" x 3" aluminum filler plate and mount it inside the bottom of the front panel,



The ac power supply constructed on the original dynamotor plate is shown along with the dynamotor.

using machine screws through existing panel holes. Drill a $\frac{3}{8}$ " hole in the center of the mounting hole for J-602 and a second $\frac{3}{8}$ " hole the same distance in from the panel side and bottom in the J-603 mounting hole. Mount a 50,000 ohm, 2 watt control in the left hand hole and a 2 megohm, audio taper control with switch in the right hand hole. Ground one side of the 50K pot and connect the center tap to the ungrounded terminal of C-608, a 3 mfd capacitor. Remove the resistor (R625, 2 meg) and capacitor (C-636, 350 mmfd) connected to pin 5 of the 12A6. Connect a .005 mfd capacitor between the junction of a 150K resistor and 100 mmfd capacitor from which C-636 was just removed and one side of the 2 meg pot. Ground the other side of the pot and connect the center terminal to pin 5 of the 12A6. Use a defunct crystal holder as the power supply connector for the ac switch leads.

The above work completes the basic modification of the receiver. All that remains is the installation of a suitable dial, control knobs and decals. The tuning knob which fits the splined capacitor drive shaft is identical to that required for the older Command Sets and it has always been in short supply. Fair Radio Sales Company of Lima, Ohio stocks these knobs and the price of \$1.00, while high, is in line with the scarcity of the item. The type of dial or dial scale required will depend on the proposed application of the receiver.

In the conventional Q5-er application, the highly selective Command Set receiver is coupled to the last *if* stage of the less selective normal station receiver. The Q5-er is tuned to the center of the station receiver *if* bandpass and tuning accomplished in the usual fashion. In this mode of operation, an uncalibrated knob is all that is required. Alternatively, the normal receiver may be set roughly to the desired frequency and tuning accomplished by sweeping the Q5-er across the *if* bandpass of the normal receiver. In this instance, the Q5-er is required to tune only a few kilocycles. Since one revolution of the Command Set capacitor drive shaft tunes the receiver approximately 13 kc in the vicinity of 450 kc, a scale may be fitted to the tuning knob and directly calibrated in kilocycles above and below the center frequency of the normal receiver *if* bandpass.

The latter method is used in the converted receiver shown in the photographs. The spinner disk of a standard Command Set knob is removed by drilling out the peened over brass shaft and soldering on a 1" extension made from a hollow, brass standoff post. A 2 $\frac{3}{4}$ " diameter dial plate is removed from a standard knob with scale assembly and given a coat of

CONVERTER SALE

New model series 300 with 3 VHF transistors, crystal, and more than 30 high quality parts. Carefully assembled and tested. Measures only 3" x 2 $\frac{1}{4}$ " x 2". Low noise and better than 1 microvolt sensitivity. Made in USA and guaranteed. Available in the following models for 12 volts DC:

Model	Input mc.	Output mc.	Price
300-A	26.965-27.255	1.0-1.255	\$8.50 ppd.
300-B	50-51	.6-1.6	\$8.50 ppd.
300-C	50-54	14-18	\$8.50 ppd.
300-D	144-148	50-54	\$10.50 ppd.

Supply limited at these low prices—order now.

All above converters are supplied with Motorola type connectors. For two SO-239 connectors instead, add 75c. N.Y.C. residents add 4% sales tax.

VANGUARD ELECTRONIC LABS Dept. H-9
190-48-99th Ave. Hollis 23, N. Y.

TV CAMERA

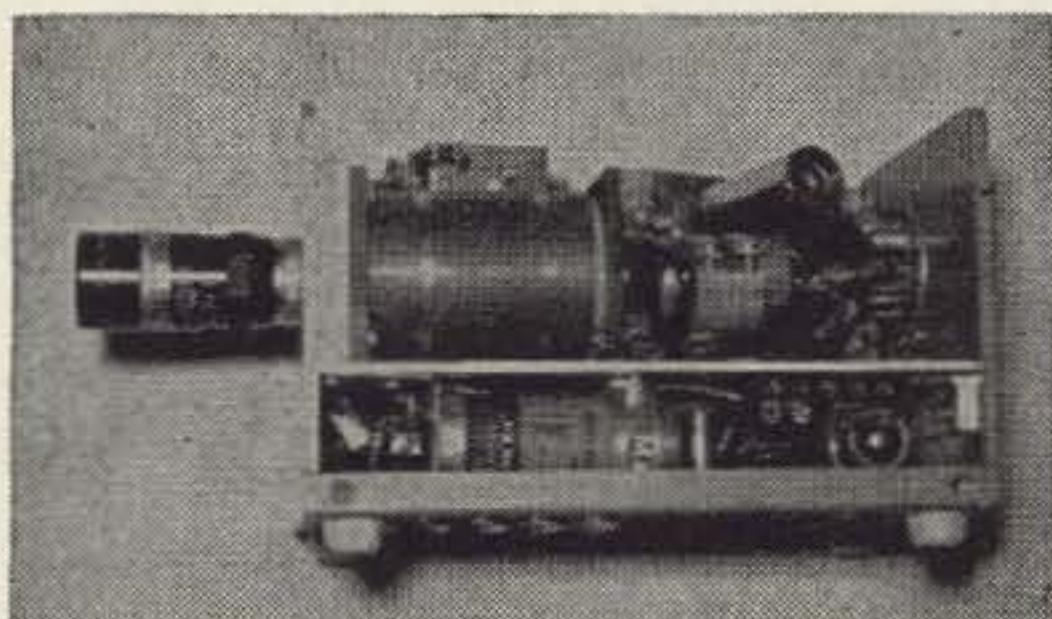

\$99.50
and up

Basic
Parts
Kit

Details—FREE List #771
DENSON ELECTRONICS CORP.
Rockville, Connecticut

NOW!

IN THE WEST

BUY YOUR

Galaxy

300 WATT TRANSCEIVER

\$299⁹⁵ PREPAID

IN STOCK AT

QUEMENT ELECTRONICS

1000 SOUTH BASCOM SAN JOSE, CALIFORNIA
"Northern California's Most Complete Ham Store"
SINCE 1933

black lacquer, reassembled, mounted on the new shaft and the unit installed, using the original locking nut. A 1½" snap hole plug is given a coat of black lacquer and installed in the now vacant J-606 connector hole. An index line is marked on the hole plug, as shown in the photograph, and calibration is accomplished as described later. Knobs are now installed on the audio and rf gain controls. The 1½" skirts of the knobs shown cover the former connector holes nicely. This completes the conversion and the unit is now ready for test and calibration.

Install the new power supply in the same manner as the original dynamotor and plug in the connector which terminates the ac switch leads. Connect ac power, plug in a pair of phones and advance the audio and rf gain controls. The tubes should light and, after a few seconds, background hiss should be heard in the phones. Connect an antenna and tune across the band. Aircraft range and ship stations should be heard with good volume. Unscrew the caps from the *if* transformers and pull the fiber rods out as far as they will come without forcing. This reduces the coupling of the windings, reducing the bandwidth substantially. Stations should still be heard, at a bit less volume but with greatly improved selectivity. If all checks out OK, install the top cover and the bottom plate and the job is finished.

To connect the Q5-er to the receiver, strip the outer jacket and shield from one end of a length of RG-58/U cable and wrap a couple of turns of the insulated center conductor around the plate lead of the last *if* stage of the station receiver. Install a BNC plug on the other end of the coax and connect to the antenna receptacle of the Q5-er receiver. Couple a signal generator or, better still, a frequency meter into the normal receiver and center the signal in the *if* bandpass by tuning for maximum signal. Tune in the *if* signal on the Q5-er and scribe the "0" calibration point on the tuning knob. Offset the signal generator 5 kc above and 5 kc below this frequency and, without tuning the normal receiver, tune the Q5-er for maximum output and scribe both points on the tuning knob scale. Divide the dial scale between "0" and the 5 kc points into five equal sections and mark the individual kilocycle calibration points. Commercial decals may now be applied and a very practical dial results.

Other refinements which may be added and which will enhance the utility of the converted receiver include a bfo circuit, avc disable switch and a self-contained speaker. The latter

subject is treated in detail in the article, "Command Set Speakers" which was published in the January, 1962 issue of *73 Magazine*. Many articles have been published on the Command Set receivers and much of this material is directly applicable to the ARC-12 equipment. The references given barely scratch the surface. A comprehensive bibliography of all surplus conversion articles published since the war is now available from *73 Magazine*.

While the ARC-12 equipment will never be as plentiful as the older Command Sets, their utility is as great. The up-dated circuitry, better wiring and improved components make them more desirable and worth the premium price they will command.

. . . W4WKM

Aircraft Radio Corporation Type 12 Equipment Components

R-507/ARC, R-19 (14 v): VHF, AM receiver, 118 to 148 mc, continuous tuning; 14 vdc power requirement with self-contained dynamotor. Modern 9 tube superheterodyne circuit with 2 rf and 3 if stages, agc, noise limiter and 360 mw audio output into 300 ohms. Sensitivity is better than 2 microvolts for 10 mw output. Selectivity is 175 kc at 60 db down. Unit is very similar to Command Set receivers in appearance except no dial scale is provided and all connectors terminate on the front panel. Rf gain control is external to the set and no audio gain control is provided.

R-508/ARC, R-19 (28 v): Identical to R-507/-ARC except power requirement is 28 vdc.

R-509/ARC, R-15 (28 v): Identical to R-507/-ARC except power requirement is 28 vdc and frequency coverage is 108 to 135 mc.

R-510/ARC, R-11A (14 v): Lf-mf, AM receiver, 190 to 550 kc, continuous tuning; 14 vdc power requirement with self-contained dynamotor. Receiver uses octal and loctal tubes and features 1 rf and 2 if stages, agc, noise limiter with 800 mw output into 300 ohm load. Sensitivity is better than 2 microvolts for 10 mw audio output. Selectivity is better than 35 db down at 3 kc off resonance and 60 db down at 5 kc off resonance. Unit is very similar to the BC-453 Q5-er except that no dial scale is provided and all connectors terminate on the front panel. No bfo or audio gain control is provided and rf gain control is external.

R-511/ARC, R-11A (28 v): Identical to R-510/ARC except power requirement is 28 vdc.

T-363/ARC, T-13 (28 v): VHF, AM transmitter; 5 crystal controlled frequencies in any 2 mc segment of the 132 to 148 mc band. Range may be lowered to 125 to 132 mc by the use of a special capacity plate. Power is supplied by the dynamotor of the companion receiver through a front panel connector. Transmitter uses 4 6AQ5 or 5763 tubes for a power output of 2 watts into a 50 ohm load. Panel size and construction is similar to the receivers of this series. The case is shortened by the width of the dynamotor which is not used in the intended application.

T-364/ARC, T-13 (14 v): Identical to the T-363/ARC except relay and heater circuits are wired for 14 vdc operation.

T-336/ARC, T-11 (28 v): Identical to the T-363/ARC except frequency coverage is 116 to 132 mc and relay and heater circuits are wired for 14 vdc operation.

T-366/ARC, T-11 (28 v): Identical to the T-363/ARC except frequency coverage is 116 to 132 mc.

Bibliography

- The Lazy Man's Q5-er, W1DX, QST, January 1948
A Double-Conversion Receiver for \$30!, WØMYU, CQ, February 1949
New Life for the Q5-er, Jordan, QST, February 1951
Turnable-I.F. Receiver Using the BC-453, W2PPL, QST, September 1959
A Poor Man's Q-Multiplier, W1ICP, QST, March 1960
The BC-453 as a Tunable I.F. in a Multi-Band Receiver, W2PPL, QST, February 1961

Save that Mil

Donald Hall K1JWU
2166th Comm. Sq., Box 3145
APO 238, New York, N. Y.

While the home station usually enjoys almost unlimited current available for gear, mobileers operate comparatively high power with definitely limited power sources. Obviously, any savings that can be effected, no matter how small, will benefit in increased battery and generator life and can easily make the difference between a start and no start.

Various cars differ in their electrical set-up so no exact procedures or recommendations can be given; but your own system should be studied carefully and advantage taken of every little current saver you can find. For instance, if the car is so wired that the front parking lights remain on with the headlights, a separate or different switch can be installed to cut them off when the headlights are on. A savings of 3 or 4 amps can often be effected this way. Instrument and dash lights also need checking. If they can only be dimmer, or are turned off by increasing dimmer control resistance, another switch can be installed to isolate them when not needed. Another few mils saved. If the parking and tail lights are of overly high wattage, they can be changed for lower wattage bulbs (consistent with State regulations and safety, of course) and the same applies to direction indicators and stop lights.

One point to keep in mind, though, if you

change the wattage of your flashing turn signals; the flashing unit itself is designed to work with a given load and its rate may be affected by a drop in load. Don't add a resistor to bring it back up—change the flasher unit itself for one designed for the wattage you intend using. And—do you really need all the dial lights on your rig at all times? Would one bulb do where two are now? A separate switch, perhaps? There could be a few extra mils there, you know.

How about the general condition of the electrical system? Most of us take great pains to insure the battery, regulator and generator are all up to snuff and that there are no fuse-blowing shorts; but what about the rest of the wiring system? The entire car should be checked and every current-consuming device given close scrutiny. (Yes, even those wires you have to crawl under the car to find!) Deteriorated insulation on wires, high resistance grounds, bad connections and high resistance shorts can all consume many valuable amps without visible effect—and they all add to the total current drain and leave just that much less available where it's needed.

Arm yourself with a sensitive low-range VOM and check resistance to ground at each device; it should be zero. Any reading here will indicate valuable current being used to heat lamp sockets and connections. Check voltage drop by measuring first at the battery terminals and then at each device (with the device turned on, of course); more than a few tenths of a volt, while acceptable on the normal car, is just too much to waste with a mobile rig. And you may be surprised to find as much as 2 or even 3 volts difference. If you do, it indicates that new and larger wires or switches are in order.

Assume nothing and take nothing for granted until you have personally checked it. That flashy, bechromed light unit can often hide poor workmanship, poor connections and high resistance shorts. And need anything be said about the effects of moisture and corrosion? Generous blobs of anti-corrosion grease (petroleum jelly in a pinch) in the right places can make a world of difference.

There is no short-cut method and you cannot assume that just because the car is new and expensive everything is in apple pie order. A few greasy hours spent with VOM, screwdriver, and pliers will pay dividends in peace of mind, more reliable starting, better overall efficiency and—bonus of all bonuses—a possible "S" unit jump on the other fellow's receiver with those few saved mils applied to your plate!

. . . K1JWU

Code Master

Here's a gadget you can build for less than a dollar and a couple of spare hours that will teach you code quickly and efficiently.

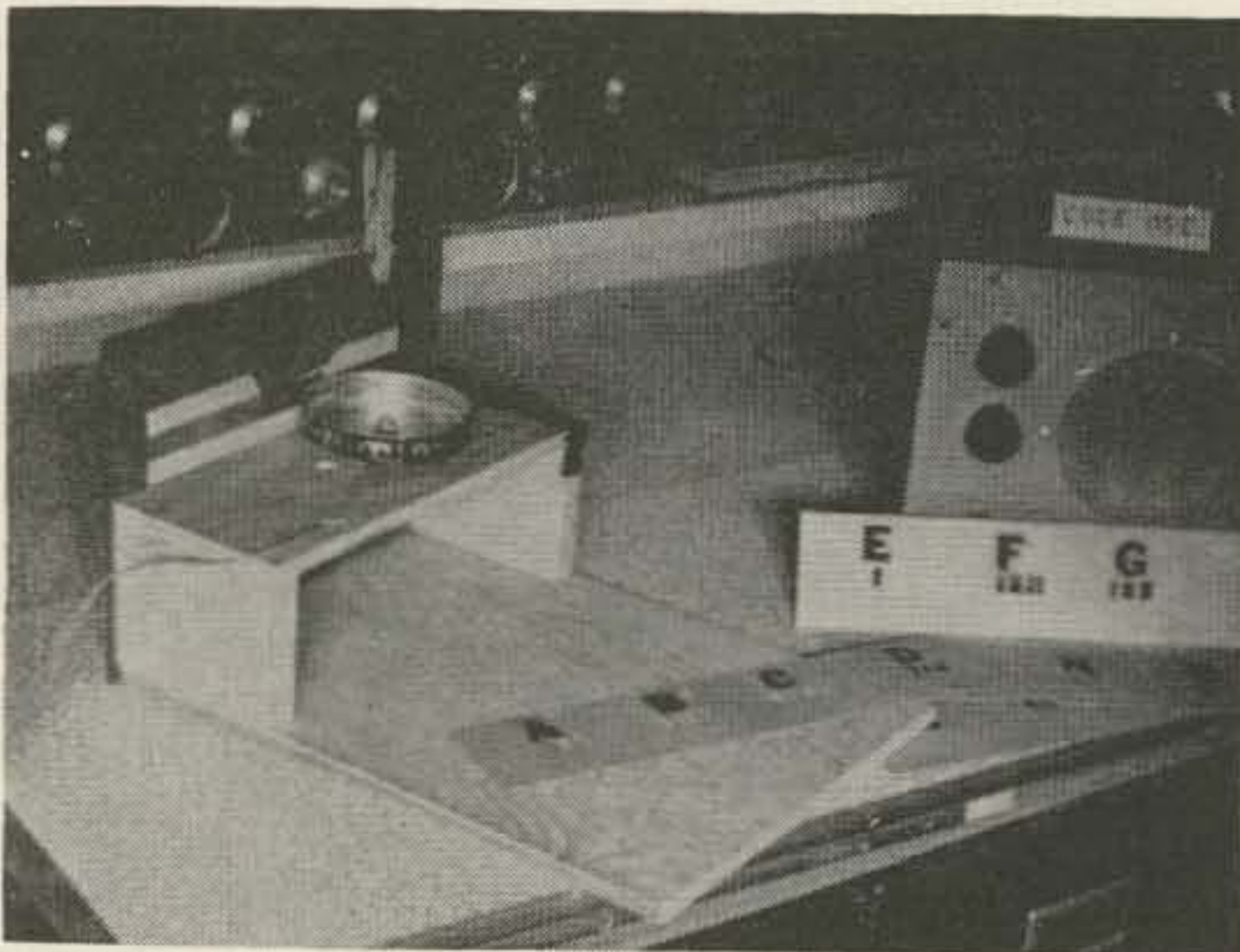

"I'd like to be a ham, but I can't pass the code test." This cry from a multitude of potential good ham and SWL operators prompted project code master.

The code hump is around eight words a minute. Code Master will start you from scratch and take you over the hump in a few short weeks.

Learning code by the dot-dash memory method is slow and tedious. Code Master lets you hear the exact keyed musical tone and shows you visually what the character is you are hearing; no di and dah to remember; hence a direct conversion from code to character.

Drag your portable record player out of the closet and measure the depth (top of the turntable to bottom of case in playing position). This is a key dimension to start construction. Fill this dimension in on the sketch.

Search the trash box for a couple of screw-on jar lids (instant coffee or peanut butter lids work fine) approximately 3½" ri. x ⅝" deep. Drill a ¼" diameter hole in the center of each. Cut a piece of coarse sandpaper to diameter of one lid and cement it to the outside bottom (sand side out) of one lid. Place this

lid over the center spindle of the turntable and secure with a tight fitting rubber grommet. This forms the drive pulley for your code master.

Refer to the sketch and cut a base, spacer blocks (2) and a bearing support from ⅜" plywood. Cut a piece of ⅛" thick masonite for the front panel to size as shown. Bore a 1" diameter hole for the window in which the coded character will appear.

Drill a ⅜" diameter hole thru the 4" x 10" piece of plywood as shown. Note this hole is offset 1" from the hole in the front panel. Sand the edges of all parts smooth and nail together.

Dig into the junk box for a ¼" shaft panel bearing or the threaded bushing from a discarded potentiometer. Cut two pieces of insulated hook-up wire (20 or 24 gage) about 2 feet long. Strip the insulation back 1½" on one and twist it securely under the head of the panel bearing for a good electrical connection. Insert the shank of the bushing thru the ⅜" diameter hole and secure with a nut on the underside. The other end of the wire connects to one side of the audio oscillator key circuit.

Cement a piece of aluminum foil (the bottom of a TV dinner tray is better) 5" long,





centered in the area below (back side) the window in the front panel. Use a paper clip to secure the end of the second wire to the foil plate. This wire goes to the opposite side of the audio oscillator key circuit.

The second lid forms the keying switch for the code master. Punch two small holes $\frac{1}{2}$ " apart at the lip edge of the lid. Insert a piece of light gage music wire thru the holes leaving $2\frac{1}{2}$ " protruding to the left (see sketch). Solder the wire in place for a good mechanical and electrical connection.

Next, to mount the keying switch. Install a $\frac{1}{4}$ " x $1\frac{1}{2}$ " long hex head bolt from the bottom side of the panel bearing; secure it with a nut on the top side. Do not tighten the nut as the bolt must turn freely in the bearing.

Install the lid with the wire projecting to the left. Secure with a lock washer and nut. Check again to make sure the bolt turns freely in the bearing. This completes the mechanical construction of your code master.

Place the record player in position on the mounting base and note the distance between the lid drive wheels. Daisy chain some light rubber bands together to form a drive belt.

Turn on the record player to see if the contact wheel is operating freely.

The code keying stencils are cut from light cardboard. The author found that two for a nickle manila file folders worked perfectly. They are stiff and slick enough to give good wear. Cut the folder into strips $2\frac{1}{2}$ " wide x $11\frac{1}{2}$ " long. Keep the cut edges square. Divide the length of the strip into four equal sections

nuvistor converters

Only \$34.50 and \$54.95 with power supply and crystal! **6 & 2** Write today for free literature on our VHF line!

parks electronics laboratory
route two, box 35 Beaverton, Oregon

Famous G4ZU Minibeams Now Popularly Priced

The World Famous Minibeam 10-15-20 meters through mass purchases now available at the low, low price\$49.95

CB-10 Dual driven two element beam with 7.8 db gain on 10 meters or CB Bands

Weight 5 pounds — powerful — only\$24.95

Hottest Parks Converters that will not overload and need no preselector.

Model 50-1 fully powered — no extras\$34.50

Model 144-1 fully powered 3 db noise\$54.95

Write for details

GAIN, Inc., Dept. 73-9, 1209 West 74th, Chicago 36, Ill.

VHFERS!

SIGNAL UP SWR DOWN

Match any 50-75 ohm, 6 or 2 meter transmitter output to efficient balanced feedline in the 300-450 ohm range.

End matching problems! Get maximum power transfer to feedline!

REDUCE HARMONIC TVI!

Bandswitching 6 and 2 meter operation w/built in VHF type SWR bridge, silver plated inductors. **LM-6N2 \$59.75 net.**

Also available **FLM-2** and **FLM-6** matchers, less SWR bridge. For single band, 6 or 2 meter use. \$19.95 net.

Send for descriptive literature on these and other quality VHF products.

COMAIRE ELECTRONICS
BOX 126 ELLSWORTH, MICHIGAN



R.W. Sept. Bargains

Bendix MN-26C 150-1500KC Excellent for "Q5er" for DX broadcast receiver, Has 112.5KC IF & is complete with 12 tubes and schematic. Like New\$18.95

Used Good condition\$14.95

BC-455 Command Receiver 6-9.1MC. A good Novice 40 meter receiver, Excellent condition\$10.95

TS-247A/APM-48 Wavemeter 210-275MC tuned cavity, 4" velvet vernier dial & 115v 60cy power supply. Used good \$9.95

RT-100A/APS-19 "X" Band Transceiver with tuneable 2J55 magnetron in transmitter & tuneable (2) 2K25 Klystrons in receiver. Front panel tuning controls. 120MC IF strip with 8-6AK5's. Complete with 27 tubes, 4 diodes and 3 fans 27.5vdc. Excellent condition\$49.50

NEW SURPLUS TUBES — All are Guaranteed, Except * pulled from New Equipment.

3BP1 3.25*	1B35 1.00*	811 2.75
3CP1 3.25*	1B60 2.00*	813 12.00
5BP1 5.95*	3B26 1.25*	829B 7.95
7F875*	4C35 5.00*	6146 2.75
567075*	719A 5.95	

BC-221 Frequency Meter—**BRAND NEW** in original military packaging. Complete\$124.50

BC-221 Frequency Meter—Excellent Condition with Xtal & original calibration book. Checked out\$69.50

Send check or money order with your order. Write Dept. 739 for latest flyer—Loads of Bargains.

R. W. ELECTRONICS, INC.
2430 S. Michigan Ave. Chicago 60616, Ill.
Phone: CALumet 5-1281-2-3



TELREX ROTATOR-INDICATOR SYSTEM MODEL TS238-RIS

MAST FEEDS THRU ROTATOR FOR SAFER AND EASIER INSTALLATION MAINTENANCE

- 1300 IN/LBS ROTATION TORQUE
- SELF LOCKING BY STURDY WORM GEARS
- AZIMUTH INDICATION BY SELSYNS
- AUTOMATIC LIMIT OF ROTATION
- DESIGNED FOR 2" O.D. MASTING
- MALLEABLE CAST MASTING CLAMP SUPPLIED
- OUTPUT SPEED APPROX. 1 RPM
- WILL FIT INTO OR ONTO A 6" SIDED TOWER

\$238⁰⁰

EGB ASBURY PARK N.J.

OTHER TELREX ROTATORS
LARGER HIGHER TORQUE RATING
MODELS AVAILABLE

MODEL TS435-RIS \$435⁰⁰
5,000 IN/LB TORQUE

MODEL TS535-RIS \$535⁰⁰
8,000 IN/LB TORQUE
(CUSTOM DESIGNED MODELS AVAILABLE)

TELREX LABS.
ASBURY PARK N.J.

WRITE FOR FREE PL-77 DESCRIBING THE WORLDS MOST POPULAR ANTENNAS





with a light pencil line. Hold the strip behind the 1" diameter window in the front panel, allowing it to rest on the bearing base. Place the strip in a manner that the center of one marked off section is centered in the window. Use the window as a template and inscribe a penciled circle on each of the four sections of the card.

Hand letter or cut large letters and numbers from magazines and paste on in each circle. Each card now has four characters which form



the visual part of code master.

Place the card behind the window and mark where the wire on the contact wheel strikes the

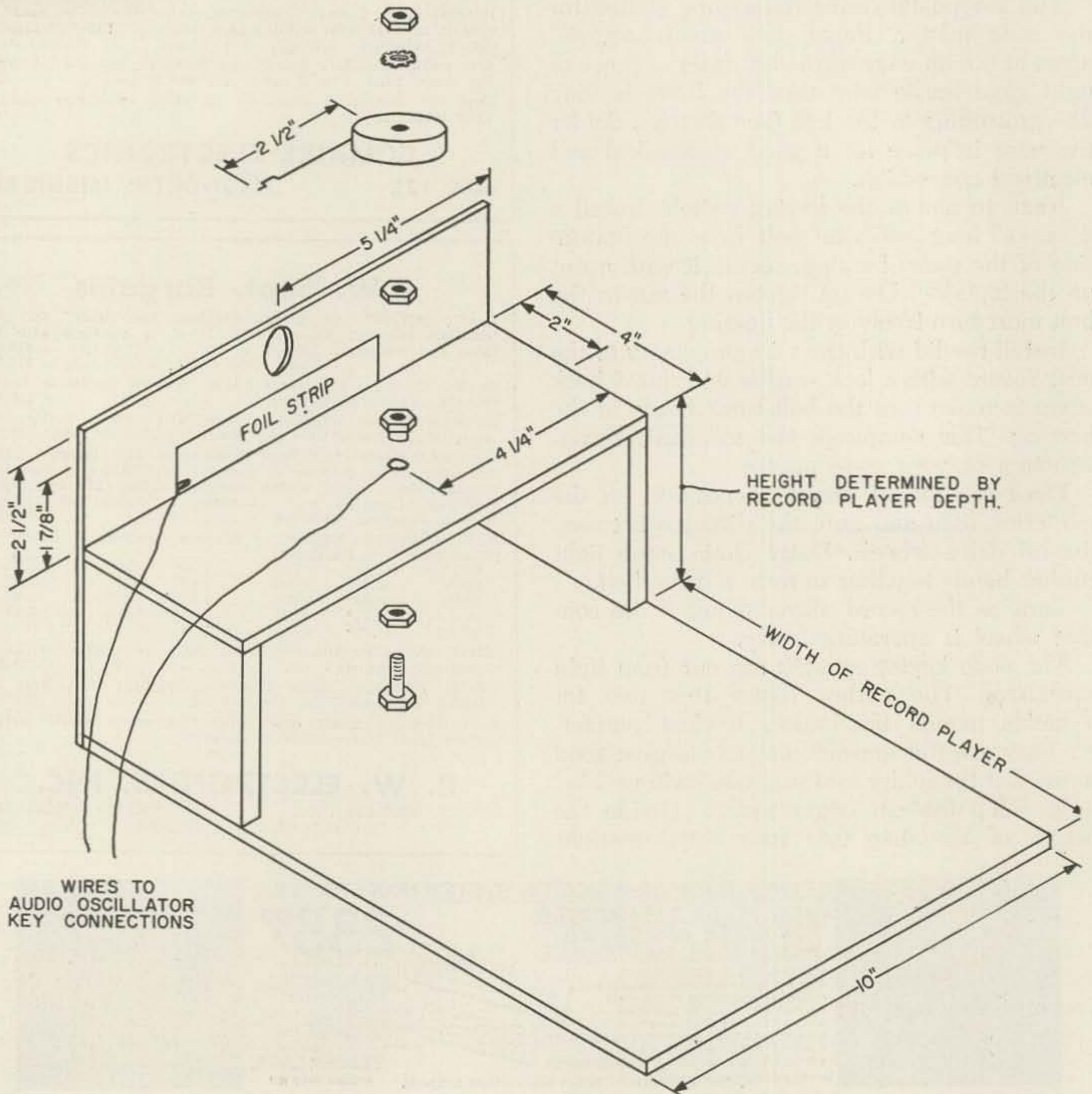

card. This is where the audio code stencil must be cut under each letter.

Cut the cardboard away $\frac{1}{8}$ " wide for dots and spaces $\frac{1}{4}$ " wide for dashes. Make the openings $\frac{1}{2}$ " long. Note that the contact wheel moves in a clockwise motion so the code stencil must be cut backwards, i. e. "A" is normally . —; it should appear — . on the stencil.

Place a stencil in the code master, holding it in place with a spring clip clothes pin. Turn on the audio oscillator and record player. Sit back and listen to the firm fist Code Master sends you. Associate the character in the window with a tone you hear. In a few days you'll copy code with perfection. The record player speed changer allows you to copy as fast as you like. 33 $\frac{1}{3}$ RPM equals 6 words per minute; 45 RPM equals 10 words per minute and 78 RPM equals 15 words per minute.

Good luck! We'll be looking for your CW on the ham bands.

... K6OKX

Diode Interference

Small power diodes are sometimes an unsuspected source of radio frequency interference.

A small broadcast/FM set was plagued with bad RFI—birdies and spurious rough signals. It was being operated within a mile of a 5 kw broadcast station. It was operated from a bridge of silicon power rectifiers. A .01 disc cap paralleled with each of the four rectifiers cleaned up the RFI.

The local broadcast station was being heard in the ham shack on every one of its harmonics. The trouble was traced to a bridge of silicon rectifiers feeding the antenna rotator. Again a .01 bypass across each of the rectifiers did the job.

A stubborn case of TVI was traced to non-linear rectification of the transmitter's normally clean signal in a bridge of 24 volt silicon rectifiers operating a T-R relay. The .01 bypass cured it.

It is apparent that all power silicon rectifiers should be bypassed for rf if they are likely to be subjected to a strong rf field. It is easy for these rectifiers to be driven into the non-linear portion of their characteristics and act as frequency multipliers. Rf voltage picked up on the power lines can easily get to these rectifiers if they are not properly isolated and cause RFI that may be very confusing.

... W6JAT

FREE Catalog

OF THE WORLD'S FINEST
ELECTRONIC GOV'T
SURPLUS BARGAINS



HUNDREDS OF TOP QUALITY ITEMS—Receivers, Transmitters, Microphones, Inverters, Power Supplies, Meters, Phones, Antennas, Indicators, Filters, Transformers, Amplifiers, Headsets, Converters, Control Boxes, Dynamotors, Test Equipment, Motors, Blowers, Cable, Keys, Chokes, Handsets, Switches, etc. etc. Send for Free Catalog—Dept. 73.

FAIR RADIO SALES
2133 ELIDA RD. • Box 1105 • LIMA, OHIO



DOW RADIO & Electronics

1759 E. Colorado Blvd. ---PASADENA---Mu 1-6683
222 West Main St. ----SANTA MARIA----WA 2-1765
5857 Hollister Ave. -----GOLETA-----WO 7-3401
1505 S. Oxnard Blvd. -----OXNARD----HU 6-6353



Free data sheets: 3.5-30 mc Preselector, built-in power supply, RF gain control, \$18.98. NJ-7 solid state noise limiter, \$4.49. Various technical manuals, various prices. Air-Dux coils. Hy-Gain antennas (18V, 10-80 meter vertical, \$16.95). All postpaid. **HOLSTROM ASSOCIATES**, P.O. Box 8640-G, Sacramento, Calif., 95822.

HARMONIC/TVI PROBLEMS???

6 METERS

TUNABLE LOW-PASS MAVERICK

The only low-pass filter designed expressly for 6 meters. With 9 individually shielded sections and 5 stages tunable forming a composite filter of unequalled performance. 1 DB loss. Handles 400 watts PI. 35 DB rejection. Size 5" by 2" by 3". **AMATEUR NET \$16.95**

MAVERICK II WITH POWER MONITOR

Same as above but with 6 meter power indicator calibrated in watts output. Indicator Size 4" by 4" by 4 $\frac{1}{2}$ ". Slant Face. Reads 0-50. 0-400 watts. **AMATEUR NET \$34.95**

2 METERS

BAND-PASS MODEL BP-144

A narrow band-pass filter with 6 mc pass band and 146 mc center frequency. 1 DB insertion loss. 35 DB attenuation of harmonics. Handles up to 185 watts PI. Size 4" by 2 $\frac{1}{4}$ " by 2 $\frac{1}{4}$ ". **AMATEUR NET \$11.85**

MODEL F810

Five separate filters housed in one package and selected by a front panel switch. Each filter is tuned for maximum attenuation of the second harmonic for that particular band. Attenuation - 35 DB. Handles up to 1 kw. Size 5" by 6" by 4". **AMATEUR NET \$24.75**

Write for complete brochures. See your local dealer.
Manufacturers of the finest UHF TV Converter

GAVIN
INSTRUMENTS, INC.

DEPOT SQUARE &
DIVISION STREET
SOMERVILLE, N.J.
TEL: 722-6311
AREA CODE 201

Linear

Amplifiers

80-2 Meters

Mono-band Units

10 watts drive required



Model 500 500 watts SSB and CW, 250 watts AM, 1 4X150 final, built-in silicon power supply and blower. **Price only \$149.95**

Model 1000 1000 watts SSB and CW, 500 watts AM, 2 4X150 finals, built-in silicon power supply and blower. **Price only \$199.95**

All units housed as above picture. Size 7" high x 15" wide x 9" deep. Please specify band when ordering.

J & D LABS

P. O. Box 266 Eatontown, New Jersey Area 201 222-1605

12 Volt Conversion of the Communicator II

Charles Green W31KH
17 Little Lane
Levittown, Pa.

It was the same old story; after having spent considerable time building and buying equipment for the car, I had to trade the car in. Then came more time in converting the six volt equipment over to twelve volts.

I have always enjoyed two meter mobile with my Gonset Communicator II, but since it was built for 117 vac and 6 vdc, mobile operation was limited to the length of a long ac line cord.

The Communicator II is built with three chassis, a receiver, transmitter and power supply. The power supply chassis is supplied in either six or 12 volt dc versions. (Both with 117 vac also). The receiver and transmitter chassis are wired in a series parallel filament hookup, allowing either six or twelve volt

operation by changing terminal strip jumpers.

The main problem in converting the Communicator II to twelve volts was the power supply chassis. A new power transformer, vibrator and rectifier tubes would be needed.

This conversion was not as simple as could be desired, but having no other choice, I decided to go ahead with it anyway.

A commercial equivalent of the original power transformer is the Merit P-2858. This transformer fitted the physical measurements and its electrical ratings are close enough to be utilized. Also, it would fit into the original transformer's mounting holes.

The original transformer was then removed and the Merit P-2858 was then installed. The original vibrator was replaced by a 12 volt

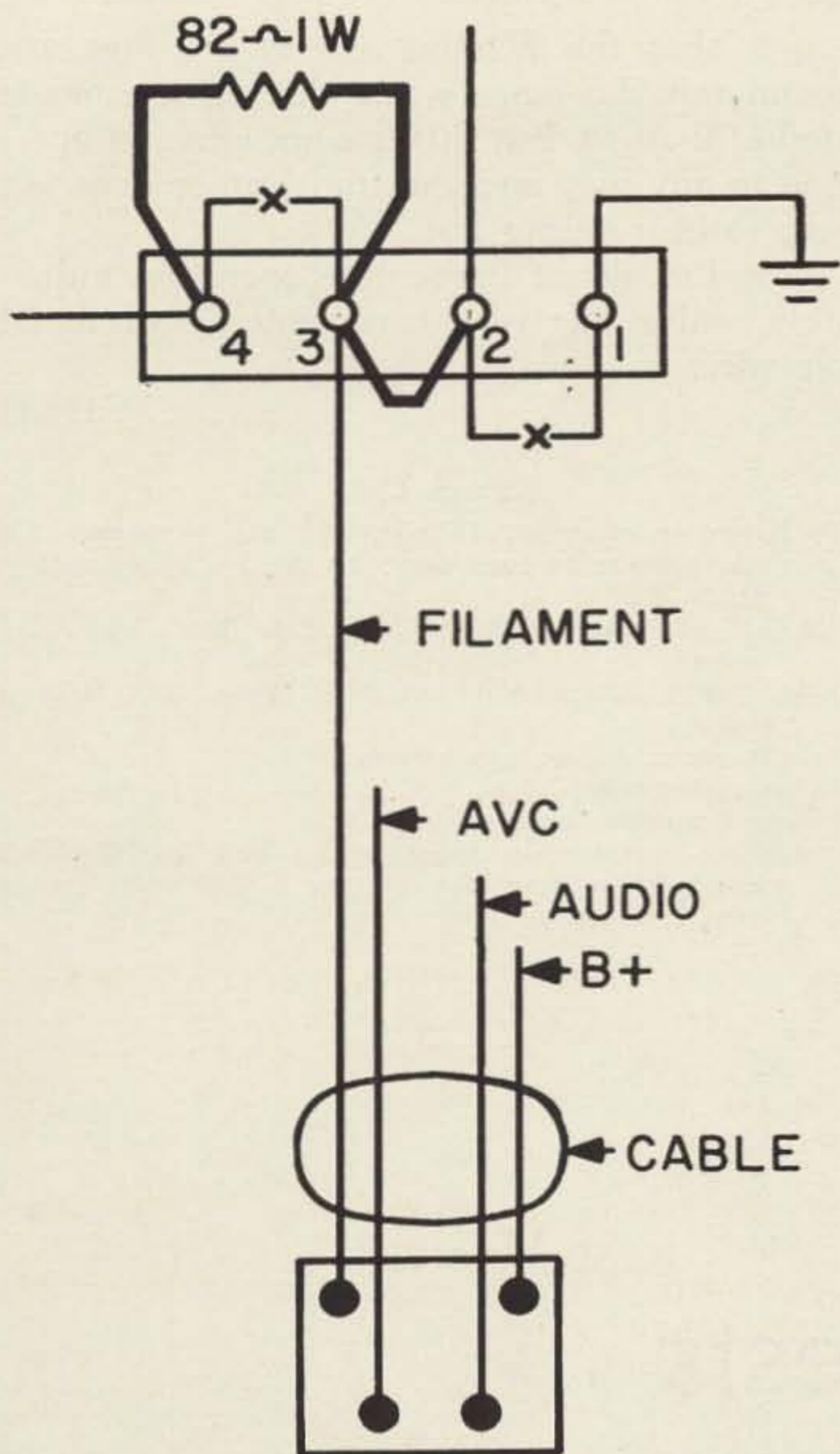

TO TRANSMITTER CHASSIS

FIGURE 1

type and the 6 x 4's were replaced by 12 x 4's. This did not involve any rewiring.

It was found that the B+ output voltage was higher than that required by the Communicator II, so a filter choke from the junk box, and a resistor in parallel with it (L1, R1) was added to bring the output B+ voltage to the required 300 volts. Any other type of filter choke, with the right resistor in parallel can be used as well.

L1 is mounted on top of the chassis in front of the rectifier tubes and R1 is mounted under the power supply chassis by a long machine screw.

The filament jumper connections on the receiver chassis are changed as in Fig. 1. The 82 ohm resistor is added, as directed by the instruction manual, to balance the filament string for 12 volt operation. The heavy lines indicate additions and the x-x-x lines indicate removals of wiring.

TNS NOISE SILENCER

Reg. \$14.98 now only \$6.00 ppd. while supply lasts. New, guaranteed, and complete with 6AL6, 12AX7, squelch control, and mounting brackets. Don't miss out. Order today.

VANGUARD ELECTRONIC LABS Dept. H-9
190-48-99th Ave. Hollis 23, N. Y.

TAKE THE SHEET METAL GRIEF OUT OF ELECTRONICS



Preformed sections make chassis and boards easy to assemble and wire! Makes electronics fun. Write for FREE literature on new circuit technique.

BALD EAGLE ELECTRONICS DEPT. 2 LA CROSSE, WIS.

255A Polar Relays	\$2.95 ea.
Silicon Rect. 18 amp at 50V. Pos. or Neg. case	\$.48 ea.
110VAC DPDT relay 10 amp	\$2.95
ARC 5 Receiver new 6-9.1 mc. w/auto tune and dynamotor	\$16.95
0-5 RF Ammeters exc cond	\$2.95
0-50 Microamp exc cond	\$4.95
0-200 Microamp exc cond	\$4.95
0-500 Microamp Dejur 1" new	\$3.95
Transformer 110V to 20V at 1 Amp	\$1.50

25% deposit on C.O.D.'s Please allow for postage
4% sales tax in Michigan

SAM'S RADIO & ELECTRONICS

14401 Meyers Road
Detroit 27, Michigan

GIFT PAK Includes
WORTH \$25
• Transistor
• Transformers
• Diodes
• Condensers
• Coils
Send 25c for handling

DOUBLE BONUS

PLUS \$1 FREE POLY PAK OF YOUR CHOICE

BOTH FREE WITH EVERY \$10 ORDER

GUARANTEED TESTED SEMI-CONDUCTORS

<input type="checkbox"/> 2 100W POWER TRANSISTORS, 2N1015 stud .. \$1	<input type="checkbox"/> 25 'EPOXY' DIODES, \$1 silicon, 750 ma (*)
<input type="checkbox"/> 6-AMP 800VDC SILICON PWR RECT, stud .. \$1	<input type="checkbox"/> 4 2N131 CITIZEN BAND \$1 "tiny" transistors
<input type="checkbox"/> 10 CK722 TRANSISTRS by Raytheon, npn .. \$1	<input type="checkbox"/> 5 MADT 30MC PHILCO \$1 TRANSISTORS, TO1
<input type="checkbox"/> 10 TOP HAT RECT, 750 mil to 600V less leads .. \$1	<input type="checkbox"/> 5 2N155 CASE POWER \$1 TRANSISTORS, TO3 (*)
<input type="checkbox"/> 10 ZENER DIODES, TO24 and axials(*) .. \$1	<input type="checkbox"/> 10 GERMANIUM DIODES 1N34, 1N48 equals \$1
<input type="checkbox"/> 4 15-W TRANSISTORS, threaded cases, npn .. \$1	<input type="checkbox"/> 25 AMP TRANSISTOR \$1 power switching, etc. ..
<input type="checkbox"/> 2 20amp PWR RECTIFIERS, silicon, stud .. \$1	<input type="checkbox"/> 30 CBS 20W TRANSISTRS stud, NPP, 2N1321 \$1
<input type="checkbox"/> 10 2N434 VERTICAL DIODES, silicon .. \$1	<input type="checkbox"/> 3 CBS 20W TRANSISTRS stud, PNP, 2N1321 \$1
<input type="checkbox"/> 4 HEARING AID TRANSISTORS, by Raytheon. \$1	<input type="checkbox"/> 15 PNP TRANSISTORS, \$1 asst cases, styles (*)

WORLD FAMOUS POLY PAK PARTS KITS—BRAND NEW

<input type="checkbox"/> 2 35-WATT POWER transrs, npn, stud .. \$1	<input type="checkbox"/> 50 1-WATT RESISTORS \$1 Allen Bradley, 5% too
<input type="checkbox"/> 10 SWITCHING TRANSISTRS, 2N438, 2N440 equals .. \$1	<input type="checkbox"/> 10 VOLUME CONTROLS \$1 duals, too & sw types ..
<input type="checkbox"/> TEXAS 20 WATT POWER, 2N1039, TO5 .. \$1	<input type="checkbox"/> 60 CARBON RESISTORS, 1/2, 1, 2 W. 5% too \$1
<input type="checkbox"/> 5 GE 2N107 TYPE TRANSISTORS, npn .. \$1	<input type="checkbox"/> 50 MICA CONDENSERS, \$1 to .01; silvers too ..
<input type="checkbox"/> 4 GE 2N170 TYPE TRANSISTORS, npn .. \$1	<input type="checkbox"/> 50 TERMINAL STRIPS, \$1 1-to-9 lug & screw types ..
<input type="checkbox"/> 4 GE 2N43 TYPE POWER OUTPUTS, npn .. \$1	<input type="checkbox"/> 50 COILS & CHOKES, \$1 rf, parasitic, if, etc. ..
(*) untested guaranteed semiconductors	<input type="checkbox"/> 40 'TINIEST' RESISTORS, 1/10W, 5% too \$1
<input type="checkbox"/> 100 PARTS SURPRISE \$1 xfmrs, etc. worth \$50 ..	<input type="checkbox"/> 25 AEROVOX CERAFILS, condensers to .05 \$1

INCLUDE POSTAGE. Avg. Wt. per pak 1 lb.—Rated, 30 days
→ Wanted! Canadian-n-Foreign Customers Too! ←

POLY PAKS

P. O. BOX 942A
So. Lynnfield, Mass.



MOTOROLA FMTRU-80D 150 MC
MOTOROLA FMTR-80D 30-50 MC
 This unit has a 30 watt transmitter using 2-2E26 tubes. Dynamotor power supply. Receivers are double conversion super het. Receiver uses vibrator power supply. Shipping Wt. 46 lbs.
 Catalog #15, 150MC-6V DC Price \$44.50
 Catalog #16, 150MC-12V DC Price \$52.50
 Catalog #17, 30-50MC-6V DC Price \$44.50
 Catalog #18, 30-50MC-12V DC Price \$52.50
 15" Case for above, Catalog #19 Price \$ 2.50

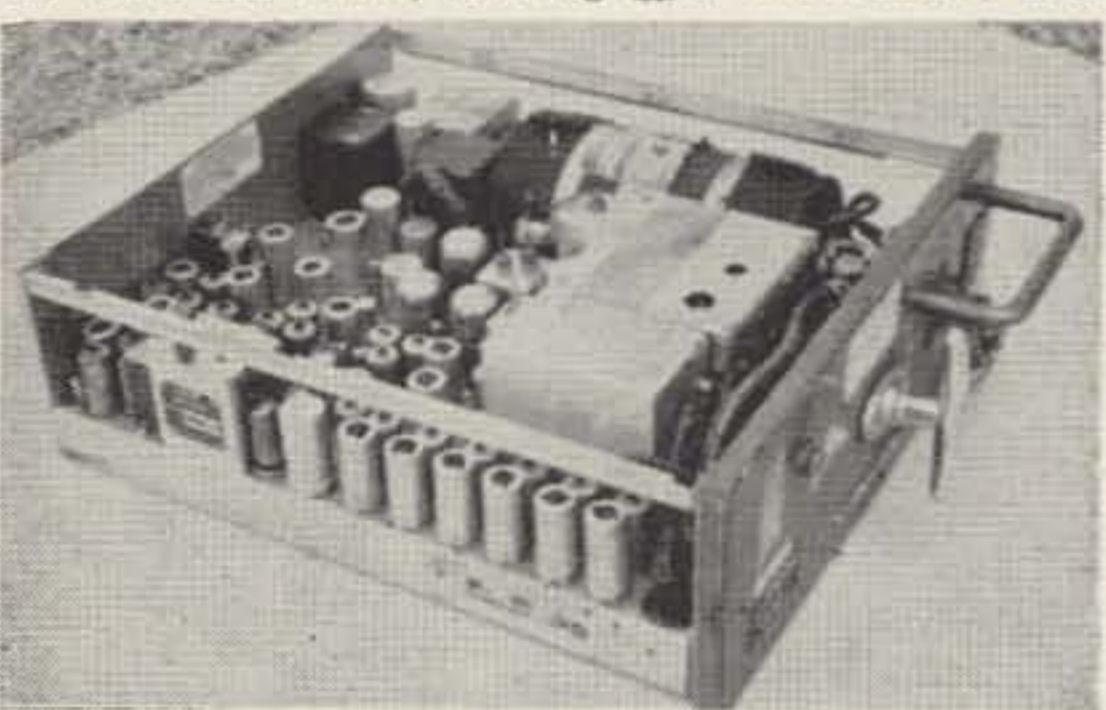

MOTOROLA FMTRU-140-D
MOTOROLA FMTR-140-D
 This unit has a 60 watt transmitter using 829B in final. Vibrator P.S. for receiver and Dynamotor for Transmitter. Shipping Wtg. 50 lbs.
 Catalog #20, 150 MC 6V Price \$54.50
 Catalog #21, 30-50 MC 6V Price \$54.50
 15" Case for above, Catalog #19 Price \$ 2.50
 80D and 140D units have chassis cutouts for adding 2nd frequency oscillator deck to transmitter.

FM Equipment

All equipment is offered to licensed radio amateurs only. Quantities are limited to two items to a customer. Each unit unless otherwise noted is a complete receiver, transmitter and power supply, a tube or two may be missing. Cases, cables, microphones, control heads and crystals are not available. Equipment is offered "as-is." Any purchase may be returned to us, freight prepaid, for a full refund if you are not satisfied. All items subject to prior sale—Terms: Payment with order—Shipping: FOB Boston—Specify carrier. Prices and specifications subject to change without notice.

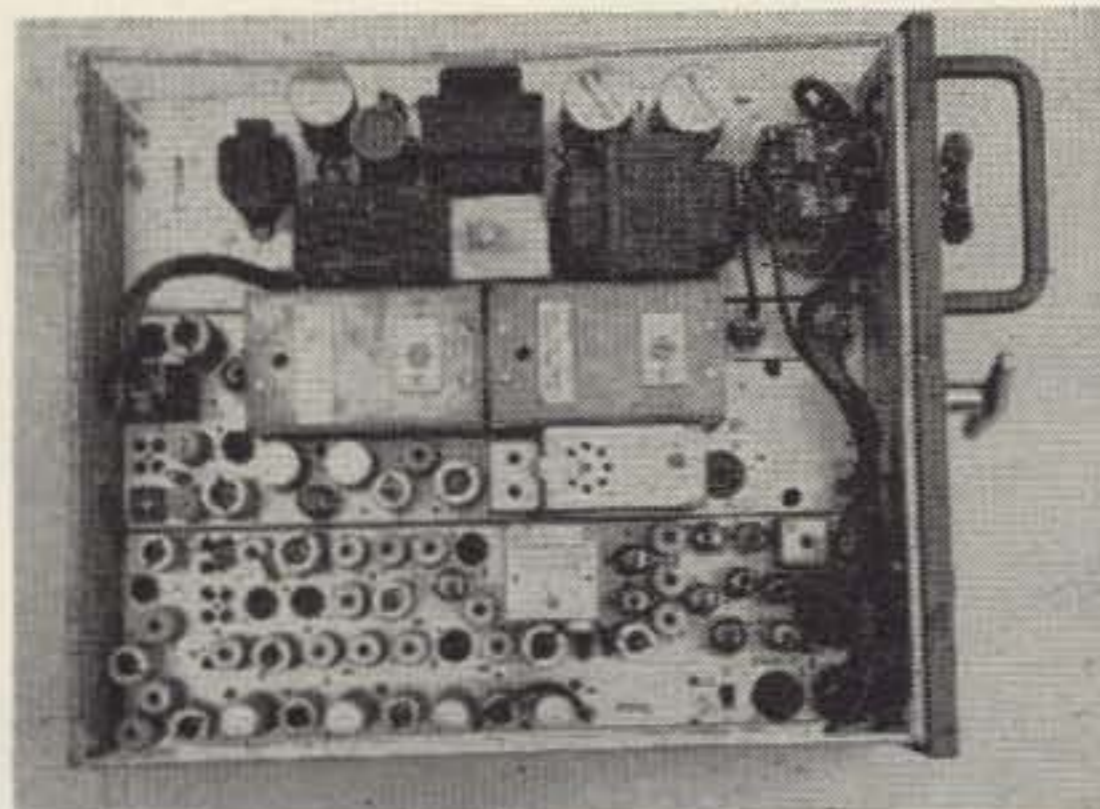

MOTOROLA T44A 6V
 Transmitter has 2C39 final in cavity. Will tune to 432MC readily. Output is 15-18 watts. 2C39 tubes included, a few small tubes and crystals may be missing.
 Catalog #10 Price \$40.00
 15" Case for above, Catalog #19 Price \$ 2.50

BOOKS

Wide-Band FM for the Amateur by Aagaard and Dubois. Covers specific conversion of Motorola gear to 2 meters. 47 pages Price \$1.75 postpaid
Motorola FM Equipment Schematic Digest. Contains a comprehensive collection of Motorola transmitters, receivers, power supply, and inter-connecting diagrams for Motorola FM equipment manufactured between 1949 and 1954. Covered is 30-50 MC, 150-170 MC and 450 MC equipment. Crystal formulas, crystal correlation data and basic alignment instructions are given. A Test set diagram is given for metering all Motorola gear. Typical readings for many transmitters are tabulated. A brief description is given for each generic type of Motorola chassis. Specific crystal data and complete alignment and 432 MC conversion instructions are given for Motorola T44A Series 450 MC equipment. 55 Pages. Price \$3.50 P.P.

FM SALES Co.

1100 TREMONT ST.
 ROXBURY 20, MASS.
 Phone: 617-427-3511

Belgium Rally

Sept. 22

Special licenses can be had for operation in Belgium from Sep. 14th to 30th for participation in the Red Cross Centenary Radio Rally on 2M and 80M phone. Write Rene Vanmuyssen ON4VY, 81 Rue J. Baus, Wezembeek-Oppen, Bt., Belgium, giving names, addresses, calls of all ops, car license, dates in Belgium, photo copy of your ham license, power and freqs of your mobile rig covers. If you are going to be around on Sep. 15th you may want to try a fox hunt in Brussels. For details on this direction finding contest write V. Claeys ON4UM, 68 Rue Haute, Beersel, Brabant, Belgium. If you would like a Dutch license for the same period send the same info to N.A.S. Fitch G3FPK, 79 Murchison Rd., Leyton, London E 10, England.

YOU NEED THIS!

Hardware special—No junk—5 pounds of machine screws and nuts, all made recently to mil. specs. All brass, mostly nickel plated. Slotted head screws. 4-40, 6-32, 8-32, 10-32. About 20 varieties, separately bagged. About 1500 pieces. 5 pounds, \$2.75 10 pounds, \$5.00.

PRECISION 60 cycle FREQUENCY STANDARD Transistorized, crystal-controlled. Operates on 12 volts DC. Output is 16 volt peak-to-peak complementary square-wave into 15K ohm load. In aluminum can 1 3/4" diam. x 5" long, plugs into octal socket. Original cost \$165. Like new. Only 12 available. \$15.00 each.

JEFF-TRONICS

Send for our 20 page catalog
 4791 Memphis Ave. Cleveland, Ohio 44109

HIGH-MFD CAPACITORS

2500 MFD 100 WVDC	\$2.25 delivered
3500 MFD 100 WVDC	2.75 delivered
1300 MFD 150 WVDC	2.10 delivered
2200 MFD 150 WVDC	2.45 delivered
150 MFD 400 WVDC	2.50 delivered
200 MFD 400 WVDC	3.10 delivered
175 MFD 450 WVDC	3.10 delivered

CONICAL STANDOFF INSULATORS

height	base dia.	price
1"	3/4"	10 FOR 95c delivered
2"	1 1/8"	6 FOR 1.65 delivered
3"	1 1/2"	4 FOR 2.65 delivered

CYLINDRICAL STANDOFF

2"	1"	4 FOR 1.25 delivered
----	----	----------------------

HIWAY COMPANY

SATISFACTION GUARANTEED

1147 Venice Blvd., Los Angeles 15, Calif.

Short Items, but Interesting



Second Op

Some of the newer DX'ers may not be familiar with W9IOP's "Second OP" slide

chart. They should be. For one dollar "Electro-Voice, Buchanan, Michigan, will mail you this gadget which will save you a lot of time in looking things up in the Callbook.

The slide-chart has all of the countries listed by call letters prefix and gives you the location, zone, country, great circle bearing, time differential and postage rates as you dial. The chart also has the QSL Bureaus listed, which can be handy.

Electro-Voice has just brought the chart up-to-date on both countries and postage, so send for one of these Second Ops and keep it on the operating desk to help you in DX'ing and QSL'ing.

Club Subscriptions

At the next club meeting we would appreciate it if you would call our group subscription rate to the attention of the members. In groups of five or more simultaneous subscriptions (or renewals) the rate is \$3.00 per year until our coming subscription rate increase (shortly). Please be sure to send five or more at once, include calls and QTH's and issue we should start the sub with.

HOW WILL IT ALL COME OUT?

Will Wayne get his head handed to him? Will Clif Evans get sued? Will the ARRL change their tune? Will our next issues be as big as we think they will be? Subscribe and see. Subscribe anyway.

Name Call

Address

City Zone State

\$3.50 One Year \$6.50 Two Years \$9.00 Three Years

\$40 Life (yours or ours)

50c each enclosed for the following back issues

(All 1960 issue \$1)
(Jan. '61 out of print)

Class license

\$1.00 enclosed for one year membership in Institute of Amateur Radio.

Send to: 73, Peterborough, N. H.

Mobile Clinic

One of the biggest problems with mobile operation is getting that antenna tuned up right. New-Tronics is doing something about the problem: mobile clinics wherein test equipment is brought out to check the power output of transmitters and the match of the antenna. This is a service to hams that would do well to be spread.

These clinics are being conducted by John Altmayer K8UQV, New-Tronics President and Fred Ohman W8FAT, Electronics Sales Manager.



John K8UQV, H. E. Ruble W8PTF of SREPCO and Fred W8FAT look over a well tuned car at SREPCO in Dayton where several hundred hams attended the clinic.



Fred W8FAT checks output of new Drake TR14 transceiver for Clem Wolford W8ENH using a Waters Dummy (no offense) Load Wattmeter.

COLUMBIA GEMS!

MOTOROLA 30-D TYPE FM BASE STATION

30-40 Mc. Transmitter-Receiver. 50 W. output. Housed in beautiful 5½ ft. metal cabinet with 3 meters and built-in speaker. Power input 110 VAC, 60 cyc. Desk console remote amplifier. This is a superb unit in excellent cond. Great buy!\$149.50

NAVY MODEL RAX RECEIVER

Unit No. 1. 200 Kc.-1500 Kc. Like new. ONLY\$24.95

AN/ARC-3 MAINTENANCE MANUAL. Late edn. \$9.95

COMMAND TRANSMITTERS

2.1-3 Mc. New.. \$6.95 4-5.3 Mc. New\$7.95
3-4 Mc. Excel. .. 7.95 5.3-7 Mc. (Less tubes) 2.95

TRANSISTOR TAPE RECORDERS

So low in price—so high in value! Importers' close-out! These units record, play back, and erase. Built-in speaker, single speed, volume control, etc. Comp. with mike, batteries and case. Reg. . \$29.95.
Like new & excel. cond.\$9.95
SAME AS ABOVE, but less case and mike. As is:\$3.95

TRANSMITTING TUBE SPECIALS! All new, unused — guaranteed!

4-65A	\$ 9.95	811	\$ 3.95
4-125A	19.95	811A	5.95
4-400A	24.95	813	12.50
807W/5933	2.95	832	4.95

COLLINS ART-13 RADIO TRANSMITTER

2-18 Mc. 100 W. output. This is the famous one! Excellent condition. A terrific buy at only\$49.95
GOOD CONDITION\$39.95

HEADSET & MIKE BARGAINS

HS-23 HEADSET: 4,000 ohms. New\$ 4.95
HS-33 HEADSET: 600 ohms. Brand new\$ 5.95
T-17D CARBON MICROPHONE: Brand new\$ 9.95
RS-38 CARBON MIKE: With coil cord and PL-68 Plug. Brand new and bargain buy\$ 9.95

COLUMBIA SPECIALS

R-388/URR COLLINS 51J-3 RADIO RECEIVER: Excel. Checked out. Guar.\$595.00
HAMMARLUND SP-600 RADIO RECEIVER: Excel. Checked out. Guar.\$449.50
H.P. MODEL 524A FREQUENCY COUNTER: Excel. Checked out. Guar.\$895.00
TEKTRONIX 511-AD OSCILLISCOPE: Excel. cond. Checked out. Guar.\$195.00
TEKTRONIX 511-AD OSCILLOSCOPE: Excel. cond. Checked out. Guar.\$395.00
MEASUREMENTS CORP. MODEL 80 SIG. GENERATOR: Excel. Checked out. Guaranteed. A Columbia Special. Only\$345.00
I-20SD FM SIG. GENERATOR: 1.5-4.5 Mc. and 19-45 Mc. New cond. Checked out. Guaranteed. Reg. \$150.00. Only\$89.50
PP-823/ARC-32 GROUND AC POWER SUPPLY FOR ARC-27: 110 V. 60 cyc. Less case. Excel. cond. Checked out. Guar....\$89.50
POLARAD MODEL TSA SPECTRUM ANALYZER: Less tuners. Excel. cond. Checked out. Guaranteed\$495.00
VECTRON MODEL SA-20 SPECTRUM ANALYZER: With S-Band Tuner. Excel. cond. Checked out. Guar. Only\$395.00
LR-1 GENERAL RADIO HETERODYNE FREQUENCY METER: 160 Kc. to 15 Mc. .003% on fundamental. Excel. Checked out. Guar.\$295.00
TS-382D/U AUDIO OSCILLATOR: 20-200,000 cyc. Excel. Guar.\$295.00
TS-403/U SIGNAL GENERATOR: This is military version of H.P. 616A. 1800-4000 Mc. Excel. Checked out. Guar.\$695.00
PRS-3 LINE DETECTOR: This is the hot 1953 model. Excel.\$39.95
SCR-625C MINE DETECTOR: World War II Model. New. FOB Los Angeles or New York City, N. Y.\$39.95
RT-82/APX-6 TRANSCEIVER: 1220 Mc. Excel. cond.\$24.95
SCR-522 2-METER TRANSCEIVER: Excel. cond. Only ...\$19.95

COLUMBIA ELECTRONICS

4365 WEST PICO BLVD. LOS ANGELES 19, CALIF.

Before you become a Silent Key

Carole Hoover K9AMD

According to the old saying, there are just two things you can count on: death and taxes. Settling up with Uncle Sam may be a must every April 15, but a fellow usually isn't forced to ponder his date with the Grim Reaper—and many don't. Ever!

Admittedly, it may sound morbid to suggest thinking seriously about joining the Silent Key list, but it's time something was said. Too often, a ham magazine carries the sad story of an ill-advised widow who sold her OM's deluxe station for a song. Every year, thousands of dollars are lost to needy wives and children who simply don't know what their relatives have invested in amateur radio equipment. And they're really not to blame.

There's probably not a ham on the air who hasn't pulled a sneaky trick to get a transmitter, receiver, or other accessory into the house without an uproar. Have you ever heard of a guy telling the little woman that his new rig cost about half the actual price? Or of a purchase made half by check and half by cash to keep the XYL from raising Cain about it? Sure you have. And in many ham shacks, equipment catalogs are carefully concealed to keep the folks or the lady of the house from throwing cold water on a dream station or antenna system.

The only way to help your wife or parents avoid a real skinning should you pound at the pearly gates before expected is to put some prices and values in black and white. A complete inventory of equipment kept up to date and filed among personal papers is a simple solution. One Midwest ham prepares labels giving model number, purchase cost, and suggested selling price and sticks it to each piece of equipment. This plan proves helpful for swapping purposes at any time.

Another suggestion is to gather the family and have a down-to-brass-tacks discussion of how to get the most out of equipment. Many electronic firms mail fliers listing surplus gear and current selling prices. And if a wife knows the right firm to contact, she can get the facts and figures to use as a guide. An only-ham-in-town should make certain his wife has the name and address of a trusted friend, also licensed, who could assist her in the disposal of equipment at fair prices.

Life begins at 40, somebody said, and you may be able to cut the mustard at 100; but just in case you should make a wrong turn during an orbital flight or decide to pull a Rip Van Winkle, why not assure your family of the returns they should have from your investments.

... K9AMD

General Coverage with the Collins S Line Receivers

Ray Moore K1DBR

The Collins 75S-1 and 75S-3 hamband receivers will tune a large segment of the high-frequency bands outside the amateur bands with no alterations of any kind. They will tune 15.033 mc to 15.433 mc which includes almost all the 19 meter broadcast band and 11.533 mc to 12.133 mc, with a 100 kc gap, which is most of the 25 meter broadcast band, as well as the 8.923 mc to 9.323 mc band. No extra crystals are required.

This is possible because the preselector (rf and mixer) tuning is not ganged to the vfo in the "S" line receivers. It works like this, taking band 3C as an example. This band covers 14.8 to 15 mc using a 8.9775 mc crystal in the first oscillator. The first *if* has a bandpass of 2.955 mc to 3.155 mc. Using the second harmonic of the crystal we get $17.955 - 2.955 = 15.000$ mc and $17.955 - 3.155 = 14.800$ mc. Performing the same arithmetic using the fundamental of the crystal except that we must use the sum of the frequencies (explained later) we get $8.9775 + 2.955 = 11.9325$ mc and $8.9775 + 3.155 = 12.1325$ mc. A look at the preselector tuning curves in the instruction manual tells us that the preselector will tune 11.933 mc to

SUMMER SPECIALS FROM SPACE

BC-221 Freq. Mtr 125kc to 20mc/s	\$70.00
TS-174/U Freq. Mtr 20mc to 250mc/s	\$150.00
TS-323/UR Freq. Mtr 20mc to 450mc/s	\$195.00
TS-175A/U Freq. Mtr 85mc to 1000mc/s	\$135.00
AN/URM-25D Sig. Gen. 10kc to 50mc	\$395.00
TS-588A/U Sig. Gen. 5kc to 50mc/s	\$390.00
TS-418/U Sig. Gen. 400mc to 1kmc	\$325.00
TS-419/U Sig. Gen. 900mc to 2100mc/s	\$475.00
TS-155C/U Sig. Gen. 2700mc to 3400mc/s	\$135.00
Ferris Mod 18c Microvolter 5 to 175mc/s	\$95.00
Gen. Radio 1208B 65mc to 500mc/s	\$140.00
FXR-W410A Wavemeter	\$100.00
<hr/>	
Ballentine 300 VTVM	\$99.00
Hewlett Packard 400C VTVM	\$115.00
Hewlett Packard 430B Power Mtr	\$120.00
Hewlett Packard 526B Plug-in	\$110.00
Hewlett Packard 525A Plug-in	\$130.00
Hewlett Packard 526C Plug-in	\$125.00
Hewlett Packard 100A	\$100.00
TS-382D/U Audio Gen. 20cps to 200kc	\$295.00
TS-268D/U Extal Rectifier Test Set	\$17.50
Simpson 260 VOM	\$25.00
TS-375A/U VTVM	\$65.00
Simpson 303 VTVM	\$55.00
Tektronix 105 Sq. Wave Gen.	\$190.00
Tektronix "CA" Plug-in Head	\$140.00
Tektronix "K" Plug-in Head	\$75.00
Dumont 304AR Scopes	\$195.00
Dumont 256D Scopes	\$99.00
Dumont 324 Scopes	\$245.00
EE-8 Field Phone—Like New Complete 12.00 ea. 2/\$20.00	
Nylon Box Kite for Field Day etc.	\$4.95
T-179/ART-26 HAM TV Transm. w/All Tubes	\$59.50
Sperti Vacuum Switch for Art-13 Etc	\$1.00
General Radio 200B Variac New	\$7.50
100 ft. Rg 11A/U Coax w/PL-259 Ea. End New	\$5.95
3ph Transatron Stack Rectifiers 50v PIV per arm 47amps	
New	\$19.95
255A Polar Relays	\$4.50
Sockets for Above Relay	\$2.50

PL-259, S0239, M-359-UG-100A/U New Any 3	\$1.00
T-18-ARC-5 Transmitter 2.1 to 3mc New	\$9.95

RECEIVERS	
SP-600 JX—540kc-54mc/s	\$450.00
R-388 (51J3) 500-30.5mc/s	\$575.00
R-390 Digital Job 500-32mc/s	\$990.00
URR-13 225 to 400mc/s	\$420.00
AR-8506B RCA Marine Rcvr.	\$240.00
AR-88 500kc to 32mc/s	\$170.00
CR-10 RCA Fixed Freq.	\$75.00
Wilcox F-3 Fixed Freq.	\$65.00

Boonton 212A Glide Scope Tester L/N	\$750.00
-------------------------------------	----------

NEW SURPLUS TUBES GUARANTEED					
2C39A	\$7.50	250TH	\$18.50	GL6442	\$20.00
3CX100A5	\$10.00	4X250F	\$25.00	5894	\$17.50
6161	\$35.00	807	\$1.00	416B	\$12.95
4-65A	\$7.50	6360	\$3.50	7212	\$4.95
8005	\$14.00	7580	\$34.80	3-400Z	\$26.00
807W/5933	\$2.00	6AN5	\$1.25	3-1000Z	\$78.00
5881	\$1.50	723A/B	\$3.00	4X150A	\$9.95
4-125A	\$20.00	2E22	\$2.90	4X250B	\$20.00
2K25	\$5.00	4X150D	\$9.50	4X150G	\$25.00
SK-640 Eimac Sockets for 4X150A, 4X250 B, etc	\$4.25 each				
	2 for \$8.00				

We buy & sell large quantities of Military and Commercial Test Equipment. AN/GRC, PRC, TRC and test equipment TS and AN/UPM or URM. What have you for sale or trade?

—MONEY BACK GUARANTEE ON ANYTHING WE SELL—
ALL SHIPMENTS FOB BRONX, N. Y.
SPACE ELECTRONICS CO.
 218 West Tremont Ave., Bronx 53, N. Y.
 TRemont 8-5222

12.133 mc at about 4½ on the scale with the bandswitch on the "C" range.

The reason we had to take the sum of the frequencies in the example above is that the different frequencies give a range of 5.833 mc to 6.023 mc which is outside the preselector tuning range for band C. When using the sum frequencies the tuning is backwards but the 1 kc per division tuning rate is maintained so it isn't at all difficult to interpolate any dial reading. On band D it is possible to use both the sum and difference frequencies of the fundamental.

The table lists the frequencies which can be tuned using this method.

... K1DBR

Band	Preselector Setting	Main Tuning Dial				
		0	50	100	150	200
3D	4½	15.433	15.383	15.333	15.283	15.233
2D	4½	15.333	15.283	15.233	15.183	15.133
1D	4½	15.233	15.183	15.133	15.083	15.033
3D	1	9.123	9.173	9.223	9.273	9.323
2D	1	9.023	9.073	9.123	9.173	9.223
1D	1	8.923	8.973	9.023	9.073	9.123
3C	4½	12.133	12.083	12.033	11.983	11.933
2C	4½	11.833	11.783	11.733	11.683	11.633
1C	4½	11.733	11.683	11.633	11.583	11.533
1E	1¾	12.673	12.723	12.773	12.823	12.873

A FEW LUCKY BUYS

(I fell in)

SAVINGS PASSED ON!

Mechanical Filter	COLLINS type F-250-85 250 KC, 8½ KC band width for mobile AM.	\$12.00 ea.
Crystal Oven	BLILEY #TC0-1,6.3v .85A 75 C, takes HC6/U crystal. Fits into octal socket.	\$2.50 ea.
5/8" Punch	GREENLEE, BRAND NEW	\$1.25 ea.
RG9B/U 51 Ohm	Silver plated RG8/U 30' with 2 UG-21B/U BRAND NEW, surplus.	\$2.25
Dual 75mmf 9000V	EFJ, Split stator. ¼" gap. 2 bearing, 2 ¼" shafts. NEW.	\$10.00
	→ 6146A \$3.00 ←	

COMMAND TRANSMITTERS

back to 1947 prices!

T-18/ARC-5	2.1 to 3 MC convert to 160 meter. BRAND NEW	\$6.50
T20/ARC-5	4 to 5.3 MC, convert to 80 or 6 meter. Ex. used \$5.00.	Brand New \$5.75
T21/ARC-5 or BC-458	5.3 to 7 MC, convert to 40 meter, or use with CENTRAL ELECTRONIC'S SSB-VFO Kit. Very excellent used.	\$6.50

Save your loot, I'll have a wagon load of GOODIES at Warren, Ohio Aug. 25; Cedar Rapids, Iowa Sep't 1; Findlay, Ohio Sep't 8; Peoria, Ill. Sep't 15; Cincy, Ohio Sep't 22.

All orders, except in emergency or I'm at a hamfest, shipped same day received. For free "GOODIE" sheet, send self addressed stamped envelope—PLEASE. PLEASE—include sufficient for postage & insurance. Any excess returned with order.

B C Electronics

Telephone CALumet 5-2235

2333 S. Michigan Ave Chicago 16, Illinois
 AMATEUR, AIRCRAFT AND MARINE RADIO EQUIPMENT
 PARTS AND ACCESSORIES

WANTED TO BUY

TOP PRICES PAID

RT-77, RT-66, 67,-68/GRC
R-274D, R-388, R-390, etc. receivers
BC-6101 Transmitters
AN/PRC-, GRC, and-TRC Eqpt
ARC-27, 34, 55, 65, etc.
ARN21 & higher; APN-22, APN-70
AN/VRR-13, -21, -28, etc.
TS-, & AN/UPM, -URM, -USM
as well as commercial test equipment.

Advise condition & price — We pay freight

Amber Industrial Corp.

75 Varick Street, N. Y. 13, N. Y. — CAnal 6-7455

Improving the W2JAV RTTY Converter

After building the W2JAV radioteletype converter I could not see too much advantage in using the T. W. Groger, W7HJC, brain child in the circuits of tubes V3 and V4.

Finally the two 47K-ohm resistors in the plate circuits of V3A and V3B were changed over to a single 100K-ohm linear pot. After once adjusting this pot along with R-1, the 50K ohm balance control, the brain child of W7HJC started doing its proper job. Now I can copy RTTY signals that I thought were impossible.

... K4GRY

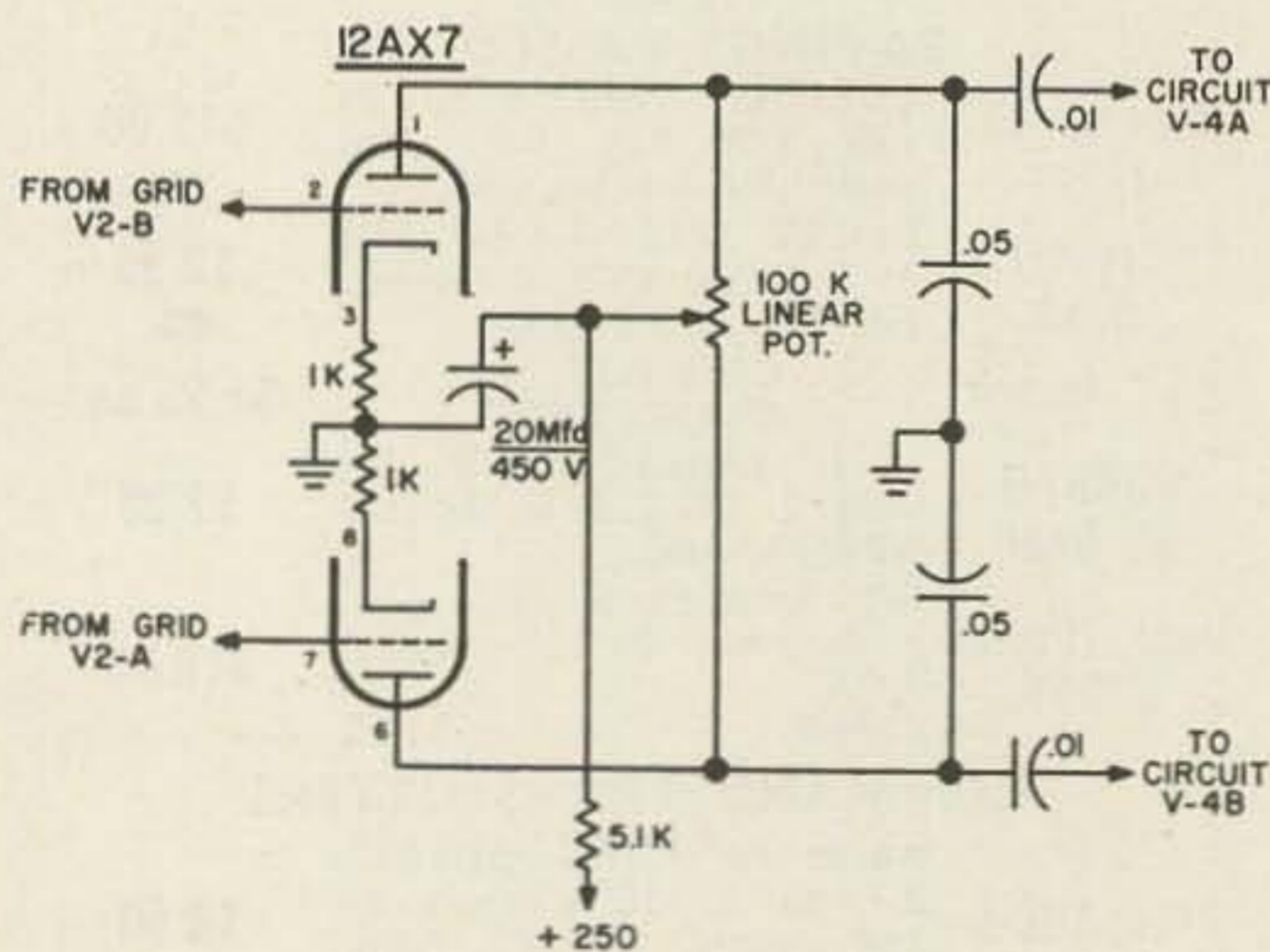

IMPROVING THE W2JAV RADIOTELETYPE
CONVERTER

SEE PAGE 43 OF APRIL, 1958 CQ

(W2NSD from page 6)

raise any strenuous objections to our filling this obvious void.

Perhaps in a few months we will be able to get our Area Coordinators together and evolve a more formal organization. In the interim I am going to act as Interim Secretary and start the ball rolling. By the time you have read this a letter will have been sent to all In-

stitute members explaining this project and asking for volunteers who are willing to invest some of their hamming time and perhaps even some postage and phone money in acting as Area Coordinators or Division Directrs. I've asked them to send in a short resumé of their ham and personal background. I'll send out a copy of these resúmes to all of the Institute members in each area so they can vote for the men they think will do the best job for them as Coordinator and Division Directors. It seems to me that we will be a lot better off to have all of the members voting for their officers rather than having a set of Directors electing their own choice for officers, which could end us up with officers seeing to it that the Directors are voted in which will perpetuate them in office . . . a round robin which we've already seen and don't want to duplicate.

Membership in the Institute is \$1 per year. How about *you*, will *you* help?

Boo Boo

There was much to-do last month when we managed to print the issue before a major error was discovered in the Linear Systems ad. The prices on their two inverters are remarkable enough without their being transposed. The 150 watt model (12 volts dc to 120 volts at 60 cycles) is small and light enough to mount just about anywhere in the car. I've always mounted an inverter in my cars so that when I want to run a small rig, tape recorder, public address system, etc., all I have to do is plug it in. 150 watts will handle most gear easily.

Europe

The Institute trip to Europe is in fine shape. We've about 75 coming along. A list of the members of the trip is available for the price of a self addressed stamped envelope, complete with a short biography of most of the tourers.

We leave Idlewild October 6th in the evening, fly to London for four days . . . then Paris, Geneva, Rome, Berlin and back to New York on the 28th. The round trip fare, for anyone interested in joining us, is \$550. This includes all transportation, hotels and breakfasts.

Hello CQ

The July issue of CQ finally dedragged itself in here the other day. Come on CQ, you can do better than that! Since a great many of 73's readers no longer bother with CQ I'll give you a short rundown on this issue.

After piecing together the torn shreds of cover I found that they were busy celebrating



MADT HI FREQ TRANSISTORS

All guaranteed, factory marked. exlnt for converters, CB transmitters, 6 meters, etc. Factory closeout bargain. 5/\$1.00

48 VOLT DC REGULATED

SOLA 48 volt DC 4.5 amp regulated plus 6.3 at 3 amps 115 volt 60 cycle input. Like new. \$17.50

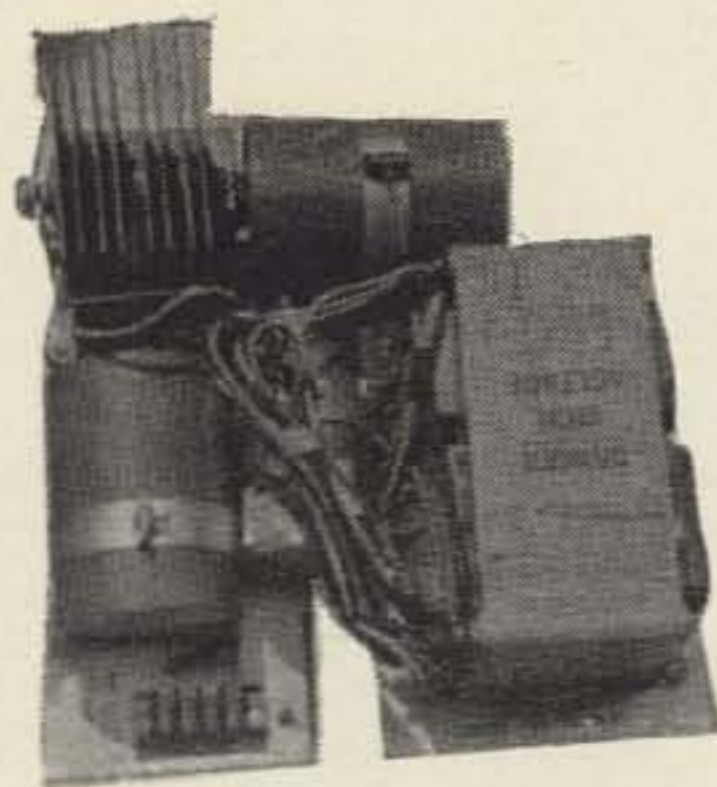

AN/PDR-27 GEIGER COUNTER

One of the Navy's finest. 4 ranges .5-5-50-500 MR/HR Detects Beta & Gamma. Detachable probe on coil cord. Complete ready to use with headphones (not shown) and shoulder strap. With Fresh batteries. Just in time for Summer prospecting.



\$35.00

LATCHING RELAY

24 Volt DC coil, latch & unlatch. 4PDT 10 amp contacts. \$1.50

POWER TRANSFORMER

115 volt 60 cycle 2,540 volt CT 400 ma Stock #T-50 \$12.50

PYRANOL CAPACITORS

8 MFD 1,500 VOLT \$1.75

SWINGING CHOKE

.40/.10 amp 4/12 Henry Stock #CK-1 \$4.00

866 TRANSFORMER

2.6 volt 10 AMP \$3.00

JOHN MESHNA, Jr. Surplus Electronic Material

19 ALLERTON ST.

LY 5-2275

LYNN, MASS.

Catalog #63 just off the press. 10c handling would be appreciated. All material FOB Lynn, Mass.

the RSGB's 50th anniversary. If your copy arrived without a shredded cover you didn't miss anything. I sure wish they would spend the fraction of a cent necessary to mail it in a wrapper. Inside I found at least six articles that seemed awfully familiar . . . aha! . . . I'm sure that at least five of 'em have been here first and been rejected. The sixth was a reprint from a year old copy of the now defunct VHF Amateur, though not labeled as such. The editorial opposed the ARRL proposal for Techs to have the entire two meter band.

This did it to me. In June they backed up the ARRL's disastrous proposal to segregate our phone bands and this month they come out in opposition to Techs on all of two meters, a not unreasonable proposal. There is nothing like being out of step *all* the time.

The present system of having two separate two meter bands is a hardship on all operators. It unnecessarily discriminates against the Technician during contests when a good deal of the activity is going on down at the forbidden low end. The level of QRM is low enough so there is no advantage to the enforced spreading out of stations, it just makes it that much more difficult to tune the band. Let's open 144-148 to the Techs.

. . . Wayne

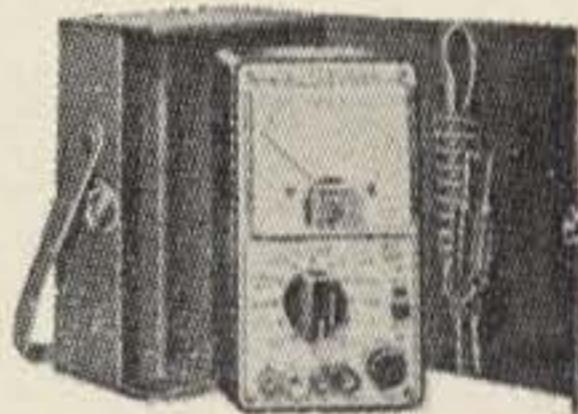

PICTURE WINDOW MULTI-METER IN CARRYING CASE HAS 300 MICROAMP MOVEMENT.

Measures:

DB - Volts - Mils
(AC - DC) ohms
\$12.95 complete

Also have pocket size multi-meter

\$6.95

Send self addressed envelope for PANEL METER listings.

ARROW SALES

2534 S. Michigan Ave. Chicago, Ill.

ALL BAND TRAP ANTENNA!



Reduces interference and Noise on All Makes Short Wave Receivers. Makes World Wide Reception Stronger. Clearer on All Bands!

For ALL Amateur Transmitters. Guaranteed for 500 Watts Power for Pi-Net or Link Direct Feed. Light, Neat, Weatherproof

Complete as shown total length 102 ft. with 87 ft. of 72 ohm balanced feedline. Hi-impact molded resonant traps. (Wt. 3 oz. 1" x 5" long). You just tune to desired band for beamlike results. Excellent for ALL world-wide short-wave receivers and amateur transmitters. For NOVICE AND ALL CLASS AMATEURS! NO EXTRA TUNERS OR GADGETS NEEDED! Eliminates 5 separate antennas with excellent performance guaranteed. Use as Inverted V for all band power gain. NO HAYWIRE HOUSE APPEARANCE! EASY INSTALLATION! 80-40-20-15-10 meter bands. Complete . . . \$14.95 40-20-15-10 meter bands. 54-ft. ant. (best for swl's) . . . 13.95 SEND ONLY \$3.00 (cash, ck., mo) and pay postman balance COD plus postage on arrival or send full price for postpaid delivery. Complete installation & technical instructions furnished. Free information.

Available only from: WESTERN RADIO — Dept. A7-9 — Kearney, Nebraska

73

P

R

O

D

U

C

T

S



73 parts kits

In the interests of making home construction simpler for those readers with anemic junk boxes 73 has gathered together the parts required for building our less complicated projects. These kits are as complete as we can make them, containing good quality parts. Except where the chassis or case is integral to a unit we do not supply it. We will mention when we do supply a case or chassis. We do supply tubes, sockets, condensers, resistors, transformers, connectors, etc. The kits are kept in stock to the best of our ability, though sometimes the distributors who supply us delay us a bit.

TWO METER PREAMPLIFIER. Uses two 6CW4 nuvistors in a grounded grid input circuit (March '63 p8) and one 6CW4 nuvistor grounded grid output. Complete with power supply. Uses 50 volts on the plates for extraordinary noise figure. Full scale drilling template supplied.
W9DUT-1 \$18.50

QRP TRANSMITTER. Have fun with this little one half watt CW rig on 40 meters. Uses any 40M surplus crystal. Kit supplies 1S4 tube and socket, condensers, resistors, coil, rf choke, terminal trip, etc. Runs from flashlight battery for filament and portable radio 67½ volt B-battery. See March '63 p22
W1MEL \$6.00

15-20 METER NUVISTOR PREAMPLIFIER. Need more hop on these bands? This simple to build preamp will bring up those signals. This is particularly good for inexpensive and surplus receivers. See April '63 page 40
W6SFM-1 \$4.00

TRANSISTOR POWER SUPPLY. Voltage regulator adjustable power supply for running transistor equipment. Takes the strain off those transistor batteries. Great for the test bench. See April '63 page 8. Uses five transistors, one zener, cute little (expensive) meter, etc. Will deliver up to 100 ma continuously, voltage from 0.35 to 15.0.
W11S1 \$25.00

TRANSISTOR TRANSCEIVER. One of the most popular kits we've ever assembled is this six meter miniscule transistorized transceiver. Really works. Hundreds built. See page 8 in the May '63 issue. Five transistors.
K3NHI \$25.00

CW MONITOR. Connects right across your key and gives you a tone for monitoring your bug. Page 44, June '63.
WA2WFW \$4.25

TWOER MODIFICATION. Increase your selectivity considerably by installing a new triode 7587 nuvistor stage. This is our best selling kit to date. Everything you need for the modification is included. See June '63 page 56
K6JCN \$6.50

SIX METER CONVERTER, DELUXE. 6EW6 low noise front end, 6U8 oscillator and mixer. Output is 10.7 mc (easy to change to suit your needs). This is a tunable converter with fixed frequency output, not the usual converter that requires you to tune the receiver. This helps considerably on eliminating interference from nearby high power stations. See page 8, July '63.

W6DUT-2\$20.00

TUNING EYE KIT. This kit enables you to install a dual tuning eye in any transmitter to indicate the tuning of two or more stages. It works far better than a meter or even meter switching. See page 22, July '63.

K6GKU\$7.50

NOISE GENERATOR. Invaluable test instrument for tuning up rf stages, converters, etc., voltage regulated by a zener diode. Kit includes even the battery and mini-box.

K9ONT\$5.00

73 News. Published monthly, editor VE3DQX. Keeps you up-to-date on current ham events. Invaluable to club officials for discussions at club meetings. Good source material for club bulletins. 1.00/year.

Ham-RTTY. This is the most complete book on the subject. Written for the beginning TT'er as well as the expert. More complete and authoritative than books at twice the price. Pictures and descriptions of all popular machines, where to get them, how much, etc. \$2.00

Bound Volume 1. Gorgeously bound library volume (bright red) of the first fifteen issues of 73. This is the only way to get a complete set of the early issues of 73. We'll pay \$1 each for copies of the January 1961 issue in good condition so we can make a few more bound volumes. Covers October 1960 through December 1961. \$15.00

Bound Volume 2. Complete matching volume covering 1962 issues of 73. \$15.00

Binders. Bright red leather binding. Specify which year you want stamped on them: 60-1, 62, 63. Darbs. \$3.00 each.

Back Issues. Since each issue of 73 features articles of a fairly timeless nature each back issue is just as much fun reading as the current issues. All back issues except January 1961 (we'll pay a dollar for these if you can find any) are on hand, some in mighty small quantities.

1960 issues \$1.00 each.
February 1961-date 50¢ each.

Care and Feeding of Ham Clubs—K9AMD. Carole did a thorough research job on over a hundred ham clubs to find out what aspects went to make them successful and what seemed to lead to their demise. This book tells all and will be invaluable to all club officers or anyone interested in forming a successful ham club. Hundreds of grateful letters have been received from clubs who have applied the ideas in this book. \$1.00

Simplified Math for the Hamshack—K8LFI. This is the simplest and easiest to fathom explanation of Ohm's Law, squares, roots, powers, frequency/meters, logs, slide rules, etc. If our schools ever got wind of this amazing method of understanding basic math our kids would have a lot less trouble. 50¢

Index to Surplus—W4WKM. This is a complete list of every article ever published on the conversion of surplus equipment. Gives a brief rundown on the article and source. \$1.50

Ham-TV—WØKYQ. Covers the basics of ham-TV, complete with how to get on the air for under \$50. Not the usual theory manual, but a how-to-do-it book. \$3.00

Surplus TV Schematics. You can save a lot of building time in TV if you take advantage of the real bargains available in surplus. This book gives the circuit diagrams and info on the popularly available surplus TV gear. \$1.00

AN/ARC-2 Conversion. This transceiver sells in the surplus market for from \$40 to \$50 and is easily converted into a fine little ham transceiver. Covers 29 mc (160-80-75-40 meters). This booklet gives you the complete schematic and detailed conversion instructions. \$1.00

AN/VRC-2 Conversion. Completely different from the ARC-2. This book gives you complete instructions on converting the inexpensive VRC surplus gear into a six meter wide band FM transceiver. There are probably over a thousand stations now operating on 52.525 mc around the country. Join the crowd. Fun. \$1.00

Coils—K8BYN. Basic book which covers the theory and practical aspects of the many different types of coils found in ham work. Well illustrated. 50¢

CW—W6SFM. Anyone can learn the code. This book, by an expert, lays in a good foundation for later high speed CW ability. 50¢

3D Map of World. Maybe you've been eating your heart out for one of these beautiful relief maps after seeing one at a friend's shack. Comes complete with one year subscription or extension to 73. \$9.95

3D Map of U. S. Complete with one year sub to 73. \$9.95

Mickey Miker—WØOPA. Complete instructions for building a simple precision capacity tester. Illustrated. 50¢

Frequency Measuring—WØHKF. Ever want to set yourself up to measure frequency right down to the gnat's eyebrow? An expert lets you in on all of the secrets. Join Bob high up on the list of Frequency Measuring Test winners. \$1.00

Impedance Bridge. Full scale construction prints for the bridge described in the August 1961 issue of 73. Comes complete with a reprint of the article. Watch out General Radio! \$1.00

SSB Transceiver Schematic—W6BUV. Giant size schematic of the transceiver that appeared in the November 1961 issue of 73. Complete with extra November issue. \$1.00

5—ANTENNAS—Kraus (W8JK). The most complete book on antennas in print, but largely design and theory, complete with math. \$12.00

11—16TH EDITION RADIO HANDBOOK—by Bill Orr W6SAI. This fantastic book is loaded with the most understandable theory course now available in our hobby plus dozens of great construction projects. This is the best ham handbook in print by a wide margin. Easily worth twice the price. \$9.50

13—REFERENCE DATA FOR RADIO ENGINEERS. Tables, formulas, graphs. You will find this reference book on the desk of almost every electronic engineer in the country. Published by International Telephone and Telegraph. \$6.00

16—HAM REGISTER—Lewis (W3VKD). Thumbnail sketches of 10,000 of the active and well known hams on the air today. This is the Who's Who of ham radio. Fascinating reading. Only edition. Now only \$2.50

18—SO YOU WANT TO BE A HAM—Hertzberg (W2DJJ). Second edition. Good introduction to the hobby. Has photos and brief descriptions of almost every commercially available transmitter and receiver, plus accessories. Lavishly illustrated and readable. \$2.95

21—VHF HANDBOOK—Johnson (W6-QKI). Types of VHF propagation, VHF circuitry, component limitations, antenna design and construction, test equipment. Very thorough book and one that should be in every VHF shack. \$2.95

22—BEAM ANTENNA HANDBOOK—Orr (W6SAI). Basics, theory and construction of beams, transmission lines, matching devices, and test equipment. Almost all ham stations need a beam of some sort . . . here is the only source of basic info to help you decide what beam to build or buy, to install it, how to tune it. \$2.70

23—NOVICE & TECHNICIAN HANDBOOK—Stoner (W6TNS). Sugar coated theory: receivers, transmitters, power supplies, antennas; simple construction of a complete station, converting surplus equipment. How to get a ham license and build a station. \$2.85

24—BETTER SHORT WAVE RECEPTION—Orr (W6SAI). How to buy a receiver, how to tune it, align it; building accessories; better antennas; QSL's, maps, aurora zones, CW reception, SSB reception, etc. Handbook for short wave listeners and radio amateurs. \$2.85

26—S9 SIGNALS—Orr (W6SAI). A manual of practical detailed data covering design and construction of highly efficient, inexpensive antennas for the amateur bands that you can build yourself. \$1.00

27—QUAD ANTENNAS—Orr (W6SAI). Theory, design, construction, and operation of cubical quads. Build-it yourself info. Feed systems, tuning. \$2.85

28—TELEVISION INTERFERENCE—Rand (W1DBM). This is the authoritative book on the subject of getting TVI out of your rigs and the neighbors sets. \$1.75

32—RCA RADIOTRON DESIGNERS HANDBOOK—1500 pages of design notes on every possible type of circuit. Fabulous. Every design engineer needs this one. \$7.50

36—CALL LETTER LICENSE PLATE—Regulation size license plate. Please give your call and the color of letters and background. \$3.00

37—101 WAYS TO USE YOUR HAM TEST EQUIPMENT—Middleton. Grid-dip meters, antenna impedance meters, oscilloscopes, bridges, simple noise generators, and reflected power meters are covered. Tells how to chase trouble out of ham gear. 168 pages. \$2.50

52—HOW TO READ SCHEMATIC DIAGRAMS—Marks. Components & Diagrams; electrical, electronic, ac, dc, audio, rf, TV. Starts with individual circuits and carriers through complete equipments. \$3.50

53—BASIC ELECTRONIC TEST PROCEDURES—Turner. This book covers just about every possible type of electronic test equipment and explains in detail how to use it for every purpose. Testing: audio equipment, receivers, transmitters, transistors, photocells, distortion, tubes, power . . . etc. \$9.75

55—TRANSISTOR CIRCUIT HANDBOOK—Simple, easy to understand explanation of transistor circuits. Dozens of interesting applications. \$4.95

63—GE TRANSISTOR MANUAL—6th edition. This is one of the best buys around: 22 chapters, 440 pages, diagrams by the gross, data, facts, charts, etc. If you don't have this one you just aren't up to date. only \$2.00

66—DESIGN MANUAL FOR TRANSISTOR CIRCUITS BY CARROLL. Tested transistor circuits for design engineers. Interesting reading too. \$9.50

SPECIAL SPECIAL SPECIAL Radio Handbook, 15th Edition, written by Bill Orr W6SAI, over 800 pages. Covers every phase of amateur radio from the very basics right up through the construction of just about everything you could want in ham gear. Originally published at \$8.50. Superseded by the new 16th edition which is the same except for new construction projects and selling for \$9.50 (see number 11). Special, until the last few copies are gone, only \$5.95!

67—TRANSISTOR CIRCUIT ANALYSIS AND DESIGN by Fitchen. Written primarily as a college text to teach circuit design. \$13.00

68—HANDBOOK OF TRANSISTOR CIRCUIT DESIGN BY PULLEN—This is a handbook which teaches a systematic system for transistor circuit design. Highly recommended by radio schools. \$13.00

74—HANDBOOK OF ELECTRONIC TABLES & FORMULAS—Formulas & laws, constants, standards, symbols and codes. Math. tables, misc. data. \$2.95

76—MODERN OSCILLOSCOPES & THEIR USES—Ruiter. Second edition. Shows what a 'scope is, what it does and how to use it for radio, TV, transmitters, etc. 346 pages. \$10.20

80—SURPLUS RADIO CONVERSION MANUAL VOLUME NO. 1 (second edition). This book gives circuit diagrams, photos of most equipment, and rather good and complete conversion instructions for the following: BC-221, BC-342, BC-312, BC-348, BC-412, BC-645, BC-946B, SCR-274N 453A series receivers conversion to 10 meter receivers, SCR-274N 457A series transmitters (conversion to VFO) SCR-522 (BC-624 and BC-625 conversion to 2 meters), TBY to 10 and 6 meters, PE-103A, BC-1068A/1161A receiver to 2 meters, Surplus tube index, cross index of A/N tubes vs. commercial types, TV & FM channels. \$3.00

81—SURPLUS RADIO CONVERSION MANUAL VOLUME NO. II. Original and conversion circuit diagrams, plus photos of most equipments and full conversion discussion of the following: BC-454/ARC-5 receivers to 10 meters, AN/APS-13 xmtr/rcvr to 420 mc, BC-457/ARC-5 xmtrs to 10 meters, Selenium rectifier power units, ARC-5 power and to include 10 meters, Coil data-

simplified VHF, CO-9/TBW, BC-357, TA-12B, AN/ART-13 to ac winding charts, AVT-112A, AM-26/AIC, LM frequency meter, rotators, power chart, ARB diagram. \$3.00

82—SURPLUS RADIO CONVERSION MANUAL VOLUME NO. III—Original and conversion diagrams, plus some photo of these: 701A, AN/APN-1, AN/CRC-7, AN/URC-4, CBY-29125, 50083, 50141, 52208, 52232, 52302-09, FT-ARA, BC-442, 453-455, 456-459, BC-696, 950, 1066, 1253, 241A for xtal filter, MBF (COL-43065), MD-7/ARC-5, R-9/APN-4, R23-R-28/ARC-5, RAT, RAV, RM-52 (53), Rt-19/ARC-4, SCR-274N, SCR-522, T-15/ARC-5 to T-23/ARC-5, LM, ART-13, BC-312, 342, 348, 191, 375. Schematics of APT-5, ASB-5, BC-659, 1335A, ARP-2, APA10, APT-2. \$3.00

83—THE SURPLUS HANDBOOK, VOLUME I—Receivers and Transmitters. This book consists entirely of circuit diagrams of surplus equipment and photos of the gear. One of the first things you really have to have to even start considering a conversion of surplus equipment is a good circuit diagram. This book has the following: APN-1, APS-13, ARB, ARC-4, ARC-5, ARN-5 VHF, ARN-5, ARR-2, ASB-7, BC-222, -312, -314, -342, -344, -348, -603, -611, -624 (SCR-522), BC-652, -654, -659, -669, -683, -728, -745, -764, -799, -794, BC-923, 1000, -1004, -1066, -1206, -1306, -1335, BC-AR-231, CRC-7, DAK-3, GF11, Mark 11, MN-26, RAK-5, RAL-5, RAX, Super Pro, TBY, TCS, Resistor Code, Capacitor Color Code, JAN/VT tube index. \$3.00

88—EUROPE ON \$5.00 A DAY— Europe can be just as expensive as the U. S. unless you know where to stay and where to eat. This book is the standard reference work for European travelers on a budget. This is the latest edition. **\$1.95**

91—DIETZGEN 10" SLIDE RULE— This is the slide rule that is recommended in the book, "Simplified Math For The Ham Shack." With a little practice you'll have Ohm's Law whipped, and any other calculations too. Has C-D-CI-L-T-A-B-S-K scales. Beautifully made rule, complete with plastic case, looks like five times the price and works that way too. **\$2.85**

92—QSL DISPLAY PLASTIC POCKETS—Each set of clear plastic pockets holds twenty QSL's for wall display. Keeps cards flat, clean and perfect. Keeps walls clean too. Or have you tried to hang QSL's yet. This beats thumb tacks and Scotch Tape all hollow. Comes in envelope of three to hold 60 QSL's, give it a try and you'll never use anything else. **Three: \$1.00**

93—RADAR-TECTOR—This gadget, though designed to pick up police radar (which it does very efficiently we are told by several amateurs), also picks up two of our amateur UHF bands. Operates entirely from the 12v car battery. Regular price is \$44.95. **Bookshop Special \$28.95**

94—KIT OF SOLDERING TOOLS—Used to was a soldering iron was all that was necessary, now you have to have a kit of fool tools. Little doohinkies like scrapers, reamers, forks, and brushes. Forsooth! Made of varnished maple and spring steel (vastly superior to winter steel). **\$4.87**

95—NE-PAD—Pilot-type writing desk that elastics to your pants leg for mobile log-keeping. Complete with two pads of 50 special 73 mobile log sheets. You know the logs gotta be good. Extra log pads are only 25c a pad. Ne-Pad with two log pads **\$3.95**

96—LATEST CALLBOOK—There are so many changes in the Callbook that you should plan on buying a new one at least once a year.
USA Callbook **\$5.00**
Foreign Callbook **\$3.00**

97—RADIO AMATEUR DX GUIDE— Crammed with maps, time conversion tables, great circle charts, etc. Each page may be removed for mounting on wall. **\$2.00**

98—WORLD PREFIX MAP—Printed in four colors on heavy stock for wall mounting. 29" x 42". Has country prefixes, time zones, radio zones, and alphabetical listing of prefixes. **\$1.00**

99—RADIO AMATEURS WORLD ATLAS—16 pages in four colors. Shows all six continents, West Indies, country prefix list, etc. If you work any DX this atlas will be very helpful. **\$1.00**

100—ELECTRONIC CONSTRUCTION HANDBOOK by W8MQU. Covers all sorts of info on how to build. **\$2.95**

102—CALL-D-CAL. Your call letters and state on a large decal (8½" long) in five colors. DX calls on world globe. **\$1.95**

103—"SCOTCHLITE CALL." White letters on black background. Pressure sensitive to stick anywhere. 8½" long. Don't forget to give your call letters when ordering. **\$2.00**

105—THE PHILLIPS CODE. A tested method of code shorthand used since 1879 by landline ops. See page 88, March 63 issue of 73. **\$2.75**

ACR-1—ABC'S OF CITIZENS BAND RADIO—by Buckwalter. How to choose, set up, license and operate CB equipment. Discusses different types of rigs, receivers, antennas, how to tune, install, operate and troubleshoot. **\$1.95**

ALP-1—GENERAL CLASS LICENSE HANDBOOK—by Pyle W7OE. A complete guide including typical questions and answers, to help you prepare for the FCC Technician, Conditional or General amateur radio exam. A good writer is quite a help in this sort of thing. **\$2.50**

AMA-1—AMATEUR RADIO ANTENNA HANDBOOK—by Hooton W6TYH. Basic theory, construction and tuning of all the well known and effective ham antennas. Good stuff on feed lines and towers too. **\$2.50**

AMP-1—TROUBLESHOOTING AMATEUR RADIO EQUIPMENT—by Pyle W7OE. A guide for all hams who want to keep their gear on the air by themselves. Includes complete schematics of many popular ham transmitters and receivers. **\$2.50**

AMR-1—ABC'S OF MOBILE RADIO by Martin. Covers subject of two-way FM mobile operation. Equipment, control, range, power supply, receivers, transmitters, installation, and uses. Quite comprehensive. **\$1.95**

ASM—AMATEUR RADIO STATION MANUAL. Contains station log, cross index for calls/names, record sheets for WAS, WAC, WAZ, schedules, equipment records, net data, DX records, world prefixes, etc. **\$3.95**

BEO—OSCILLATOR CIRCUITS—by Adams. This book is designed for the fellow who really wants to know how electronic circuits work. It is written with incredible simplicity and uses four color diagrams to effectively explain just what happens in circuits. Covers all nine basic oscillator circuits. **\$2.95**

BER—RADIO CIRCUITS. Uses four color circuits to explain just what is happening in the various circuits in a receiver. One of the best systems yet to explain the working of circuits. **\$2.95**

CB3—CITIZENS BAND RADIO MANUAL. Just about everything you will need to know about CB, plus service data on 34 popular models of CB gear: Cadre, Capital, Citi-Fone, Eico, Globe, Gonset, Hallicrafters, Heath, ITT, Lafayette, La Salle, Magnavox, Philmore, Poly-Com, Vocaline, Webcor. **\$2.95**

DIT—DIODE CIRCUITS HANDBOOK by Rufus P. Turner. The lowly diode has come into its own these days. Here are nearly 100 diagrams of circuits with discussions and complete explanations of their operation. **\$2.50**

HAI—HAM ANTENNA CONSTRUCTION PROJECTS. Low cost construction methods, transmission-lines, antenna tuners, etc. Over two dozen interesting and inexpensive antennas. **\$2.95**

HAM—SO YOU WANT TO BE A HAM by W2DJJ. Includes all the would-be radio amateur needs to get started in ham radio. **\$2.95**

HAP-1—ABC'S OF HAM RADIO—by Pyle W7OE. How to get a Novice license. Excellent book by a top author. **\$1.95**

HRC—HANDBOOK OF HAM RADIO CIRCUITS by W9CGA. Includes circuit diagrams, photos and discussion of the circuit of 36 pieces of ham equipment. Here are the basic circuits so you can design anything you need. **\$2.95**

MAT—ELECTRONICS MATH SIMPLIFIED. Algebra, trig, logs, ohms law, frequency, reactance, inductance, capacitance, power supplies, etc. Quite comprehensive. **\$4.95**

MCN—MODERN COMMUNICATIONS COURSE—by Noll. Aimed more at commercial radio than amateur, but an excellent book for home study or class work. Covers transmitters and antennas quite well. **\$4.95**

MMD—ELIMINATING MAN MADE INTERFERENCE—What makes it, how to find it, how to cure it in homes, factories, automobiles, aircraft, boats, etc. Or maybe you haven't been plagued lately. 160 pages. **\$2.95**

QAN—2ND CLASS RADIOTELEPHONE LICENSE MANUAL—by Noll. Another 73 author makes it in the big time. Q & A manual for commercial ticket. Get one, you never know when it'll be handy . . . and this sure proves what you know, or don't know. **\$3.95**

RSG—NORTH AMERICAN RADIO-TV STATION GUIDE—Over 7500 stations listed by city, state and frequency. AM-FM-TV. **\$1.95**

SIH—SSB COMMUNICATIONS HANDBOOK—by W6YTH. This book covers all known methods of generating SSB with details on them. Discussion and schematics on many popular SSB rigs. Very educational, and mostly for the ham. **\$6.95**

SWL-1—ABC'S OF SHORT WAVE LISTENING—by Buckwalter. Covers what to listen to, frequencies, antennas, receivers, QSL's, space signals. Good basic cook for SWL'ing. **\$1.95**

TCM—TRANSISTORS CIRCUIT MANUAL—by Lytel. Schematics and descriptions of over 200 transistorized circuits, covering just about anything you can possibly want to do with transistors. **\$4.95**

TUB—TUBE SUBSTITUTION HANDBOOK. This book is invaluable when something goes blip and you are fresh out of the exact replacement. **\$1.50**

BOOKSHOP SUBSCRIPTION SERVICE

While you are sending in an order to Bookshop you may care to subscribe to one of the electronic magazines. U.S. only.

Radio-Electronics 1 yr.	\$5.00
Popular Electronics 1 yr.	\$4.00
Electronics World 1 yr.	\$5.00
ATV Experimenter 1 yr.	\$1.00
QST 1 yr.	\$5.00
CQ 1 yr. (not recommended) ..	\$5.00
Popular Mechanics 1 yr.	\$4.00
Popular Science 1 yr.	\$4.00
Science & Mechanics 1 yr.	\$4.00
Electronics Illustrated 1 yr.	\$2.00

Send check or M.O. to:
**Radio Bookshop
Peterborough
New Ham Shire**

INDEX TO ADVERTISERS

To aid you in finding ads which are not running in this issue we have listed the last ad run by each company in 73.

15	Ad Com	95	Glass, J. J.	69	P & H
May 63	Adirondack	11	Gonset	81	Poly-Paks
47	A & F Electromart	Aug. 63	Goodheart	Mar. 63	Polytronics
Aug. 62	Air	95	Graham Radio	June 63	Propagation Products
61	Alco	Apr. 63	Grantham School	July 63	QTH MAPS
Dec. 62	Alden	July 63	Groth	59	Quaker
July 63	Algeradio	45	Grove	59, 73	Quement
96	Allied	Nov. 62	Ham Aids	35	Radio Am. Callbook
47	Alltronics-Howard	Jun. 62	Ham Boards	92	Radio Bookshop
Mar. 62	Alvaradio	Sep. 62	Hamkerchiefs	Apr. 63	Radio Industries
53	Amateur Elect. Supply	Dec. 62	Ham Kits	Dec. 62	Radio Supply & Eng.
Feb. 63	Amateur Radio Exchange	Aug. 63	Ham Trader	Jun. 62	Raytheon
Oct. 62	Amatronics	CVR 2	Hallicrafters	July 63	Ready Radials
July 63	American Crystal	June 63	Hammarlund	28	Redline
May 63	Amperex	Mar. 63	Harrison, Ivan	95	Reed
27	Amplidyne	Oct. 61	Harrison Radio	June 63	Rex
July 63	Amrad	Jul. 62	Hartman	95	Reyco
Apr. 63	Arrow Electronics	Aug. 63	Hayden	Oct. 61	Rider
June 63	Arrow Sales, Cal.	June 63	Heath	Apr. 63	Ritco
89	Arrow Sales, Chi.	24	Henry	July 63	Rohn
Oct. 62	Ashe	July 63	Hi-Par	77	RW Electronics
95	Badges	83	Hi-Way	81	Sams
81	Bald Eagle	79	Holstrom	Jun. 62	Sar
Nov. 62	Barrington	Sep. 62	Hornet	Feb. 63	Schober
Nov. 62	Barry	Aug. 63	Howard	Mar. 62	Seco
Jun. 62	Bay Roy	Aug. 63	Hunter	Aug. 62	SEG Sales
87	BC Electronics	June 63	Hy Gain	Feb. 62	Shure
Apr. 63	Best	May 63	Instructograph	Aug. 63	Sideband Engineers
May 63	BF	5	International Crystal	Nov. 62	Signal
Oct. 61	British Radio	June 63	Irving Electronics	Apr. 63	S. J. Electronics
57	Burghardt	95	Jays	July 63	Skylane
May 62	Burk	July 63	J & D Labs	July 63	Slep
33	B & W	83	Jefftronics	87	Space
95	Byron Airpark	Sep. 61	Jennings	June 63	Space Raider
95	Calamar	May 63	Johnson	May 63	Sprague
35	Callbook	Aug. 61	JSH Electronics	June 63	Star
Aug. 63	Candee	Jan. 63	Kar-Tenna	84	Subscriptions
June 63	C & H	37	KTV Towers	July 63	Super-Q
July 63	Charter Oak	June 63	Ladd	25	Swan
7	Clegg	3	Lafayette Radio	June 63	T A B
19	Cleveland Institute	Mar. 62	Lefor	Feb. 63	Technical Manuals
July 63	Collins	Nov. 62	Limachi	39	Technical Materiel
85	Columbia	15	Linear Systems	June 63	Telemarine
May 63	Columbia Products	Mar. 61	L R Electronics	71, 77	Telrex
77	Comaire	Oct. 62	L W Electronics	Apr. 63	Tepabco
Aug. 63	Cornell-Dubilier	July 63	Maps	Jul. 62	Texas Crystal
July 63	Cubex	Apr. 63	Master Mobile	Apr. 62	Texonic
6	Cushcraft	May 63	McCoy	55	Topaz
Jul. 62	Davco	May 61	Mercury	Jan. 63	Transceivers
Apr. 63	Delta	Aug. 62	Mesco	69	Transistors Ult.
73	Denson	89	Meshna	22	Tri-Ex
June 63	Dow Key	May 63	Metrodynamics	June 63	Tri-State
79	Dow Radio	June 63	Miller	Aug. 63	United
41	Drake	July 63	Mini-Products	Feb. 63	US Crystals
Mar. 63	Ebco	Aug. 63	Mission	Cover II	U. T. C.
June 63	Editors & Engineers	July 63	M & M	Apr. 63	Valley
Feb. 63	Ed-U-Cord	Jun. 61	Mobiliers	45, 73, 81, 95	Vanguard
Feb. 62	EICO	Jan. 63	Mor-Gain	Aug. 63	Verns
Mar. 63	Electro-com	21	Mosley	July 63	Versatronics
June 63	Electronic Servicenter	Sep. 62	Multi-Products	Feb. 63	Vesto
May 62	Electrophysics	Cover IV	National	July 63	V & H
45	Epsilon Records	May 63	New Products	Jan. 63	Vibroplex
61	Evans	Aug. 63	Newtronics	Dec. 62	Waber
4	E-Z Way	July 63	North American	17	Waters
79	Fair	95	Northwest	31	Webster
July 63	Fairbrother	Dec. 62	Nortronics	Jul. 62	Wegner
35	Finney	Aug. 63	Ole's	47	Western (Calif.)
83	F-M	Mar. 62	Organs & Electronics	89	Western (Neb.)
Aug. 63	Foreign Projects	May 63	Out-O-Door	47	Wildcat Press
16	Foreign Subs	Dec. 62	Pacific Plantronics	63, Cover III	World Radio Labs
Aug. 62	Fort Wayne	June 63	Palmer	Apr. 62	Zalytron
77	Gain, Inc.	77	Parks	84	73 Subscriptions
Feb. 63	Gam	65	Pausan	90	73 Products
79	Gavin Instruments	Dec. 61	Penwood Numechron	91	73 Parts Kits
47	Gem Electronics	Dec. 61	Peterson	16	6 Up

CALAMAR Electronics Co.

K6HYY

WA6HYU

**COLLINS, HAMMARLUND, MOSLEY,
SWAN, SIDEBAND ENGINEERING,
NATIONAL, GONSET**

2163A FULTON AVE, SACRAMENTO, CAL.

BE A HAM

Afternoon or evening classroom courses in Code and Theory for the General license.

Call GR 8-3245

RON REED ELECTRONICS INSTITUTE
W. Los Angeles 49, Calif.

WALKIE-TALKIE!

6 meter, 150 mw., 4 channel, transistorized transmitter with AM modulator. Complete with transistors and 50.5 mc. crystal. Requires only 12 volts at approx. 35 ma. Ideal for walkie-talkie or get 10 to 15 mile range with a beam.

Only \$14.95 ppd. while they last.

VANGUARD ELECTRONIC LABS Dept. H-9
190-48-99th Ave. Hollis 23, N. Y.

LOOKING? SHOPPING? TRADING? TRYING TO SAVE MONEY?

Write Bob Graham for Special Deals on New and Re-conditioned used gear. Cash or Budget.

Graham Radio

Dept. C., Reading, Mass. Tel: 944-4000.

Reyco Multiband Antenna Coils

Traps for dipoles . . . high strength . . . moisture proof guaranteed to handle a full KW. Model KW-40 coils will, with a 108 foot antenna, provide operation on 10-15-20-40-80. **\$12.50 set.**

For information on other models write:

**FRED L. REYNOLDS W2VS, 492 Ravenswood Ave.,
Rochester 19, New York**

FM FM FM FM FM

FMTRU 30D 150mc \$45.00 FMTRU 41V 30-50mc \$85
FMTR 30D 30-50mc \$45.00 50BR base sta. 30-50mc \$85
FMTRU 80D 150mc \$65-\$100 80Y base sta. 30-50mc \$150
FMTR 80D 30-50mc \$65-\$100 T44A6A 450mc \$100 and up
Also-GE gear \$35 and up. Dumont and Link gear available.

northwest electronics
Box 7, Chesterton, Indiana

NEW conversion of BC-659 to GB. This one includes AVC, Crystal Filter, PL coupling, electronic push to talk, Squelch Bias and more. Conversion kit \$20.60. Plans only, \$2.00. FOB Citrus Heights.

JAY'S CB SERVICE

PO Box 173, Citrus Heights, Calif.

Don't Fool Around With Messy Wire Guys

Polyethylene guy line reduces installation time to a fraction of what it used to be. Eliminates need for insulators, turnbuckles, brackets, etc. Length easily adjustable after installed. This material will outlast your tower. Won't stretch. Available in a variety of bright colors. Write and send 25c for sample. 20% discount on orders over 500 feet.

5/16" 1400 lb. test 5c per foot
3/8" 2000 lb. test 8c per foot
1/2" 3400 lb. test 14c per foot

Check or MO to
Byron Airpark
R. R. 3, Xenia, Ohio

SEALED METAL CRYSTAL 1/2" spacing, 3rd overtone. With fractions. Will ship to closest fraction:

27MC	18MC	40MC	48MC
28MC	23MC	42MC	115MC
15MC	37MC	44MC	134MC
16MC	38MC	45MC	135MC
17MC	39MC	46MC	
200KC	\$1.95 ea.		
13000KC	1.95 "		
		49c each or 3 for \$1.39	

TUBES

707B Klystron 5 for \$1.00; 20 for \$2.95
717 A same as 6SK7 5 for \$1.00; 20 for \$2.95
Sub miniature tube assortment removed from late equipment
6 for \$1.00; 24 for \$2.95

3DP1 3" scope tube. Produces circular pattern
79c ea.; 2 for \$1.49

3EP1 3" scope tube. Similar to 3BP1 but smaller base
97c ea.; 2 for \$1.79

3FP7 3" scope tube 79c ea.; 2 for \$1.49

2C46 \$1.79 ea.

2C42 \$1.49 ea.

APX-6 — complete with tubes and conversion data for 1212 MC
\$14.95 ea.

RM-52 — Phone patch \$1.49 ea.

RM-53 — Phone patch with cord and relay \$2.49 ea.

Telephone dial \$1.25 ea.

ARA-26 Keyer. Can be used to key transmitters \$3.49 ea.

Sextant Baubletype. Has automatic averaging reading with case
used \$8.95

Concertone recording & playback cartridge, used, both for
\$1.49 ea.

Minimum order \$5.00. All orders FOB Los Angeles. 25% deposit on COD orders. All items subject to prior sale.

J. J. GLASS ELECTRONICS CO.

AIRCRAFT • MARINE • INDUSTRIAL • RADAR

1615 SOUTH MAIN STREET

1624 SOUTH MAIN STREET

LOS ANGELES 15, CALIFORNIA

TELEPHONES: RI. 9-1179 - 9-1170

WRETCHED K2PMM

BADGES

One of the big problems at hamfests and club meetings is to have everyone plainly enough marked with their first name and call. All sorts of stickers and pieces of cardboard have been tried, plus little cards which can be typed up and stuck in holders . . . all have the same problem: they are hard to read from any distance.

The best answers to date are these engraved laminated plastic name badges which can be read by Cousin Weakeyes from seventeen paces. You are in luck. We've arranged to make these darbs available at a real low price, all personally engraved. The badges are 3" x 3/4" and come complete with a pin and safety lock. Please give your first name, call and specify whether you want the badge to be bright red with white letters or jet black with white letters.

\$1.00 each.

Order from
73 Peterborough, N. H.

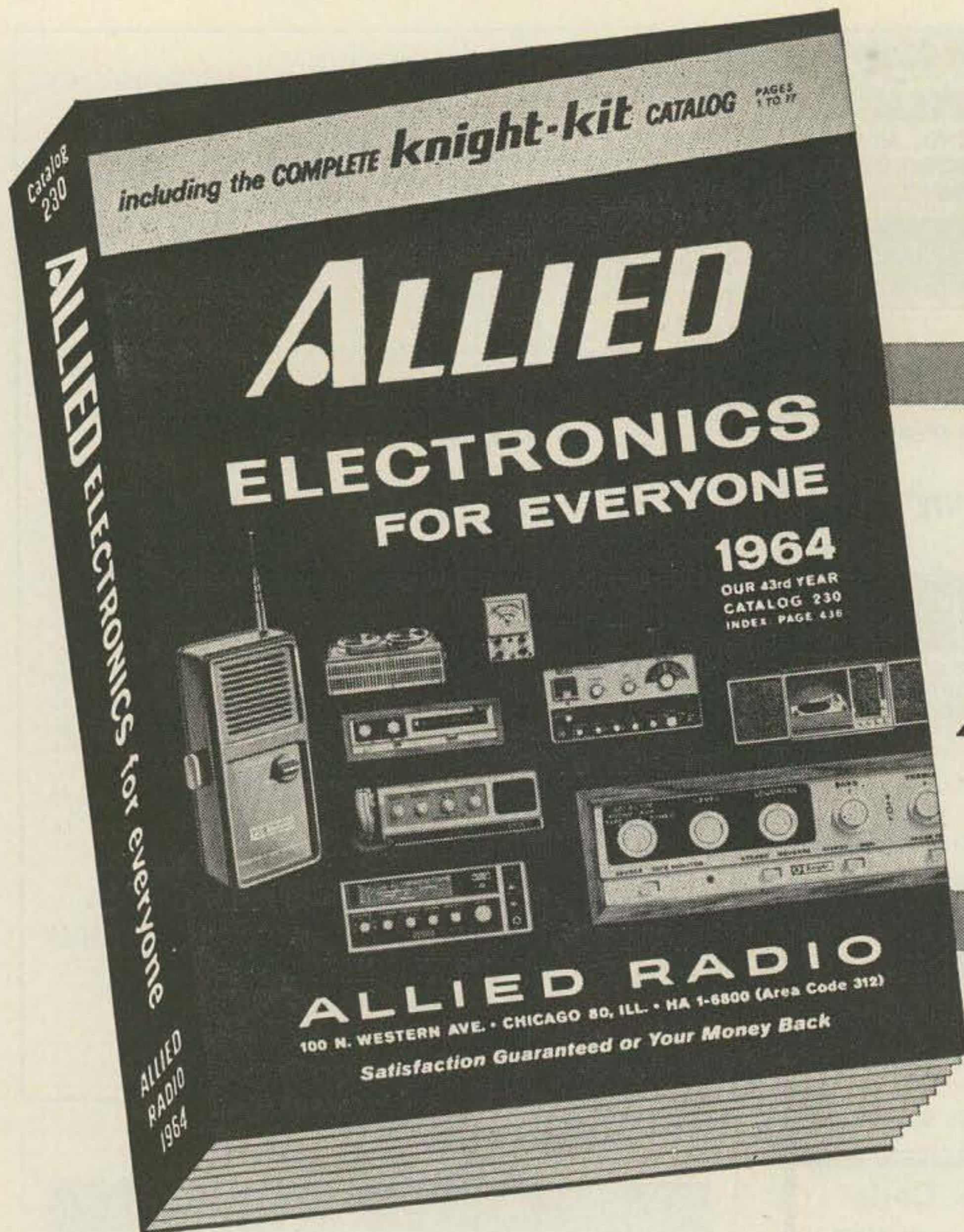

FREE

send today for
your 444-page

ALLIED

1964 CATALOG

world's largest
electronics catalog

BIGGEST SELECTION
BIGGEST SAVINGS

EVERYTHING IN ELECTRONICS FOR THE AMATEUR

*get every ham
buying advantage*

LARGEST SELECTION

ALLIED stocks the station gear you need—at lowest, money-saving prices. Same day shipment from the world's largest stocks.

HAM-TO-HAM HELP

Our staff of more than 60 licensed hams goes all-out to give you the personal help you want. Whether you write, call, or visit our Ham Shack, you'll like the friendly interest and attention you always get at ALLIED.

NO MONEY DOWN

Get Top Buying Power with Your ALLIED Credit Fund Plan—up to 24 months to pay.

ALLIED RADIO

serving the Amateur for 43 years

- Ham Receivers and Transmitters
- World's Largest Stocks of Station Supplies
- New Build-Your-Own Ham Knight-Kits®
- Citizens Band 2-Way Radio
- Electron Tubes and Semiconductors
- Test Instruments and Meters
- Everything in Stereo Hi-Fi
- Tape Recorders and Tape
- Everything in Electronic Parts, Tools & Technical Books

SEND FOR YOUR COPY TODAY

ALLIED RADIO, Dept. 14-J
100 N. Western Ave., Chicago 80, Ill.

Send FREE 1964 ALLIED Catalog

Name _____
PLEASE PRINT

Address _____

City _____ Zone _____ State _____

FREE



TRANSCEIVER HANDICAP

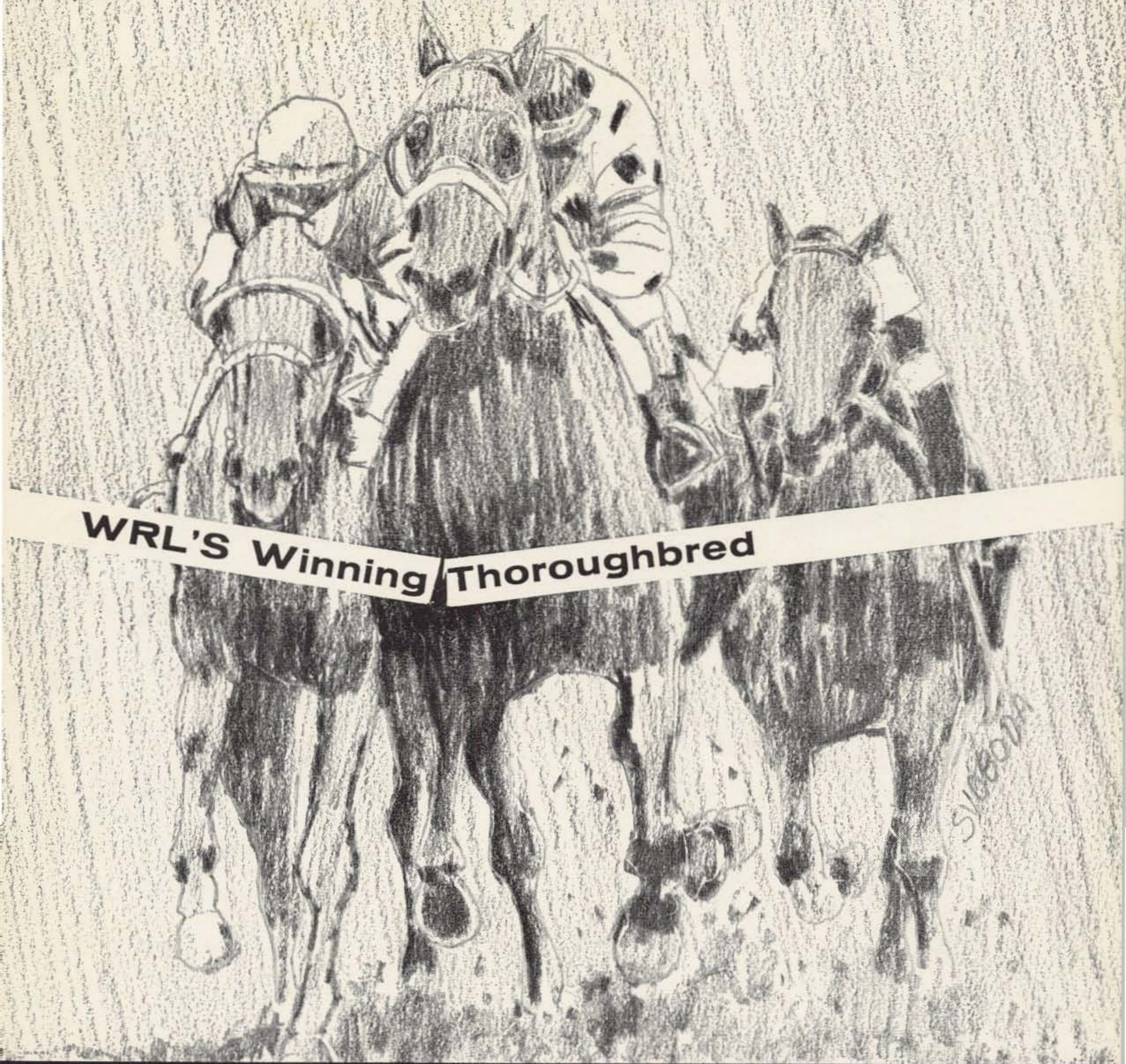

WRL'S Winning Thoroughbred

GALAXY 300 WINS IN THE STRETCH. A tough race all the way — it was neck and neck from the start. But Galaxy, through superior breeding (research and development), workouts (field-home-mobile testing), and the best owner/trainer (World Radio Laboratories), came through in the stretch and is paying off big for hundreds of cheering hams. When you buy the Galaxy 300 (300 watt SSB/AM/CW transceiver, covering 80-40-20-meters) you've got a winner — \$299.95 wired, make it a daily double with deluxe matching power \$99.95. Like a full run-down? Mail the coupon . . . then you'll know why hamdicappers everywhere are choosing the Galaxy 300.



WORLD RADIO LABORATORIES
3415 West Broadway, Council Bluffs, Iowa

SEND ME FREE: RUNDOWN SHEET ON
"GALAXY 300" ALL NEW WRL HAM CATALOG
 QUOTE ME "TRADE-IN" ON ATTACHED LETTER.

NAME _____

ADDRESS _____

CITY _____ ZONE _____ STATE _____

WORLD RADIO LABORATORIES

West Broadway • Council Bluffs, Iowa • Phone: 328-1851

ALL IT TAKES IS 917 PARTS



PLUS

Patience, Workmanship, Integrity, Experience and Know-how

It takes more than parts to produce a rig like National's NCX-3 SSB transceiver . . . It takes vital intangibles not listed on any spec sheet or schematic. **PATIENCE** to design carefully and conservatively . . . **WORKMANSHIP** assuring meticulous attention to the smallest detail of component placement and soldering . . . **INTEGRITY** to avoid fanciful claims, and to ship only fully tested, quality-approved units, backed up by a One-Year Guarantee and a nation-wide network of warranty repair stations . . . **EXPERIENCE** with every phase of the communications equipment business—from the design and manufacture of atomic frequency standards and super-sophisticated military SSB equipment to the least glamorous choke, knob, or drive . . . and just plain **KNOW-HOW**—the know-how you expect after nearly half a century of building ham equipment—know-how to put the features **you** want in a rig like the NCX-3—complete CW coverage of the 80, 40 and 20 meter bands as well as the phone sections . . . break-in keying . . . **built-in VOX** . . . **smooth** SSB/CW AGC and product detector action . . . **built-in S-meter** . . . **built-in AM** detector for compatible AM operation . . . mobile mount at no extra charge . . . In fact, all of the features and performance you want and need for fixed station as well as mobile/portable use.

Whether your choice is the NCX-3 at \$369.00 or any one of National's other equipment products from \$50.00 to \$1000.00, you can be confident that you've also bought the **plus** factors that assure you of continuing enjoyment and long-term reliability.



National Radio Company

A Wholly Owned Subsidiary of National Company, Inc.
37 Washington St., Melrose 76, Mass.
World Wide Export Sales: Ad Auriema Inc., 85 Broad St., N.Y.C.
Canada: Tri-Tel Associates, 81 Sheppard Ave., W. Willowdale, Ontario

two tones might work. There are some fairly sophisticated filters available these days. We are open for articles along this line.

Slow Scan Television

The FCC apparently has finally come through with the slow scan tv permission. We'll have the exact frequency allocations by and by. This rule change has been hanging fire for about seven years now. Opponents to the proposal grumble that the slow scan signals are horribly wide and make a mess in the phone bands. Proponents point out all the things we can do with slow scan. We shall see more of both sides.

We have a couple of slow scan articles in the works here and will publish them as soon as we can. We are interested in more. Andre of Vanguard Labs has an idea that you might like to play around with . . . he is working on a system that will use a regular tv camera and monitor. Then you would record the signal on a drum and slow down the drum for radio transmission. The signals would record on another drum at the other end and this would speed up and the picture could be seen on the monitor. Instead of using a slow phosphor viewing tube you would just repeat the same picture over and over.

At any rate, slow scan is here so let's see what we can do with it. Let's try to cause as little QRM with the signals as we can and see what kind of interesting systems we can work out. It wasn't very many years ago that there were a lot of laughs when I proposed a WAS certificate for RTTY. Now it is time for one for television!

Your Advanced Class License

Our series on the Advanced License Study Course is winding up this fall. If you've followed the series you should have no trouble at all in getting your ticket and keeping most of your allocations. We will continue on with a study guide for the Extra Class and, I suspect, eventually go back and provide you with a course for the General Ticket.

Many of our readers write to tell us that the course is being used with great effectiveness by their clubs, with an hour or so devoted to questions and answers at the beginning of each club meeting based upon the current text. When the series is done we will bring the whole thing out in a separate book which can be kept at hand for future club courses. . . . Wayne

radio amateur callbook



GET YOUR NEW ISSUE NOW!

Over 283,000 QTHs
in the U.S. edition
\$6.95

Over 135,000 QTHs
in the DX edition
\$4.95

See your favorite dealer or order direct (add 25¢ for mailing in U.S., Possessions & Canada. Elsewhere add 50¢).

These valuable EXTRA features included in both editions!

- QSL Managers Around the World!
- Census of Radio Amateurs throughout the world!
- Radio Amateurs' License Class!
- World Prefix Map!
- International Radio Amateur Prefixes
- Radio Amateurs' Prefixes by Countries!
- A.R.R.L. Phonetic Alphabet!
- Where To Buy!
- Great Circle Bearings!
- International Postal Information!
- Plus much more!

**WRITE FOR
FREE
BROCHURE!**

RADIO AMATEUR
callbook INC.
Dept. B, 4844 W. Fullerton Ave.
Chicago, Ill. 60639

Reader comments on the DX Hand- book

"Extraordinarily complete" . . . W3BNW

"The wall map is fabulous" . . . K5MVF

"Absolutely delighted" W1MRS

"I use it every day . . . invaluable" . . .
W9CEL

"Particularly appreciate the 80M info"
. . . W9YBD

"Must reading for every DXer" . . W2API

**Order your copy now. \$3 from 73,
Peterborough, NH 03458**

NOISE BLANKER



Removes interference generated by auto ignitions, appliances, radars, and other sources of high energy pulse noise. Specifically designed for VHF operators requiring maximum noise suppression for reception of weak DX and scatter signals. Connects in the coax between converter and receiver. All solid-state design features silicon

Field Effect Transistors for reliability and best cross-modulation characteristics. Specify converter output frequency. Choice of 12-18, 100-140, 125-170 VDC; phono or BNC connectors. **SWAN 250.** Add noise blanking capability to this popular transceiver with the WESTCOM TNB-250 Noise Blanker. Mounts on rear of cabinet without drilling; easy to install. **Price: \$29.95 postpaid.** Calif. residents add sales tax. All products are warranted for one year and offered on a satisfaction or return basis.

WESTCOM ENGINEERING COMPANY
P.O. Box 1504 San Diego, Cal. 92112

GET IT from GOODHEART!

EVERYTHING UNCONDITIONALLY GUARANTEED

SILIC. RECTIF. 8000 PIV 400 MA. Large user's termin. invent., not rejects! Slater SLA08-2. Max: reverse, 2 uA; fwd drop, 8.2 v. Cost \$8 ea. PAIR Postpaid **\$5.30**

ELDICO SSB Adapter SBA-1 with book, converts any receiver with 455 kc IF to SSB; select either upper or lower side band; also adds CW oscillator if you have none. Many features and a very expensive unit in neat cabinet **\$127.50**

R-23/ARC-5 Command revr 190-550 kc. Shpg. wt. 9# .. 14.95

A.R.C. 12 #22 Command revr 540-1600 kc. 9# 17.95

LM-14 freq. meter, .01% 125 kc-20 mc. 15# 57.50

TS-323/UR freq. meter 20-480 mc. .001% 169.50

BC-221's OK \$57.50 TS-175 OK 125.00

CLOSING OUT Radio Receivers 38-4000 mc at **CRAZY LOW PRICES!** Ask for APR-4Y/CV-253 sheet.

SP-600-JL Revr. 0.54-54 mc. aligned, grtd. 250.00

R-392/URR grtd OK, w/AC sply & book 525.00

WANTED: GOOD LAB TEST EQUIPT & MIL COMMUNIC.

TIME PAY PLAN: Any purchase totaling \$160.00 or more, down payment only **10%**

WE PROBABLY HAVE THE BEST INVENTORY OF GOOD LAB TEST EQUIPMENT IN THE COUNTRY. BUT PLEASE DO NOT ASK FOR CATALOG! ASK FOR SPECIFIC ITEMS OR KINDS OF ITEMS YOU NEED! WE ALSO BUY! WHAT DO YOU HAVE?

R. E. GOODHEART CO. INC.

Box 1220-GC, Beverly Hills, Calif. 90213

Phones: Area 213, office 272-5707, messages 275-5342

**PLEASE INCLUDE YOUR ZIP CODE
WHEN YOU WRITE 73.**

\$\$\$ More Dollars \$\$\$ FOR YOUR EQUIPMENT

We at Bel-Air pay more. Specializing in police and marine monitoring and transmitting equipment. All HF, FM, business units. Also ham gear and tower equipment. Below wholesale prices on many items with new factory warranties.

Terms available

**Write, phone—We pay freight on
all purchases**

The Big One

Bel-Air Electronics

5403 Grand Ave.
Omaha, Nebr. 68104
402 451-6477

WTW Report

Since the last report, conventions and hamfests have caused QRM and we missed the last issue of the magazine. We now have a good system lined up, so my service to all of you will be speedier and more efficient. Remember . . . send all reports directly to me. Don't send anything to 73 Magazine. I have all the certificates here and am sending them directly.

We still need a good club in W/K1, W/K2, and W/KØ, as well as Africa for WTW card check points.

There seems to be some confusion about phone certificates. SSB and AM are both phone, and count toward the award for either mode.

Regarding Don Miller's cards . . . we are only accepting the ones that ARRL accepts toward DXCC, thus no one can say we make our rules as we go along. We accept as a country any spot recognized by any national radio society. If ARRL accepts, we do too. If RSGB accepts it we do too, Send 25¢ to get a copy of the country list/tally sheet. This will relieve any doubts you might have.

There are strong rumors that a number of fellows are getting close to WTW-300 on 20 now. I wonder who will be first to qualify? Check your cards very carefully as we look them over with a critical eye and will disqualify any which show they have been tampered with.

To make the task of anyone checking your cards for the awards easier, I strongly suggest, when possible, to have all QSO information on one side of the card, along with your call sign in fairly large letters. Next time you have QSLs printed, how about keeping this in mind? The business of flipping cards over and over when checking them can become a chore and requires twice the time.

Remember, to qualify for WTW, all contacts must have taken place after May 1, 1966.

The following stations have qualified for WTW since the last listing:

WTW-200, 14 MHz Phone:

Certificate #11, K8YBU

12, PY3BXW

13, W6MEM

WTW-100, 14 MHz Phone:

- 54, K5TGJ
- 55, K4VKW
- 56, SVØWL

WTW-100 21 MHz Phone:

- 13, W6MEM
- 14, K4VKW
- 15, WA1EUV

WTW-100, 21 MHz CW:

- 5, WØRRS

WTW-100, 14 MHz CW:

- 15, K4CEB

21 MHz Phone still has only W4OPM with #1, and 28 MHz both Phone and CW still await someone to pick up #1.

As soon as enough scores are received, I will start a running list of the number of countries various fellows have worked.
... W4BPD

Tell Our Advertisers

You Saw It In 73

USED MODEL 501 TV CAMERAS



MADE
IN U.S.A.

\$160.00 FOB Hollis

Each month we have a limited number of used TV cameras which we make available to hams at greatly reduced prices. These cameras were rented out for temporary surveillance jobs on construction sites, county fairs, conventions, etc. All have been checked out and are guaranteed for 90 days. Complete with vidicon and lens.

**Used Model 501 sale priced
\$160.00 FOB Hollis**

Don't delay. Only a few used cameras are available each month. For specifications send for our illustrated catalog.

VANGUARD LABS

Dept. H, 196-23 Jamaica Ave., Hollis, N.Y. 11423

A NOTICE OF HIGH IMPORT

While we have had to reluctantly inch our subscription rates up just a hair, we have managed a real coup for you, the dedicated reader! We have nailed down, for the time being, our three year subscription rate. Take advantage of this obvious oversight. Sock it to us. Gold is up, silver is up, the pound is down. . . . we warned you. This is a good deal. We shall say no more.

Name Call

Address

City State Zip

New subscription—renewal—extension?—

\$12 THREE YEARS!

One year \$6

HAM RTTY \$3

DX Handbook \$3

VHF Antennas \$3

While you are at it you might as well order some of our nice books listed above. Also it wouldn't hurt to get a \$3 binder or two. *And remember*, 73 now costs a lousy \$26.28 for three years on the newsstand. Appalling.

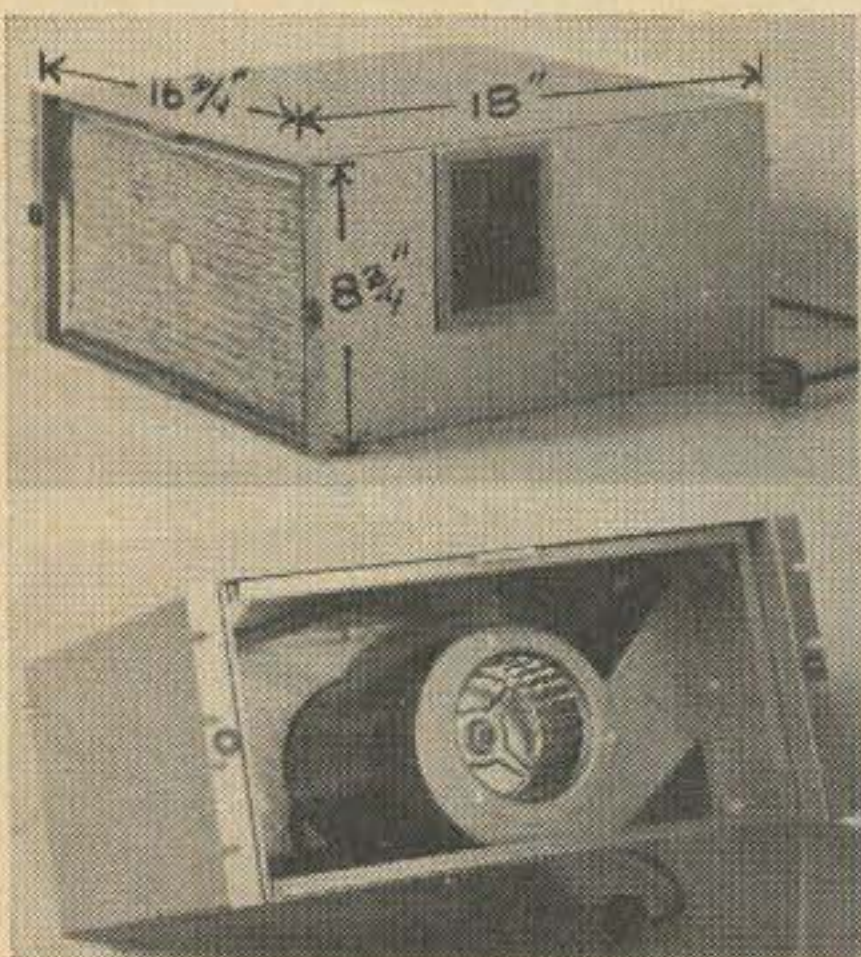

BLOWERS

standard 19" rack cabinet size; 110v 60 cyc General Electric 1/8 HP 3750 RPM motor with 5" squirrel cage blower. Mfg. McLean Engineering Lab. with dust filter, 55 lb. shipping wt. **MOTOR ALONE WORTH MUCH MORE THAN THIS PRICE**

NEW \$17.95

COMPUTER GRADE ELECTROLYTICS

40,000 MFD	10 VDC	5,000 MFD	36 VDC
20,000	25	3,500	75
16,000	12	2,500	80
10,000	15	1,500	100
8,000	55		

(If out of stock we will send next highest value)

CHOICE \$1.35 each 10/\$12.25



INTEGRATED CIRCUITS

UL 914 open gate Fairchild with 30 different projects to use this I.C. in. **NEW** from manufacturer **\$1.00 ea.**

3 DIGIT COUNTERS type used in tape recorders **50c ea., 10/\$4.50**

TELETYPE PAPER ROLLS 8 1/2" wide **75c ea., 12 rolls \$7.50**

TELETYPE PAPER TAPE 11/16" wide **25cca., case of 40/\$7.50**



CRYSTAL OSCILLATOR KITS USING I.C. UL 914

Stable, Harmonic-rich output crystal osc. range 100 KC to 10 MC—Kit includes Fairchild I.C. UL 914, crystal sockets, resistors, capacitor, & **PRINTED CIRCUIT BOARD**, with instructions for assembly **\$2.00 per k.t**

NEW 12V 5 AMP filament transformer with over load fuse. **\$3.00 ea.**

1000 PIV—1 AMP DIODES Tophat or Epoxy **40c ea. 10/\$3.75**

IBM Regulated Transistor Power Supplies—heavily filtered and regulated. Extremely low ripple—with plug-in regulator card—with schematics

12 V Output at 20 amp	40 lbs	\$29.95
12 V Output at 16 amp	35 lbs.	\$24.95
12 V Output at 12 amp	30 lbs.	\$19.95
12 V Output at 4 amp	15 lbs.	\$14.95
12 V Output at 2 amp	10 lbs.	\$ 9.95

(ship. wt.)

Circuit breakers for both AC input and DC output. Voltage variable from 11 to 13 volts with pot. 115 VAC 60 cyc input. Excellent condition.

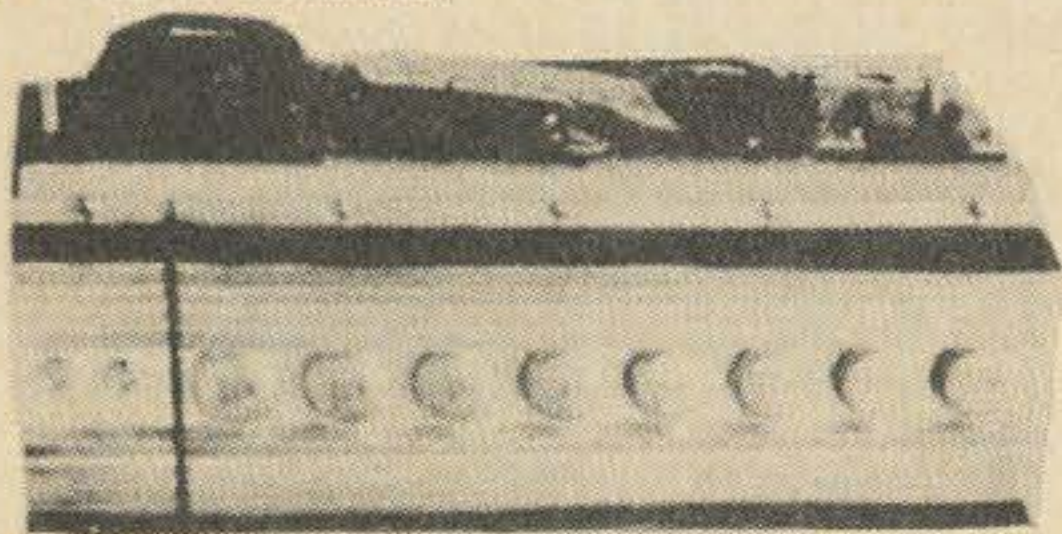

**Visit our 2nd Store Opening Sept. 1st.
247 So. Meridian, Indianapolis, Ind.
638-7213**



R & R ELECTRONICS
1953 S. YELLOWSPRINGS ST.
SPRINGFIELD, OHIO
Dept. 7F

\$2.00 minimum order FOB Springfield, Ohio COD order 25% deposit. Please add sufficient postage, we refund all unused amount. Ohio customers add 4% sales tax.

**SATISFACTION GUARANTEED
ON ALL ITEMS**

CROSSWORD

by

Michael Kresila

Box 57

Marion, Ohio 43302

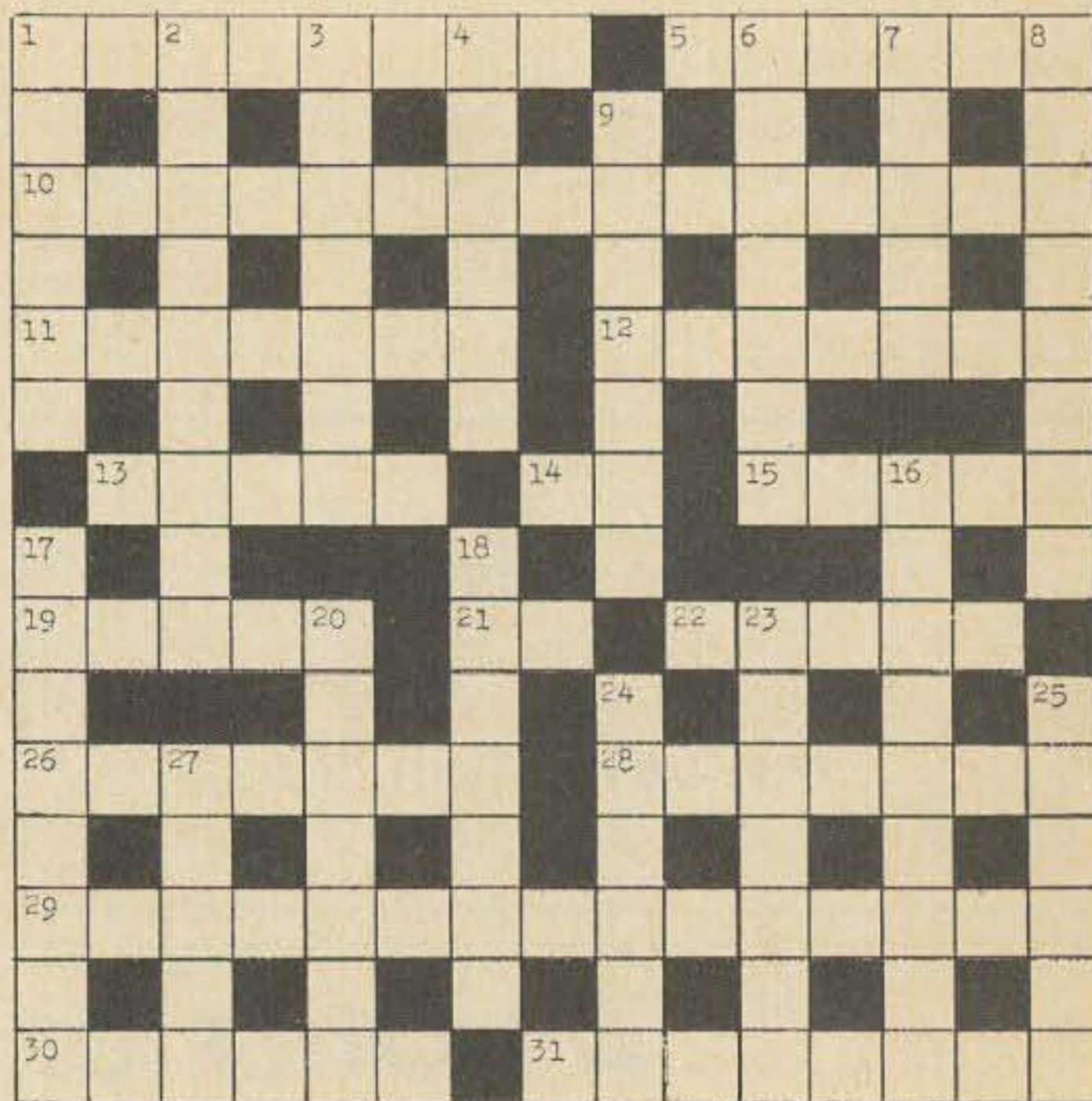

Across

1. An amplifying station used to boost the volume on long telephone lines.
5. Noise heard in a receiver due to atmospheric disturbances.
10. The lack of dilution of a hue by white.
11. Flyback.
12. An electrode used to initiate conduction at the desired points in each cycle.
13. Undesired sound.
14. Aluminum. (Abbr.)
15. To make merry.
19. A series of names, numbers and words.
21. A world-governing body. (Abbr.)
22. The centimeter-gram-second electromagnetic unit of a magnetic induction.
26. Also called piggy-back control.
28. Trade name for a phenolic compound having good insulating qualities.
29. Use of radio signals for course-plotting.
30. To push with sudden force.
31. An electrode whose primary function is to reverse the direction of an electron stream.

SCR-SILICON-CONTROL RECTIFIERS!

PRV	16A	25A	PRV	16A	25A
50	.50	.75	400	1.60	1.90
100	.95	1.20	600	1.95	2.75
200	1.15	1.30	800	2.85	3.60
300	1.40	1.65	1000	3.70	4.50

5U4 Silicon Tube ..\$1.50@, 5 for \$5
 5R4 Silicon Tube\$4@, 3 for \$9
 866A Silicon Tube ..\$10@, 2 for \$18

MICA MTG KIT T036, T03, T010, 4/\$1
 ANODIZED T036 INSULATOR5/\$1
 ZENERS 1 Watt 6 to 200V ..80@, 3/\$2
 ZENERS 10 Watt 6 to 150V \$1@, 6/\$5
 STABISTOR up to Ten Watt, 20 for \$1

Wanted Test Sets (TS) & Equip.

*** TRANSISTORS * SCR'S * ZENERS!!!**
 Full Leads Factory Tested & GTD!
 PNP150 Watt/15 Amp HiPwr T036 Case!
 2N441, 442, 277, 278, DS501 Up To
 50/VCBO\$1@, 7 for \$5
 2N278, 443, 174. Up to 80V \$2@, 4 for \$5
 PNP150 W/2N1980, 1970 &
 2N2075, 2079\$2@, 3/\$5
 PNP 30 Watt/3A, 2N115, 156, 235, 242
 254, 255, 256, 257, 301 40e@3 for \$1
 PNP 2N670/300MW 35e@5 for \$1
 PNP 2N671/1 Watt 50e@4 for \$1
 PNP 25W/TO 2N538, 539, 540 ..2 for \$1
 2N1038 6/\$1, 2N10394 for \$1
 PNP/TO5 Signal 350MW 25e@, 5 for \$1
 NPN/TO5 Signal IF, RF, OSC 5 for \$1
 Finned Heat Sink 180 SQ", \$1@, 3/\$2
 Finned Sink Equip. 500 SQ", \$3@, 2/\$5
SILICON PNP/TO5 & TO18 PKG
 2N327A, 332 to 8, 474 to 9, 541 to 3,
 935 to 7 & 1276 to 9, 35e@4/\$1

866 C.T./2.5V/10A FILAMENT
 XFMR 10 Ky Insitd \$2@,3/\$5

Bandwidth Ceramic 500W 2P/6Pos, \$2@
 5Hy-400Ma Choke \$4@2/\$5
 250Mfd @ 450 Wv Lectlytic \$3@, 5/\$10

Send 25c for New Catalog

"TAB"

"That's A Buy"

"TAB" * SILICON ONE AMP DIODES

Factory Tested & Guaranteed

Piv/Rms	Piv/Rms	Piv/Rms	Piv/Rms
50/35	100/70	200/140	300/210
.05	.07	.10	.12
400/280	600/420	800/560	900/630
.14	.21	.30	.40
1000/700	1100/770	1700/1200	2400/168
.50	.70	1.20	2.00

*All Tests AC & DC & Fwd & Load!
 1700 Piv/1200 Rms @ 750 Ma. 10 for \$10
 2400 Piv/1680 Rms @ 750 Ma. 6 for \$11

Silicon Power Diodes, Studs & P.F. **

D. C.	50Piv	100Piv	200Piv	300Piv
Amps	35Rms	70Rms	140Rms	210Rms
** 12	.25	.50	.75	.90
** 18	.20	.30	.75	1.00
45	.80	1.20	1.40	1.90
160	1.85	2.90	3.50	4.60
240	3.75	4.75	7.75	10.45
D. C.	400Piv	600Piv	700Piv	900Piv
Amps	280Rms	420Rms	490Rms	630Rms
12	1.20	1.50	1.75	2.50
** 18	1.50	Query	Query	Query
45	2.25	2.70	3.15	4.00
160	5.75	7.50	Query	Query
240	14.40	19.80	23.40	Query

We Buy, Sell & Trade As Well!

"TAB"

TERMS: Money Back
 Guarantee! Our 24th
 Year. \$5 Min. Order
 F.O.B. N. Y. C. Add
 Shipping Charges.

56 DX PEARL ST., BKLYN, 11201 N.Y.

PHONE 212-522-7300

Send 25c For Catalog

DC 3 1/2" Meter/RD/800Ma \$3@, 2/\$5
 Socket Ceramic 866 Tube5/\$1
 Socket Ceramic 4X150/Loktal4/\$1
 W.E. Polar Relay#255A \$4@, ...3/\$10
 Toroids 88Mhy New Pckg 75e@,4/\$2
 200 KC Freq Std Xtals4/\$2
 2 Side/cu Printed Ckt Bd New 9x12" \$1
 Finished Piezo Xtals Blanks50/\$1
 Line Filter 4.5A@115VAC 6 for \$1
 Line Filter 5A@125VAC 3 for \$1
 Choke 4Hy/0.5A/27Ω \$3@4/\$10
 H'sid Stevens Precision Choppers ... \$1
 PL259A & SO239 CO-AX M&F Pairs 3/\$2
 Phone Patch Xfms Asstd 4 for \$1
 FT243 Xtal & Holder, surplus .. 5 for \$1
 Insitd Binding Posts "EBY" 25/\$1
 Sun-Cells Selenium Asstd 10/\$1
 Band Pass Filters 60, 90, 150 cys. .3/\$3
 2.5MH Piwound 500MA Choke3/\$1
 Beam Indicator Selsyns 24VAC2/\$5
 Fuse 250MA/3AG50/\$1, 300/\$2
 Oil Cndsr Strobe, Photoflash 25MFD
 2000V G.E./Pyranol, \$7@2/\$10
 Resistor Bleeder 50K/100W3 for \$1

Send 25c for Catalog

Discaps .001@1000WVDC 10e@ ..20/\$1
 Discaps, 2x .004@1000WVDC 15e@, 10/\$1
 Discaps .03@1000WVDC 15e@10/\$1
 Discaps .01 @2000WVDC 18e@6/\$1
 Discaps .001 @5KVWDC 20e@6/\$1
 Discaps .005@5KVWVDC 25e@5/\$1
 Discaps 130mmG/6KV 20e6/\$1
 .02@50WVDC25 for \$1
 6 or 12VAC Minifan & Blade\$1

X-Formers All 115V-60Cy Primary—

2500V@1Cma & Fil \$2@4/\$5
 1100VCT@ 300Ma, 6v@ 8A, 5V @ 3A &
 125V Bias, abt 1200 VDC \$4@ ...3/\$12
 480 Vet@ 40Ma & 6.3@ 1.5A CSD \$1.50
 10 Vet@ 5A & 7.5 Vet @ 5A\$5
 6.3 Vet 15.5A & 6.3 Vet @ 2A\$4
 7.5 Vet@ 12A \$3@ 2/\$5

Down

- To preserve for later reproduction.
- A high-vacuum thermionic tube used to control the magnitude of current flow. (PI.)
- Also called antennas.
- An ionized layer in the atmosphere, about 55 to 85 miles above the earth's surface.
- Representation of an operating system by computers and its associated equipment and personnel.
- The rotation of a cross-section of a waveguide about the longitudinal axis.
- The parts of a digital computer which carry out instructions in proper sequence.
- Capable of being heard.
- The transmitted portion of the suppressed sideband.
- A dielectric that retains a charge after the charging field is removed.
- A metallic alloy having special magnetic properties.
- Fixed set of plates in a variable capacitor.
- Slang expression for radio broadcasting.
- A position of authority or trust.
- A refinement added to an impedance bridge to avoid the effects of capacitance to ground.
- A device, also known as acoustic radar.

Solution Pg. 106

\$100,000 IN PRIZES



\$45 OPERATING DESK

FREE WITH 10 SUBSCRIPTIONS

Walnut Pervaneer finish 18" x 40" x 29" high with 4 drawers, great for transceivers. Easy to assemble. FOB Mo. 48 lbs. Send 10 new \$6 subscriptions. USA only.

73, PETERBOROUGH, NH 03458

**MORE RANGE . . .
with NO NOISE**

**FOR ALL
MOBILE UNITS**



**CUSTOM SYSTEMS
KITS • ACCESSORIES**

**ELIMINATE IGNITION NOISE
ELECTRO-SHIELD®
YOUR ENGINE**

FROM \$44.95

ESTES ENGINEERING CO.

543 W. 184th St., Gardena, Calif. 90247



Solution To Puzzle on Pg. 118

1	R	E	P	E	A	T	E	R	S	T	A	T	I	G		
	E	L	E	L	A	R	W	O								
10	C	O	L	O	R	S	A	T	U	R	A	T	I	O	N	
	O	O	I	Y	D	I	S	T								
11	R	E	T	R	A	C	E	I	G	N	I	T	O	R		
	D	R	L	R	E											
	13	N	O	I	S	E	14	A	L	15	R	E	V	E	L	
17	E	N					18	M	E							
19	L	I	S	T	20	S	21	U	N	22	G	A	U	S	S	
	E									24	O	I	T	25	W	
26	C	A	27	S	C	A	D	E	28	F	O	R	M	I	C	A
	T	O														
29	R	A	D	I	O	N	A	V	I	G	A	T	I	O	N	
	E	A	R	L	C	V	A	K								
30	T	H	R	U	S	T	31	R	E	P	E	L	L	E	R	

YOUR CALL

Please check your address label and make sure that it is correct. In cases where no call letters has been furnished we have had to make one up. If you find that your label has an EE3* & * on it that means we don't know your call and would appreciate having it.



Interested in what European hams are accomplishing at the higher frequencies?

Read UKW - BERICHTE, the authoritative German quarterly, now with English summaries! Applications of the latest VHF and UHF techniques; equipment and antenna construction details. Each sixty-page issue packed with practical articles written by the most outstanding amateurs in Europe.

Annual subscription U.S.A. \$3.00, Canada \$3.25
H. Ingwersen, PA6AFN Box 87, Topsfield, Mass. 01983

CQ de W2KUW
All tubes bought
Electronic items wanted
Topping all offers

TED DAMES CO.
308 Hickory St., Arlington, N.J. 07032

**Tell Our Advertisers
You Saw It In 73**

\$100,000 IN PRIZES



**\$160 ENCYCLOPEDIA
FREE WITH 20 SUBSCRIPTIONS**

New American Encyclopedia in 16 volumes, over 6000 pages, over 1100 full color pictures! Completely up to date, latest edition. FOB. If you have children you should have an encyclopedia. Just send us 20 new \$6 subscriptions to 73. USA.

73, PETERBOROUGH, NH 03458

Propagation Chart

September 1968

ISSUED JUNE 1

J. H. Nelson

EASTERN UNITED STATES TO:

GMT -	00	02	04	06	08	10	12	14	16	18	20	22
ALASKA	14A	14	14	7	7	7	7	14B	14	14	14	14
ARGENTINA	21	14A	14	14	7A	14	21A	21A	21A	21A	21A	21
AUSTRALIA	21	14	14	7A	7A	7	7B	14	14	14	21	21A
CANAL ZONE	21	14	14	14	7A	7	14A	21	21	21A	21A	21A
ENGLAND	7A	7	7	7	7	14	21A	21	21	21	14A	14
HAWAII	21	14	14	7A	7	7	7A	7B	14A	21	21	14A
INDIA	14B	7B	7B	7B	7B	14	14	14A	14A	14A	14	14B
JAPAN	14	14	7B	7B	7B	7B	7	14B	14B	7B	14	14A
MEXICO	21	14	14	7A	7A	7	14	21	21	21	21A	21A
PHILIPPINES	14	14	7B	7B	7B	7B	14B	14	14	14	14	14
PUERTO RICO	14	7A	7A	7	7	7	14	21	21	21	21	21
SOUTH AFRICA	14	14	7B	14	14	14A	21A	21A	21A	21A	21A	21
U. S. S. R.	7	7	7	7	7	14	14A	14A	14A	14	14	7B
WEST COAST	21	14A	14	7A	7	7	7A	14A	21	21	21A	21A

CENTRAL UNITED STATES TO:

ALASKA	14A	14	14	7	7	7	7	7	14	14	14	14A
ARGENTINA	21	14A	14	14	14	7	21	21	21A	21A	21A	21
AUSTRALIA	21A	21	14	14	14	7A	7B	14	14	14	21	21A
CANAL ZONE	21A	14A	14	14	14	7A	14	21A	21A	21A	21A	21A
ENGLAND	7A	7	7	7	7	7	14	21A	14A	21	14A	14
HAWAII	21A	21	14	14	7A	7	7	7B	14A	21	21A	14A
INDIA	14	14	14	7B	7B	7B	7B	14	14	14A	14	14B
JAPAN	14A	14	14	7B	7B	7B	7	7	14B	7B	14	14A
MEXICO	14A	14	7	7	7	7	7	14	14A	14A	21	21
PHILIPPINES	14A	14	14	7B	7B	7B	7B	7A	14	14	14	14
PUERTO RICO	21	14	14	7A	7A	7	14	21	21	21	21	21A
SOUTH AFRICA	14	14	7B	7B	7B	7B	14A	21	21A	21A	21	21
U. S. S. R.	7B	7	7	7	7B	7B	14	14	14A	14	14	7B

WESTERN UNITED STATES TO:

ALASKA	14	14	14	7	7	7	7	7	7	14	14	14
ARGENTINA	21	21	14	14	14	14	14	21	21A	21A	21A	21
AUSTRALIA	21A	21A	21	14	14	14	14	14	14	14	21	21A
CANAL ZONE	21A	21	14	14	14	7A	14	21	21A	21A	21A	21A
ENGLAND	7A	7	7	7	7	7	7B	14	14	14A	14A	14
HAWAII	21A	21A	21	14A	14	14	14	7	14A	21	21A	21A
INDIA	14	14A	14	7B	7B	7B	7B	7B	14B	14B	14	14B
JAPAN	21	21	14	14	7	7	7	7	14	14	14	14A
MEXICO	21	14A	14	7	7	7	7	14	21	21	21A	21A
PHILIPPINES	21	21	14	14	7	7	7	7	14	14	14	14A
PUERTO RICO	21A	14	14	14	7A	7	14	21	21A	21A	21A	21A
SOUTH AFRICA	14	14	7B	7B	7B	7B	14	14A	21	21	21	21
U. S. S. R.	7B	7B	7	7	7B	7B	7B	14	14	14	14	7B
EAST COAST	21	14A	14	7A	7	7	7A	14A	21	21	21A	21A

A. Next higher frequency may be useful at this hour.

B. Very difficult circuit at this hour.

Good: 1, 2, 8-13, 16, 17, 19-27

Fair: 3, 4, 6, 7, 14, 18, 28-31

Poor: 5, 14

Note: VHF forecasts have been discontinued due to lack of reliable information.

DUAL GATE MOSFET PRE-AMPS



to 175 Mhz. \$19.95 ppd.
to 300 Mhz. \$23.95 ppd.
to 400 Mhz. \$27.95 ppd.
to 450 Mhz. \$31.95 ppd.

- Available from 5 MHz. to 450 MHz. Bandwidth is approximately 5% of frequency.
- Two Dual Gate MOSFET amplifier stages with each having a tuned input and tuned output. Each Dual Gate MOSFET is actually an integrated cascode circuit thus giving you 2 cascode circuits equivalent to 4 triodes.
- Exceptionally low noise (2.5 DB at 175MHz.), greatly reduced cross modulation and 10 times the dynamic range (signal handling capability) of the best bi-polar transistors. Also superior to preamps using junction FETs and Single Gate MOSFETs.
- Internal connections for high impedance AGC or manual gain control if needed.
- Type BNC input and output receptacles for minimum loss at UHF. Standard impedance is 50-75 ohms.
- Carefully tuned at our laboratory with sweep generator and oscilloscope for the best bandpass characteristic.
- Full wave UHF diodes protect input transistor.
- Operates on 6 to 16 volts DC, 5 to 15 Ma.

VANGUARD LABS

Dept. H

196-23 Jamaica Ave., Hollis, NY 11423

Wouldn't
your ad
Look good
here?

LOOKING FOR THE WEAK ONES?

The TEKRAD Mark V antenna has an enormous capture area compared to quads and yagi antennas . . . really pulls in the weak ones, and you work what you hear!

Missing DX off the side of the beam? The Mark V is omnidirectional so you know where the band is open at any time.

Windstorms worry you? The Mark V is impervious to wind and will stay up while the quad is going through the neighbor's roof.

Like to work all bands? Sure you do, and the Mark V will instantly put you on any band from 80M to 10M, horizontally polarized, with high efficiency and low VSWR. Make your transceiver act like a 2KWPEP rig, loudest on the band.

The Mark V antenna comes to you complete, ready to use, cut to length with 70 feet of feedline for only \$32.50 postpaid. All you have to furnish is a mast or tower about 50-60' tall.

Order today while the bands are hot.

W4JM/Ray W4SIW/Bill

TEKRAD, INC
P.O. BOX 57 VALPARAISO, FLORIDA 32580

DXERS and DXERS-TO-BE

Want to keep up to the minute of what's happening DXwise? Subscribe to Gus Browning W4BPD's new weekly DXERS MAGAZINE. 24 pages of DX events, coming up DXpeditions, QSL info, pix, etc. Rates, US surface \$11.00. US air mail \$12.90, West Indies \$18.50, S. America and Europe \$23.00, rest of world \$30.00.

New rates due to postal increase

The DXERS MAGAZINE
c/o W4 BPD

Route 1, Box 161-A,
Cordova, S.C., U.S.A.

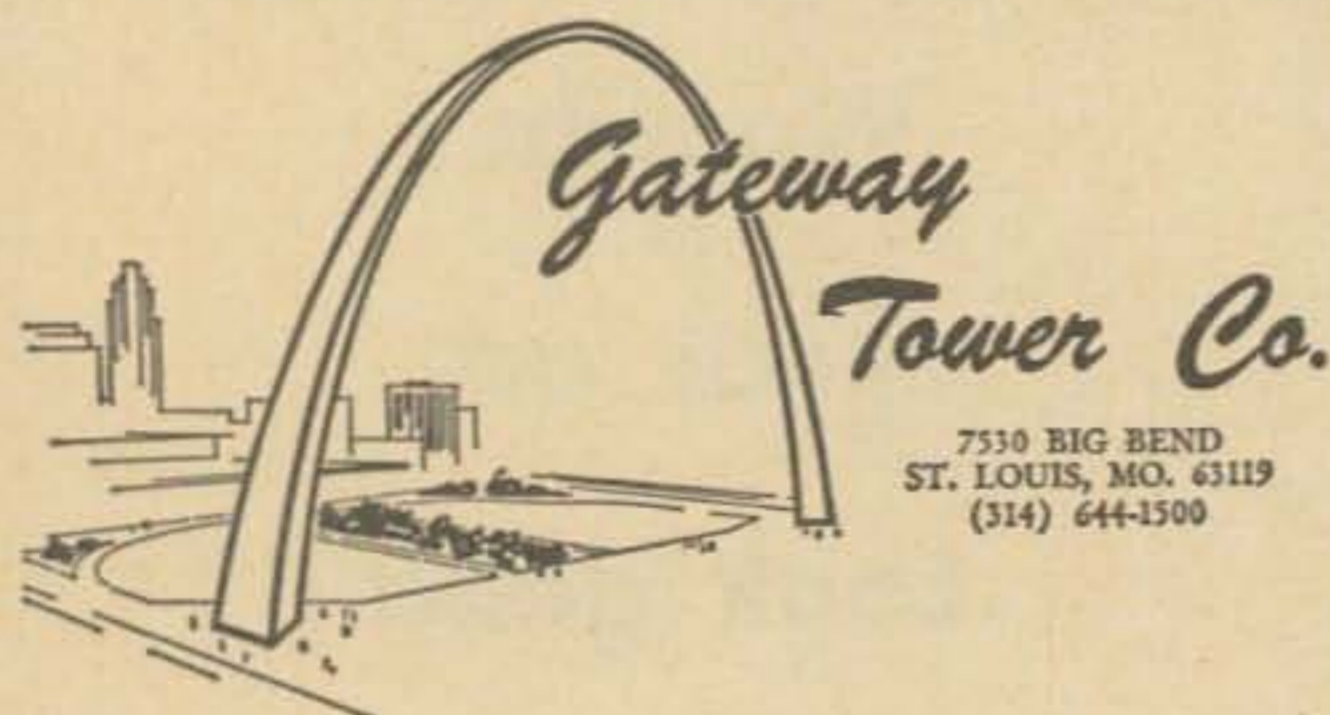

ALUMINUM TOWERS

Send postcard for Literature

Dear 73,

After reading some tower construction articles in the July issue of 73, I had a horrible thought; does the average ham realize what the common termite might do to a wooden tower, if given the chance?

Anyone constructing a wooden tower should take all precautions to prevent damage by termites or other pests or decay. Consult your local lumber or hardware dealer for the necessary materials to treat the wood and nearby ground to prevent any such damage.

George S. Stevens WB2ZFA
Mays Landing, N.J.

Dear 73,

I want to take this opportunity to comment on the incentive license study sections in your magazine. I think they are the best. Really, I'm learning more by your type of presentation than I ever could out of the Handbook. I believe that basically the Handbook is designed for a person who has a basic knowledge of electricity and a little experience of the same. Coming in cold with absolutely no knowledge, the Handbook is very confusing to me. Most of the other hams in the club here think the same. In other words, fine business.

G. Gerald Burger WAØKUA
Secy. Huron Amateur Radio Club

Dear Kayla,

Decidedly like what you are doing. The humor is splendid and your Advance Class course is excellent. Keep laughing and the temptation to wring your hands is not so great. 88 to you too.

Jim Kaufman WAØRD
Boulder, Colorado 80302

Dear Kayla,

The big "40 meter push" which you presented in 73 depicts the beginnings of an excellent campaign. I'm all for, and would like to see 73 Magazine present and lead a year long marathon designed to eliminate the interference caused by commercial stations on 40 meters. If 73 would follow through with such an "elimination marathon", I promise to urge most of the hams with whom I come in contact to support the campaign.

Possibly 73 can print up some pre-written complaint letters to be signed and mailed by US hams to Radio Moscow, VOA, BBC, etc. I bet we can lick the interference problem in one year with cooperation. How about it 73?

Marty Hartstein WB6NWW
Long Beach, Calif.

OK, fellows, what say? I'll print up some form letters to be used as petitions. Let's give it a try. It can only cost postage and the work in getting signatures. Any other ideas from readers as to how to better make use of 40 will be appreciated and put to use.

Dear Wayne, Kayla, and Lin,

After a one year trial subscription I decided that 73 was great. I must say your editorials are right on the beam, so to speak. They are my thoughts entirely on almost every subject.

Keep up the good work and put in more humorous articles like Dilemma in Surplus (June '68). Keep putting in lots of ads, I read them word for word. And . . . best of all, put in more pictures with the articles, especially ones about decibels! HI HI.

Brent Christensen WAØSTS

Dear 73,

Thought that I would let you know that as lousy as the mail service is over here, I finally received my February issue of your most welcome bit of ham news from the States. My subscription was mailed to you in November at the same time that I mailed subs to the other two. I am getting 73 quite regularly even though late. I must say that I am a bit disappointed with the other two magazines as I have yet to receive my first copy. As you well know, there is no operation here and our only contact with the ham world in the states is through your magazines for which we are very appreciative. There are five hams in our group and by the time the magazine gets around, it is well dog-eared and equally as well read and appreciated. Keep up the good work. Just thought I would toss the roses where they are justly due. We do make good use of it and it does get passed around and then filed in the operating room.

Herb Wright WB6IHE
Saigon, So. Vietnam

Dear 73,

With great interest I read W2NSD's editorial on UFO's. I have been interested for several years in this subject. My views parallel those of the editorial and I hope in the near future I can assist in this proposed program. I do not know if there are any amateurs on this side of the pond that are interested but will do my best to find out. I think it would be of great value to have an arm of the network in Europe. I will keep my ears on 14250 and in the meantime try to scare up some interested parties on this end.

Richard J. Malby
APO New York 09176

Dear 73,

All US hams and relations visiting Spain are all times welcomed at the home of very old OM, V. S. Alexandersen, well known in the Amateur World between 1927-1936 as ET2X, ET3CS and ES3CX. I'm not active anymore, but I'm still a ham. Address Camino Son Toells 37, St. Augustin, Palma De Mallorca, Baleares, Spain.

V. S. Alexandersen

Dear 73,

Please pass along the word that I still have a bulk (300+) of National Zip Code Directory flyers to pass out free to anyone sending a request.

Earle and Marilyn McIvor
Box 8151, Rochester, N.Y. 14617

DIODE CIRCUITS HANDBOOK

An invaluable reference book. Covers rectifiers, meter circuits, mixers, detectors, modulators, products, FM detectors, noise limiters, squelch, AGC, BFO/Q-multiplier, xstr protection, AFC, Varicap tuning, audio clippers, FM modulator, balanced mods, Varactor multipliers, field-strength meters, wavemeters, RF probes, dummy loads, SWR bridge, tachometer, noise generator, square-wave gen, zeners, control circuits, voltage control, etc. 111 different circuits.



An absolute steal at \$1.
73 MAGAZINE
Peterborough, N.H. 03458

TOROID CORES

Red "E" Cores-500 kHz
to 30 MHz- $\mu = 10$

#	OD	ID	H	EACH
T-200-2	2.00"	1.25"	.55"	\$3.00
T-94-2	.94	.56	.31	.75
T-80-2	.80	.50	.25	.60
T-68-2	.68	.37	.19	.50
T-50-2	.50	.30	.19	.45
T-37-2	.37	.21	.12	.40
T-25-2	.25	.12	.09	.30
T-12-2	.125	.06	.05	.25

Yellow "SF" Cores-10 MHz
to 90 MHz- $\mu = 8$

T-94-6	.94	.56	.31	.95
T-80-6	.80	.50	.25	.80
T-68-6	.68	.37	.19	.65
T-50-6	.50	.30	.19	.50
T-25-6	.25	.12	.09	.35
T-12-6	.125	.06	.05	.25

Black "W" Cores-30 MHz
to 200 MHz- $\mu = 7$

T-50-10	.50	.30	.19	.60
T-37-10	.37	.21	.12	.45
T-25-10	.25	.12	.09	.40
T-12-10	.125	.06	.05	.25

FERRITE BEADS: .125" x .125", $\mu = 900$. With Spec Sheet & Application Notes Pkg of 12, \$2.00

KILOWATT TOROID BALUN KIT: Still only \$5.00

EXPERIMENTER'S 2 CORE TOROID KIT—This famous kit contains cores, wire, and charts so that you can make your own high Q modern inductors for hundreds of practical applications.: \$1.50

MINIMUM ORDER: \$1.00

Please Add 25¢ per order
for Packing & Shipping

AMIDON ASSOCIATES

12033 Otsego Street
North Hollywood, Calif. 91607

"ARCTURUS" SALE

- Tube cartons 6AU6 etc. size, \$2.15 per 100. 6SN7 etc. size, \$2.55 per 100. 5U4GB size, \$2.95 per 100. 5U4G size, .03c each.
 - 7" 90° TV bench test picture tube with adapter. No ion trap needed. Cat. #7BP7, \$7.99.
 - Silicon rectifier, octal-based replacement for 5U4, 5Y3, 5AS4, 5AW4, 5T4, 5V4, 5Z4. With diagram. Cat. # Rect 1, 99c each.
 - 5 transistor circuit boards containing up to 6 transistors, plus diodes, resistors, capacitors, etc. Cat. # TB10, 99c.
 - Kit of 30 tested germanium diodes. Cat. #100, 99c.
 - RCA-110° flyback transformer, latest type, includes schematic diagram, applicable to any TV. Cat. # BR-1, \$2.99.
 - Color yokes. 70° for all round color CRT's. Cat. # XRC70, \$12.95. 90° for all rectangular 19 to 25" color CRT's. Cat. # XRC90, \$12.95.
 - Transistorized U.H.F. tuners used in 1965 to 1967 TV sets made by Admiral, RCA, Motorola, etc. Removable gearing may vary from one make to another. Need only 12 volts d.c. to function. No filament voltage needed. Easy replacement units. Cat. # U.H.F.567, \$4.95.
 - U.H.F. Tuner—original units as used in TV sets such as RCA, Admiral, etc. covering channels 14 through 82, as part of #94D173-2. Complete with tube. Drive gearing is removable. Can be used in most sets. Cat. # U.H.F. 3, \$4.95.
 - F.M. tuner—Hi/Fi amplifier tuning unit. Tunes from 88 to 108 mc. Contains two 10.7 Mc. I.F. transformers, one 10.7 sound discriminator, R.F. oscillator and mixer stages and 12DT8 tube. I.F.'s are standard "K" type. Circuit diagram for building F.M. radio included. Also plan for building F.M. tuner. Sam's photofact #620 shows 2 applications, 1 for radio, 1 for Hi-Fidelity tuner and amplifier. Cat. #FM-20, \$4.95.
- Send for our free catalog listing thousands of similar best buys in tubes, parts, kits, transistors, rectifiers, etc. Orders under \$5.00, add 50c handling charge. Include 4% of dollar value of order for postage. Canadian postage \$1.00 extra.

ARCTURUS ELECTRONICS CORP.

502-22nd St., Union City, N.J. 07087 Dept. 73
Phone: 201-UN 4-5568

GATEWAY ELECTRONICS

6150 Delmar Blvd., St. Louis, Mo. 63112

- 12 Volt Transistor Power Supply for
GE 25 Watt Progress Line Radio \$24.00
- GE 4 Fre. Oscillator Deck for GE
Progress Line 150mc units. Pro-
vides osc. sig. for xmtr and re-
ceiver\$14.50
- 40-0-40 micro-amps Zero Center
Meter\$ 2.95
- 12 Volt DC -117V AC Inverter
Parts Kit 200 Watt with diagram
and instructions, less case\$14.95
- Jennings Vac. Var. Cap. (UCS-300)
with motor drive 10-300 Pf\$35.00
- Telephone op. headset (Western
Electric)\$ 8.50

Minimum order \$5.00. Sorry, no catalog
at this time. Write for specific items.
Watch for our future ads in 73. Stop in
and see us when you're in St. Louis.



U. S. CRYSTALS

Surplus Crystals — Amateur

FT243, DC34, CRIA/AR, FT241,
HC6/U and other misc. crystals

Write for Free Catalog
U. S. CRYSTALS

Los Angeles, Calif.
P O. Box 78397

- Reflectometer SWR Bridge w/Meter, 30-1000mc. ...EX 8.50
- BC733F 108-110mc Converts to Satellite Recvr.EX 8.75
- TS1019/APM72A 9 Meters 3UP1-CRT Tests APG30 EX 37.50
- T465/ALT7 200W Xmtr 168-352mc w/2 6161's ..EX 19.50
- T465 Schematic pp. 1.00.....Complete Manual pp. 6.50
- TCS12 Xmtr/Recvr Control Box with SpeakerEX 6.75
- R443/ARN5D 330mc Recvr 11 Tubes 3 Cavities ...EX 4.75
- Jones No. 574.23 Micromatch Doubler CouplerEX 12.50
- C3186/APS38B Control Box with MeterEX 4.50
- C18 A.R.C. Type 12 Equipment Control BoxNEW 1.50
- C1457 Control Box for R550/ARR40 ReceiverLN 1.75
- C760B/A Control Box for ARN14B&C ReceiversLN 4.50
- C45 Control Box for ARCL, 4 & 12 EquipmentEX 1.35
- 6161 Tube w/Connectors, 100 Watts to 1200mc.EX 6.75
- R101A/ARN6 100-1750ke Receiver, Four Bands ...EX 27.50
- ID91B/ARN6 4" Navigators Bearing Indicator ...EX 7.50
- AS313B/ARN6 Station Seeking Loop, 100-1750ke. ...EX 6.25
- RT316/APN12 160-234mc Transceiver w/Tubes ...EX 12.50
- ID169C/APN12 3JPI CRT Scope, Coax Switch ..NEW 12.50
- AM300 Interfone Amp w/4 Tubes and Dynamotor ..EX 3.25
- PP336 Main Power Supply for APR9 ReceiverEX 16.50
- PP337/APR9 Klystron Supply for TN130, TN131 ..EX 10.50
- ID226 Panoramic Indicator for APR9 ReceiverEX 14.50
- R316A/ARR26 14-Tube 162-174mc AM/FM Recvr. LN 22.75
- PP468 Power Supply for R316A Receivers 400cy. ..LN 4.75
- C610 Control Box w/4 Tubes for R316A Recvrs. ...EX 4.50
- Scope Xformer 1950V@3ma 5 F11 Windings 60cy. ..UN 4.75
- SA325/U Coaxial Switch SP4T 38VDC MotorEX 6.50
- Adaptor Cable PL259 to BNC Panel SocketLN 3/1.75
- OHMITE Z-50 Radio Frequency ChokeEX 6/1.00
- Rt. Angle Drive w. Gears, Universal, 1/4" Shafts ..EX 2/2.50
- Feed-thru Capacitors 15 on Panel....Three Panels ... /1.00
- BNC (UG290/U Coaxial Panel SocketsEX 8/1.00
- Coax 6" long w/BNC (UG260A/U) Plug each end EX 5/1.00
- Coax 8" w/1 BNC Plug & 1 BNC Panel Socket ..EX 4/1.00

E. C. HAYDEN Box 294, Bay Saint Louis,
Mississippi 39520.
Prices: FOB Bay Saint Louis. Terms: Net, Cash.

Caveat Emptor?

★ Price—\$2 per 25 words for non-commercial ads; \$10 per 25 words for business ventures. No display ads or agency discount. Include your check with order.

★ Type copy. Phrase and punctuate exactly as you wish it to appear. No all-capital ads.

★ We will be the judge of suitability of ads. Our responsibility for errors extends only to printing a correct ad in a later issue.

★ For \$1 extra we can maintain a reply box for you.

★ We cannot check into each advertiser, so Caveat Emptor . . .

DAVCO DR30 WANTED. State price and condition. J. A. Tyson, W9JXD, 5345 University Ave., Chicago, Ill. 60615.

WRL's USED GEAR has trial—terms—guarantee!
SR46—\$94.50; SR500—\$199.95; HW12—\$89.95; HW22—\$89.95; Galaxy V—\$289.95; Galaxy 300—\$159.95; TX62—\$99.95; 75A3—\$229.00; 51J3—\$395.00; NC-300—\$149.95; RME6900—\$149.95. Hundreds more—low prices—free Blue-Book list. Write WRL, Box 919, Council Bluffs, Iowa 51501.

VERY GOOD LATE MODEL NCX 3. Several modifications, outboard 10 kc receiver tune, ALC, and speaker. \$150. AC power supply, \$35. W7QBT, 890 W. 21 Street, Eugene, Oregon 97405.

WANTED, ANY CONDITION; VOM, VTOM, Weststone Bridge. Resistance Decade Box, meter monuments. Gil Barber, 4155 E. Carey, Las Vegas, Nevada 89110.

NCX-5 MARK II and NCXA in excellent condition. \$450 cash. Write K5TSR, 102 W. Rampart Dr., Apt. Q203, San Antonio, Texas 78216.

HALLICRAFTERS HT 32, like new, \$250. Globe King 500A 160 through 10. CW. AM, with your exciter will run 700 watts SSB. ALC, extra final, VFO. \$195, like new. 3-5 KVA generator, \$200. Ship. John Smith, 1924 Dolphin Blvd., St. Petersburg, Florida 33707.

FOR SALE: HEATH SB-301 rec. with CW filter factory aligned, \$260.00. Knight P2 SWR bridge, \$10.00. Heath Kit H D-10 electronic keyer, \$35.00. Instrograph code practice keyer with full set of tapes, \$25.00. Ameco code practice oscillator and CW monitor, \$5.00. Value of all equipment new, \$390.00. Will sell individually or as package for \$325.00. D. Willson, 7803 Dawn Rd., Cincinnati, Ohio 45237.

MODEL #28 KSR, \$295.00. Write for list of 10 years' surplus, RTTY, FAX, etc. G. White, 5716 N. King's Highway, Alexandria, Virginia 22303.

WANTED: Issues of 73. Oct. '60 to Dec. '62, Jan. '66 to Dec. '67. Kirt Fanning, 6021 Edgewood, LaFrange, Ill. 60525.

FOR SALE: Motorola 80-D, 12v, complete and a Link 50ufs, 110v base complete, both on 52.525HZ. \$120 for the pair. WA9GVE, 7424 Illinois Rd., Fort Wayne, Indiana.

FOR SALE: Clegg Apollo Six Linear Amplifier. Brand new! Below cost! Contact Jack Batts, Five Old Tavern Road, Wayland, Mass. 01778. Phone 653-6891.

NORELCO VIDEO TAPE RECORDER in perfect condition, tape and all additional parts included; CCTV camera—\$115.00, Vidicon—\$10.00, Vidicon Yoke—\$10.00, Elgeet 4" Telephoto lens—f2.7; Reverb—\$15.00; Simpson 260 VOM—\$35.00; Heath RF Signal Generator IG-102, \$15.00; EICO R-C Bridge & RLC Comparator—\$18.00; Tachometer—\$10.00. Wanted: 6M SSB Transceiver. WB2GKF, 506 Mount Prospect Avenue, Clifton, N.J. 07012.

FOR SALE: Complete Hallicrafters station in excellent condition. HT-37, and SX-100 with R-66B speaker. \$300. James Winter, RR 2, Huron, S.D. 57350.

THE HAM-DINGER: Warren (Ohio) A.R.A. 11th Annual Hamfest, Sunday, August 25, Newton Falls, rain or shine. Follow arrows from Rt. 534 or Turnpike Exit 14. Talk-in stations, 10-6-2-. Prizes, swapshop, homebrew-code contests, XYL-YL program, ragchews galore. Food sold or bring picnic. For Hamfest bulletin write W.A.R.A., Box 809, Warren, Ohio 44481.

TWO METER FET PREAMPLIFIER. Typical specifications: 12 DB or better gain with less than 2DB noise figure. \$10.95 postpaid. Communications Associates, P.O.B. 13275, St. Petersburg, Fla. 33731.

HALLICRAFTERS HT32B; \$275; NC-300, \$125; matching pr 813's GG linear with pwr supply, \$50; TR-4 with ac pwr supply and speaker, \$500. Beautiful. K6SUQ, 5 Rydal Court, Orinda, Calif. 94563.

WANTED: Heath-VX-1. Also G-76 AC power supply, must be in fine condition. Cash. G. Gysan, 53 Lothrop St., Beverly, Mass. 01915. Phone 922-3850.

FOR SALE: VHF EQUIPMENT: 6 meter SSB, HX-30 and HA-20 linear, factory wired, mint condition with manuals, \$245.00. Gonset communicator II-B, 6 meters, 12/117v in mint condition with manual, \$115. Gonset #3350, G-76 DC power supply (all transistor), \$50.00. W1VYB-J. Gysan, 53 Lothrop Street, Beverly, Mass. 01915. Phone: 922-3850.

TOROIDS, uncased 44 or 88mH, also individually epoxy encased 88mH for standards, any 5, \$1.50. 255A relay \$2.10, 18B socket 70¢ all PP USA. E. W. Evans, K4OEN, 220 Mimosa Ln., Paducah, Ky. 42001.

"SAROC" FOURTH ANNUAL fun convention scheduled January 8-12, 1969, in Hotel Sahara's new space convention center, Las Vegas, Nevada. Advance registration closes January 1, 1969. Ladies program in Don the Beachcomber. Technical seminars, FM, MARS, RTTY, QCWA, WCARS-7255. Registration \$12.00 per person entitles "SAROC" participants to special room rate \$10.00 plus room tax per night single or double occupancy, admittance to cocktail parties, technical seminars, exhibit area, Hotel Sahara's late show, Sunday breakfast equal to any banquet dinner, ask any "SAROC" veteran. Brochure planned November mailing for details QSP QSL card with ZIP Southern Nevada ARC, Box 73, Boulder City, Nevada 89005.

ARC-1 Transceiver 100-156 Mc, 25 Watts AM, with tubes, schematic, conversion info for 2-meters. Used, good. 50 lbs. \$20.00

ARC-1 only, less tubes, \$12.00

BC-221-AK with AC Power, Calib. Book & Xtal. \$95.00

TS-174, 20-250 Mc. Freq. Meter, on rack panel with AC Power, Calib. Book & Xtal. \$95.00.

Brush BL-202 2-channel oscillograph, Used, Exc. \$90.00

Sorensen 3000S AC Line Voltage Regulator, 3000 V.A. Used, Exc. \$125.00

Non-Linear-Systems 451 Digital Voltmeter. P.U.R.

Send 10c for flyer listing surplus equipment, test equipment, new and used ham gear.

JEFF-TRONICS

4252 Pearl Rd. Cleveland, Ohio 44109

GO VHF

Go VHF the easy VHF Associates way. Send for descriptive Technical Bulletins describing our complete line of TRANSISTOR RECEIVING CONVERTERS and VARACTOR FREQUENCY MULTIPLIERS for 50, 144, 220, 432 and 1296 MHz.

VHF ASSOCIATES, INC.

P.O. Box 22135, DENVER, COLORADO 80222

LARGEST SELECTION in United States AT LOWEST PRICES—48 hr. delivery

JAN
CRYSTALS

Thousands of frequencies in stock. Types include HC6/U, HC18/U, FT-241, FT-243, FT-171, etc. SEND 10¢ for catalog with oscillator circuits. Refunded on first order. 2400B Crystal Dr., Ft. Myers, Fla. 33901

EASY CONSTRUCTION

MEANS
UNIT CHASSIS
WRITE
DEVICES

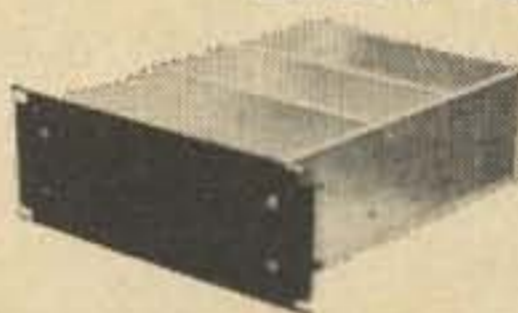

BOX 136, BRONX, N.Y. 10463

Get more watts per dollar

Send for free list—

NC200, AC200, both \$349.00; HRO500, Demo., \$1495.00; Swan 500, Demo., \$420.00; 350 for \$349.00; MarkII Lin., Demo., \$530.00; Collins, 3283, \$650.00; Hallicrafters SR2000 & P2000, both \$1250.00; Used for \$995.00.

FRECK RADIO & SUPPLY CO., INC.

38 Biltmore Avenue • Asheville, N.C. 28801
T. T. Freck W4WL 704-254-9551 Doug Jones WB4IHO

**"THE COMPLETE HAM STORE"
WHERE YOUR DOLLAR BUYS THE MOST**

All leading lines of amateur gear:
We give best trade-in allowance
for your gear on new equipment:
Call us for the best deal:

**WE PAY CASH FOR HAM & CB RADIOS
CALL OR WRITE**

BOB'S AMATEUR ELECTRONICS

927 N.W. 1st. St., OKLA. CITY, OKLA. 73106
Phone 405-CE-5-6387

WE PAY CASH FOR TUBES

Lewispaul Electronics, Inc.
303 West Crescent Avenue
Allandale, New Jersey 07401

VIBROPLEX

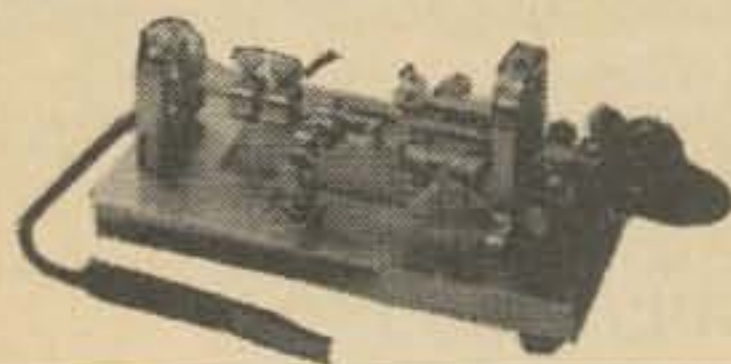

ENJOY EASY,
RESTFUL KEYING
\$21.95 to \$43.95
THE VIBROPLEX
CO., INC.
833 Broadway,
N. Y. 3, N.Y.

TRADE YOUR SURPLUS FOR BRAND NEW GEAR!

Your surplus can easily make a good down payment on brand new ham equipment. Send me your list of surplus and tell me what you want.
Bill Slep, W4FHY

Write-Wire-Phone (813) 722-1843

SLEP ELECTRONICS COMPANY
2412 Highway 301 N, Ellenton, FL 33532

YOUR SURPLUS WANTED BY THE FASTEST GUN IN THE EAST



No horsing around, we pay fast . . . in 24 hours . . . and we pay more. We'll swap or trade new equipment too . . . We quote fast too. We also pay for shipping, insurance, etc. You call fast, now, collect, for fast quote.

SPACE ELECTRONICS

div. of MILITARY ELECTRONICS CORP.
11 Summit Ave., East Paterson, N.J. 07407, (201) 791-5050

ETCHED CIRCUIT BOARDS

Novice Trans.	2.75	Novice rec.	2.75
RTTY Encoder	2.50	RTTY Decoder	4.00
UHF Dippers	2.25	SWR Bridge	1.25
Lab Supply	3.50	144 Converter	5.75
Keyer	4.95	CP Osc. Mon.	1.25

Send order or Catalog request to . . .

HARRIS CO.
BOX 985, TORRINGTON, CONN. 06790.
Conn. Res. add sales tax.

SURPLUS SALE

We have to move a quantity of material out of one of our storage areas, and need room. Many parts, assemblies and assorted material will be sold at cost (or below) on a first come first served basis. Our special sale flyer is available by sending 3 unused 6c postage stamps to cover postage & handling.

BIGELOW ELECTRONICS
P.O. Box 71 Bluffton, Ohio 45817

RTTY GEAR FOR SALE. List issued monthly, 88 or 44 MHy torroids 5 for \$1.50 postpaid. Elliott Buchanan & Associates, Inc., 1067 Mandana Blvd., Oakland, California 94610.

3000 V @ 3µF brand new GE Pyronal oil capacitors \$3 each. Can mail. 3-lbs each shipping wt., FOB. P. Wandelt, RD # 1, Unadilla, New York 13849.

WANTED: Military, commercial, surplus Airborne, ground, transmitters, receiver, testsets accessories. Especially Collins. We pay freight and cash. Ritco Electronics, Box 156, Annandale, Va. Phone 703-560-5480 collect.

CLEGG VENUS 6 M SSB serial 100 33 w/ac ps and APOLLO LINEAR 1200 265. Both units recently factory checked. Included SS Booster 708 308. Everything \$450.00. Eastern Penna. Write Box 968, c/o 73 Magazine.

SELL. Excellent CE100V, \$495. Kent Markel, Box 144A RR 1, Lexington Park, Maryland 20653. 301-863-5967.

FOR SALE: SX101—\$100; Knight R100A—\$70; Ranger II—\$150; DX60—\$40; HW32—\$75. Don Ahonen, Rt. 1, Bx 291A, Lisle Road, Owego, New York 13827.

WANTED: HA-10 LF/MF tuner, new or used. F. Rafalowski, 525 Home Ave., Trenton, New Jersey 08611.

SELL/TRADE: Collins mechanical filters, F455N-20 (2kc), F455N-30 (3kc), F455N-40 (4kc), on partially cannibalized Collins sub-chassis 5407577006. Will remove filters or send sub-assembly. Trade for or buy 500kc filters for 51J4 receiver: F500B-31, F500B-14, F500B-08, or what have you that fits? W. A. Kernaghan, 1752 Kilohi St., Honolulu, Hawaii 96819.

FOR SALE: Thunderbolt. Complete with spare tubes. Will ship. \$225. K6HLO, 511 Oak St., Roseville, California 95678.

THE CENTRAL NEW YORK CHAPTER OF QCWA will hold its annual banquet and meeting on September 28, 1968, at Hanson's Hotel, Oquaga Lake, Deposit, New York. Cocktail QSOs from 5 to 7 p.m. Buffet dinner at 7 p.m. and business meeting and election of officers at 8:30 p.m. All QCWA members are invited to attend and enjoy this program. Use exit 83 from the East, exist 82 from the West, on route 17. Tickets \$5. For further information contact Clark Galbreath W2AXX, 111 Keeler St., Endicott, N.Y. 13760.

FOUR CORNERS FIELD DAY! September 21, 22. Club station K5WXI will operate 15, 20, 40 and 80 meters SSB and CW day and night. "5 Ø 7" award for working this station.

THE FOUNDATION FOR AMATEUR RADIO will hold its annual Hamfest on Sunday, September 22 from 1000 until 1700 hours at the Gaithersburg Fairgrounds in Gaithersburg, Md.

THE IOSCO RADIO CLUB presents its 4th annual Northeastern Michigan Hamfest on October 4, 5, 6 at East Tawas, Mich. 60 miles north of Bay City on US 23. Programs will begin Friday, October 4, at 6 p.m. ending Sunday afternoon at 3 p.m. For additional information contact Jerry Mertz W8DET or Glenn A. Pohl K8IYZ.



"FLAT PAK" INTEGRATED CIRCUITS!!

BRAND NEW!
\$1.49

DUAL
914*

We include
30 Basic IC Projects
RADIO-ELECTRONICS
January & JULY 68



RTL Logic

-55° C to +125° C
Electronics World:

★ First time anywhere two identical IC's in one, package.

EPOXY SILICON TRANSISTORS

- 3-FK-4046, 1W, 0.5A, npn, 250MC \$1.00
- 3-2N3568, 350MW, 200MC, 200BVC, NPN \$1.00
- 4-2N3563, NPN, 600MC, 200MW \$1.00
- 3-2N3683, NPN, 1000MC, 5MA, 200MW .. \$1.00
- 3-14 WATT, B-5000, npn, 3A \$1.00
- 4-2N4313, PNP, 600MC, 200MW \$1.00
- 4-2N3565, 500HFE, npn, 200MC \$1.00

FAIRCHILD INTEGRATED IN-LINE CIRCUITS

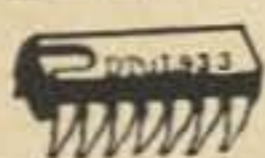

Tested, with data sheets

- 930 DUAL 4 INPUT GATE & EXPANDER \$1.00
- 933 DUAL INPUT EXPANDER \$1.00
- 944 DUAL POWER GATE \$1.00
- 946 QUAD 2 INPUT NAND/NOR GATE \$1.00
- 952 DUAL 2 INPUT INVERTER GATE \$1.00
- 953 2-2-3 INPUT AND GATE \$1.00
- 954 DUAL 4 INPUT AND GATE \$1.00
- 955 8 INPUT AND GATE W/2 INPUTS \$1.00
- 956 DUAL INPUT BUFFER \$1.00

100's of other IC's including: Flip-Flops, Registers, Adders, etc. Write for listing.

FAIRCHILD ** BRAND NEW! "FLAT PAK" RTL INTEGRATED CIRCUITS Sale

- 900 Buffer \$1.49
- 903-903* 3 Input Gate \$1.69
- 904-904* Half Adder \$1.69
- 914-914* Dual 2 Input Gate \$1.49
- 923 JK Flip Flop \$1.69
- 923-923* JK Flip Flop \$1.98
- 927 Quad Inverter \$1.69

*First time anywhere two identical IC's in one package, example 923-923 contains two separate JK flip-flops in one package. 914's and 923. We include 50 uses. ** Licensed. 1/4" x 1/4"

LINEAR AMPLIFIERS with circuits & data

- 702C WIDE BAND DC \$3.98
- 703H RF-IF-FM \$1.49
- 709C HI-GAIN OPERATIONAL \$3.98
- 710C HI-SPEED DIFF. COMP. \$3.98
- 711C DUAL COMPARATOR \$4.98

400 mc
5 for \$1



2N706

Watts | V_{cb} | I_o | ma
.5 | 30 | TO-300 | 150

SILICON

\$10 ORDERS
CHOOSE
ANY
\$1 ITEM Free

100 MICROAMP PANEL METER



SILICON POWER STUD RECTIFIERS

PIV	3A	6A	12A	55A
50	<input type="checkbox"/> .06	<input type="checkbox"/> .16	<input type="checkbox"/> .20	<input type="checkbox"/> .50
100	<input type="checkbox"/> .07	<input type="checkbox"/> .22	<input type="checkbox"/> .25	<input type="checkbox"/> .75
200	<input type="checkbox"/> .09	<input type="checkbox"/> .30	<input type="checkbox"/> .39	<input type="checkbox"/> 1.25
400	<input type="checkbox"/> .16	<input type="checkbox"/> .40	<input type="checkbox"/> .50	<input type="checkbox"/> 1.50
600	<input type="checkbox"/> .20	<input type="checkbox"/> .55	<input type="checkbox"/> .75	<input type="checkbox"/> 1.80
800	<input type="checkbox"/> .30	<input type="checkbox"/> .75	<input type="checkbox"/> .90	<input type="checkbox"/> 2.30
1000	<input type="checkbox"/> .40	<input type="checkbox"/> .90	<input type="checkbox"/> 1.15	<input type="checkbox"/> 2.70



1 AMP TOP HAT AND EPOXIES

PIV	SALE	PIV	SALE	PIV	SALE
50	<input type="checkbox"/> .05	800	<input type="checkbox"/> .19	1800	<input type="checkbox"/> .87
100	<input type="checkbox"/> .07	1000	<input type="checkbox"/> .31	2000	<input type="checkbox"/> 1.05
200	<input type="checkbox"/> .08	1200	<input type="checkbox"/> .44	3000	<input type="checkbox"/> 1.60
400	<input type="checkbox"/> .11	1400	<input type="checkbox"/> .62	4000	<input type="checkbox"/> 1.90
600	<input type="checkbox"/> .16	1600	<input type="checkbox"/> .72	10000	<input type="checkbox"/> 4.80

★ Handles 2 Amps
2 AMP
800 PIV
TOP HAT
RECTIFIERS

6
for
\$1



TUNNEL
DIODE
1N3716/TD3
Actual Size
Used in many
oscillator and
amplifier circuits



1.
AMP

MICROMINIATURE SILICON RECTIFIERS

Actual Size

PIV	Sale	PIV	Sale
50	<input type="checkbox"/> 5¢	600	<input type="checkbox"/> 20¢
100	<input type="checkbox"/> 7¢	800	<input type="checkbox"/> 25¢
200	<input type="checkbox"/> 9¢	1000	<input type="checkbox"/> 31¢
400	<input type="checkbox"/> 12¢		

10¢ for bargain catalog on 100's of \$1 Poly Pak assortments, transistors, rectifiers, zeners, ICs, Triacs, SCRs, etc., parts & equipment. "It's the hottest bargain parts catalog in the industry."

Terms: add postage. Rated: net 30, cod's 25%
Phone Orders: Wakefield, Mass. (617) 245-3829
Retail: 211 Albion, St., Wakefield, Mass.

POLY PAKS

P.O. BOX 942 A
Lynnfield, Mass. 01940

LIBERTY PAYS MORE!!

WILL BUY FOR CASH ALL TYPES

- ELECTRON TUBES
- SEMICONDUCTORS
- Military Electronic Equipment
- Test Equipment

PRESTEL FIELD STRENGTH METER

(Model 6T4G)

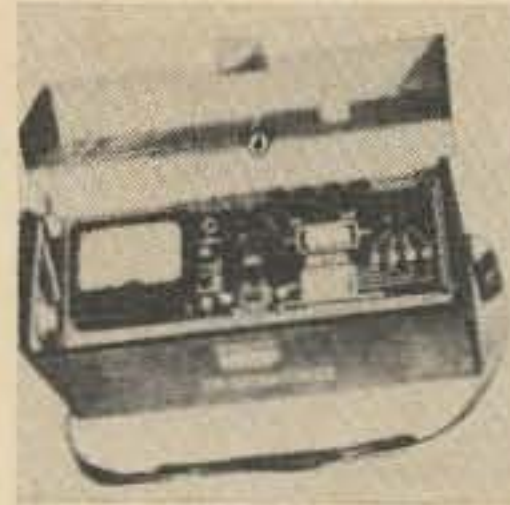

Frequency Range: 40 to 230 and 470 to 860 Megahertz. Calibrated outward from 10 to 50,000 Microvolts. Nothing makes it easier to properly and speedily find the correct place to install TV, FM and Communication Antennas. You can measure and hear the signals

with this 4½ volt battery economically powered unit. There is nothing else like it!

Only \$120.00

WIRE, WRITE, PHONE COLLECT! WE PAY FREIGHT ON ALL PURCHASES

Liberty Electronics, Inc.

548 Broadway, New York, New York 10012, Phone 212-925-6000

BIG CATALOG

World's "BEST BUYS"
in GOV'T. SURPLUS
Electronic Equipment

RECEIVERS:

RCAF GR-10—195-410 KC & 1.4-31 MC, Used, Checked: \$99.95
BC-603—20-27.9 MC FM Receiver with sensitivity and squelch:
Used, Not Checked: \$22.95 Used, Checked for op.: \$32.95
BC-348 Receiver—200-500 KC and 1.5-18 MC w/Crystal Phasing
BFO, and Vernier Tuning, AVC, MVC. Prices: Used, less
Dynamotor: \$69.50—Used, less Dynamotor, operation checked:
\$79.50

Power Supply for BC-348—115 VAC New: \$18.95

COMMAND RECEIVERS — TRANSMITTERS:

BC-453—190-550 KC, with Dynamotor Used: \$16.95
BC-454—3.0-6.0 MC, with Dynamotor Re-New: 19.95
BC-455—6.0-9.1 MC, with Dynamotor Re-New: 14.95
R-25/ARC-5—1.5-3.0 MC, less Dynamotor New: 19.95
R-28/ARC-5—100-156 MC, less Dynamotor Used: 22.95
T-18/ARC—2.1-3.0 MC Used: \$9.95 New: 12.95
T-20/ARC—4.0-5.3 MC Used: \$6.95 New: 9.95
T-21/ARC—5.3-7.1 MC Used: \$6.95 New: 9.95
T-22/ARC-5 7.0-9.1 MC Unused: 18.95
T-23/ARC—100-156 MC New: 24.95
BC-969—3.0-4.0 MC Gov't. Reconditioned: 12.95
BC-456 Modulator—Use with Command Transmitters 3.95
MD-7/ARC-5 Modulator—ARC-5 and Comm. Trans. .. 9.95

RECEIVER — TRANSMITTERS:

BC-620 FM TRANSCEIVER—20-27.9 MC Crystal Control, and
PE-97 Power Supply—6/12 VDC Re-New: \$19.95
BC-659 FM TRANSCEIVER—27-38.9 MC Crystal Control, and
PE-117 Power Supply—6/12 VDC Re-New: 19.95
SCR-522 RECEIVER-TRANSMITTER—AM Four Channel Cryst-
tal Control—100-156 MC Used: 29.95
ARC-3—100-156 MC 8 Channel Crystal Control AM—Aircraft
Equip. Electric Band Change. R-77/ARC-2 Receiver—Used: 24.95
T-67/ARC-3 Transmitter Re-New: 29.50

Prices F.O.B. Lima, O.—25% Deposit on COD's.

BIG FREE CATALOG—New edition just off the press!
Send for your FREE copy today. Address Dept. 73.

FAIR RADIO SALES

1016 E. EUREKA • Box 1105 • LIMA, OHIO • 45802

INDEX TO ADVERTISERS

Adirondaek, 103
Aerotron (Ameco), 67
Amber Ind., 103
Amidon, 107
Arcturus, 107
Arrow Sales, 103
ATV, 98

B.C. Electronics, 91
Bel Air, 100
Bigelow, 110
Bob's Amateur Electronics, 109
BTI (Hafstrom), 37

Clegg, 84
Crabtree's, 23
Cushcraft, 24

Dames, Ted, 104
Devices, 109
Drake, Cover IV
DXer Magazine, 106

Epsilon, 37
Estes, 104
Evans, 58

Fair Radio, 112
FM Magazine, 26
Freck, 109

Gain, Inc., 33
Galaxy, Cover III
Gateway Electronics, 108
Gateway Towers, 106
Goodheart, 100

Harris, 110
Hayden, 108
Heath, 19
Henry Radio, 13
Hi Par, 97
Hunter, 33

International Crystal, 3

JAN Crystal, 109
JeffTronics, 109

Kaptain's Komponenten, 67

Leger Labs, 85
Lewispaul, 110
Liberty, 112

Meshna, 91
Mission, 15
Montgomery Geodetic Services,
97
Mosley, 41

Nat'l ARRL Convention, 104

Omega-T, 57

Palomar, 37
Pickering, 61
Poly Paks, 111

Radio Amateur Callbook, 99
Radio Shack, 55
R&R, 102
Redline, Cover II, 68, 69
Rohn, 5

Saleh, 98
Sentry, 39
Slep, 110
Sound History, 35
Space/Military, 110
Stellar, 46
Swan, 11

TAB, 103
TAB Books, 91
Tex Rad, 106
Telrex, 18, 29

UKW, 104
US Crystals, 108

Vanguard, 36, 40, 73, 85, 90,
101, 105
Vibroplex, 110
VHF, 109

Westcom, 99

73 Magazine, 25, 92, 93, 101,
103



The Distinguished Family of World Travelers

The experts know that matchless performance can only be achieved through matched components.

That's a sound principle to follow whether your interest is racing engines, golf, fishing or doing a better home laundry. It's an even more important criteria when you travel the world as an Amateur Radio Operator.

You travel the first class ticket when you go on the Galaxy line. Matched components, balanced and precision produced to perform as a perfect team. A team that will take you anywhere in the world...and bring the world to you.

We're Hams ourselves, so we know that's what you want from your equipment investment.

See the Galaxy line at your dealer's. If he doesn't have it, write us for one near you who does.



GALAXY ELECTRONICS

"Pacesetter in Amateur/Commercial Equipment Design"

10 South 34th Street • Dept. 73-M33 • Council Bluffs, Iowa 51501

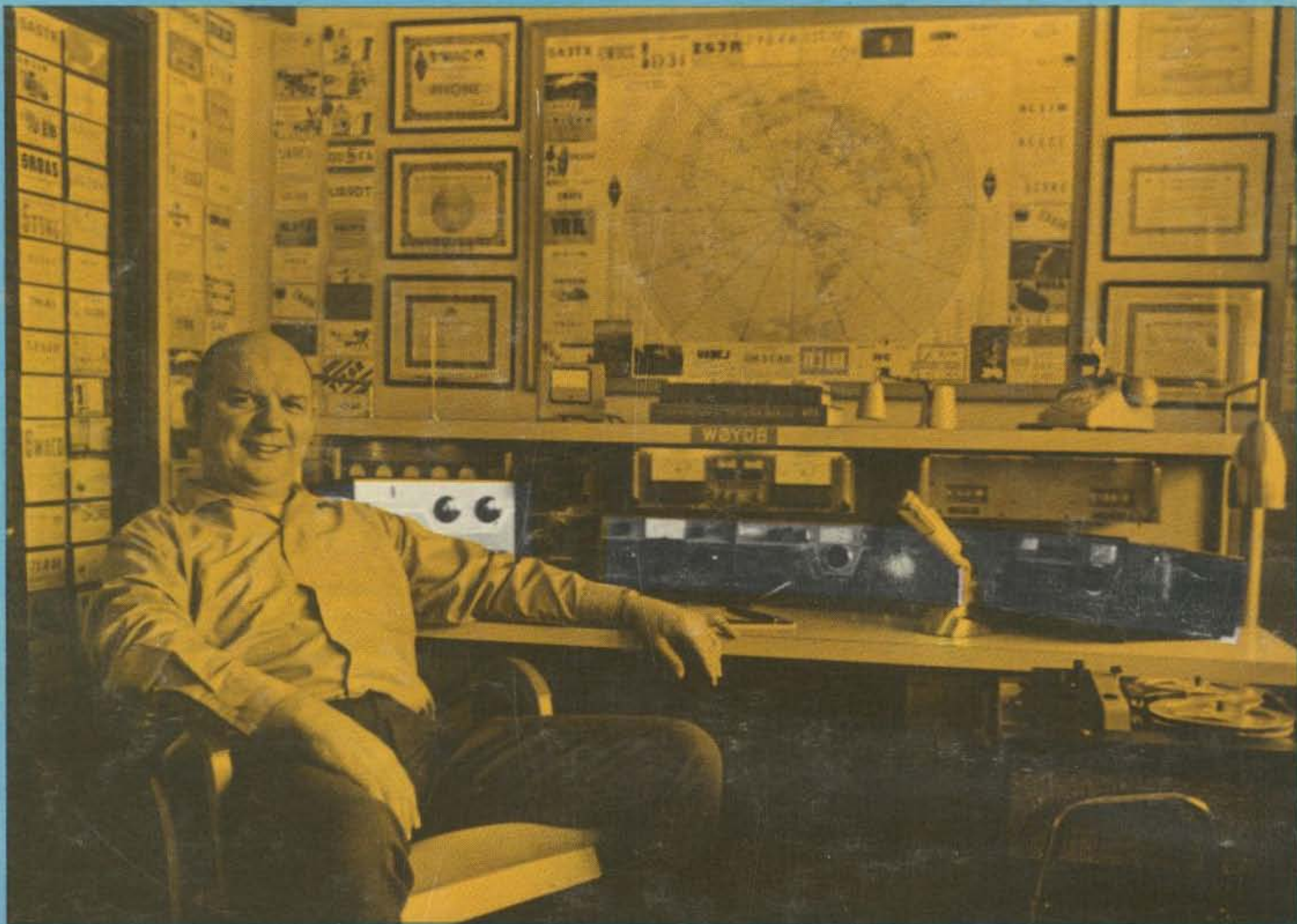

“Drake 4-Line is the most satisfying...totally efficient...”

says WØYDB, Minneapolis . . .

To quote in part from a letter received from W. C. Higgins, WØYDB, Minneapolis, Minn., dated May 10, 1968 . . .

“...Enclosed are several snapshots of my hamshack and equipment. Since the Drake 4-Line is so predominant, I thought that you might like to add to your photo collection of Drake-equipped stations. Granted, the gear is not the new B series but it is still the most satisfying and totally efficient that this old-timer has used in 32 years of amateur, military and commercial electronic experience. I earn my living as a Production Manager of (aero-space) electronic instrumentation production . . . and I think I can recognize excellence in electronic engineering design and performance when I see it.

“Again, congratulations for developing the 4-Line. 73 . . .”

(Signed) Bill, W. C. Higgins

Ask any ham who owns a Drake 4-Line Revr, Xmtr or Linear...

or write for detailed specifications:

Dept. 388 **R. L. DRAKE COMPANY** 540 Richard St., Miamisburg, Ohio 45342