

75

3.8

3.85

May 1961

37¢

2 for 73¢

5

73

7.2

14.2

14.25

Amateur Radio

21.3

21.35

21.4

29

29.2

29.4

2

52.5

53

50

60

NEW! GSB-201

GONSET'S LITTLE POWERHOUSE!



Now at your distributor

RF LINEAR AMPLIFIER

BIG... with a husky, go-places power rating of 1500 watts PEP...

SMALL... only a foot across the front—less than one-and-a-half feet in depth!
No space problem here—these are true “table-top” dimensions.

Fine looking—modern industrial designer styling—finished in durable, attractive light colors. Blends well with existing equipment.

Features and features...

Full bandswitching 80-40-20-15 and 10 meters • pi network output • stable, efficient grounded grid circuitry • Power input rating: 1500 watts PEP SSB • 1000 watts CW • 400 watts AM • can be driven by exciters in the 65-150 watt category, GSB-100 and similar units • Low cost Type 811A tubes used in amplifier • long life silicon rectifiers replace older vacuum tube rectifiers in high voltage power supply • Antenna changeover relay is built in • panel switch allows tune up at low power • full vision panel instrument is switchable to indicate amplifier plate current or relative RF output • Dimensions, 8½" high, 12⅝" wide, 17" deep.

Model #3340

399⁵⁰



GONSET

Division of Young Spring & Wire Corporation
801 SOUTH MAIN ST., BURBANK, CALIFORNIA

EXPORT SALES: WESTREX CORP., 540 WEST 58TH ST. NEW YORK 19, N. Y.

You can't miss hearing this!



CLEGG ZEUS

TRANSMITTER for 6 & 2

...185 Watts of Solid "Talk Power" Tops the Band!

Again ...

Clegg Laboratories brings VHF'ers a new power packed performer . . . A new beauty that's guaranteed to produce more carrier output and a higher level of modulation power than any other commercially built VHF amateur transmitter now available.

Put a *Zeus* on 6 and 2 and watch the QSO's roll in. If you like DX, listen to this! — You'll have 185 solid watts on *both* AM and CW . . . and you'll have *automatic* modulation control that will actually let you "out-talk" many kilowatt rigs!

CHECK THESE FEATURES AND SEE WHY A NEW ZEUS WILL PUT YOUR CALL ON THE "MOST WANTED LIST"

- High Level Plate and Screen Modulation
- Highly Efficient Type 7034 Final Amplifier
- Self-Contained Stable VFO
- Built-In Automatic Modulation Control
- Simple Band Switching and Tune-Up
- Two Unit Construction with Remote Modulator and Power Supply Conserves Space at Operating Position

Amateur Net Price: Only \$595. Completely wired and tested with all tubes, Modulator, Power Supply, VFO, cables, etc.

Clegg LABORATORIES

RT. 53, MT. TABOR, N. J. • OAKWOOD 7-6800

Ask your Clegg Distributor (listed below) for full information. He'll be glad to serve you.

California
Henry Radio, Los Angeles, Severns, Hemet

Connecticut
Kaufman Electronics, Bridgeport

Delaware
Delaware Electronics Sup., Wilmington

Florida
Amateur Radio Center, Inc., Miami
Electronic Equipment Company, Inc., Miami

Indiana
Brown Distributors, Fort Wayne
Van Sickle Radio Supply, Indianapolis

Iowa
World Radio, Council Bluffs

Kansas
Acme Radio & T. V., Hutchinson

Maryland
Key Electronics, Wheaton

Massachusetts
De Mambro Radio Supply, Boston

Michigan
Purchase Radio Supply, Ann Arbor
Radio Parts, Inc., Grand Rapids

Missouri
Henry Radio, Butler
Walter Ashe, St. Louis

New Mexico
Car Parts Depot, Roswell
Valley Engineering, Los Alamos

New Jersey
Federated Purchaser, Mountainside

New York
Terminal Electronics, New York
Harrison Radio Corp., New York

Ohio
Universal Service, Columbus
Sternbergs, Inc., Cincinnati

Oklahoma
Radio, Inc., Tulsa

Pennsylvania
Tydings Company, Pittsburgh
Eugene G. Wile, Philadelphia

South Carolina
Dixie Radio Supply Company, Sumter

South Dakota
Dakota Supply, Yankton

Virginia
Key Electronics, Arlington

Washington
Radio Supply Company, Seattle

Amateur Crystals

**1000 KC to
137 MC - .01%
TOLERANCE**

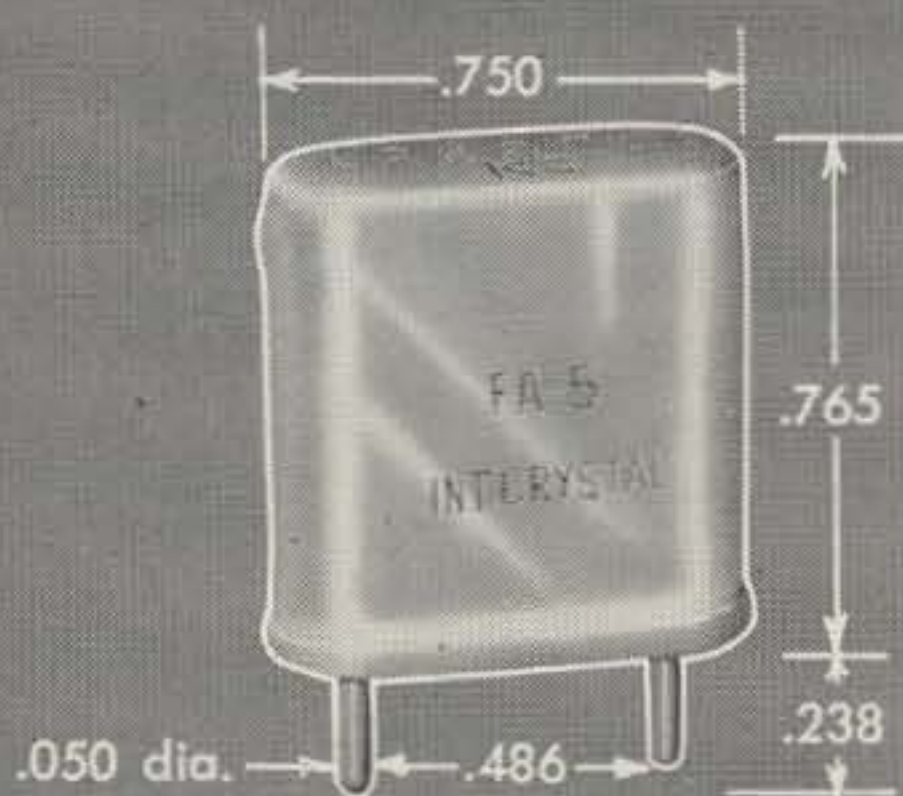

New!
MINIATURIZED
FM-9 SERIES

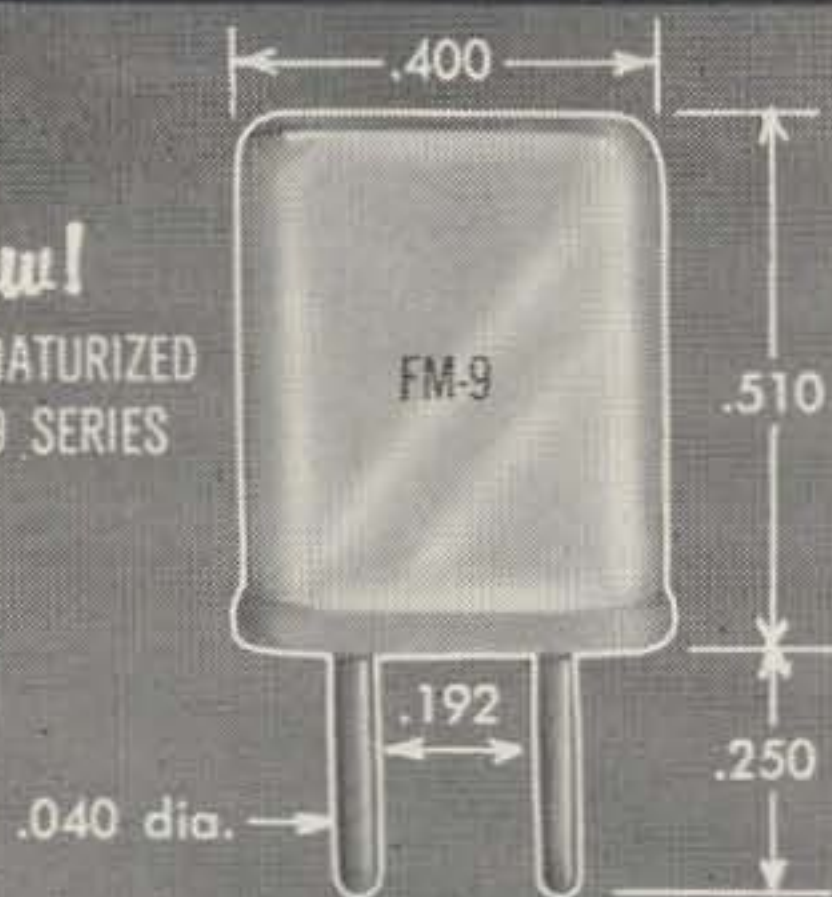

Wire mounted, plated crystals for use by amateurs and experimenters where tolerances of .01% are permissible and wide-range temperatures are not encountered.

Just any crystal in any oscillator will NOT combine to produce spot frequencies. These crystals are designed to operate into a 32 mmf load on their fundamental between 1000 kc and 15000 kc. Overtone crystals operate at anti-resonance on 3rd mode and series resonance on 5th and 7th mode crystals.

- **HOLDERS:** Metal, hermetically sealed. FA-5 and FA-9 are HC/6U pin type while the FM-9 is an HC/18U pin type.
- **FREQUENCIES** (Specify crystal type and frequency when ordering.)

	FA-5 and FA-9	Price	FM-9	Price
Fundamental	1000 - 1499 kc	\$ 5.75	Not available	
	1500 - 1799 kc	\$ 4.95	Not available	
	1800 - 1999 kc	\$ 4.40	Not available	
	2000 - 9999 kc	\$ 3.30	8000 - 9999.999 kc	\$ 5.00
	10000 - 14999 kc	\$ 4.40	10000 - 15000 kc	\$ 5.50
	15000 - 20000 kc	\$ 5.50	15001 - 19999.999 kc	\$ 6.50
Overtone (3rd)	10 - 14.99 mc	\$ 4.40	Not available	
	15 - 29.99 mc	\$ 3.30	20 - 39.99 mc	\$ 5.00
	30 - 59.99 mc	\$ 4.40	40 - 59.99 mc	\$ 5.50
Overtone (5th)	60 - 75.99 mc	\$ 4.95	60 - 89.99 mc	\$ 6.50
	76 - 99.99 mc	\$ 7.15	90 - 100 mc	\$ 8.50
	Not available		101 - 110 mc	\$10.00
Overtone (7th)	100 - 137 mc	\$ 9.35	Not available	

Overtone crystals are calibrated on their overtone frequency. They are valuable for receiver-converter applications and are NORMALLY NOT UTILIZED IN TRANSMITTERS, since only a small amount of power is available under stable operating conditions.

- **CALIBRATION TOLERANCE:** $\pm .01\%$ of nominal at 30° C.
- **TEMPERATURE RANGE:** -40° to +70° C. $\pm .01\%$ of frequency at 30° C.
- **DRIVE LEVEL:** Recommended, maximum 3 milliwatts for overtones; up to 80 milliwatts for fundamentals, depending on frequency.

ONE DAY PROCESSING . . .

Orders for less than five crystals will be processed and shipped in one day. Orders received on Monday through Thursdays will be shipped on the day following. Orders received on Friday will be shipped the following Monday.

WRITE FOR 1961 CATALOG FREE!



18 NORTH LEE • OKLAHOMA CITY, OKLA.

G4 Zed Smith	Hartland Smith W8VVD	9
A tri-bander without loading coils or traps; can be tuned from the shack!		
Feedline Economy	William Roberts W9HOV	18
Open-wire line just may become popular again after you read this one.		
Propagation Special Feature	Dave Brown K2IGY	20
Taking a look at sunspot numbers with an eye to predictions.		
Testing the KT-200 Receiver	Allie C. Peed K2DHA	22
Next month we have some of Bill Orr's ideas for modifying this receiver.		
Ham Calendar	R. M. Case K4YNO	25
Just what we've been needing. Should go nicely with a 35 hour clock.		
Build a Vary-Volt	Joseph Leeb W2WYM	26
A piece of test equipment that is worth its weight in something or other.		
Moonstruck	Dave Bell W8GUE/6	28
Eyewitness account.		
Moon Chart	Bill Ashby K2TKN	31
How to get radio signals back from the moon, reduced to a chart.		
Sideband Exciter	Angel Fernandez W2NQS	32
What with Turret construction and a simple circuit you may try this one.		
Testing the Knight GDO	Steve Abrams W2OKU	35
Porsche-pushing ham tests Knight GDO, likes it, tells all.		
Propagation Charts	Dave Brown K2IGY	36
What time to where, when on what bands . . . probably.		
Custom Resistors	Roy E. Pafenberg	38
How to move precision resistors to the value you need.		
AC Calibration of your VOM	William Bentley	40
We'll be giving you more and more on precision and calibration.		
Ohms by the Yard	Jim Kyle K5JKX/6	41
This ties in with the precision resistors on page 38.		
Blowers	Melvin Leibowitz W3KET	42
What size blower you need to keep a cool rig.		
How Low The Fi	Staff	44
Our technical article: examining the audio stages of your receiver.		

Misc.:		Staff:
Table of Contents.....	3	editor-publisher
Editorial	4	Wayne Green W2NSD
Subscription Rates	6	publications manager
High Voltage Insulation for Meters.....	21	David Fish
Club Subscriptions	30	associate editor
Quick and Cheap	37	Don Smith W3UZN
Improved Meter Accuracy.....	49	associate editor
Letters	51	Jim Kyle K5JKX/6
Maps Maps Maps Maps Maps Maps Maps	52	associate editor
Ham Headlines	55	Marvin Lipton VE3DQX
AF MARS Technical Broadcasts.....	55	associate editor
Public Information Field Day.....	56	Charles Spitz W4API
\$65 Sideband Transceiver	57	sales representative
Other Ham Publications	59	Jim Morrisett WA6EXU
Advertising Index	62	3rd assistant vice-president ..
		John Peterson WA2FME
		photographer
		Joe Schimmel W2QDM
		subscriptions
		Mrs. Wayne (Virginia) Green
		transportation
		Porsche
		printing
		Ye Olde O'briene Presse

COVER: Segment of National NC-270 Dial.

73 Magazine is published monthly by Amateur Radio Publishing, Inc., 116 Main Street, Norwalk, Connecticut. Business Office, 1379 East 15th Street, Brooklyn 30, New York. Telephone: DE 6-8880. Subscription rates: U.S.A. and possessions, APO, FPO, Canada and Mexico; one year \$3.00; two years \$5.00; three years \$7.00. Foreign: one year \$4.00; two years \$7.00. Second-class postage paid at Norwalk, Connecticut. Printed in the U.S.A. Entire contents copyright 1961 by Amateur Radio Publishing, Inc. Postmaster: Please send form 3579 to 73 Magazine, 1379 East 15th Street, Brooklyn 30, New York.

... de W2NSD

(never say die)

More Congratulations

Are in order. You fellows are without a doubt the liveliest group of magazine readers ever assembled. You've not only been brain-washing our advertisers with information requests, but you've been sending them checks with abandon. It is quite a pleasure for me, as chief advertising salesman, to call advertisers and find that I don't have to suggest that maybe next month things will pick up a bit. When I call they sell *me*. They must be exaggerating a bit when they say that they're getting as good results from advertising in 73 as they do from magazines with twice or three times the circulation. I like to hear it, but I don't really believe it. You aren't working *that* hard, are you?

The post card we bound in the last issue gave me some weary nights clipping all those information requests out and sorting them for the advertisers. It also gave me some terrifically effective ammunition for shooting down some of the more reluctant prospective advertisers. There are still some well known ham manufacturers conspicuous by their absence as supporters of the magazine. A few of the readers, noticing this absence, requested information from missing advertisers. This is probably a much better advertising sales talk than the one that I have been using, which draws more on their heartstrings than their business acumen.

Three in One

The Totah ARC of Farmington, N.M. have discovered an unusual spot for a DXpedition. Look for 'em on the bands on May 27-28 operating from the junction of the W5-W7-W ϕ call areas, which is also the meeting point for four states. Your QSL will bring you a colorful certificate.

Too Many Ads

We really should have put in a few more pages this month, but we're still trying to work our way out of the difficulties and expense of moving our office to new larger (and just as ugly) quarters. So bear with us for a little longer as we try to get this thing on an even keel. We've got a lot of interesting stuff in preparation for you. Two meter ops will be

pretty excited over the new mobile (and fixed station) antenna we've got coming. This one seems to have a lot of advantages over the halo. Sidebanders will like our coming transceiver. Then we have a 2M transceiver too . . . and it can mostly be built from junk parts from old TV sets or FM sets. Plus all sorts of small projects.

FCC Actions

The Maritime Mobile Amateur Radio Club has petitioned the FCC for a very long overdue modification of the regulations to permit MM stations to use 20 meters world-wide and also 40 meters while in North and South American waters. This is particularly important in view of the rapidly deteriorating band conditions which are leaving the ten and fifteen meter bands high and dry and about as useful as two meters. Let's hope that this proposal goes right through without the usual three year battle.

Phoenix May 26-29

Virginia and I are looking forward to meeting as many of you as possible at the big Klatch in Phoenix this month. This will be a combination subscription gathering expedition and honeymoon for us . . . in case you missed the not too cryptic note on page three last month. If you're within driving or flying distance this extended weekend shindig will make a fine vacation for you.

In addition to lots of equipment displays you will get a chance to hear Senator Barry Goldwater (ex 6BPI), Bill Orr W6SAI, Leo Earnshaw ZL2AAX, Don Stoner W6TNS, Wes Schum W9DYV, Merrill Swan W6AEE, and other interesting speakers.

Drop a line quickly to K7AWI, Box 7155, Phoenix, Arizona for all the details, or else show up on the 26th and join the fun. It's at the Westward Ho Hotel. And wow do they have prizes lined up for you!

Wise Words for Weary Writers

No matter what the Boy in the Back Room says, \$20 in the hand is worth a lot more than \$40 in the bush. When you submit an article to 73 you either get it back or you get a check . . . and with no one, two or three year wait.

To the hundreds
of Hams who have
taken the time
to write, we at
EICO can only
say...

FROM THE BOTTOM OF OUR HEARTS, THANK YOU

We promise to continue
to do all in our power
to merit your approval.

Milton Stanley
3909 High View Rd.
E. Peoria, Illinois
Electronic Instrument Co., Inc.
3300 Northern Blvd.
Long Island City 1, N. Y.

Dear Sir:

When I saw your Model 720 Transmitter on display, it looked so good that I decided to purchase a 720 kit. I put it together in five evenings. The instruction book is so well written that any beginner can build this kit with no trouble at all. When I put the 720 on the air for the first time, I called CQ and a station in Munising, Mich. answered me and gave me a 599 report. In two months I had worked 37 states with a single wire antenna about fifteen feet off the ground. All stations worked gave me a good report. I was so pleased that I purchased an EICO Model 730 Modulator. Results were equally good. I have worked 44 states and Canada on phone with the 720 and 730. All reports I get are very good. The clipping level control and the over-modulation indicator helps make the EICO 730 Modulator the best buy for the money and I personally believe the EICO 720 Transmitter is the best 90-watt rig on the market. The EICO 720 and 730 together make an all around rig that is hard to beat. I am so well pleased with the quality of EICO kits that I am looking forward to building more of your products. I highly recommend EICO kits to beginners as well as the old timers.

Sincerely,

Milton Stanley
MILTON STANLEY, K9VJH



**90-WATT CW
TRANSMITTER***
#720

Kit \$79.95
Wired \$119.95

*U. S. Pat. No. D-184,776
"Top quality" — ELECTRONIC
KITS GUIDE. Ideal for veteran or
novice. 90W CW, 65W external
plate modulation. 80 through 10
meters.



**NEW!
60-WATT CW
TRANSMITTER**
#723

Kit \$49.95
Wired \$79.95

Ideal for novice or advanced ham
needing low-power, stand-by rig.
60W CW, 50W external plate mod-
ulation. 80 through 10 meters.



**CITIZENS
BAND
TRANSCEIVERS**

Single and

Multi Channel Models Available.
From Kit \$59.95 Wired \$89.95



**HIGH-LEVEL
UNIVERSAL
MODULATOR-
DRIVER**
#730

Kit \$49.95 Wired \$79.95
Delivers 50W undistorted audio.
Modulates transmitters having
RF inputs up to 100W. Unique
over-modulation indicator. Cover
E-5 \$4.50.

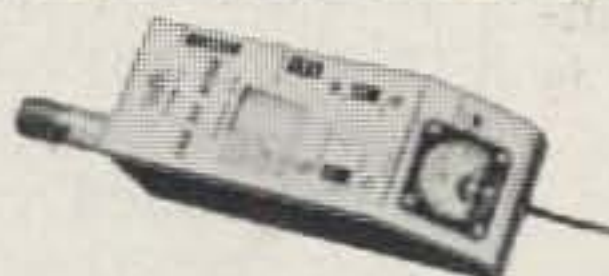

**GRID
DIP
METER**
#710

Kit \$29.95 Wired \$49.95
Includes complete set of coils
for full band coverage. Continu-
ous coverage 400 kc to 250 mc.
500 ua meter.



VACUUM TUBE VOLTMETER #221
Kit \$25.95

**PEAK-TO-PEAK
VTVM #232
& *UNI-PROBE®**
Kit \$29.95
Wired \$49.95

*U. S. Pat. No. 2,790,051



**COLOR &
MONO DC-5MC
LAB & TV 5"
OSCILLOSCOPE**
#460

Wired \$129.50
Kit \$79.95

5" PUSH-PULL OSCILLOSCOPE
#425 Kit \$44.95 Wired \$79.95

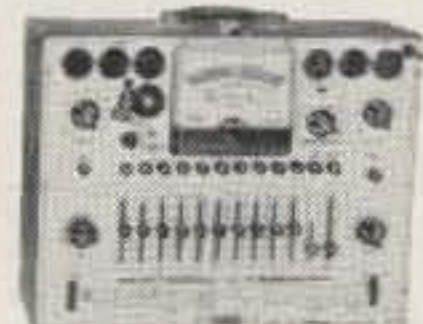

**DYNAMIC
CONDUCTANCE
TUBE
& TRANSISTOR
TESTER #666**

Kit \$69.95 Wired \$109.95
TUBE TESTER #625
Kit \$34.95 Wired \$49.95



**RF SIGNAL
GENERATOR**
#324

(150kc-435mc)
Kit \$26.95
Wired \$39.95

TV-FM SWEEP GENERATOR
& MARKER #368
Kit \$69.95 Wired \$119.95



3300 Northern Blvd.
Long Island City 1, N. Y.

EICO, 3300 N. Blvd., L.I.C. 1, N. Y.

Send free Catalog & name of
neighborhood distributor.
 Send free "Short Course for
Novice License." Send
36-page STEREO HI-FI GUIDE:
25c enclosed for postage
& handling.

Name.....

Address.....

City.....

Zone.....

State.....

Add 5% in the West.

730

ENGINEERS: Excellent career opportunities in creative electronics design. Write to the Chief Engineer.

(Editorial from page 4)

It is not even necessary to produce two doctors and one minister as evidence that you need immediate remuneration. Our Handy Guide on How To Sneak Things By The Editor is available at the bargain price of free if you send a self-addressed stamped (we're not only lazy, we're cheap) envelope. Mark it "Style Sheet" so you won't be flooded with ditto printed trivia from the editor as promised back in March.

Feedback

Doggone if you all didn't surprise me this time. We had so many articles in the March issue that the votes were rather more scattered than usual. It was, however, nip and tuck all the way along between the Transistorized GDO by W3KET, Build-Save-Learn-Have Fun by W8VVD, and Up Front by the Staff. The winner by one lone vote was W8VVD who gets a check for another 50% payment on his article as a reward for your enthusiasm. W3KET made second, proving again that transistors are of great interest. The Kyle All Band Antenna placed 4th and Ignition Interference placed 5th. All had heavy voting.

The combination voting card and readers' service card in the April issue has greatly increased the voting. To date, with only a few hundred cards in, Nuvistor Converter by K8BYN and Noise Limiter by K5JKX/6 are neck and neck at about 200 votes each. Not too far behind is the big technical article again. This seems to make one of the top spots each month, guess we'll have to continue the series and maybe run two per issue eventually.

Tear the card out of this issue and send it in right away. This will serve several purposes: your magaizne will be easier to read with that confounded card torn out; we'll find out how you feel about the articles in this issue and be governed accordingly; and our advertisers will expectantly send you whatever literature or catalogs you request. If the response is good they may buy you more pages of magazine for next month.

... W2NSD

Subscription Rates

While we do not consider a subscription blank an absolute necessity for starting or renewing your subscription, it may simplify matters for you. We have bound one in his issue so it is not necessary to rip your copy of 73 all to shreds. Rates: \$3 per year; \$5 two years; DX operators \$4 per year. Back issues: 50¢ each. Subscriptions start from current issue only.

DESIGN

STRENGTH

DEPENDABILITY

NO GUYS

NO GUYS

A TRIBAND BEAM AT 60 FT -

THREE REASONS WHY YOUR BEST BUY IS...

E-Z WAY
Satellite "60"

E-Z WAY AERO-DYNAMIC design decreases wind load and provides telescoping action that permits raising and lowering of tower sections. **CRANK UP TO 60 FEET, DOWN TO 25 FEET and TILTS OVER FOR ACCESS TO ROTOR OR BEAM.**

STRENGTH is built-in to every E-Z Way Tower...Heavy wall steel tubing legs, continuous diagonal bracing of solid steel rod and electrically welded throughout...no loose bolts or nuts here. E-Z Way design and strength are your assurance of **DEPENDABILITY** that you can count on year after year. See your nearest distributor today or write for free literature.

The SATELLITE

Model RBX-60-3P (Painted) \$335.00
Model RBX-60-3G (Galvanized) \$410.00

MOUNTING KITS:

GPK X60-3 (Ground Post) \$125.00
BAK X (Wall Bracket) \$17.00

Freight Prepaid anywhere in (48) U.S.A.

E-Z WAY

©

HOWERS

INC.

P. O. BOX 5767

TAMPA 5, FLA.

BULLSEYE BUYS at ARROW!

AMERICAN GELOSO V.F.O.'s

Wired, tested, calibrated, ready for use. Mod. 4/104 for driving one 807 or 6146 final in AM or CW under Class "C" conditions.

Mod. 4/102 for driving two 807's or 6146's final. Has 5 bands. Supplied with Mod. 1640 dial ass'y.

Mod. 4/103 for 144-148 mc bands. Combines VFO primary freq. of 18 mc with xtal fundamental freq. of 12 mc. Supplied with Mod. 1647 dial ass'y.

Mod. 4/104, 4/102 or 4/103 less tubes and xtal, each \$29.95

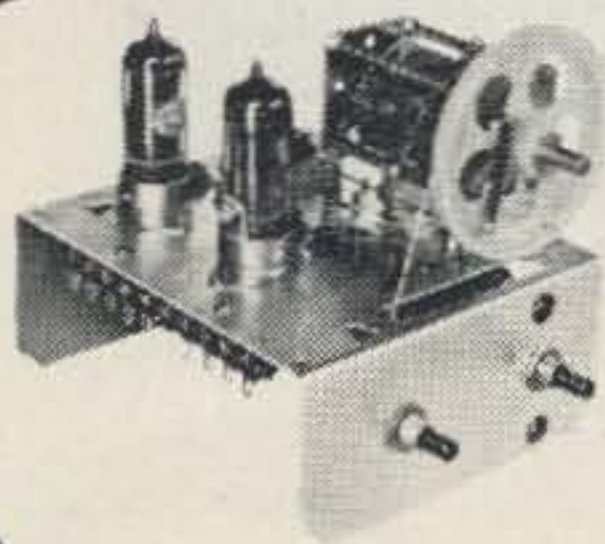

PRECISION PLANETARY-VERNIER

for exceptionally fine tuning

Superb craftsmanship by Jackson Bros. of England. Ball bearing drive, 1/4" dia. shaft, 1 1/8" long, 6:1 ratio, v y FB for fine tuning. Easily adaptable to any shaft. Comparable value — \$5.95.

Amateur Net \$1.50 ea.
10 for \$13.50

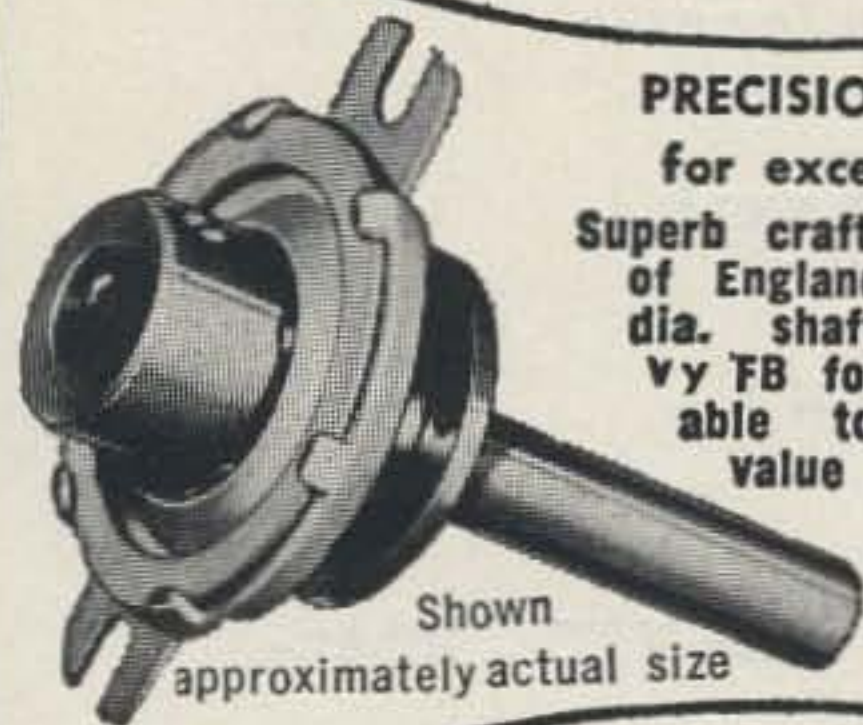

Shown approximately actual size



"Wonder Bar" 10 Meter Antenna

As featured in Nov. 1956 QST. Complete with B & W 3013 Miniductor. Only 8 ft. long for 10 meters. Wt. 5 lbs.

Amateur Net \$7.85



Versatile Miniature Transformer

Same as used in W2EWL SSB Rig — March 1956 QST. Three sets of CT windings for a combination of impedances: 600 ohms, 5200 ohms, 22000 ohms. (By using center-taps the impedances are quartered.) The ideal transformer for a SSB transmitter. Other uses: interstage, transistor, high impedance choke, line to grid or plate, etc. Size only 2" h. x 3/4" w. x 3/4" d. New and fully shielded.

Amateur Net \$1.39

3 for \$3.49 10 for \$10.75
ARROW Authorized distributor of HEATHKIT equipment

AMECO 2 & 6 METER CONVERTERS

Crystal Controlled
Gain: over 30 db
Noise Figure: better than 4 db



Tube Lineup: 2 meter Converter has new, imported 6ES8 high gain, low noise, cascode 1st RF Amp., 6U8A 2nd RF Amp. & Mixer, 6J6 Osc.—Multiplier.

6 meter Converter has 6B8S Cascode RF Amp and 6U8A Mixer and Osc.

Converter complete with tubes and xtal for 7-11 or 14-18 mc. IF output in Kit form with instructions
Wired and tested

	6 meter	2 meter
Kit form with instructions	CB-6 \$19.95	CB-2 \$23.95
Wired and tested	\$27.50	\$33.95

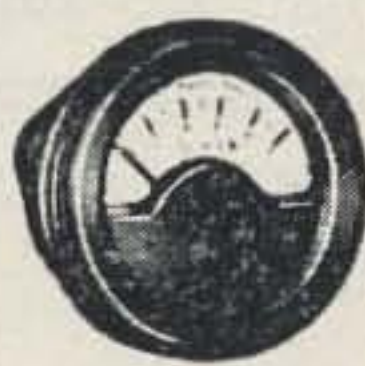

Sub-Miniature 0-200 Microampere Meter

A high quality instrument made by International Instrument Co. (Model 100). Only 1" in diam. Ideal for limited space applications. A natural for transistorized grid dip oscillator as described in QST.

\$3.95 ea.

AMERICAN GELOSO PI TUNING COILS

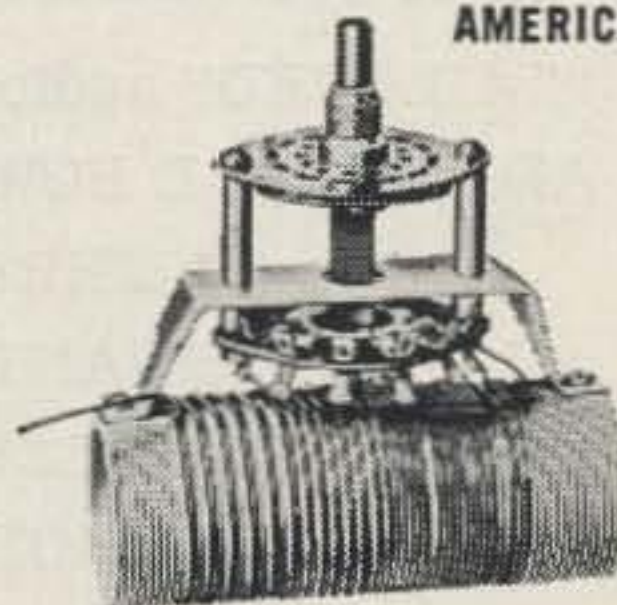

Units have 6 posit. tap switch mounted on ceramic coil form. Mod. 4/111 designed for use with two 807's or 6146's (in parallel). Freq. Range 3.5 to 29.7 mc. Mod. 4/112 is designed for use with single 807 or 6146. Handles up to 60 w. Range: 3.5 to 29.7 mc. Mod. 4/111 or 4/112, each \$4.95

MAIL ORDERS PROMPTLY PROCESSED
SAME DAY SHIPMENT FROM STOCK

ARROW ELECTRONICS, INC.

65 Cortlandt Street, New York 7, N. Y. • Dlgy 9-4730
525 Jericho Turnpike, Mineola, N. Y. • Ploner 6-8686

SAY YOU SAW IT IN 73

TO SAVE C.O.D. CHARGES, PLEASE INCLUDE SUFFICIENT POSTAGE WITH YOUR ORDER. ANY EXTRA MONEY WILL BE RETURNED.

ALL PRICES F.O.B. N. Y. C.
Arrow's Export Dept. Ships To All Parts Of The World!
Prices Subject To Change Without Notice.

Central Electronics

Famous for

**DYNAMIC
PUNCH**



ANNOUNCES
THE NEW
200V
BROAD-BAND
Exciter-Transmitter



NEW FEATURES IN THE 200V

Amateur net... **\$795**

- NEW! Silicon rectifier power supply. Better regulation. Less heat. Higher voltage. 200 watts PEP input on SSB.
- NEW! Frame grid (6EH7-6EJ7) mixers. Extremely high gain Less heat. Unwanted mixer products down in excess of 50 DB.
- NEW! Temperature compensated crystal oscillator circuits for extreme, long term stability.
- NEW! Increased mike pre-amplifier gain. Compensates for weak voices or low output microphones.
- NEW! Smooth as silk two speed tuning knob with 5 KC per turn vernier tuning ratio.

**PLUS
THESE
ORIGINAL
FEATURES**

COMPLETELY BROAD-BANDED. You tune only the VFO . Inherently matches output impedances of 50-72 ohms.
COMPLETE BAND COVERAGE. ALL of the 80-40-20-15-10 meter bands, plus generous overlap and position for extra band.
INPUT 175 watts on CW, FSK and PM. 100 watts on AM.
"TAILORED" audio filter-Audio limiter.
ADJUSTABLE POWER OUTPUT control. 2" **MONITORING SCOPE.**
CALIBRATION ACCURACY better than 1 KC.
UNWANTED SIDEBAND SUPPRESSION 50 DB.
CARRIER SUPPRESSION at least 50 DB.
HARMONICS down in excess of 50 DB.
Third order **DISTORTION PRODUCTS** down in excess of 40 DB.

THERE IS
NOTHING
FINER THAN
THE
200V

EASIER TO OPERATE THAN EVER! Choice of USB-LSB-AM-PM CW-FSK at the flip of a switch. Perfected VOX, PTT, CW breakin 4 ways to key.

Available soon - write for literature.

Central Electronics, Inc.

1247 W. Belmont Ave.

Chicago 13, Illinois

A subsidiary of Zenith Radio Corp.



The Gee Four Zed Smith

*A compact,
lightweight,
remotely tuned
tri-band beam*

Hartland B. Smith W8VVD
467 Park Avenue
Birmingham, Michigan

How would you like to own a beam with these important characteristics?

1. It is light in weight, under 10 pounds, to be exact.
2. It is strong enough to withstand the high winds and icing conditions encountered during winter months.
3. The turning radius is less than 11 feet.
4. It has no traps or loading coils, items which are difficult to design, construct and adjust without extensive lab and shop facilities.
5. Each element can be tuned by remote control, right from the shack.
6. It performs satisfactorily on 14, 21 and 28 mc.
7. Best of all, the cost is surprisingly low.

The antenna at my QTH boasts all of these important features. The how and why of its construction are set forth in the following paragraphs.

Although plans for a great many different beams have appeared in ham publications during the last twenty years, none of these quite seemed to fit my needs. The one which came closest, however, was the G4ZU antenna described by Dick Bird in the *RSGB Bulletin*, *CQ*, *Revista Telegrafica*, etc. I decided that with a few changes and modifications, the G4ZU could be made to meet every one of my specifications.

Those of you who are unfamiliar with the design and theory of the G4ZU should refer to Fig. 2 which shows a popular version of this ingenious aerial. A twin boom supports the elements. The director, cut for the 28 mc

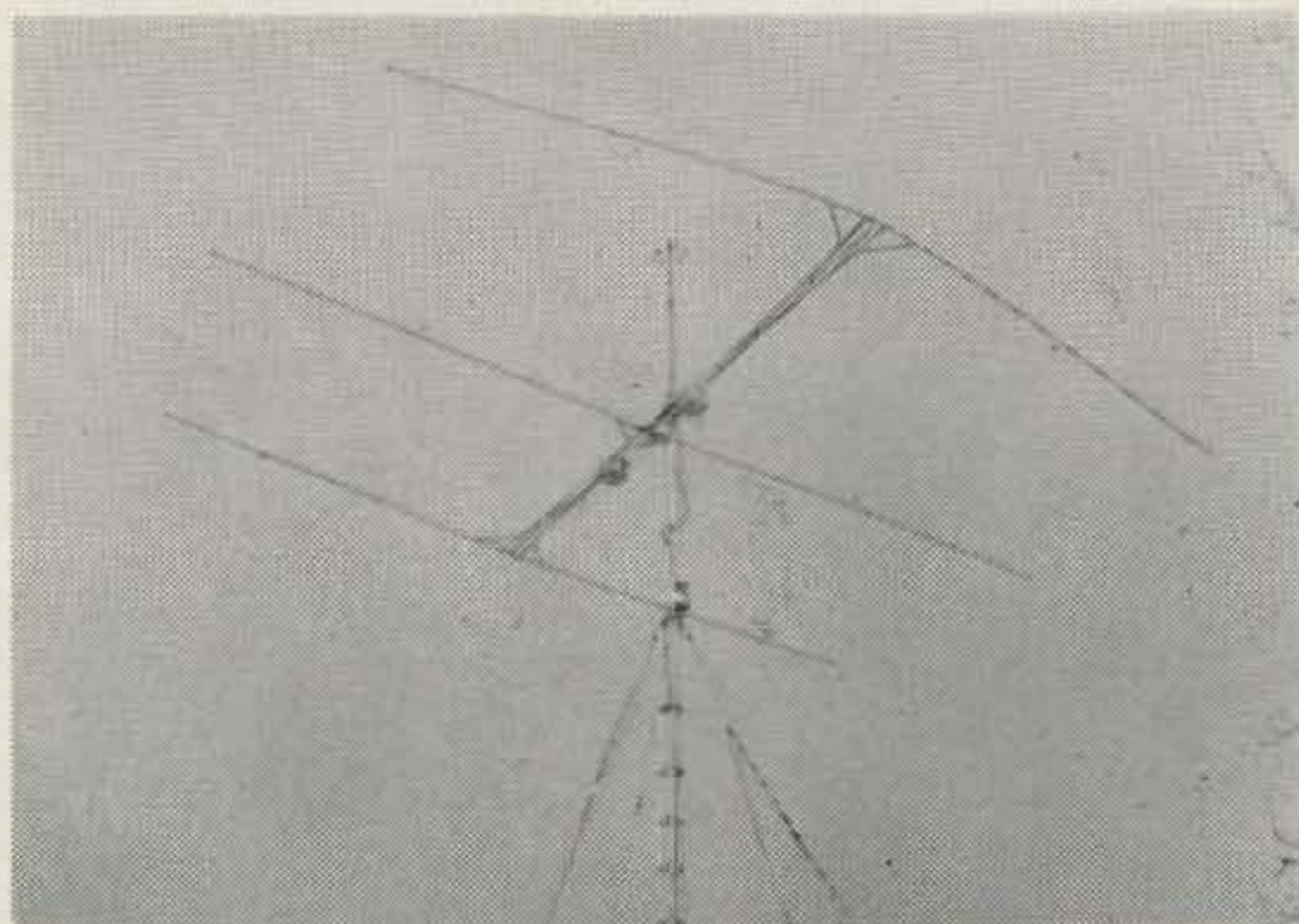

Fig. 1. You probably can't see the wire danglers on the end of each element to reduce the overall size of the Gee Four Zed Smith three band beam.

band, is split at its center where a 28 mc open quarter wave stub is connected. The stub acts as a short circuit at 28 mc. Consequently, for all practical purposes, the director appears as though it isn't split at all. On 21 mc, however, the stub is no longer a short circuit. 21 mc energy cannot jump the gap in the director and so it must detour down the boom to the 21 mc shorting bar and then proceed out the other leg of the boom to the rest of the director. That portion of the boom between the director and the 21 mc shorting bar acts as a 1 turn coil which loads the director for 21 mc operation. Thus, the director is active on both the 28 mc and 21 mc bands.

The driven element is insulated from the boom and is fed with open wire line. It is an ordinary dipole at 21 mc. On the 28 mc band it appears as two shortened collinear elements, while on 14 mc it works as a single short dipole.

The 21 mc reflector, like the director, is split at its center. A 21 mc quarter wave open stub acts as a short across the break on 21 mc. At 14 mc, the stub is no longer effective and so rf energy must detour down the boom to the 14 mc shorting bar. As with the director, this arrangement provides a loading effect which resonates the reflector on 14 mc.

The beam acts as a two element affair on 20 meters with a radiator and reflector. Despite its smaller than normal size for a 20 meter antenna, performance on this band is quite good, especially if care is exercised in the tuning process. On 15 meters, the G4ZU

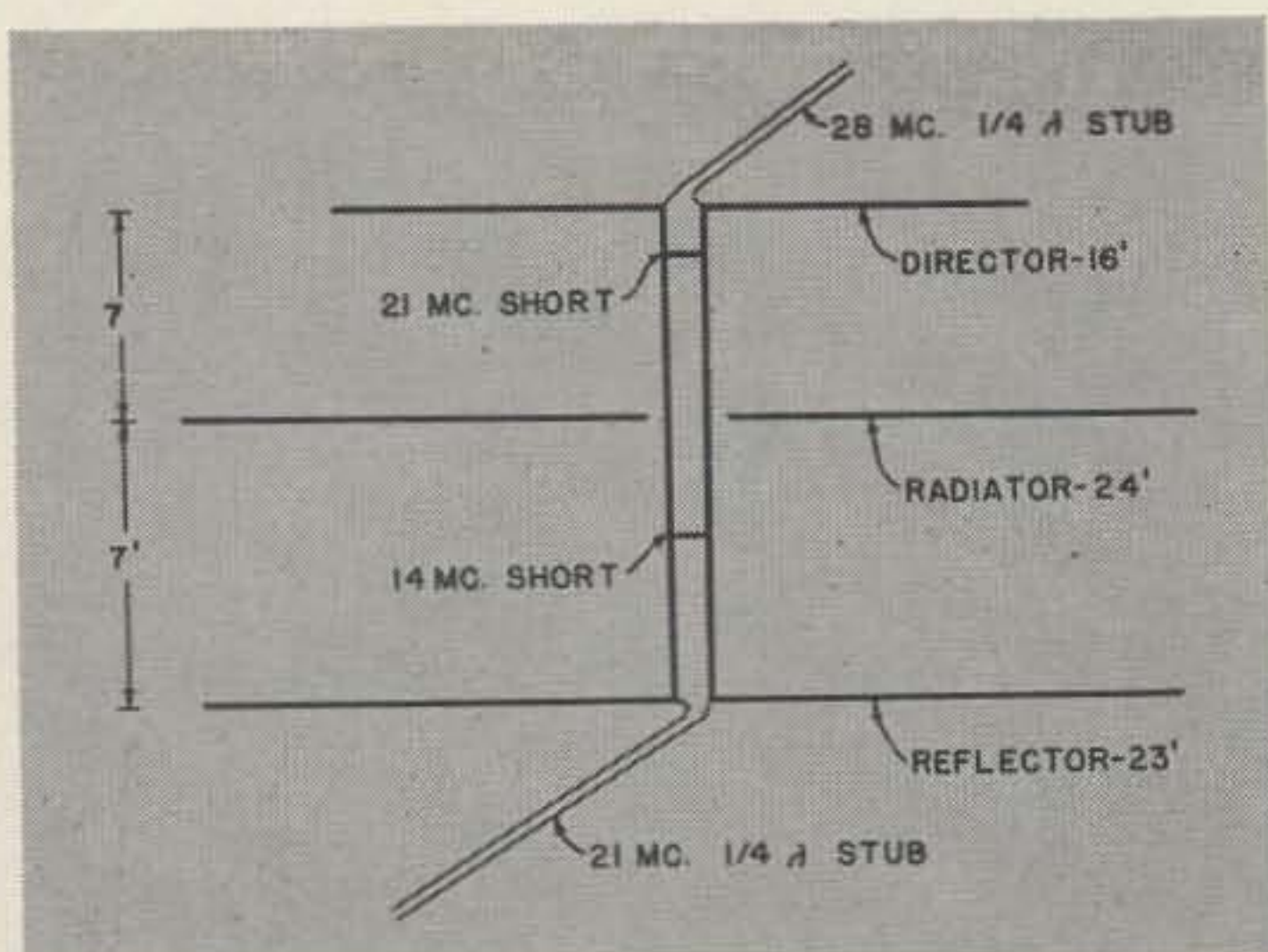

Fig. 2. Standard G4ZU beam.

performs as a 3 element beam with a full length reflector and a loaded director. Although only the radiator and director would appear to operate at 28 mc, the beam is more effective than an ordinary two element 10 meter aerial. According to G4ZU, this is because a significant amount of gain is contributed by the collinear configuration of the radiator. Additional 10 meter directivity is provided by the 20 meter reflector which acts as a non-resonant passive element. If you are interested in learning more about the theory behind this particular type of beam I suggest that you consult some of the references listed at the end of the article.

Because self-supporting elements must be fairly husky, I concluded that a standard G4ZU would be too heavy for my flimsy 36 foot dural mast. Consequently, I built my version out of 1/2 inch aluminum tubing held up by umbrella type guys. Although I used half hard tubing because it was given to me without charge, an ST alloy would be preferable since it has less tendency to take on a permanent bend in a severe wind storm.

In order to support the light weight elements, I extended the rotating shaft and ran guy wires from the top of the shaft to the elements and to the ends of the boom. The guy wires were insulated with electrical tape where they touched the shaft and the elements. The wires were also broken with plastic insulators to keep them from resonating at 10, 15 or 20 meters. If you examine Fig. 1 closely, you'll note that the guys tend to give the director and reflector a somewhat bowed appearance. Since element spacing is not critical, the effect on performance of this slight distortion is insignificant.

Even though the longest element of the standard G4ZU measures only 24 feet, I have tree problems which won't permit me to swing a beam of that size. For this reason I found it necessary to keep the horizontal spans of the radiator and reflector down to 18 feet. I fastened solder lugs to each end of these two elements with sheet metal screws. Wire danglers were then soldered to the lugs to

make up the balance of the required electrical length. Strain on the soldered joints was minimized by insulating each dangler with electrical tape for a distance of about 3 inches from its associated lug and then wrapping the dangler once around the end of the element. To prevent moisture induced corrosion, the entire area around the solder lug was well taped. I used ordinary bare twisted antenna wire for the danglers.

Since the driven element is self resonant only on 15 meters, a tuned feedline is required for three band operation. Rotation is no problem if one end of a 4 foot length of tubular twinlead is connected to the radiator and the opposite end is fastened to a 2 inch open wire line which runs from a point near the top of the mast down into the shack. The tubular lead can twist and squirm during rotation without any danger of shorting out or significantly changing impedance.

Don't worry about TVI being accentuated by the open wire line. The antenna tuner which is required by this style of feeder definitely

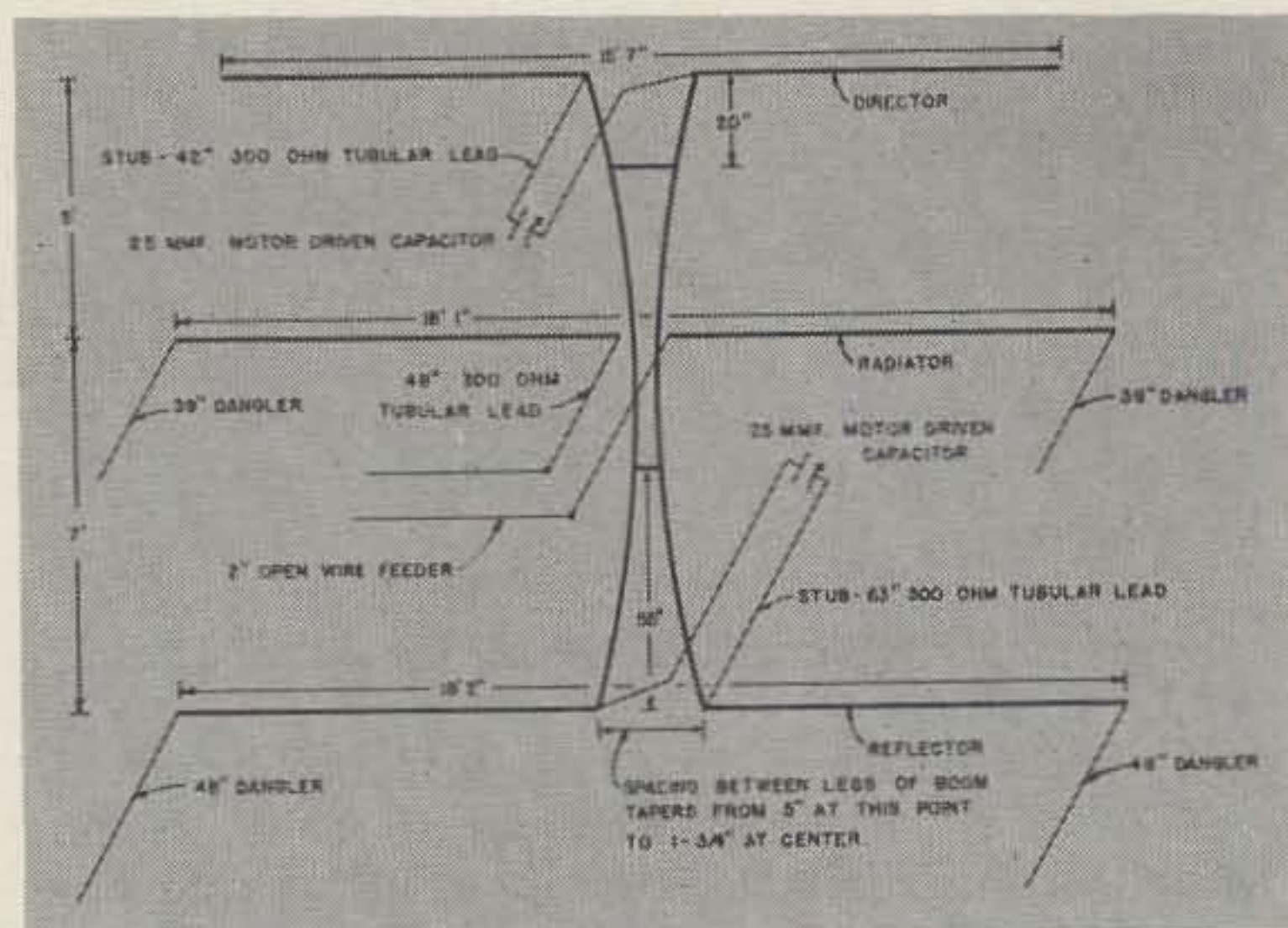

Fig. 3. Gee Four Zed Smith beam.

discriminates against harmonics which might escape from the low pass filter at the output of the transmitter. Line pickup and radiation apparently are insignificant because, as the beam rotates while the receiver is tuned to a steady signal, the S meter drops almost to zero on the ends and to a low value off the back.

The driven element may be peaked on any frequency in the 14, 21 or 28 mc bands by merely twisting a couple of knobs on the tuner which can be located near the operating position in the shack. Some other method, however, must be provided to remotely adjust the director and reflector. I chose 1 RPM timing motors to do the job. These are actuated by S4 and S5, toggle switches mounted on the panel of the antenna tuner. Suitable motors are listed in a number of mail order bargain flyers. Duplicates of the ones I used can be obtained for \$1.25 each from Herbach and Rademan, Inc., 1204 Arch St., Philadelphia 7, Pa. Ask for catalog number TM4212X.

INTERNATIONAL 1961 CATALOG

FREE



Your
BUYING GUIDE FOR
PRECISION RADIO CRYSTALS
AND QUALITY ELECTRONIC EQUIPMENT.

- COMMERCIAL CRYSTALS • AMATEUR AND
CITIZENS BAND CRYSTALS • AUTO
RADIO CONVERTERS • OSCILLATORS • FREQUENCY
ALIGNMENT EQUIPMENT • TRANSMITTERS
• MODULATORS • POWER SUPPLIES
- TRANSISTOR SUBASSEMBLIES • CITIZENS
BAND TRANSCEIVERS • CITIZENS
BAND ANTENNAS/ACCESSORIES

Specialists in precision radio crystals, Citizens 2-Way radio equipment, and quality electronic products.

INTERNATIONAL
CRYSTAL MANUFACTURING CO., INC.

18 NORTH LEE • OKLAHOMA CITY, OKLA.

AMATEURS —

Complete data on International's all transistor subassemblies; 6 and 2 meter transmitting and receiving gear; crystal controlled converters for 75, 40, 20, 15 and 10 meters.

CITIZEN LICENSEES —

International transceivers, accessories and antennas for dependable 2-Way radio communication. See International's kit for constructing your own Citizens transceiver.

EXPERIMENTERS —

Printed circuit oscillators, RF converters, IF units, audio units, transistor subassemblies, crystals and crystal ovens.

Mail today for your **FREE Catalog!**

International Crystal Mfg. Co., Inc.
18 North Lee, Oklahoma City, Okla.
Send Free 1961 International Catalog

Name _____

Address _____

City _____ Zone _____ State _____

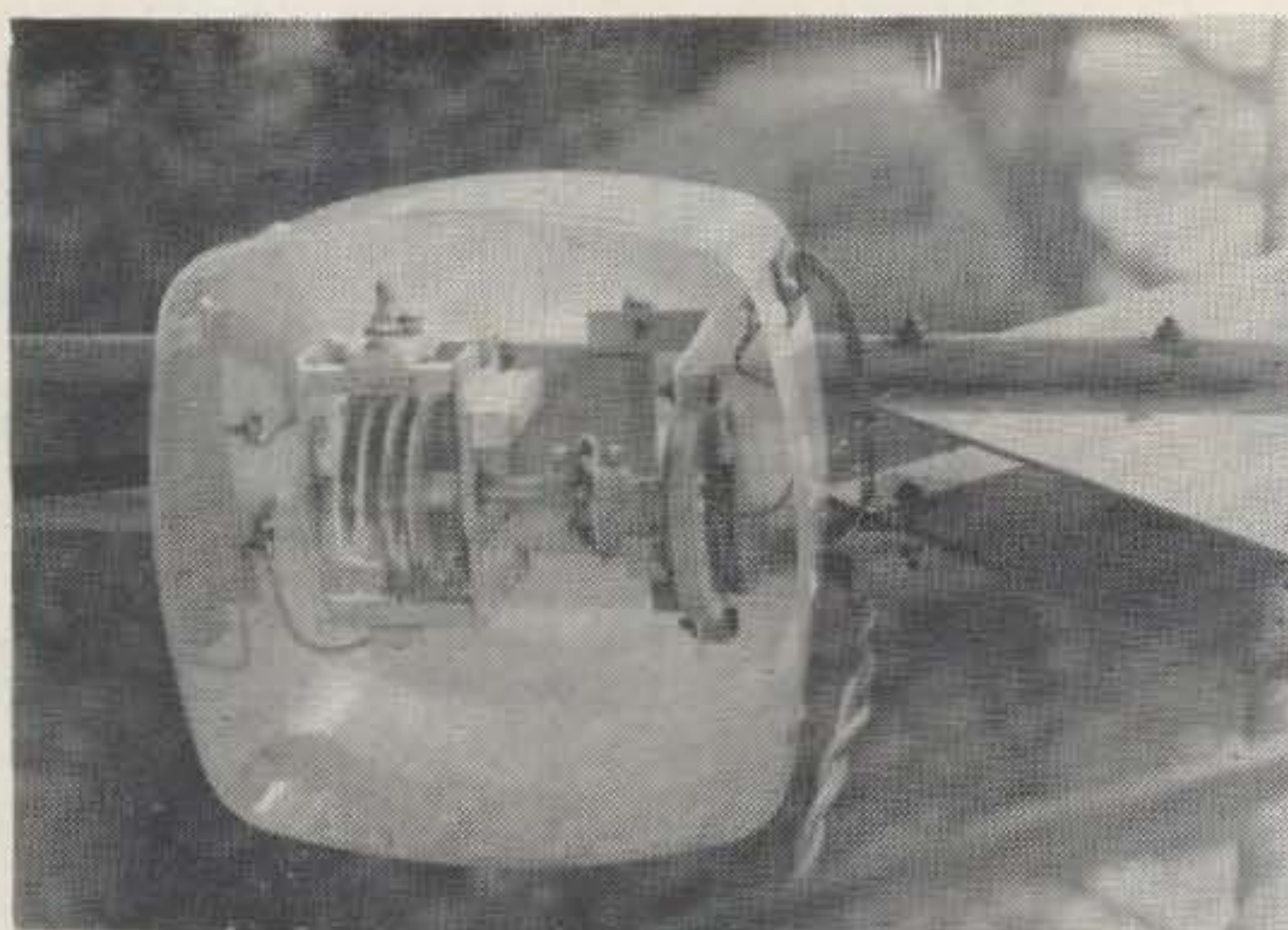

Fig. 4. Plastic ice-box dishes protect the element tuning capacitors and motors from rain and snow. $\frac{1}{4}$ " shafts, soldered to the output gears of the motors, drive the capacitors via insulated couplings.

The motors drive variable capacitors which are wired across the open ends of the director and reflector stubs. The stubs, cut from Belden type 8275 foam filled 300 ohm twinlead, are made somewhat shorter than an electrical quarter wave and are then loaded by the variable capacitors. As these capacitors are tuned, the resonant frequencies of the director and reflector change to a noticeable extent. Since the capacitor rotors are not at rf ground potential, bakelite or ceramic insulated shaft couplers must be used between the motors and the capacitors.

A capacity of 25 mmfd and a plate spacing of $\frac{1}{8}$ inch should prove satisfactory for the stub capacitors. No arc-over troubles have developed during two seasons of operating at transmitter powers of 1000 watts PEP SB and 350 watts AM while using capacitors with these specs. Housed in plastic ice box dishes, the capacitors are mounted as shown in Fig. 4, near the center of the boom. The exact positions of these containers depend on the lengths of the director and reflector stubs which run between their respective elements and the motor driven capacitors. The stubs can be supported below the boom by small standoffs cut from $\frac{1}{4}$ inch sheet plastic.

Tape the control wires for the tuning motors to the boom and the shaft. Allow enough slack in them for rotation and then run them down the mast, preferably to the bottom, before taking them into the shack. This procedure will minimize rf pickup on the ac line.

Fig. 5 shows how the elements are mounted on the boom and also how the boom is fastened to the rotating shaft. Ordinary 6-32 bolts and sheet metal screws can be used for hardware, provided they are dabbled or sprayed with Rust-Oleum Primer, No. 769, to discourage rust and electrolysis. Also paint the spots where the reflector, director and shorting bars contact the boom. Apply two coats of good quality spar varnish to the wood dowels which act as element insulators and braces.

Like any other beam, this one must be carefully adjusted before it is mounted permanently atop a mast. Temporarily set it on a step ladder or other support at least 7 or 8 feet off the ground. Point the beam at a field strength meter located more than 100 feet away. Feed 28 mc energy to the radiator. Don't bother with a tuner at this time. Just hook the feedline directly to a low power transmitter. Turn on the director tuning motor. Trim the director a few inches at a time until the maximum field strength reading occurs when the plates of the director tuning capacitor are half meshed. Switch to 21 mc and set both motor driven capacitors to mid-range. Adjust the position of the director shorting bar and the length of the reflector danglers for the best meter deflection.

Rotate the antenna 180° or until the reflector is nearest the field strength meter. With 14 mc energy applied to the radiator, position the reflector shorting bar for a minimum field strength meter reading. Recheck several times on 28, 21 and 14 mc to make sure that adjustments for one band haven't seriously upset those of another. As soon as maximum forward gain on 28 and 21 mc and minimum back radiation on 14 mc all occur when the stub capacitors are half meshed, you can hoist the beam to its final location.

The antenna tuner is a bandswitching affair built into an 8" x 10" x 12" utility box. The coil dimensions and tap positions shown in the schematic are the ones which worked out best at my particular QTH. These values have been included only as a guide. Due to differences in feeder length and antenna height, you'll undoubtedly have to experiment a little to discover the best coil and tap adjustments. This procedure, however, won't be very difficult be-



Fig. 6. The antenna tuner, reflected power meter and motor controls are housed in an 8" x 10" x 12" cabinet.

cause a reflected power meter is included as a permanent feature of the tuner.

L1 is a 12" length of RG8U co-ax which has been modified to serve as a pickup line for the reflected power meter. It is prepared by first slitting and then removing the outer



HERE'S A NEW HEATHKIT® GROUNDED GRID KW LINEAR...JUST \$229⁹⁵

The new Heathkit "Warrior" is a completely self-contained, desk-top kilowatt linear, loaded with special features, at half the cost of comparable units! Compare feature for feature, quality component for quality component, you'll find no shortcuts . . . only the finest watt-per-dollar value in a linear amplifier on the amateur market today!

Maximum power input: SSB—1000 watts P.E.P., CW—1000 watts, AM—400 watts (500 watts using carrier controlled modulation), RTTY—650 watts. **Driving power required:** 50 to 75 watts—depending on frequency. **Output circuit:** Variable pi-network (50 to 75 ohms). **Input circuit:** Broad banded—requires no tuning. **Input impedance:** Approx. 70 ohms. **Band coverage:** 80, 40, 20, 15, 10 meters. **Panel metering:** Switch-selected, grid current, plate current, high voltage and relative power output for ease of loading. **Tube complement:** 4-811A, 2-866A. **Size:** 19½" W x 11¼" H x 16" D.

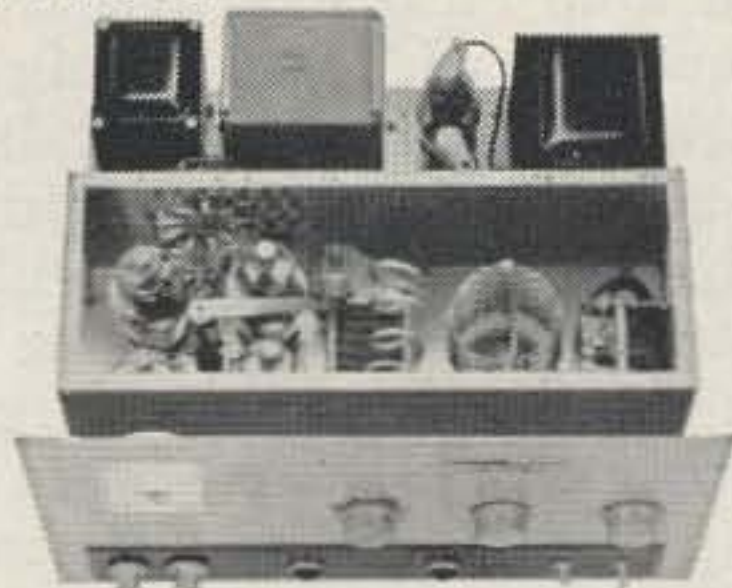

This inside view shows the neat circuit layout and husky components that emphasize quality. Note the internal shielding of plate circuit for maximum protection against TVI.

CHECK THESE FEATURES . . .

- Completely self-contained . . .* HV, Fil. and Bias supplies built in.
- Versatile . . .* May be driven by any 50 to 125 watt transmitter or exciter—no matching or swamping network required.
- Efficient . . .* Stable grounded grid circuitry allows most driving power to appear in output for up to 70% efficiency.
- Oil-filled capacitor . . .* And 5-50 henry swinging-choke provide the excellent dynamic regulation required for high peak power output with low distortion.
- Inexpensive tubes . . .* 4 paralleled 811A's and 2-866A's, forced-air cooled by silent built-in fan.
- Stable . . .* carefull design provides a high degree of over-all stability in conjunction with the grounded grid circuit configuration.
- Exclusive . . .* Internal RF shielding of plate circuit for maximum TVI suppression.
- Interlocked switching . . .* prevents accidental application of HV before switching on filament and bias.
- Rugged construction . . .* 16 gauge steel chassis—¼" aluminum front panel—welded one-piece cabinet.

Kit Model HA-10 . . . 100 lbs. \$23 dn., \$20 mo. **\$229.95**

Assembled Model HAW-10 . . .
100 lbs. \$33 dn., \$28 mo. **\$329.95**

FREE CATALOG

Send today for your Free Catalog describing over 200 different Heathkit products in Hi-Fi, Test, Amateur Radio, Marine and General consumer fields.



HEATH COMPANY

Benton Harbor 11, Michigan

Please send my Free copy of the complete Heathkit Catalog.

NAME _____

ADDRESS _____

CITY _____

ZONE _____

STATE _____

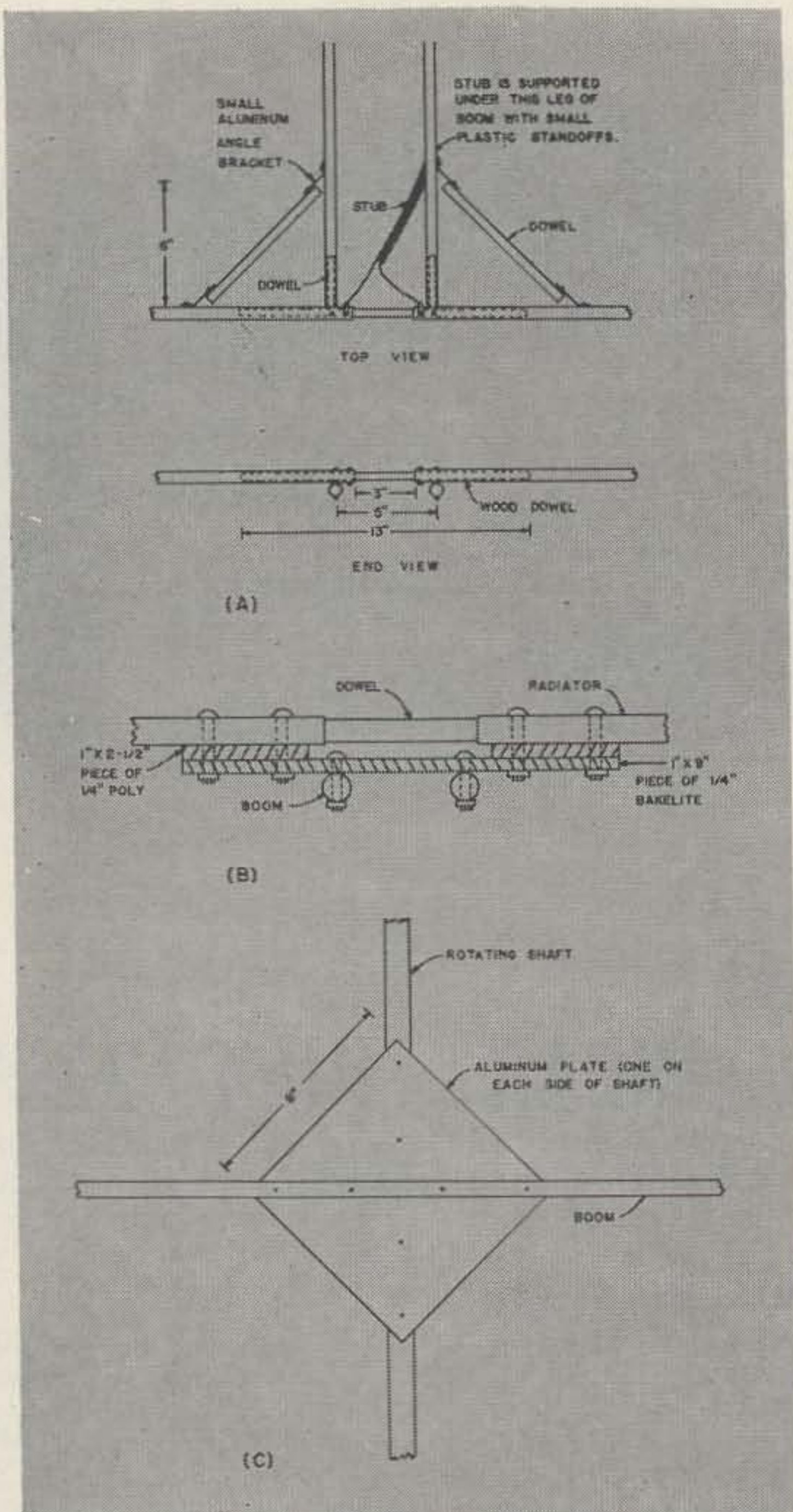

Fig. 5. (a) Method for mounting the parasitic elements to the boom. (b) Method for insulating the radiator from the boom. (c) Two square aluminum plates are used to fasten the boom to the rotating shaft.

vinyl jacket of the co-ax. About a half inch from each end of the section of co-ax, make holes in the exposed shield braid by means of an ice pick or the blade of a small screw driver. Thread a piece of fine wire through one hole and then along under the shield, next to the poly insulation, and then out the other hole. This can be most easily accomplished if you shorten the braid by pushing on each end so that it bunches up near the center of the co-ax. No. 30 enameled wire may be used if you are careful not to break the insulation during the threading process. I employed very fine plastic covered wire for the purpose. After the wire has been threaded through, stretch the shield out again until it assumes its original length. Replace the vinyl jacket on the co-ax and spiral wrap it with electrical tape.

The exact value for R1 must be found by

experiment. Temporarily disconnect the wires which run from S1A to the 10 and 15/20 meter links, L3 and L5. Attach a dummy load between the movable arm of S1A and ground. The impedance of this dummy should match the output impedance of your transmitter or low pass filter. Use only non-reactive carbon resistors for the dummy. Feed 10, 15 or 20 meter energy from the transmitter into J1. Throw S2 to the FORWARD position and adjust R2 for a full scale reading on M1. Switch S2 to the REFLECTED position and try different values at R1 until the meter reads zero. The correct value for this carbon resistor will probably fall somewhere between 50 and 250 ohms. A carbon potentiometer may be used at this point if you'd rather not fiddle around with fixed resistors while trying to discover how many ohms are required.

After removing the dummy and replacing the L3 and L5 leads on S1A, you can hook the feedline from the beam to output connectors F1 and F2. Set S1 and S3 to 20 meters and S2 to FORWARD. Feed 20 meter energy from your transmitter into J1. Adjust the SENSITIVITY control, R2, until M1 reads full scale. Put S2 in the REFLECTED position and Tune C1 for minimum deflection of M1. Tune C2 and try to reduce the reading of M1 even more. At some combination in the settings of C1 and C2, the M1 reading should drop to zero indicating that the tuner is transforming the feedline impedance to that of the co-ax feeder from your transmitter or low pass filter. If a zero reading cannot be achieved, the 20 meter feedline tap positions on L2 should be changed. Bear in mind that the closer these taps are kept to the outer edges of the coil, the lower will be the circulating current. As a result, there will be less coil heating and power loss. Furthermore, the resonant point of the tuner will be broadened and you'll be able to QSY further from your original frequency without having to retune.

After locating the proper 20 meter tap positions, set S1 and S3 for 15 and make the necessary adjustments on that band.

While setting the tuner up for 10 meters you may find it necessary to stretch out or squeeze together the turns of L5 in addition to changing tap positions on L4 in order to achieve a zero reflected power reading. As soon as the coil taps for the three bands have been permanently located and soldered, you can put the tuner chassis into its case.

To go on the air, merely switch S1 and S3 to the same band as the transmitter. Put S2 in the FORWARD position and set R2 for a full scale reading of M1. Throw S2 to REFLECTED and tune C1 and C2 for a zero meter reading. When going from one band to another you'll find that this tune-up procedure takes only a minute or so. While not quite so convenient as a trap tribander, the Gee Four Zed Smith boasts a very important advantage.



NOW

LPA-1 AVAILABLE IN KIT FORM

The most copied grounded-grid 1-KW linear amplifier by those who build their own.

AMPLIFIER KIT

LPA-1 Kit—(less tubes, cabinet and blower).....	\$269.50
Blower—(optional for warm climate use)	19.95
Cabinet—	48.75
LPA-1 Amplifier—Factory wired and tested Complete with cabinet, blower and tubes	375.00

POWER SUPPLY KIT TOO

LPS-1 Kit—(complete with cabinet but less tubes) .	\$169.50
LPS-1 Power Supply—Factory wired and tested Complete with cabinet and tubes	205.00

(See Nov. QST, page 115 and Nov. CQ, page 21, for outstanding features)



LPA-MU Matching Unit Price \$36.00
LPA-MU-2 Matching Unit Price \$36.50
Factory wired and tested

LPS-1 Power Supply for LPA-1



Barker & Williamson, Inc.

Canal and Beaver • Bristol, Penna.

Foreign Sales—Royal National Corp., 250 West 57th St., New York 19, N.Y.

OTHER B&W EQUIPMENT: Transmitters AM-CW-SSB • Transistorized Power Converters and Inverters • Dip Meters • Matchmasters • Frequency Multipliers • Low Pass Filters • T-R Switches • R. F. Filament Chokes • Transmitting R. F. Plate Chokes • Band-Switching Pi-Network Inductors • Cyclometers • Antenna Coaxial Connectors Baluns • Variable Capacitors • Toroidal Transformers • Coaxial Switches • Fixed and Rotary edgewound Inductors • Plug-in Coils with fixed and variable links • Straight type air wound coils in a variety of dimensions.

It radiates efficiently on only one band at a time. Thus, you need have little worry about putting out a 10 meter harmonic when you're switched to 20 or a 20 meter subharmonic when you're on 10.

The director and reflector can be remotely peaked for optimum performance in the following manner. Put your transmitter on your favorite 28 mc frequency and resonate the tuner by means of the reflected power meter. Turn off the transmitter and tune your receiver to a strong local signal near the same frequency. Point the beam toward the source of this signal. Throw on S4 to actuate the director tuning motor. Let it run until the receiver S-meter is at its highest point. Turn off S4. Switch to 14 mc. After resonating the driven element with the transmitter and tuner, put the back of the beam toward a steady local. Turn on the reflector motor with S5 and allow it to run until the receiver S-meter drops to its lowest value. Normally, if the director is peaked on 28 mc and the reflector is optimized for 14 mc, no 21 mc adjustment of the parasitic elements will be required. However, when you need that last db of gain for a 21 mc sked or to break through to some choice DX, you can touch up both the director and reflector to achieve the best possible per-

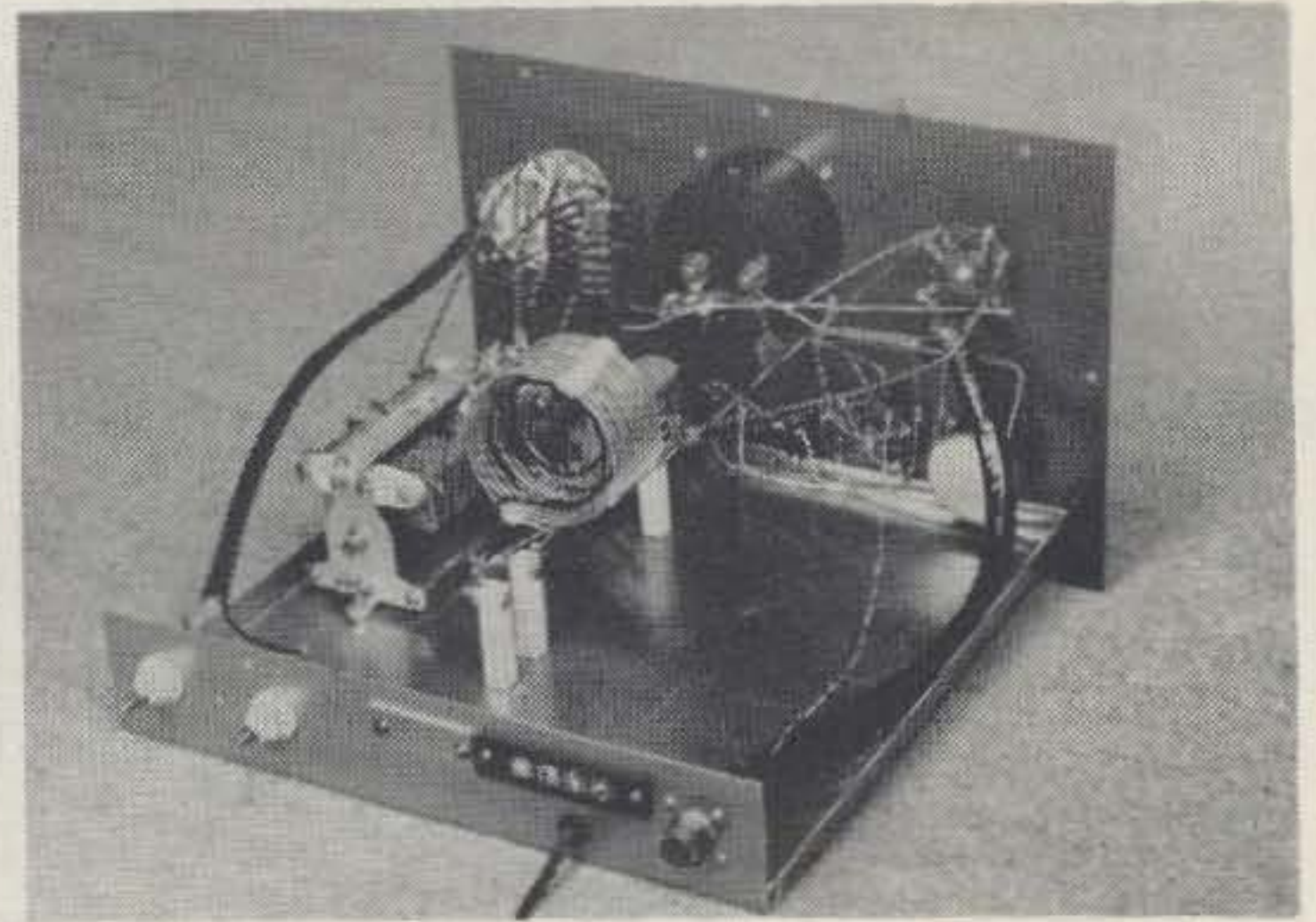
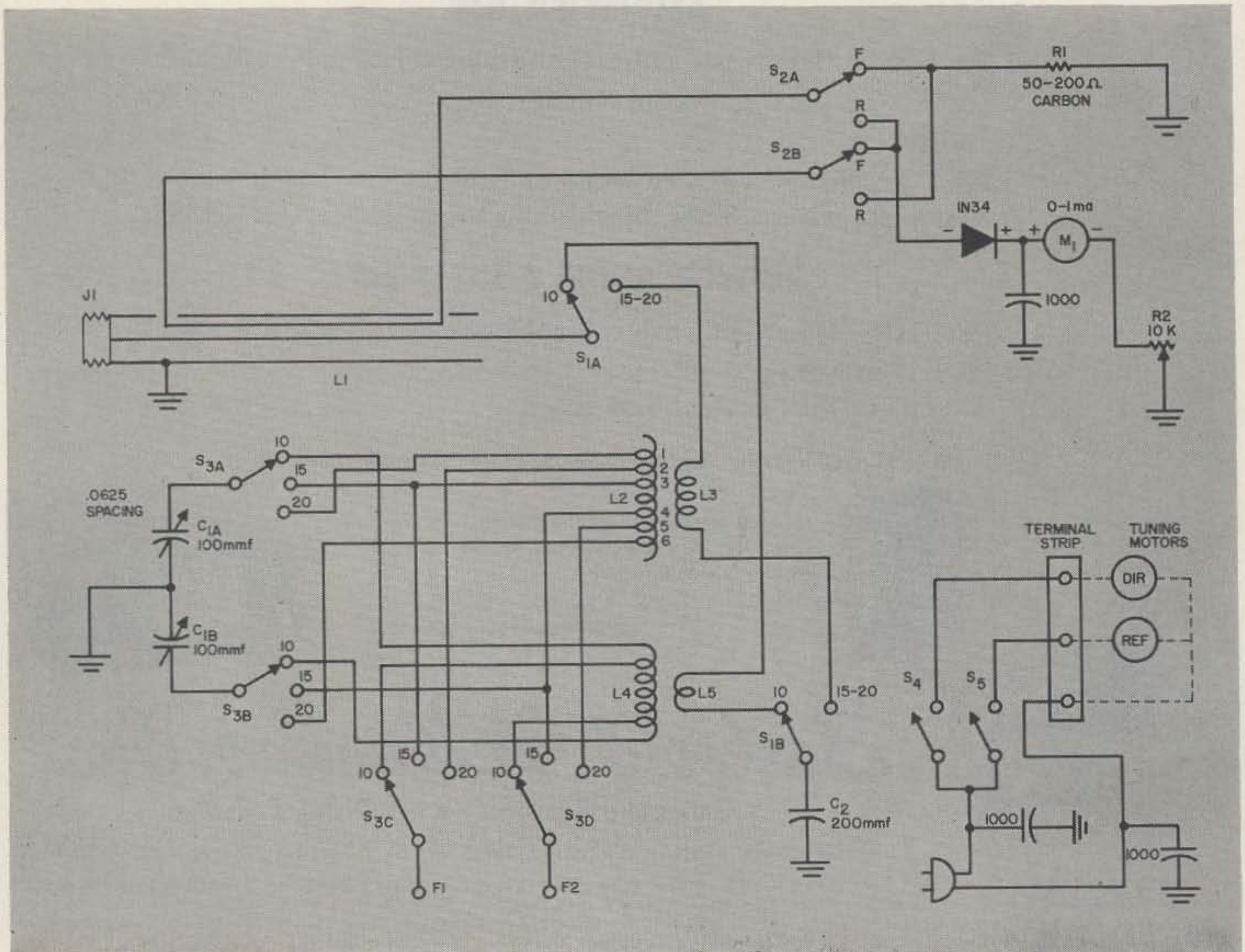

Fig. 7. Rear view of tuner. L1 runs along right hand edge of the chassis. L2 and L3 are to the right of the two gang capacitor C1. L4 and L5 can be seen between the meter and the ceramic bandswitch S3.

formance.

If you live in a sparsely populated area with no nearby hams, use a transistor oscillator located several hundred feet from the shack as a signal source. Although you can check the results of your tuning efforts by feeding power into the antenna and having someone observe the deflection on a field strength meter, this arrangement is much less convenient than

Fig. 8. Schematic of Gee Four Zed Smith antenna tuner.



CW • FSK • FAX *Signals on* SINGLE SIDEBAND

WITH **TMC's** MODEL

TIS-3



Featuring:

**ADJUSTABLE
FREQUENCY SHIFT
DIRECT READING IN
CYCLES**



For further
information
write for
Bulletin No. 245

- HIGH STABILITY, MULTI-PURPOSE AUDIO TONE KEYER
- TRUE FREQUENCY SHIFT BY MEANS OF 200 KC OVEN CONTROLLED OSCILLATOR WITH REACTANCE CONTROL
- VARIABLE FREQUENCY SHIFT, 12 TO 1000 CYCLES
- SELECTABLE CENTER FREQUENCIES FOR FOLLOWING OPERATION:
 - A. 1,900 cps INTERNATIONAL STANDARD FOR FAX TRANSMISSIONS
 - B. 2,000 cps PROVIDES COMPATIBILITY FOR TRANSMITTERS AND RECEIVERS LIMITED TO TUNING IN 1 KC STEPS
 - C. 2,550 cps STANDARD FREQUENCY WIDELY USED FOR 850 CPS SHIFT
 - D. OPTIONAL TO BE CUSTOMER SELECTED
- VOLTAGE OR CURRENT INPUTS
- COMPLETE COMPATABILITY WITH CURRENT FSK SYSTEMS
- 1,000 cps CW CHANNEL (OTHERS AVAILABLE AT CUSTOMERS REQUEST)

THE TECHNICAL MATERIEL CORPORATION
MAMARONECK, NEW YORK

IN CANADA: TMC (Canada) Ltd., OTTAWA, ONTARIO

the received signal method.

Originally designed especially for installation on a flimsy mast, the antenna worked so well during its first season that I decided to keep on using it when I changed to a tilt-over crank-up tower last fall. The 10 and 20 meter front-to-back ratio, according to a nearby 75A4, is about 20 db. On 15 the figure runs between 25 and 30 db.

Although no gain tests have been made, performance on 10 and 15 seems to compare very favorably with that of the average 3 element beam. When my 300 watt is feeding power to the antenna I can work just about every DX station I hear, often on the first call. Once, while using a 120 milliwatt transistorized CW rig, I raised a Puerto Rican without prearrangement. Another time I had a nice phone chat with a JA while running 25 watts to my exciter.

On 20 meters, the antenna provides excellent Stateside QSO's with lots of S9 plus, plus reports. I haven't tried serious 20 meter DXing, however, because it seems rather silly to buck the kilowatt QRM with a condensed 2 element beam, especially since it has proven so easy to get across the pond on 15 and 10.

Tuning changes which result from accumulations of moisture, snow or ice on the elements and feedline can be easily counteracted by a slight readjustment of the remote control circuitry. Even though high winds cause the danglers to flop back and forth a bit there

seems to be no significant degradation of performance in breezes under 50 mph.

If you're cramped for space, have a thinly padded purse or require a beam that's suitable for mounting on a slender TV mast, I suggest that you carefully consider the advantages offered by this modified G4ZU. The fact that you can tune it right on the nose while comfortably seated in the shack is a plus feature well worth the effort required to build it yourself.

Coil Table

- L1—See text.
- L2—10 turns, no. 12 wire, 2½" diam., 1½" long. B-W 3905-1 (Air Dux 2006) Taps 1 and 6, ½ turn from each end. Taps 2 and 5, 1½ turns from each end. Taps 3 and 4, 3½ turns from each end.
- L3—3 turns no. 12 wire, 2" diam., ¾" long, mounted inside L2.
- L4—5½ turns no. 10 wire, 1½" diam., 1" long. Tapped 1 turn from each end.
- L5—3 turns no. 14 wire, 1" diam., ½" long, mounted inside L4.

References

- G. A. Bird, G4ZU—The G4ZU Three Band Minibeam, RSGB Bulletin, February, 1956.
- The Story of the Three Band Minibeam, CQ Magazine, March, 1957, page 20.
- More About the Minibeam, RSGB Bulletin, October, 1957, page 168.
- More About the Minibeam-Part I, CQ Magazine, July, 1958, page 52.
- More About the Minibeam-Part II, CQ Magazine, August, 1958, page 28.
- Robert C. Bunce, K6QHZ—The Mickey Match, QST, November, 1958, page 26.
- R. Lynn Kalmbach, W4IW—A Motor Tuned Beam, CQ Magazine, July, 1959.

Economy?

Bill Roberts W9HOV
House of Antennas

Cheapness alone does not make a bargain.

LOOK at the following table which has been offered by one of the leading cable manufacturers in which they describe the amount of attenuation on their products per hundred feet.

	Attenuation per 100 feet						
	3.5 mc	7.00 mc	14 mc	21 mc	28 mc	50 mc	144 mc
RG8U	0.30	0.45	0.66	0.83	0.98	1.35	2.50
RG58U	0.68	1.00	1.50	1.90	2.20	3.10	5.70
RG11U	0.38	0.55	0.80	0.98	1.15	1.55	2.80
RG59U	0.64	0.90	1.30	1.60	1.80	2.40	4.20
Open wire	0.03	0.05	0.07	0.08	0.10	0.13	0.25

Now, what does all this tell us? First let's say that we are using 100 feet of line (shorter lines and longer lines are proportionate). It is a commonly known thing that a gain of 3 db is equal to doubling of power (therefore a 3 db loss would halve it).

Let's take a hypothetical case where "A" runs 100 watts on 28 mc with a line 100 feet long. The table shows us that there is an attenuation of 0.98 db with RG8U and 2.20 db with RG58U. If a 3 db loss halves your power the 1 db loss with RG8U means you have lost 1/3 of 50 watts, or nearly 14 watts power. With RG58U you have lost 22/30ths or .73 of 50 watts. That figures to about thirty five watts.

Now let's look at it another way. Let's say you have 100 watts and you have chosen RG58U because it is cheap. You have saved a few cents a foot for 100 feet, that is true, but you have doubled your losses. As we have shown, you lose 14 watts with RG8U and 35 watts with RG58U. So you have saved about \$6.00 on cable and you have thrown away 21 watts. At higher levels it is even more outstanding because the wattage goes up and the savings (??) stay the same.

With the cost per watt of present day transmitters it sure is poor economy to save money by buying less expensive coax. Moral—use the heaviest cable you can afford, or use open line if you have the nerve. . . . W9HOV

THE LAFAYETTE ROUNDUP OF HAMSHACK VALUES



MODEL HE-26 HYBRID PHONE PATCH

Perfect for AM-SSB Phone Patch operation. VU Meter monitors line level for Q5 phone patches. An unmatched low—

24.50



37.50

HE-28 RF WATTMETER AND SWR BRIDGE

150 watts full scale—Built-in dummy load—Wattmeter $\pm 5\%$ to 54 mcs. SWR $\pm 5\%$ for in line use.

MODEL TM-15 WAVE METER

Checks transmitter output for harmonics, parasitics, and out-of-band operation. Provided with magnetic feet. Perfect for the novice.



8.95

MODEL TM-14 FIELD STRENGTH METER

Complete, no wires to connect. Monitor transmitter output, check antennas, etc. Perfect for mobile, provided with magnetic feet.

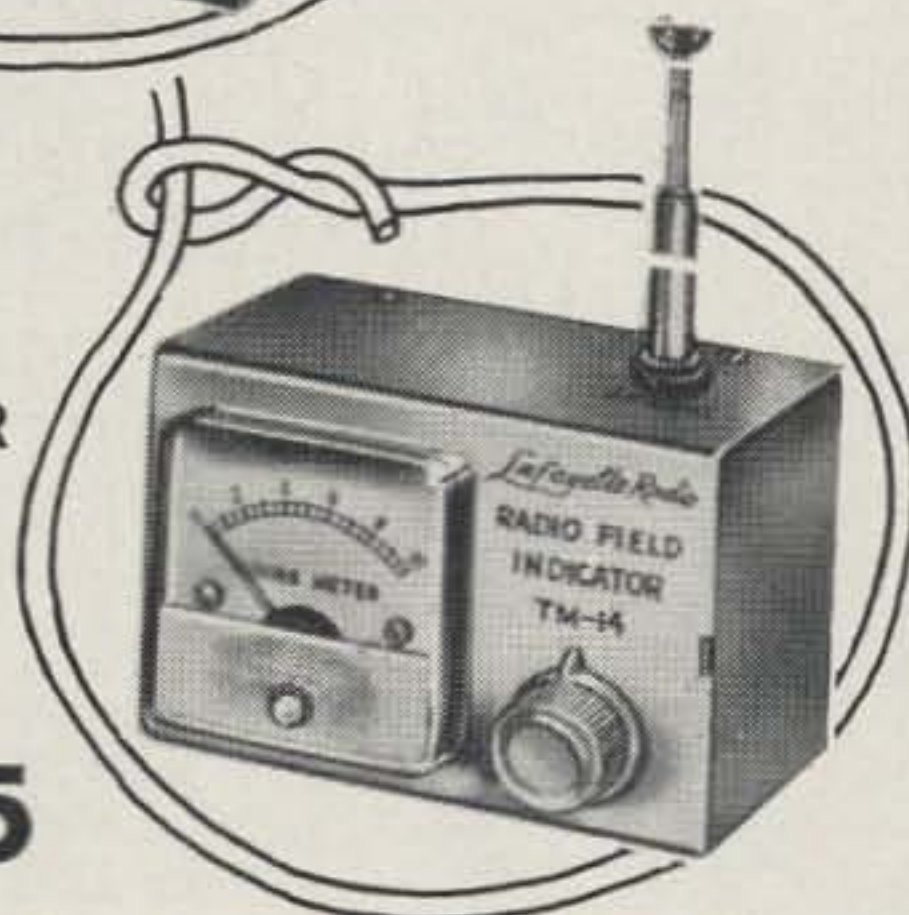

6.95

LAFAYETTE PROFESSIONAL QUALITY COMMUNICATIONS RECEIVER

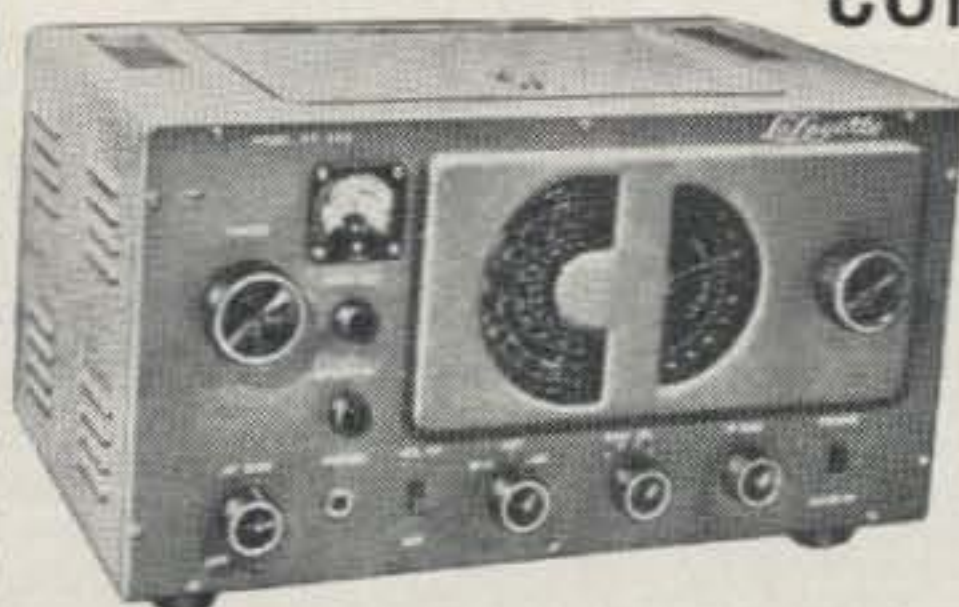

KT-200WX
in Kit Form

64.50

5.00 Down

- Superhet Circuit Utilizing 8 Tubes and Rectifier Tube
- Built-in "S" Meter with Adjustment Control
- Full Coverage 80-10 Meters
- Covers 455kc to 31 mc
- Variable BFO and RF Gain Controls
- Switchable AVC and Automatic Noise Limiter

The Communications Receiver that meets every amateur need—available in easy-to-assemble kit form. Signal to noise ratio is 10 db at 3.5 MC with 1.25 microvolt signal. Selectivity is -60 db at 10 kc, image reflection is -40 db at 3 MC.

LAFAYETTE RADIO

NEW YORK, N. Y.
100 6th Avenue

NEWARK, N. J.
24 Central Avenue

BRONX, N. Y.
542 E. Fordham Rd.

PARAMUS, N. J.
182 Route 17

BOSTON, MASS.
110 Federal Street

PLAINFIELD, N. J.
139 W. 2nd Street

165-08 LIBERTY AVENUE, JAMAICA 33, N. Y.

OTHER LOCATIONS

Lafayette Radio Dept. 73E-1 P.O. Box 190 Jamaica 31, N. Y.

\$.....Enclosed. Send Stock #..... Rush FREE 324 Page Catalog 610

\$.....Down Payment Enclosed for Stock #.....

Lafayette Easy Pay Application Will Be Forwarded Upon Receipt of Down Payment

Name _____

Address _____

City _____ Zone _____ State _____



**FREE 324-Page
1961
Catalog No. 610**

Cut Out & Paste
on Post Card

Propagation

Part I

David A. Brown K2IGY
Associate Editor

THE present Sunspot Cycle, Number 19, which reached an all time high in late 1957, is now rapidly on the decline. To understand what kind of DX conditions will exist this coming winter and for the rest of the cycle, it is important that one understands first, the Sunspot Cycle and second how propagation conditions follow this cycle.

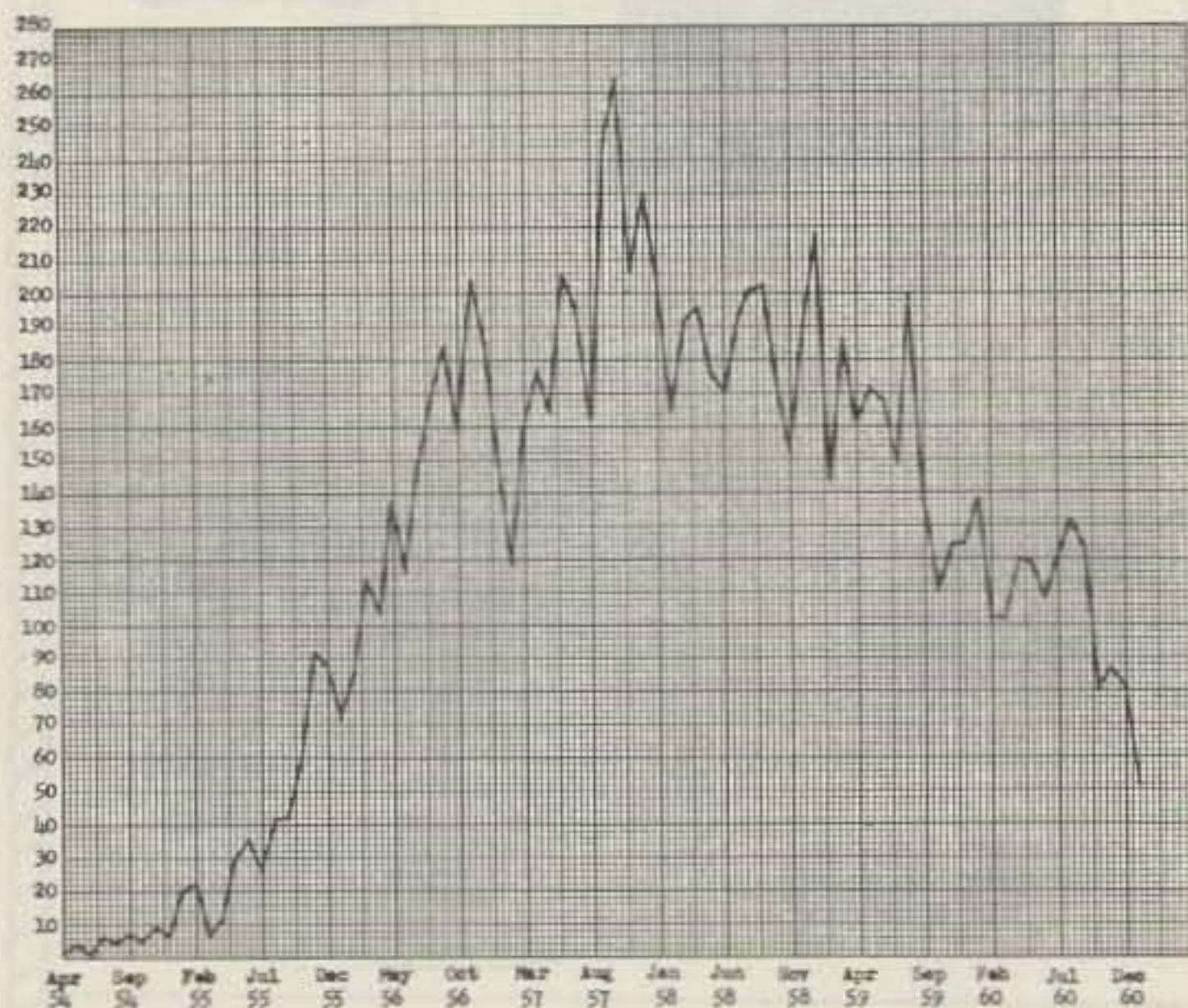

The relative sunspot number is not the count of the number of sunspots seen on the disk of the Sun, rather, it is an index of sunspot activity observed on the entire visible disk of the Sun, which is determined each day by many observers throughout the world.

Sunspots usually occur in groups and the Relative Sunspot Number was set up to include the number of groups as well as the number of spots, and is defined as: $R = k(10g + s)$, where R is the relative sunspot number; k is a scale factor (usually less than one) which depends on the observer and his instrument and is intended to be used as a conversion back to the original scale set up by Wolf in 1849; g is the number of groups or clusters of spots; s is the number of individual spots. This number is determined each day and the average (mean) value given for each month. The American Relative Sunspot Numbers are designated RA, and the Zürich Relative Sunspot Numbers as RZ. Fig. 1 is a graph of the RZ numbers.

Examination of Fig. 1 will show that the sunspot number is a highly unpredictable quantity in itself, but the cyclic nature is easily

seen. Note that the maximum RZ number occurred in October, 1957 and was 262.9. The highest daily number ever observed was 355 on December 24 and 25, 1957.

In propagation analysis we are interested in the 12-month running average of the RZ numbers, for it is this smoothed curve that the yearly variations in MUF follow, and not the very erratic variations in Fig. 1.

Fig. 2 is the 12-month running average of the RZ numbers and it is this curve that we call the "Sunspot Cycle." Sunspot Maximum is the time when the Sunspot Cycle reaches its maximum value, and not when the RZ numbers are highest.

The time of Sunspot Maximum is not easy to determine, in fact there is an apparent discrepancy between the American and Zürich maximums, probably due to the method of reduction of the observations. Most maximums are quite broad and there is always some uncertainty in the determination of the time of greatest activity on the Sun. A difference of over a year between RZ and RA, maximums is found in the present cycle, RZ having occurred in 1947.5 and RA, in 1948.8. The Zürich Sunspot Cycle is used as the standard, and to date there is data for eighteen complete cycles, the current one being Number 19.

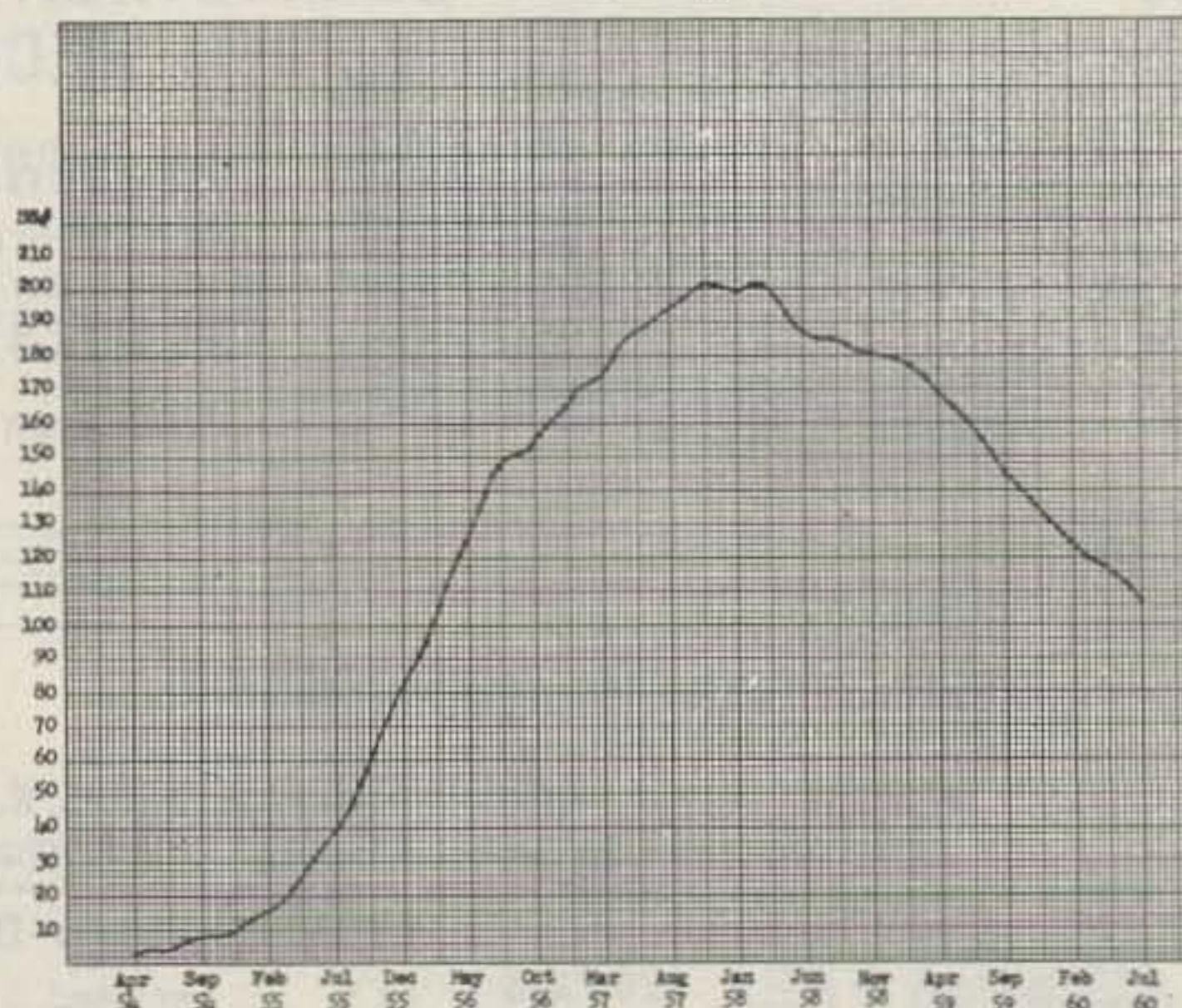

The most reliable data is for cycles #8 through #18. This data has been averaged and the result is called the Mean Sunspot Cycle, which has a period of 11.1 years. The rise from minimum to maximum takes 4.6 years while

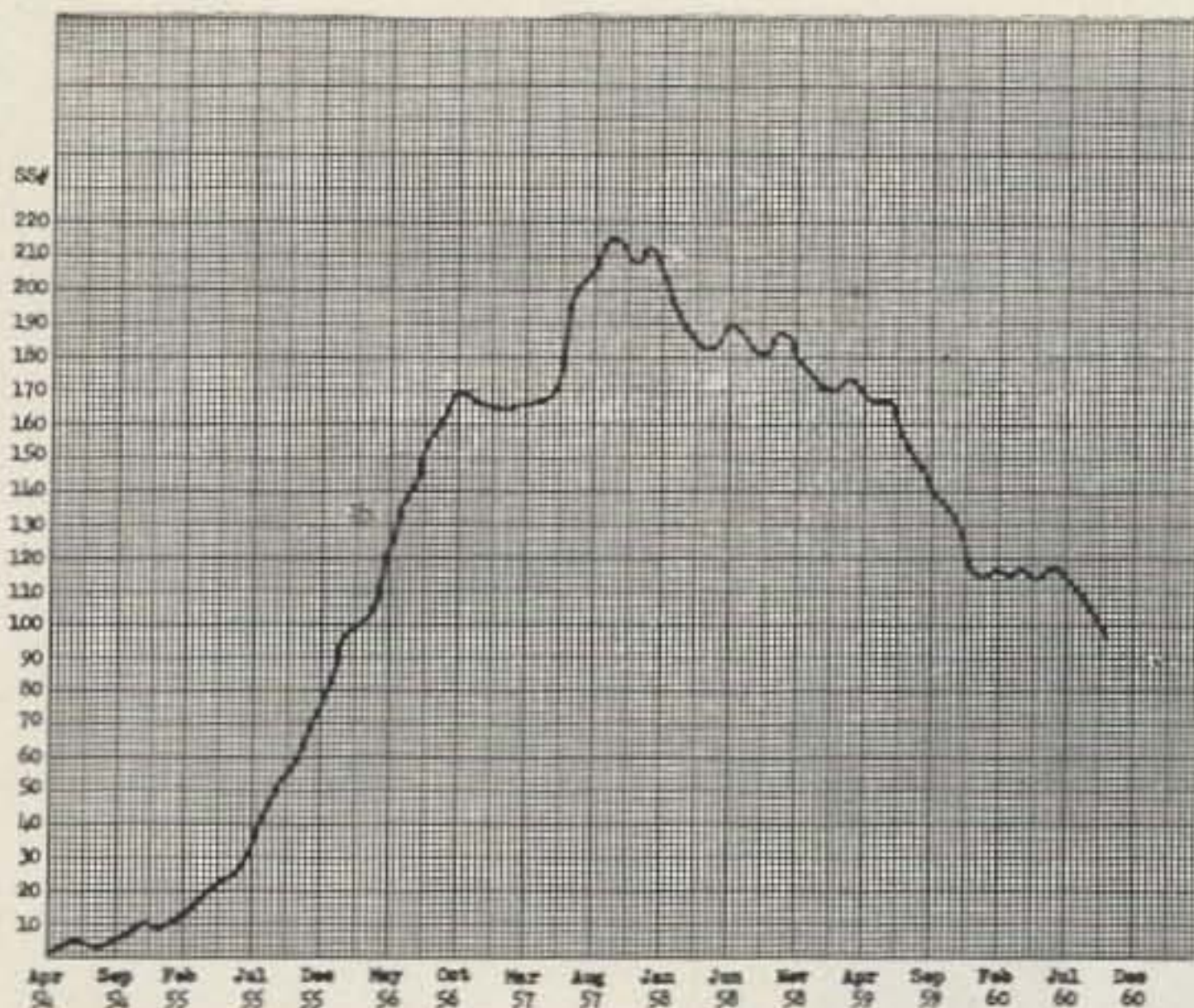

the fall from maximum to minimum takes 6.5 years. The average maximum number is around 96.4. The length of a cycle is determined from one maximum to the next. The shortest cycle was 7.3 years (1830-1837) and the longest 17.1 years (1788-1805). For this reason it is practically impossible to predict when the next maximum will occur in advance with any reliability.

The present cycle reached a maximum around 1957.7 making the length of cycle #18 only 10.2 years long, almost a year shorter than the average cycle. We are now most interested in when the next minimum will occur. Since the twelve-month running average values of RZ are six months behind the RZ values, the last six months of the Sunspot Cycle have to be predicted. Also, the data for predicting the MUF's must be available for at least three months in advance, based on current Critical Frequencies and a predicted Smoothed Sunspot Number. This means that the smoothed numbers should be predicted at least ten months in advance.

To aid in the determination of the smoothed numbers, I use a seven month and a three month smoothed running average, curves which are Fig. 3 and Fig. 4 respectfully. Notice how the curve in Fig. 3 approximates the smoothed
(Continued on page 53)

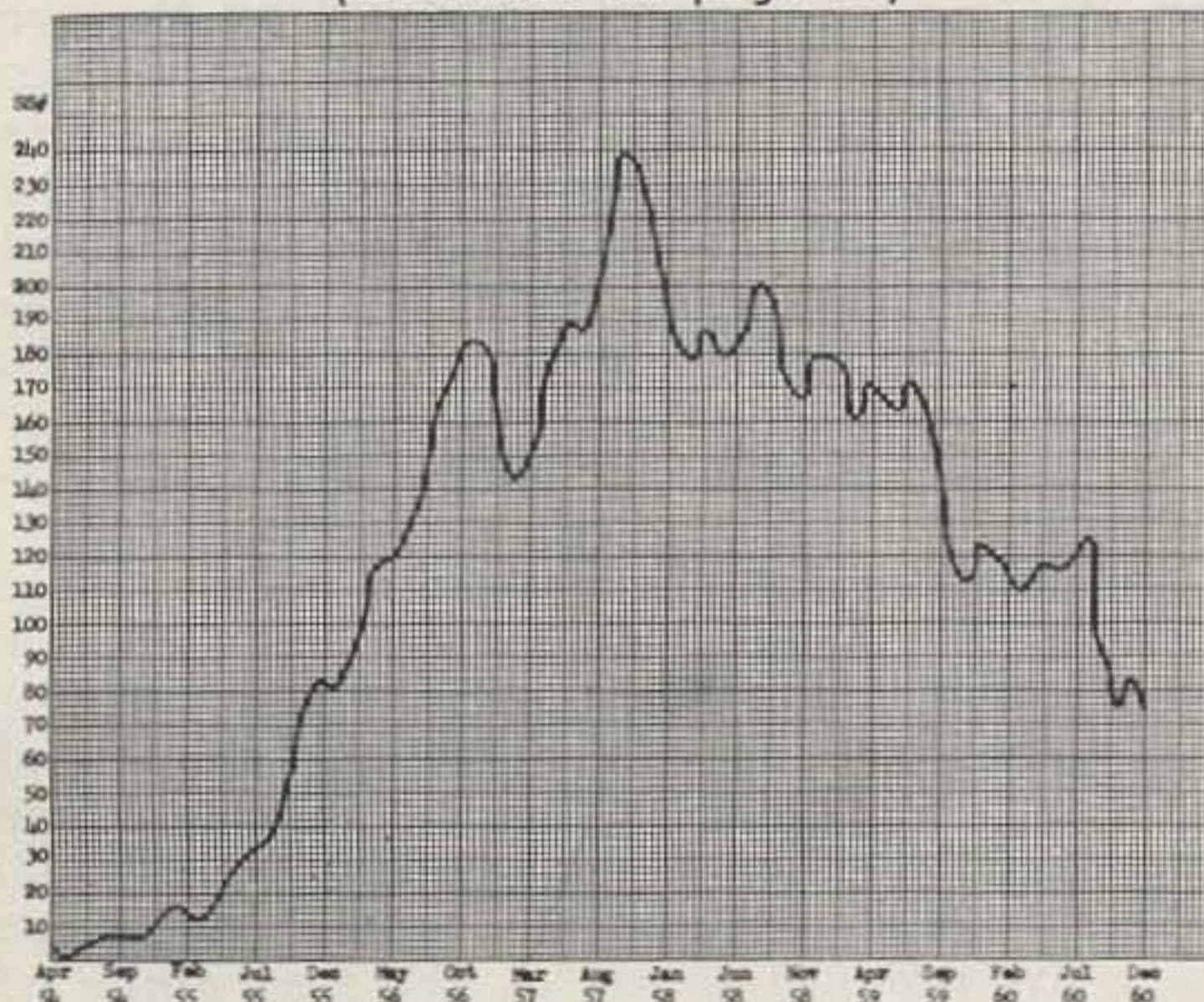

NOW! TWO ANTENNAS IN ONE*

*another *FIRST* from *FINCO*

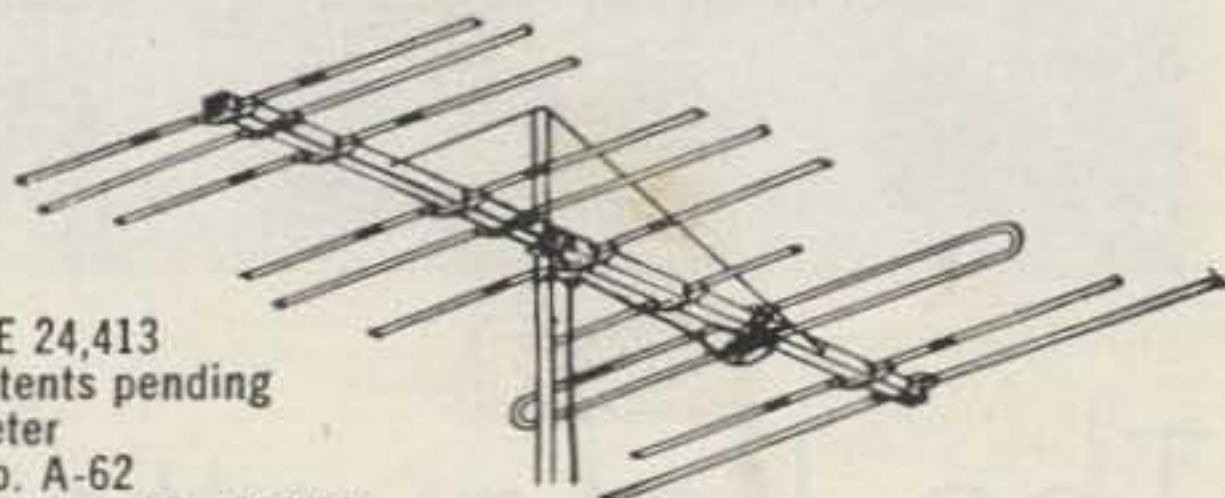

Patent RE 24,413
Other patents pending
6 & 2 Meter
Model No. A-62
Amateur Net A-62 \$33.00
Stacking Kit AS-62 \$2.19

The Only Single Feed Line 6 & 2 METER COMBINATION ANTENNA from **FINCO**

- Heavy Duty Square Aluminum Boom, 10 Ft. Long
- All Elements are Sleeve Reinforced And Completely Pre-assembled With "Snap-Out" Lock-Tite Brackets
- Boom Suspension Rods Are Supplied Completely Pre-assembled, Ready To Be Snapped Into Upper End Of Mast

ON 2 METERS:

- 18 Elements
- 1—Folded Dipole Plus Special Phasing Stub
- 1—3 Element Collinear Reflector
- 4—3 Element Collinear Directors

ON 6 METERS:

- Full 4 Elements
- 1—Folded Dipole
- 1—Reflector
- 2—Directors

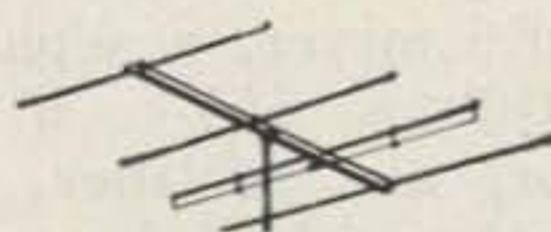

A6-4 6 Meter 4 Element
Amateur Net \$17.16
Stacking Kit AS-6 \$2.19



A2-10 2 Meter 10 Element
Amateur Net \$11.88
Stacking Kit AS-2 \$1.83

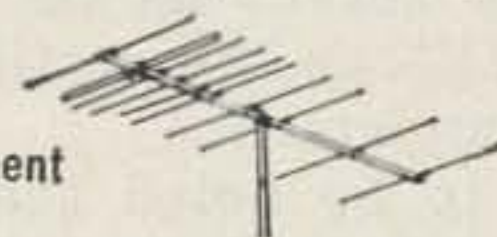

A1 1/4-10 1 1/4 Meter 10 Element
Amateur Net \$11.88
Stacking Kit AS-1 1/4 \$1.26

See Your *FINCO* Distributor
or write for Catalog 20-226 to:
THE FINNEY COMPANY
Dept. , 34 W. Interstate St., Bedford, Ohio

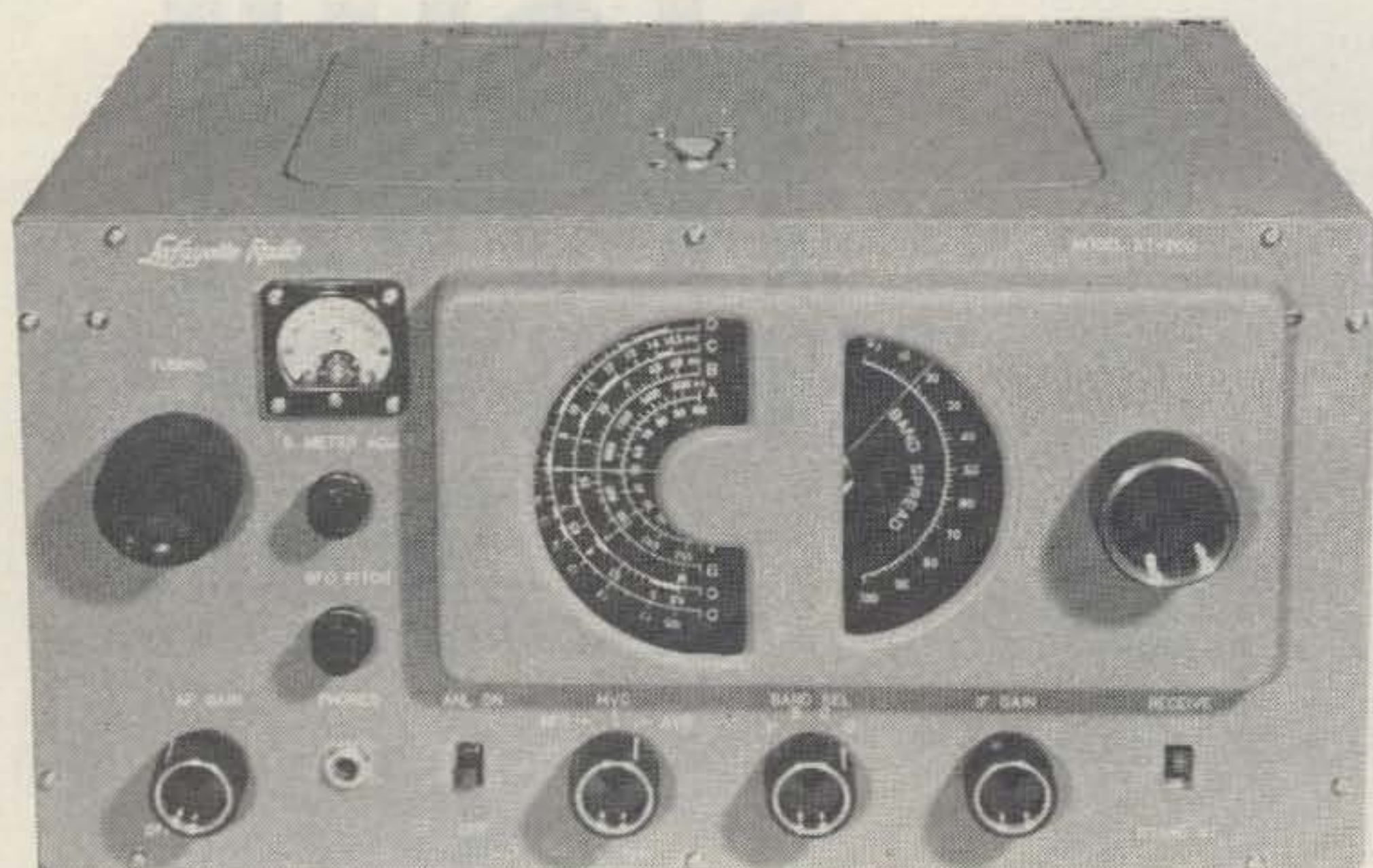

Allie C. Peed, Jr. K2DHA
34 Ashley Drive
Rochester 20, New York

The Lafayette KT-200 Receiver

a review

As a kit, the KT-200 represents a departure from the usual kit practices. As soon as you unpack it, you'll note that by the usual kit standards you are about half finished already. All of the mechanical mounting is already completed for you. Tube sockets, transformers, main tuning capacitor, filter capacitor, controls, and even knobs and pilot lamps are all in place. The tuning mechanism is already installed and operative. The dial cords are strung and the flywheels are in place. And, best of all, the complex assembly of coils and alignment capacitors for the oscillator, mixer, and rf amplifier stages are mounted and pre-aligned, but more about this later.

Circuitwise, the KT-200 is conventional, straightforward, good design. It consists of a 6BD6 rf amplifier, a 6BE6 mixer, a separate 6BE6 oscillator, two 6BD6's as 455-kc *if* amplifiers, a 6AV6 detector, avc rectifier, and first audio amplifier, another 6AV6 beat frequency oscillator and shunt-type noise clipper. A 6AR5 serves as the audio power amplifier and a 5Y3 as the rectifier completes the nine-tube complement.

It is to be noted that many receivers commonly use a single 6BE6 pentagrid tube as both oscillator and mixer. However, in the interest of stability, the designers of this circuit have chosen to devote separate 6BE6's to the mixer and oscillator functions. This contributes to stability since it greatly reduces

the tendency of the oscillator to "pull" on strong signals and probably it also lessens thermal drift problems.

AVC voltage is applied to both the rf and *if* amplifier stages. A front panel control provides for disabling the avc in its mvc (Manual Volume Control) position. This same switch in its third position (BFO) serves the dual purpose of turning on the beat oscillator and disabling the avc for copying CW or SSB signals.

Instead of the traditional rf gain control, the KT-200 is provided with a manual *if* gain control. Thus, the rf amplifier runs fully open all of the time except as modified by the avc bias. A minor point here is that the *if* gain control is simply a 10K potentiometer in series between ground and the two cathodes of the *if* amplifier tubes. Therefore it does not afford a complete range of control from cut-off to full gain as is the case with rf gain controls. It does, however, provide sufficient control to keep strong signals from over-driving and distorting.

A stand-by switch opens the plate supply lead to the rf amplifier, mixer, and oscillator stages while leaving the remainder of the stages powered. This is perfectly adequate and probably contributes to quick recovery time and stability when break-in operation is used. The stand-by switch terminals are brought out to a five-pronged socket on the rear apron of

the chassis for connection to a break-in relay in the station control system if desired.

All of the components are of Japanese manufacture and appear to be of excellent quality. The use of a few wax impregnated by-pass capacitors is probably the lone exception. While these are of good quality, modern receiver construction practice is to use plastic or ceramic encapsulated capacitors which can be expected to give longer service.

The cabinet, panel, and chassis are a pleasant surprise. They are of heavy gauge steel including two heavy diagonal braces between the chassis and top of the front panel. This contributes to the receiver having the ruggedness of a piece of military gear when completed. It should assure good mechanical stability of the finished assembly. The cabinet and panel are finished in gray wrinkle finish, and the cabinet is provided with numerous louvers to allow good circulation and heat dissipation from the interior. Both bottom and top are provided with hinged access doors of ample size and good fit.

A unique feature of the chassis is that ground points are formed by punching out "U-shaped" tabs in the chassis. These are bent out from the underneath side of the chassis by the constructor and ground leads are wrapped around them and soldered. This feature should give positive grounds avoiding difficulties with loosening of screwed-on ground lugs, and interface corrosion between ground lugs and the chassis. However, the kit builder using a low wattage soldering iron might encounter difficulty in heating these ground tabs hot enough to assure a good solder job.

The S-meter is one of the small 1½ inch square type and it is connected with a multiplying resistor and calibration control from the cathode of the rf amplifier to ground. Essentially, it measures the voltage developed on the cathode which is a direct function of the strength of the received signal. Calibration of the S-meter is accomplished by temporarily shorting the antenna terminals on the back of the set and adjusting the "S Meter Adjust" control on the front panel until the meter reads zero. Unfortunately, this zero position varies from band to band and requires frequent re-adjustment if you are band-hopping. When the meter is adjusted to give proper readings on the short wave bands, switching to the broadcast band will pin the meter unless you back off on the control. Then you are out of calibration when you return to the higher frequency bands. Perhaps the best operational scheme here is to tune the receiver to a clear spot on the band in question and adjust the control to make the meter read just slightly above zero. Your S-meter readings then will be in terms of signal strength above background noise which is a meaningful relative reading.

Assembly of the kit consists chiefly of wir-

ing in all of the components which are mounted on their pigtail leads, and connecting the terminals of those items which are pre-mounted on the chassis and panel. The only part which might be considered difficult is the wiring of the bandswitch since this requires careful attention to directions and some work in rather cramped space at times. Total wiring time for a careful, experienced worker shouldn't exceed ten to twelve hours, and even the rankest novice kit constructor should be able to complete the job in fifteen to twenty hours.

Pre-Alignment

Your writer has, through experience, developed a tongue-in-cheek attitude toward kits which are sold claiming pre-alignment of the tuned circuits. Most such kits result in a completed unit which is aligned well enough to work after a fashion, but most of them require alignment for optimum operation. The KT-200 proved to be almost an exception however. By virtue of the fact that the tuning coils and capacitors are pre-mounted and aligned, the overall alignment was quite good and only required a minimum of touching up to achieve the sensitivity and selectivity claimed in the specifications. In particular, the frequency calibration of the main tuning dial scales was outstanding. Anyone who has ever spent hours tuning between the top and bottom of four bands while juggling padders and coil adjustments will certainly appreciate this feature of the KT-200.

Similarly, the *if* transformers were close enough to proper alignment to allow them to be peaked by ear by the kit constructor who is not equipped with a signal generator and voltmeter. The only exception to this good

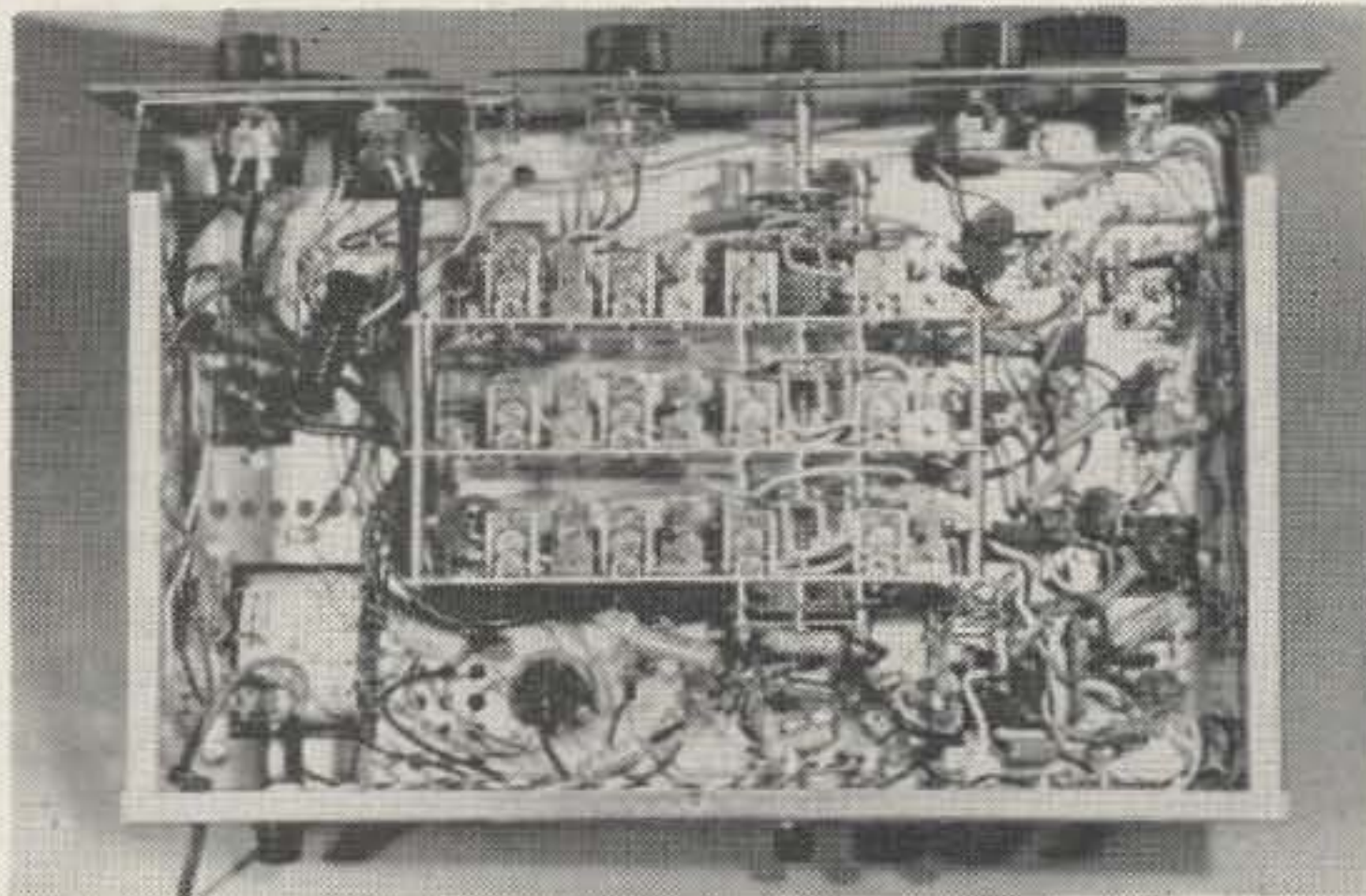

alignment was the bfo coil which was considerably out of tune. However, this is aligned by simply adjusting the core until a zero beat is heard in the speaker or phones, and hence it was not difficult to bring into line.

It was previously mentioned that frequency calibration of the main tuning dial was excellent. However, two-dial tuning of this type in general suffers from poor re-set accuracy and since, in this case, the main tuning dial

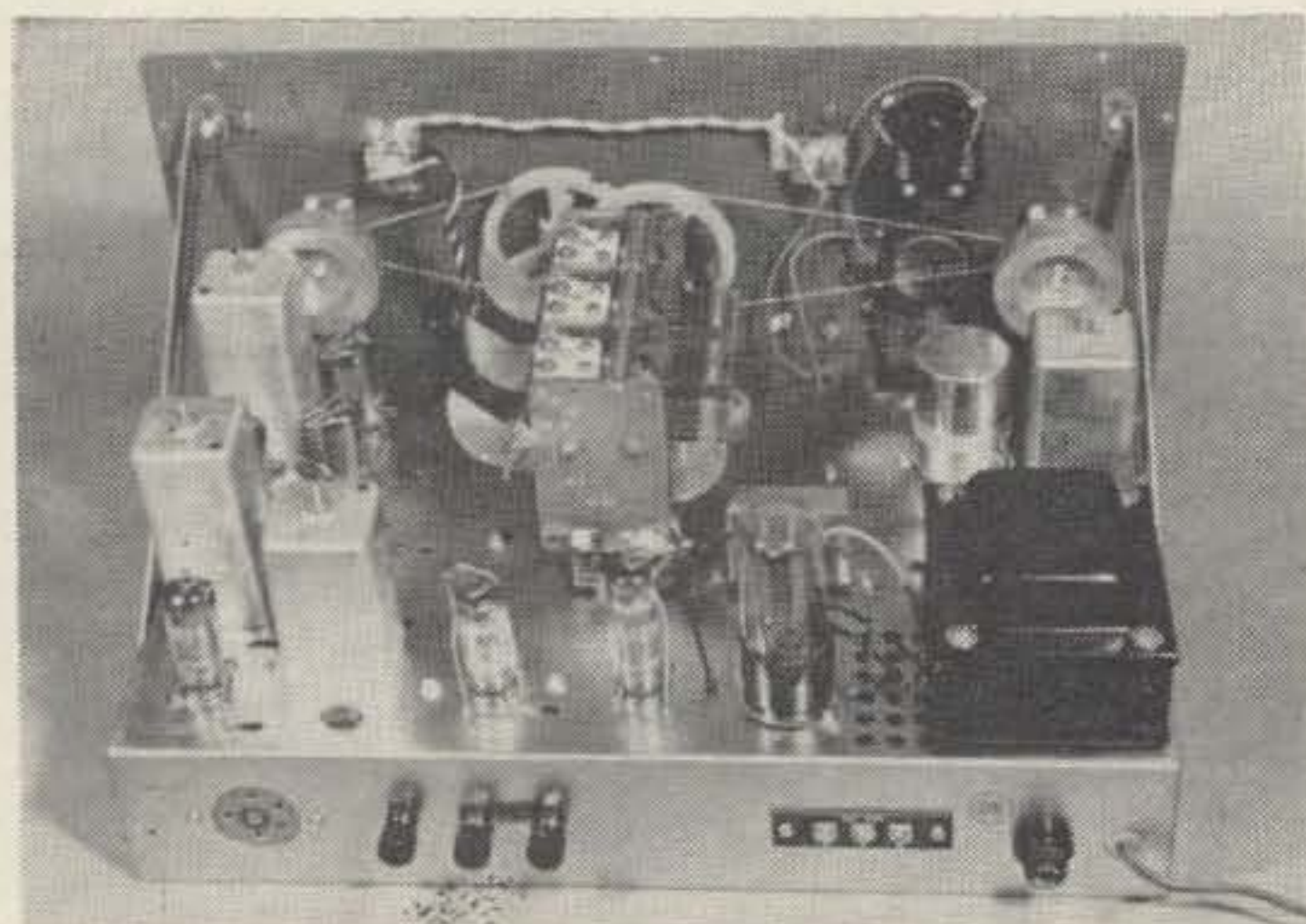

does not have index marks for setting to the amateur bands, location of the ham bands becomes a small problem. The bandspread dial is not calibrated except for an arbitrary 0—100 logging scale. The selectivity of the receiver is good enough to justify the use of a great deal of bandspreading, i.e., the bandspread control provides for a slow tuning rate enabling accurate tuning. But, this good feature is at the expense of coverage on the bandspread dial and one complete sweep of the bandspread scale does not cover fully any ham band in its entirety. It is necessary to reset the main tuning in order to tune a whole band.

If a 1000 kc crystal calibrator is available, it can be used to good advantage in spotting the proper ham band settings of the main tuning. Set the bandspread dial to 100 (maximum capacity) and tune in the 1000 kc marker at the lower end of the band in question. Then the bandspread will tune up the band from the lower edge. At the limit of the bandspread tuning if you wish to tune further up the band, it will be necessary to "fudge" the main tuning up a fraction. In practice, this isn't as much of a handicap as it sounds since the bandspread is sufficient to cover the entire phone or CW sub-band on most of the bands, and it is seldom that an operator operates both modes at one operating session.

The lack of bandspread calibration is no real handicap in modern operation which calls for zero-beating the station that you are working with your transmitter vfo. You must, however, assure yourself that your transmitter is operating within the proper frequency limits by some other method than your receiver's calibration, unless you provide the receiver with a crystal calibrator and learn to use it properly.

Mechanically, the bandspread tuning is interesting. In the main tuning capacitor, one plate is omitted in the center of each of the three rotor sections. Then, on a separate shaft from the opposite side of the capacitor, a single plate is turned into this gap in each stator section from the bandspread tuning shaft—a very neat arrangement.

The instruction manual is quite complete,

but there are a sprinkling of errors and omissions which must be watched. For example, a correction sheet enclosed with this particular kit changed the instructions for wiring the main filter capacitor. However, this kit appeared to have one of the original type capacitors in it. When wired according to the correction sheet, the second section of the filter capacitor was connected with reverse polarity and the first section was ungrounded. As a result, all of the voltages were low by a large amount and there was excessive hum. Indeed, this could lead to the demise of the filter capacitor if not found and corrected quickly. Reference to the terminal notation on the capacitor can clear up this problem.

A couple of omissions which will be caught quickly by the experienced kit builder but which might trip the novice are worthy of mention. One relates to the pilot lamp wiring. There are two pilot lamps—one for each tuning dial. The instructions direct the wiring only of the one on the bandspread dial while the second one is not mentioned or shown in any of the illustrations. Perhaps this a change in the design which has not yet been worked into the manual. It is necessary only to run a couple of leads from the wired lamp socket to the other one in order to make both operate.

Another oversight appears in the rather detailed instructions for aligning the bfo. In the course of this procedure the manual fails to direct that the bfo be turned on with the front panel switch.

In the tabulation of voltages, the instructions fail to give directions for the settings of all of the front panel controls. This can lead to some readings which are perfectly normal but quite at variance with those given in the table. For example, it is obvious that the bfo must be turned off to obtain the readings given in the tabulation on the bfo tube. Likewise, some of the grid voltages will be different from those in the table depending on whether the AVC is activated or not, and whether a signal is present or not.

Modifications

Two modifications suggest themselves as being worth consideration by those who may assemble one of these units in the future. One is to take advantage of the three unused prongs of the five-prong rear apron socket to bring out a power take-off for a Q-Multiplier, TR Switch, crystal calibrator, or other low-drain auxiliary station accessory. Connect one pin to ground, one to the 6.3-volt filament line, and one to the plate voltage from the output of the filter. It is a good idea to mark these on the chassis beside the socket so that when you want to use it, you can recall how you wired the socket without having to open the cabinet and trace the wiring.

The second modification relates to the 10-watt resistor used as part of the power supply

filter (R21). This generates considerable heat and it is in rather close proximity to the oscillator coils and padders. Since the set was found to have a very substantial amount of drift for about the first ten to fifteen minutes of its operation from a cold start, it seemed prudent to move this resistor over to the side of the chassis away from the coils and nearer some of the ventilating holes. This move diminished the warm-up drift appreciably and made for more rapid stabilization.

The bfo in the particular unit tested failed to provide sufficient injection to allow for good SSB reception. It was necessary to increase the size of the small tubular capacitor which coupled the bfo output into the second detector. The 2.2-mmfd capacitor supplied was too small. A 10-mmfd disc ceramic gave more suitable injection level and an even larger one might be desirable. (Two pieces of hook-up wire twisted into a gimmick capacitor might serve as well.)

While the receiver is capable of good SSB reception, it must be observed that tuning in a sideband signal with the small bfo knob on the panel can be a bit tedious. A larger knob, or planetary reduction drive would be of some assistance.

Operation of the KT-200 for a limited time since its construction has left the impression that it is definitely a hot performer even on ten meters where many single-conversion general coverage units with 455-kc *if*'s fall down. No problem was encountered with images, no doubt due to the isolation and attenuation provided by the rf amplifier stage. Sensitivity is very good and selectivity is adequate although the addition of a Q-Multiplier would be useful for operation in the crowded ham bands. After the warm-up drift previously discussed, the stability is excellent—good enough even to allow satisfactory reception of single sideband signals. Incidentally, as sort of a bonus, this receiver is an outstanding performer on the broadcast band.

In summary, the KT-200 appears to be an excellent value for a middle-priced general coverage receiver. It is worthy of serious consideration by anyone ready to graduate from the inexpensive five or six tube general coverage receivers, but not yet in a position to purchase one of the top-flight communications receivers. Or it might be useful as a second receiver to supplement your ham-band-only hearing aid.

... K2DHA

Hey	Fri.	Fri.	Thu.	Wed.	Sat.	Sun.
8	7	6	5	4	3	2
16	15	14	13	12	11	9
23	22	21	20	19	18	17
31	30	29	28	27	26	24
38	37	36	35	34	33	32

DOWN through the ages civilization has developed into its present, though ever changing form. In the wake of its evolution it has left the remains of innumerable outmoded ideas and once useful articles. Some of these have been revised to meet the times, while others were simply discarded.

One thing that has survived unscarred and unchanged throughout centuries of use and misuse is the calendar.

After many long years of diligent research on the subject I have developed the following plan for calendar revision. I propose that this plan be adopted for the good of all amateur radio operators and any and all individuals associated with them.

Hams, as everyone knows are inclined to "put off till tomorrow what should be done today." With this calendar you can put off washing the car on the seventh and still get it done by the third.

Ever notice how your Friday night net meetings always clash with the XYL's bridge parties or other great social occasions which demand your presence? No longer. Not with two Fridays in each week!

Now you can go ahead and buy that expen-

The Ideal Ham Calendar

R. M. Case K4YNO

sive KW rig you've had your eye on without worry about the first of the month payments on it as there isn't any first. The tenth and twenty-fifth have also been eliminated in case you are asked to pay on those days.

The number of week-days has been cut to four leaving a glorious three-day week end for hamming.

Those bothersome Mondays have been eliminated altogether and an extra day: Heyday has been added to round out the week. It is hoped that with a little persuasion Frank's Country Cousins would allow unrestricted operation on this day.

After you have carefully scrutinized the intricate details of this wonderful new calendar and feel that you would like to join our campaign for its adoption please stop by our headquarters at the S.A.H.F.H.B.A.O.C.H.**

If you don't have enough time to devote to this worthy cause at least stop by to see us some time. We are allowed to have visitors from one till four o'clock on Wednesday and Friday afternoons.

**Sunny Acres Home for Half Baked and Otherwise Crazy Hams.

Build a Vary-Volt

Joseph Leeb W2WYM
549 Green Valley Road
Paramus, New Jersey

A variable-voltage supply is generally in the luxury class, as far as the average experimenter is concerned—nice to have, but expensive. Yet it need not be beyond your reach, because you probably have the makings in your junk box right now. Once you've used the Vary-Volt, you'll wonder how you ever got by without one.

Before digging into the construction, let's

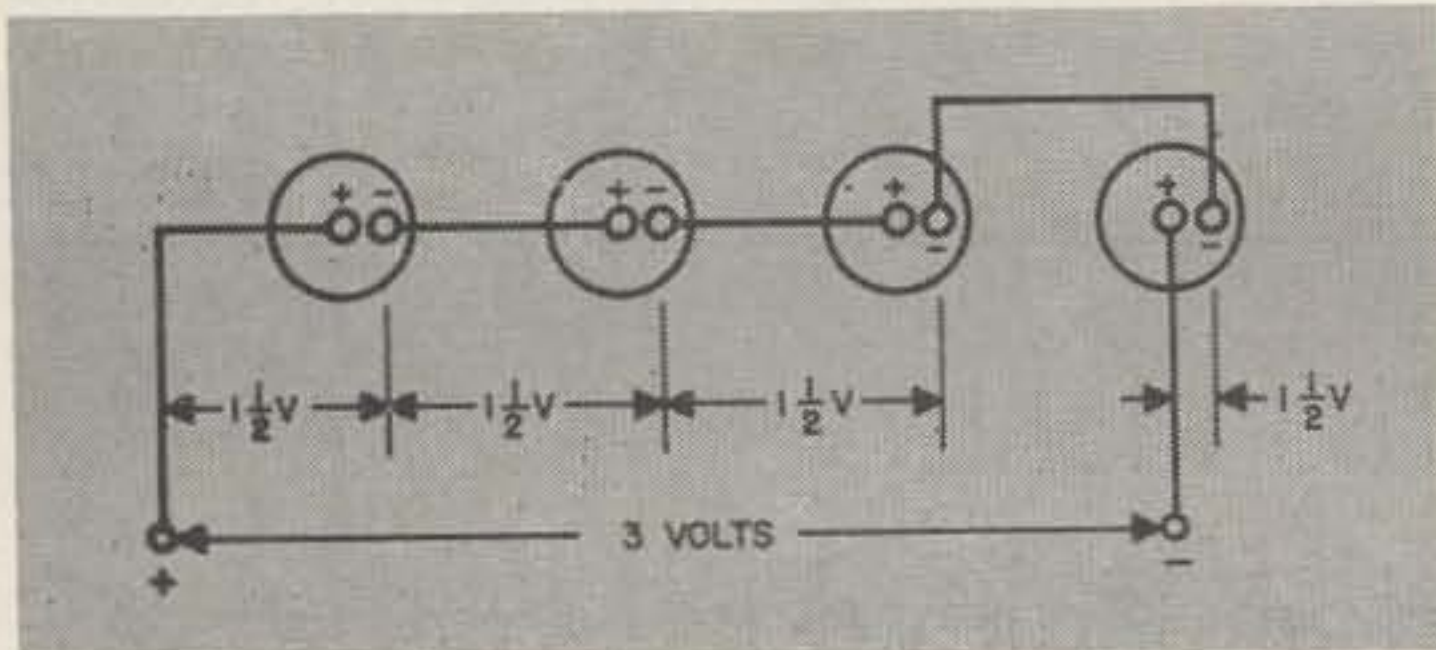

see how the Vary-Volt works. Suppose we start with some dry cells. We all know that if we connect our cells in series, observing polarity, the final voltage is the sum of the voltages of all the cells. If each cell delivers $1\frac{1}{2}$ volts, two in series will give 3 volts, three in series, $4\frac{1}{2}$ volts, and so on. A little carelessness in observing polarities, however, will give some unexpected results. For example, four cells, connected as shown in Fig. 1, with one cell reversed, will give, not 6 volts, but 3 volts! The first three cells give $4\frac{1}{2}$ volts, but the fourth cell, being connected with reversed polarity, bucks the voltage of the first three cells, and the result is $4\frac{1}{2}$ minus $1\frac{1}{2}$, or 3 volts.

Although we are not accustomed to thinking of transformers as having polarity, their windings do, nevertheless, have definite polarity at any given instant when the current

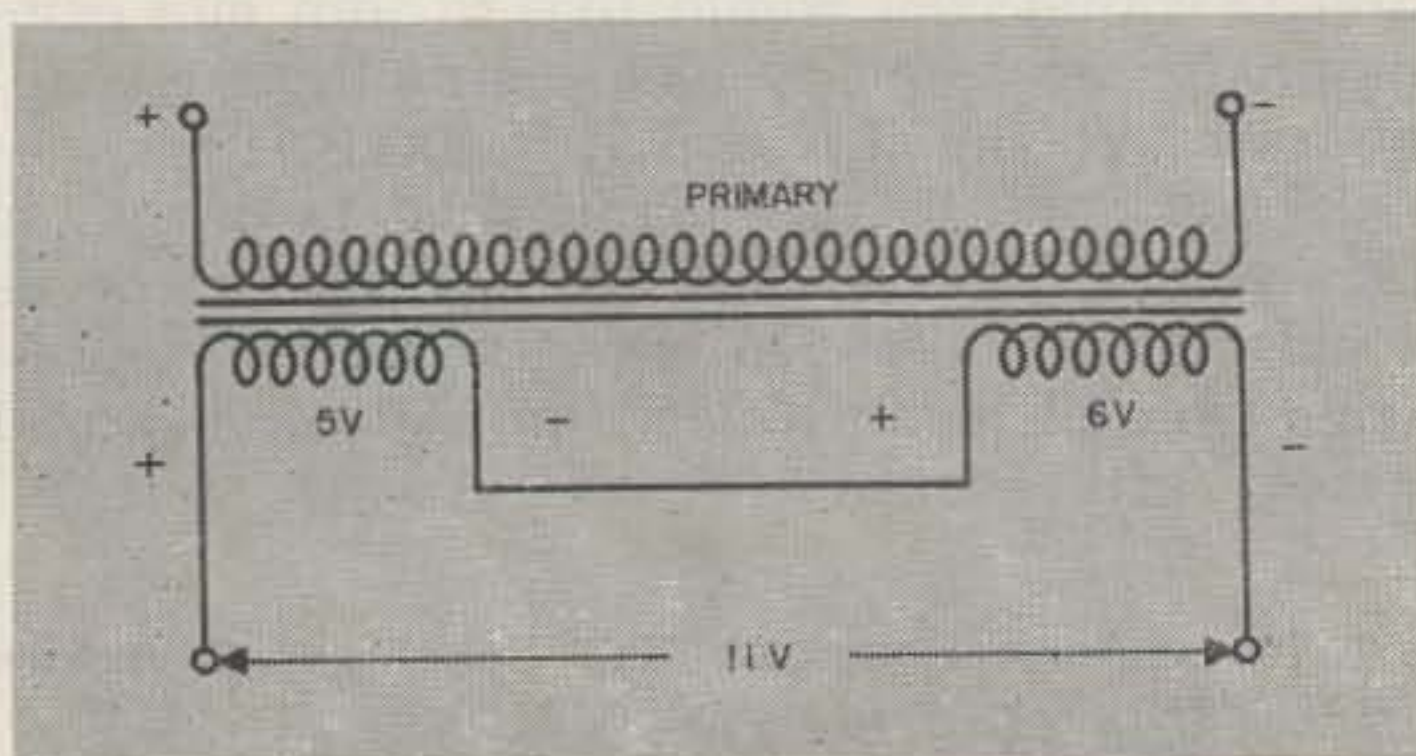

flows. If we connect two windings on a transformer in series we will get either the sum or the difference of the two voltages, depending upon whether we connect the windings "series adding" or series bucking." (See Figs. 2 and 3). In our case the primary is used with the filament windings, making the Vary-Volt an auto-transformer with buck and boost.

To build the Vary-Volt we need a filament or power transformer with several filament windings. An old TV transformer will do nicely.

With the aid of an ohmmeter locate the winding with the highest resistance. This is the high voltage winding and will not be used, so tape up the leads carefully to keep them out of harm's way. Now find the winding with the second highest resistance. This is the primary; put a tag on it. The remaining windings are the filament windings.

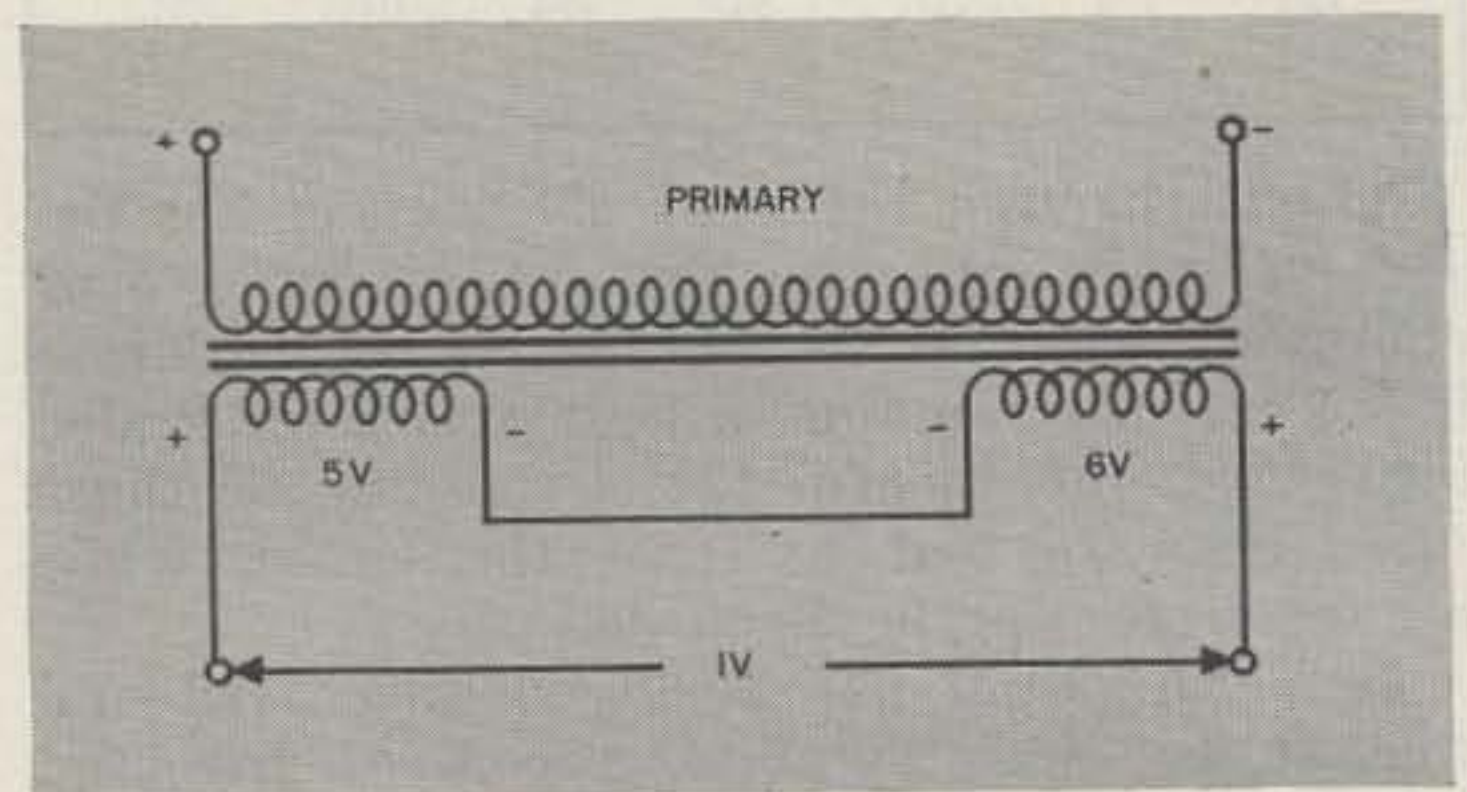

Connect a cord and plug to the primary in series with a 50 or 60 watt lamp. The lamp is a safety precaution, used only while checking out the windings. Hook up the filament windings in series and plug the primary in to the 115 volt ac line. Measure the total voltage of the windings. If it adds up to the sum of the individual filament winding voltages the terminals are correctly polarized with respect to each other. If the reading is less than expected, some of the connections will have to be reversed. This is done by measuring first one winding by itself, then two in series. If the two voltages add, connect in the third. Again, if the three voltages add, OK; if they buck, reverse the terminals of the winding.

By connecting the filament windings in series with the primary in such a manner that

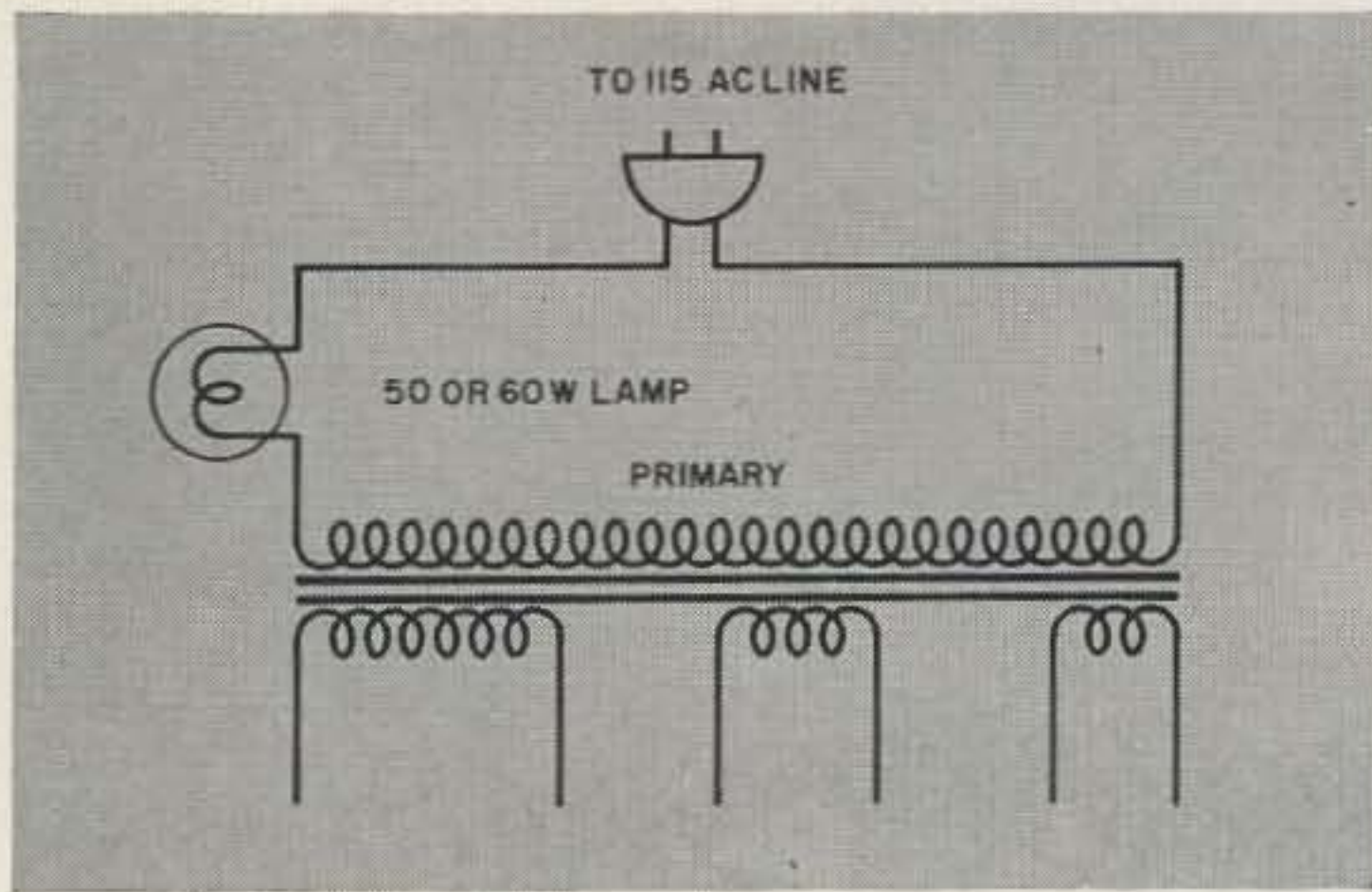

the secondary voltages add to the primary voltage, or reduce it by bucking action, we have a range of adjustment from line voltage minus all secondary voltages up to line voltage plus all secondary voltages. For example, if our transformer has filament windings delivering 6.3, 6.3 and 5 volts, and the line voltage is 115, then our Vary-Volt will give from 115 minus 6.3, minus 6.3, minus 5, or 97.4 volts, up to 115 plus 6.3, plus 6.3 plus 5, or 132.6 volts. The two-deck seven-position switch accomplishes this by tapping off the desired number of windings in series with the primary, and proper switching of polarity. For

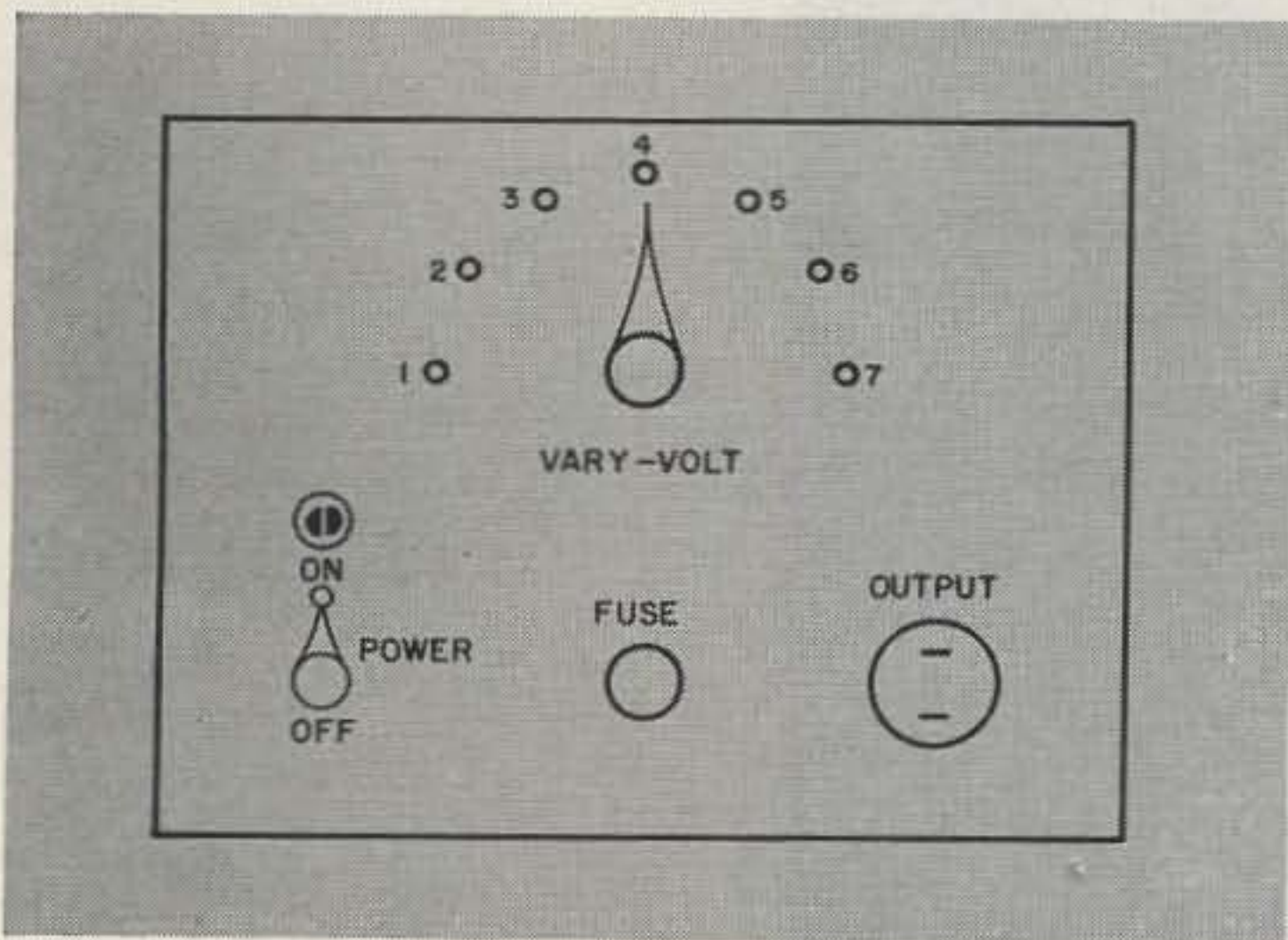

example, when the switch is in positions 1 to 4, the lower deck connects the filament windings in series-bucking with the primary. In switch positions 5 to 7 the lower deck reverses the connections to the filament windings, placing them in series-aiding with the primary. The upper deck of the switch selects the desired voltages.

Construction of the Vary-Volt is quite simple. Dimensions have not been included since they will vary with the size and shape of transformer available. The panel may be fastened to a wooden baseboard or mounted in a ventilated cabinet. Prepare the panel for drilling and cutting by following Fig. 5. Mount the voltage selector switch, power switch, pilot light, fuse holder and outlet as shown. Wire according to the diagram. Use color-coded wire if available. This will reduce chances of error and make troubleshooting easier,

With the wiring completed, plug the Vary-Volt in to a 115 volt ac outlet. Check the output voltage with an ac voltmeter. If the voltage at each point on the selector switch is not according to the Table in Fig. 6, recheck the wiring, keeping in mind that the points on the selector switch become reversed when viewed from the rear.

As we warned you in the beginning, you'll wonder how you ever managed without a Vary-Volt. There is nothing better for tracking down intermittent conditions in electronic circuits caused by either excessively low or excessively high line voltage.

Does your electric drill run too fast? Slow it down with the Vary-Volt. Like to dine by subdued light? The Vary-Volt makes an excellent dimmer. Soldering iron too sluggish? Boost its voltage with the Vary-Volt. Each time you use this handy shop gadget you will find more new and exciting applications for it.

... W2WYM

Parts List

- T1—Filament or power transformer with several filament windings.
- S1—Toggle switch.
- S2—2-deck, 7 position wafer switch.
- F1—Fuseholder and fuse. Fuse amperage depends upon transformer size.
- PL1—115 volt neon pilot light and socket.
- J1—Panel type convenience outlet.
- AC line cord and plug.
- Panel and box; size dependent upon transformer dimensions.
- Hardware: solder, wire, screws, nuts, washers, etc.

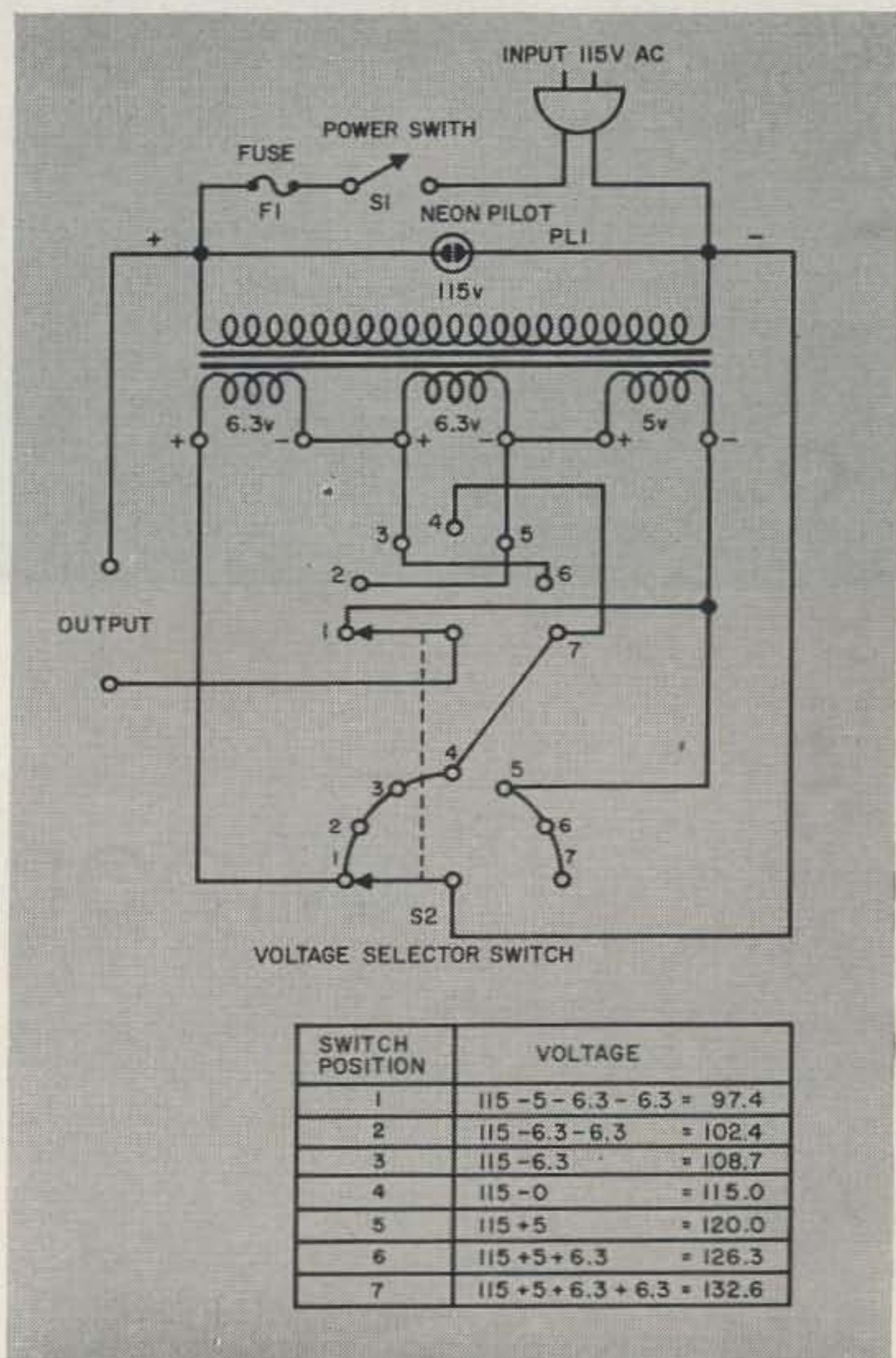

SWITCH POSITION	VOLTAGE
1	$115 - 5 - 6.3 - 6.3 = 97.4$
2	$115 - 6.3 - 6.3 = 102.4$
3	$115 - 6.3 = 108.7$
4	$115 - 0 = 115.0$
5	$115 + 5 = 120.0$
6	$115 + 5 + 6.3 = 126.3$
7	$115 + 5 + 6.3 + 6.3 = 132.6$

WIBU

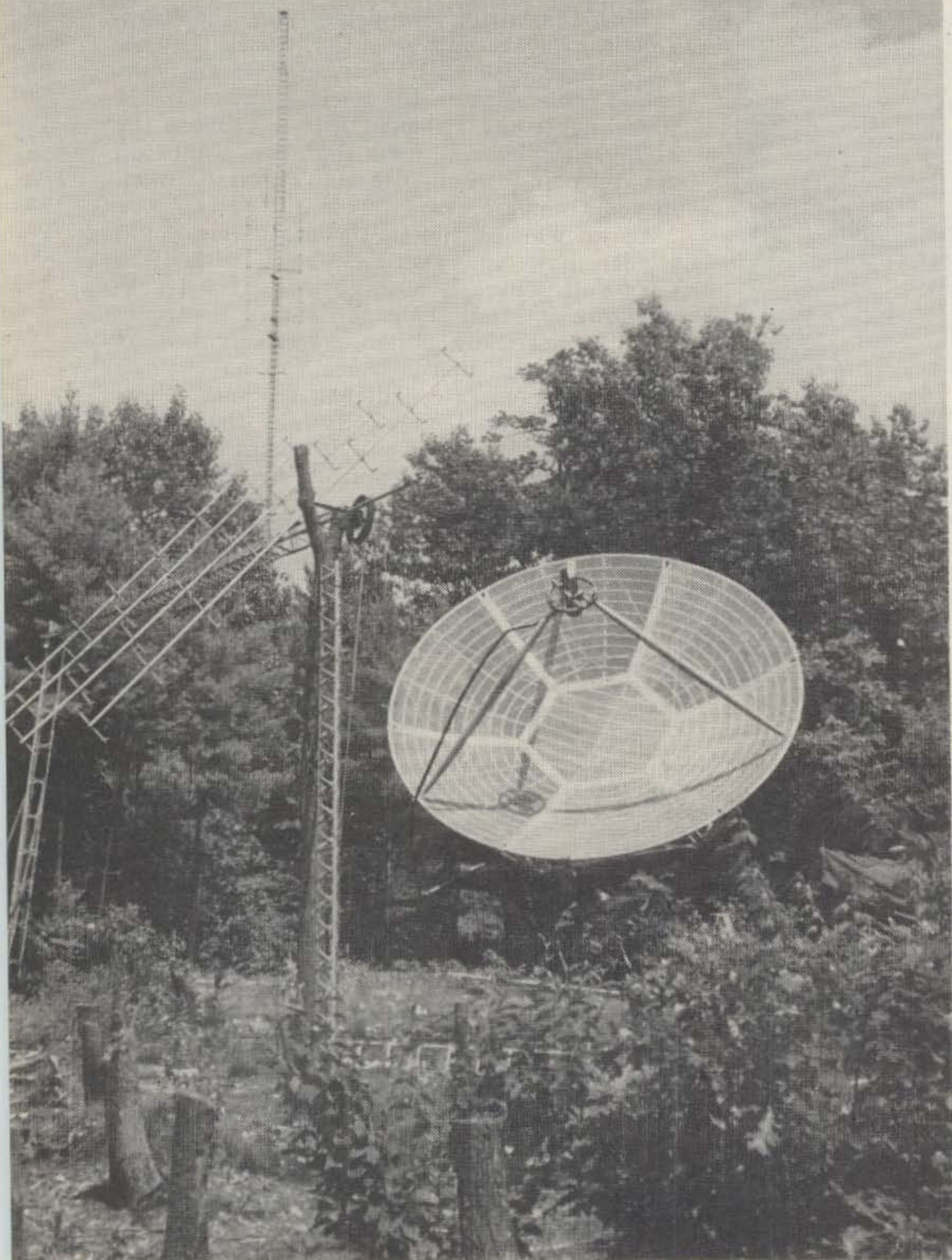

Moonstruck

Dave Bell, W8GUE/6
3209 North Marengo Ave.
Altadena, California

I could see the outline of the big dish against the full moon as I followed Jack through the hanging feedlines to Building C (the chicken coop.) I fought my way through the bushes which had somehow survived the throngs of hams who had pushed them aside. Jack threw a switch with the ceremony of lighting up a world's fair. He has a flair for the dramatic. And well he might. The floodlights illuminated a huge dish, twenty-some feet in diameter, which at that moment looked like the pride of Goldstone.

"There she is, David," he said with amazing reserve.

I mumbled a wow or a gee or similar.

"It's just a leetle one," he said, "but it'll hit the moon all right."

After fumbling a moment with his coat-hanger "lock," Jack stepped into Building C.

"C'mon in here and get warmed up."

I told him I'd be in in a minute and walked over to the dish. It was held 15 or 20 feet in the air by two huge, steel pipes buried in several yards of concrete. In the glare of the lights I could see what looked like an automobile differential welded to the top of the supporting pipes, and on this was mounted the aluminum and chicken wire dish. A huge counterweight balanced the affair. It occurred to me that all Jack needed was a beanstalk and he could have convinced the "Twilight Zone" producers that he had stolen the giant's sieve.

"C'mon in here. You'll freeze yourself out there."

Building C hadn't warmed up much, but Jack was rubbing his hands over the kerosene stove. He pointed to several, orange-crate supported benches which bulged with equipment.

"That's the deevice."

I looked at the collection of commercial, home-brew, and bread-board gear.

"Isn't that a sight?" he asked.

I had to agree that it was.

"Sammy ought to be on right now. Soon as everything warms up we'll be hearing *moon-bounce*."

I looked at the equipment. A commercial power supply with controls completely foreign to the ordinary ham (me.) A rack full of what I think were filters of various kinds. The only recognizable object was a BC 453 surrounded by a dozen tubes and i-f cans to "get the frequency down to earth."

Jack bent over the receiver, pointed to a spot on the dial, and said that was Sammy's frequency. He rocked the receiver dial back and forth, squealed the Q-multiplier a couple of times, and adjusted the parametric amplifier power supply.

"I don't hear him," he said with mock incredulity. "I can't understand it." He looked at me as if he expected me to come up with a solution.

"I know," he said, "we forgot to point the *thing*." He laughed at his joke and pushed

the warped, coop door.

"You tune and I'll aim," was his parting shot.

I moved to the door to watch him point the antenna. When he had it untied and free-swinging, he aimed it roughly at the moon, then climbed a step ladder at the base of the mount to check his compass readings against his pocket-chart. After several trips up and down the ladder, several looks at the chart, and innumerable sightings through the telescope, he tied everything down and came back inside.

"Hear him yet?"

I had neglected to tune. Getting the dish on target was a fascinating operation. Jack rocked the 453 dial back and forth. He squealed the Q-multiplier. He looked at his watch.

"Be about a minute before the moon catches up with the dish," he said, and went back to tuning. We listened to the roar and hiss come out of the small speaker. Jack boosted the volume and started a rustic tape recorder. He again looked at his watch.

"Maybe the moon's running a little slow tonight," he said, and then laughed.

UHF noise, tube noise, and Q-multiplier squeal filled Building C and much of the empty countryside.

"Hear anything, David?"

"No," I said.

"You don't?"

"No."

"Well, I don't either," said Jack. "Must be something wrong."

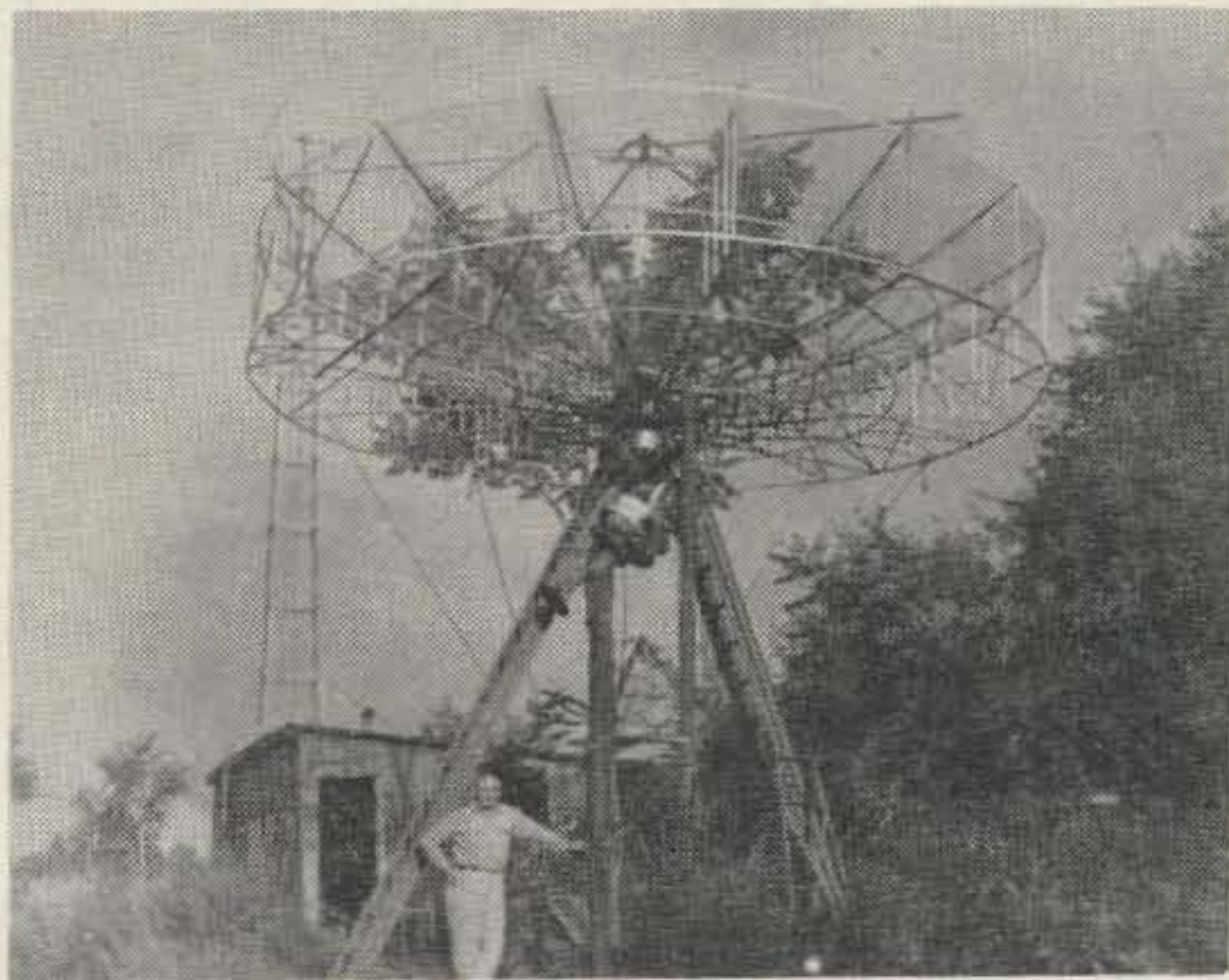

We went outside. As Jack gently nudged the dish, I sighted the moon through the telescope.

"Put the cross hairs on the leading edge of the moon."

I did as I was told. The cross hairs were just off center. At that moment, from Building C, came a low, beat note. It went off, then came on again.

"There's old Sammy. We found him," said Jack. "I knew he was there. Just takes a bit of looking."

He was there. And loud. From the Rhododendrom Swamp of Waltham, Mass., to the moon, to the semi-wilderness of Dorset, Ohio

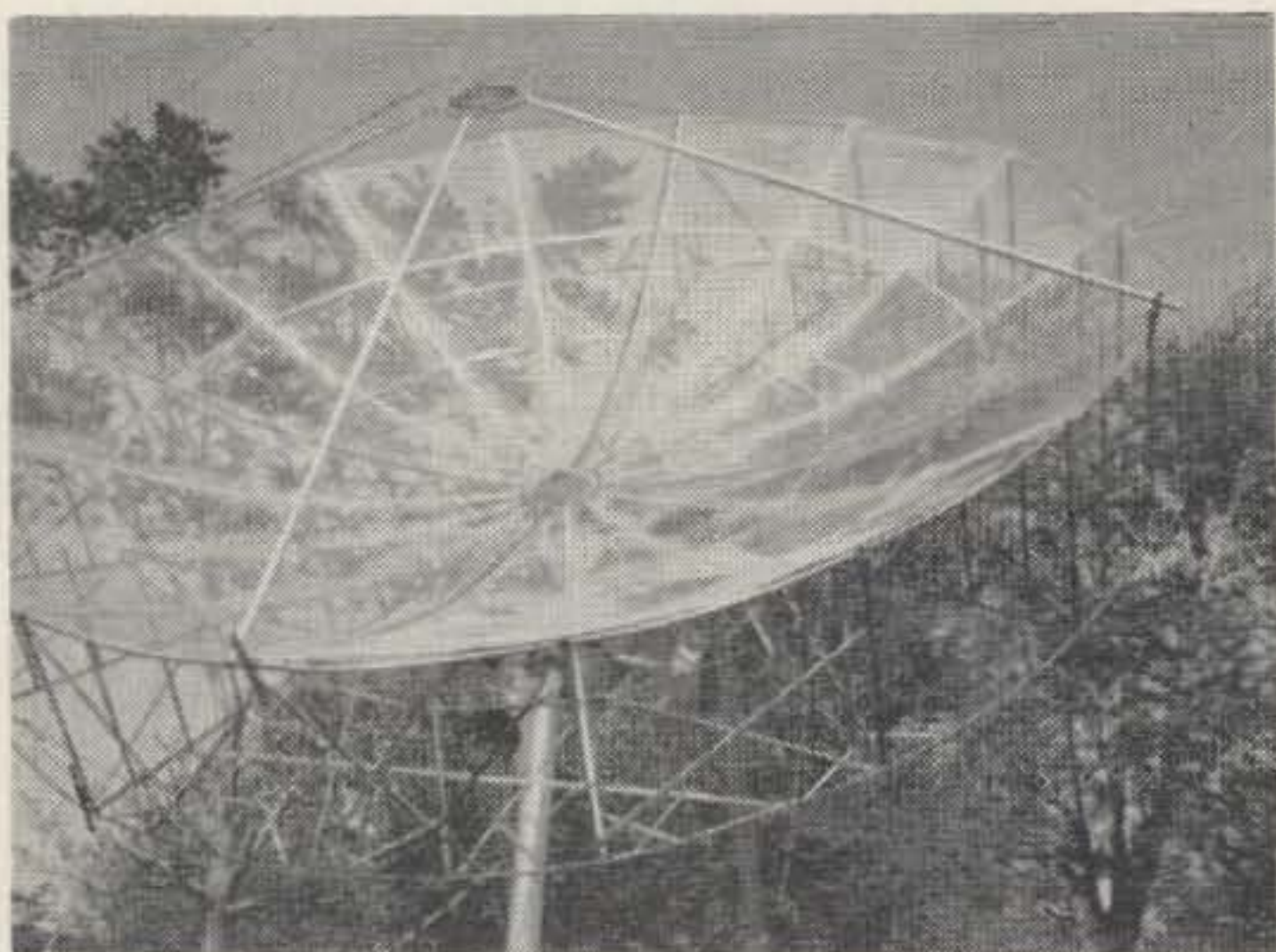

in about two seconds. Quite a trip at 1296 megacycles. And there I stood on a ladder under a chicken-wire dish listening to the wavering note.

"He's not very loud yet," said Jack.

I thought he was at least S-9 on any conservative meter.

"You got it on the leading edge?"

I checked the moon in the cross hairs.

Jack tied the antenna down while I kept him sighted on target. We went inside to listen to the loud series of dashes which signalled another success for Jack and Sam. After we listened for a few minutes, the moon moved on and the signals faded out. Jack rewound the tape recorder and lifted off the tape.

"That was a pretty good test," he said with rare modesty. "Let's go in and play this to Sammy."

The familiar sideband kilowatt at W8LIO was warmed up (as usual) and set to 7250 kc for the schedule with W1BU/W1FZJ.

"Hello, Sam; Hello, Sam; Hello, Sammy. This is W8LIO calling you. W1BU, this is W8LIO."

Immediately came the answer.

"W8LIO, this is W1BU."

This standard reply caught Jack off guard.

"Who's this?" he asked.

"This is Lew, W1ICP."

"Is Sammy there, Lew?"

"He's coming in now."

"OK. I'll play my little tape for you boys if you're ready."

Jack started his battered tape recorder, a twin of the one in Building C. He plugged the output of the recorder into the 20-A and

the 4-1000 linear lighted up with what, moments before, had been a 1296 mc signal. After playing a minute or so of the loudest portion of the tape, Jack picked up the microphone.

"I guess my receiver is working OK, eh Sammy?"

"It sounded pretty good tonight," said Sam. He's not noted for superlatives.

"What did you think of it, Lew?" asked Jack.

Lew, it seemed to me, sounded a little breathless. If so, it was understandable.

After the schedule was affirmed for the following evening and W1BU had signed off, an AM station came on the frequency complaining about the nuts who imitated Russian jamming signals. I suppose Jack's tape recording did sound a bit like a jamming station. It oc-



Fred Collins W1FRR tuning W1BU

curred to me then that hams are in two general categories: the pioneers and everybody else. For a moment that night, I was among the pioneers. . . . W8GUE/6

More About Club Subscriptions

Same message as last month. Clubs subs are only \$2.50 each in groups of five or more subscriptions. Please list name, call and address. Subs must all start with next published issue. All back issues must be ordered separately at 50¢ each. Clubs must be absolutely bonafide, having been in existence for at least ten minutes before ordering group subscriptions.

Moon Relay Requirements

Bill Ashby K2TKN
Box 97
Pluckemin, New Jersey

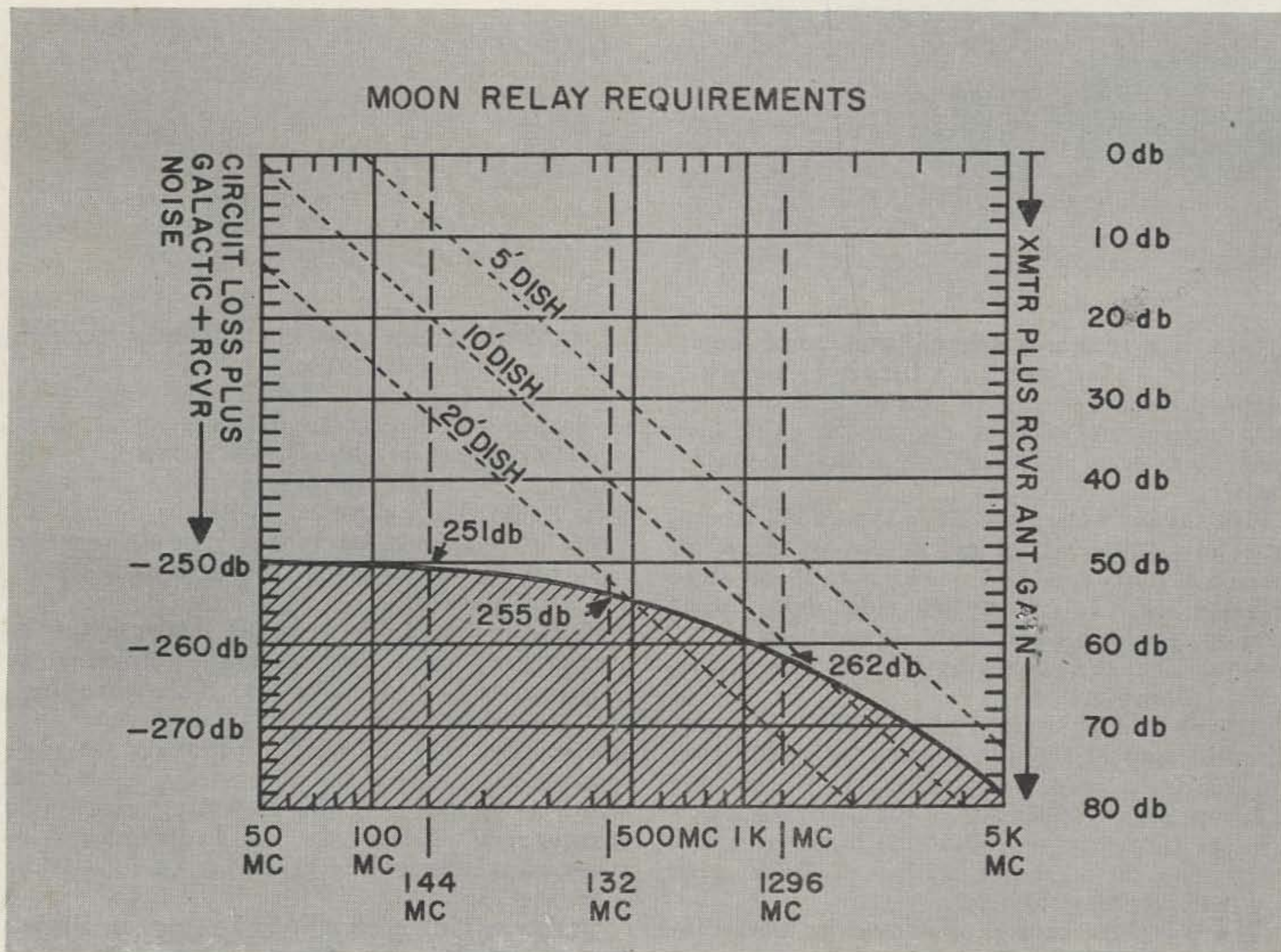

Given: Receiver sensitivity of -175 db below 1 watt.

Transmitter power output of 300 watts on CW or SSB.

Add: Actual gain in db above a dipole of both receiving and transmitting antennas, less feedline loss.

Place this gain on chart on the frequency you are using. The number of db this extends into the shaded portion gives you the signal/noise ratio.

Faraday Shift and other fading: 10 db minimum

Doppler Shift: 3.5 cycles per megacycle maximum

Why?

If you can get 10 db into the shaded portion you can talk to other amateurs up to 12,000 miles away 365 days of the year!

This is based upon recent, extremely accurate, moon circuit loss info and agrees with every actual bounce we know of . . . W4AO, W1FZJ, W2NLY, W ϕ ETJ, etc. With the biggest 50 mc antennas you could get up (20 db) it would take 3 KW output from the transmitter. On two meters (23 or 24 db antenna) it takes a full KW output (not input). And this just gets the minimum detectable signals.

. . . K2TKN

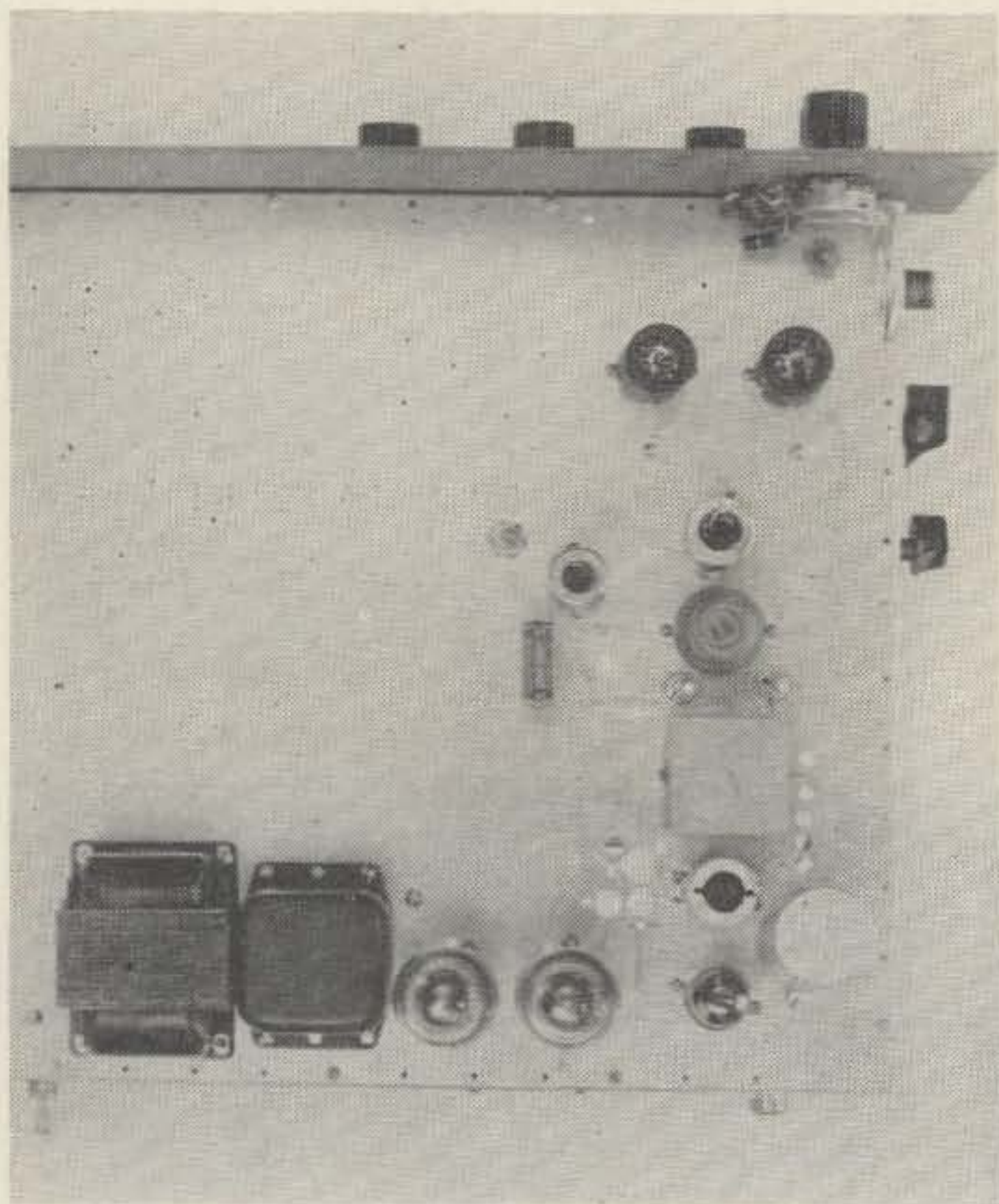

Simple Super Sideband

Angel Fernandez W2NQS
2017 Homechest Avenue
Brooklyn 29, N. Y.

SOME like single sideband and some don't as the saying goes, but like it or not this sideband exciter can give you a taste of sideband operation with a rig in the Cadillac class at a price more in line with "compact" quality.

Built around the new RCA type 7360 beam-deflection tubes, it gives 60 db or more of carrier suppression and more than 40 db suppression of the unwanted sideband. These figures become all the more astonishing when you note that it's a phasing-type exciter rather than a filter rig.

Before you rush into the shack and start slinging solder, though, please note that this unit as described is an exciter *only*. Its output is 1 volt peak-to-peak at 1700 kc. It still needs a mixer to get to your favorite band, and this mixer can be combined with a VFO to give you bandhopping ability.

The complete exciter is shown in block-diagram form in Fig. 1. RF generated by the carrier oscillator is fed into a phase-shifting network and from there into a pair of 7360's. Audio from the mike, meanwhile, is amplified and phase-shifted separately. Each audio channel is then phase-split to get a push-pull signal, and these two push-pull audio signals are also fed to the 7360's.

To those familiar with phasing exciters, this block diagram won't look too different from the conventional type. Just a different kind of balanced modulator, that's all. But therein lies the secret of success, for adjustment of the 7360 balanced modulator is simple and straightforward, unlike adjustment of the conventional diode-ring or lattice modulators. What's more, the balance adjustments, once

made, don't creep and consequently require little readjustments later.

One note about the 7360 at this point. Like all cathode-ray tubes (and that's about what it is, although it doesn't look much like the usual CRT) this bottle doesn't like stray magnetic fields. They play hob with its operation. Therefore, it must be kept as far as possible from all such chunks of iron as transformers and filter chokes.

Keeping this point in mind, construction is straightforward. The schematic diagram is shown in Fig. 2. You can use the chassis layout shown in photo or fit it into your own space; however, if layout is changed be sure to keep all components and wiring associated with the plates and the deflecting electrodes symmetrical. Extremely small differences in stray capacitance can give you balance troubles later on.

Construction is simplified by use of Vector turret sockets, permitting each section to be wired separately and installed in the chassis after wiring is finished.

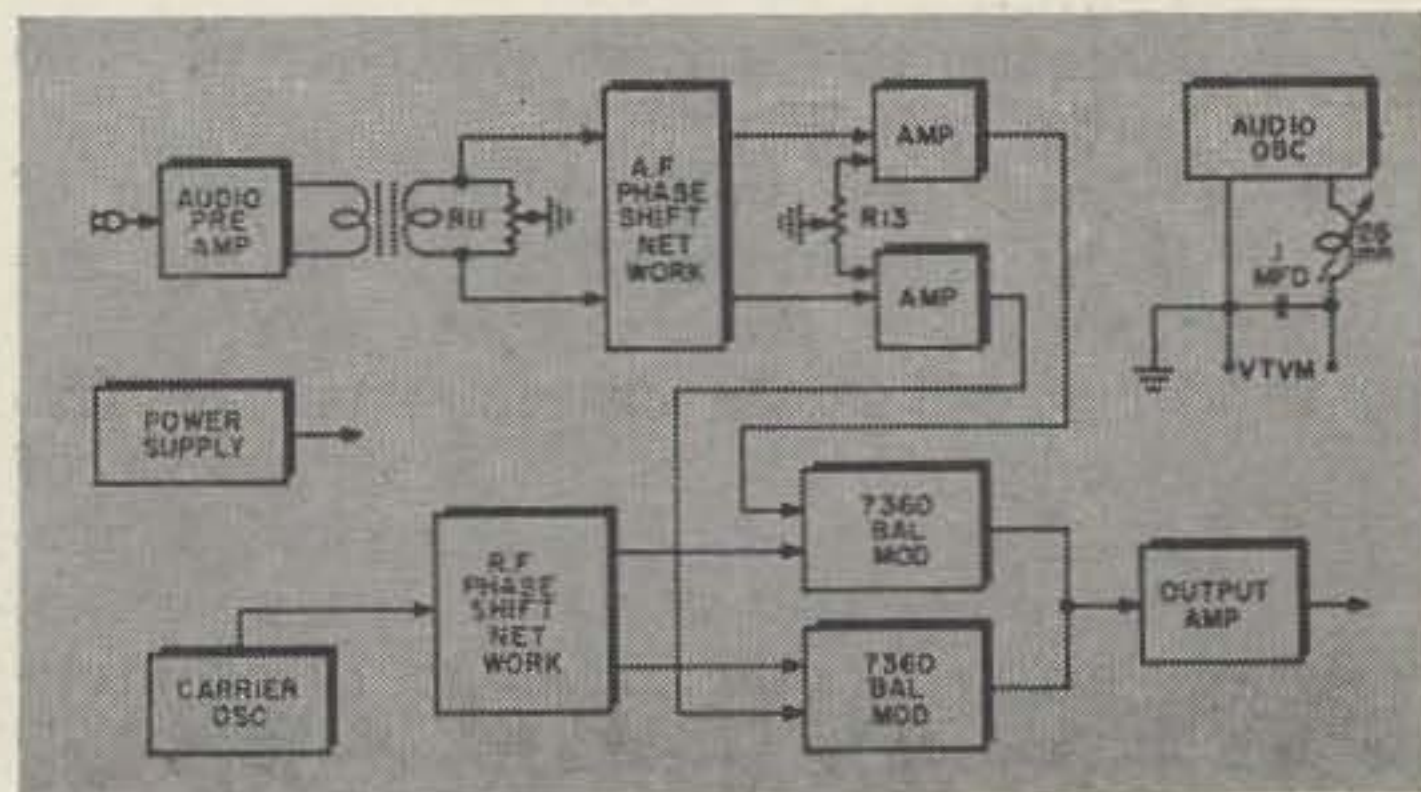

Fig. 1

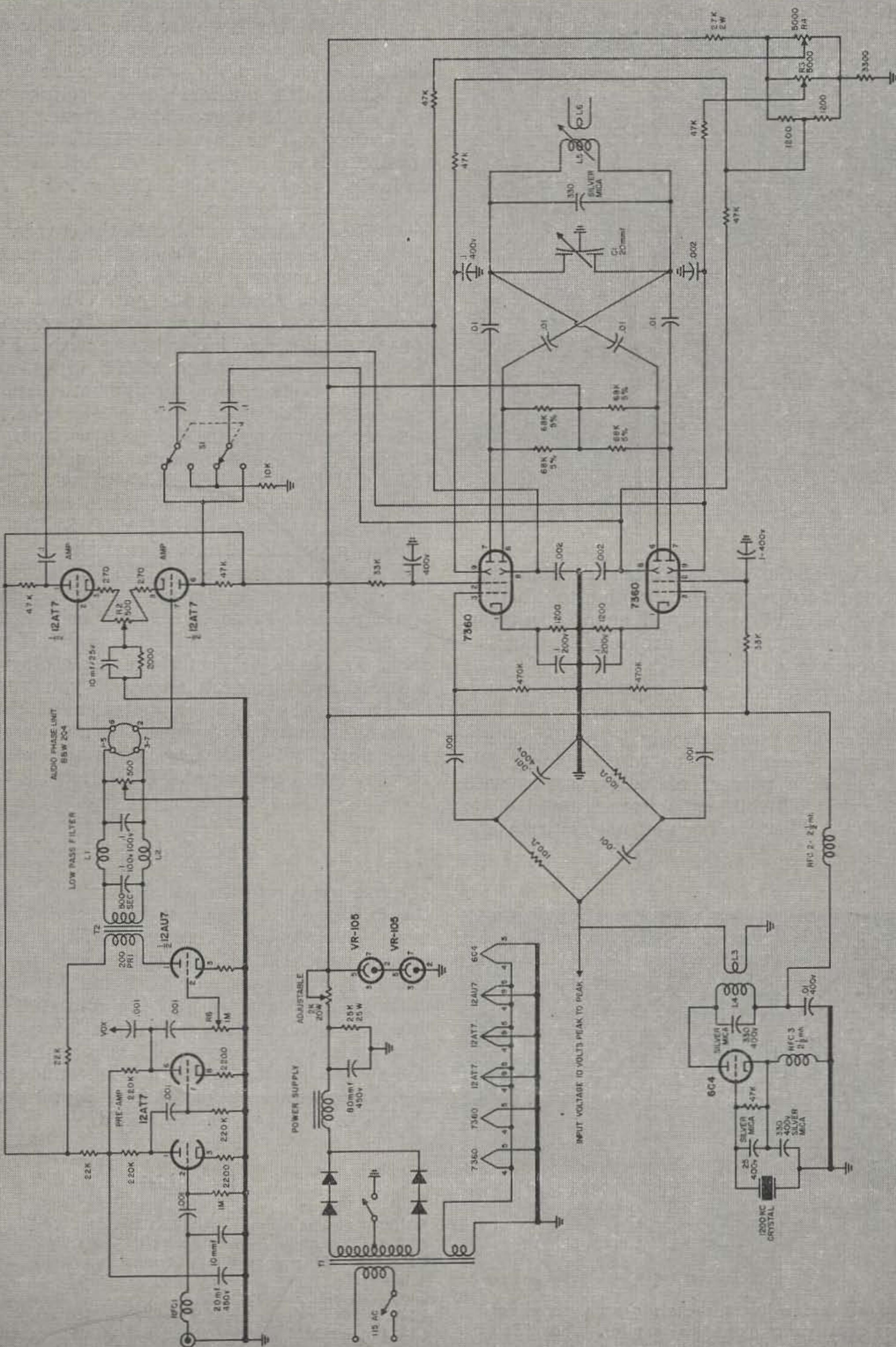
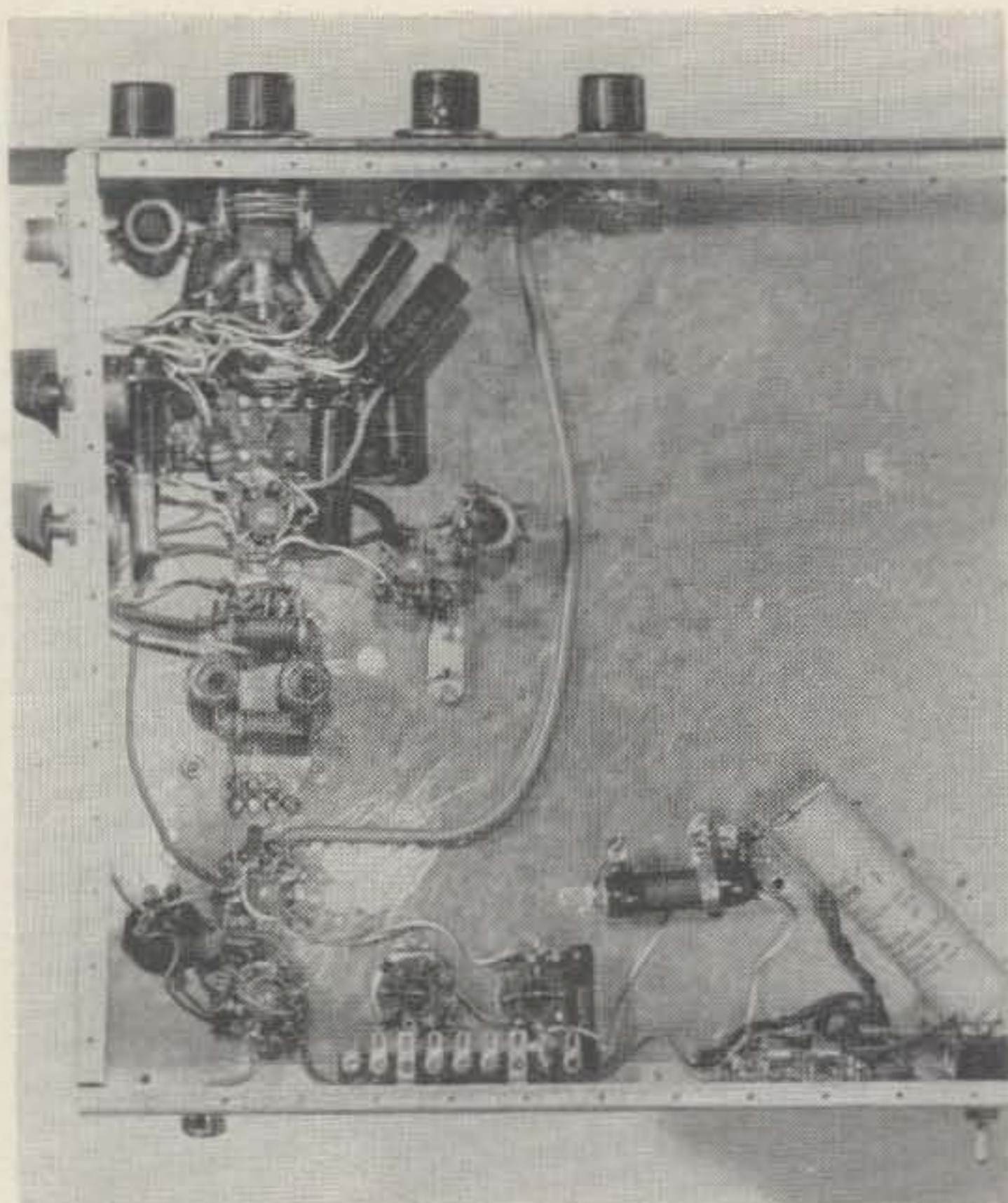

Fig. 2



Once built, the rig must be adjusted. Initially, you need a receiver tunable to 1700 kc, a VTVM with rf probe, and an af oscillator. Operational adjustments are made using the shack receiver only.

Initial adjustment of the exciter is as follows:

1. Check the power supply to make certain its output is humfree. One way of doing this is to connect a pair of phones in series with a 0.1 mfd 600-volt capacitor from B+ to ground (CAUTION: Turn off power first) and listen.

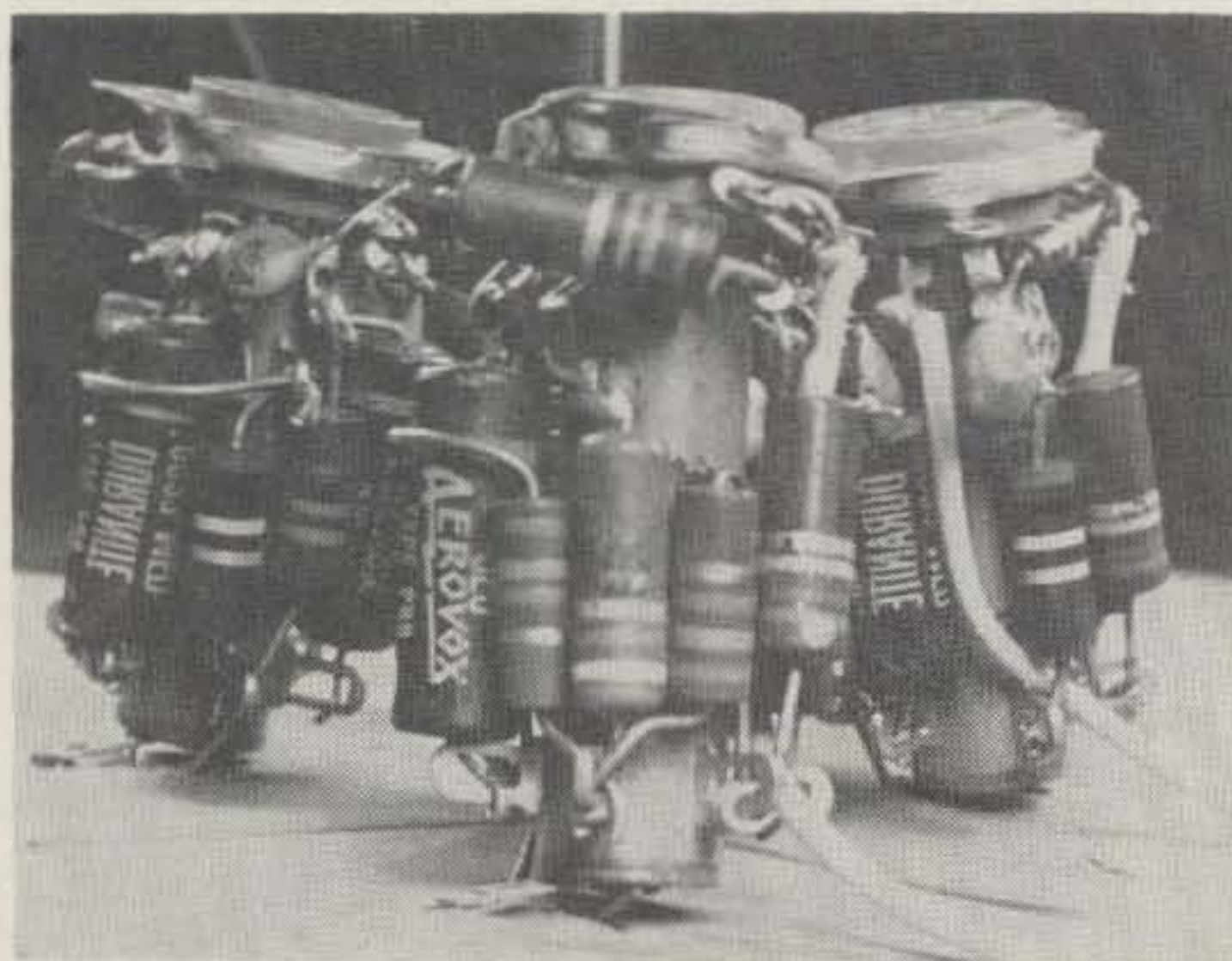

Use of vector turret sockets greatly simplifies the construction of this exciter. This 7360 balanced modulator looks more complicated than it is due to the artistic double mirror photo by W2QDM who wanted you to see all sides at once.

2. Adjust R5 until the VR tubes glow. Make certain that they remain lit with the exciter operating; if they go out, readjust R5.

3. Resonate the low-pass filter at 3 kc using an af oscillator as shown in Fig. 5 and adjusting for maximum indication on the VTVM.

4. Adjust LA until measured voltage from pin 6 of the 6C4 to ground is -18 vdc.

5. Apply a 1 kc signal to MIKE input and monitor voltage at pin 6 of V3. Adjust R6 for a reading of 1 volt RMS (2.8 v P-P). Mark setting, return to zero.

6. Using the receiver, locate the carrier near 1700 kc. Unbalance R3 and R4 and peak the signal with receiver tuning. Adjust R3 and R4 in turn until signal nulls out. When adjustment is correct, the carrier will be completely gone and cannot be located even with BFO.

7. With 1 kc signal at MIKE input, adjust R6 until receiver S-meter indicates approximately S-8. You should hear a 2-kc tone. With receiver selectivity in sharpest position, tune higher in frequency until S-meter peaks. Place SIDEBAND SELECTOR switch in position 1 and adjust R1 and R2 in turn to null out the signal. Place SIDEBAND SELECTOR switch in position 2 and signal should return.

8. Return switch to position 1 and *slowly* tune 2 kc lower in frequency until signal is again peaked. Place switch in position 2 and touch up adjustments of R1 and R2 if necessary. These adjustments are something of a compromise, but even at worst you will get something like 40 db suppression of the unwanted sideband. Adjustment is now complete. Feed output of exciter to mixer and amplifier of your own choosing and BCNU on the bands.

9 Mc Output

Since many of you will be wanting to have the output on 9 mc, you will want to know what changes are necessary. The oscillator should have a 3 uh coil (L4) made up of 11 turns of #26 enam. on a National XR-72 form with a three turn link on the cold end of the winding. Change the crystal to a 9 mc crystal. The plate condenser should be changed from 330 to 100 mmfd. The two .001 condensers in the bridge circuit of the oscillator output should be changed to 175 mmfd.

Parts List

R1-R2—500 ohms linear Ohmite CU-5011 2W
 R3-R4—5000 ohms linear Ohmite CU-5021 2W
 C1—20 mmfd per section differential variable Johnson 160-311
 RFC—2.5 mh National R50
 L1-L2—TV linearity coil, Miller 6315 4-30 mh
 L3—4 turns #26 enam. on cold end of L4
 L4-L5—43 turns #26 enam. on 3/4" diameter form, National XR-72
 L6—4 turns wound on center of L5

... W2NQS

73

TESTS

the Knight-Kit G. D. O.



Stephen Abrams W2OKU

BY now the reader of 73 Magazine must be rather familiar with the subject of grid-dip meters. The circuits are basically similar; the sizes of the "boxes," likewise; the fre-

quency ranges, ditto. Why, then, the great number of articles? There are at least two reasons. The first is simple. Give the reader a sample of what is available in specifications and equipment. The second is only slightly more subtle. Occasionally a manufacturer will provide a "something" in his equipment, either making its use more convenient or providing a novel usage, that may make it more worthy of consideration by the buyer. This kit, happily, satisfies both reasons.

The Knight G-30 lists for \$22.95, and is available only in kit form. It covers the frequency range from 1.5 to 300 mc in six bands as listed in the specifications column. The case is of satin finished aluminum and occupies a space of $6\frac{1}{4} \times 3\frac{1}{8} \times 1\frac{1}{2}$ inches. The completed unit is quite light, weighing in at 1 lb. 10 oz. This, combined with the serrated dial extending beyond the case, permits easy one-hand operation.

In any grid-dip meter a point of major interest is the frequency scales. In this kit the prewound plug-in coils which determine the frequency range have been color-coded to correspond to similar coloring located on the case below the markings on the clear plastic tuning dial. If you have ever used a GDO and suddenly found yourself wondering which scale should be read you would appreciate this feature. The scales are clearly marked on the

(Continued on page 37)

Price: \$22.95**Time for construction:** One evening**Range:** 1.5-300 mc

Red 1.5-3.5

Violet 3.4-8.5

Blue 8.2-20

Orange 19 -45

Yellow 45 -110

Green 105 -300

Input power: 105-125 volts, 50-60 cps,
at 3 watts

Uses: Determine tuned circuit frequency
Determine circuit Q
Measure inductance
Measure capacitance
Phone and CW monitor
Crystal tester and market generator
Signal generator
Neutralization adjustment
Parasitic and harmonic checks
Coarse frequency measurement

PROPAGATION CHART

EASTERN UNITED STATES TO:

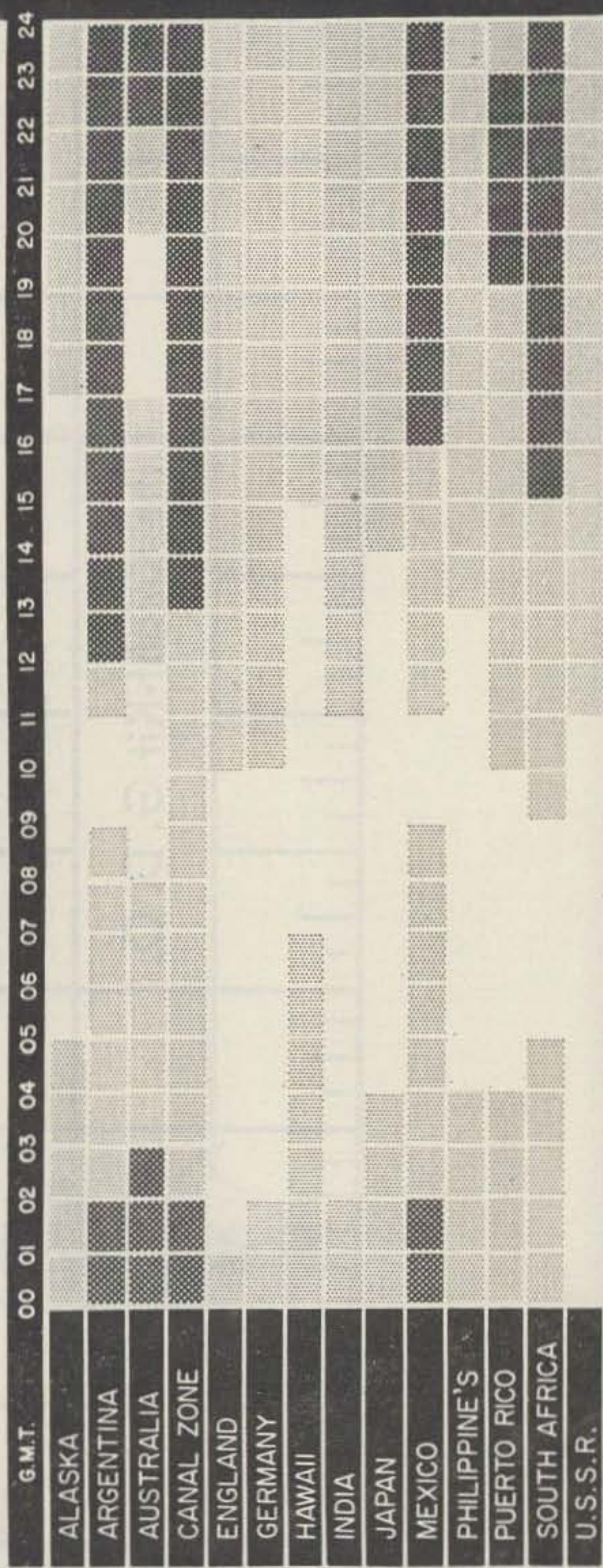

CENTRAL UNITED STATES TO:

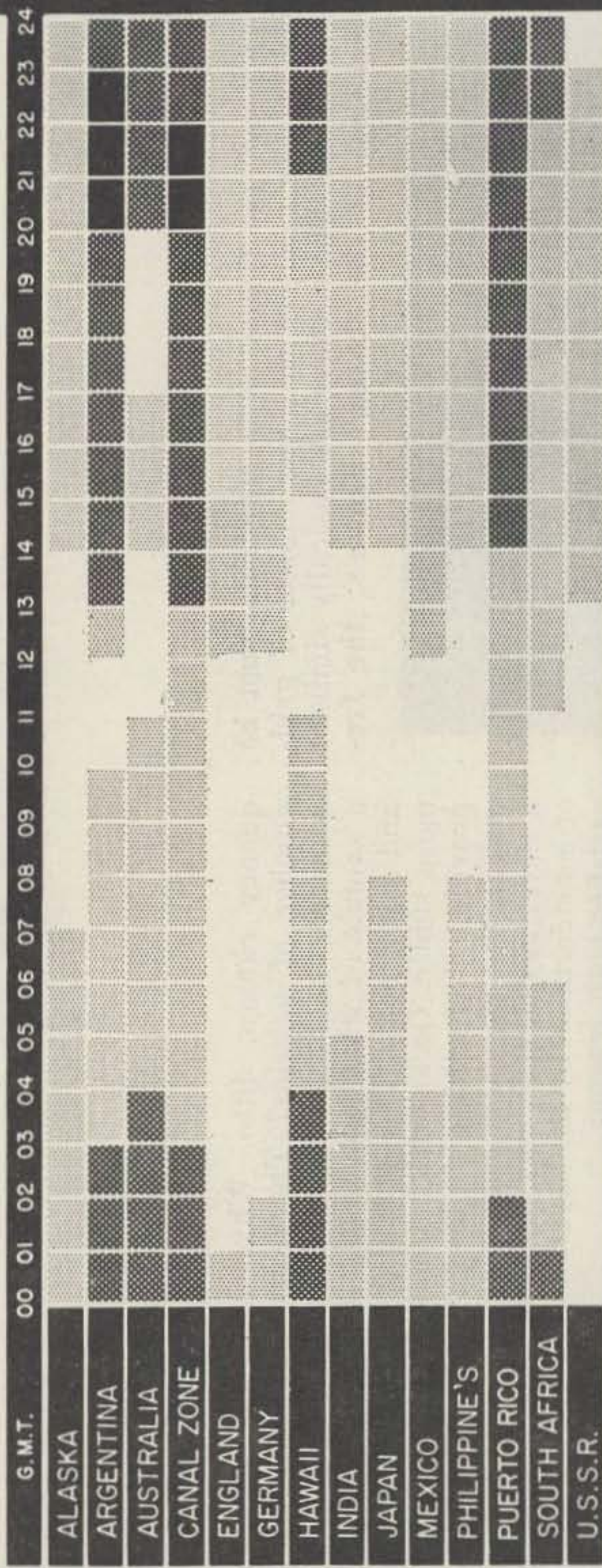

WESTERN UNITED STATES TO:

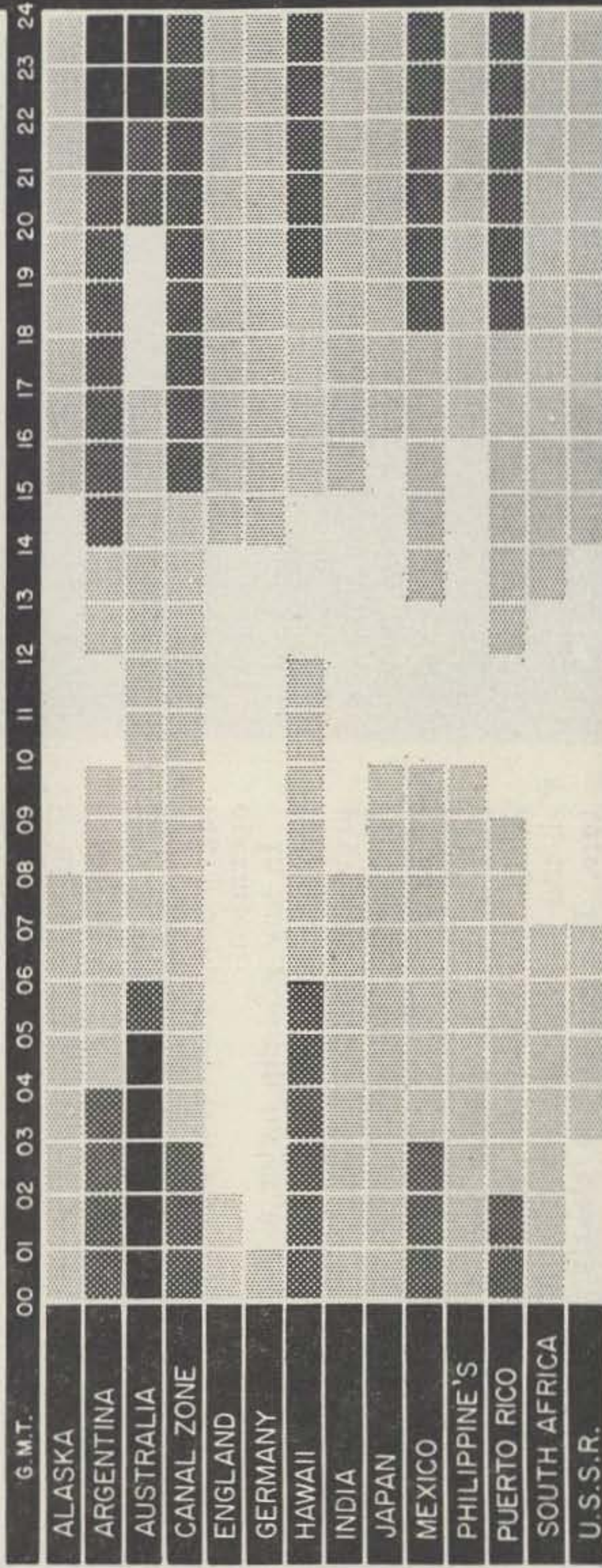

LEGEND

7 MC

14 MC

21 MC

28 MC

Propagation Charts

David A. Brown K2IGY
30 Lambert Avenue
Farmingdale, N. Y.

The bands listed are MUFs and a higher band will not work for the time period listed. Lower bands will work, but not nearly as well. Times are GMT, not local time.

These charts are to be used as a guide to ham load openings for the month of May, 1961 to the various countries listed. I will be interested to hear of your results in using these charts and to know what other areas you might wish included in future charts.

Advanced Forecast: May 1961

Good 6-7, 16-18, 20-31

Fair 1, 3-5, 8, 12-15, 19

Bad 2, 9-11

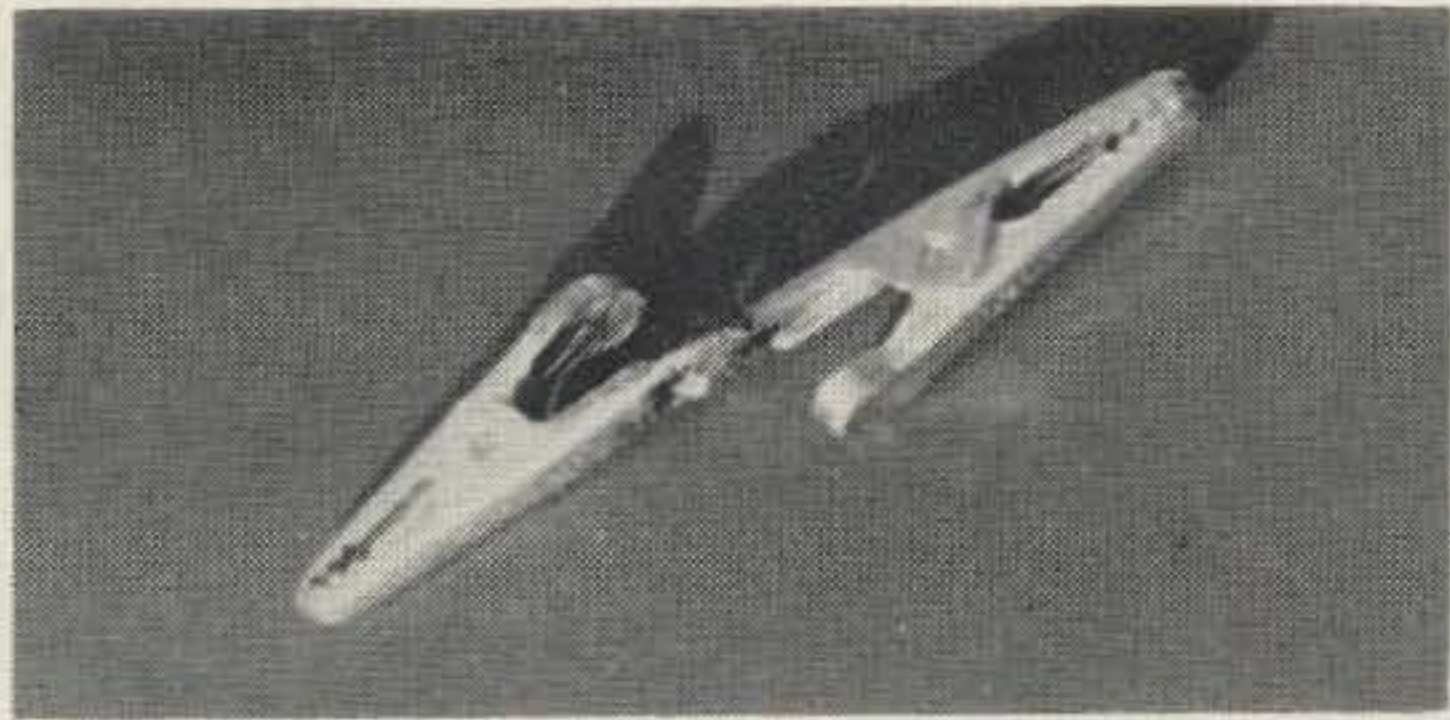

Quick and Cheap

Experimenters will find a miniature double clip, made by soldering two of the smallest alligator clips together end to end, an almost indispensable aid to breadboard construction of electronic projects. Using the miniature twin-clip eliminates soldering of components in early assembly stages, and allows instant substitution when determining exact parts values for experimental projects. Cost of the midget clips used to make the tiny twin-clip is 7 cents each in individual quantities, or 44 cents for 10—making the twin-clip's cost negligible in comparison to the cost of parts saved through its use.

... K5JKX

(G.D.O. from page 35)

knob with little chance for parallax as there is only small clearance between the scale and hairline. The quality and quantity of the dial markings are suitable for the ranges presented. A particularly desirable feature of this unit is the inclusion of a movable hairline. This permits the exact setting of a particular frequency and a higher than normal frequency accuracy for the immediately surrounding region of the dial. The data plotted in Fig. 1 was taken by setting the hairline to a measured whole-number frequency near the center of the range tested, and varying the dial setting from that point. Setting the hairline parallel to the length of the chassis, as is done in the initial calibration, results in frequency accuracies comparable to other units in the same price range.

The stability of the unit with changes of line voltage was found to be almost independent of operating frequency. The average shift was 190 cps/volt of line variation. As this variation was measured for voltages from 90 to 130 vac (let's hope yours is never worse), ac line stability should be no problem.

Construction of the meter proved to be quite easy as the instructions are almost childishly simple. Care must of course be taken in wiring the rf circuits. The unit was built in the course of one evening with no perspiration appearing on the brow of the assembler. It is pleasant to be able to state that it worked immediately; due credit must again be given to the instructions. It is worth noting here that the manual accompanying the equipment includes, in addition to constructional details, complete descriptions of how to use the GDO in all the applications mentioned in the specs column. Also included is a reactance-frequency nomograph (easy to use) handy for some of the applications: inductance and capacitance determination.

Electrically the circuit is one which has almost become standard. A 6AF4A UHF triode is used as a Colpitts oscillator with the resonant circuit made up of the plug-in coil and dial driven variable capacitor connected between grid and plate. Provision for the use of headphones for audio monitoring is made with a panel jack which simultaneously removes the indicating meter from the circuit. Use as a wavemeter is accomplished by setting the unit for minimum sensitivity which removes supply voltage from the tube, permitting it to act as a tuned diode detector.

All in all the G-30 is a satisfactory example of a device which should be present in every ham shack. As to why you should have one in your shack, I refer you to the list of uses printed here and to the Radio Amateur Handbook (ARRL).

... W2OKU

Economical Custom Resistors

A Low Cost Approach to the Precision Resistor Problem

Roy E. Pafenberg

THE experimenter, faced with the problem of obtaining precision or high stability resistors, has a variety to choose from. Accurate wire-wound and deposited film carbon resistors may be purchased in many stock values and packaged in a number of configurations. In addition, other sophisticated types are available to suit those with exotic tastes and thick wallets.

Two complications arise which limit the application of these components in the general run of home construction projects. First, the cost is high, ranging from under a dollar for enamel insulated, carbon film types to over \$15.00 for the higher value wire-wound resistors. The second problem is that required values, in the desired tolerances, may not be stocked. This is true despite the wide range of listed values. For example, the catalogs list nearly 500 stock resistance values in the IRC and Texas Instrument lines of encapsulated, deposited film resistors.

The usual answer to the problem of prohibitively expensive components, at least for the amateur or experimenter, is to turn to military or commercial surplus stocks. While this answer is still valid, the chances of obtaining a high percentage of required precision values from these sources are minimal.

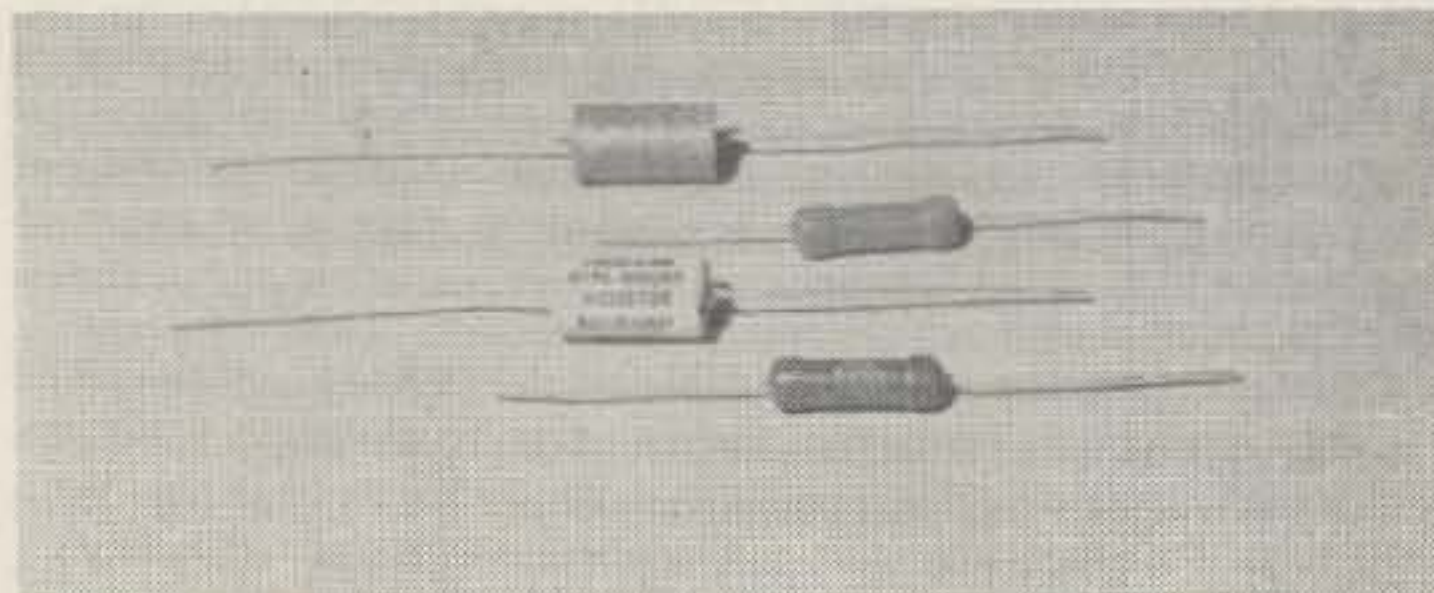

Before and after view of altered resistors. Carbon film unit is protected by nail polish while the wire-wound resistor has a layer of plastic tape applied.

There is a simple, low cost solution to this problem but, before going into the methods and procedures, a look at the basic characteristics of these components is in order.

In general terms, a precision resistor is a

resistor that may be manufactured to very close resistance tolerances, ranging from a small fraction of one percent to about two percent deviation from their nominal value. Such resistors will maintain this degree of accuracy for long periods of time and under adverse conditions of temperature and humidity. Any variation of resistance with respect to temperature is small and, when the temperature is restored to normal, the resistance returns very close to the original value. Each of the types mentioned above fall in this general category.

The conventional precision wire-wound resistor is simply a length of suitable resistance wire, wound on a bobbin or other form, and provided with terminals or leads. Many types are available and the finished resistor may or may not be encapsulated. These resistors may be manufactured to extremely close tolerances and are relatively expensive.

The carbon film resistor consists of a ceramic rod with a layer of carbon combustion products deposited on the outer surface. Termination is effected by crimping end caps and leads on either end of the rod. The resistance is often brought to final value by cutting a spiral groove, through the carbon, for the length of the rod. In this event, the thickness of the film and the pitch of the spiral determine the resistance. The finished resistor may be protected by enamel insulation or may be potted in casting resin. The basic manufacturing process is low in cost and wide tolerance, film resistors are becoming common in all types of equipment. Inspection and testing to close tolerances increases the cost considerably. Even so, they are the least expensive of the precision resistor family, with some types of 1% tolerance available at under sixty cents each.

A review of experimental applications of precision, high stability and/or low noise resistors is in order. Requirements for such resistors fall in four general categories:

1. Precision, high stability resistors of predetermined value and tolerance.
2. Precision, high stability resistors of un-

determined value, the resistance of which must be adjusted, in circuit, to meet known standards of performance.

3. Two or more precision resistors for use where the absolute resistance value is of minor importance, but where the resistance relationship of one to the other must be controlled to a high degree of accuracy.
4. Resistors of the precision type for use where the absolute resistance value is of minor importance but where the characteristics of high stability and low noise are required.

The cost of new stock, carbon film and wire-wound precision resistors is often prohibitive, however both types are readily available on the surplus market. Fantastically low prices are the order of the day. For example, TAB of New York lists them at 35 for \$.99, LEKTRON of Chelsea, Mass. at \$3.00 per pound and Brooks Radio and TV Corporation of New York at 40 for \$1.00. Both the carbon film and wire-wound resistors, of the un-encapsulated types, may be changed in value to meet specific requirements. The job is relatively simple and pays off in dollars saved.

The first step in producing custom resistor values is to obtain an instrument of sufficient accuracy to satisfy the application at hand and this requirement can vary widely. In the



Carbon film resistor is quickly raised to desired value by removing a portion of the carbon film with sandpaper.

simplest case, where the value of a resistor must be adjusted to achieve known standards of equipment performance, only the test equipment normally required for maintenance of the device would be needed. In other cases, where stability rather than extreme accuracy is the objective, a good ohmmeter may suffice.

A resistance comparator bridge, such as described in the December, 1959 issue of *Radio-Electronics*, is a low cost solution if very close tolerance, matched resistors are required. In the article, "Match Resistors Fast," I. Queen gives construction details for a very inexpensive but very accurate instrument. As a matter of fact, the money saved on a couple of matched pair requirements will probably cover the cost of the parts to build the bridge and a reasonable stock of surplus, carbon film resistors.

However, for those applications where absolute resistance value is of importance, an accurate resistance bridge is the best answer. These instruments, though simple and widely used, are relatively expensive. Substantial savings can be obtained on the surplus and used equipment market but the cost is still high. If a bridge is not available, it should not prove too difficult to secure the use of one for the short time required. Suggested sources are the larger distributors, trade schools, public schools and private industry.

Enamel insulated, carbon film resistors are very easy to adjust to any reasonable, higher resistance value. It is recommended that the initial value be at least half the desired value



Wire-wound resistors respond to similar treatment. Preset the bridge to the desired resistance value and connect one end of the resistor to the bridge. Unwind resistance wire from the free end of the resistor, passing it through the other terminal of the bridge, until the bridge indicates balance.

to avoid stability problems and excessive reduction in the wattage rating of the resistor. To change the value of the resistor, mount the unit on the bridge terminals and adjust the bridge to the desired final resistance value. Loop a strip of fine sand or emery paper over the body of the resistor and sand lightly until the bridge indicates balance. Proceed cautiously to prevent undue heating of the resistor and to avoid overshooting the desired value. This method is foolproof and is both quick and accurate. The photograph shows the procedure and it is as simple as it appears. A coat of nail polish, in your favorite shade, will provide moisture protection and give a custom appearance. Marking decals may be added for a truly custom job.

Wire-wound resistors respond equally well, although the technique is slightly different. The resistor selected must be of higher resistance than the desired value and the reduction in wattage rating will be in direct proportion to the percentage of resistance wire removed. Expose the resistance winding, clip and then unwind a portion of the winding. Set the bridge controls to indicate the desired value and connect the undisturbed terminal of the resistor to one terminal of the bridge. Continue to unwind the resistance wire and slide the wire through the other terminal of the

bridge until balance is indicated. Enamel insulation can be scraped on the terminal post to make contact until the balance point is approached. Portions of wrapped insulation may be removed in a similar fashion. When the balance point is localized to a few inches of wire, carefully remove all the insulation in that area and arrive at the final balance point with the wire securely clamped in the terminal post. Mark this point, slide a length of insulating tubing over the bare wire, and rewind on the bobbin. Carefully solder the resistance wire to the terminal and measure the resistance to insure that nothing has gone wrong. A layer of plastic tape around the bobbin will provide protection and give a commercial appearance.

The photograph shows the method used. The time required to adjust a resistor to the desired value is less than that expended in reading a description of the method. The remaining photograph shows before and after views of both carbon film and wire-wound units.

The techniques outlined above will provide, at nominal cost and little effort, precision resistors for experimental applications and will permit their use in projects where their cost would normally be prohibitive. Improved and predictable performance of critical circuitry are two of the major advantages gained.

Calibrate VOM AC Scales

The average VOM can be checked for accuracy quite easily on DC and OHMS scales (using mercury cells and precision resistors), but the AC scales are usually a problem. Trying to calibrate the instrument using the line voltage as a standard is generally a waste of time, since variations are so great and unpredictable.

For less than twenty dollars, you can purchase a device that will act as a stable regulated supply for small instruments and also serve to calibrate your VOM within one half percent! Select a Raytheon Voltage Regulating Transformer, according to the wattage of the other instruments you want to power. I chose the 30 watt model, and use it to power my VTVM and my scope calibrator. The output of each of the available transformers is 115 volts, RMS, 1/2% tolerance.

To calibrate your VOM, simply connect the test leads to the transformer output socket. A word of caution: the output of the transformer is not a sine wave, and cannot be used to calibrate peak-to-peak VTVMs. Confine your tests to RMS sensing instruments, such as VOMs, and you'll be rewarded with accurate and de-

pendable readings.

. . . Bentley



Ohms by the Yard

Jim Kyle K5JKX/6

ESPECIALLY in the breadboard stages, a rig often requires a high-resolution voltage divider or potentiometer capable of being set within less than half a degree—or in more usual language, capable of being adjusted to within a fraction of a volt yet having an overall range measured in tens of volts.

A case in point is a 1296 mc parametric amplifier recently described elsewhere, which uses a surplus 2K21 as the pump-frequency generator. This reflex klystron is electrically tuned, and adjustment of the repeller voltage must be exact.

An expensive answer to this problem is a 10-turn potentiometer. This gadget, unknown to many hams but common in the analog-computer field, requires 10 full turns of the input shaft to travel from one end of its range to the other. You might call it a potentiometer with bandspread. The price puts quite a spread on the bank balance, too—it costs a minimum of \$10.

Here's a less-expensive device which does

the same thing. It can be substituted as a unit anywhere a 10-turn pot is specified, but even if all parts are purchased new will cost you less than \$6. The \$4 saved will more than pay for a year's subscription to 73.

As shown on the schematic diagram, this unit has a total resistance of 100,000 ohms. It was developed for use with the 1296 mc paramp previously mentioned. To adapt it to any other total-resistance value, simply adjust all resistance values in proportion.

Basically, this gadget is a switched voltage divider, one leg of which is an ordinary TV-type potentiometer. Each switch position moves the potentiometer one-tenth of the way up its range, effectively dividing shaft motion by 10 as a result. Thus, with the switch in position 1 and the potentiometer dial set at 20 percent of full rotation, the wiper arm is 2 percent of the way up the total range. In the same switch position with the pot all the way up, the wiper is effectively at the 10 percent point. Moving to switch position 2 and

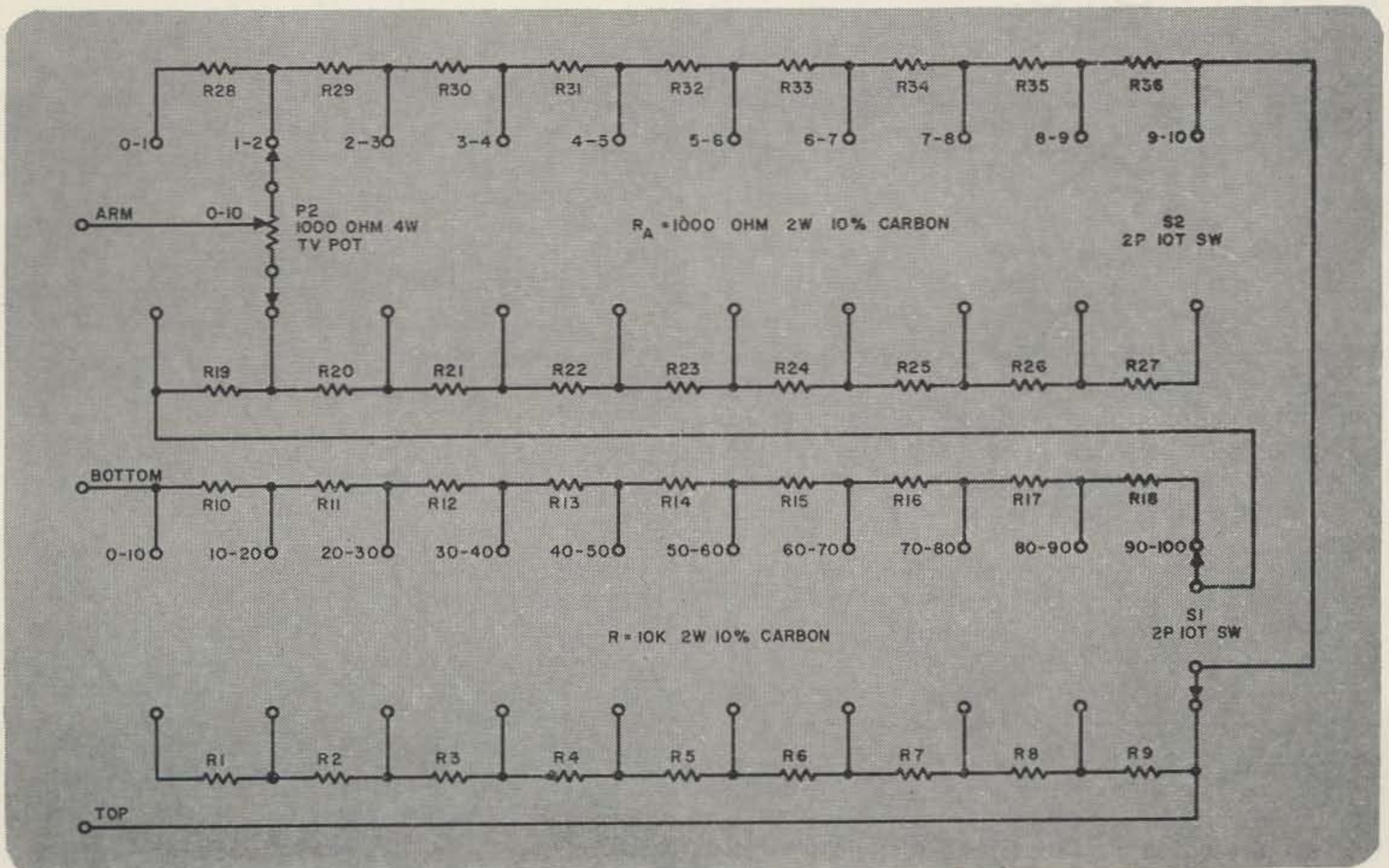

Fig. 2

setting the pot at zero maintains the 10 percent point, while opening the pot to 20 percent on position 2 gives you an effective 12 percent of total range. In this manner, the entire range is covered.

The idea can be expanded by adding one more switch and 18 more fixed resistors as shown in Fig. 2 to give the equivalent of a 100-turn potentiometer at the same cost as a standard 10-turn unit. This amount of resolution would allow you to choose an output voltage between say 50 and 150 volts to within 0.01 volt if desired (a diagram of such a supply is shown in Fig. 3.) For most purposes, though, the unit of Fig. 1 will suffice.

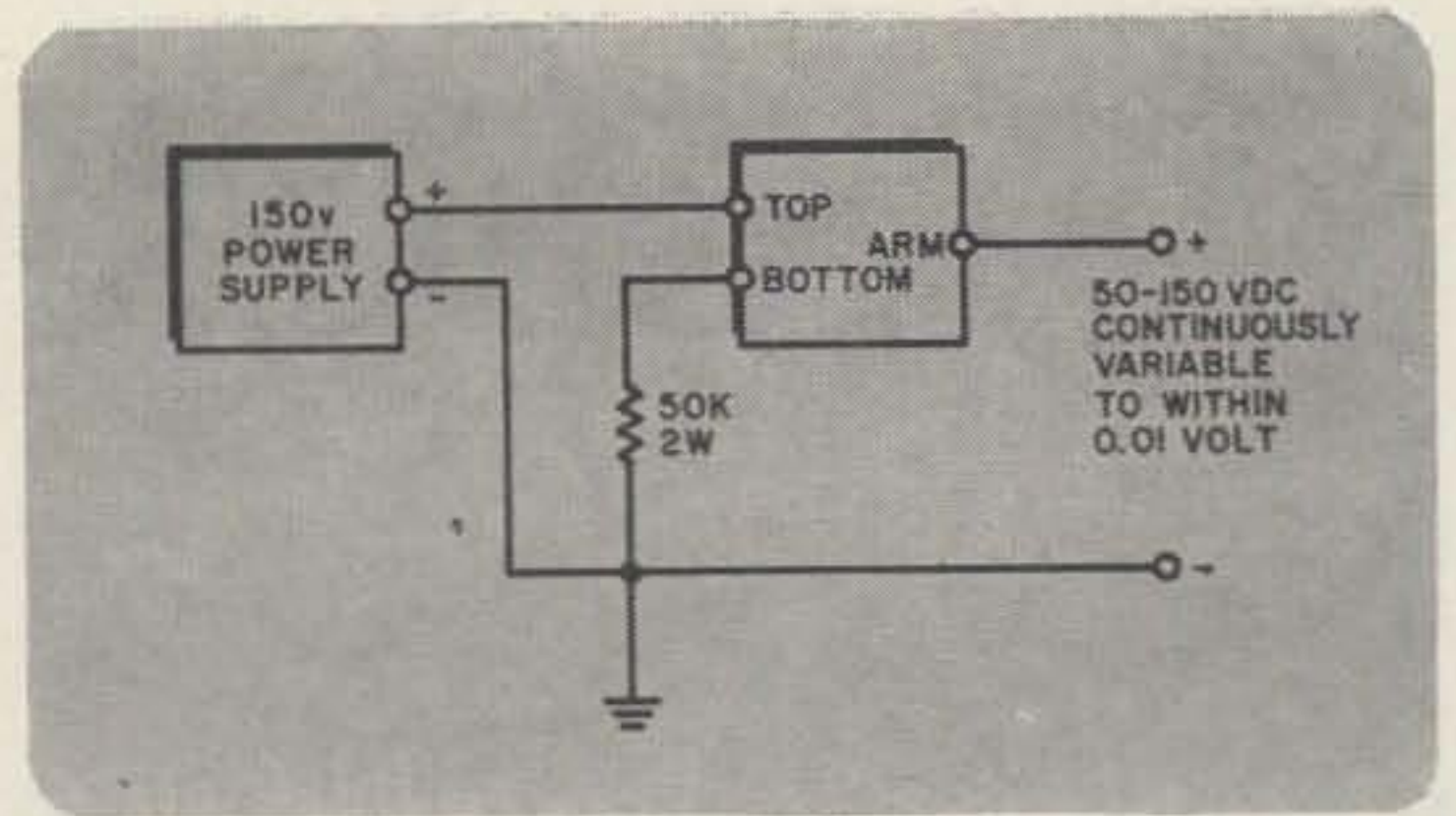
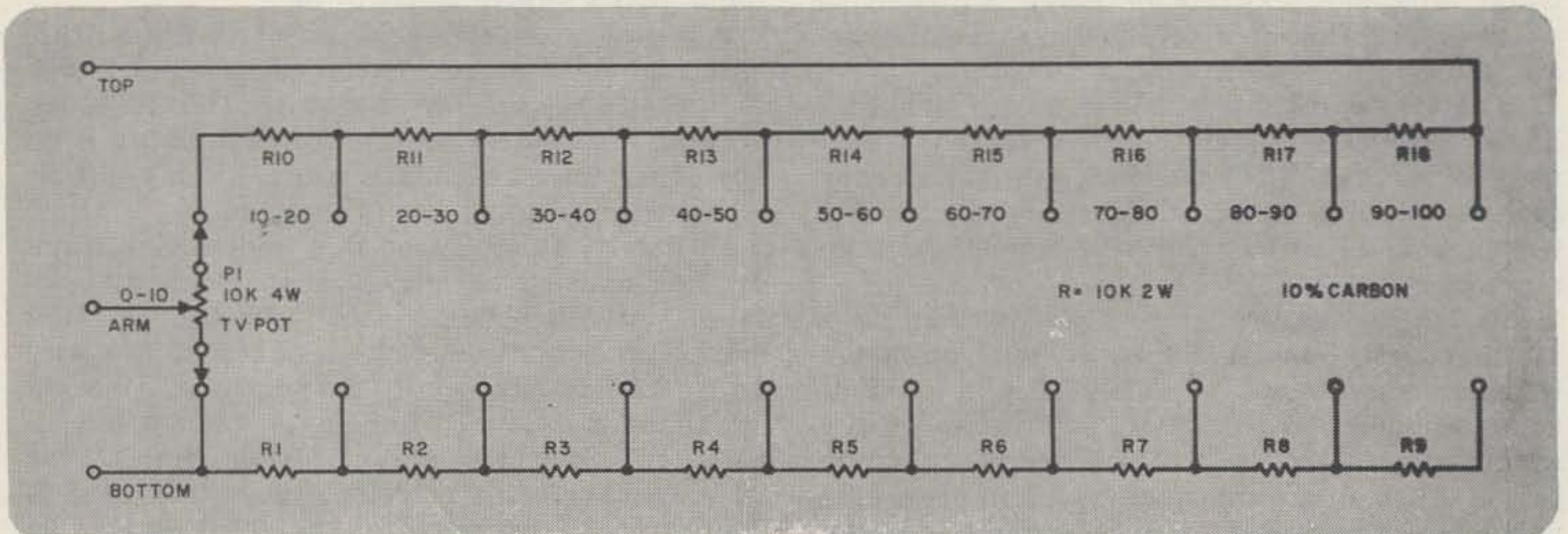

Fig. 3

Fig. 1



Blowers: Facts and Figures

Melvin Leibowitz W3KET
220 West 4th Street
Wilmington 1, Delaware

FORCED air cooling in ham transmitters; virtually unheard of a decade ago, is now becoming commonplace. It is the purpose of this article to help the home-brewer select the proper blower as information on this subject in contemporary literature is virtually non-existent.

There are two general situations that require forced cooling. The first is where a lot of heat is produced in a confined space as in a high power final amplifier. Short lead construction and thorough shielding required in modern construction seriously restricts the natural flow of air and something has to be done to get the air moving again. This problem can be solved simply by placing a 3 or 4 inch fan at a strategic place in the enclosure so that it will stir up a breeze.

The second situation can not be treated so lightly. This is where external anode tubes

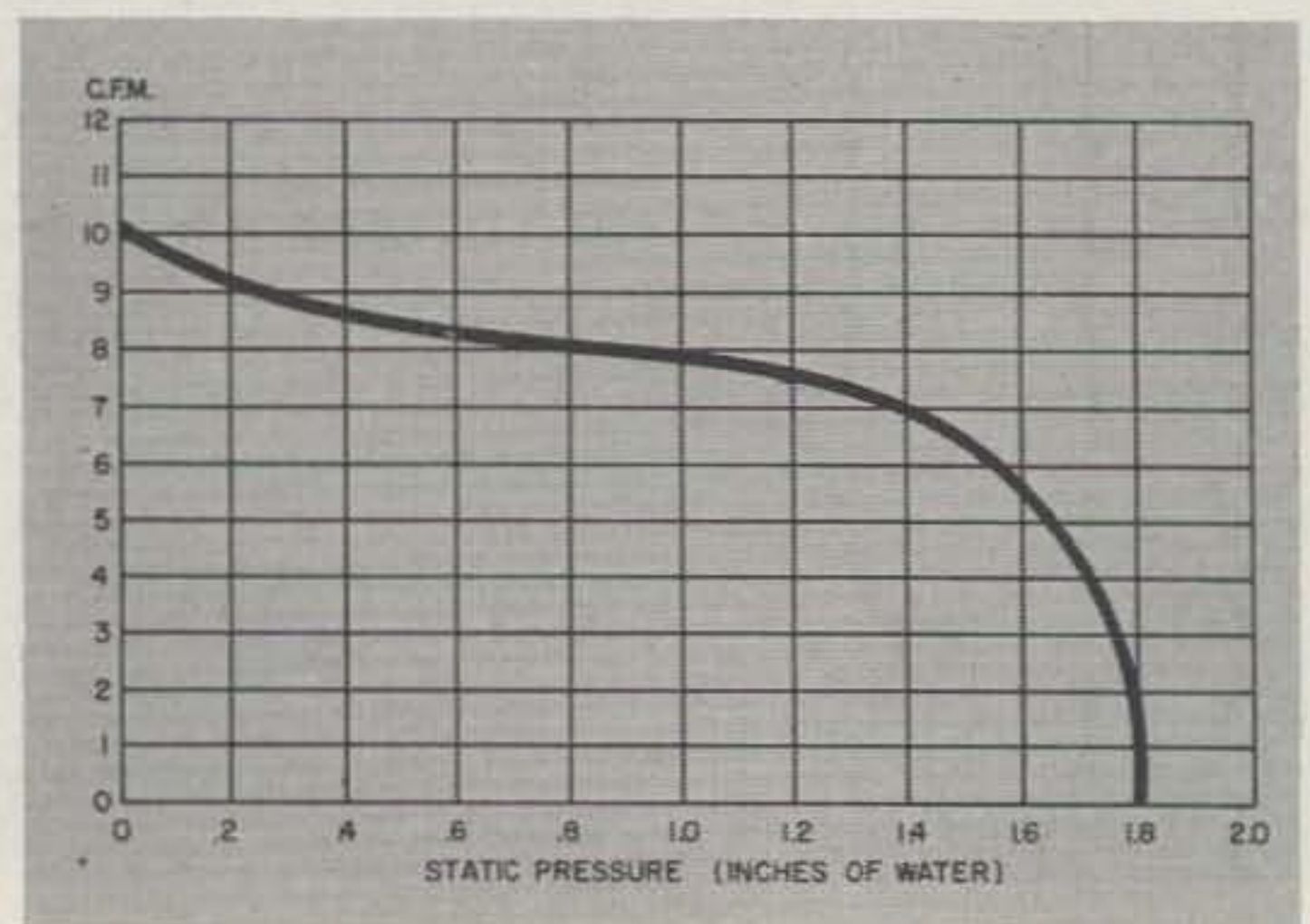

such as the 4X250, PL172, 4CX1,000, etc. are used. These tubes must have a definite amount of air blown through their plate structure if normal tube life is to be expected. In-as-much as these tubes are expensive, tube life becomes a serious consideration and the ham designer will want to be sure that he is supplying enough air.

Most hams will obtain their blower from military surplus. Very often they will not be rated in terms of air output but the motor speed and blower size are almost always given. The charts and tables given here will help you to determine the output of your blower. Blowers come in several different sizes according to the wheel diameter. These range from a number 1 to number 3 as shown in Table 1. The size of the blower is usually stamped or moulded into the side of the housing. Table 1 also lists several common speeds for each size wheel and the corresponding output. You can still determine the output if your blower speed is not listed by interpolating between the figures given. This is not strictly accurate but close enough for all practical purposes. These figures are typical but not necessarily exact as the thickness of the wheel also influences the output. It is most important to stress that the figures in Table 1 are for blowers working into open air, not under pressure.

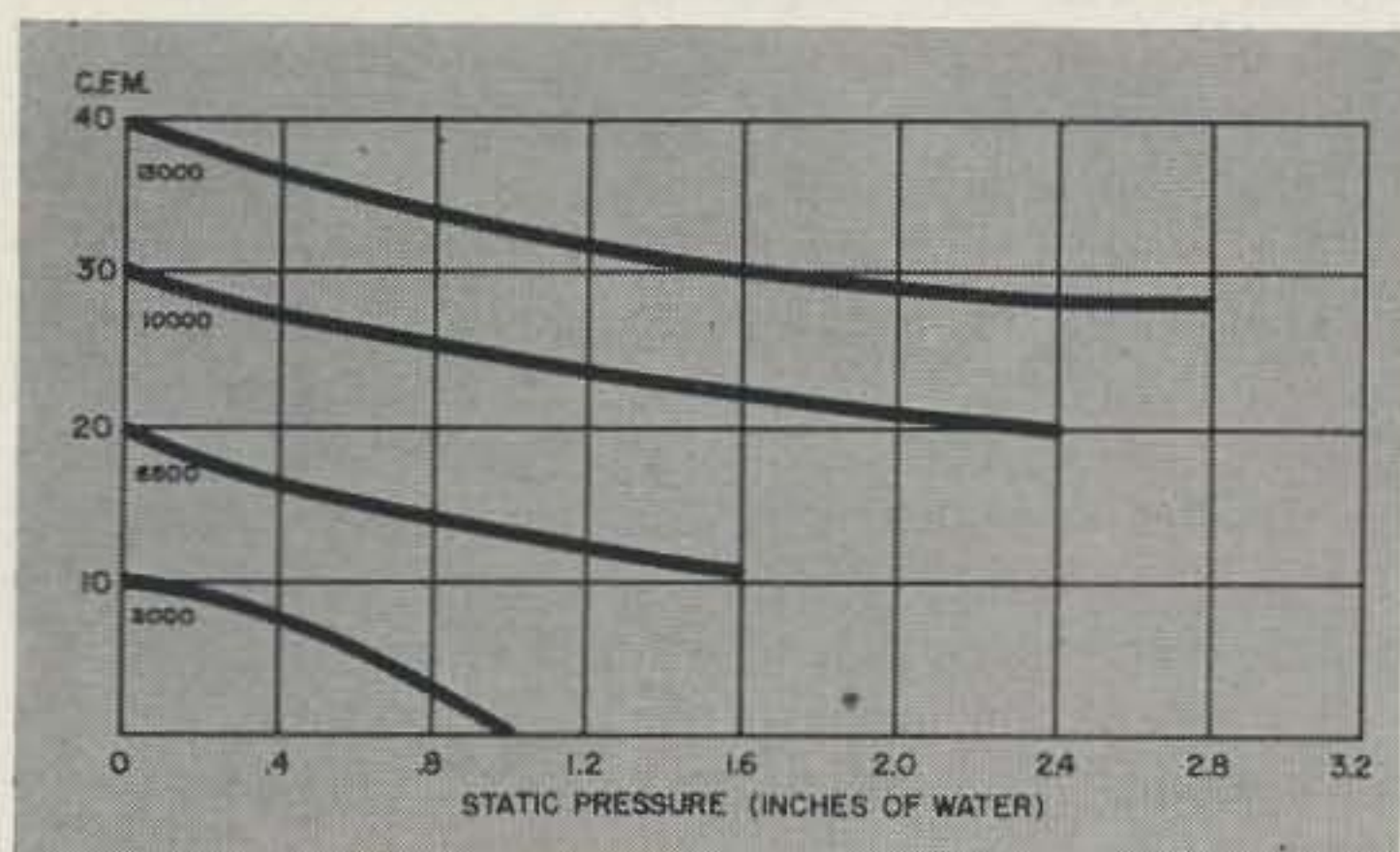

The output will drop under pressure. Figures 2, 3, and 4 show the output of different size machines at various pressures.

The tube data sheet will tell you how much air is required and at what pressure. Two tubes will require twice the volume of air but the pressure will be the same as for one tube. It would be wise to allow a safety factor of at least 2 and preferably 3 as there will be some air leaks in the system and other losses.

Inspection of Table 1 shows that small blowers must turn at very high speeds in order to produce usable amounts of air. Small blowers are to be avoided for this reason if quiet operation is desired. The motor itself may be quiet but the high speed chopping of the air by the fan blades tends to set up a loud hiss approaching an effect something like a siren. There is bound to be more vibration in a high speed motor than in a slower one. For reasons of quietness then, select a slow speed machine

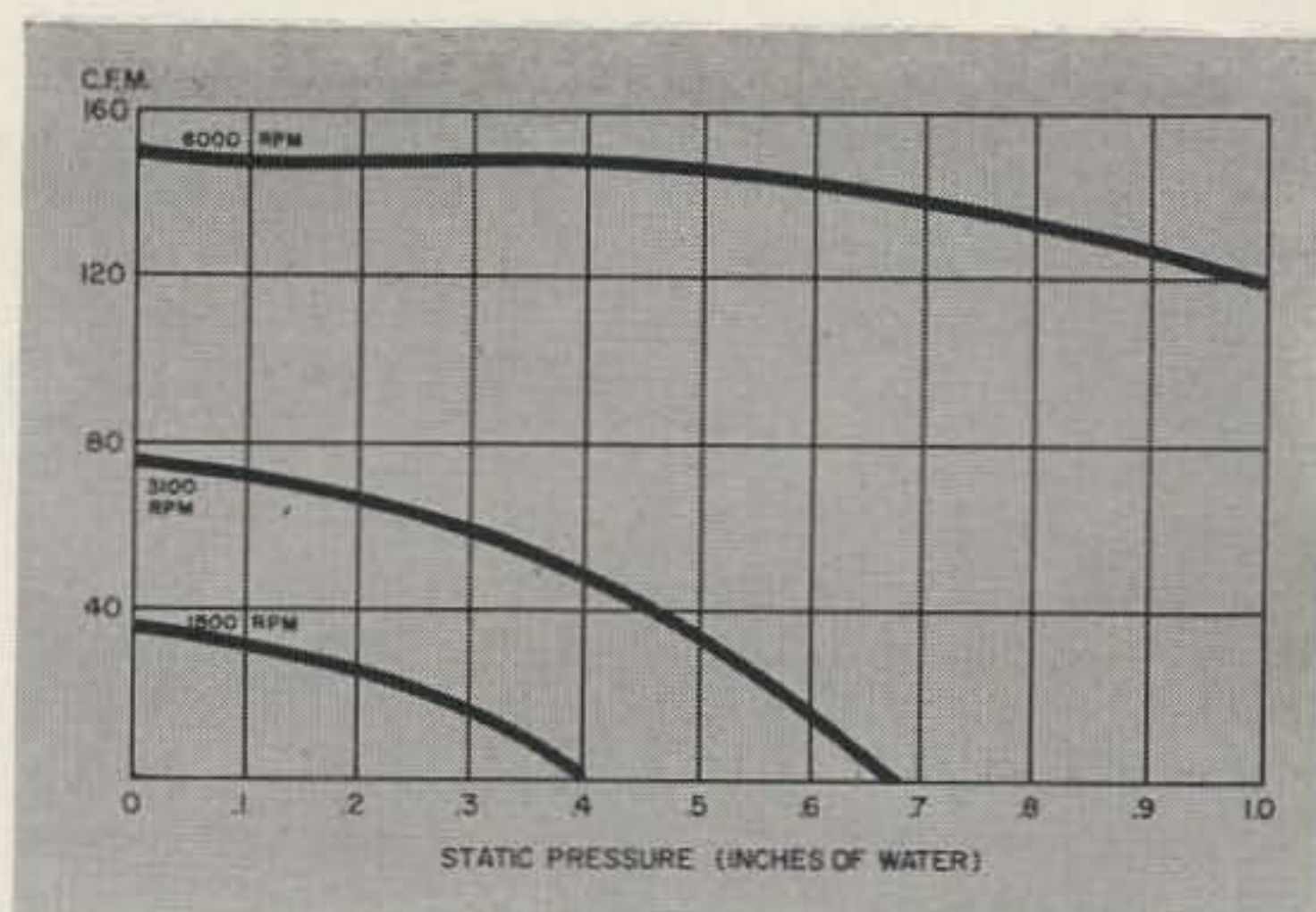

about 1500-3000 R.P.M.

If you intend to buy a surplus blower bear in mind that many of them are brush type motors designed for low voltage direct current. They will work on A.C. but there is a possibility of them causing QRN in the receiver. It may or may not be possible to filter them by bypassing the brushes to the case of the motor.

In summation: select the largest, slowest blower that you can fit in the cabinet. Allow a safety factor of 2 or more. Clean the rotor blades every few months particularly if your transmitter is located in your living quarters as the blades will pick up quite a bit of lint and dust. A pipe cleaner moistened in water is good for this. Be very nice to your parts supplier and he may let you select the quietest machine from his stock.

Many hams are needlessly prejudiced against forced air cooling, but if the principles set forth here are followed, dependable, quiet operation will result. . . W3KET

Table 1

Size	Speed	Output C.F.M.
1	18,000	9
1 1/2	3,000	4
	8,000	12
	11,000	17
	15,000	23
2	3,000	10
	6,000	20
	10,000	30
	13,000	40
2 1/2	2,750	17
	6,000	35
	9,000	52
	12,000	70
2 3/4	1,500	25
	3,000	55
3	1,500	40
	3,000	75
	6,000	150

How Low the Fi

Staff

ONCE a radio signal has been detected, it's still somewhat useless for our purposes until we can hear it. That's the job of the audio section in any receiver. Every receiver marketed includes such a section, and most of us pretty well take it for granted.

However, the performance of the audio portion can make or break a set's overall ability for ham usage—and some of the most highly rated receivers in recent years have fallen short in the audio department.

Four major requirements must be met for an audio section to be completely acceptable: it must have adequate gain to allow the weakest signal detected to be heard; it must have a frequency response no greater than necessary for the reception mode chosen; it must be free from fatiguing distortion; and, finally, its power output must be no greater than necessary for the intended service.

Fortunately, all these requirements can be achieved easily through homebrew modifications. Let's examine them more closely.

Gain is an apparently simple thing—but it's necessary before anything else becomes important. The audio signal present at the output of most detectors is between 1 and 10 volts, and most power output stages require a minimum of 30 volts to drive them to full output (remember that audio stages—in receivers at least—are always operated Class A and are voltage—rather than power-driven).

Testing for adequate gain is simplicity itself. Just disconnect the antenna, turn the audio gain all the way up, and listen at the speaker for the hiss of random or "white" noise.

However, a noisy first-audio stage can negate the value of this test. To check for that, pull the last *if* tube. If noise persists, your audio stage is noisy. If the noise goes away when the *if* tube is pulled, your audio section has sufficient gain.

An operational test for adequacy of gain is simply to note what position of the af gain control is used most often. It should be at about 12 o'clock when listening to a normally-modulated signal (such as on the broadcast band). If it's opened wider, you can use more audio gain even if the set passes the preliminary test. If it's not that far open, you already have too much gain and it must be reduced. We'll go into ways and means of accomplishing both a little farther on.

Much has been written about the need for limited frequency response in ham receivers, and there's not too much to add in the way of theory—but a little later we'll go into some not-too-widely-known ways of achieving the theoretical ideal.

Basically, the idea behind frequency shaping is this: telephone engineers learned long ago that while the average ear can hear sounds from somewhere around 30 cycles up to 15 or 20 kc, only 2700 cycles of this spectrum are necessary to convey the human voice. Frequencies lower than 300 cycles or higher than 3000 cycles may add to a voice's character, but they don't add much to intelligibility.

Therefore, since the bandwidth required for every form of modulation is at least partially dependent on the bandwidth of the modulating signal itself, the engineers reasoned that for best efficiency all voice communication should be limited in frequency range to the band from 300 to 3000 cycles.

While this sounds as if it applies primarily to transmitters (and it does) it also has great benefits in receivers. Even if the transmitted signal covers the full audio spectrum, it's likely to be more intelligible and less fatiguing if receiver audio bandwidth is limited to the 2700-cycle voice-communication range.

The reasons are twofold. First, no matter how good the equipment, you'll always have some noise along with the incoming signal at the signal strengths usually encountered in ham operation. While this noise is evenly distributed throughout the spectrum, the sensitivity of your ears is not so even. Most persons show a peak in their hearing between 4000 and 8000 cycles, with the majority of individuals having the peak near 6 kc.

For this reason alone, cutting audio response off sharply at 3 kc makes an apparently drastic improvement in signal-to-noise ratio. In addition, the actual noise voltage present is a direct function of bandwidth, so by slicing down the audio bandwidth the actual signal-to-noise ratio is also increased.

The other reason for frequency shaping is somewhat more subtle. It begins with a recognition of the fact that most ham operation is under conditions described by engineers as "worst possible case." We work with incoming signals in the microvolt-and-under range, we habitually attempt to copy marginal double-hop signals, and we usually work much closer

to the MUF than do the commercials.

All of these conditions contribute to unavoidable distortion of the received signal—and much of this distortion is second-harmonic in nature. This means that, even if the original signal has a clean 300-3000 cycle bandwidth, by the time it gets out of our detectors it extends up to 6 kc—and those upper kilocycles are all highly-distorted signal.

However, if we trim back to the original 3 kc upper limit in the audio stages, that distorted portion of the signal is discarded and what we hear, while not so clean as the original, is much improved in quality.

Occasionally you'll hear theoreticians among us argue that audio frequency shaping in a receiver is useless, especially if the *if* bandpass is limited to 3 kc. You can see, however, that both the reasons cited above still exist even when *if* bandwidth is reduced—since much of the noise and the distortion are generated in the detector stage of the receiver.

These arguments lead directly to the next requirement for an acceptable audio section: that it be free from fatiguing distortion.

The fad for high fidelity (and don't be misled if you've a hi-fi buff—so is the author) has shed much new light on the question of how much distortion is acceptable in audio.

In olden days, engineers figured 5 percent distortion as a good figure. They're still using that figure in communications receivers.

However, hi-fi designers have made some valid-sounding claims that as little as one percent distortion will prove objectionable over any extended period of time.

Before going any farther, though, we'd better define "distortion," since it means not just one, but many things. There is frequency distortion, harmonic distortion, amplitude distortion, phase distortion, intermodulation distortion. . . .

Only two of these concern us primarily at this point, and only those two—harmonic and intermodulation distortion—are meant. After all, we deliberately introduce amplitude and frequency distortion when we narrow the bandpass.

But harmonic distortion and IM are the most fatiguing to listen to, and they're the ones on which we shall concentrate.

The major causes of both trace back to a single root—the attempt to get too much from a single tube. This is in the accepted amateur tradition of stretching each bottle to its limit and then some, but the result can be extremely unpleasant in this case.

When any tube is stretched past its capability, it is forced to operate on non-linear portions of its transfer curve. This means that the output signal is no longer an exact replica of the input signal. In the usual case, negative-going peaks of the output signal are slightly flattened.

The result is second-order harmonic distor-

tion, since the waveshape becomes exactly the same as the original would be if between 5 and 10 percent of its second harmonic were added to it.

At the same time this is going on, IM also rears its head. Remember back to the front end and the product detector, and what happens when two frequencies are impressed at the same time on any non-linear device? Your overdriven audio tube is certainly non-linear, and just as you might expect, you'll get a mixing action. Assume that the original signal consisted of only two tones—500 cycles and 950 cycles. At the output, you will find the original two tones, their sum (1450 cycles), their difference (450 cycles), their second harmonics (1000 cycles and 1850 cycles), the sum (2850 cycles) and the difference (850 cycles) of the harmonics, plus the sum and difference products of every frequency listed so far (taken in pairs) and every frequency so determined. Some of these spurious outputs include 1350 cycles, 100 cycles, 200 cycles, 300 cycles, 4700 cycles, and 7550 cycles. Quite a mess from just two input frequencies, no? And the voice has not just two, but dozens of simultaneous frequency components.

While the picture may appear mighty black at this point, it's not so bad as all that. This problem fortunately, can be cured permanently in any receiver for less than a dollar.

Before going into circuitry, though, let's examine the last specification for acceptable audio: power output no greater than necessary.

You wouldn't fire up a 50-foot semi-trailer to drive the kids to school any more than you would attempt to move seven rooms of furniture cross-country in a Volkswagon, but every day similar extravagances of power are committed in receiver audio sections.

One excellent conversion article published a couple of years ago included as a major step the increasing of the set's output power from its rated two watts to 10 watts. While the procedure described was perfect, it represented wasted effort for the most part, since virtually all fixed-station ham work is carried on with less than two watts audio.

Actually, if your shack is in a normally-quiet location, a half-watt of audio will be more than ample with most speakers. The hi-fi experts, again, have proved that 250 milliwatts of *audio* power (not to be confused with the same number of milliwatts applied to the speaker, since the best speakers are only some 10 percent efficient) is enough to drive one screaming from the room. About 50 milliwatts of sound energy is the average listening level.

Audio required for mobile work is considerably greater, since the speaker in the auto must compete with engine roar, wind, and other traffic noises. There, five to 10 watts is useful. But in the fixed station, for loud-speaker operation, two watts should be suf-

ficient to allow a good safety margin of power.

Of course, if you're using phones exclusively, power requirements will be much less. In this case, voltage amplification alone is all that's necessary, since most earphones function admirably with around 10 milliwatts of power applied and almost any voltage amplifier will furnish this small power at the high impedance level of most phones.

Having completed the theoretical discussion, we're ready to embark on the second stage of our search for improved audio—the achievement of these four goals.

Taking them in order, let's look again at gain.

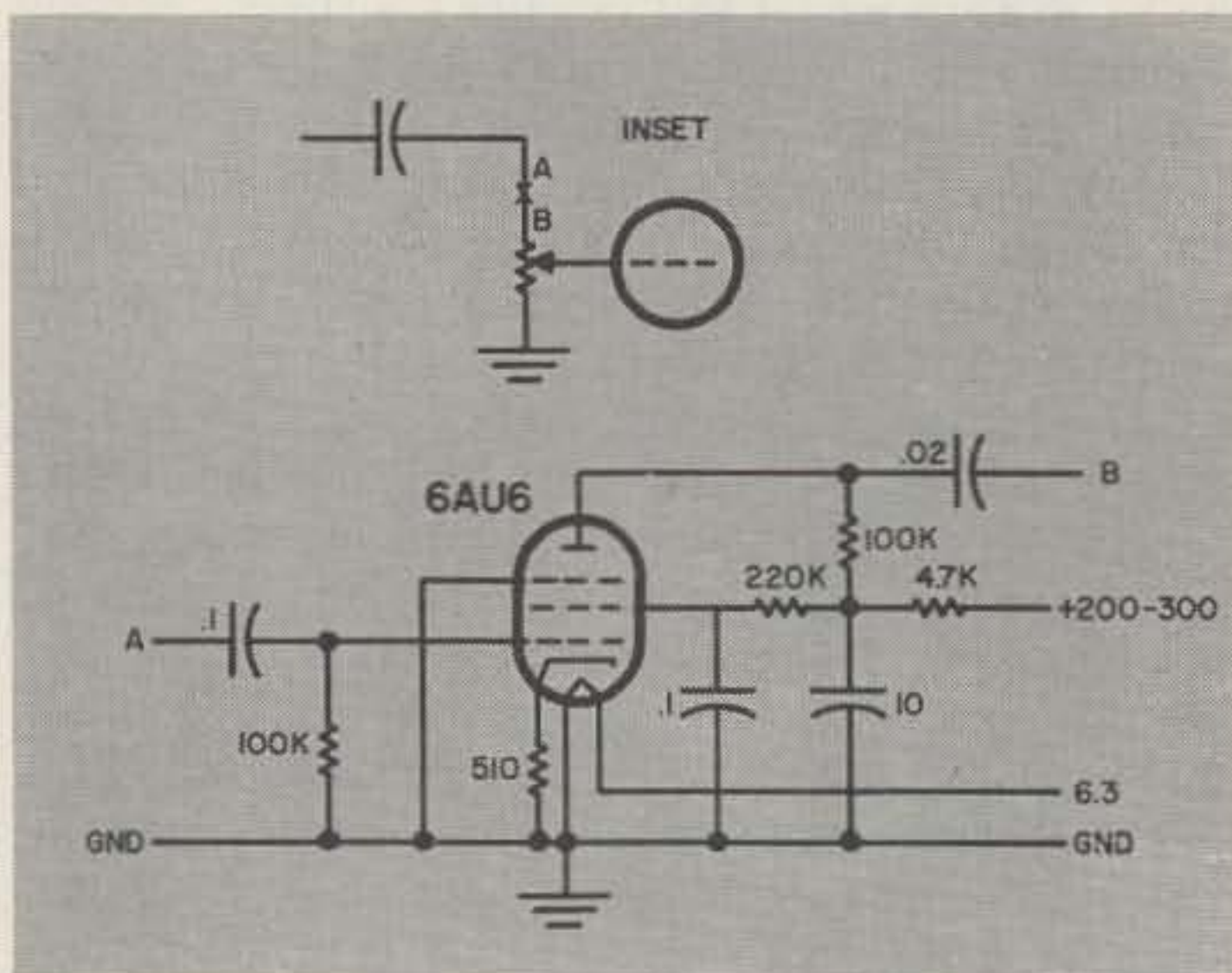

Fig. 1. This outboard audio stage will give a voltage gain of about 50. It can be added to any set suffering insufficient gain by breaking the connection to the top of the volume control, as shown, and inserting the amplifier in series.

If you need more gain, you have two choices. You can either add an outboard stage of audio (as in Fig. 1) or you can modify the existing stages for increased gain at the possible price of increased distortion. If you're also intending to reduce distortion while maintaining the same output power and introducing frequency shaping, the best bet is to add the outboard stage.

Wiring for the added stage of audio is non-critical, except that grid and plate leads should be separated from each other and from all ac-carrying wires such as filament leads. The stage should be added ahead of the volume control, thus enabling you to keep from overloading subsequent stages should you tune to an unusually-strongly-modulated signal.

If you're going to modify existing stages for increased gain, the place to start is at the plate load resistor of each tube. This is based on the assumption that you've already substituted tubes with higher amplification factors for the original bottles. If you haven't, do so. Substitutes for some of the popular audio tubes include: 6SF5 for 6J5 (requires rewiring of socket); 12AX7 for 12AU7; 6AV6 for 6C4 (requires rewiring); and 6AV6 for 6AT6.

Other substitutes can be located in a few minutes with a good tube manual.

Now, increase the values of the plate load resistors. They should go up to 470,000 ohms in most cases, but to some degree this is a trial-and-error process. Start with the first stage and test as you go. If distortion increases radically, trim the resistor value back a bit. A "Andy Ohmmaker" comes in handy at this stage.

When plate resistor values are changed, the values of grid resistors in subsequent stages must also be changed in the same ratio to maintain maximum gain. However, grid resistors should never exceed 2.2 megohms—and the grid resistor of a power output stage shouldn't go higher than about 47,000 ohms because of grid-emission effects which can seriously damage the tube.

If you're troubled by excess gain, you also have two choices. Either you can install a resistance pad as shown in Fig. 2 to get rid of the excess audio, or you can trim the gain back to size with feedback.

If the only modification you plan to make is in the gain department, the resistance pad is the best bet—mainly because it's simpler. However, if you plan to reduce distortion or to add frequency shaping, wait until those steps are completed before modifying the gain, because your gain requirements are subject to change as the modification proceeds.

Frequency shaping can be attacked in many ways. You can use LC filters, RL filters, RC filters, or combinations of any or all of these. In addition, feedback tricks open whole new vistas of frequency shaping, including adjustable cutoff points.

The classic approach to the situation has been through the use of LC filters. These are

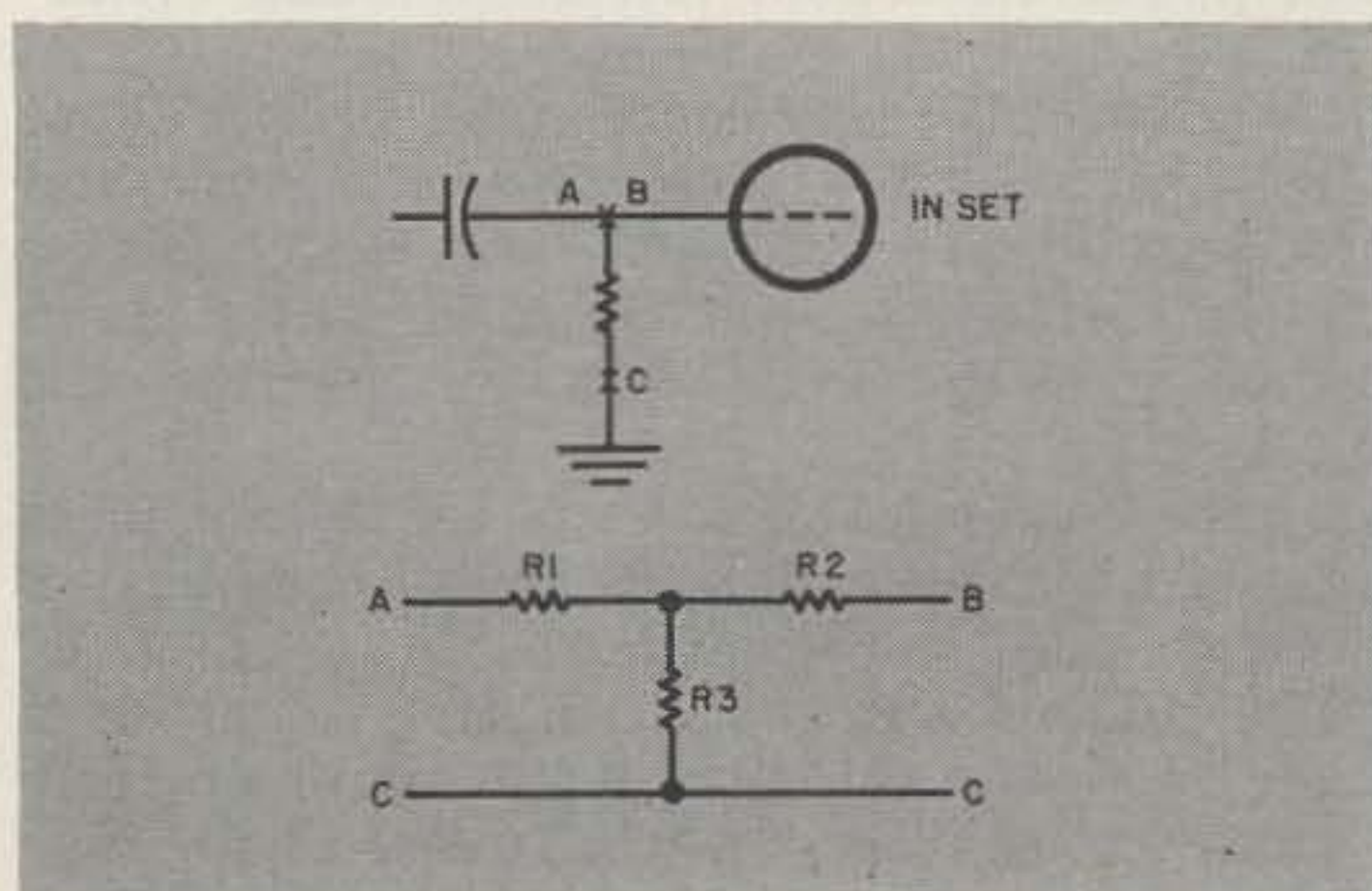

Attenuation	R1 and R2	R3
Desired		
10 db	270 K ohms	330 K ohms
20 db	420 K ohms	100 K ohms
30 db	470 K ohms	30 K ohms
40 db	470 K ohms	10 K ohms

Fig. 2. Excessive audio gain may be cured by installation of a T-pad as shown. Values given are for replacement of a 470 K grid resistor; for other grid-resistor values, they may be scaled up or down in proportion.

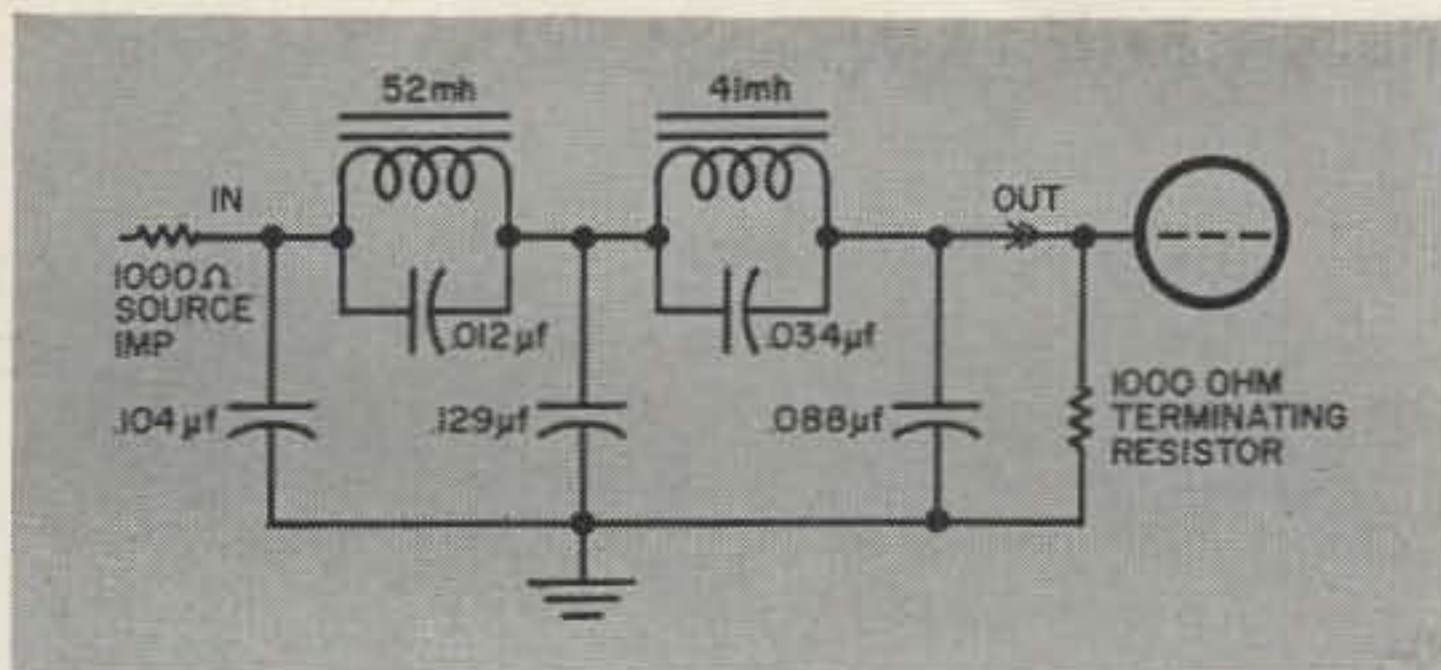

Fig. 3. Low-pass filter for use at 1000-ohm impedance level. Cutoff frequency is 3500 cycles. Passband is flat to 3000 cycles, and all frequencies above 4000 cycles are down 50 db or more. A cathode follower (not shown) is suggested to drive the filter.

available commercially at a cost of approximately \$15, and can be homebrewed for about \$5 (depending on the contents of the junkbox and your requirements).

Such a filter, designed to pass frequencies below 3 kc without attenuation and to suppress frequencies above 4 kc by 50 db or more, is shown in Fig. 3. Note that the amount of rejection obtainable with this filter is similar to the stability of a VFO—it's determined as much by the mechanical construction of the gadget as by the electrical circuit used.

Input and output of the filter must be completely shielded from each other. In addition, magnetic coupling between elements of the

filter must be minimized. Toroidal inductors are recommended for purposes of isolation, but they're usually expensive and hard to locate.

As a matter of fact, unless you like to tinker with the mechanical end of this hobby of ours, you'll probably find it better to either use the commercial filter or to investigate some circuits yet to be described. Construction of a good low-pass audio filter is one of the trickiest things in ham radio.

Turning again to the hi-fi designers, we find that they too have faced a similar problem in the design of the electronic crossover network. There, by skillful use of feedback, they have managed to get LC-filter results with RC components. Since it's the inductive element that plays havoc with homebrew filters, these circuits bear investigation.

One of these circuits is shown in Fig. 4. The low-frequency cutoff is switch-selected, but at the high end you have continuous adjustment of the passband. This enables you to cut it down to 100 cycles or less for CW reception, back out to 300 and 3000 cycles for voice, and even wider if you like to listen to SW music broadcasts from time to time.

Naturally, a project such as this is an out-board unit with its own controls and power supply. About the only way to include such a gadget inside the receiver case is to transistorize it, and that's left up to you, the creative

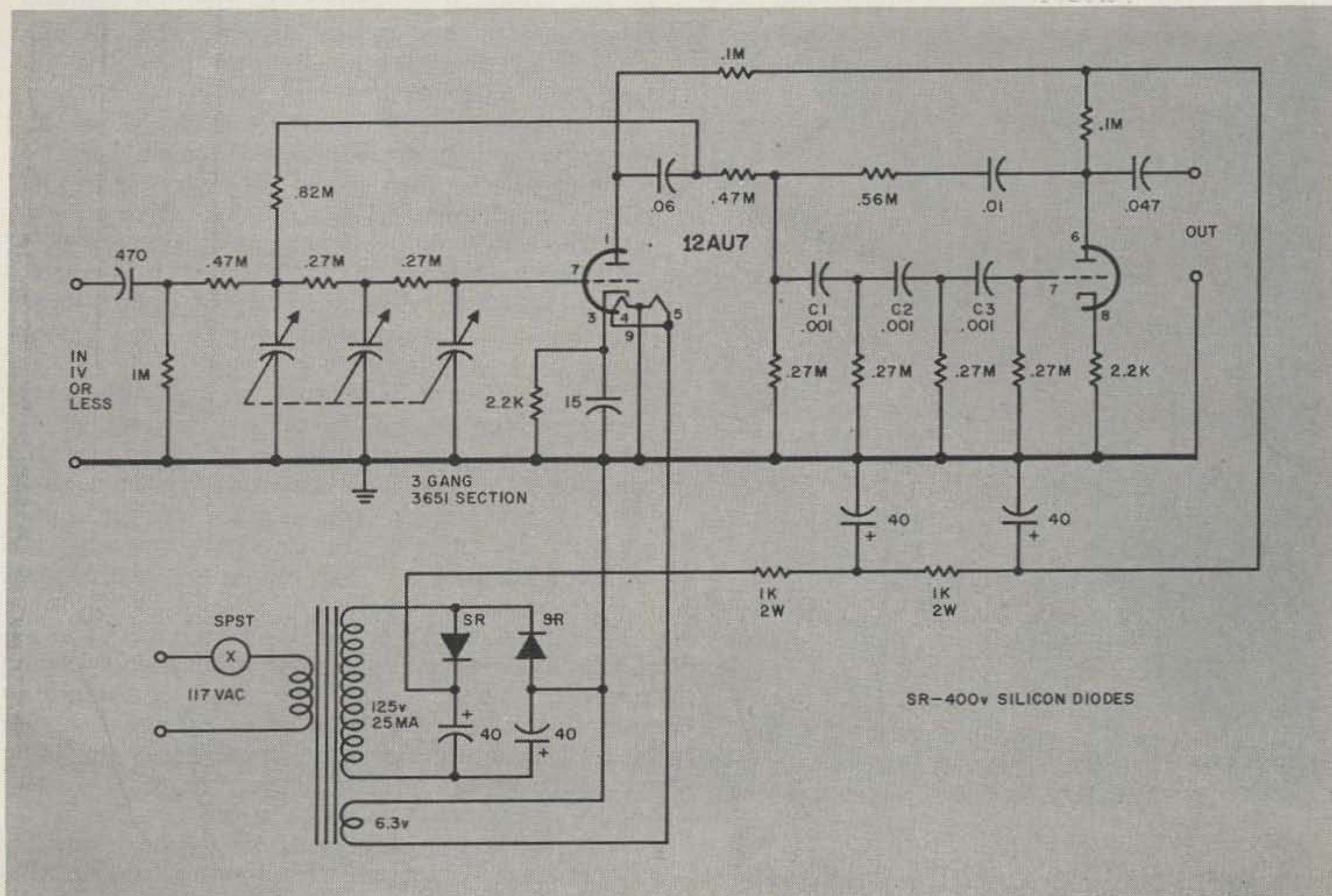

Fig. 4. Variable bandpass filter which provides 40 db rejection of unwanted frequencies. Upper cutoff frequency is continuously variable from 1.8 kc. to 20 kc. Lower cutoff is fixed at 350

cycles. It may be varied by changing values of C1, C2, and C3. Doubling the size of each will lower the cutoff frequency by approximately two times. Over-all gain of the filter is unity.

reader. Design formulae and examples can be found in the references.

Some time back, when discussing distortion, we said that it could be cured permanently for less than a dollar. This is the point at which the details are to be revealed.

Going back for a moment to the hi-fi designers, we find that one of the major advances in the audio art was the introduction of the negative-feedback concept. In case the term is foreign to your experience, here's the idea in capsule form.

Distortion consists of the original signal, plus the distortion component. If the distortion component could be stripped out of the distorted signal, only the undistorted original would remain.

Since any voltage can be counteracted by an equal voltage of opposite polarity, we have a way by which the distortion can be reduced. If the amplifier output is reduced to a point at which it equals the input, reversed in polarity, and then applied back to the input, the only part of the signal that isn't cancelled is the distortion components.

This looks at if it's self-defeating, and in this form it is. But if all input is cancelled, there's no feedback signal. The process adjusts itself so that the composite input to the amplifier will consist of a small input signal and a large distortion component. This distortion is out-of-phase with the distortion gen-

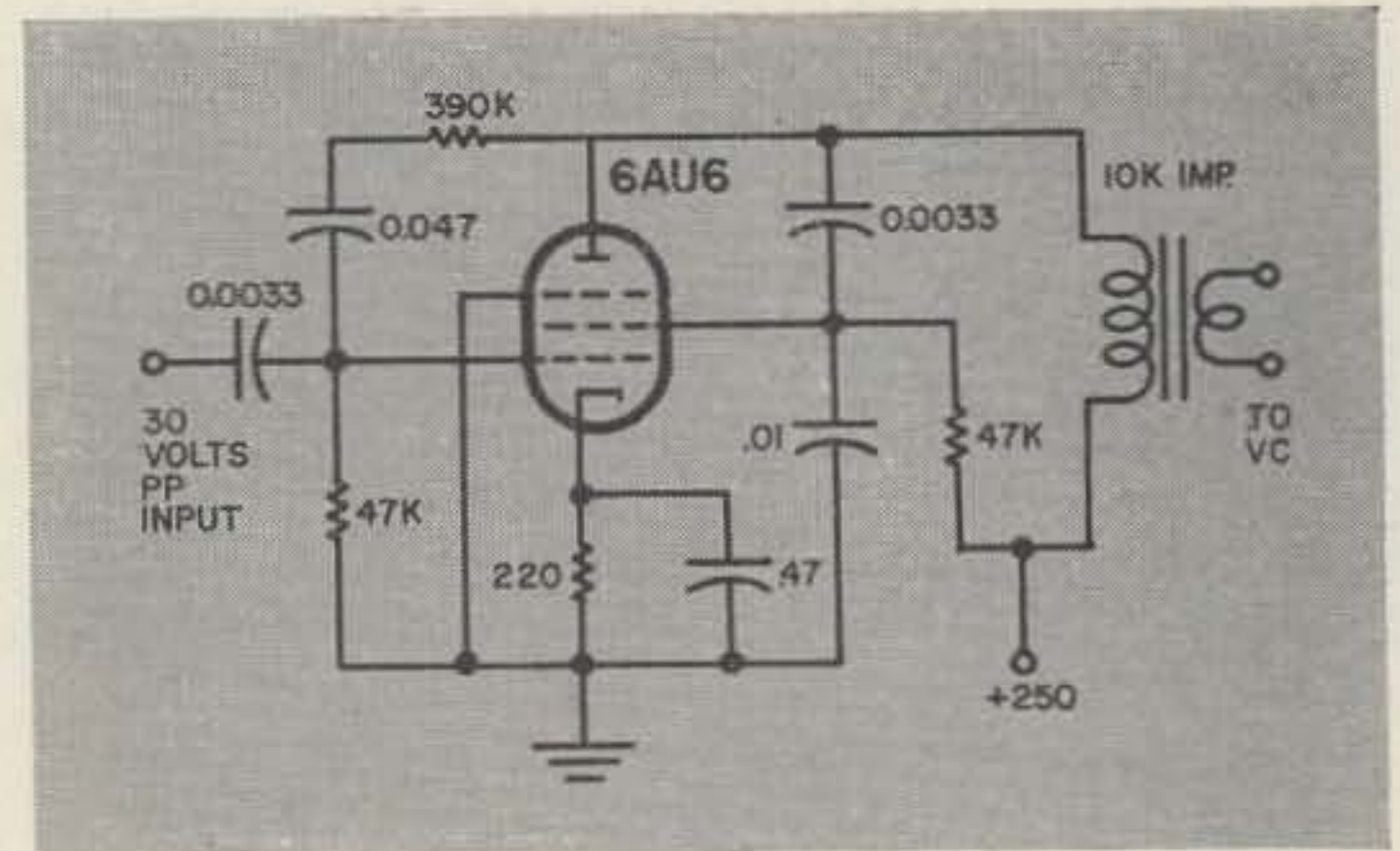

Fig. 6. This output stage will develop 300 milliwatts at approximately 1 percent distortion, and draws only 15 ma at maximum signal. Transformer may be a universal type, or one designed for battery (tube-type) portable use. Note use of feedback to reduce distortion. If feedback resistor is omitted, drive requirement is only 3 volts peak-to-peak but distortion rises to nearly 10 percent.

erated in the stage, and so is cancelled out. Since a trace of original input was left, we will have a trace of distortion also—but in practice, this component is reduced far more than is the desired signal.

The disadvantages of negative feedback as applied to communications receiver audio are threefold: If too much feedback is applied the amplifier may break into oscillation in spite of the reversed polarity; the driving voltage requirements go up in direct ratio to the amount of feedback used; and feedback extends the bandwidth of the stage.

That last item is usually considered an advantage, and is an additional reason for use of feedback in hi-fi work. However, it would play the dickens with our carefully-worked-out 300- and 3000 cycle cutoff points were they included within the loop. This pitfall is avoided by adding the feedback loop in such a manner that all frequency shaping is done before feedback is applied to the signal.

The other two disadvantages are taken care of by proper design. Instability is avoided by using only enough feedback to clean up the signal to the point of acceptability. Increased drive requirements are handled in the same manner as "insufficient gain"—by adding an outboard stage or by changing component values in earlier stages.

The only tricky thing about the addition of feedback is to make certain that the phase is correct. Remember that the phase of the audio signal undergoes a 180-degree change in each stage. Thus, taking the signal from the output-tube plate and returning it to the grid of the same tube would be correct, but returning it to the grid of the driving tube would be disastrous. To include the driving tube in the loop, the feedback must go to its cathode (which then cannot be bypassed). Typical feedback loop installations are shown in A and B, Fig. 5. Additional information on feed-

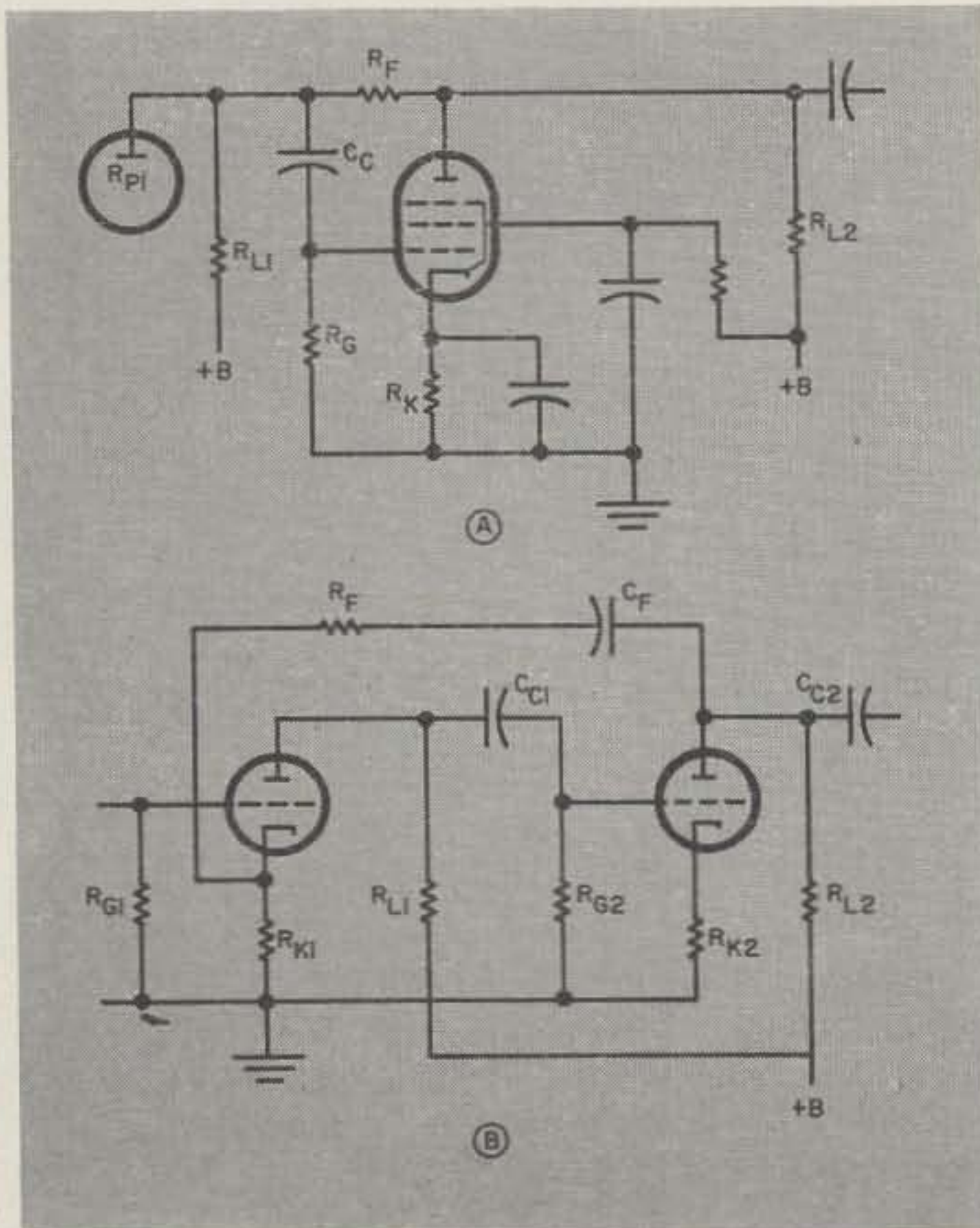

Fig. 5. Typical feedback loops. Shown at A is single-stage loop; at B is two-stage feedback. Feedback voltage is determined by ratio of R_f to the parallel combination of R_{pl} , R_{l1} , and R_g in A, and of R_f to R_{k1} in B. C_f blocks plate voltage but must be large enough to be a virtual short to the audio at all frequencies.

THE ONLY WAY TO GO MOBILE

six meters —
ten meters

NEIL



MOBILEER VHF Phone Transmitter

- Built-in power supply; no external high voltage required, just connect to your 12 volt battery.
- Transistorized modulator and 12 volt plate tubes permit extremely low battery drain.
- All controls on front panel.
- Uses 8 mc crystals; no overtone circuits employed.
- Two built-in tuning meters eliminate fumbling for meter switch; no guessing which scale to read.
- 100% plate and screen modulation, not merely screen modulated, for constant output, maximum audio.
- Extremely compact, only 3 inches high.
- With the ease of tuning and trouble-free operation for which NEIL is famous.
- Features new, updated circuitry.

Price: MOBILEER, kit **\$134.00** MOBILEER, wired **\$159.00**
(specify band desired)

See your dealer or order from:
THE NEIL CO. 1336 Calkins Road, Pittsford, N. Y. • Baker 5-6170

For higher mobile power: Neil BETA transmitter, 60 watts, requires external power supply. Kit \$98, Wired \$125.

Improve

Meter

Accuracy

Recently I acquired on the surplus market a 3 inch 0-20 ma meter. Unfortunately the internal resistance was not known. The standard method of finding internal resistance, as in the handbook, gave 1.6 ohms. Considering the inaccuracies that were present, that figure was probably within 10% at best. When a meter is used as is, the internal resistance is not too important. For shunting, however, the internal resistance must be known accurately. To improve meter accuracy, I added an 8.4 ohm 1% (?) homemade resistor in series to bring the "internal" resistance to 10 ohms. This resistor was wound from a carefully measured length of copper wire. Since the major inaccuracy is now 10% of 1.6 ohms, or .16 ohms, the total variation is now .16/10, or about 2%. This technique will work on any meter with a low full-scale voltage drop.

... KØWML

you haven't heard?

EVANS OFFERS

COMPLETE SERVICE

- To HAMS - - - By HAMS
(12 licensed employees)
- EQUIPMENT and COMPONENTS
(Ham - Electronic - Electrical)
- TRADE-INS
(on new or used units)
- TIME PAYMENTS
(flexible, financed ourselves)
- ENGINEERING DEPARTMENT
(backing all equipment sales)
- RECONDITIONED EQUIPMENT
Largest inventory in the Northeast
- EXPERIENCE - - - 26 years as:

"YOUR FRIENDLY SUPPLIER"

Evans RADIO

CA 5-3358 • ROUTE 3A • BOW JCT.
BOX 312 • CONCORD, N. H.

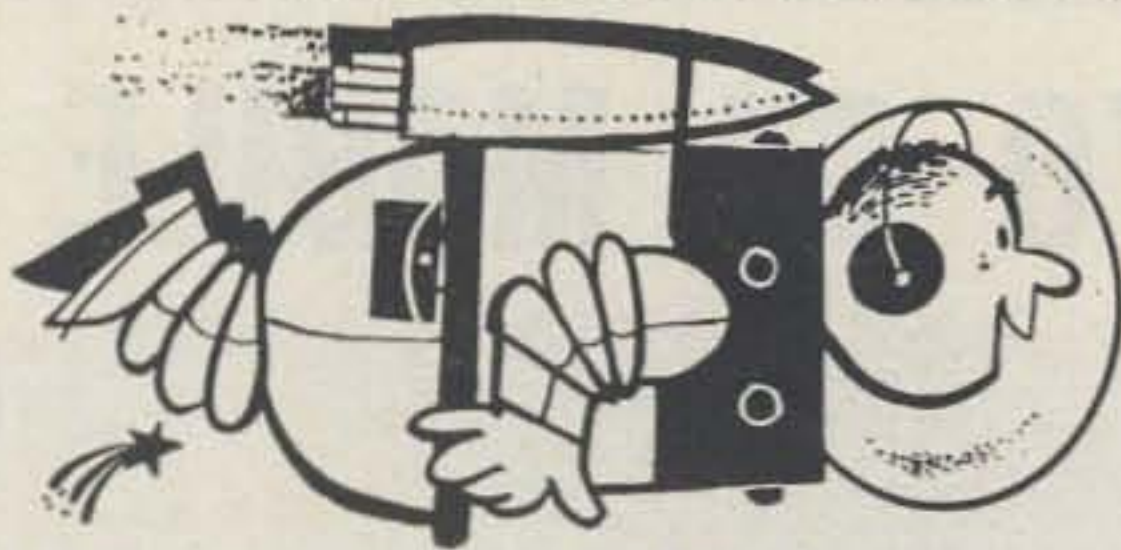

BARRY'S VALUES ARE "OUT OF THIS WORLD"
Send for your 1961 "GREENSHEET" CATALOG today!
Hundreds of specials on equipment, components and tubes.

Here are a few samples:

C.D. Ham M Rotator. Brand new boxed. Complete. \$110.00
Mosley TA-36 10, 15, and 20 meter beam. \$125.00

50' 8 Conductor Color-Coded Cable: Each lead is color coded and tagged and numbered. There are 8 spade lugs on each end. Line is excellent and insulated with rubber covering. Each lead is individually covered with rubber also, for added protection. 50' Roll \$2.95

SPECIALS

Accuracy plus or minus 0.0012%. Contains precision 500 KC crystal, BMS Labs Crystal oven, 5840 sub-miniature tube. Hermetically sealed, Nickel plated rectangular case. Mounts in standard 7 pin miniature socket. Requires 6.3 VAC or DC. 75 to 100 V.D.C. With schematic, RCA Type A8838300-1. Size 4 1/2" H x 1-7/16" W x 1 1/8" D. Wt.: 1 lb. Cat. #4-500 CRV. (Orig. Govt. Cost: \$172.00.) VERY SPECIAL ONLY \$3.75

Pwr Xfmr: Pri: 115 VAC 60 CPS. Sec: 1260 VCT @ 425 Ma; also 30 V. @ 1.05 Amps. Filament (1) 6.4 VAC @ 7.5 Amps. (2) 6.3 VAC @ 3.7 Amps. (3) 5 VAC @ 4 Amps. Hermetically sealed. Order Hazeltine #TR-1285. \$12.50

RCA Mica Capacitor: 4,000 Mmfd. 3000 V. Peak. \$1.95.
RCA PLATE Xfmr: 1290 V.C.T. @ 360 Ma. Pri: 115 V. w/taps. 60 CPS. Herm. sld. \$4.95.

Johnson Variable Capacitor: Dual 215/215 Mmfd. .125 spacing (4500 V.). \$7.75.

RCA Plate Xfmr: 905 VCT @ 360 Ma. Pri: 115 V. w/taps @ 60 CPS. Herm. sld. \$3.95.

Merit Choke: 10 Hy 250 Ma. #C-3182. \$2.95.
Superior Powerstat Variable Auto-Xfmr Type 10: Input: 120 V. 60 CPS, 1 Phase Output: 0-120/132 V. @ 1.25 Amps. Removed from new equipm't. With knob & dial. \$5.95.

Xmtg. Variable Capacitor: Approx. 20 to 750 Mmfd. @ 4,000 VDC. In oil-filled glass enclosure. 6 1/4" L x 3 3/8" H x 3 1/8" W overall. \$11.95.

Johnson Socket #122-101: For VHF use w/tubes such as the 826, 832, 4D32, 4D22, PL6549 & PL6569, etc. Special terminals permit direct mtg of grid coils. This 7 pin wafer socket only \$1.00. (Brand New Surplus)

Xmtg Variable Capacitor: 72 to 1,008 Mmfd. @ 3500 V. Ceramic ins. \$8.50.

Variable Capacitor: 18 to 400 Mmfd. 1000 V. Ceramic ins. \$2.50.

Min. 125 Watt Modulation Xfmr: Pri: 10K P to P. Sec: 4550 Ohms. (Screen winding 3300 Ohms) Insulated for 5KV Peak. Orig. designed for PP 4-65A's. Approx. 3" x 3" x 3". 3 lbs. \$6.95.

Special Eimac JAN 4-65A's @ \$10.00 each.
Johnson #213 Sockets for 304TL & 304TH. Brand-new (surplus). \$1.15 each. (4 for \$4.)

Cathode Ray Tube Shield (for tube type 2BP1). \$2.95.
Cornell-Dubilier 4 Mfd. @ 4000 VDC Oil Capacitor: \$9.95 each (3 for \$27.00).

UTC Type S-32 Swinging Choke: 5/25 Hy Hy/225 Ma/120 Ohms. \$4.90.

Plate Xfmr: Pri: 115 VAC @ 60 CPS w/taps. Sec: 3200 VCT @ approx. 300 Ma. \$10.50.

Filter Choke: 8 Hy. @ 200 Ma. (90 Ohms D.C. Resistance). Hermetically sealed. \$1.75.

RCA CRV-59AAC TV Camera/Xmtr with 1846 Iconoscope—\$95.00

Hipersil Type Compact construction. Approx. 3" x 3" x 3". Ideal for pair of 4-65A's —\$6.95.

Add 50¢ Service Charge for orders under \$5.00. Prices are F.O.B. NYC.

Come in and browse. We are open Mon. to Fri. 9 to 6. Sat. 10 to 2 P.M.



BARRY ELECTRONICS

512 BROADWAY, NEW YORK 12, N.Y.

II YEARS OF BUYERS' CONFIDENCE

CORPORATION

WALKER 5-7000 TWX: NYI-3731

(. . . Lo Fi from page 48)

back in general can be found in the bibliography. Just be careful that neither the volume control nor any frequency-shaping components are included in the loop, and you'll have no trouble.

This brings us to the subject of power for the audio section, the last requirement for acceptability. A low-but-adequate-power audio output stage is shown in Fig. 6.

The circuit, adapted from a Korean-war-vintage design for a portable BC set, proves especially useful for fixed-station work. It is capable of about 300 milliwatts output, and with an efficient speaker system will prove to you that there's no need to burn up some 35 watts with a pair of 6V6s in the receiver. It can easily be added to almost any set.

BIBLIOGRAPHY

- Amperex Applications Engineering Laboratory, **Audio Designer's Handbook, Part III**, Audio, February, 1960, page 36.
- John P. Billon, **Improving Audio Quality in A.C.-D.C. Receivers**, Radio & Television News, February, 1955, page 70.
- George Bonadio, W2WLR, **Better Audio for 10c**, CQ, February, 1958, page 115.
- Robert W. Buchheim, W9JTH, **Low-Pass Audio Filters**, QST, July, 1948, page 18.
- Norman H. Crowhurst, **Electronic Crossover Design**, Audio, September, 1960, page 19.
- Norman H. Crowhurst, **Improving Radio and Phono Amplifiers**, Radio-Electronics, September, 1958, page 40.
- Lawrence Fleming, **A Variable Low-Pass Filter**, Radio & Television News, May, 1955, page 46.
- Lawrence Fleming, **Voltage Amplifier Distortion**, Radio & Television News, September, 1956, page 55.
- GE Ham News, **Low-Pass Audio Filter**, March-April, 1955, page 3.
- F. Langford-Smith, **Radiotron Designer's Handbook**, Fourth Edition, pages 481-601.
- J. P. Neil, **Narrow-Band Speech Unit**, Radio & Television News, March, 1955, page 71.
- James V. O'Hern, W2WZR, **Simple Low-Pass Filter Design**, QST, October, 1958, page 21.
- Thomas Roddam, **Feedback Amplifiers as Filters**, Wireless World, June, 1959, page 274.
- Dr. Carl F. Rothe, **Audio Filter Has Variable Bandpass**, Radio-Electronics, May, 1958, page 48.
- Seely, **Electron-tube Circuits**, McGraw-Hill, 1950, general.
- Alvin G. Sydnor, **Bandpass and Rejection Filter**, Radio & Television News, November, 1956, page 148.
- Frederick E. Terman, **Electronic and Radio Engineering**, Fourth Edition, general.



Colorado's 2400 amateurs cross-referenced by name, call and location in the 1961 Colorado Ham Directory. Mile-Hi Award rules, too. Available now for \$1 from:

THE DENVER RADIO CLUB
P.O. Box 356
Denver 1, Colorado

Reyco Multiband Antenna Coils

Traps for dipoles . . . high strength . . . moisture proof guaranteed to handle a full KW. Model KW-40 coils will, with a 108 foot antenna, provide operation on 10-15-20-40-80. \$12.50 set.

For information on other models write:

FRED L. REYNOLDS W2VS, 492 Ravenswood Ave., Rochester 19, New York

LETTERS

Greetings OM:

Problems! March 73 page 12 schematic leaves the 9 volt battery always in circuit. Then, in my own article, on page 18, we forgot to mention removing the jumper and attaching the coax after grid-dipping. Then, me again, on page 43 it is not clear that the resistor goes to point X, the volume control to point Y and ground to Z.

Al Newland W2IHW

Ahem! Well, on page 12, though our schematic agrees with that sent in by the author, I would suggest moving that ground over to the other side of the S1A switch. Thanks for the elucidation on the other two items.

To The Editor:

On page 50 of the March 1961 issue of 73 the article titled "Chassis Mounting the PL-259" states: "The second item that cannot be obtained commercially is a double ended male plug." These double male plugs are manufactured by the Dow Key Company and are in-stock items in most amateur radio supply houses in this area.

Vincent Colling WA2EKP
NRM Wholesale Radio, Inc.

Dear OM:

Running 70 watts on six meters (Viking Challenger) I naturally (?) ran into TVI. Filters, etc., etc., were tried with no significant success. To condense the drama, here is how I completely eliminated my TVI. I took my own TV antenna down and cleaned it carefully with Brillo, replaced the twinlead and the screws attaching the feeder to the antenna. Presto: no more TVI. Even with the rig poorly tuned there is no problem. I suspect that the oxide on the antenna terminals rectified and reradiated my six meter signals into the neighbor's TV sets. Now everybody is happy.

Gibbons Jeansonne K5000

MULTI-ELMAC MOBILE EQUIPMENT

CHOSEN

for use aboard the S.S. HOPE!



AF-68

TRANS-CITER

PMR-8

RECEIVER



M-1070

POWER SUPPLY

Manufactured by
MULTI-PRODUCTS COMPANY
21470 COOLIDGE HWY., OAK PARK 37, MICH.

JIM CLARK W1ULU

KIT WIRING & TESTING LABS

50 - 144 - 220 - 420 mc

Nuvistor Preamplifiers \$19.95

With built-in power supply \$32.95

Complete with 6CW4-Slug tuned

2 Aiken Street Tel.: HEmlock 2-3600 Derry, N. H.

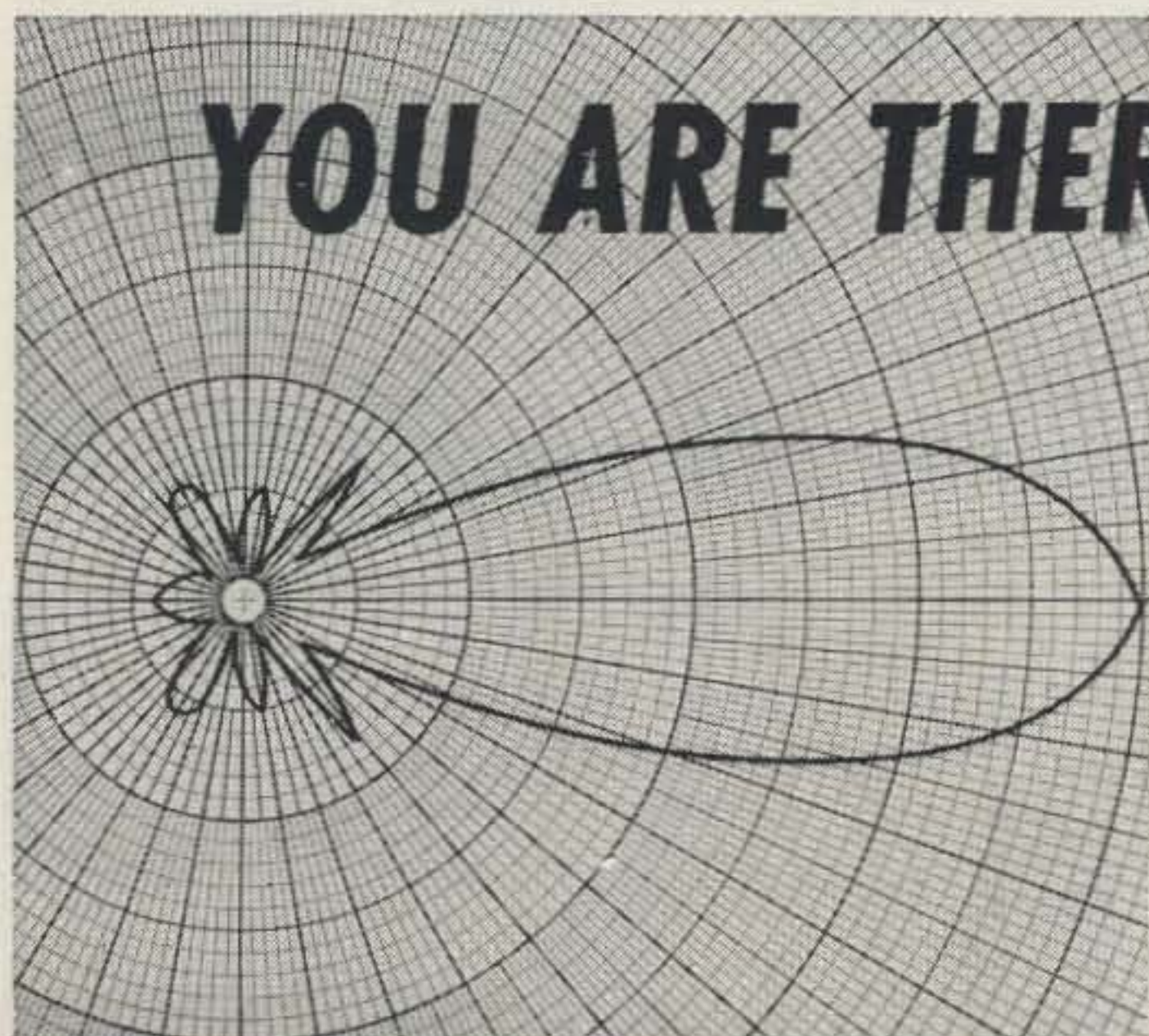

For TOP-MAN-ON-
THE-FREQUENCY results...
Install a Telrex antenna... dollar for
dollar better in every way! Antenna
systems from \$6.95 to \$12,000.00

ANTENNAS

SINCE
1921

telrex LABORATORIES

Communication and TV Antennas

ASBURY PARK 40, NEW JERSEY, U.S.A.

Give your shack that professional look—



install an
**ALDEN
HAM
BENCH**

with power facilities.

See our full page ad in the January 73 (page 45) and order yours today. For further information see your dealer or write to

ALDEN PRODUCTS CO.

2186 North Main Street, Brockton, Mass.

BIG MAP DEAL

These DDD (3-D) maps are widely advertised at \$9.95. Unfortunately we have been unable to make a special purchase of these fine maps and therefore we must bring them to you at full list price: a low, low, only \$9.95!

Perhaps a glowing description of the maps will arouse your interest. Well, let's see . . . hmmm. Well, first of all they are pretty big. 28½" and 18½" to be exact. And they are printed with eight colors (all different). But best of all are those mountains that you can feel. They stick right up at you nearly an inch. They are in the right places too. Amazing job. They come complete with the frame and a handy map index which locates all the places for you. You can see the major highways on the U.S. Map.



MOBILE POWER SUPPLY

MODEL
A12/600/200

NOW
\$59.50

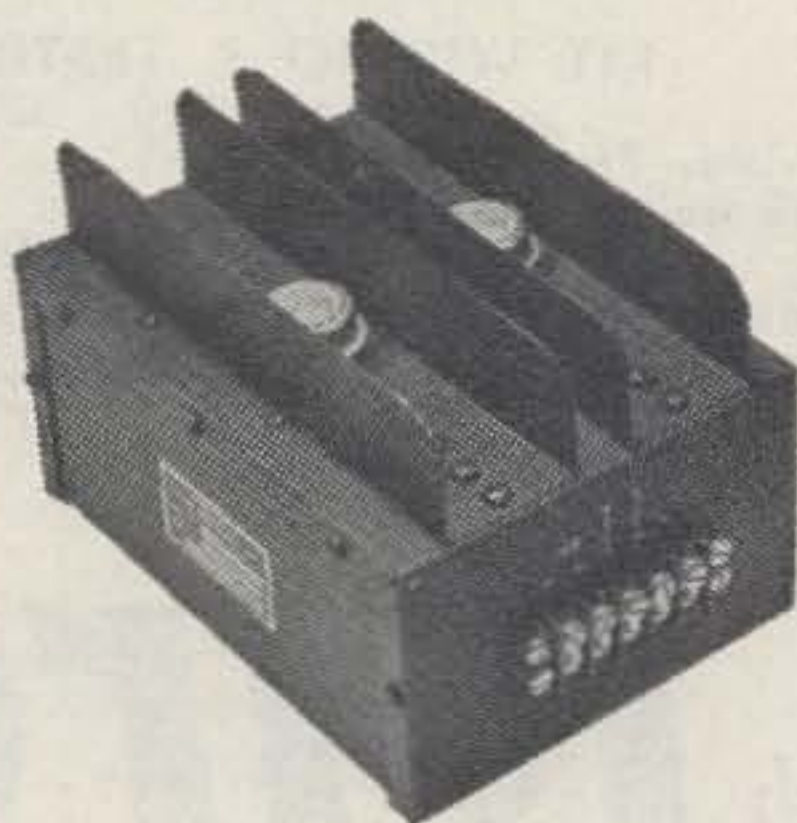

This 12V input dc to dc transistorized converter is conservatively rated for continuous output of 120 watts at 600V or 300V, or any combination of 600 and 300 volt loads totaling 120 watts.

High efficiency, small size, and light weight, plus freedom from maintenance, conserve your battery and increase the enjoyment of mobile operation.



**ELECTRONICS DIVISION
GLOBE INDUSTRIES, INC.**

525 MAIN STREET
BELLEVILLE, NEW JERSEY

Sir: 4
Enclosed is \$9.95. Please send me one of your 3-D maps immediately. U.S.— World—
Name Call
Address
City Zone State
Please include at no charge with this order a one year (new) (renew) subscription to 73 starting with the issue.
(Two years with two maps.)
Send order to: 73 Magazine, 1379 E. 15th St., Brooklyn 30, N. Y.

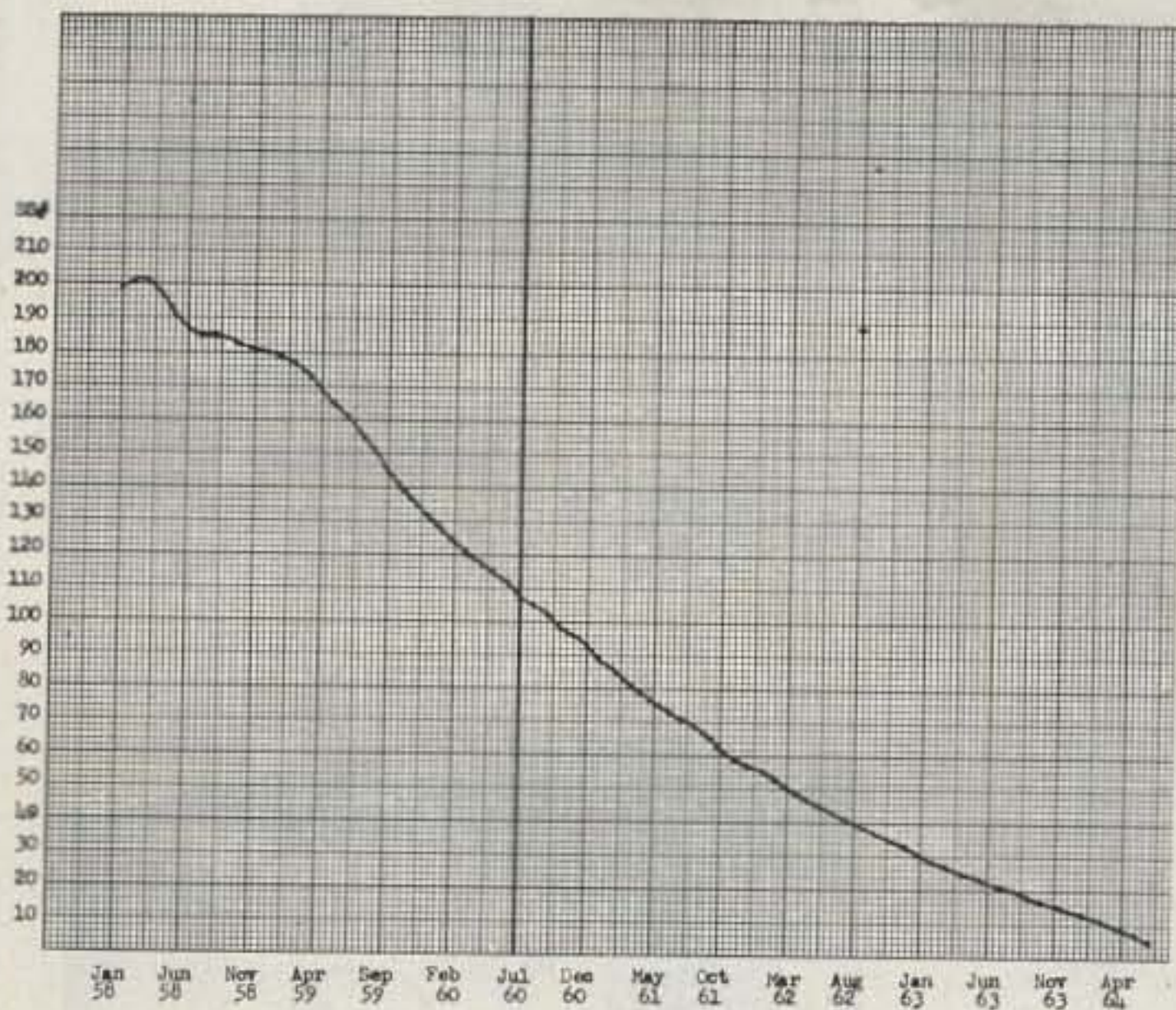

(... Propagation from page 21)

Sunspot Cycle quite well, and also what variations are completely absorbed by the smoothed cycle in Fig. 1. This curve is only four months behind the mean monthly cycle data. The curve in Fig. 4, while still being very rough, is only two months behind the mean monthly cycle of Fig. 1 and from these curves the tendency of the smoothed cycle can be kept up to date.

The time of minimum for the present cycle can not be determined exactly, very far in advance, however, Fig. 5 is my prediction of smoothed numbers for the rest of the cycle which I think will have its minimum around June 1964. A more accurate determination of minimum for a short cycle can be made when the smoothed numbers reach 1/9th of the maximum value (about 22) because minimum tends to come about one year later; also when the 1/11th value is reached (about 18) minimum tends to come 2/3 of a year later.

Part II will cover the variations in MUF, diurnal, seasonal, and with sunspot cycle.

... K2IGY

VHF CONVERTER

Two Meters

or

Six Meters

Model LW-61 \$18.50



FEATURES:

- Comes complete with tubes and crystal
- 0.6-1.6, 7-11 or 14-18 mc output
- Other IF outputs on special order (add \$2)
- Grounded grid RF stage for Low Noise
- Broadband output
- For fixed or mobile use
- Use and BC or communications receiver
- Coax input and output plugs provided
- Requires only 5 ma B and 6 v
- Add 50c for 12 volts
- Not a kit, wired and tested, ready to go

Order Direct:

LW-51 Deluxe kit, less tubes & xtal	\$59.95
LW-51 Deluxe kit, with tubes & any xtal.	74.95
LW-51 Deluxe kit, wired & tested	89.95
Ship weight 7 lbs.: 77c East Coast; \$1.59 Western	
LW-72 AC Power Supply for LW51, wired	49.95
LW-61 VHF Converters	18.50
LW-80 Pre-Amplifiers	12.50

LW ELECTRONIC LABORATORY

ROUTE 2

JACKSON, MICHIGAN

TELETYPEWRITER EQUIPMENT

COLLINS 51J2, 51J3, R-390A/URR Receivers (.50-30.5 MC)
 TELETYPE Printers #14, #15, #19, #20, #26, #28.
 KLEINSCHMIDT Printers #TT-4A, TT-76, TT-98, TT-99
 TT-100, GGC-3.

TELEWRITER Frequency Shift Converter.

For general information & equipment list write:
 Tom W1AFN

ALLTRONICS-HOWARD CO.

Box 19, Boston 1, Mass.

Richmond 2-0048

IN THE . . . WEST - it's WESTERN RADIO

and TELEVISION
 SUPPLY
 CO.



FOR OVER 25 YEARS ONE OF THE WEST'S OLDEST AND LARGEST FIRMS
 DEVOTED EXCLUSIVELY TO AMATEUR AND ELECTRONIC EQUIPMENT.

1331 India St.
 P. O. Box 1728

San Diego 1, Calif.
 BELmont 9-0361

SOLAR SYSTEM VI

RECEIVER

Better than 1/2 microvolt selectivity.
10 kc selectivity (6 db down).
Double conversion for selectivity, image rejection and sensitivity.
Voltage regulated oscillators for stability.
Up to 5 watts audio output for external speaker.
Self contained speaker.
Large 6:1 vernier dial for easy tuning.
Jack for headset output.
Built-in noise limiter.
Spotting switch for zeroing receiver and transmitter.

MECHANICAL

Weight is only 15 pounds . . . you can carry it anywhere easily.
Size is 8"x12" deep to fit under dash or into a suitcase.
One piece double plated chassis for stability and long rust-proof life.
Removes from case easily for servicing.
Carrying handle easily removed for quick mobile installations or used as a mounting bracket.
Steel case with fine crackle finish.
All components are standard and replaceable (no

TRANSMITTER

12 Watts input to a 5763
High efficiency plate and screen modulation for maximum "punch"
Uses popular and inexpensive 8 mc crystals (FT-243 holders)
Provision for VFO operation
Press-to-talk
Metered
Microphone: crystal, ceramic or carbon
50-75 ohm output (will match standard auto receiving whip)

printed circuit boards).
Front panel is recessed and etched so lettering cannot wear off.
Mounting feet are instantly removable.

POWER SUPPLY

Self contained vibrator power supply for 6 vdc, 12 vdc and 110 vac.
Nothing else to buy. The change of power source can be made in seconds.
Separate power cords provided for dc and ac inputs.

SIX METER TRANSCEIVER

for . . .

- Mobile
- Fixed Station
- Emergency
- Aviation

Price **\$189.50**



For information send to . . .

SEG ELECTRONICS

12 HINSDALE STREET
BROOKLYN 7, N. Y.

HAIL, COLUMBIA!

Largest Store-Warehouse in the country

Huge stock of electronic components

ARC-5 Equipment. All in excellent condition.

R-28 Rec 100-156 mc 4 ch.	19.95
T-23 Xmtr 100-156 mc 4 ch.	12.95
R-23 Rec 190-555 kc. Q-5'er	9.95
R-25 Rec 1.5-3 mc.	14.95
R-26 Rec 3-6 mc.	7.95
R-27 Rec 6-9 mc.	7.95
T-18 Xmtr 2.1-3 mc.	4.95
T-19 Xmtr 3-4 mc.	7.95
T-20 Xmtr 4-5.3 mc.	4.95
T-21 Xmtr 5.3-7 mc.	4.95
T-22 Xmtr 7-9 mc.	8.95
MD7 Modulator for all ARC-5..	4.95

Filter Choke: 6 Hy 150 ma, 2500v ins. ew 3x3x3 1/2 in.95
Ten for	7.95
Modulation Transformer, 20W 3x3x3 1/2 in. 6K to 6K CT, new (actually handles 30W of audio!) New, 10 for	7.95

THIS MONTH'S SPECIALS

BC375 100W Xmtr 200-12,500 kc with proper tuning unit. LN	14.95
SCR625 Mine Detector, excellent	19.95
DM35 Dynamotor, 12V in, 625V @ 225 ma out, new	7.95
TCS 12V Dynamotor, 440V @ 200 ma output brand new	4.95
BC669 Xmtr-Rec 1680-4450 kc 75W AM VFO/Xtal, excellent	89.95
Power Supply for BC669 (PE-110) 110VAC, excellent	49.95
Connecting cable for BC669 & PE-110 (CD515)	3.50
BC-620 FM Xmtr-Rcvr 20-28 mc., 5W with 6-12 vdc Pwr Supply. FB for C.B. or Amateur. Like New	18.49
ARR-15 Collins 2-18 mc. Communications Rcvr Exc. Cond.	49.95
APX-6 1215 mc. Xmtr-Rcvr Exc. Cond. Less Tubes	4.95
APT-5 300-1400 mc. 50W Xmtr. FB for 432 or 1215 mc. Exc. Cond.	19.95

TUBES . . . ALL NEW ALL SPECIALS!

4-65A	\$7.50
4-125A	19.95
4X150A	7.95
4CX250B	22.50
4X250B	20.00
4-400A	25.00
4-1000A	65.00
832	2.95
829B/3E29	4.95
Rafts of other tubes	tell us your needs.

SILICON RECTIFIER SPECIALS

500 ma at 500 PIV	\$.95
5A at 50 PIV	1.49
25A at 50 PIV	2.49
35A at 50 PIV	3.49
70A at 100 PIV	5.95
200A at 50 PIV	9.95
1A at 140 PIV Bridge Assembly	2.95
All brand new, manufactured by Audio Division. All Guaranteed.	

- Free Bulletins. Write. Try resisting our irresistible bargains!
- We buy used equipment. TS, GRC, PRC, VRC, etc. Let us hear from you.

COLUMBIA ELECTRONICS

4365 W. Pico Blvd. Los Angeles 19, Calif. • WE 8-3731

Ham Headlines

If ham radio makes the newspapers in your town please send a clipping to Marvin Lipton VE3DQX, 311 Rosemary Road, Toronto 10, Ontario, Canada. Marvin runs the 73 News Service, a monthly publication sent to all editors of club bulletins. He will digest the most important stories that are submitted each month for us to print in 73.

HAMS AID IN TORNADO

(Chicago Sun-Times, Chicago, Ill.) Scores of hams answered a South Side Chicago ham's plea for help after a tornado struck the area. For hours during the night they directed traffic, provided transportation and generally assisted the police department.

AMATEUR SUED FOR LENDING AID

(Chicago Sun-Times, Chicago, Ill.) Maurice R. Franks, Jr., a university student and avid ham operator who played an important role in a recent Chicago tornado found himself subject of a Superior Court Suit. A landlady filed the suit claiming that Franks' transmitter interfered with 100 television sets in her apartment building as he aided in storm communications. She is asking that he be enjoined from operating his station and also requests a permanent injunction.

RADIO OP FAILS TO SAVE WOMAN'S LIFE

(Daily News, Brooklyn, N. Y.) Angel Fernandez, a Brooklyn ham radio operator, made a desperate attempt to save the life of a critically ill woman, Mrs. R. Cocido, in Buenos Aires, Argentina. She was in grave need of a new antibiotic made in U.S. Fernandez received a radio message about the woman's plight and after spending \$160 of his own and arranging for speedy delivery of the medicine via National and Panagra Airlines, he learned that his efforts were in vain. The drug arrived seven hours after Mrs. Cocido died.

AMATEUR OPERATORS STAND-BY

(Cleveland Plain Dealer, Cleveland, Ohio. Submitted by Tom Hill, K8DHX) Twenty five amateur radio operators were at their sets in different parts of the county to provide emergency communications after a severe storm struck Greater Cleveland recently.

ACKNOWLEDGMENTS

We would like to acknowledge two ham stories that appeared in the Syracuse Herald-Journal and Buffalo Evening News, respectively. The former was written by K. W. Thomas, a ham of 18 years standing, who substituted a bit about ham radio for a regular columnist. The latter concerned C.D. operations of a youth, 17 year old Peter Lascell, of Chautauqua County, N. Y.

AF MARS TECHNICAL NET

Sundays 2-4 pm EST 3295-7540-15715 kc

May 7—Telemetry; Modern concepts and applications.

May 14—Semiconductors.

May 21, 28, June 4, 11—Review of basic physics.

ANNOUNCING THE

Shorecrest 2M CONVERTER

SUPER LOW-NOISE—CUSTOM BUILT
USING RCA's NEW NUVIDOR

PAUL A. REVEAL W2ADD BOX 575
Church Street Station, New York 8, N. Y.



CITIZEN BAND CLASS "D" CRYSTALS

All 22 Frequencies in Stock

3rd overtone. .005% tolerance—to meet all FCC requirements. Hermetically sealed HC6/U holders. 1/2" pin spacing—.050 pins. (.093 pins available, add 15¢ per crystal).

\$2.95
EACH

The following Class "D" Citizen Band frequencies in stock (frequencies listed in megacycles): 26.965, 26.975, 26.985, 27.005, 27.015, 27.025, 27.035, 27.055, 27.065, 27.075, 27.085, 27.105, 27.115, 27.125, 27.135, 27.155, 27.165, 27.175, 27.185, 27.205, 27.215, 27.225.

Matched crystal sets for Globe, Gonset, Citi-Fone and Hallcrafters Units . . . \$5.90 per set. Specify equipment make.

RADIO CONTROL CRYSTALS IN HC6/U HOLDERS

Specify frequency, 1/2" pin spacing . . . pin diameter .05 (.093 pin diameter, add 15¢) . . . \$2.95 ea.

FUNDAMENTAL FREQ. SEALED CRYSTALS

in HC6/U holders
From 1400 KC to 4000 KC .005% Tolerance . . . \$4.95 ea.
From 4000 KC to 15,000 KC any frequency
.005% Tolerance . . . \$3.50 ea.

SEALED OVERTONE CRYSTALS

Supplied in metal HC6/U holders
Pin spacing .486, diameter .050
15 to 30 MC .005 Tolerance . . . \$3.85 ea.
30 to 45 MC .005 Tolerance . . . \$4.10 ea.
45 to 60 MC .005 Tolerance . . . \$4.50 ea.



QUARTZ CRYSTALS FOR EVERY SERVICE

All crystals made from Grade "A" imported quartz—ground and etched to exact frequencies. Unconditionally guaranteed! Supplied in:

FT-243 holders Pin spacing 1/2" Pin diameter .093	MC-7 holders Pin spacing 3/4" Pin diameter .125
DC-34 holders Pin spacing 3/4" Pin diameter .156	FT-171 holders Pin spacing 3/4" Banana pins

MADE TO ORDER CRYSTALS • Specify holder wanted
1001 KC to 2600 KC:
.01% tolerance . . . \$2.00 ea.
.005% tolerance . . . \$2.75 ea.
2601 KC to 9000 KC:
.005% tolerance . . . \$2.50 ea.
9001 KC to 11,000 KC
.005% tolerance . . . \$3.00 ea.

Amateur, Novice, Technician Band Crystals

.01% Tolerance . . . \$1.50 ea.—80 meters (3701-3749 KC), 40 meters (7152-7198 KC), 15 meters (7034-7082 KC), 6 meters (8335-8650 KC) within 1 KC
FT-241 Lattice Crystals in all frequencies from 370 KC to 540 KC (all except 455 KC and 500 KC) . . . \$50¢ ea.
Pin spacing 1/2" Pin diameter .093
Matched pairs + 15 cycles \$2.50 per pair
200 KC Crystals, \$2.00 ea.; 455 KC Crystals, \$1.50 ea.; 500 KC Crystals, \$1.50 ea.; 100 KC Frequency Standard Crystals in HC6/U holders \$4.50 ea.; Socket for FT-243 crystal 15¢ ea.; Dual socket for FT-243 crystals, 15¢ ea.; Sockets for MC-7 and FT-171 crystals 25¢ ea.; Ceramic socket for HC6/U crystals 20¢ ea.
Write for new free catalog #860 complete with oscillator circuits

ASK YOUR PARTS DEALER FOR TEXAS CRYSTALS
See big red display . . . if he doesn't stock them, send us his name and order direct from our Florida factory.

NOW! Engineering samples and small quantities for prototypes now made either at Chicago or Ft. Myers Plant. 24 Hour Service!
IN CHICAGO, PHONE GLadstone 3-3555

RUSH YOUR ORDER TO OUR NEW PLANT

Use coupon below for 1st Class shipment.

TEXAS CRYSTALS

Dept. G-51, 1000 CRYSTL DRIVE, FORT MYERS, FLA.
For extra fast service, Phone WE 6-2100

ATTACH THIS COUPON TO YOUR ORDER FOR SHIPMENT VIA 1ST CLASS MAIL AT NO EXTRA COST

TERMS: All items subject to prior sale and change of price without notice. All crystal orders must be accompanied by check, cash or M.O. with PAYMENT IN FULL. No. COD's. Dept. G-51.

KEEP CANDEE HANDEE!

FAMOUS Q 5'ER ! ! !

This is the fantabulous one! 190-550 kc. The receiver you've been looking for at only \$9.95
 BC-454: 3-6 Mc. 7.95
 BC-455: 6-9.1 Mc. 7.95
 MD-7 MODULATOR: Special 3.95

A TRIO OF HEADSET BARGAINS!

HS-23: Hi impedance. Leather covered headband. Brand new. Great buy. Only \$4.95
 HS-33: Low impedance. Leather covered headband. Brand new. A. J. J. Candee Special 5.95
 Hi Fi Headset: 15,000 cycles! Brand new with chamois cushions. It's terrific! Only 8.95
 CD-307A Headset Extension Cord: Brand new. Approximately 5 ft. length. Only49

APN-1 FM TRANSCEIVER

420-460 Mc. Compl. with tubes. Exc. Ea. \$2.95
 Approx. shp. wt. per unit 25 lbs. TWO for 5.00

YOU GOT IT! WE WANT IT! LET'S DEAL?
 We're paying top \$\$\$ for GRC-9; PRC-6, -8, -9, -10; GN-58A; All electronic test equip.

R-4A/ARR-2 RECEIVER

234-258 Mc. 11 tubes. UHF, tunable receiver. See Aug./59 C.Q. Magazine for conversion. Excellent cond. TWO for \$5.00. Each \$2.95

APX-6 TRANSPONDER

A midget warehouse of parts! Blowers, three Veeder-Root counters, I. F. strips, cavity, over 30 tubes, etc. Includes 3E29 tube. Good cond. A STEAL AT ONLY \$9.95

T-67/ARC-3 TRANSMITTER—

100 to 156 MC. Used: \$14.95

R-77/ARC-3 RECEIVER—

100 to 156 MC. Used: \$14.95

ADF AN/ARN-7

Receiver R5/ARN-7 \$29.95
 Loop LP2ILM 7.95
 Inverter MG-149F 9.95
 Control Box C-4/ARN-7 5.00
 Mount FT-213 3.00

SCR-522 TRANSCEIVER

4-channel. Crystal controlled 100-156 Mc. Ideal for 2 meters. Complete with tubes. Excel. \$14.95

APN-4 LORAN EQUIPMENT

Marine or airborne. Long range navigational gear to determine exact position of ship or plane up to 1200 miles from base. Complete with tubes, crystals. Ex. Only \$19.95

ART-13 COLLINS

Transmitter, removed from aircraft, 10-channel auto-tune or manual. 2-18.1 Mc. for Ham Rig with 813 final. Output 60-100 W. CW or modulated. Crystal-calibrated for VFO. Exl. Cond. Only \$33.33

RT91/ARC-2 TRANSCEIVER

Airborne; AM, CW, MCW, Output 40 W. Input 500MW Freq. Range 2000 to 9050 KC in eight channels; Input 26.5 volt DC, excl. cond. ship. wt. 100 lbs., w/control box \$39.95

All items FOB Burbank, Calif., subject to prior sale.
 In Calif. add 4%. Min. order \$3.95.

J. J. CANDEE CO.

Dept. MS

509 No. Victory Blvd., Burbank, Calif.
 Phone: Victoria 9-2411



Information Field Day—A full day of hamming in North Hollywood Park with public displays proving that "Radio ham" is not synonymous with "TVI." Members of San Fernando Valley Radio Club presiding.

Jim Morrisett WA6EXU

TODAY I watched the unusual meeting of hams (cool under the collar) discussing TVI with civilian-televiewers (strangely not about to blow their lids, either). In fact, calm discussion was startlingly prevalent. The only demonstrations were non-people type, peaceful and effective. Potentially irate citizens watched with interest, as side by side, sets with and without TVI functioned in the midst of a howling nest of field day transmitters on all amateur bands.

Public Information Field Day. New name for a new event that pays off in good will.

On a pleasant Sunday afternoon in Southern California, the San Fernando Valley Radio Club held its first annual PIFD. The location, no far mountain top or obscure ham haven, but a grassy park in the middle of North Hollywood. The purpose, besides an excuse for an outing, to promote better understanding between the public and the radio amateur. The FCC is co-operating fully and wishes that clubs all over the country would do the same to help them get TV-grippers out of their hair.

Between 9 and 4 on Sunday, Feb. 26, hundreds of people sauntered in, stood around getting informed, and sauntered out again. When they sauntered out they carried with them a healthier attitude toward amateur radio. A few were keen to know more about this hobby, once they realized one could be a TV-watcher *and* a ham, even simultaneously if you care for that sort of thing.

The PIFD demonstration turned out to be such a good idea it was repeated by request at the Sportsman's Show at the Los Angeles Coliseum March 15-27, where K6BSA operated four transmitters simultaneously, the SFVRC furnishing the same before-and-after TVI and de-TVI display.

Troubled with the neighbors? If they're miffed, invite them to PIFD. . . . WA6EXU

Letters

Dear Wayne,

Here is a rig you will be seeing a lot of before long. This is one of the hottest items I've come across yet. Let's see what you think of it.

The kit of parts sells for \$50, a bargain, cannot be bought across parts counter for this price. The board, a nifty job with all drilling done and brass eyelets inserted at all connection points, \$15. This is the extent of the stuff Denney furnishes, besides instructions.

Other parts needed:

Collins Mechanical Filter (about \$43).

Carrier crystal (or 2 crystals if upper and lower sideband desired), ground to exact frequency to match Collins filter.

Tubes run about \$17.

Outboard VFO operating at output frequency plus 455 kc. The rigs are normally on 40, can be converted without too much trouble for 80 and 20.

External power: 300 v @ 100 ma. Filaments 6 or 12 volts.

External speaker 3-4 ohms.

External rf gain control (dc only on cable), 50K.

Mounts on 7 x 13 x 2 chassis.

2 good watts measured output, enough to drive a kw.

Receiver sensitivity 1 mv. Reports on the receiver section are that it is very hot.

T-R is accomplished by switching of B-plus line. Circuitry is such that no other connections need be switched for transmit-receive. Designed primarily for mobile use where VOX is not desired.

Looks like this will fill a real need. A good, reliable sideband transceiver with which the ham who knows virtually nothing about sideband can make the leap to sideband, with a complete station costing less than a comparable AM rig!

(Continued with pix on page 58)

TAPETONE'S NEW
WTC-432,
3/4 METER,
LOW-NOISE,
CRYSTAL
MIXER
CONVERTER



NEWEST
CONVERTER
ON THE MARKET . . .

This advanced design approach, seldom used by amateurs but widely used in commercial UHF receivers, achieves outstanding performance. It consists of a double-tuned cavity preselector, followed by a crystal mixer and low-noise IF preamplifier.

SPECIFICATIONS:

NOISE FIGURE: 6.0 DB
GAIN: 20 DB
IMAGE REJECTION: GREATER THAN 50 DB
IF REJECTION: GREATER THAN 80 DB
TUBE COMPLIMENT: 1N21E, 6BC4, 6BC4,
12AT7, 6AK5

STANDARD MODELS AVAILABLE:

WTC-432 IF OUTPUT FREQUENCY 50-54 MC.
WTC-432A IF OUTPUT FREQUENCY 51-55 MC.
WTC-432N IF OUTPUT FREQUENCY 30.5-34.5 MC.
WTC-432C IF OUTPUT FREQUENCY 28-32 MC.

PRICE: \$126.56

QST'ers can see Feb. P. 46 for a writeup on this converter

TAPETONE, INC.

10 ARDLOCK PLACE,
WEBSTER, MASS.

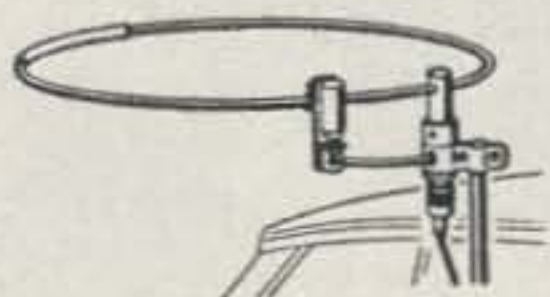

2-METER



6-METER

HALO ANTENNAS

Fixed and Mobile, for both 6 and 2 meters, by the pioneers in horizontal polarization for mobile communications.

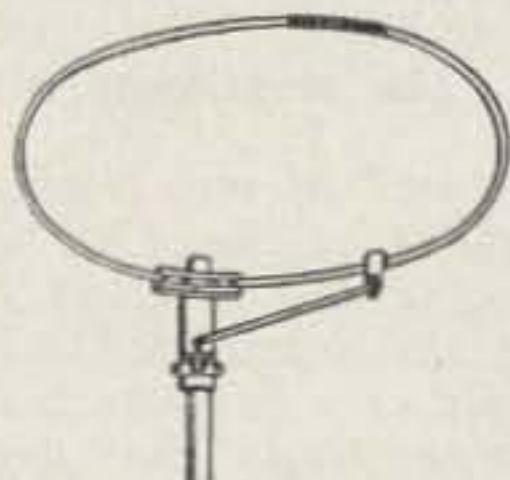

6-METER

Hi-Par also manufactures a quality line of antennas for amateur, TV, FM and commercial services.

AT YOUR
DISTRIBUTORS
OR
WRITE DIRECT

HI-PAR PRODUCTS CO. ♦ FITCHBURG, MASS.

**NEW P & H LA-400-C
LINEAR AMPLIFIER
NOW 800 WATTS PEP
FOR ONLY \$164.95**



PANORAMIC SPECTRUM ANALYSIS
Odd order distortion products (1kc, separation) using popular 100 watt SSB exciter and LA-400C.

	3rd order	5th order
EXCITER ONLY	-37 db.	-47 db.
EXCITER AND LA-400C	-37 to -40 db.	-47 to -50 db.

Certified by ITT FEDERAL LABORATORIES

The 80 thru 10 meter band-switching pi network is designed for 800 watts PEP SSB, 400 watts CW, FM or FSK and 230 watts Linear AM (controlled carrier) or 185 watts (constant carrier) with 50-70 ohm output. Popular 100 watt SSB exciters require no swamping or matching networks to drive the low Z untuned input. Grounded grid circuit uses four 1625's or 837's on customers request. Meter reads RF drive, plate current, RF amps output. New modern compact 9" X 15" X 10½" gray cabinet also contains power supply using 81b's. TVI suppressed, Parasitic Free.

One-Year Warranty on all Parts and Tubes

SEE THE NEW LA-400C AT YOUR DEALERS

LA-400C Kit Complete with tubes\$164.95

LA-400-C Wired and tested\$219.95

P & H ELECTRONICS INC.
424 Columbia Lafayette, Ind.

TUBES WANTED!
ESPECIALLY KLYSTRONS,
MAGNETRONS, MINIATURE,
SUB-MINIATURE AND
OTHER SPECIAL PURPOSE TYPES
HIGHEST PRICES PAID

Order by phone from Mr. Harwit of JSH

Jsh
ELECTRONICS CO.

DEPARTMENT

73

1108 Venice Boulevard
Los Angeles 15, California

Richmond 9-7644

(... Letter from page 57)

The circuitry was first developed in the fabulous Jennings shack by Don Johnson W6AAQ, father and midwife to some of the most fascinating SB rigs to appear on the scene in recent years.

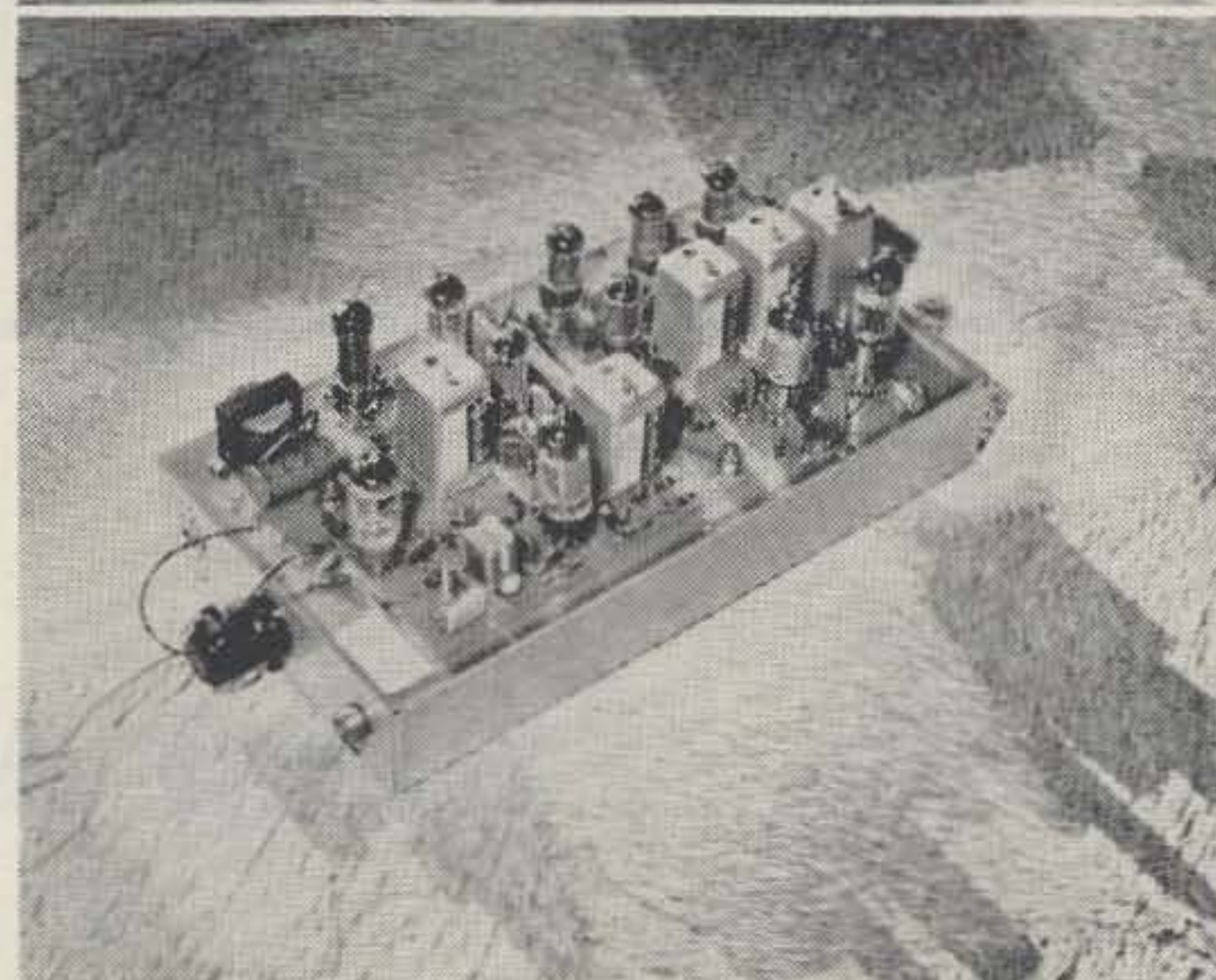

Denney Moore, W6MHP, has taken over production of the printed-circuit boards and furnishing of the kits of parts and instructions. W6MHP plus Mrs. Moore constitute the D. Moore Company, which has earlier put out the Reflect-O-Match, a gem among SWR devices.

Orders are now being filled by D. Moore Company, 1236 Virginia Ave., Redwood City, Calif.

... Jim Morrisett WA6EXU

Well Jim, you're just a bit ahead of me. I got a good look at it in the Jennings exhibit at the IRE show in March and am just as enthusiastic as you about it. Paul Barton, W6JAT went over all the details for me. From what I can see, Mrs. Moore should soon be up to her elbows in printed circuit board drillings. Hope you gave them one of our rate cards bwah! ... Wayne.

Gentlemen:

Would you please announce the Burlington Amateur Radio Club International Field Day Hamfest at Burlington Vermont on June 17-18 ... the largest hamfest north of Swampscott. Registration is \$3 thru W1OJO, Box 684, Burlington, or \$3.50 at the gate, and includes a two hour ferry ride across Lake Champlain.

K1CEG Bert Perry

Other Ham Publications

In lieu of half of the magazine being filled with specialized departments, we recommend that you subscribe to the bulletin of your special interest. You get a lot more news and get it faster this way . . . and you encourage the fellows who are putting out these bulletins.

73 HAM CLUB BULLETIN. Marvin Lipton VE3DQX, 311 Rosemary Road, Toronto 10, Ontario, Canada. Sent free to all editors of ham club bulletins monthly to keep them abreast of what is going on with all the other ham clubs. This is an excellent source of news for putting together your club bulletins. To subscribe to this news bulletin just send a copy of your own club bulletin to Marvin.

SIDEBANDER. Official organ of the Single Sideband Amateur Radio Association, 12 Elm Street, Lynbrook, L. I., N. Y. Subs include membership to SSBARA: \$3 per year. Monthly. Primarily operating news and chit-chat for the SSB DX gang.

THE OLD TIMER'S BULLETIN. Published by Bruce Kelly W2ICE, Main Street, Holcomb, New York, four times a year. \$1 per year. Pictures and discussions of old ham gear, old ham ops and old ham doings.

VHF AMATEUR. Published monthly by Bob Brown K2ZSQ(T), 67 Russell Avenue, Rahway, New Jersey. \$2 per year. Operating news for VHF'ers.

DX-QSL News Letter. Clif Evans, K6BX, Box 385, Bonita, California. Published quarterly. 40¢ each; Annual subscription \$1.25 (four copies) by first class mail (\$1.50 for DX stations). Lists all QSL Bureaus, managers for rare DX stations, etc. Why not send your old Callbook to a DX ham? Write Clif for the name of someone who needs it.

DIRECTORY OF CERTIFICATES AND AWARDS. Clif Evans, K6BX, Box 385, Bonita, Cal. Complete Directory plus one year of revisions (quarterly) \$3.50. Add 75¢ for 1st class mail; \$1.25 for airmail; DX stations 1st class mail add \$1.00. Needless to say, this is the most complete collection of data on the hundreds of certificates and awards available.

FLORIDA RTTY BULLETIN. Fred W. DeMotte W4RWM, P.O. Box 6047, Daytona Beach, Florida. \$3 per year including membership in Florida RTTY Society. Mostly operating news with a bit of technical info now and then. All TT men should be getting this.

SOUTHERN CALIFORNIA RTTY BULLETIN. Merrill L. Swan W6AEE, 372 West Warren Way, Arcadia, California. \$2.75 per year, not including membership in Society. Operating news and some technical articles. This is the oldest TT bulletin going. All TT men should also get this one. Monthly.

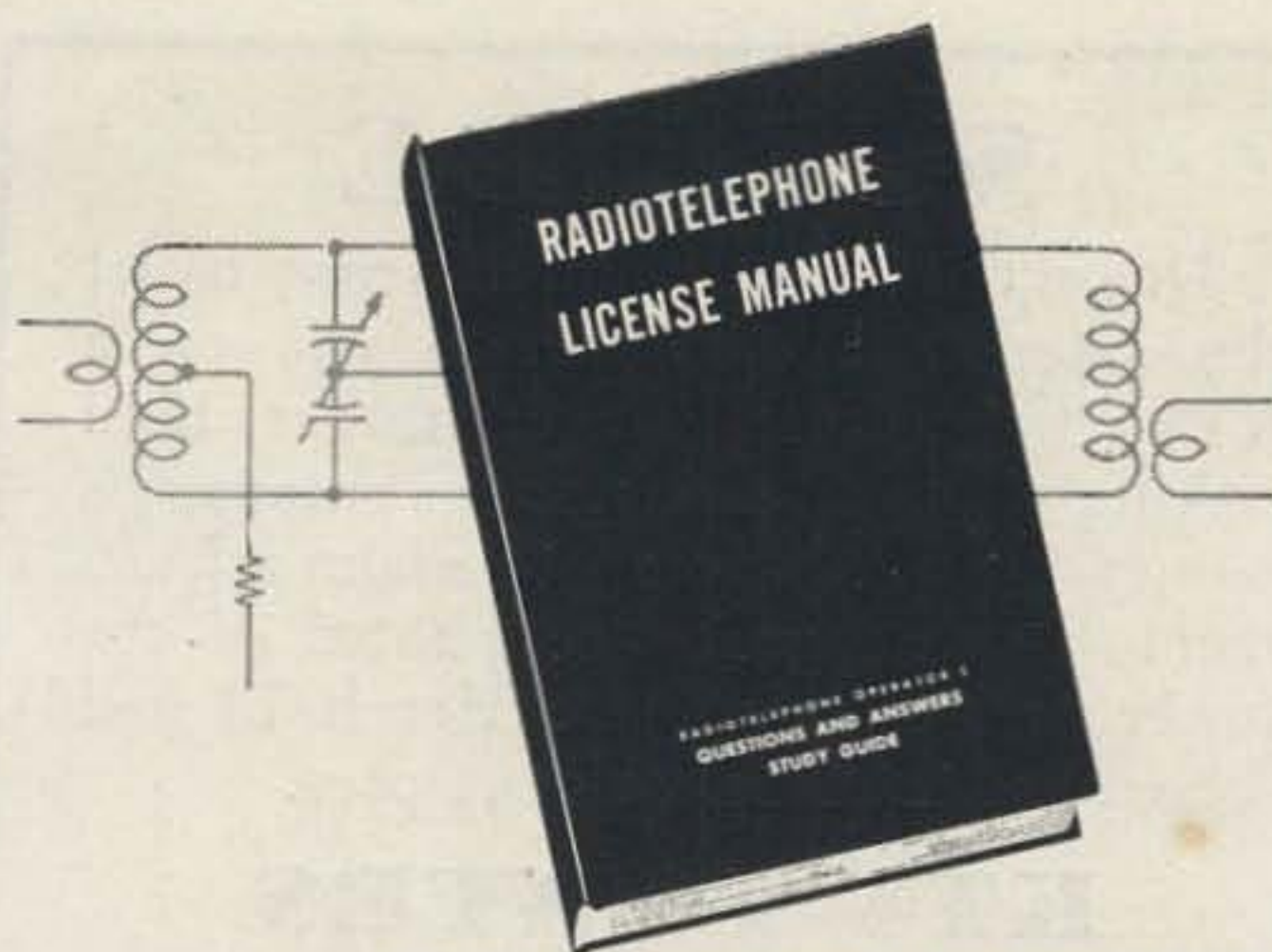

RADIOTELEPHONE LICENSE MANUAL \$5.75

Helps you prepare for all U.S.A. commercial radiotelephone operator's license exams. Gives the basis for a sound understanding of every pertinent subject. Complete study-guide questions and answers in one volume.

RADIO HANDBOOK — largest ever published. The comprehensive reference source on radio. Gives simplified theory . . . latest design data . . . more "How-to-Build" data than any book in field **\$8.50**

WORLD'S RADIO TUBES (Brans' Radio Tubes Vade Mecum). World's most authoritative tube book **\$6.00**

WORLD'S EQUIVALENT TUBES (Brans' Equivalent Tubes Vade Mecum). Over 32,900 comparisons **\$6.00**

SURPLUS RADIO CONVERSION MANUALS
Practical conversions of most popular surplus equipment, in 3 volumes. Send stamped envelope for list of contents **\$3.00 each**

*Order from your favorite electronic parts distributor. If he cannot supply, send us his name and your remittance, and we will supply; foreign, add 10%.

EDITORS and ENGINEERS, Ltd.

Summerland 8 California
Dealers: Electronic distributors, order from us. Bookstores, libraries, newsdealers order from Baker & Taylor, Hillside, N. J. Export (exc. Canada), order from H. J. Snyder Co., 440 Park Ave. So., N.Y. 16.

ALL BAND TRAP ANTENNA!



Reduces interference and noise on all makes short wave receivers. Makes world wide reception stronger. Clearer on all bands!

For ALL Amateur Transmitters. Guaranteed for 500 Watts Power for Pinet or Link Direct Feed. Light, Neat, Weatherproof

Complete as shown total length 102 ft. with 87 ft. of 72 ohm balanced feedline, Hi-impact molded resonant traps. (Wt. 3 oz. 1" x 5" long). You just tune to desired band for beamlike results. Excellent for ALL world-wide short-wave receivers and amateur transmitters. For NOVICE AND ALL CLASS AMATEURS! NO EXTRA TUNERS OR GADGETS NEEDED! Eliminates 5 separate antennas with excellent performance guaranteed. Use as Inverted V for all band power gain. NO HAYWIRE HOUSE APPEARANCE! EASY INSTALLATION!

80-40-20-15-10 meter bands. Complete \$14.95
40-20-15-10 meter bands. 54-ft. ant. (best for w-w swl's) 13.95
20-15-10 meter bands. Dual Trap. 24-ft. antenna 19.95

SEND ONLY \$3.00 (cash, ck., mo) and pay postman balance COD plus postage on arrival or send full price for postpaid delivery.

Available only from:
WESTERN RADIO - Dept. A7-5 - Kearney, Nebraska

SUICIDE

Doesn't it make a lot of sense to let the antenna come down to you on a KTV Twin-Track Tower rather than risking a lot of the insurance company's money by climbing up to make adjustments or changes? See photos of the tower on page 6 of the March 73 and send for literature, prices, specs.

KTV TOWERS

P.O. Box 294

Sullivan, Illinois

INTRODUCTORY OFFER

OUR WORLD FAMOUS

Lektron Exclusive

JUMBO PAK

INCLUDES
500 PIECES

FOR ONLY **\$3.00**
POST PAID

(Worth \$85)

Our Pak Includes: Disc, Tubular, and Ceramic Condensers—plus Precision Resistors—all are

Guaranteed Perfect

LEKTRON

FREE
GIANT
CATALOGS

- Ham Gear
- Tools-Tubes
- Electronics
- Radio - Hi-Fi

244 Everett Ave., Chelsea 50, Mass.

Old Call Books

Few DX operators can afford to buy a Callbook. If you have one that is less than three years old that you would like to send to a DX ham then drop a card to Cliff Evans K6BX and he will send you a letter from a DX ham that would like to have your Callbook. K6BX, Box 385, Bonita, California. We think this is a wonderful service and extend our best regards to Cliff for his work.

MOTOR DRIVEN MATCHING SYSTEMS
BY **Mach**

REMOTE ANTENNA UNITY BEAM MATCHING SWR

6, 10 or 11 METER SINGLE
10, 11, 15 or 20 SINGLE
TRI BAND (WITH CONSOLE)

WRITE FOR BROCHURE —
3526 BLUE RIDGE CUTOFF
Mach ELECTRONICS KANSAS CITY 35, MO.

Radio Bookshop

On the off chance that someone may read this ad who has the bug to read a little on their favorite subject, we've laid in a stock of the following books.

2—ELECTRICAL ENGINEERS' HANDBOOK—Pender-McIlwain. This huge book should keep you busy for months just reading the interesting facts it contains. There is hardly any problem in communication or electronics that you can't find covered here. Excruciatingly thorough. 1618 pages. **\$10.00**

6—VACUUM-TUBE CIRCUITS AND TRANSISTORS—Arguimbau. Designed for both beginners and engineers. Math kept to a minimum. Simple explanations of complex ideas. You'll know a lot more about radio after you read this book. 646 pages. **\$10.25**

8—RADIO-TELEVISION & BASIC ELECTRONICS—Oldfield. Logical presentation and descriptive illustration make this an ideal book for the beginner. Written by self-learning of electronics principles. 342 pages. **\$4.95**

13—REFERENCE DATA FOR RADIO ENGINEERS. Tables, formulas, graphs. You will find this reference book on the desk of almost every electronic engineer in the country. Published by International Telephone and Telegraph. **\$6.00**

20—RTTY HANDBOOK—Kretzman (W2JTP). A-Z of ham Teletype. Very popular book, low supply. **\$3.00**

32—RCA RADIOTRON DESIGNERS HANDBOOK—1500 pages of design notes on every possible type of circuit. Fabulous. Every design engineer needs this one. **\$7.50**

33—WAVE PROPAGATION & ANTENNAS—Welch. Highly recommended by the propagation experts as the best Book on the subject. **\$5.75**

40—RADIO HANDBOOK, 15th EDITION—Orr (W6SAI). This is far and away the best amateur radio handbook ever printed. Over 800 pages. **\$8.50**

52—HOW TO READ SCHEMATIC DIAGRAMS—Marks. Components & diagrams; electrical, electronic, ac, dc, audio, rf, TV. Starts with individual circuits and carries through complete equipments. **\$3.50**

49—ELECTRONIC COMMUNICATION—Shrader. Everything you need to know about electronics, electricity, and radio to pass FCC amateur or commercial license examinations. This text has what you hoped to find in the Amateur Handbook: detailed thorough explanations of every phase of radio and electronics. 937 pages. This is one of the few really complete texts on the subject. **\$13.00**

53—BASIC ELECTRONIC TEST PROCEDURES—Turner. This book covers just about every possible type of electronic test equipment and explains in detail how to use it for every purpose. Testing: audio equipment, receivers, transmitters, transistors, photocells, distortion, tubes, power . . . etc. **\$8.00**

76—MODERN OSCILLOSCOPES & THEIR USES—Ruiter. Second edition. Shows what a 'scope is, what it does and how to use it for radio, TV, transmitters, etc. 346 pages. **\$6.50**

79—TRANSISTOR PROJECTS—Skip the theory and start having fun. Radios: self powered, shirt pocket, regenerative, carrier-power, headphone. Instruments and accessories: sine-square wave generator, preamps for VTVM's, gain checker, shortwave calibrator, phase shifter, substitution box. Plus remote transistor ear, electronic compass, simple oscillator, lamp control, multi-impedance amplifier, electronic counter, portable power supply . . . etc. **\$2.90**

80—SURPLUS RADIO CONVERSION MANUAL VOLUME NO. I (second edition). This book gives circuit diagrams, photos of most equipment, and rather good and complete conversion instructions for the following: BC-221, BC-342, BC-312, BC-348, BC-412, BC-645, BC-946B, SCR-274N 453A series receivers conversion to 10 meter receivers, SCR-274N 457A series transmitters (conversion to VFO), SCR-522 (BC-624 and BC-625 conversion to 2 meters), TBY to 10 and 6 meters, PE-103A, BC-1068A/1161A receiver to 2 meters, Surplus tube index, cross index of A/N tubes vs. commercial types, TV & FM channels. **\$3.00**

81—SURPLUS RADIO CONVERSION MANUAL VOLUME NO. II. Original and conversion circuit diagrams, plus photos of most equipments and full conversion discussion of the following: BC-454/ARC-5 receivers to 10 meters, AN/APS-13 xmtr/rcvr to 420 mc, BC-457/ARC-5 xmtrs to 10 meters, Selenium rectifier power units, ARC-5 power and to include 10 meters, Coil data-simplified VHF, GO-9/TBW, BC-357, TA-12B, AN/ART-13 to ac winding charts, AVT-112A, AM-26/AIC, LM frequency meter, rotators, power chart, ARB diagram. **\$3.00**

82—SURPLUS RADIO CONVERSION MANUAL VOLUME NO. III—Original and conversion diagrams, plus some photo of these: 701A, AN/APN-1, AN/CRC-7, AN/URC-4, CBY-29125, 50083, 50141, 52208, 52232, 52302-09, FT-ARA, BC-442, 453-455, 456-459, BC-696, 950, 1066, 1253, 241A for xtal filter, MBF (COL-43065), MD-7/ARC-5, R-9/APN-4, R23-R-28/ARC-5, RAT, RAV, RM-52 (53), Rt-19/ARC-4, SCR-274N, SCR-522, T-15/ARC-5 to T-23/ARC-5, LM, ART-13, BC-312, 342, 348, 191, 375. Schematics of APT-5, ASB-5, BC-659, 1335A, ARR-2, APA10, APT-2. **\$3.00**

83—THE SURPLUS HANDBOOK, VOLUME I—Receivers and Transmitters. This book consists entirely of circuit diagrams of surplus equipment and photos of the gear. One of the first things you really have to have to even start considering a conversion of surplus equipment is a good circuit diagram. This book has the following: APN-1, APS-13, ARB, ARC-4, ARC-5, ARC-5 VHF, ARN-5, ARR-2, ASB-7, BC-222, -312, -314, -342, -344, -348, -603, -611, -624 (SCR-522), BC-652, -654, -659, -669, -683, -728, -745, -764, -799, -794, BC-923, -1000, -1004, -1066, -1206, -1306, -1335, BC-AR-231, CRC-7, DAK-3, GF-11, Mark II, MN-26, RAK-5, RAL-5, RAX, Super Pro, TBY, TCS, Resistor Code, Capacitor Color Code, JAN/VT tube index. **\$3.00**

R235—RADIO CONTROL FOR MODEL BUILDERS—Winter. One of the best and newest books available on RC. **\$4.25**

R245—HOW TO USE GRID-DIP OSCILLATORS—Turner (K6AI). Construction & uses, an important book. **\$2.50**

Order Form

2 6 8 13 20 32 33 40 52 49 53
76 79 80 81 82 83 R235 R245

Name Call

Address

City State

RADIO BOOKSHOP

1379 East 15th Street, Brooklyn 30, N. Y.
(N.Y.C. add 3% tax)

MONOBAND BEAMS



Full Sized
●
Wide Spaced
●
Light Weight

10 METER—3 Element . . . \$28.50
Model No. A28-3, boom 10' x 1 1/2"
10 METER—4 Element . . . \$42.50
Model No. A28-4, boom 18' x 1 5/8"
15 METER—3 Element . . . \$32.50
Model No. A21-3 boom 12' x 1 5/8"
20 METER—2 Element . . . \$45.00
Model No. A14-3, boom 10' x 1 5/8"
20 METER—3 Element . . . \$62.50
Model No. A14-3, boom 20'6"x1 5/8"

See your distributor or write for
FREE CATALOG

CUSHCRAFT 621 HAYWARD ST.
MANCHESTER N. H.

SAVE TIME AND MONEY

INCREASE VERSATILITY
ELIMINATE OBSOLESCENCE

BUILD YOUR EQUIPMENT
WITH VANGUARD
"PCM's" *

*printed circuit modules.

- Largest selection of circuits.
- Lowest cost.
- Every module is tested, guaranteed and complete with tubes, transistors, and crystals where required.



SPECIAL THIS MONTH
6 METER TRANSMITTER
\$15.99 list
NOW \$7.99

this month only

Specifications: Crystal controlled, 7 watts input to 6CX8 final, 52 ohm link output.

Power requirements: 250 V. DC @ 35 ma., 6.3 V. @ .45 a.
Send stamped self-addressed envelope for complete list of VANGUARD PCM's.

VANGUARD ELECTRONIC LABS

Dept. H-5, 190-48 — 99th Ave., Hollis 23, N. Y.

U.S. #1 ELECTRONICS

a division of AMBER INDUSTRIAL CORP. Dept. A7
1920 E. EDGAR ROAD (Right on Highway U.S. 1)
LINDEN, N. J.—across from ESSO RESEARCH LABS
PE-103 Dm.: w/filter, start. relay, bat. cable
in 6v/12v @ 21a/11a; out 500v @
160ma. 12.50

**TERRIFIC BARGAIN! GO-9 TRANSMITTER,
100 W. 0.3-18 MCS. BRAND NEW \$59.50**

BC-659	FM Rec.-Xmtr. xtal. contr.; 80 ch.; 27-38.9 mcs.	10.95
BC-620	20-27.9 mcs same as BC-659, but no spkr.	10.95
SCR-522	Xmtr AM, 4 ch., xtal contr. 30w, 18 tubes very good	22.50
BC-604	Xmtr. 20-27.9 mcs. 30w, 10-ch. xtal control.new	8.50
BC-684	Same as BC-604, except 27-39.1 mcs.	8.50
DM-35	12v Dynamotor for BC-604 or BC-684	4.95
BC-458	Xmtr 5,3-7 mcs. complete w/tubes & xtal	7.50
BC-1206	Rec. 195-420 kcs w/5 tubes, works on 24-28 vdc	8.95
MP-22	mast base for mobile mountnew	1.95
T-26	mobile chest mikenew	1.00

Our new catalog is now ready. We held up publication in order to get a lot of brand new surplus items in it.

THOUSANDS OF ITEMS—THOUSANDS OF BARGAINS

Write for free listing—25% deposit on C.O.D. orders—Minimum order \$5.00. All prices f.o.b. Linden, N. J. Some quantities limited. Prices Subject to Change Without Notice.

DIRECTIONAL POWER COUPLER

50 TO 500 MCS — 10 TO 1000 WATTS

4 INSTRUMENTS IN ONE



STANDING WAVE RATIO
MODULATION MONITOR
FIELD STRENGTH METER
LINE LOSS

52 ohm model: L52

75 ohm model: L75

BULLETIN E-5275

\$24.50 Each unit individually aligned to insure perfect meter calibration.

NUVISTOR PRE-AMPLIFIER

EXCELLENCE IN PERFORMANCE

MODELS TO COVER:

48-60 MCS— MODEL G-50

140-150 MCS— MODEL G-144

210-240 MCS— MODEL G-220

410-450 MCS MODEL G-432

BULLETIN E-5124



\$19.95 Each unit individually aligned for optimum noise figure.

417-A GROUNDED GRID PRE-AMPLIFIER
\$21.95 LESS TUBE **\$39.90 WITH TUBE**

Eliminate the guesswork from your matching problems.

Quarter wave linear balun transformer.

Any frequency from 50 to 500 mc

Any impedance ratio between 50 and 600 ohms

Write for bulletin E50-600

VHF-UHF ASSOCIATES
P. O. BOX 1068
FAIRFIELD, CONN.

TWO METER OMNIDIRECTIONAL TURNSTILE ANTENNA

\$3.95 P.P. in U.S.A.

• Fixed or Mobile • Can be stacked • Light Weight • Excellent for CD & Nets • Elements, Hub, Hardware, Phasing Section, and Instruction Sheet Included.

MERCURY ENTERPRISES Box 273
Granby, Conn.

BOSTONIANS!

Arise! You're surrounded by Bob Graham W1KTJ. Skeptical? Well, look for yourself. Visit either of the Graham stores and see tremendous quantities of new and reconditioned ham gear at New England's only exclusive ham stores. It's worth the trip.

North of Boston at
505 Main, Reading
Phone: 944-4000

South of Boston at
1105 N. Main, Randolph
Phone: WO 3-5005

50-144 mc

J Beam
Skeleton
Slot

220-440 mc

Now, the "skeleton slot" antenna you have waited for. Available in "73 combinations"—all with constant impedance—broad banding.

Coax or open feed—light weight—rugged—Models from 2 to 64 elements—gains to match—low SWR.

Write now for details . . . available through dealers.

HOUSE OF ANTENNAS

1153 East 82nd St., Chicago 19, Illinois
Telephone SO 8-9282

J BEAM

J BEAM

Advertisers Index

Alden	52
Allied Radio	64
Alltronics-Howard	53
Arrow Electronics, Inc.	7
Barry	50
Candee	56
Central Electronics	8
Clark	51
Clegg	1
Colorado Ham Directory	50
Columbia	54
Cushcraft	61
Editors & Engineers	59
EICO	5
Evans Radio	49
E-Z Way Towers	6
Finney	21
Globe Industries	52
Gonset	Cover II
Graham	62
Heath	13
Hi-Par	57
House of Antennas	62
International Crystal	2, 11
JSH	58
KTV Towers	60
Lafayette Radio	19
Lektron	60
L-W Electronics	53
Mach	60
Maps	52
Mercury	62
Multi-Products	51
National Radio	Cover IV
Neil	49
Petersen	Cover III
P & H	58
Radio Bookshop	60
Reyco	51
Seg Electronics	54
Shorecrest	55
Subscriptions	6
TAB	63
Tapetone	57
Technical Material Corp.	17
Telrex	51
Texas Crystals	55
US #1 Electronics	61
Vanguard Electronic Lab	61
VHF-UHF Associates	62
Western Radio (Nebraska)	59
Western Radio (San Diego)	53

"TAB" FOR THE BEST KITS!

Each "TAB" Kit Contains The Finest Selection!!!!

- Kit 75 Mica Condensers
Kit 8 Crystal Diodes
Kit 200ft Hook Up Wire
4 Rolls, 50ft/ea. Asstd. Color
Kit 100 Ceramic Condensers
Kit 5 FT243 Xtal Holders
Kit 5 Microswitches
Kit 8 Xtal Osc-Blanks
Kit 4 Asstd Rectifiers
Kit 5 UG/Connectors
Kit 100 Self/Tap Screws
Kit 4 Selenium "Suncells"
Kit Adj Wire Stripper & Cut
Kit Hi Gain Xtal Mike
Kit 6 ea Phonoplugs & Jacks
Kit 2 pair SO239 & PL59
Kit 12 Binding Posts Asstd

99¢
Order Ten Kits—We Ship Eleven!!!
ONE EACH ABOVE KIT ONLY.....

Kit 35 Precision Resistors
Kit 10 Switches
Kit 75 Resistors 1/2 & 1/2W
Kit 12 Electrolytic Cond's
Kit 15 Volume Controls
Kit 56 Tube Sockets
Kit 65 Tubular Condensers
Kit 500 Lugs & Eyelets
Kit 10 Bath Tub Oil Cond's
Kit 5 lbs. Surprise Package
Kit 10 Transmit Mica Cond's
Kit Glyptal & Cement
Kit 3 Phone/Patch Xfms
Kit 4 AN/Reflector Lites
Kit 6 Insult Tuning Tools
Kit 4 "Suncells" Asstd.
Kit 5 Sub-Min Tubes
Order Ten Kits—We Ship Eleven!!!

GTD! POWER-DIAMOND-TRANSISTORS
Factory Tested
***MFGD In U.S.A.
Replaces Medium & HiWattage Types
2N155, 2N156, 2N234, 2N256, 2N307, 2N554
GENERAL TO 3GP 80¢ @,20 for \$15
PURPOSE100/\$65
(\$10 or more this item we pay P.P./U.S.A.)

8 TOPHAT SILICON DIODES \$1
EXPERIMENTERS KIT, USE AS
STABISTORS, ZENOR DIODES
METER PROTECTION CLIPPER
& RECTIFIERS! \$10 VALUE.

DIAMOND BASE MICA MTG KIT... \$.30
ROUND BASE MICA MTG KIT... \$.30
DELCO POWER HEAT SINK WITH
FINS 80 SQ"... \$1.25
KIT DIODES COMPUTER.....20¢, 8/\$1
KIT TRNSTR NPN or PNP. 39¢ @, 3 for \$1
IN34A DIODES 23¢ @, 10 for \$2, 100/\$18
(\$10 or more this item we pay P.P./U.S.A.)

GTD! HIPOWER-ROUND-TRANSISTRS
Factory Tested
***MFG In U.S.A.
2N277 or 2N441 @ \$2.25,
2N278 or 2N442 @ \$3.75,
2N173 or 2N443 \$5.00 @ 4/\$16
(\$10 or more this item we pay P.P./U.S.A.)

NEW POWER CONVERTER
12VDC to 500VDC
up to 200MA
100 Watts; Tap at 250VDC
*Type C1250E \$35

TYPE C650E FOR 6VDC INPUT \$35
12VDC to 250VDC up to 150MA
Type C1225E \$30
C625E for 6VDC input \$30

"TAB" TOROID XFMRs for
TRANSISTOR POWER CONVERTERS!
T6-500E/6VDC Inpt. 500VDC & Tap. Max 200Ma \$15. T12-500E/12VDC Inpt. 500VDC
& Tap, Max 200Ma \$15. T6-250E/6VDC
inpt. 250VDC, Max 150Ma \$14. T12-250E/
12VDC Inpt. 250VDC, Max 150Ma \$14.

Leece Neville Charger Systems
"SILTAB" Silicon Rectifier
Replacement
Non-Aging Hermetically Sealed
FOR 6 or 12VDC @ 100A, Type YJ9 \$24

Table with 4 columns: Selenium F.W. Bridge Rectifiers, DC Amp, 18VAC, 36VAC, 72VAC, 130VAC, 14VDC, 28VDC, 54VDC, 100VDC. Rows 1/2, 1, 2, 3, 6, 10, 12, 20, 24.

Write For Rectifier Catalog

Send 25¢ for Catalog

"TAB" THAT'S A BUY

"TAB" Tubes Factory Tested, Inspected, Six Months Guaranteed! No Rejects!

GOVT & MFGRS Surplus! New & Used

Table of tube types and prices: 0A2, 0A3, 0B2, 0C3, 0D3, 0Z4, 1A7, 1B3, 1L4, 1R4, 6BZ7, 6C4, 6C5, 6C6, 6C8, 6CB6, 6CD6, 6CF6, 6CL6, 1.25, .45, .69, 1.08, 1.08, .89, 1.49, .85, 1.40, etc.

We Swap Tubes! What Do/You Have?

Table of tube types and prices: 4PR60A, 4-125A, 4X150G, 4X250B, 4-400A, 4E27A, 250TL, 307A, 316A, VR92, 37.50, 27.50, 15.00, 41.00, 41.75, 39.00, 19.45, 2/\$1, 5/\$1, 5/\$1, etc.

Send 25¢ for Catalog!

Table of tube types and prices: 2C43, 2C51, 2D21, 2E22, 2E24, 2E25, 2E26, 2E30, 2E35, 2K25, 6F7, 6F8, 6H6, 6J4, 6J5, 6J6, 6J7, 6J8, 6K6, 6K7, 388A, 350A, 350B, 371B, 6146, 416B, 450TH, 450TL, 460, 703A, 707B, 715C, 717A, 723AB, 725A, 803, 804, 805, 3/\$1, 2.45, 1.75, .95, 3.90, 16.00, 43.00, 43.00, 11.50, etc.

All Tubes Stocked at Low Prices!

Table of tube types and prices: 2K26, 2K28, 2V3, 2X2, 3A4, 3A5, 3AP1, 3BP1, 3C24, 3D23, 6K8, 6L6, 6SN7, 6T8, 6V6GT, 6X5, 12AT6, 12AT7, 12AU6, 12AU7, 6K8, 6L6, 6SN7, 6T8, 6V6GT, 6X5, 12AT6, 12AT7, 12AU6, 12AU7, etc.

We Buy! We Sell! We Trade!

Table of tube types and prices: 807, 811, 811A, 812, 813, 815, 826, 828, 829B, 832A, 833A, 837, 866A, 954, 955, 957, 958A, 1.10, 3.45, 4.41, 3.30, 9.95, 1.75, .99, 9.00, 8.00, 6.00, 36.00, 2/\$2, 2.45, 10/\$1, 3/\$1, 3/\$1, 2/\$1, etc.

Wanted Test Sets and Equipment

Table of tube types and prices: 5BP1, 5BP4, 5CP1, 5CP7, 5R4, 5T4, 5U4, 5V4, 5Y3, 5Z3, 12BZ7, 12H6, 12J5, 12J7, 12J8, 12K8, 12SA7, 12SC7, 12SF5, 12SG7, 12SH7, 12SJ7, 12SK7, 12SL7, 12SN7, 12SQ7, 12SR7, 15E, 15R, FGI7, 7.95, 7.95, 4.99, 9.00, 1.00, .90, .99, .89, .60, .89, 89.00, 1.00, .99, .59, .72, .65, .75, .69, .59, .66, 19T8, 24G, 25A6, 25A7, 25C5, 25L6, 25T, 25Z5, 25Z6, 26A7, 1.95, 3.49, 2/\$1, .79, 1.35, .59, .59, 1.49, .79, .72, .99, 8.28, 19.39, .89, 15.00, 3.49, .69, .59, 4.49, 1.25, 2.99, etc.

Send 25¢ for Catalog!

Table of tube types and prices: 15GP22, 6A7, 6A8, 6AB4, 6AC7, 6AG5, 6AG7, 6AK5, 6AL5, 6AQ5, 991, 1614, 1619, 1620, 1625, 1626, 1629, 2050, 5517, 5608, 5618, 5651, 5654, 5656, 5663, 5670, 5686, 5687, 5691, 5725, 5732, 5736, 5749, 5750, 5751, 5814, 5814, 5814, 5894, 5/\$1, 2.75, 5/\$1, 2.00, 3/\$1, 5/\$1, 4/\$1, 1.25, 1.25, 3.95, 3.25, 1.35, 1.20, 4.25, 1.15, .90, 1.75, 1.15, 4.70, 1.95, 2.00, 85.00, 1.95, 2.75, 1.25, 1.20, 1.20, 1.20, \$12.00, etc.

Top \$\$\$ Paid for 304TL, 813, 811A, 812A Tubes

Table of tube types and prices: 6AR6, 6AS7, 6AT6, 6AU6, 6B8, 6BA6, 6BE6, 6BG6, 6BH6, 6BJ6, 6BK7, 6BL7, 6BN4, 6BN6, 6BN7, 6BQ6, 6BQ7, 6BX7, 6BY5, 6BZ6, FG27, HV27, 28D7, FG33, EL34, 35A5, 35L6, 35T, 35Z5, RK39, 5732, 5736, 5749, 5750, 5751, 5814, 5814, 5894, 5732, 5736, 5749, 5750, 5751, 5814, 5814, 5894, 2.00, 85.00, 1.95, 2.75, 1.25, 1.20, 1.20, 1.20, \$12.00, etc.

Top \$\$\$ Paid for XMTIR Tubes!

Table of tube types and prices: 6BK7, 6BL7, 6BN4, 6BN6, 6BN7, 6BQ6, 6BQ7, 6BX7, 6BY5, 6BZ6, FG27, HV27, 28D7, FG33, EL34, 35A5, 35L6, 35T, 35Z5, RK39, 5732, 5736, 5749, 5750, 5751, 5814, 5814, 5894, 5732, 5736, 5749, 5750, 5751, 5814, 5814, 5894, 2.00, 85.00, 1.95, 2.75, 1.25, 1.20, 1.20, 1.20, \$12.00, etc.

"TAB" TERMS: Min Order \$3-25¢ with order F.O.B. New York. Ten day guarantee, price of mdse. only. Our 17th year. Prices shown are subject to change.

111FJ Liberty St., N. Y. 6, N. Y. RE 2-6245

NEW "VACDAC" SILICON TUBE REPLACEMENTS WITH BUILT IN RF SURGE & SERIES BALANCING PROTECTION



Table of tube types and prices: TYPE VRMS/PIV AMPS PRICE, ST866, ST816, ST5R4, ST5U4, 5000/10400, 5000/7000, 1900/2800, 1120/1600, 0.3, 0.3, 0.5, 0.6, \$20.00, \$16.00, \$15.00, \$ 8.00

SILICON DIODES 750MA* TOP HATS General Purpose 400 PIV at 300 MA Special 2 for \$1 20 for \$7

Table of tube types and prices: rms/piv 17/25, rms/piv 35/50, rms/piv 70/100, rms/piv 140/200, 14¢, 19¢, 29¢, 34¢, rms/piv 210/300, rms/piv 280/400, rms/piv 350/500, rms/piv 420/600, 43¢, 55¢, 70¢, \$1.00, rms/piv 490/700, rms/piv 560/800, rms/piv 630/900, rms/piv 700/1000, \$1.25, \$1.50, \$1.70, \$2.00

Low Priced * T200 SILICON DIODES rated 380piv/266rms @ 200Ma @ 100°C 36¢ each; 10 for \$3.25; 100 for \$27;

*CAPACITOR INPUT DERATE 20%: (\$5 or more this item we pay P.P./U.S.A.) SPECIAL! TRANSISTORS & DIODES!!! Factory Tested & Guaranteed!

Table of tube types and prices: FULL LENGTH LEADS, 2N123 PNP 45¢, 12 for \$5, 100/\$37, 2N292 NPN 45¢, 12 for \$5, 100/\$37, 2N293 NPN 45¢, 12 for \$5, 100/\$37, 2N223 PNP 80¢, 100/\$65, 2N597 PNP \$1.90, 6/\$10, 2N598 PNP \$1.90, 6/\$10, 2N599 PNP \$3.50, 3/\$10

"SUNTAB" SELENIUM PHOTOCCELL 2BP 75µa 3/4x3/8" c40@, 11 for \$4 5AP 1" Dia., 5BP/Sq & Rect 220µa, c55 15AP 750µa, 1 3/4" Dia. \$1.45@, 4 for \$5 10BP 350µa, 1-11/16" Rect. c75@, 10 for \$7 10CP 750µa, 1 7/8x1 1/2" c1.45@, 4 for \$5

GENERAL PURPOSE-PNP-COMPUTER GRADE! Use as Amplifier-Oscillator-HIFI Logic-Servoamp-Power Supply Pulse Amplifier or High Current Switch Veb. Vcc. Veb Approx 40V GP3C rated 300 Milliwatts 65¢, @ 10 for \$5, 100 for \$39 GP10C Rated 1 watt 90¢, 6 \$5, 100 \$63

2N155 \$1.39, 2N176 \$1.80, 2N177 \$1, 2N178 \$1.75, 2N247 \$1.50, 2N255 \$1.20, 2N270 \$.95, 2N274 \$1.25, 2N408 \$.80, 2N544 \$1.20, 2N578 \$1.80, 2N579 \$2.20, 2N581 \$1.25, 2N582 \$2.10, 2N174 \$8.50, 2N443 \$.650, 2N670 \$1.60, 2N671 \$2.

NEW BATTERY CHARGER BC6-12V FOR 6V OR 12 VOLT BATTERIES, TRICKLE & FULL CHARGE up to 4 AMP

Charges 6 & 12 volt batteries Built BC6-12VB...\$10.00 BC6-12VK preassembled Kit 7.50 Same except rated 2.5A BC612AB 8.00 BC6-12AK Preassembled Kit 6.00

!!! TUBE SPECIAL !!! 4X150D-Removed from Govt. equipment. Tested. \$3 ea., 2 for \$5. Filament Xfmr. \$2. First come, first served.

"TAB"-THAT'S A BUY. BARGAINS

New Variacs/or equiv 0-135V/7.5A. \$15.30 New Variacs/or equiv 0-135V/3 Amp \$10.65 New Variacs/or equiv 0-132V/1.25A. \$7.25 RF-MTG GE/475 Ma & 5 Amp \$4@, 2/\$7 DC-METER Dejur 800 Ma/2 1/2" \$3@, 2/\$5 DC MTR 100Ma/2 1/2" \$3@, 2/\$5 RF-HTR Weston 750Ma/TC.....\$4@, 2/\$6 DC-METER One Ma/4" Rd. \$5@, 2/\$8 TRS PWR DIODES* up to 3amp. .4 for \$1 TRS PWR DIODES* up to 5amp. .4 for \$1 *Heat sink mounted. SNOOPERSCOPE TUBE 2"...\$5@, 2/\$9 MINI-FAN 6 or 12VAC/60 Cys \$2@, 3/\$5 NEW PRINT CKT-PANEL, 11x12x.062" @ IN34A 45¢@.15/\$5; IN35\$1; IN38 70¢@; XTAL OVEN-115V&Thermostat....\$2 Blower 24VDC/100CFM.....\$3.98 Xmitting Mica's .006 @ 2500V, 5 for \$1.00 4-1000A Air Socket, less chimney.....\$9.95 829B Socket 85¢, 183 Socket.....\$1 4x150 Ceramic/LOKTAL.....2 for \$1.00

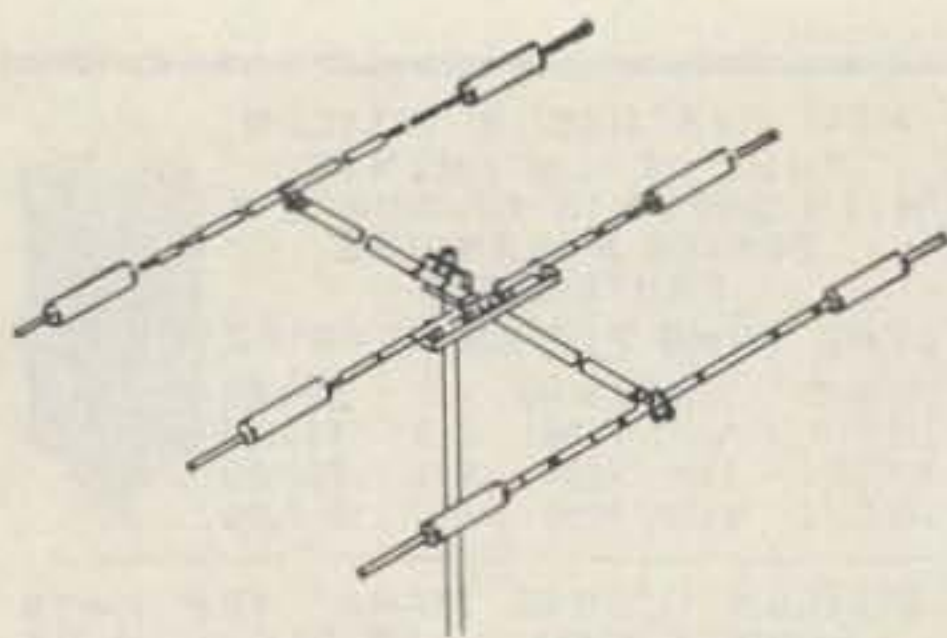

**Mosley Model TA-33
"Trap-Master" Antenna**
Stock No. 92 CZ 360.....\$97.75

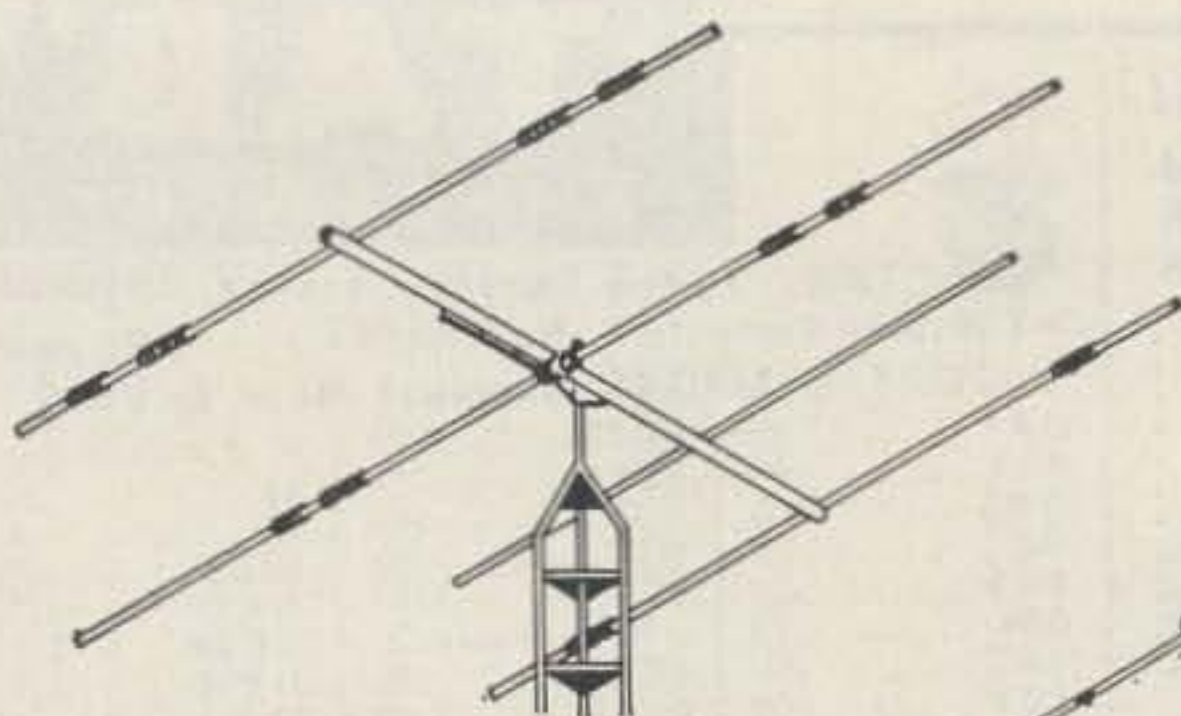

**Hy-Gain TH-4 4-Element
Thunderbird "Tribander"**
Stock No. 77 CZ 361.....\$117.50

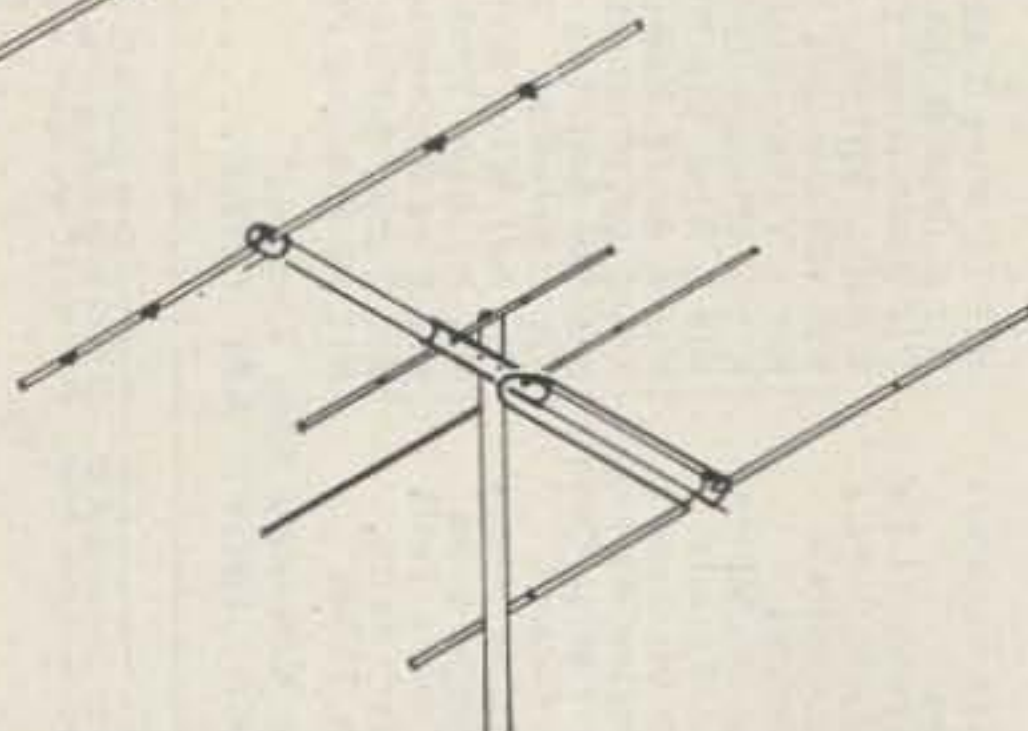

**Telrex TC-99 Challenger
"Tri-Band" Antenna**
Stock No. 99 CZ 964.....\$159.50

ALLIED has that
new antenna system
you need!

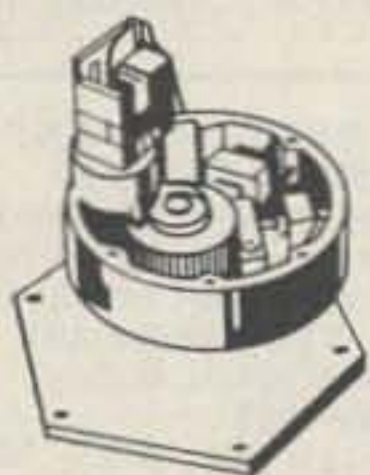

**Hy-Gain Rotator
Indicator System**

RBX-1 "Roto-Brake" (twin-motor unit). Stock No. 83 SU 691..\$129.95



CONTROL SYSTEM—world map indicator and control box.

83 SU 692. Central U.S.A.
83 SU 693. Far East Coast.
83 SU 694. Far West Coast. } Each \$70

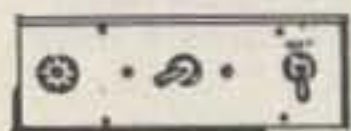

CDR Ham-M Rotator
Complete, heavy-duty system.
Stock No. 92 SX 357....\$117.11



E-Z Way Towers

The top-quality crank-up, tilt-over un-guyed tower. All models in stock at ALLIED, from \$90.00 up.

IN STOCK FOR IMMEDIATE DELIVERY!
All Mosley, Hy-Gain and Telrex antennas. Whatever your antenna needs, you'll save time and money by sending your order to ALLIED.

YOU GET MORE AT ALLIED

- Get our famous "King-Size" trades—they're highest!
- Only \$2 down on orders up to \$50—only \$5 up to \$200!
- Enjoy every buying advantage—top service and real "ham-to-ham" help!

FREE!
Send for our big Summer Sale Book today!



order from

ALLIED RADIO

ALLIED RADIO, Dept. 150-E1
100 N. Western Ave., Chicago 80, Ill.

Immediate Delivery

Ship me the following:

- | | |
|--|--|
| <input type="checkbox"/> 92 CZ 360 Mosley | <input type="checkbox"/> 83 SU 691 RBX-1 |
| <input type="checkbox"/> 77 CZ 361 Hy-Gain | <input type="checkbox"/> 83 SU 692 |
| <input type="checkbox"/> 99 CZ 964 Telrex | <input type="checkbox"/> 83 SU 693 |
| <input type="checkbox"/> 92 SX 357 CDR | <input type="checkbox"/> 83 SU 694 |

\$.....enclosed

Send Free Summer Sale Book No. 205

Name _____ Call _____

PLEASE PRINT

Address _____

City _____ Zone _____ State _____

It pays to insist on

PR crystals

STANDARD OF EXCELLENCE SINCE 1934

AMATEUR TYPES

40 and 80 Meters, PR Type Z-2

Rugged. Low drift, fundamental oscillators. High activity and power output. Stands up under maximum crystal currents. Stable, long-lasting; ± 500 cycles.....**\$2.95 Net**

Third Overtone, PR Type Z-9A

Hermetically sealed; calibrated 24,000 to 24,666 and 25,000 to 27,000 Kc., ± 3 Kc.; .050" pins.....**\$4.95 Net**

6 Meters, PR Type Z-9A

Fifth overtone; for operating directly in 6-meter band; hermetically sealed; calibrated 50 to 54 Mc., ± 15 Kc.; .050" pins.
\$6.95 Net

CITIZENS BAND CLASS "D" Type Z-9R, Transmitter

FCC assigned frequencies in megacycles: 26.965, 26.975, 26.985, 27.005, 27.015, 27.025, 27.035, 27.055, 27.065, 27.075, 27.085, 27.105, 27.115, 27.125, 27.135, 27.155, 27.165, 27.175, 27.185, 27.205, 27.215, 27.225; calibrated to .005%. (Be sure to specify manufacturer of equipment).....**\$2.95 Net**

CITIZENS BAND CLASS "D" Type Z-9R, Receiver

Specify I.F. frequency, also whether receiver oscillator is above or below transmitter frequency. Calibrated to .005%. (Be sure to specify manufacturer of equipment.)
\$2.95 Net

Type Z-9R, Radio Control

FCC assigned frequencies in megacycles: 26.995, 27.045, 27.095, 27.145, 27.195, 27.255; calibrated to .005%. (Be sure to specify manufacturer of equipment).....**\$2.95 Net**

COMMERCIAL TYPES

Commercial Crystals available from 100 Kc. to 70 Mc. Prices on request.

Type Z-1, MARS and CAP

Official assigned frequencies in the range. Calibrated to .005%. 1600 to 10000 Kc.....**\$3.45 Net**

Type Z 1, TV Marker

Channels 2 thru 13....**\$6.45 Net**

4.5 Mc. Inter-carrier,

.01% **\$2.95 Net**

5.0 Mc. Signal Generator,

.01% **\$2.95 Net**

10.7 Mc. FM, IF,

.01% **\$2.95 Net**

Type Z-6A, Frequency Standard

To determine band edge. To keep the VFO and receiver properly calibrated.

100 Kc. .. **\$6.95 Net**



Z-6A



Z-2



Z-9A
Z-9R



Z-1



2XP

Type 2XP

Suitable for converters, experimental, etc. Same holder dimensions as Type Z-2.

1600 to 12000 Kc., (Fund.) ± 5 Kc.....**\$3.45 Net**

12001 to 25000 Kc. (3rd Overtone) ± 10 Kc.....**\$4.45 Net**

ALL PR CRYSTALS ARE UNCONDITIONALLY GUARANTEED.
ORDER FROM YOUR JOBBER.

PETERSEN RADIO CO., Inc. 2800 W. Broadway
COUNCIL BLUFFS, IOWA

EXPORT SALES: Royal National Corporation, 250 W. 57th Street, New York 19, N. Y., U. S. A.

with built-in PRODUCT DETECTOR

NC 270



THE "COSMIC BLUE" NATIONAL'S NEW HAMBAND RECEIVER

This newest and finest precision double conversion amateur receiver with 6 meter coverage, brings you an ease of sideband tuning previously available only in the most expensive equipment. The NC-270 features an exclusive "Ferrite Filter" for instant upper-lower SSB selection and a degree of selectivity to conquer even the toughest AM and CW signal conditions. The solid $\frac{1}{8}$ " steel panel, ceramic coil forms, double-spaced tuning gang, and full ventilation cabinet combine to give mechanical and thermal stability that will surprise even the most critical operator. Even the color of the NC-270 is outstandingly different, National's new duo-tone "Cosmic Blue." Write for detailed specifications.

Only \$24.99 down*

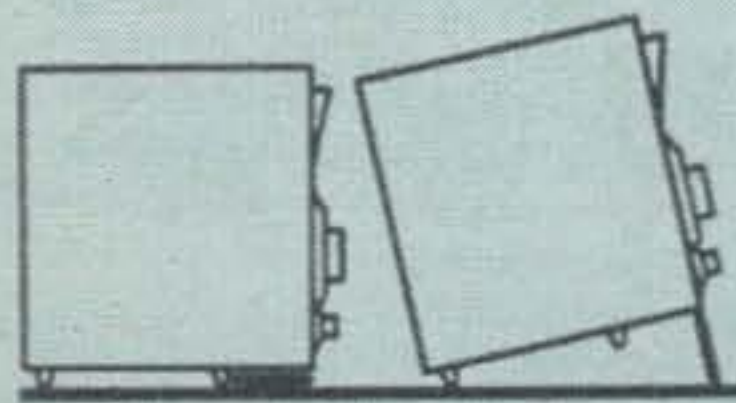

And National Radio's patented "Flip Foot" makes operating the NC-270 so easy.

Suggested cash price: \$249.95. NTS-3 Matching Speaker. \$19.95 (slightly higher west of the Rockies and outside the U.S.A.). *Most National distributors offer budget terms and trade-in allowances.

NATIONAL RADIO COMPANY, INC.



A WHOLLY OWNED SUBSIDIARY OF NATIONAL CO., INC.

MELROSE 76, MASS.

Export: AD AURIEMA, INC., 85 Broad St., New York, N. Y.

Canada: CANADIAN MARCONI CO., 830 Bayview Ave., Toronto 17, Ont.

SPECIFICATIONS SUBJECT TO CHANGE WITHOUT NOTICE